



РУКОВОДСТВО ПО ЭКСПЛУАТАЦИИ

OPERATING MANUAL
BEDIENUNGSANLEITUNG
MODE D'EMPLOI
MANUAL DE FUNCIONAMIENTO
MANUALE DI ISTRUZIONI
ΕΓΧΕΙΡΙΔΙΟ ΛΕΙΤΟΥΡΓΙΑΣ
MANUAL DE INSTRUÇÕES

ROOM AIR CONDITIONER
CEILING WALL TYPE
HEAT & COOL MODEL
(REVERSE CYCLE)

English

Deutsch

Français

Español

Italiano

Ελληνικά

Português

Русский

KEEP THIS OPERATION MANUAL
FOR FUTURE REFERENCE

P/N9314961014-02

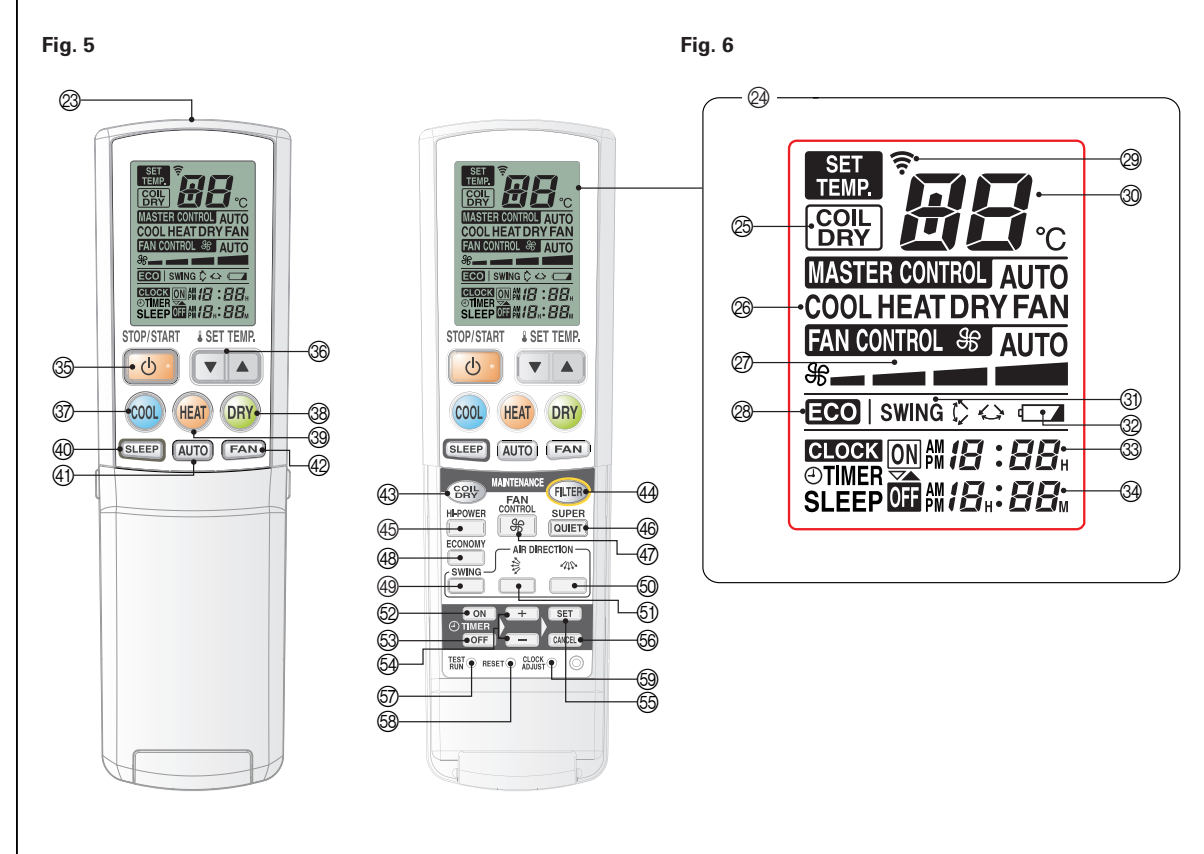
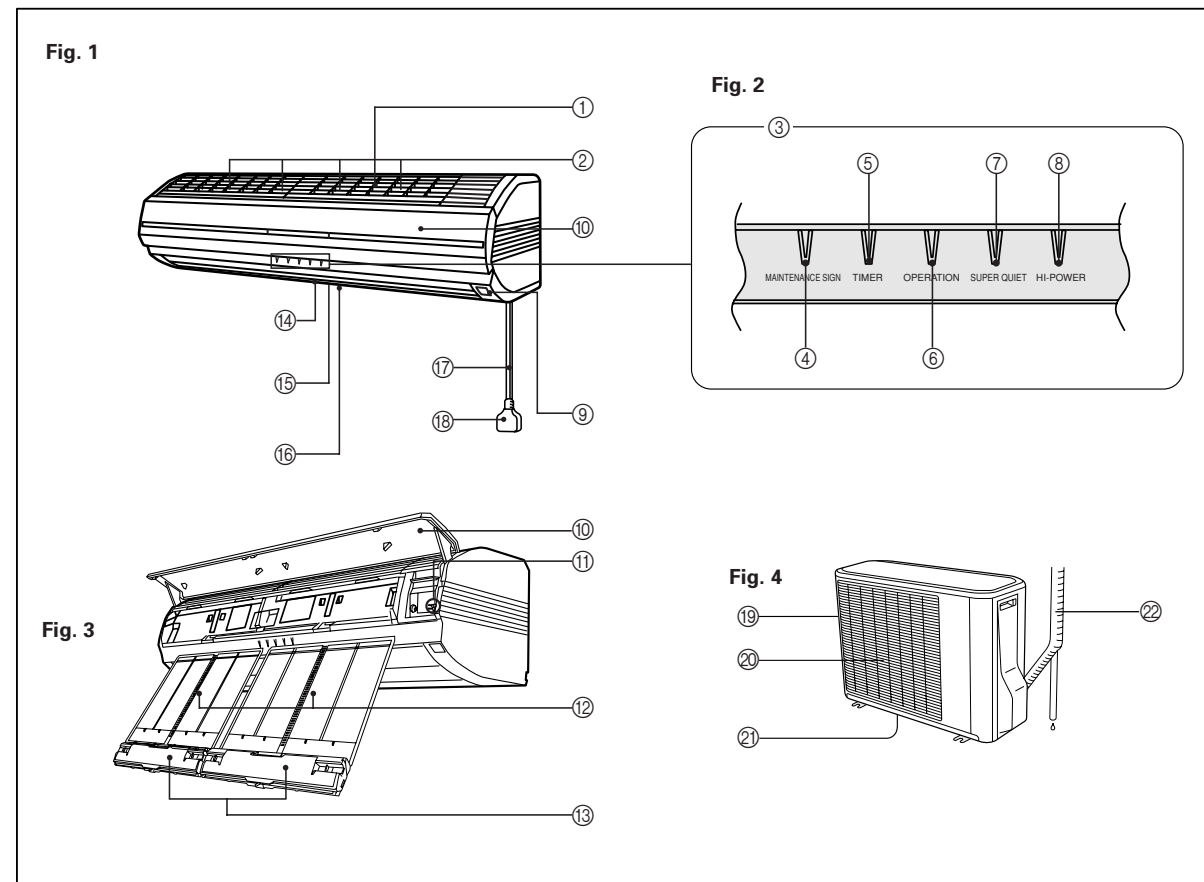

This figure shows the control display when all indicator lamps are on. It may differ from the actual display.

CONTENTS

SAFETY PRECAUTIONS	En-1	HI-POWER OPERATION	En-12
FEATURES AND FUNCTIONS	En-2	COIL DRY OPERATION	En-13
NAME OF PARTS	En-3	AUTOMATIC FILTER CLEANING	
PREPARATION	En-4	FUNCTION	En-14
OPERATION	En-6	PERFORMING MAINTENANCE	En-16
ADJUSTING THE DIRECTION OF		PERFORMING MAINTENANCE	
AIR CIRCULATION	En-8	(CONTINUED)	En-19
SWING OPERATION	En-9	MANUAL AUTO OPERATION	En-21
TIMER OPERATION	En-10	TROUBLESHOOTING	En-22
SLEEP TIMER OPERATION	En-11	OPERATING TIPS	En-23
ECONOMY OPERATION	En-12		

SAFETY PRECAUTIONS



DANGER!

- Do not attempt to install this air conditioner by yourself.
- This unit contains no user-serviceable parts. Always consult authorized service personnel for repairs.
- When moving, consult authorized service personnel for disconnection and installation of the unit.
- Do not become excessively chilled by staying for lengthy periods in the direct cooling airflow.
- Do not insert fingers or objects into the outlet port or intake grilles.
- Do not start and stop air conditioner operation by disconnecting the power supply cord and so on.
- Take care not to damage the power supply cord.
- In the event of a malfunction (burning smell, etc.), immediately stop operation, disconnect the power supply plug, and consult authorized service personnel.
- If the power supply cord of this appliance is damaged, it should only be replaced by the authorized service personal, since special purpose tools and specified cord are required.



CAUTION!

- Provide occasional ventilation during use.
- Do not direct air flow at fireplaces or heating apparatus.
- Do not climb on, or place objects on, the air conditioner.
- Do not hang objects from the indoor unit.
- Do not set flower vases or water containers on top of air conditioners.
- Do not expose the air conditioner directly to water.
- Do not operate the air conditioner with wet hands.
- Do not pull power supply cord.
- Turn off power source when not using the unit for extended periods.
- Check the condition of the installation stand for damage.
- Do not place animals or plants in the direct path of the air flow.
- Do not drink the water drained from the air conditioner.
- Do not use in applications involving the storage of foods, plants or animals, precision equipment, or art works.
- Connection valves become hot during Heating; handle with care.
- Do not apply any heavy pressure to radiator fins.
- Operate only with air filters installed.
- Do not block or cover the intake grille and outlet port.
- Ensure that any electronic equipment is at least one metre away from either the indoor or outdoor units.
- Avoid installing the air conditioner near a fireplace or other heating apparatus.
- When installing the indoor and outdoor unit, take precautions to prevent access to infants.
- Do not use inflammable gases near the air conditioner.

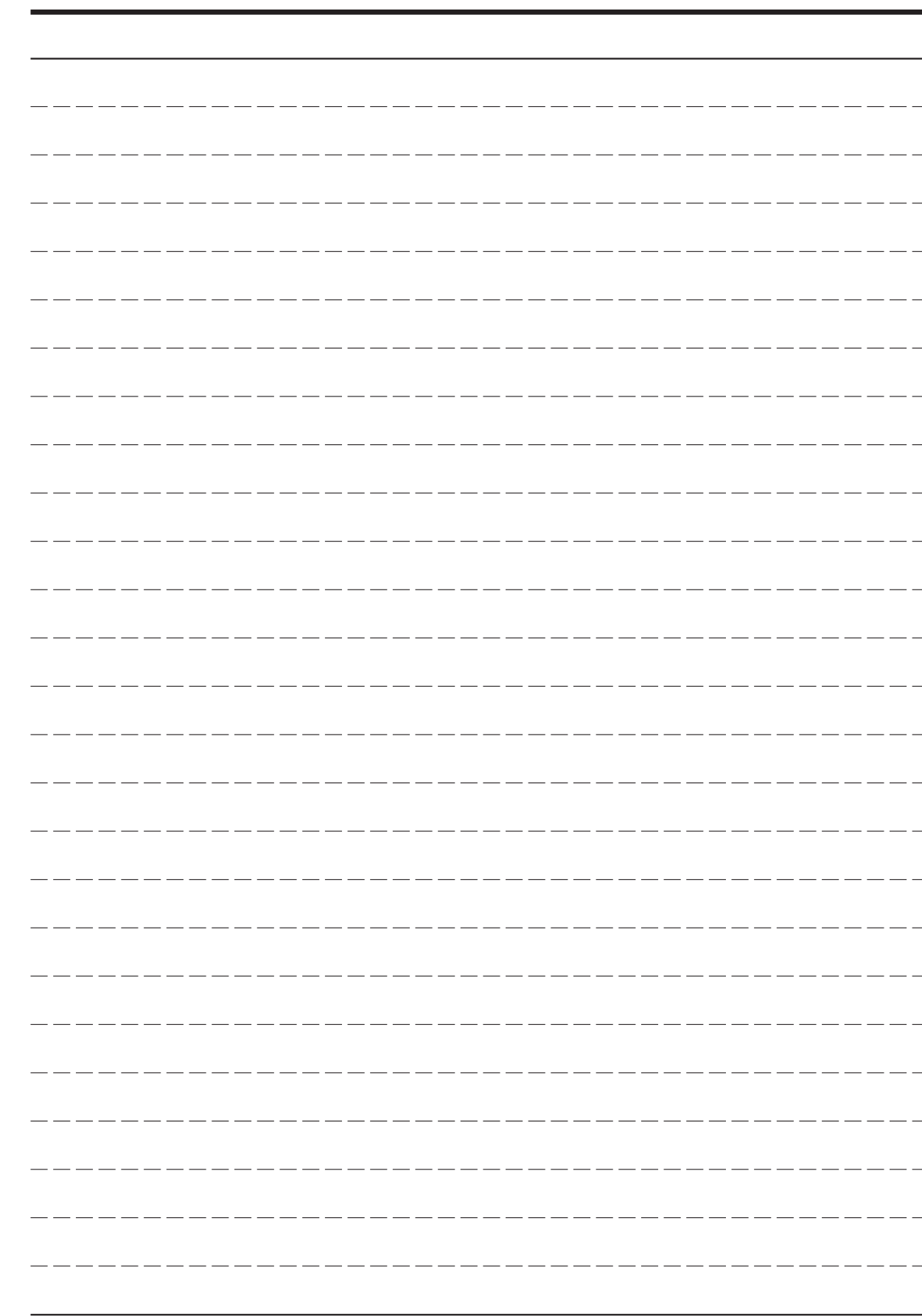

FEATURES AND FUNCTIONS

INVERTER

At the start of operation, a large power is used to bring the room quickly to the desired temperature. Afterwards, the unit automatically switches to a low power setting for economic and comfortable operation.

COIL DRY OPERATION

The Indoor unit can be dried by pressing the COIL DRY button on the Remote Control Unit so as to avoid going moldy and restrain the breed of bacterium.

AUTO CHANGEOVER

The operation mode (cooling, dry, heating) is switched automatically to maintain the set temperature, and the temperature is kept constant at all times.

WIRELESS REMOTE CONTROL UNIT

The Wireless Remote Control Unit allows convenient control of air conditioner operation.

HORIZONTAL AIRFLOW: COOLING/ DOWNWARD AIRFLOW: HEATING

For cooling, use horizontal airflow so the cool air does not blow directly on the occupants in the room. For heating, use downward airflow to send powerful, warm air to the floor and create a comfortable environment.

SWING OPERATION

The airflow-direction louvers move (swing) automatically. In addition, up, down, left, and right airflow directions can be selected using the Remote Control Unit.

MILDEW-RESISTANT FILTER

The AIR FILTER has been treated to resist mildew growth, thus allowing cleaner use and easier care.

SUPER QUIET OPERATION

When the SUPER QUIET button is pressed, the unit begins SUPER QUIET Operation; the indoor unit's airflow is reduced to produce quieter operation.

AUTO FILTER MAINTENANCE FUNCTION

The filter is automatically cleaned after a set amount of time of air conditioner operation.

INTERNAL UV CLEANING

Growth of mold and various germs inside the indoor unit is suppressed with UV (ultraviolet rays).

NAME OF PARTS

Fig. 1 Indoor Unit

- ① Intake Grilles
- ② UV Lamp (4 position)
- ③ Indicator (Fig. 2)
- ④ MAINTENANCE SIGN Indicator Lamp (red)
- ⑤ TIMER Indicator Lamp (green)
- ⑥ OPERATION Indicator Lamp (red)
- ⑦ SUPER QUIET Indicator Lamp (green)
- ⑧ HI-POWER Indicator Lamp (orange)
- ⑨ Remote Control Signal Receiver
- ⑩ Open Panel (Fig.3)
- ⑪ MAINTENANCE/MANUAL AUTO button
 - When kept on pressing the MANUAL AUTO button for more than 10 seconds, the forced cooling operation will start.
 - The forced cooling operation is used at the time of installation. Only for authorized service personnel's use.
 - When the forced cooling operation starts by any chance, press the START/STOP button to stop the operation.
- ⑫ Air Filter
- ⑬ Dust Box
- ⑭ Air Flow Direction Louver
- ⑮ Right-Left Louver (behind Air Flow Direction Louver)
- ⑯ Power Diffuser
- ⑰ Power Supply Cord
- ⑱ Power Supply Plug

Fig. 4 Outdoor Unit

- ⑲ Intake Port
- ⑳ Outlet Port
- ㉑ Pipe Unit
- ㉒ Drain Port (bottom)

Fig. 5 Remote Control Unit

- ㉓ Signal Transmitter
- ㉔ Remote Control Unit Display (Fig. 6)
- ㉕ COIL DRY Display
- ㉖ Operating Mode Display
- ㉗ FAN CONTROL Display
- ㉘ ECONOMY Operation
- ㉙ Transmit Indicator
- ㉚ Temperature Display
- ㉛ SWING Display
- ㉜ Battery Indicator Display
- ㉝ ON TIMER Display
- ㉞ OFF TIMER Display
- ㉟ START/STOP button
- ㊱ SET TEMP. button (▲/▼)
- ㊲ COOL button
- ㊳ DRY button
- ㊴ HEAT button
- ㊵ SLEEP button
- ㊶ AUTO button
- ㊷ FAN button
- ㊸ COIL DRY button
- ㊹ FILTER button
- ㊺ HI-POWER button
- ㊻ SUPER QUIET button
- ㊼ FAN CONTROL button
- ㊽ ECONOMY button
- ㊾ SWING button
- ㊿ AIR DIRECTION (Left-Right) button
- ① AIR DIRECTION (Up-Down) button
- ② ON TIMER button
- ③ OFF TIMER button
- ④ SET TIME buttons (+ / -)
- ⑤ SET (TIMER) button
- ⑥ CANCEL (TIMER) button
- ⑦ TEST RUN button
- ⑧ RESET button
- ⑨ CLOCK ADJUST button

- Refer to the folded out page on the cover.

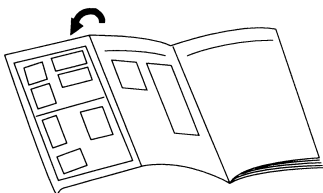

PREPARATION

How to open and close the remote control's cover.

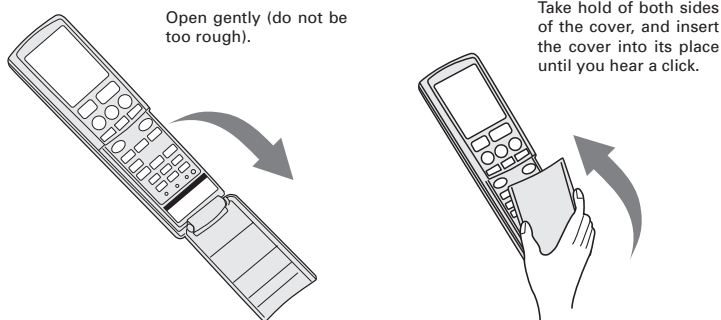

Prompts to change remote control's batteries

- Remote control periodically starts and stops.
Battery Indicator Display (Fig.6 ㉔) shown during operations.
 - At start-up: blinks 5 times
 - At shut-down: remains lit for about 10 minutes.If the Battery Indicator Display is shown, please change your batteries as soon as possible, even if your remote control is still usable.

About the TEST RUN button

- This button is used when installing the air conditioner and should not be used under normal conditions, as it will cause the air conditioner's thermostat function to operate incorrectly.
- If this button is pressed during normal operation, the unit will switch to the test operation mode and the OPERATION Indicator Lamp (red) (Fig.2 ㉑) and TIMER Indicator Lamp (green) (Fig.2 ㉓) on the Indoor Unit will flash simultaneously.
- To stop the test operation mode, press the START/STOP button (Fig.5 ㉕) to stop the air conditioner.

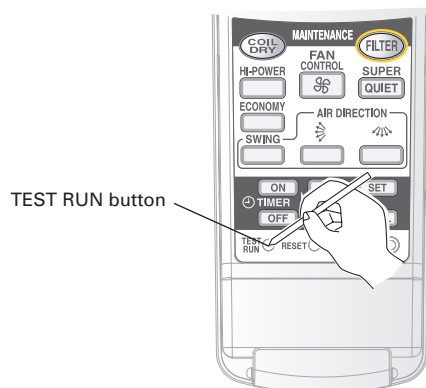

About the Compulsory Cooling Mode

- If the TEST RUN button (Fig.5 ㉗) is pressed during the cooling mode, the unit will change to the compulsory cooling mode and the room will be cooled regardless of the thermostat setting.
- Use the compulsory cooling mode to collect refrigerant in the outdoor unit before moving the air conditioner. (Do not use this button under normal conditions.)



Turn on the Power

Connect the Power Supply Plug (Fig. 1 18) to an electrical outlet; in the case of a direct line connection, turn on the circuit breaker.

Load Batteries (LR03 × 2)

1 Press and slide the battery compartment lid on the reverse side to open it.

Slide in the direction of the arrow while pressing the mark.

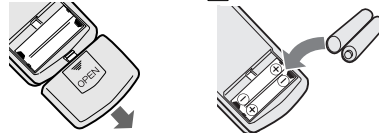

2 Insert batteries.

Be sure to align the battery polarities (+/-) correctly.

3 Close the battery compartment lid.

4 About the RESET (Fig.5 58) button

- If the remote control is unable to function normally after the batteries are changed, please press the RESET button (Fig.5 58).
- Press the RESET button (Fig.5 59) using a ball-point pen or other such items with a relatively sharp tip.

RESET button

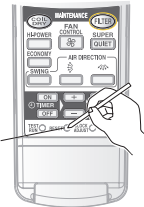

CAUTION!

- Take care to prevent infants from accidentally swallowing batteries.
- When not using the Remote Control Unit for an extended period, remove the batteries to avoid possible leakage and damage to the unit.
- If leaking battery fluid comes in contact with your skin, eyes, or mouth, immediately wash with copious amounts of water, and consult your physician.
- Dead batteries should be removed quickly and disposed of properly, either by placing in a public battery collection receptacle, or by returning to appropriate authority.
- Do not attempt to recharge dry batteries.
- Please always press the RESET button after changing batteries to avoid the possibility of functional errors.

Never mix new and used batteries, or batteries of different types. Batteries should last about one year under normal use.

In any of the following situations, please change your batteries.

- The Battery Indicator Display is shown
- No data transmission possible unless close to Indoor Unit
- The Remote Control Unit is unable to work properly

Set the Current Time

1 Press the CLOCK ADJUST button (Fig. 5 59)

Use the tip of a ball-point pen or other small object to press the button.

2 Use the / SET TIME buttons (Fig. 5 54) to adjust the clock to the current time.

button: Press to advance the time.

button: Press to reverse the time.

(Each time the buttons are pressed, the time will be advanced/reversed in one-minute steps. hold the buttons depressed to change the time quickly in ten-minute steps.)

3 Press the SET button (Fig. 5 55).

This completes the time setting and starts the clock.

To Use the Remote Control Unit

- The Remote Control Unit must be pointed at signal receiver (Fig. 1 9) to operate correctly.
- Operating Range: About 7 meters.
- When a signal is properly received by the air conditioner, a beeping sound will be heard.
- If no beep is heard, press the Remote Control Unit button again.

Remote Control Unit Holder

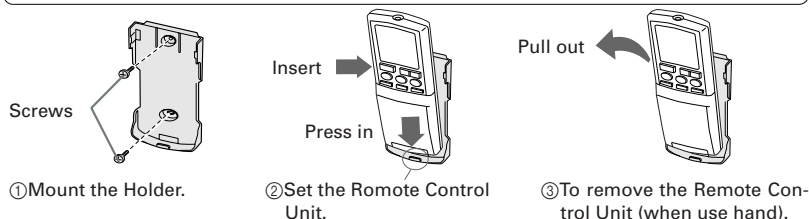

En-5

OPERATION

To Select Mode Operation

Press the necessary Operation button.

- Cooling Operation: Press the COOL button (Fig.5 37)
- Heating Operation: Press the HEAT button (Fig.5 38)
- Dry Operation : Press the DRY button (Fig.5 39)
- Auto Operation : Press the AUTO button (Fig.5 41)
- Fan Operation : Press the FAN button (Fig.5 42)

The Indoor Unit's OPERATION Indicator Lamp (red) (Fig.2 6) will light.
The Air conditioner will start operating.

Pressing the unit's START/ STOP button (Fig.5 35) will run the unit in its most recently-used mode.

To Set the Thermostat

Press the SET TEMP. button (Fig. 5 36).

- ▲ : Press to raise the thermostat setting.
- ▼ : Press to lower the thermostat setting.

●Thermostat setting range:

Cooling/Dry	18-30 °C
Heating	16-30 °C
AUTO	18-30 °C

The thermostat can not be used to set room temperature during the FAN Mode (the temperature will not appear on the Remote Control Unit's Display).

To Set the Fan Speed

Press the FAN CONTROL button (Fig. 5 47).

Each time the button is pressed, the fan speed changes in the following order:

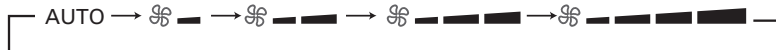

About three seconds later, the entire display will reappear.

When set to AUTO:

- Cooling** : As the room temperature approaches that of the thermostat setting, the fan speed becomes slower.
- Heating** : Fan operates so as to optimally circulate warmed air.
However, the fan will operate at very low speed when the temperature of the air issued from the indoor unit is low.
- Fan** : The fan operates at the low speed.

Super Quiet Operation:

Press the SUPER QUIET button(Fig.5 46).

The Indoor Unit's SUPER QUIET Indicator Lamp (green) (Fig.2 7) will light. (No display on the Remote Control Unit)
SUPER QUIET operation begins.

The Indoor Unit's airflow will be reduced for quieter operation.

- In SUPER QUIET mode, any of the changes listed below will switch SUPER QUIET Operations off.
 - Changing the Fan Speed.
 - Switching to HI-POWER Operation.
- When the Air Conditioner's operations are stopped, SUPER QUIET Operation is cancelled. When the unit is started again, it will run at the Fan Speed displayed on the Remote Control Unit's FAN CONTROL Display.
- During SUPER QUIET Operation, Heating and Cooling and Dry performance will be reduced somewhat.



Example: When set to COOL

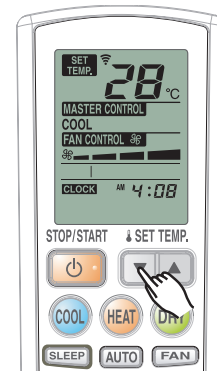

Example: When set to 28°C

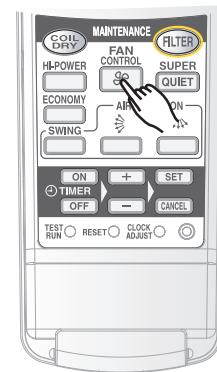



To Stop Operation

Press the **START/STOP** button (Fig.5 ㉓).

The OPERATION Indicator Lamp (red) (Fig. 2 ㉔) will go out.

About AUTO CHANGEOVER Operation

AUTO: ● When AUTO CHANGEOVER operation first selected, the fan will operate at very low speed for about one minute, during which time the unit detects the room conditions and selects the proper operating mode.

If the difference between thermostat setting and actual room temperature is more than +2 °C → Cooling or dry operation

If the difference between thermostat setting and actual room temperature is within ±2 °C → Monitor operation

If the difference between thermostat setting and actual room temperature is more than -2 °C → Heating operation

- When the air conditioner has adjusted your room's temperature to near the thermostat setting, it will begin monitor operation. In the monitor operation mode, the fan will operate at low speed. If the room temperature subsequently changes, the air conditioner will once again select the appropriate operation (Heating, Cooling) to adjust the temperature to the value set in the thermostat.
(The monitor operation range is ±2 °C relative to the thermostat setting.)
- If the mode automatically selected by the unit is not what you wish, select one of the mode operation (HEAT, COOL, DRY, FAN).

About Mode Operation

Heating: ● Use to warm your room.

- When Heating mode is selected, the air conditioner will operate at very low fan speed for about 3 to 5 minutes, after which it will switch to the selected fan setting. This period of time is provided to allow the indoor unit to warm up before begin full operation.
- When the room temperature is very low, frost may form on the outside unit, and its performance may be reduced. In order to remove such frost, the unit will automatically enter the defrost cycle from time to time. During Automatic Defrosting operation, the OPERATION Indicator Lamp (red) will flash, and the heat operation will be interrupted.

Cooling: ● Use to cool your room.

Dry: ● Use for gently cooling while dehumidifying your room.

- You cannot heat the room during Dry mode.
- During Dry mode, the unit will operate at low speed; in order to adjust room humidity, the Indoor Unit's fan may stop from time to time. Also, the fan may operate at very low speed when adjusting room humidity.

Fan: ● Use to circulate the air throughout your room.

During Heating mode:

Set the thermostat to a temperature setting that is higher than the current room temperature. The Heating mode will not operate if the thermostat is set lower than the actual room temperature.

During Cooling/Dry mode:

Set the thermostat to a temperature setting that is lower than the current room temperature. The Cooling and Dry modes will not operate if the thermostat is set higher than the actual room temperature (in Cooling mode, the fan alone will operate).

During Fan mode:

You can not use the unit to heat and cool your room.

ADJUSTING THE DIRECTION OF AIR CIRCULATION

- Adjust the up, down, left, and right air directions with the AIR DIRECTION buttons on the Remote Control Unit.
- Use the AIR DIRECTION buttons after the Indoor Unit has started operating and the airflow-direction louvers have stopped moving.

Vertical Air Direction Adjustment

Open the lid on the Remote Control Unit.

Press the AIR DIRECTION (Up-Down) button. (Fig. 5 ⑤)

- When the AIR DIRECTION (Up-Down) button (Fig.5 ⑤) is pushed, the airflow direction changes within the range to the following.
- You can select the desired airflow direction.

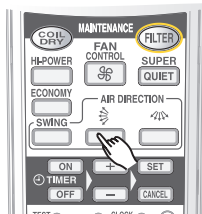
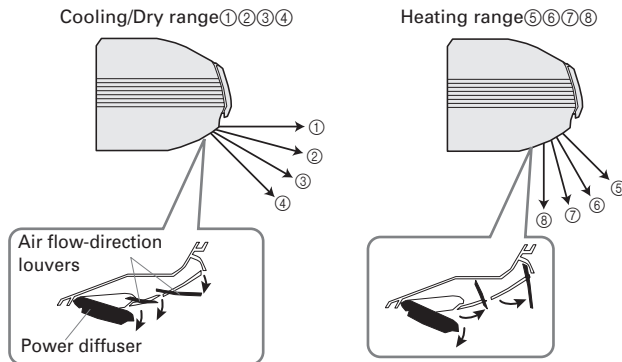

- * The up/down airflow-direction louvers move in the direction of the arrow from the closed position.
- In order to maximize the heating and cooling performance, use the ranges above.

Fan range ①②③④⑤⑥⑦⑧

* The Remote Control Unit display does not change.

⚠ DANGER!

- Never place fingers or foreign objects inside the outlet ports, since the internal fan operates at high speed and could cause personal injury.

About airflow direction adjustments

- When the unit is turned on or the operation mode is changed, the position of the airflow-direction louvers is automatically set as listed below to match the operation mode (heating, cooling, etc.) selected.
Cooling/Dry/Fan: ① horizontal airflow
Heating: ⑦ downward airflow
- During HI-POWER operation (see page 12), the up/down airflow direction is set automatically to optimize the heating and cooling performance.
- When the AIR DIRECTION buttons on the Remote Control Unit are pressed, it may take a short time for the up/down airflow-direction louvers or the left/right airflow-direction louvers to reach the desired position. During that time, the airflow direction cannot be adjusted even if the AIR DIRECTION buttons are repeatedly pressed.
- During the monitor period in the auto mode (see page 7), horizontal airflow direction is set and cannot be adjusted.
- If the AIR DIRECTION (Up-Down) button is pressed during the up/down swing operation (see page 11), the up/down swing operation will stop. In addition, if the AIR DIRECTION (Left-Right) button is pressed during the left/right swing operation, the left/right swing operation will stop.

Right-Left Adjustment

Open the lid on the Remote Control Unit.

Push the AIR DIRECTION (Left-Right) button (Fig.5 ⑥).

- When the AIR DIRECTION (Left-Right) button (Fig.5 ⑥) is pushed, the airflow direction will change in the following order.

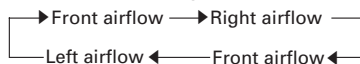

- You can select the desired airflow direction.
- The Indoor Unit is set for front airflow when the unit is turned on.

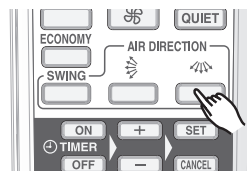

* The Remote Control Unit display does not change.



SWING OPERATION

Begin air conditioner operation before performing this procedure.

To select SWING Operation

Open the Remote Control Unit lid to perform swing operation settings.

Press the SWING button (Fig. 5 ④).

The SWING Display (Fig. 6 ③) will light.

Each time the SWING button is pressed, the swing operation will change in the following order.

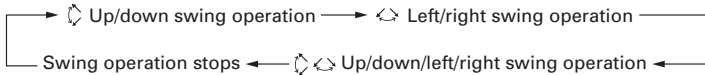

To stop SWING Operation

Press the SWING button (Fig.5 ④) and select STOP.

Airflow direction will return to the setting before swing was begun.

About Swing Operation

- **Up/down swing:** Swing operation begins using the following range according to the current airflow direction.
 - Airflow direction is 1-4 (for cooling, dry).
With the upper airflow-direction louver in the horizontal position, the lower airflow-direction louver moves (swings) to direct airflow to a wide area.
 - Airflow direction is 5-8 (for heating).
With the airflow-direction louvers set for downward or straight down airflow, airflow is directed mainly at the floor.
- **Left/right swing:** The airflow-direction louvers move (swing) in the left/right airflow direction.
- **Up/down/left/right swing:** The airflow-direction louvers move (swing) in both the up/down and left/right airflow directions.
- The SWING operation may stop temporarily when the air conditioner's fan is not operating, or when operating at very low speeds.
- If the AIR DIRECTION (Up-Down) button is pressed during the up/down swing operation, the up/down swing operation will stop and if the AIR DIRECTION (Left-Right) button is pressed during the left/right swing operation, the left/right swing operation will stop.

TIMER OPERATION

Before using the timer function, be sure that the Remote Control Unit is set to the correct current time (See page 5).

To Use the OFF TIMER or ON TIMER

Open the Remote Control Unit lid to perform the timer function settings.

- 1 Press the desired Operation button or START/STOP button (Fig. 5 ㉓).**
(if the unit is already operating, proceed to step 2).
The Indoor Unit's OPERATION Indicator Lamp (red) (Fig. 2 ㉖) will light.

- 2 Select the desired timer operation time, and then press the OFF TIMER button (Fig. 5 ㉔) or the ON TIMER button (Fig. 5 ㉕).**

The OFF or ON timer indicator flashes.

- 3 Use the SET TIME buttons (Fig. 5 ㉖) to adjust the desired OFF time or ON time.**

+ Button: Press to advance the time. The time advances in 5-minute increments.

- Button: Press to reverse the time. The time goes backward in 5-minute increments.

- 4 Point the Remote Control Unit towards the Indoor Unit and press the SET button (Fig. 5 ㉗).**

The OFF or ON timer Indicator stops flashing.

The TIMER Indicator Lamp (green) (Fig. 2 ㉙) on the Indoor Unit will light.
If the ON TIMER function is selected, the air conditioner operation stops.

To Use the Program timer

- 1 Press the START/STOP button (Fig. 5 ㉓)**
(if the unit is already operating, proceed to step 2).
The Indoor Unit's OPERATION Indicator Lamp (red) (Fig. 2 ㉖) will light.

- 2 Set the desired times for OFF timer and ON timer.**
See the section "To Use the OFF timer or ON timer" to set the desired mode and times.
The indoor unit's TIMER Indicator Lamp (green) (Fig. 2 ㉙) will light.

About the Program timer

- The PROGRAM timer allows you to integrate OFF timer and ON timer operations in a single sequence. The sequence can involve one transition from OFF timer to ON timer, or from ON timer to OFF timer, within a twenty-four hour period.
- The first timer function to operate will be the one set nearest to the current time. The order of operation is indicated by the arrow in the Remote Control Unit's display (OFF → ON, or OFF ← ON).
- One example of PROGRAM timer use might be to have the air conditioner automatically stop (OFF timer) after you go to sleep, then start (ON timer) automatically in the morning before you arise.

To Cancel the Timer

Press the CANCEL button.

To Change the Timer Settings

Perform operations 2-4.

To Stop Air Conditioner Operation while the Timer is Operating

Press the START/STOP button.

To Cancel the Timer

Press the CANCEL button.

TIMER Indicator Lamp (green) will go out. Canceling the OFF TIMER or the ON TIMER

1. Press the TIMER button of the function to cancel (OFF or ON).
2. Press the CANCEL button.

To Change the Timer Settings

1. Press the TIMER button of the function to change (OFF or ON).
2. Set the timer using the "+" and "-" TIMER buttons.
3. Press the SET button.

To Stop Air Conditioner Operation while the Timer is Operating

Press the START/STOP button.

SLEEP TIMER OPERATION

Unlike other timer functions, the SLEEP timer is used to set the length of time until air conditioner operate is stopped.

To Use the SLEEP timer

While the air conditioner is operating or stopped, press the SLEEP button (Fig. 5 ④).

Each time the button is pressed, the time changes in the following order:

→ 1.0 → 2.0 → 3.0 → 5.0 → 7.0 → 9.0(hour) →
(RESET)

The Indoor Unit's OPERATION Indicator Lamp (red) (Fig. 2 ⑥) and the TIMER Indicator Lamp (green) (Fig. 2 ⑤) light.

To Change the Timer Settings

Press the SLEEP button (Fig.5 ④) once to display the last setting time.

Press the SLEEP button (Fig.5 ④) again to change the time.

Each time the button is pressed, the time changes in the following order (Change from the last setting time):

→ 1.0 → 2.0 → 3.0 → 5.0 → 7.0 → 9.0(hour) →
(RESET)

Confirmation of TIMER's time

The left time of the TIMER which is being set currently will be displayed for 5 minutes.

To Cancel the Timer:

Press the CANCEL (TIMER) button.

To Stop the Air Conditioner During Timer Operation:

Press the START/STOP button.



ECONOMY OPERATION

Begin Air Conditioner operation before performing this procedure.
Open the Remote Control Unit lid.

To Use the ECONOMY Operation

Press the ECONOMY button (Fig.5 ④⑧).

"ECO" appears on the Remote Control Unit display.
Economy operation begins.

To Stop the ECONOMY Operation

Press the ECONOMY button (Fig.5 ④⑧) again.

"ECO" disappears from the Remote Control Unit display.
Normal operation begins.

About ECONOMY Operation

At the maximum output, ECONOMY Operation is approximately 70% of normal air conditioner operation for cooling and heating.

When ECONOMY operation is performed during the cooling mode, dehumidification is improved. This function is especially convenient when you want to remove the humidity in the room without significantly lowering the room temperature.

During ECONOMY operation, the thermostat setting automatically changes according to the temperature to avoid Unnecessary cooling and heating for the most economical operation.

- If the room is not cooled(or heated) well during economy operation, select normal operation.
- Once air conditioner operation is stopped, normal operation begins when the indoor unit is turned on again.
- During the monitor period in the AUTO mode, the air conditioner operation will not change to ECONOMY operation even if ECONOMY operation is selected by pressing the ECONOMY operation button.

HI-POWER OPERATION

Begin Air Conditioner operation before performing this procedure.
Open the Remote Control Unit lid.

To Use the HI-POWER Operation

Press the HI-POWER button(Fig.5 ④⑤).

The Indoor Unit's HI-POWER Indicator Lamp (orange) (Fig.2 ⑧) will light.
HI-POWER operation begins.

To Stop the HI-POWER Operation

Press the HI-POWER button(Fig.5 ④⑤) again.

The Indoor Unit's HI-POWER Indicator Lamp(orange) (Fig.2 ⑧) will go out.
Normal operation begins.

However, HI-POWER operation will automatically stop under the following conditions.

- If SUPER QUIET Operations are selected during HI-POWER Operation, HI-POWER will be cancelled.
- During cooling mode
The room temperature is 1°C below the thermostat setting or 30 minutes has passed since the HI-POWER operation began.
- During heating mode
The room temperature is 2°C above the thermostat setting.
- During fan mode
15 minutes has passed since the HI-POWER operation began.

About HI-POWER Operation

- During cooling mode
The Indoor unit will operate at maximum power until the room temperature is 1°C below the thermostat setting.
- During heating mode
The Indoor unit will operate at maximum power until the room temperature is 2°C above the thermostat setting.
- During dry mode
The airflow can not be set during HI-POWER operation
- During fan mode
The airflow from the Indoor Unit is increased.



COIL DRY OPERATION

- After allowing the interior of the indoor unit time to dry, run the UV filter clean, to limit mold and bacteria on the interior of the unit and on the air filter. This function shows clear results after cooling or dehumidifying.
- For COLID DRY Operation, press the COIL DRY button. Cleaning operations will run for about 20 minutes and stop automatically.

To start COIL DRY Operation

Press the COIL DRY button (Fig.5 ㉔) (when the air conditioner is operating or stopped).

Only the OPERATION Indicator Lamp (red) (Fig2. ㉖) on the Indoor Unit will light. "COIL DRY" appears on the Remote Control Unit display and disappears after approximately 20 minutes.

If the COIL DRY button (Fig5. ㉔) is pressed again during COIL DRY operation, COIL DRY operation will start again.

To stop COIL DRY Operation

Press the START/STOP button (Fig.5 ㉕) during COIL DRY operation.

The OPERATION Indicator Lamp (red) (Fig2. ㉖) on the Indoor Unit will go out.

- The Remote Control Unit will be in the operation-stopped condition.

About COIL DRY Operation

The following procedures are performed during COIL DRY operation before the operation automatically stops after approximately 20 minutes.

- ① Drying
After about 18 minutes of COIL DRY Operation, drying shall be performed on the interior of the indoor unit. All dirt and foul odors are to be removed from the air filter.
- ② UV filter cleaning (about 2 minutes)
UV rays are discharged onto the air filter, so that all dirt, odor, and dust undergo disinfecting and deodorizing processing, and are recycled into the dust box. At the same time, the air filter's disinfecting and deodorizing functions are reset, and returned to cleaning mode.
- ③ Operations stop
The COIL DRY operation come to an end.

⚠ NOTE!

- When COIL DRY operation begins, the Indoor Unit operates in the heating mode and the fan mode to dry the inside of the Indoor Unit. As a result, the room temperature and humidity may rise slightly.
- COIL DRY operation cannot be used to clean the air in the room.
- COIL DRY operation is most effective when performed frequently.

AUTO FILTER MAINTENANCE FUNCTION

- This is a convenient function that automatically removes dust from the air filters after a set amount of time of air conditioner operation.
- The auto filter maintenance function can also be started using the remote control unit.

Auto Filter Maintenance

About operating the Auto Filter Maintenance

- Auto filter maintenance is performed after the air conditioner operates for a set amount of time and is stopped or the FILTER button (Fig.5 ④) on the Remote Control Unit is pressed.
- During auto filter maintenance, the MAINTENANCE SIGN Indicator Lamp (red) (Fig.2 ④) on the Indoor Unit will light.

1. Air filters come out

- The air filters automatically come out of the indoor unit under the open panel. At this time, the dust on the air filters is collected in the dust boxes (behind the open panel).

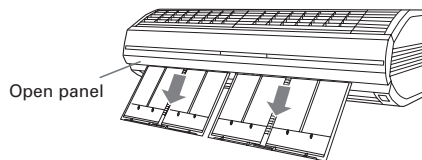

2. Air filter retract

- After the air filters come out, they automatically retract to their original positions in the Indoor Unit.

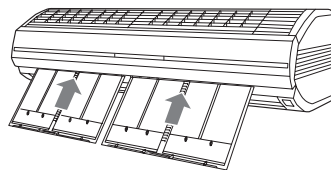

- When the auto filter maintenance is complete, the MAINTENANCE SIGN Indicator Lamp (red) (Fig.2 ④) on the Indoor Unit goes out.

MAINTENANCE SIGN Indicator Lamp(red) flashes

The MAINTENANCE SIGN Indicator Lamp (Fig.2 ④) will flash during auto filter maintenance if the air filters are not installed or are pulled. If this occurs during air conditioner operation, unplug the power supply cord from the Electrical outlet and follow procedures "Dust Box Maintenance" to install the air filters.

Changing the FILTER MAINTENANCE Interval

The filter maintenance interval can be changed. Some dust may be tough to clear away with Auto Filter Maintenance. In such a situation, please switch the Interval to 50H for more thorough cleaning. While cleaning, please place the remote control in stop mode (so that only the CLOCK and the time are displayed).

1. Hold down the SET TIME button (Fig.5 ③) for at least 3 seconds. Switches from displaying the current time to displaying the interval, and begins blinking.
2. Set the interval using the SET TIME button's \leftarrow and \rightarrow keys (Fig.5 ④). Pressing these buttons will allow you to scroll between the figures below.
50H \leftrightarrow 100H
Factory settings are 100H.
For more detailed FILTER MAINTENANCE, set to 50H.
3. Point the remote control to the main unit and press the SET button (Fig.5 ⑤). The display will stop blinking and send signals to the Indoor Unit. If you do not press the SET button (Fig.5 ⑤), there is no way to save the work time settings.

CAUTION!

Do not touch the air filters during the auto filter maintenance.

- The Indoor Unit may malfunction if the air filters are pulled or pushed.
- If the air filters are unnecessarily pulled, they may be damaged or fall and cause personal injury.

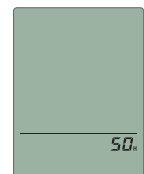
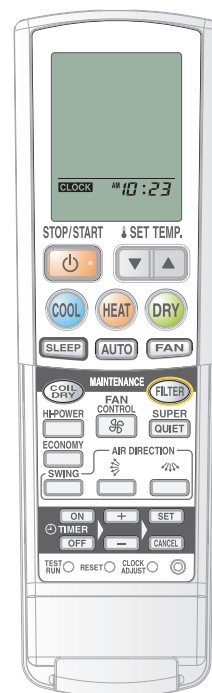



About the Auto Filter Maintenance function

- Depending on how dirty the air filters are, all of the dust may not be removed from the air filters during the auto filter maintenance. In this case, perform auto filter maintenance again.
- If dust remains on the air filters after auto filter maintenance has been performed a number of times, perform dust box maintenance (see page 16)
- Depending on the condition of the dust on the air filters, such as if the dust is particularly oily or hardened, the dust may not be removed during the auto FILTER MAINTENANCE. In this case, remove the air filters and clean with water (see page 19).
- During auto filter maintenance, clicking or hissing sounds may be produced.
- During FILTER MAINTENANCE, if you pull or push the filter upwards, the FILTER MAINTENANCE process will stop and the MAINTENANCE SIGN Indicator Lamp (red) (Fig.2 ④) will blink.
At this time, please refer to Dust Box Maintenance, FILTER Installation.
- If the FILTER is inserted too low, it will automatically correct itself by moving upwards.
- If there are any objects located under the indoor unit, should the FILTER fall out, it would hit these objects and would no longer be able to work properly.

AUTO Filter Maintenance using the Remote Control Unit

Press the FILTER button(Fig.5 ④)

(When the Air Conditioner is operating or stopped.)

The MAINTENANCE SIGN Indicator Lamp (red) (Fig.2 ④) on the Indoor Unit will light. Auto filter maintenance begins.

- If the FILTER button is pressed during Air Conditioner operation, the Air Conditioner will stop, auto filter maintenance will be performed, and the air conditioner will start operating again after the auto filter maintenance is complete.
- Even if the FILTER button is pressed during the auto filter maintenance, the cleaning will not stop.

About the notification for Dust Box cleaning

- When auto filter maintenance is not activated, but the Indoor Unit's MAINTENANCE SIGN Indicator Lamp (red) (Fig.2 ④) is illuminated, this means that it is time to perform dust box cleaning. In such a situation, please clean your dust box.
- Due to differences in Auto Filter Maintenance intervals, there are also differences in the amount of time that an air conditioner runs before its MAINTENANCE SIGN Indicator Lamp (red) (Fig.2 ④) is lit.

Auto filter maintenance interval	Interval before maintenance sign indicator lamp (red) is illuminated
50 hours	2000 hours
100 hours	4000 hours

- While the MAINTENANCE SIGN Indicator Lamp (red) is illuminated, Auto Filter Maintenance will not work. (Even if you press the Remote Control Unit's FILTER button, it will not run). In such a situation, please clean the DUST BOX, and press the MAINTENANCE/ MANUAL AUTO button (Fig.3 ⑩). The MAINTENANCE SIGN Indicator Lamp (red) (Fig.2 ④) will go out.
- The MAINTENANCE SIGN Indicator Lamp (red) will only light up when the Air Conditioner is running or coming to a halt.
- If you put out the MAINTENANCE SIGN Indicator Lamp (red) (Fig.2 ④) without cleaning the Dust Box, the next time that Auto Filter Maintenance runs, dust may spill out from the unit. When the MAINTENANCE SIGN Indicator Lamp (red) (Fig.2 ④) is illuminated, please be sure to clean the Dust Box.



PERFORMING MAINTENANCE

- Frequent maintenance will extend the life of the air conditioner and improve the cooling and heating performance.
- Before maintenance, stop air conditioner operation using the remote control and unplug the power supply cord from the electrical outlet.

CAUTION!	
<p>Before cleaning the air conditioner, be sure to turn it off and unplug the power supply cord from the electrical outlet.</p> <ul style="list-style-type: none"> ● The internal fan operates at high speed and could cause personal injury. 	<p>When cleaning the air conditioner, do not stand on any unstable objects.</p> <ul style="list-style-type: none"> ● You might fall and personal injury could result.
<p>When removing the dust boxes and grill, do not touch any metal parts (heat exchanger, etc.).</p> <ul style="list-style-type: none"> ● Personal injury may result. 	<p>When cleaning the dust boxes and grill, be sure to install them securely.</p> <ul style="list-style-type: none"> ● If the dust boxes and grill are not properly installed, they could fall and cause personal injury.

Dust Box Maintenance

- If the MAINTENANCE SIGN Indicator Lamp (red) (Fig.2 ④) on the Indoor Unit is lit, be sure to clean the dust boxes. If the Indoor Unit is installed in an area with a lot of dust, clean the dust boxes every 3 months even if the MAINTENANCE SIGN Indicator Lamp (red) (Fig.2 ④) is not lit.
- When cleaning the dust boxes, dust may fall to the floor. Lay newspaper, etc. under the Indoor Unit before cleaning the dust boxes.

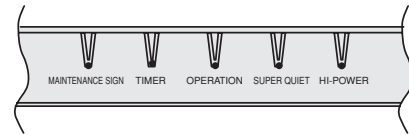

1. Remove the dust boxes and air filters from the indoor unit. Remove the air filters from the dust boxes.

- Preparation**
- Stop the air conditioner using the Remote Control Unit.
 - Unplug the power supply cord from the electrical outlet.

1. Open the open panel.

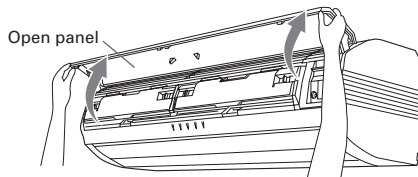

Grab both sides of the open panel and fully open the open panel. Continue to open the open panel past the horizontal position. (The panel will remain open even after it is released.)

3. Remove the dust boxes and air filters.

Grab the center of each dust box, lift the bottom in direction 1, and then remove the dust box in direction 2. (Remove the dust boxes and air filters together.)

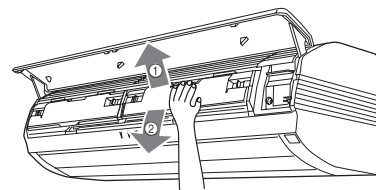

2. Remove the dust box's lock.

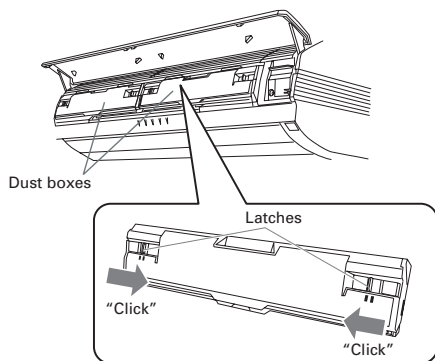

Move the holding positions (yellow) on either side of the dust boxes (2 on the left and right) inwards, and remove the lock.

4. Remove the air filter from each dust box.

Grab the holding position on the air filter and pull the air filter out from the dust box in the direction of the arrow.

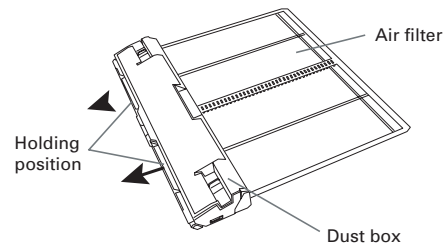

- When the air filter is removed from the dust box, dust may fall from the dust box. Lay newspaper, etc. under the dust box before removing the air filter.





2. Remove the dust collected in the dust boxes and clean the dust boxes.

1. Open the dust boxes.

- ① Hold the latch (light blue) on both sides of the interior of the dust box, and pull outwards until you hear a "click" sound.

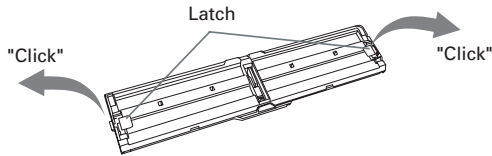

- ② Open the interior of the box.

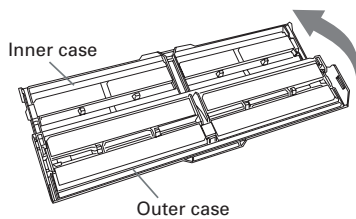

- Be gentle when opening, as excess force may result in damage and malfunction.
- When opening the inner case, dust collected inside the dust box may fall out. During this process, please place newspapers or some other cover under the dust box.

- ③ Cleaning the interior of the box.
 - Use a vacuum to clean up the dust on the brush and the box, or use a brush to wipe this dust away.

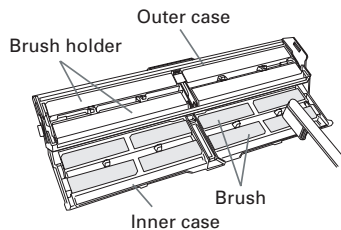

- Do not be too forceful when opening up the brush holder. Otherwise, this may result in damage and malfunction.

2. Wash the front and rear cases with water if they are extremely dirty.

- ① Lightly rub the brushes clean with 40°C–45°C hot water. If the brushes are difficult to clean, apply a mild synthetic laundry detergent (low or neutral alkalinity) and rub lightly.
 - ② Rub the front and rear cases lightly with a sponge.
 - ③ Rinse under running water.
 - ④ Remove the water from the front and rear cases.
 - ⑤ Wipe the brushes and cases with a towel, etc., and place in a shaded area to dry.
- Do not use a cleaner other than a mild synthetic laundry detergent (low or neutral alkalinity).
 - Do not clean with hot water above 60°C.
 - Do not clean with any abrasive or hard object.
 - Do not dry with hot air from a hair dryer, etc. The cases may be deformed and the brushes may come off.

- After washing with water, make sure the dust boxes are completely dry before installation. The brushes are especially difficult to dry so wipe them with a towel, etc. to make sure they are completely dry. If the dust boxes are installed wet, the dust may not be removed from the air filters during auto filter maintenance.

3. Dust box installation

- ① First pull down on the outer casing, and then cover up the inner casing.

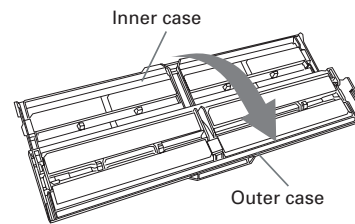

- ② Put the latches (light blue) on either side into their place.

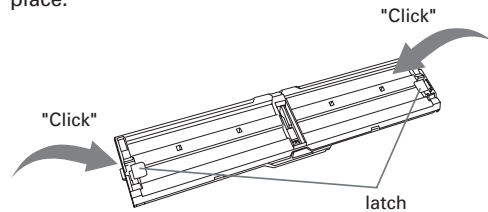

- When installing the dust box, please insert the latch directly into its correct position. If the latch is not fully in place, and the box is installed onto the main unit, Auto Filter Maintenance will not work.



3. Install the dust box onto the main unit, press the "MAINTENANCE / MANUAL AUTO" button, and then insert the air filter.

1. Install the dust box onto the main unit.

- ① Make sure that the dust box's 2 yellow latches are open.
- ② Open the front panel and insert the dust box into the unit until you hear it catch in place.

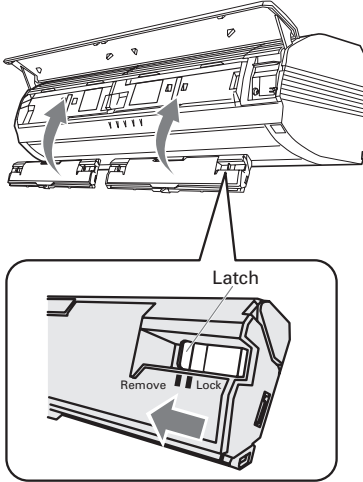

- ③ Insert the dust box fully and move the two latches on either side outside to lock it in place.

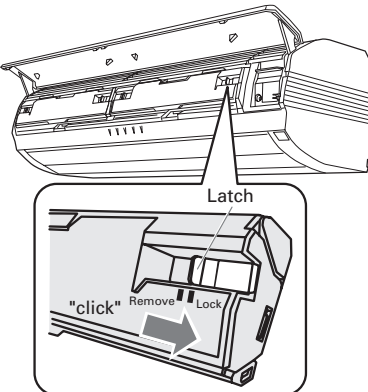

- If the latches are locked while installing the dust box, malfunctions may result and the dust box may fall out.
- During installation, make sure that you have a good grip of the middle of the dust box and insert it soundly in its place. Should there be any errors in installation, the dust box may fall out and cause injury.

2. Insert the power supply line into its socket and press the MAINTENANCE / MANUAL AUTO button (Fig.3 ⑪).

- ① Insert the power supply line into its socket.
- ② Press the unit's "MAINTENANCE / MANUAL AUTO" button.

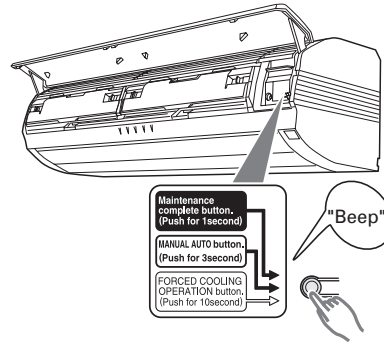

*If the MAINTENANCE SIGN Indicator Lamp (red) (Fig.2 ④) light is illuminated, it will go out at this point.

- Press down on the MAINTENANCE / MANUAL AUTO button, and release the button when you hear a "beep." If the MAINTENANCE / MANUAL AUTO button is held down for more than 3 seconds, MANUAL AUTO Operation will begin (page 21).
- Please be sure to press the MAINTENANCE / MANUAL AUTO button. Auto Filter Maintenance is unable to be performed when the MAINTENANCE SIGN Indicator Lamp (red) (Fig.2 ④) is illuminated.

3. Insert the air filters into the unit (one on both the left and right side).

- ① Insert the air filter net into the dust box slot.

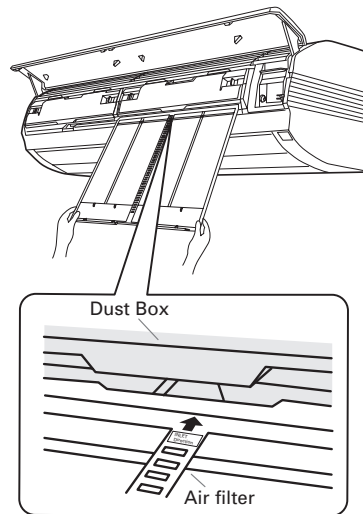

- ② Insert the air filter until it reaches the upper limits of the air filter frame (on both sides). (After about 2 seconds, the air filter will automatically lock into its place).

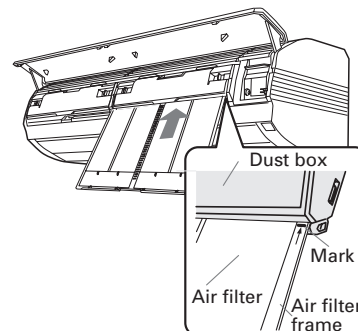



PERFORMING MAINTENANCE (CONTINUED)

3. Install the dust box onto the main unit, press the "MAINTENANCE / MANUAL AUTO" button, and then insert the air filter. (Continued)

- ③ Following the same procedure, insert the other side's air filter.
- During installation, please make sure that both the filter and your hands are dry. Any moisture on the filter or on your hands may result in malfunctions or electric shock.
- Please insert the air filter correctly according to the designated direction. Incorrect insertion may result in excess noise or functional problems.
- Insert the air filter to the point designated on the filter.

If the filter is not in the correct position, it may not automatically lock into its place.

4. Close the Front Panel.

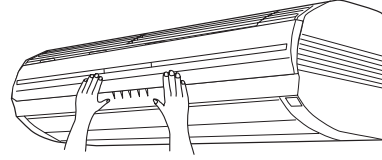

Air Filter Maintenance

- Wash the air filters with water if small dust particles remain on the air filters even after auto filter maintenance is performed.
- It is recommended to perform dust box maintenance when the air filter maintenance is performed.

1. Open the open panel, and then remove the dust boxes and air filters.

Refer to procedure 1 in Dust Box Maintenance (see page 16).

2. Remove the air filters from the dust boxes.

Refer to procedure 1 in Dust Box Maintenance (see page 16).

3. Remove the dust with a vacuum cleaner, and then wash the air filters with water.

- If there is excessive oil or dirt, please wash with synthetic kitchen detergent (medium-grade).
- Wipe the air filters with a towel, etc., after washing them with water, and then place them in a shaded area to dry.
- Do not bend the air filters. The air filters may be damaged and prevent the auto filter maintenance from being performed. Please pay special attention to the air filter frame and the internal gears.

- Do not clean the air filters with any abrasive or hard object. The air filters may be damaged.
- Do not clean with hot water above 60°C.
- Do not dry with hot air from a hair dryer, etc. The air filters may be deformed.
- After washing the air filters with water, do not forcefully shake them dry. The air filters may be damaged.

4. Install the dust boxes and air filters in the indoor unit, and then close the open panel.

Refer to procedure 4 in Dust Box Maintenance (see page 16).

About the air filter (titanium apatite micro-filter)

- With a micro-fiber filter (extra fine) enhanced by the addition of titanium apatite, disinfection and deodorization is performed on dust gathered from the air and all types of odorous bacteria.
- UV rays on the filter's titanium enhance the effects of disinfecting and deodorizing, and leave the air filter completely clean.

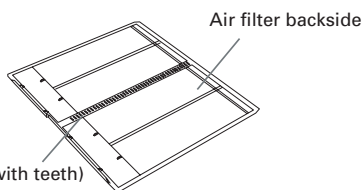

Indoor Unit Maintenance

- Remove the dust from the exterior of the indoor unit with a vacuum cleaner, wipe the unit with lukewarm water, and then dry with a clean, soft cloth.
- Do not clean with water above 40°C. The exterior of the indoor unit may be deformed and become discolored.
- Do not clean with benzene, paint thinner, or polish. They will damage the exterior of the indoor unit.

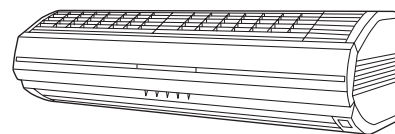

En-19



PERFORMING MAINTENANCE (CONTINUED)

Intake Grille Maintenance

- Perform dust box maintenance at the same time.

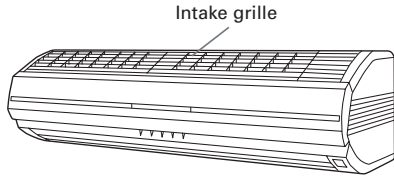

1. Open the open panel.

Refer to procedure 1 in Dust Box Maintenance (See page 16).

2. Removing the Intake grille.

- ① Push the grille's holding positions (4) on the interior of the open panel upwards (releasing the front panel's four holding positions).

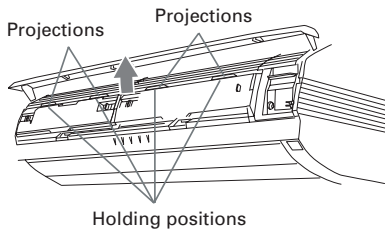

- ② Grasp the Intake grille's upper holding positions and pull them forward.

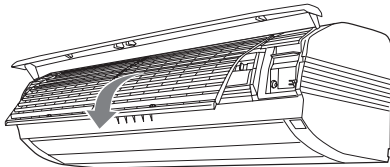

3. Wash with water.

Remove the dust from the intake grilles with a vacuum cleaner, wipe them with lukewarm water, and then dry them with a clean, soft cloth.

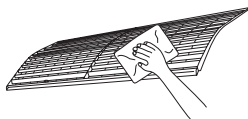

- Do not clean with water above 40 °C. The exterior of the indoor unit may be deformed and become discolored.

4. Install the intake grilles.

- ① Slide each intake grille into the indoor unit along the guide rails under the open panel until it stops. (Lift up slightly on the intake grille as it is being installed.)

⚠ CAUTION!

Be sure to install the intake grilles securely.

- If the intake grilles are not installed securely, they may fall and cause personal injury.

5. Install the Intake grilles.

- ① Slide Intake grille into the indoor unit along the guide rails under the open panel until it stop. (Lift up slightly on the intake grille as it is being installed.)

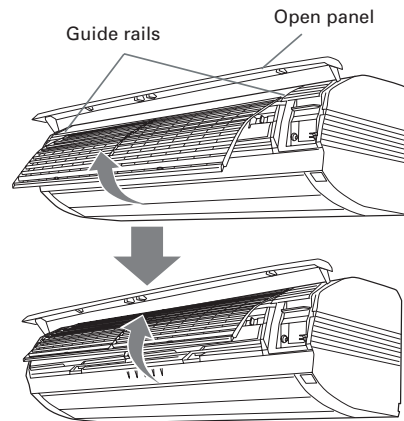

- Make sure that the intake grilles are installed in the correct direction. FRONT is stamped on the holding position of each intake grille.

- ② Insert the four projections on each intake grille into the indoor unit in the direction of the arrows shown.

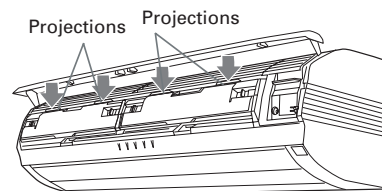

- If the intake grilles are not installed properly along the guide rails until they stop, the projections will not fit into the indoor unit. After installation, make sure the intake grilles are installed securely by gently moving them forward and backward and from side to side.

6. Close the open panel.

Refer to procedure 4 in Dust Box Maintenance (See page 16).

MANUAL AUTO OPERATION

Use the MANUAL AUTO operation in the event the Remote Control Unit is lost or otherwise unavailable.

REMOTE CONTROL UNIT UNAVAILABLE (MANUAL AUTO OPERATION)

If the Remote Control Unit is lost or the batteries are dead, the air conditioner can be operated provisionally from the indoor unit.

1. Open the open panel.

Grab both sides of the open panel and open the open panel until it is held in place. (The panel will remain open even after it is released.)

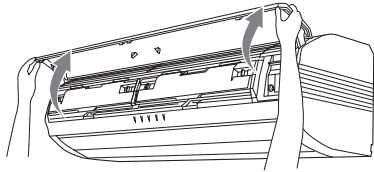

3. Close the open panel.

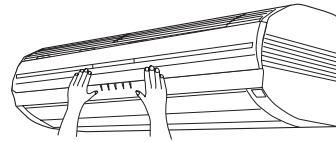

- Do not operate the air conditioner with the open panel open.

2. Press the MAINTENANCE/MANUAL AUTO button (Fig.3 ⑪) for 3 seconds.

- Press the MAINTENANCE/MANUAL AUTO button (Fig.3 ⑪) and continue to press the button even after a beeping sound is produced. The OPERATION Indicator Lamp (red) (Fig.2 ⑥) on the Indoor Unit will light. The air conditioner will operate in the auto mode (see page 7). Airflow will be automatic, airflow direction will be the standard setting, and the thermostat settings will be the standard temperature.

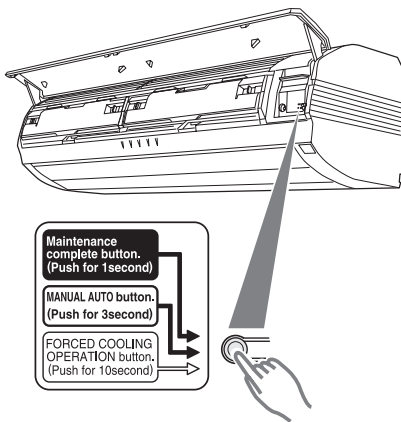

Stopping MANUAL AUTO Operation

Press the MAINTENANCE/MANUAL AUTO button (Fig.3 ⑪) for 3 seconds.

Air conditioner operation will stop and the OPERATION Indicator Lamp (red) (Fig.2 ⑥) on the Indoor Unit will go out.

TROUBLESHOOTING

WARNING!

In the event of a malfunction (burning smell, etc.), immediately stop operation, disconnect the Power Supply Plug, and consult authorized service personnel.
Merely turning off the unit's power switch will not completely disconnect the unit from the power source. Always be sure to disconnect the Power Supply Plug or turn off your circuit breaker to ensure that power is completely off.

Before requesting service, perform the following checks:

	Symptom	Problem	See Page
NORMAL FUNCTION	Doesn't operate immediately:	<ul style="list-style-type: none"> ● If the unit is stopped and then immediately started again, the compressor will not operate for about 3 minutes, in order to prevent fuse blowouts. ● Whenever the Power Supply Plug is disconnected and then re-connected to a power outlet, the protection circuit will operate for about 3 minutes, preventing unit operation during that period. 	—
	Noise is heard:	<ul style="list-style-type: none"> ● During operation and immediately after stopping the unit, the sound of water flowing in the air conditioner's piping may be heard. Also, noise may be particularly noticeable for about 2 to 3 minutes after starting operation (sound of coolant flowing). ● During operation, a slight squeaking sound may be heard. This is the result of minute expansion and contraction of the front cover due to temperature changes. 	—
		<ul style="list-style-type: none"> ● During Heating operation, a sizzling sound may be heard occasional. This sound is produced by the Automatic Defrosting operation. 	23
	Smells:	<ul style="list-style-type: none"> ● Some smell may be emitted from the indoor unit. This smell is the result of room smells (furniture, tobacco, etc.) which have been taken into the air conditioner. 	—
	Mist or steam are emitted:	<ul style="list-style-type: none"> ● During Cooling or Dry operation, a thin mist may be seen emitted from the indoor unit. This results from the sudden Cooling of room air by the air emitted from the air conditioner, resulting in condensation and misting. 	—
		<ul style="list-style-type: none"> ● During Heating operation, the outdoor unit's fan may stop, and steam may be seen rising from the unit. This is due to Automatic Defrosting operation. 	23
	Airflow is weak or stops:	<ul style="list-style-type: none"> ● When Heating operation is started, fan speed is temporarily very low, to allow internal parts to warm up. ● During Heating operation, if the room temperature rises above the thermostat setting, the outdoor unit will stop, and the indoor unit will operate at very low fan speed. If you wish to warm the room further, set the thermostat for a higher setting. 	—
		<ul style="list-style-type: none"> ● During Heating operation, the unit will temporarily stop operation (between 7 and 15 minutes) as the Automatic Defrosting mode operates. During Automatic Defrosting operation, the OPERATION indicator lamp will flash. 	23
		<ul style="list-style-type: none"> ● The fan may operate at very low speed during Dry operation or when the unit is monitoring the room's temperature. 	6
		<ul style="list-style-type: none"> ● During SUPER QUIET operation, the fan will operate at very low speed. 	6
<ul style="list-style-type: none"> ● In the monitor AUTO operation, the fan will operate at very low speed. 		6	
Water is produced from the outdoor unit:	<ul style="list-style-type: none"> ● During Heating operation, water may be produced from the outdoor unit due to Automatic Defrosting operation. 	23	

TROUBLESHOOTING

	Symptom	Items to check	See Page
CHECK ONCE MORE	Doesn't operate at all:	<ul style="list-style-type: none"> ● Is the Power Supply Plug disconnected its outlet? ● Has there been a power failure? ● Has a fuse blown out, or a circuit breaker been tripped? 	—
		<ul style="list-style-type: none"> ● Is the timer operating? 	10 - 11
	Poor Cooling performance:	<ul style="list-style-type: none"> ● Is the Air Filter dirty? ● Air the air conditioner's intake grille or outlet port blocked? ● Did you adjust the room temperature settings (thermostat) correctly? ● Is there a window or door open? ● In the case of Cooling operation, is a window allowing bright sunlight to enter? (Close the curtains.) ● In the case of Cooling operation, are there heating apparatus and computers inside the room, or are there too many people in the room? 	—
		<ul style="list-style-type: none"> ● Is the unit set for SUPER QUIET operation? 	6
The unit operates differently from the Remote Control Unit's setting:	<ul style="list-style-type: none"> ● Are the Remote Control Unit's batteries dead? ● Are the Remote Control Unit's batteries loaded properly? 	5	

If the problem persists after performing these checks, or if you notice burning smells, or the OPERATION Indicator Lamp (red) (Fig. 2 ⑥) and the TIMER Indicator Lamp (green) (Fig. 2 ⑤) flashes, immediately stop operation, disconnect the Power Supply Plug (Fig. 1 ⑱), and consult authorized service personnel.

OPERATING TIPS

Operation and Performance

Heating Performance

- This air conditioner operates on the heat-pump principle, absorbing heat from outdoor air and transferring that heat indoors. As a result, the operating performance is reduced as outdoor air temperature drops. If you feel that insufficient heating performance is being produced, we recommend you use this air conditioner in conjunction with another kind of heating appliance.
- Heat-pump air conditioners heat your entire room by recirculating air throughout the room, with the result that some time may be required after first starting the air conditioner until the room is heated.

Microcomputer-controlled Automatic Defrosting

- When using the Heating mode under conditions of low outdoor temperature and high humidity, frost may form on the outdoor unit, resulting in reduced operating performance.

In order to prevent this kind of reduced performance, this unit is equipped with a Microcomputer-controlled Automatic Defrosting function. If frost forms, the air conditioner will temporarily stop, and the defrosting circuit will operate briefly (for about 7-15 minutes).

During Automatic Defrosting operation, the OPERATION Indicator Lamp (red) (Fig. 2 ⑥) will flash.

AUTO Restart

In Event of Power Interruption

- The air conditioner power has been interrupted by a power failure. The air conditioner will then restart automatically in its previous mode when the power is restored.
- Operated by setting before the power failure.

- If a power failure occurs during TIMER operation, the timer will be reset and the unit will begin (or stop) operation at the new time setting. In the event that this (kind of timer fault occurs the TIMER Indicator Lamp (green) (Fig.2 ⑤) will flash (see Page. 3).
- Use of other electrical appliances (electric shaver, etc.) or nearby use of a wireless radio transmitter may cause the air conditioner to malfunction. In this event, temporarily disconnect the Power Supply Plug, reconnect it, and then use the Remote Control Unit to resume operation.

OPERATING TIPS

Temperature and Humidity Range

	Cooling Mode	Dry Mode	Heating Mode
Outdoor temperature	About -10 to 43 °C	About -10 to 43 °C	About -15 to 24 °C
Indoor temperature	About 18 to 32 °C	About 18 to 32 °C	About 30 °C or less

- If the air conditioner is used under higher temperature conditioner than those listed, the built-in protection circuit may operate to prevent internal circuit damage. Also, during Cooling and Dry modes, if the unit is used under conditions of lower temperature than those listed above, the heat-exchanger may freeze, leading to water leakage and other damage.
- Do not use this unit for any purposes other than the Cooling, Dehumidifying, and air-circulation of rooms in ordinary dwellings.
- If the unit is used for long periods under high-humidity conditions, condensation may form on the surface of the indoor unit, and drip onto the floor or other objects underneath. (About 80% or more)

Tips for saving energy

- When the outdoor temperature is low (about 10°C or less), the unit will consume the power of 20~40W unless the power plug is disconnected from the outlet even if the air conditioner turns off.
- Remove the power plug to stop the power supply for energy saving when not using for a long time.