



Panasonic®

Operating Instructions Air Conditioner

Model No.

Indoor Unit

CS-W7NKD

CS-W9NKD

CS-W12NKD

Outdoor Unit

CU-W7NKD

CU-W9NKD

CU-W12NKD



ENGLISH

Before operating the unit, read these operating instructions thoroughly and keep them for future reference.



QUICK GUIDE

© Panasonic HA Air-Conditioning (M) Sdn. Bhd. 2011.
Unauthorized copying and distribution is a violation
of law.

OPERATION CONDITION

Use this air conditioner under the following temperature range

Temperature (°C)		Indoor		Outdoor	
		*DBT	*WBT	*DBT	*WBT
COOLING	Max.	32	23	43	26
	Min.	16	11	16	11
HEATING	Max.	30	-	24	18
	Min.	16	-	-5	-6

*DBT: Dry bulb temperature

*WBT: Wet bulb temperature

УСЛОВИЯ ЭКСПЛУАТАЦИИ

Используйте данный кондиционер в следующем диапазоне температур

Температура (°C)		В помещении		Вне помещения	
		*DBT	*WBT	*DBT	*WBT
ОХЛАЖДЕНИЕ	Макс.	32	23	43	26
	Мин.	16	11	16	11
ОБОГРЕВ	Макс.	30	-	24	18
	Мин.	16	-	-5	-6

*DBT: Температура по сухому термометру

*WBT: Температура по влажному термометру

УМОВИ ЕКСПЛУАТАЦІЇ

Кондиціонер потрібно використовувати в такому температурному діапазоні

Температура (°C)		У приміщенні		Зовні	
		*DBT	*WBT	*DBT	*WBT
ОХОЛОДЖЕННЯ	Макс.	32	23	43	26
	Мин.	16	11	16	11
ОБИГРІВ	Макс.	30	-	24	18
	Мин.	16	-	-5	-6

*DBT: Температура за сухим термометром

*WBT: Температура за вологим термометром

ПАЙДАЛАНУ ШАРТЫ

Осы ауа желдеткішін мына температура ауқымында пайдаланыңыз

Температура (°C)		Ішкі		Сыртқы	
		*DBT	*WBT	*DBT	*WBT
САЛҚЫНДАТУ	Ең көп	32	23	43	26
	Ең аз	16	11	16	11
ЖЫЛЫТУ	Ең көп	30	-	24	18
	Ең аз	16	-	-5	-6

*DBT: Құрғақ температура

*WBT: Ылғал температура

SAFETY PRECAUTIONS

To prevent personal injury, injury to others, or property damage, please comply with the following. Incorrect operation due to failure to follow instructions below may cause harm or damage, the seriousness of which is classified as below:

 **WARNING**

This sign warns of death or serious injury.

 **CAUTION**

This sign warns of injury or damage to property.

The instructions to be followed are classified by the following symbols:









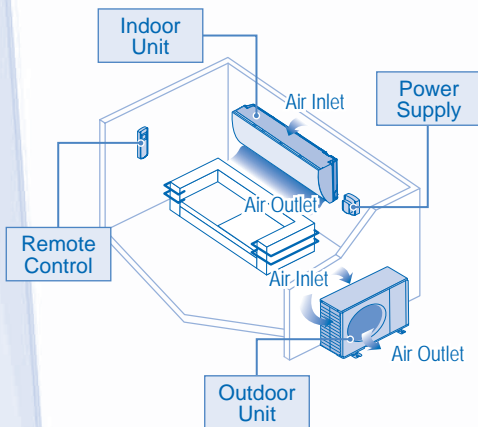

This symbol denotes an action that is PROHIBITED.



These symbols denote an actions that is COMPULSORY.



 WARNING	
INDOOR UNIT AND OUTDOOR UNIT	
	<p>This appliance is not intended for use by persons (including children) with reduced physical, sensory or mental capabilities, or lack of experience and knowledge, unless they have been given supervision or instruction concerning use of the appliance by a person responsible for their safety. Children should be supervised to ensure that they do not play with the appliance.</p> <p>Please consult authorized dealer or specialist to clean the internal parts, repair, install, remove and reinstall the unit. Improper installation and handling will cause leakage, electric shock or fire.</p> <p>Confirm to authorized dealer or specialist on usage of specified refrigerant type. Using of refrigerant other than the specified type may cause product damage, burst and injury etc.</p>
	<p>Do not install the unit in a potentially explosive or flammable atmosphere. Failure to do so could result in fire.</p>
	<p>Do not insert your fingers or other objects into the air conditioner indoor or outdoor unit, rotating parts may cause injury.</p>
	<p>Do not touch the outdoor unit during lightning, it may cause electric shock.</p> <p>Do not expose yourself directly to cold air for a long period to avoid excess cooling.</p> <p>Do not sit or step on the unit, you may fall down accidentally.</p>
REMOTE CONTROL	
	<p>Do not allow infants and small children to play with the remote control to prevent them from accidentally swallowing the batteries.</p>
POWER SUPPLY	
	<p>Do not use a modified cord, joint cord, extension cord or unspecified cord to prevent overheating and fire.</p> <p style="text-align: right;"></p> <p>To prevent overheating, fire or electric shock:</p> <ul style="list-style-type: none"> • Do not share the same power outlet with other equipment. • Do not operate with wet hands. • Do not over bend the power supply cord. • Do not operate or stop the unit by inserting or pulling out the power plug.



WARNING

POWER SUPPLY



If the supply cord is damaged, it must be replaced by the manufacturer, its service agent or similarly qualified persons in order to avoid a hazard.

It is strongly recommended to be installed with Earth Leakage Circuit Breaker (ELCB) or Residual Current Device (RCD) to prevent electric shock or fire.

To prevent overheating, fire or electric shock:

- Insert the power plug properly.
- Dust on the power plug should be periodically wiped with a dry cloth.

Stop using the product if any abnormality/failure occurs and disconnect the power plug or turn off the power switch and breaker.

(Risk of smoke/fire/electric shock)

Examples of abnormality/failure

- The ELCB trips frequently.
- Burning smell is observed.
- Abnormal noise or vibration of the unit is observed.
- Water leaks from the indoor unit.
- Power cord or plug becomes abnormally hot.
- Fan speed cannot be controlled.
- The unit stops running immediately even if it is switched on for operation.
- The fan does not stop even if the operation is stopped.

Contact your local dealer immediately for maintenance/repair.



This equipment must be earthed to prevent electrical shock or fire.



Prevent electric shock by switching off the power supply and unplug when:

- Before cleaning or servicing.
- Extended non-use.
- Abnormally strong lightning activity.



CAUTION

INDOOR UNIT AND OUTDOOR UNIT



Do not wash the indoor unit with water, benzene, thinner or scouring powder to avoid damage or corrosion at the unit.

Do not use for preservation of precise equipment, food, animals, plants, artwork or other objects. This may cause quality deterioration, etc.

Do not use any combustible equipment in front of the airflow outlet to avoid fire propagation.

Do not expose plants or pet directly to airflow to avoid injury, etc.

Do not touch the sharp aluminium fin, sharp parts may cause injury.



Do not switch ON the indoor unit when waxing the floor. After waxing, aerate the room properly before operating the unit.

Do not install the unit in oily and smoky areas to prevent damage to the unit.

Do not dismantle the unit for cleaning purpose to avoid injury.

Do not step onto an unstable bench when cleaning the unit to avoid injury.

Do not place a vase or water container on the unit. Water may enter the unit and degrade the insulation. This may cause an electric shock.

Do not open window or door for long time during COOL/DRY mode operation.



Ensure drainage pipe is connected properly and keep drainage outlet clear of gutters, containers or does not immersed in water to prevent water leakage.

After a long period of use or use with any combustible equipment, aerate the room regularly.

After a long period of use, make sure the installation rack does not deteriorate to prevent the unit from falling down.

REMOTE CONTROL



Do not use rechargeable (Ni-Cd) batteries. It may damage the remote control.



To prevent malfunction or damage of the remote control:

- Remove the batteries if the unit is not going to be used for a long period of time.
- New batteries of the same type must be inserted following the polarity stated.

POWER SUPPLY



Do not pull the cord to disconnect the plug to prevent electric shock.

REMOTE CONTROL

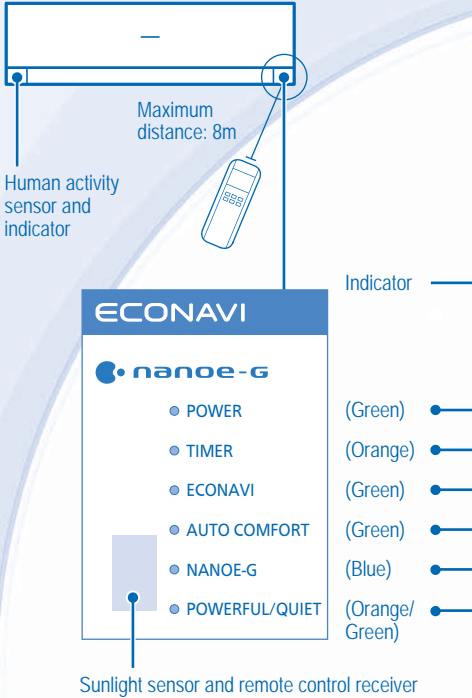

Remote Control display

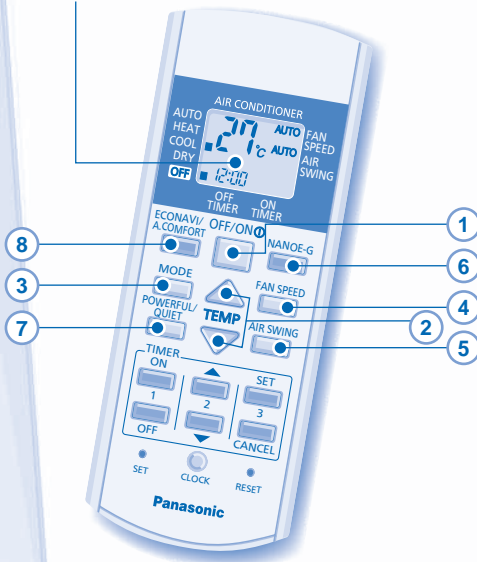

Press the remote control's button

1 TO TURN ON OR OFF THE UNIT

- Please be aware of the OFF indication on the remote control display to prevent the unit from starting/stopping improperly.

2 TO SET TEMPERATURE

- For heat, cool and dry modes, the range of temperature for selection is 16°C ~ 30°C.
- Operating the unit within the recommended temperature could induce energy saving.
HEAT mode : 20°C ~ 24°C.
COOL mode : 26°C ~ 28°C.
DRY mode : 1°C ~ 2°C lower than room temperature.

3 TO SELECT OPERATION MODE

AUTO mode - For your convenience

- Unit selects the operation mode according to the room temperature.
- Once auto mode is selected, the unit will operate at the standard setting temperature.

Room temperature	Operation mode	Standard setting temperature
23°C & above	Cool	25°C
Below 23°C	Dry	22°C
Below 20°C	Heat	21°C

- Press  for "HI" to +2°C or  for "LO" to -2°C to the standard setting temperature.

HEAT mode - To enjoy warm air

- Unit takes a while to warm up. The power indicator blinks during this operation.

COOL mode - To enjoy cool air

- Use curtains to screen off sunlight and outdoor heat to reduce power consumption during cool mode.

DRY mode - To dehumidify the environment

- Unit operates at low fan speed to give a gentle cooling operation.

4 TO SELECT FAN SPEED (3 OPTIONS)



- For AUTO, the indoor fan speed is automatically adjusted according to the operation mode.

5 TO ADJUST VERTICAL AIRFLOW DIRECTION (5 OPTIONS)



- Keeps the room ventilated.
- In COOL/DRY mode, if AUTO is set, the louver swing up/down automatically.
- In HEAT mode, if AUTO is set, the louver fix at predetermined position.

6 TO PURIFY THE AIR

- Removes/deactivates harmful micro-organisms such as viruses, bacteria, etc.
- Can be activated even when the unit is turned off. In this condition, fan speed and air swing cannot be adjusted.
- nanoe-G starts automatically with the unit switched on



7 TO SWITCH BETWEEN POWERFUL & QUIET



POWERFUL TO REACH TEMPERATURE QUICKLY 

- This operation will stop automatically after 20 minutes.

QUIET TO ENJOY QUIET OPERATION 

- This operation reduces airflow noises.

8 TO MONITOR HUMAN PRESENCE & ACTIVITY FOR ENERGY SAVING & COMFORT



ECONAVI  To optimize energy saving

A.COMFORT  To maximize comfort

Heat Source & Movement	Low	High	Normal	None
COOL/DRY Mode Set Temperature	+0.3°C			+2°C
Set Fan Speed	+1 tap*	-1°C	+1 tap	≤ Medium Fan

HEAT Mode Set Temperature	+0.3°C			
Set Fan Speed		-1°C		-2°C

* For first 15 minutes or until set temperature is reached.

- The human activity sensor may not detect moving objects further than 7m away or beyond detection angle.
- The human activity sensor sensitivity is influenced by indoor unit location, movement speed, temperature range, etc.
- The human activity sensor may mistakenly detect pets, certain lighting, fluttering curtains and light reflection as human being.

NOTES



- Can be activated in all modes and can be cancelled by pressing the respective button again.

- Cannot be selected at the same time.

REMOTE CONTROL

- 9 Press and hold for 5 seconds to dim or restore the unit's indicator brightness.
- 10 Press and hold for approximately 10 seconds to show temperature setting in °C or °F.
- 11 Press to restore the remote control's default setting.
- 12 Not used in normal operations.

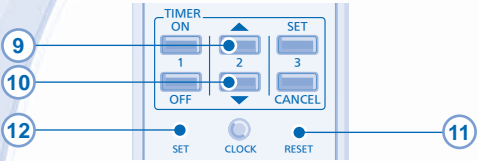

TO SET THE TIMER

- To turn ON or OFF the unit at a preset time.

 Select ON or OFF timer	 Set the time	 Confirm
----------------------------	------------------	-------------

- To cancel ON or OFF timer, press or then press .
- When ON Timer is set, the unit may start earlier (up to 30 minutes) before the actual set time in order to achieve the desired temperature on time.
- Timer operation is based on the clock set in the remote control and repeats daily once set. For clock setting, please refer to Remote Control Preparation on the back cover.
- If timer is cancelled manually or due to power failure, you can restore the previous setting (once power is resumed) by pressing .

INDOOR UNIT



CAUTION

- Switch off the power supply and unplug before cleaning.
- Do not touch the aluminium fin, sharp parts may cause injury.

CLEANING INSTRUCTIONS

- Do not use benzene, thinner or scouring powder.
- Use only soap (≈ pH7) or neutral household detergent.
- Do not use water hotter than 40°C.

HINT

- To ensure optimal performance of the unit, cleaning maintenance has to be carried out at regular intervals. Please consult authorized dealer.

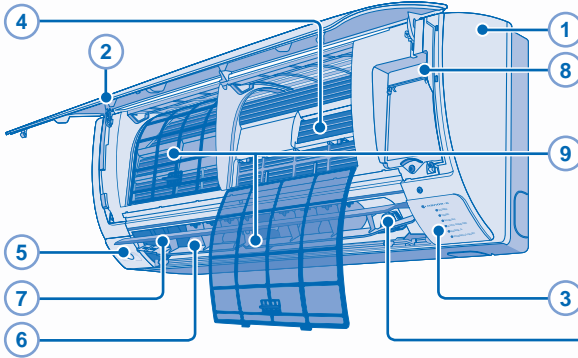

5 HUMAN ACTIVITY SENSOR

- Do not hit or violently press the sensor or poke it with a sharp object. This can lead to damage and malfunction.
- Do not place large objects near the sensor and keep away heating units or humidifiers from the sensor's detection area. This may lead to sensor malfunction.

10 nanoe-G GENERATOR

- Do not touch during operation.

1 INDOOR UNIT

- Wipe the unit gently with a soft, dry cloth.

2 FRONT PANEL

Remove Front Panel

- Raise and pull to remove the front panel.
- Wash gently and dry.

Close Front Panel



- Press down both ends of the front panel to close it securely.

3 REMOTE CONTROL RECEIVER

4 ALUMINIUM FIN

5 HUMAN ACTIVITY SENSOR

6 HORIZONTAL AIRFLOW DIRECTION LOUVER

- Manually adjustable.



7 VERTICAL AIRFLOW DIRECTION LOUVER

- Do not adjust by hand.

8 AUTO OFF/ON BUTTON

- Use when remote control is misplaced or a malfunction occurs.

Action	Mode
Press once.	Auto
Press and hold until 1 beep is heard, then release.	Cooling
Press the button to turn off.	

9 AIR FILTERS

- Air filter cleaning is required every two weeks.
- Wash/rinse the filters gently with water to avoid damage to the filter surface.
- Dry the filters thoroughly under shade, away from fire or direct sunlight.
- Replace any damaged filters.

10 nanoe-G GENERATOR

Clean with dry cotton bud.

- nanoe-G generator cleaning is recommended every 6 months.



TROUBLESHOOTING

The following symptoms do not indicate malfunction.

SYMPTOM	CAUSE
Mist emerges from indoor unit.	▶ • Condensation effect due to cooling process.
Water flowing sound during operation.	▶ • Refrigerant flow inside the unit.
The room has a peculiar odor.	▶ • This may be due to damp smell emitted by the wall, carpet, furniture or clothing.
Indoor fan stops occasionally during automatic fan speed setting.	▶ • This helps to remove the surrounding odours.
Operation is delayed a few minutes after restarting.	▶ • The delay is a protection to the unit's compressor.
Outdoor unit emits water/steam.	▶ • Condensation or evaporation occurs on pipes.
TIMER indicator is always on.	▶ • The timer setting repeats daily once set.
POWER indicator blinks during operation and the indoor fan is stopped.	▶ • The unit is in defrost mode, and the melted frost is drained from the outdoor unit.
Indoor fan stops occasionally during heating operation.	▶ • To avoid unintended cooling effect.
Cracking sound during operation.	▶ • Changes of temperature caused the expansion/contraction of the unit.

Check the following before calling for servicing.

SYMPTOM	CHECK
Heating/Cooling operation is not working efficiently.	▶ • Set the temperature correctly. • Close all doors and windows. • Clean or replace the filters. • Clear any obstruction at the air inlet and air outlet vents.
Noisy during operation.	▶ • Check if the unit has been installed at an incline. • Close the front panel properly.
Remote control does not work. (Display is dim or transmission signal is weak.)	▶ • Insert the batteries correctly. • Replace weak batteries.
The unit does not work.	▶ • Check if the circuit breaker is tripped. • Check if timers have been set.
The unit does not receive the signal from the remote control.	▶ • Make sure the receiver is not obstructed. • Certain fluorescent lights may interfere with signal transmitter. Please consult authorized dealer.

FOR SEASONAL INSPECTION AFTER EXTENDED NON-USE

- Checking of remote control batteries.
- No obstruction at air inlet and air outlet vents.
- After 15 minutes of operation, it is normal to have the following temperature difference between air inlet and air outlet vents:

Cooling: $\geq 8^{\circ}\text{C}$

Heating: $\geq 14^{\circ}\text{C}$

FOR EXTENDED NON-USE

- Activate Heat mode for 2-3 hours as an alternative to remove moisture left in the internal parts thoroughly to prevent mould growth.
- Turn off the power supply and unplug.
- Remove the remote control batteries.

NON SERVICEABLE CRITERIAS

TURN OFF POWER SUPPLY AND UNPLUG then please consult authorized dealer under the following conditions:

- Abnormal noise during operation.
- Water/foreign particles have entered the remote control.
- Water leaks from Indoor unit.
- Circuit breaker switches off frequently.
- Power cord becomes unnaturally warm.
- Switches or buttons are not functioning properly.

Information for Users on Collection and Disposal of Old Equipment and used Batteries



[Information on Disposal in other Countries outside the European Union]

These symbols are only valid in the European Union. If you wish to discard these items, please contact your local authorities or dealer and ask for the correct method of disposal.



Note for the battery symbol (bottom two symbol examples):



This symbol might be used in combination with a chemical symbol. In this case it complies with the requirement set by the Directive for the chemical involved.

Pb

Declaration of Conformity
with the requirements of Technical Regulation on the Restriction Of the use of certain Hazardous
Substances in Electrical and Electronic Equipment
(adopted by Order №1057 of Cabinet of Ministers of Ukraine)

The Product is in conformity with the requirements of Technical Regulation on the Restriction Of the use of certain Hazardous Substances in electrical and electronic equipment (TR on RoHS).

The content of hazardous substance with the exemption of the applications listed in the Annex №2 of TR on RoHS:

1. Lead (Pb) – not over 0,1wt % or 1000wt ppm;
2. Cadmium (Cd) – not over 0,01wt % or 100wt ppm;
3. Mercury (Hg) – not over 0,1wt % or 1000wt ppm;
4. Hexavalent chromium (Cr⁶⁺) – not over 0,1wt % or 1000wt ppm;
5. Polybrominated biphenyls (PBBs) – not over 0,1wt % or 1000wt ppm;
6. Polybrominated diphenyl ethers (PBDEs) – not over 0,1wt % or 1000wt ppm.