



## COLOURFUL EXHAUST

- Energy and power efficient exhaust air heat pump with inverter controlled compressor
- Display unit with easy-to-read colour screen
- Specified compressor output 1.5-6.0 kW
- Extract air temperature down to -15 °C
- Low energy fan
- Low energy circulation pump, class A
- Outdoor temperature sensor/indoor temperature sensor
- Measures and logs average indoor temperature during the heating season
- Scheduling heating, ventilation and hot water as well as holiday mode
- Can control up to four heating systems, with different temperature levels
- Phase individual load monitor
- Can communicate with GSM (accessory)
- Integrated volume vessel of 25 l

### **NIBE F750**

NIBE F750 is a complete exhaust air heat pump for both new installations and replacement in houses or similar.

It has an integrated DC fan and water heater that has stainless steel or enamel corrosion protection. There is an integrated immersion heater used as an additional heater when it becomes really cold outside.

Energy is recovered from the ventilation air and supplied to the heat pump, which reduces energy costs considerably. The device ventilates the house, supplies heat and produces domestic hot water. NIBE F750 is intended for low temperature dimensioned radiator circuits and/or under floor heating.

The heat pump works based on the floating condensing principle, and is why the boiler section has a 25 litre temperature buffer vessel. NIBE F750 should not be docked to other heat sources.

## HOW DO EXHAUST AIR HEAT PUMPS WORK?

Ventilation, which means totally hygienic inside air, is a basic requirement for living in a healthy house. Controlled domestic ventilation with heat recovery reuses the energy from the exhaust air.

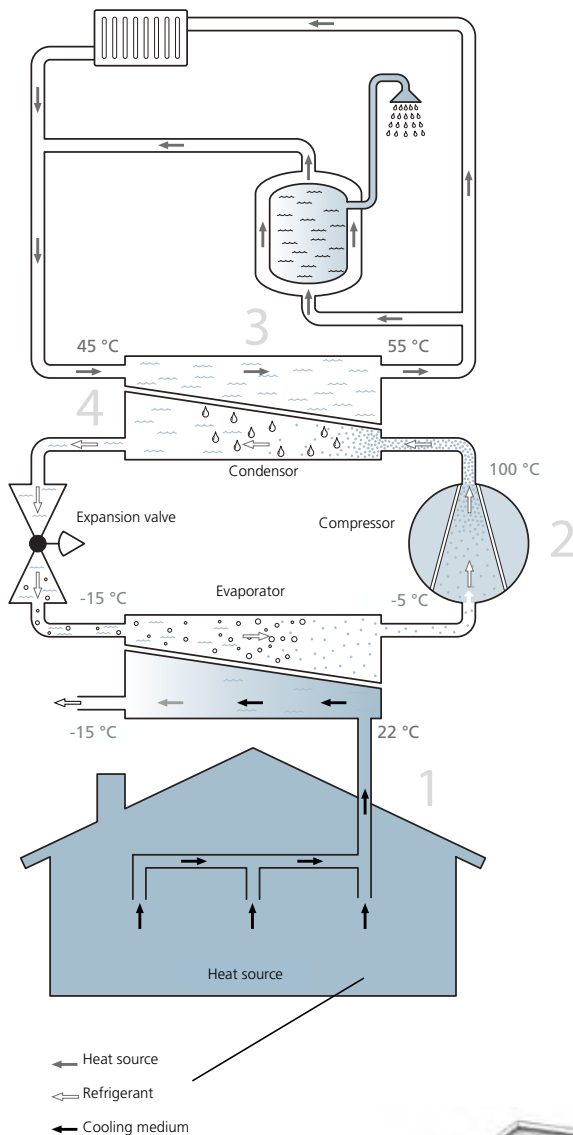

1. Warm exhaust air is blown across the heat exchange and the heat is transferred into the refrigerant circuit. The cold exhaust air passes to the outside of the house.
2. The compressor raises the pressure of the refrigerant, resulting in an increase in temperature in the heat pump.
3. Energy extracted from the exhaust air is transferred into a water-based heating system to heat your home and hot water.
4. In the condenser, the refrigerant reverts to liquid form, ready to turn into gas once more and to collect new heat energy.

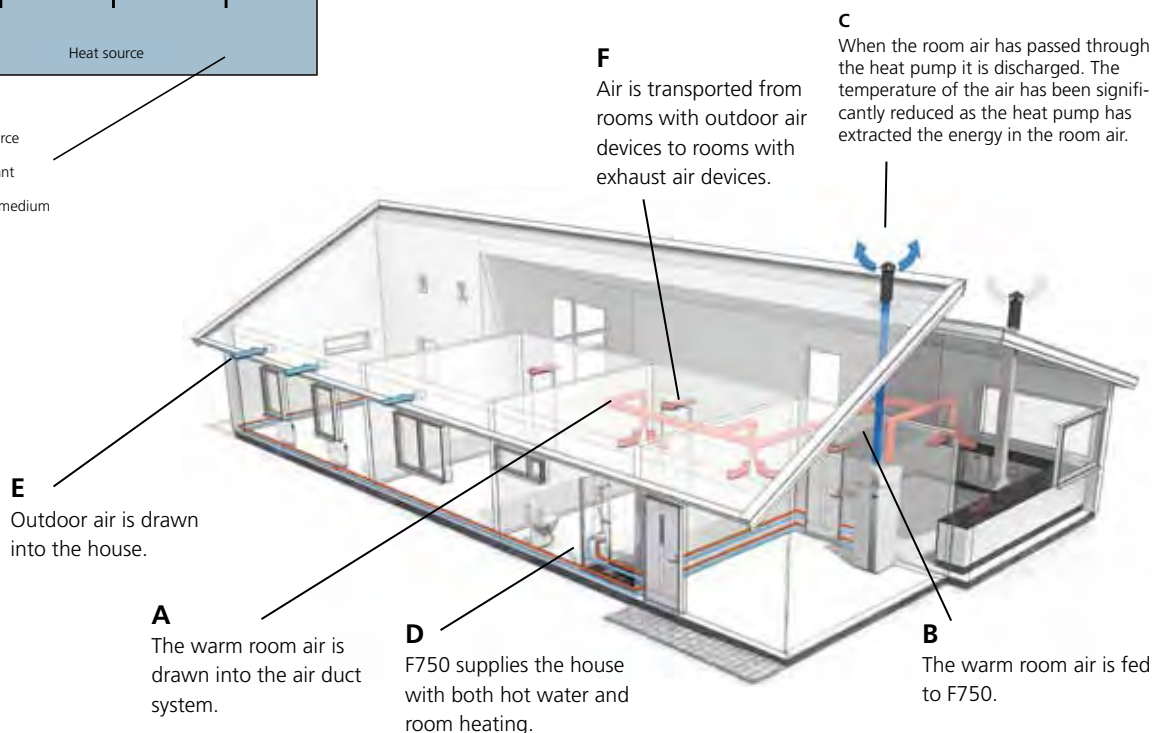

## GOOD TO KNOW ABOUT NIBE™ F750

### Transport and storage

F750 should be transported and stored vertically and stored in a dry place.

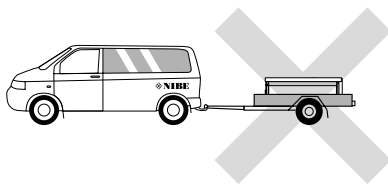

### Design

A microprocessor controls F750. This makes for easy operation at the same time as always enabling the heat pump to run as efficiently as possible, as the microprocessor continuously decides the best method of operation. The microprocessor also manages the heating automatic device and circulation pump. It is possible to control an automatic bypass when there is a need of two different flow temperatures. The numerical display shows the current temperatures and set values in plain text.

The design of the ventilation section gives a high ventilation capacity. The steplessly reconnectable fan steps can easily be increased or reduced via the internal clock, control panel or external signal.

F750 gives great savings thanks to a powerful, variable compressor, which, with intelligent control, works with the most favourable temperature conditions.

The insulation consists of moulded Neopor (environmentally friendly cellular plastic) for minimal heat loss.

The outer casing is of white powder coated steel plate. The front door is easy to remove for easy access when installing and for servicing.

F750 has a maximum immersion heater output of 6.5 kW. The output is easy to adjust via the display and can be blocked if needed.

### Equipment

NIBE F750 is equipped with a complete set of valves, consisting of a drain valve, filling valve, non-return valve, and safety valve for the water heater section. The boiler section is equipped with a drain valve, filler valve and safety valve. In addition, the unit is equipped with climate controlled heating automatic devices with outdoor temperature, indoor temperature and flow sensors, circulation pump, load monitor and expansion vessel.



# GOOD TO KNOW ABOUT NIBE™ F750

## New builds

F750 has been developed to meet energy and output requirements for new buildings.

## Exhaust air

NIBE F750 has a large, powerful compressor that can fulfil the output and energy requirement in accommodations up to and around 200 square metres (depending on the design and geographic location of the house). As the compressor is inverter controlled, operation is very economical and the output two to three times higher than for conventional exhaust air models.

Over and above this, you get all the normal advantages of exhaust air heating systems – no boreholes required and the system is supplied as one complete unit that supplies the accommodation with heat, hot water and ventilation.

## Ground-source heating

If you build a house that is larger than average and/or if you have an outdoor pool and/or heated garage, we recommend a ground-source heat pump, e.g. NIBE F1245.

## Conventional exhaust air heat pump

The proportion of the accommodation's energy demand that can be provided by a traditional exhaust air heat pump is shown below.

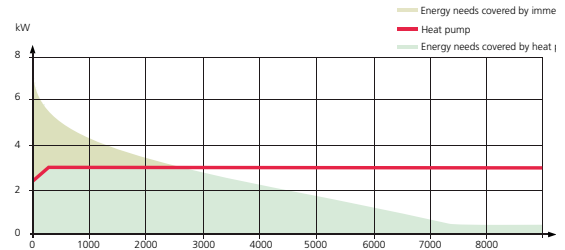

## Exhaust air heat pump NIBE F750

Note how the outgoing output from NIBE F750 follows the curve for the building's energy demand. This is possible thanks to the heat pump's powerful inverter controlled compressor.

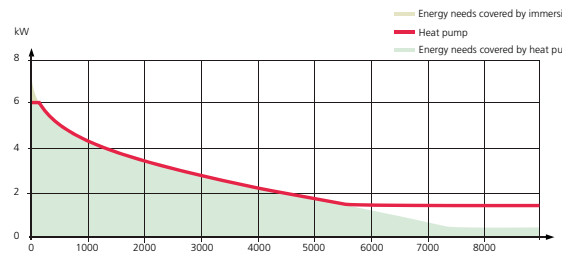

## Ground source heat pump

This diagram shows how much energy a ground-source heat pump can generate. Savings are large, but this type of heat pump would generate too much energy for a small house, which increases the risk of malfunctions and would make the compressor start and stop frequently, which, in turn, shortens the service life of the compressor.

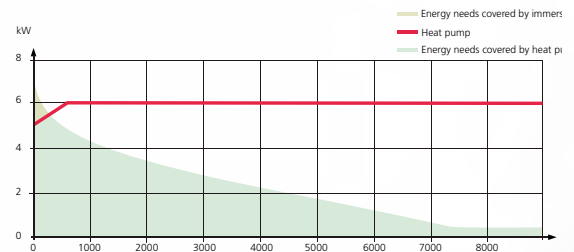

# GOOD TO KNOW ABOUT NIBE™ F750

## Dimensions

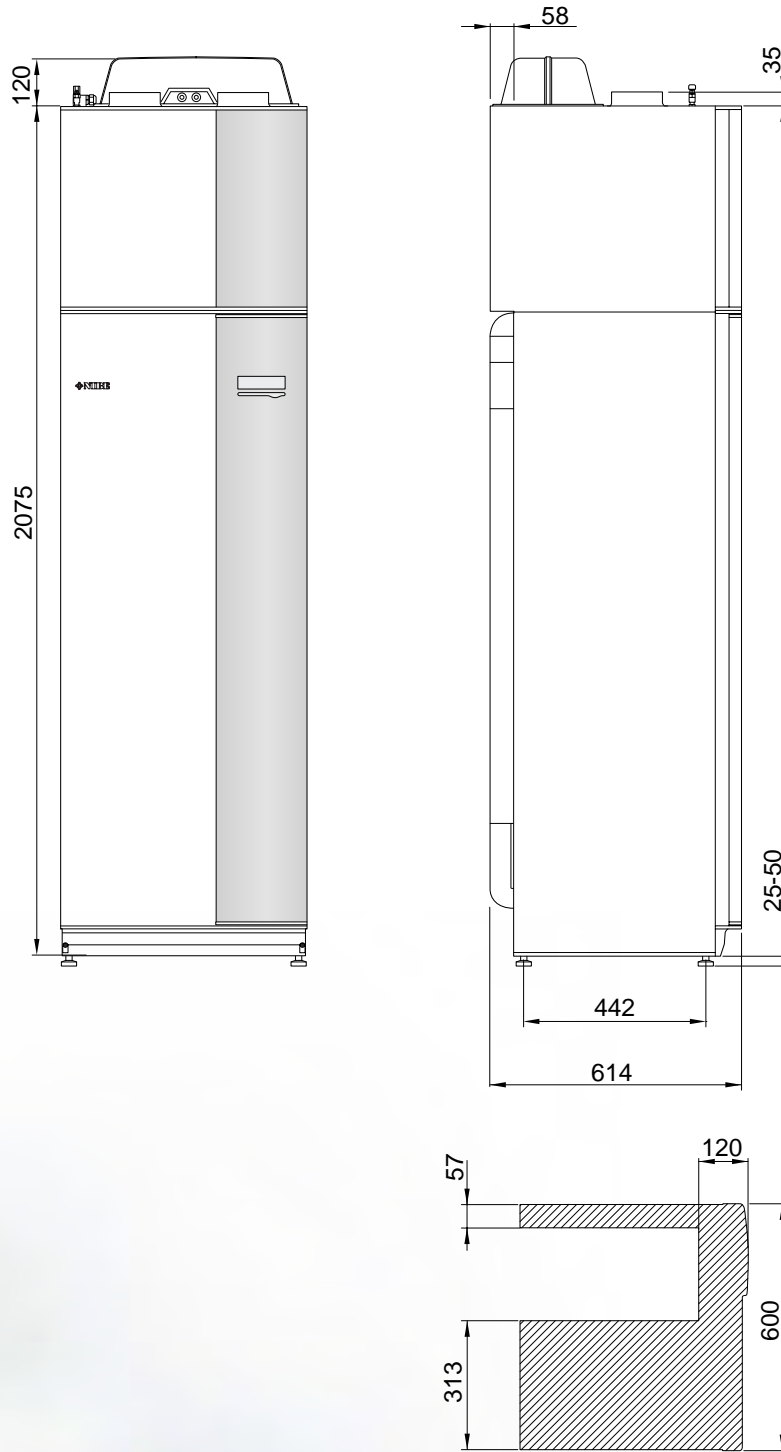

Pipework from below, is not allowed within hatched area.

# GOOD TO KNOW ABOUT NIBE™ F750

## Equipment

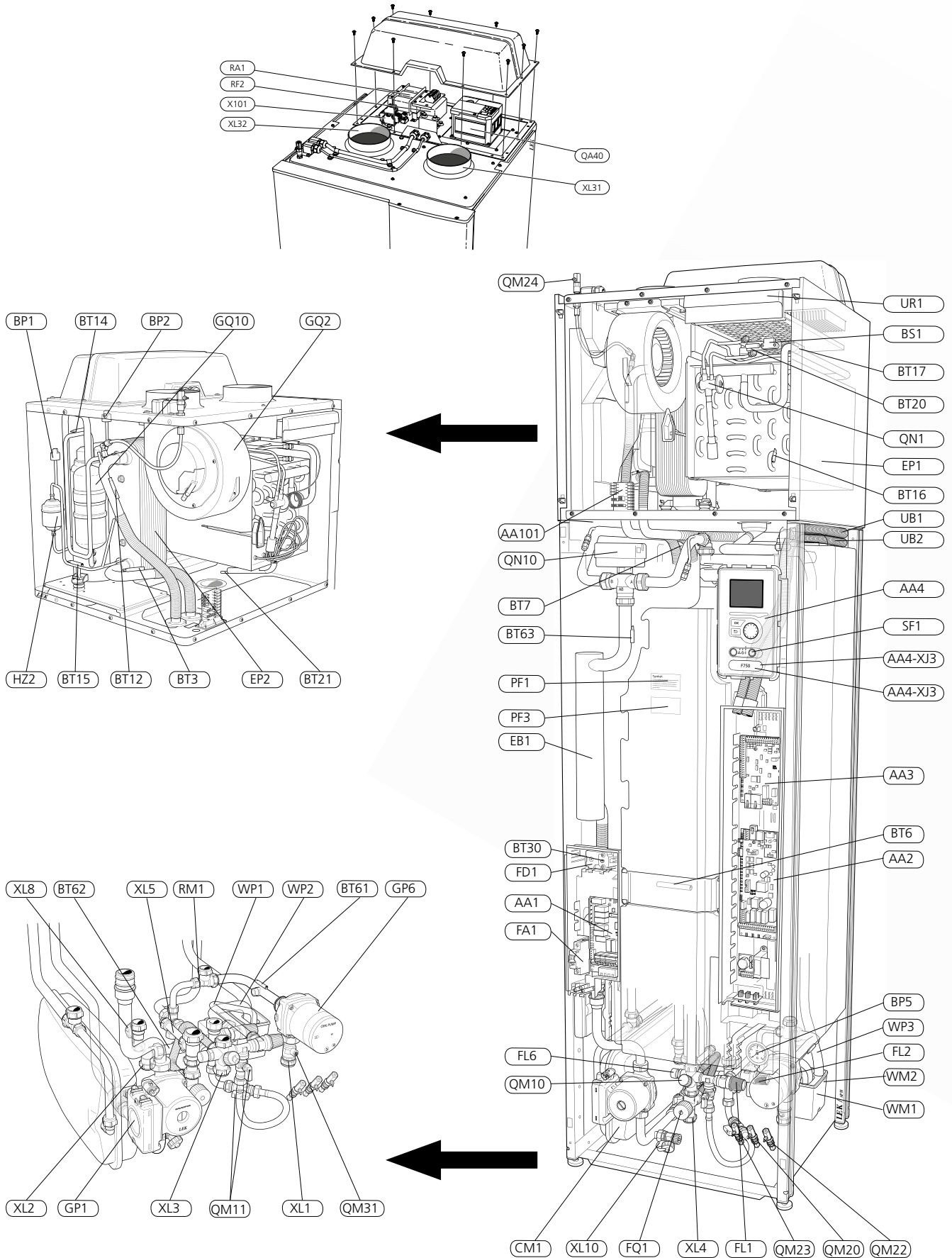



# GOOD TO KNOW ABOUT NIBE™ F750

## List of components

### Pipe connections

XL1	Connection, heating medium flow line
XL2	Connection, heating medium return line
XL3	Connection, cold water
XL4	Connection, hot water
XL5	Connection, hot water circulation
XL8	Connection, docking in
XL10	Connection, draining heating medium
XL31	Ventilation connection, exhaust air
XL32	Ventilation connection, extract air

### HVAC components

CM1	Expansion vessel
FL1	Safety valve, water heater
FL2	Safety valve, climate system
FL 6	Vacuum valve
FQ 1	Mixer valve, hot water
GP1	Heating medium pump
GP6	Heating medium pump 2
QM10	Filling valve, water heater
QM 11	Filler valve, climate system
QM20	Venting, climate system
QM22	Venting, coil
QM23	Venting, buffer tank
QM24	Venting, exchanger
QM31	Shut-off valve, heating medium flow
QN10	Reversing valve, climate system/water heater
RM1	Non-return valve
WM1	Drip tray
WM2	Overflow water discharge
WP 1	Overflow pipe, safety valve hot water heater
WP 2	Overflow pipe, safety valve climate system
WP 3	Condensation lead off, fan box

### Sensors etc.

BP 1	High pressure pressostat
BP 2	Low pressure pressostat
BP5	Pressure gauge, heating system
BS1	Air speed sensor
BT 3	Temperature sensors, heating medium return
BT 6	Temperature sensor, hot water, control
BT 7	Temperature sensor, hot water, display
BT 12	Temperature sensor, heating medium flow after condenser
BT 14	Temperature sensor, hot gas
BT 15	Temperature sensor, fluid pipe

BT 16	Temperature sensor, evaporator
BT 17	Temperature sensor, suction gas
BT 20	Temperature sensor, exhaust air
BT 21	Temperature sensor, extract air
BT 30	Thermostat, backup heating
BT 61	Temperature sensor, heating medium flow after buffer vessel
BT 62	Temperature sensor, heating medium return after buffer vessel
BT 63	Temperature sensor, heating medium supply after immersion heater

### Electrical components

AA1	Immersion heater card
AA2	Base card
AA3	Input circuit board
AA 4	Display unit
	AA4-XJ3 USB socket
	AA4-XJ4 Service socket
AA101	Connection card sensor
EB1	Immersion heater
FA1	Miniature circuit-breaker
FD1	Temperature limiter
QA40	Inverter
RA1	Choke
RF2	EMC-filter
SF1	Switch
X101	Terminal fuse, inverter

### Cooling components

EP1	Evaporator
EP2	Condenser
GQ10	Compressor
HZ2	Drying filter with tank *
QN1	Expansion valve *

### Ventilation

GQ2	Exhaust air fan
UR1	Filter cover

### Miscellaneous

PF1	Type plate
PF3	Serial number plate
UB1	Cable grommet
UB2	Cable grommet

\* Not visible in the image.

Designations in component locations according to standard IEC 81346-1 and 81346-2.

# INSTALLATION

## Installation and positioning

To facilitate pipe installation, a space should be left for the distribution manifold etc on the right or left-hand side. For other installation dimensions, see "Dimensions".

Install the heat pump with its back to an outside wall, in a room where noise does not matter, in order to eliminate noise problems. If this is not possible, avoid using a wall that backs on to a bedroom or some other room where noise would be a problem. Leave space between the heat pump and wall behind (and any routing of supply cables and pipes) to reduce the risk of any vibration reproduction.

Route pipes so they are not fixed to an internal wall that backs on to a bedroom or living room.

The heat pump's installation area should always have a temperature of at least 10 °C and max 30 °C.

## Pipe installation

Pipe installation must be carried out in accordance with current norms and directives.

Four flexible connection pipes with quick-release connectors are supplied with the product for quick and easy installation.

## Radiator connection

When the circulation pump is operating the flow in the heating system must not be stopped completely, i.e. at least one of the heating system's radiators/under floor heating loops must be fully open.

## Tap water connection

The heat pump should be supplemented with an external water heater if a bubble pool or other significant consumer of hot water is installed.

## Water heater without immersion heater

For new builds water heater type NIBE VPB 200 or VPBS 300 (prepared for solar docking) are used. The docking kit accessory is required. Place VPB 200 to the left of F750. VPBS300 requires pipe routing behind the units, which requires 60 mm of free space to the wall.

## Water heater with immersion heater

For existing houses NIBE Compact or Eminent type water heaters can be used.

For more information see

## Installation area

Leave a space of 500 mm in front of the heat pump. Approximately 50 mm free space is required on each side in order to open the side hatches. The hatches do not need to be opened during service, all service on F750 can be carried out from the front.

Leave space between the heat pump and wall behind (and any routing of supply cables and pipes) to reduce the risk reproduction of any vibration.

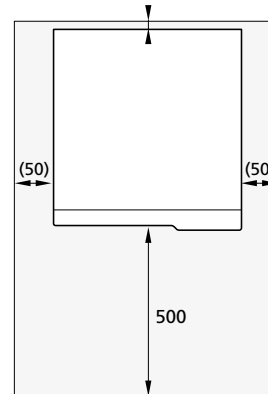

### NOTE!

Ensure that there is sufficient space (300 mm) above the heat pump for installing ventilation hoses.



# INSTALLATION

## Electrical connections

Connection must not be carried out without the permission of the electricity supplier and must be under the supervision of a qualified electrician.

F750 must be connected with corresponding connection cable (length 2 m) via an isolator switch with a minimum breaking gap of 3 mm. The connection cable can be found on the reverse of F750 (see image below).

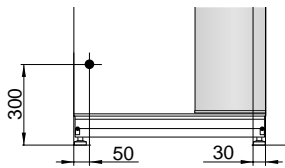

The requisite circuit fuse is based on the table below.

Other electrical equipment is connected at the factory, except the outdoor and indoor temperature sensors. Operation (230V), fan and circulation pumps are internally fused by a miniature circuit breaker (10A).

Electrical addition (kW)	Max (A) L1	Max (A) L2	Max (A) L3
2	2	0	8,7
5	9,5	7,5	8,7
6,5	11,7	11,8	8,7

The table shows max phase current (operating 230 V, electrical addition, fan and circulation pumps) at the different power steps for the heat pump.

In addition to this there is the current for the compressor, which may amount to 4.3 A on all phases, depending on operation.

## Inspection

F750 is equipped with a closed expansion vessel as standard. Current norms require the heating installation to be inspected before it is commissioned. This inspection should only be made by persons with the necessary expertise.

Function checks of the ventilation system must be carried out by authorised persons according to the applicable regulation.

## Maximum boiler and radiator volumes

The volume of the expansion vessel is 10 litres and it is pressurised as standard to 0.5 bar (5 mvp). As a result, the maximum height between the vessel and the highest radiator is 5 metres. There is a valve on the vessel for any pre-pressure adjustment.

The initial pressure of the expansion vessel must be stated in the inspection document.

The maximum system volume at the above pre-pressure, excluding the boiler, is 260 litres.

## Available external pressure, climate system

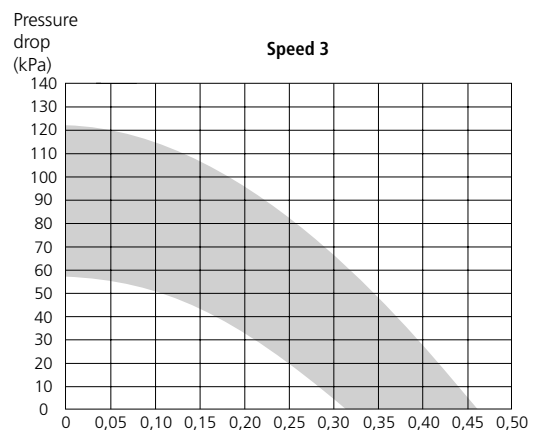
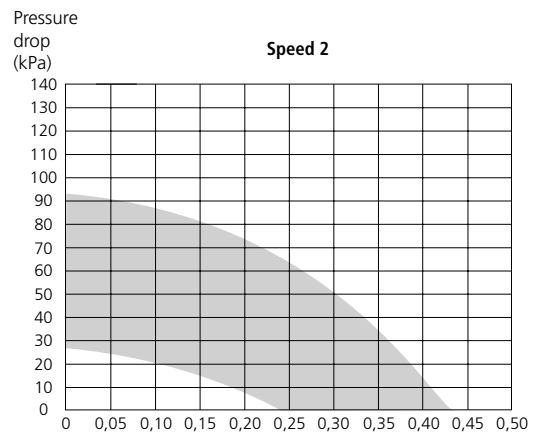
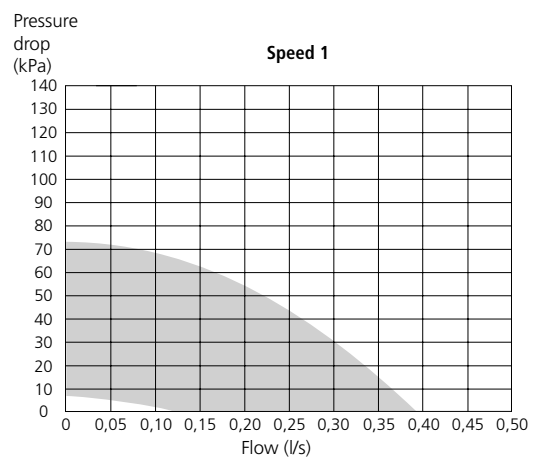

# INSTALLATION

## Outdoor and room temperature sensors

Connect the sensors with two-core cable to terminal block. The minimum cable cross section should be 0.4 mm<sup>2</sup> up to lengths of 50 metres, for example, EKKX or LiYY.

Install the outdoor temperature sensor in the shade on a wall facing north or north-west, so it is unaffected by the morning sun. If a conduit is used it must be sealed to prevent condensation in the sensor capsule.

Install the room temperature sensor in a neutral position where the shown temperature is required.

## Ventilation

F750 is connected so that all ventilation air except the kitchen fan passes the evaporator in the heat pump. For optimum heat pump operation the ventilation flow must not fall below 110 m<sup>3</sup>/h (31 l/s). Even if the norm requirements give lower flow requirements, the increase to 110 m<sup>3</sup>/h does not mean an increase in energy consumption as the heat pump level of recovery also increases.

Connections must be made via flexible hoses, which must be installed so that they are easy to replace. Because the extract air can reach -15 °C, the extract air duct must be insulated with diffusion proof material (PE30) over its entire length. Exhaust air ducts that are laid in cold areas must be insulated. Provision must be made for inspection of the duct. Make sure that there are no reductions of cross-sectional area in the form of creases, tight bends etc, since this will reduce the ventilation capacity. All joints in the ducting must be sealed and pop-riveted to prevent leakage. The duct system must be carried out in accordance with current norms. A minimum of air tightness class B is recommended.

The extract air duct should, if possible, be routed up through the roof. If the duct is to be routed out through the roof, avoid having a 90 degree bend backward, as this can cause noise and poorer capacity.

To prevent fan noise being transferred to the exhaust air valves, it may be a good idea to install a silencer in the duct. This is also recommended for shorter extract air ducts.

To obtain the necessary air exchange in every room of the house, the exhaust air devices must be correctly positioned and adjusted. A defective ventilation installation may lead to reduced heat pump efficiency and thus poorer operating economy, and may result in damage to the house.

The extract air duct must not be routed to the flue.

If a stove or similar is installed, it must have sealing doors and be able to take combustion air from outside.

To achieve a good level of comfort it is also important to use a sufficient number of outdoor air devices with good air distribution.

## Setting the fan capacity

Select the ventilation capacity in the display.

## Fan diagram

The diagram below show the available ventilation capacity. Min exhaust air flow is 31 l/s (110 m<sup>3</sup>/h).

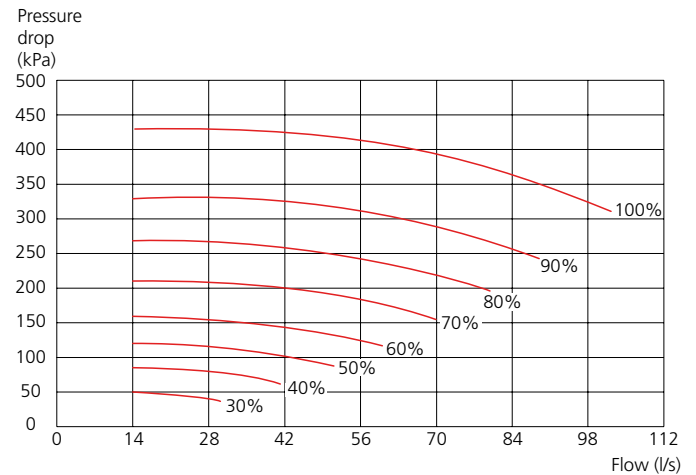

## INSTALLATION

### Control, general

The indoor temperature depends on several factors. Sunlight and heat emissions from people and household machines are normally sufficient to keep the house warm during the warmer parts of the year. When it gets colder outside, the climate system must be started. The colder it is outside, the warmer radiators and floor heating system must be.

Control of the heat production is performed based on the "floating condensing" principle, i.e. the temperature level needed for heating at a specific outdoor temperature is produced guided by collected values from the outdoor and flow sensors. The room sensor can also be used to compensate the deviation in room temperature.

### Heat production

The heat supply to the building is controlled in accordance with the selected control curve (curve slope and offset) in menu 1.9.1. After adjustment, the correct amount of heat for the current outdoor temperature is supplied. The flow line temperature of the heat pump will hunt around the theoretically required value.

### Hot water production

Hot water charging starts when the hot water sensor has fallen to the set start temperature. Hot water charging stops when the hot water temperature on the hot water sensor (BT6) has been reached.

For occasional higher demand for hot water, the "temporary lux" can be used to raise the temperature for 3 – 12 hours (selected in the menu system).

### Additional heat only

F750 can be used with only additional heat (electric boiler) to produce heating and hot water, for example, before the ventilation system is complete.

### Alarm indications

The status lamp lights red in the event of an alarm and the display shows detailed information depending on the fault. An alarm log is created with each alarm containing a number of temperatures, times and the status of outputs.

### Own curve

F750 has pre-programmed non linear heating curves. It is also possible to create an own defined curve. This is an individual linear curve with one break point. You select a break point and the associated temperatures.

### USB service outlet

F750 is equipped with a USB socket in the display unit. This USB socket can be used to connect a USB memory to update the software, save logged information and handle the settings in F750.

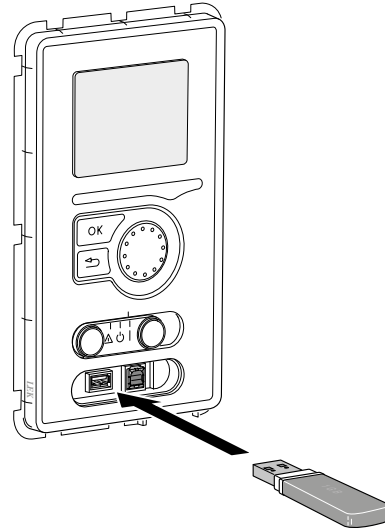

### SMS 40

F750 can be controlled and monitored externally with accessory SMS 40.

SMS 40 consists of a communications module, a GSM modem with an antenna and a separate power supply unit with jack for plugging into a wall socket. The antenna can be placed outside the enclosure.

SMS 40 enables operation to be controlled and monitored, via a GSM module, using a mobile phone via SMS messages. For the GSM function to work, the communications module must be equipped with a valid GSM subscription. This may for example be a cash card or a special telematics subscription. For further presentation.

## THE DISPLAY

A large, easy to read multicolour display gives everyone the chance to maximize the energy saving potential of this exciting green technology!

### Display unit

#### Display, A

Instructions, settings and operational information are shown on the display. The easy-to-read display and menu system, facilitates navigation between the different menus and options to set the comfort or obtain the information you require.

#### Status lamp, B

The status lamp indicates the status of the heat pump. It:

- lights green during normal operation.
- lights yellow in emergency mode.
- lights red in the event of a deployed alarm.

#### OK button, C

The OK button is used to:

- confirm selections of sub menus/options/set values/page in the start guide.

#### Back button, D

The back button is used to:

- go back to the previous menu.
- change a setting that has not been confirmed.

#### Control knob, E

The control knob can be turned to the right or left. You can:

- scroll in menus and between options.
- increase and decrease the values.
- change page in multiple page instructions (for example help text and service info).

#### Switch, F

The switch assumes three positions:

- On (I)
- Standby (⏻)
- Emergency mode (⚠)

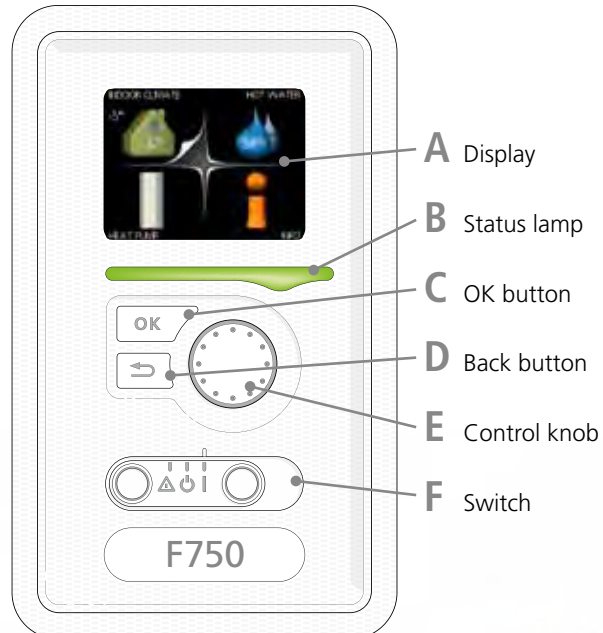

## THE DISPLAY

### Menu system

When the door to the heat pump is opened, the menu system's four main menus are shown in the display as well as certain basic information.

#### Menu 1 – Indoor climate

Setting and scheduling the indoor climate.

#### Menu 2 – Hot water

Setting and scheduling hot water production.

This menu only appears if a water heater is docked to the heat pump.

#### Menu 3 - Info

Display of temperature and other operating information and access to the alarm log.

#### Menu 4 – Heat pump

Setting time, date, language, display, operating mode etc.

#### Menu 5 - Service

Advanced settings. These settings are not available to the user. The menu is visible by pressing the Back button for 7 seconds.

### Start guide

The first time the heat pump is started a start guide is started. The start guide instructions state what needs to be carried out at the first start together with a run through of the heat pump's basic settings.

The start guide ensures that the start-up is carried out correctly and cannot be bypassed. The start guide can be started later in menu 5.7.

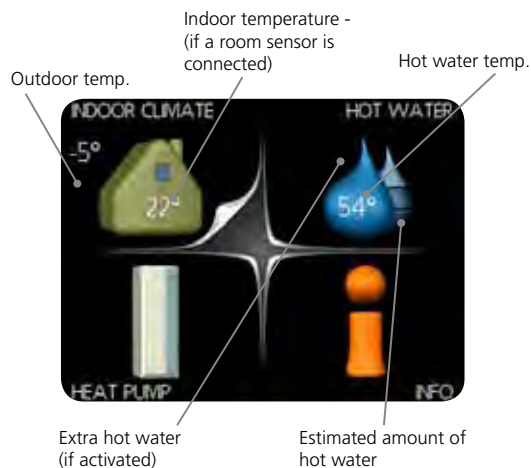

# TECHNICAL SPECIFICATIONS



		Enamel	Stainless steel
<b>Output data according to EN 14 511</b>			
Specified heating output ( $P_H$ ) <sup>1</sup>	kW	1.144	
COP <sup>1</sup>		4.2	
Specified heating output ( $P_H$ ) <sup>2</sup>	kW	1.498	
COP <sup>2</sup>		4.72	
Specified heating output ( $P_H$ ) <sup>3</sup>	kW	4.994	
COP <sup>3</sup>		2.43	
<b>Additional power</b>			
Output immersion heater	kW	0.5-6.5	
<b>Electrical data</b>			
<b>Rated voltage</b>	V	400 V 3N-PE 50Hz	
Drive output heating medium pump 2	W	5-45	
Driving power exhaust air fan	W	25-140	
Enclosure class		IP 21	
<b>Refrigerant circuit</b>			
Type of refrigerant		R407C	
Volume	kg	0.74	
<b>Heating medium circuit</b>			
Max pressure in boiler section	MPa/bar	0.25/2.5	
<b>Ventilation</b>			
Min airflow	l/s	31	
<b>Sound pressure level according to EN 12 102</b>			
Sound pressure level in boiler room ( $L_{RAV}$ ) <sup>4</sup>	dB(A)	36-51	
<b>Water heater and boiler section</b>			
Volume boiler section (of which buffer vessel)	litre	35 (25)	
Volume, hot water heater	litre	180	
Max pressure in hot water heater	MPa/bar	1.0/10	
<b>Capacity water heating according to EN 255-3<sup>5</sup></b>			
Capacity hot water 40 °C at Normal comfort ( $V_{max}$ )	litre	244	
<b>Dimensions and weight</b>			
Width	mm	600	
Depth	mm	610	
Height excl. inverter box, incl. feet	mm	2100-2125	
Required ceiling height	mm	2270	
Weight	kg	235	
Part no.		066 063	066 061

<sup>1</sup>A20(12)W35, exhaust air flow 108 m<sup>3</sup>/h (30 l/s) min compressor frequency

<sup>2</sup>A20(12)W35, exhaust air flow 252 m<sup>3</sup>/h (70 l/s) min compressor frequency

<sup>3</sup>A20(12)W45, exhaust air flow 252 m<sup>3</sup>/h (70 l/s) max compressor frequency

<sup>4</sup>The value varies with the selected fan curve and the room's damping capacity T

A20(12) exhaust air flow 150 m<sup>3</sup>/h (42 l/s)



## SUPPLIED COMPONENTS

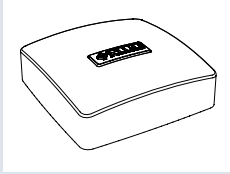

Outdoor sensor

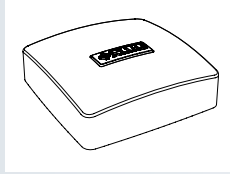

Indoor sensor

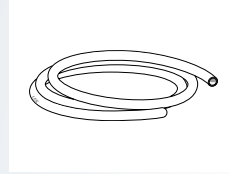

Vent hose (length 1 m)

The kit of supplied items is placed on top of the product.

## ACCESSORIES

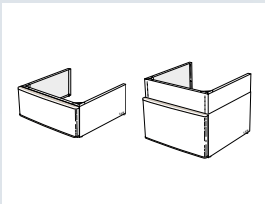

### NIBE Top cabinet

Top cabinet for room height  
2400, 2500, 2550-2800 mm.

Height:	2400 mm
Part no.	089 756
Height:	2500 mm
Part no.	089 757
Height:	2550-2800 mm
Part no.	089 758

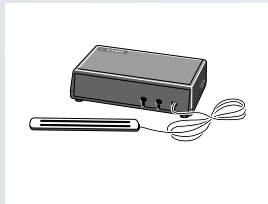

### NIBE SMS 40 Communication module

NIBE SMS 40 enables operation to be controlled and monitored, via the GSM module, using a mobile phone via SMS messages.

Part no. 067 073

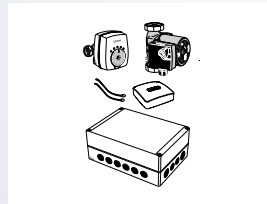

### NIBE ECS 40/ ECS 41 Extra shunt group

This accessory is used when NIBE F750 is installed in houses with two or more different climate systems that require different supply temperatures, for example, in cases where the house has both a radiator system and an underfloor heating system.

ECS 40 Part no. 067 061  
ECS 41 Part no. 067 099

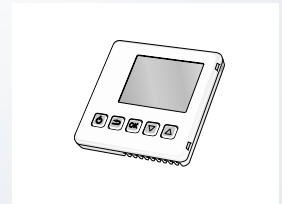

### NIBE RMU 40 Room unit

NIBE RMU 40 means that control and monitoring of the operation can be carried out in a different part of the accommodation to where NIBE F750 is located.

Part no. 067 064

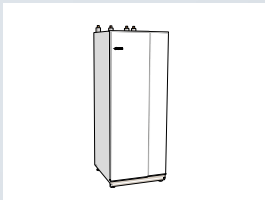

### NIBE VPB/VPBS Accumulator tank

Extra water heater without immersion heater. Placed to the left of NIBE F750 for easy installation. VPBS 300 is solar ready.

VPB 200 CU	Part no. 088 515
VPB 200 E	Part no. 088 517
VPB 200 R	Part no. 088 518
VPBS 300 CU	Part no. 083 012
VPBS 300 E	Part no. 083 015

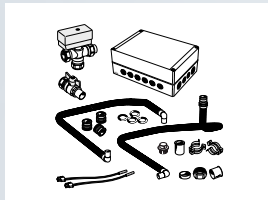

### NIBE DEW 40 Docking kit water heater

For extra water heater NIBE VPB 200.

Part no. 067 102

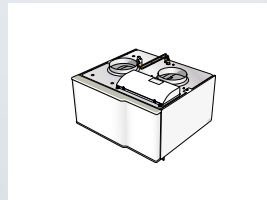

### NIBE SAM 40 Supply air module

NIBE SAM 40 is a supply air module specially developed for houses with supply and exhaust air systems.

Part no. 067 147



### NIBE SCA 40 Solar accessory

For connection to NIBE VPBS 300.

Part no. 067 137



### NIBE DKI 10 Division kit

Division kit used if you want to split the F750 and place the heatpump module beside the tank module.

Part no. 089 777



NIBE is ISO-certified:  
SS-EN ISO 9001:2000  
SS-EN ISO 14001:2004

This brochure is a publication from NIBE. All product illustrations, facts and specifications are based on current information at the time of the publication's approval. NIBE makes reservations for any factual or printing errors in this brochure.



NIBE Energy Systems AB  
Box 14  
285 21 Markaryd  
SWEDEN