

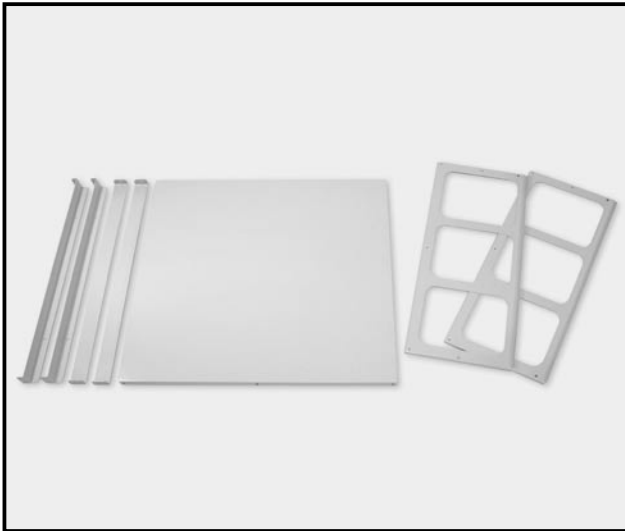

Photo



Descriptions

Enables operation even when the outside temperature is low. Protect the unit from cold wind.

Applicable Models

- PUAZ-RP35/50
only 1 piece required

Specifications

Exterior	Color (Munsell)	Ivory (3.0Y 7.8/1.1)
	Surface treatment	Acrylic resin coating
	Material	Alloy hot-dip zinc-coated carbon steel sheet
Weight		3.4kg
Accessory name x Qty. <Material/Surface treatment>		Washer faced screw (M4x10) x 18 <SUS410/Passivated>

Dimensions

Unit : mm

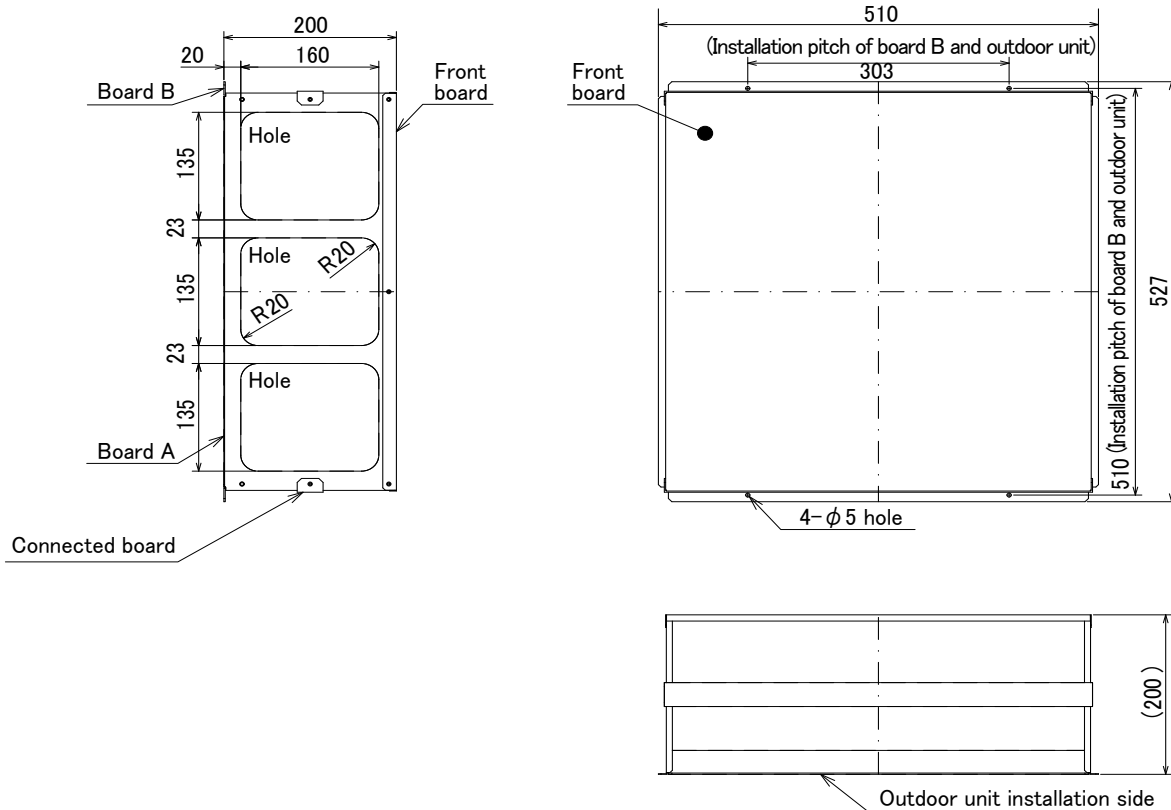

CAUTION

* Air Guide prevents reverse rotation of outdoor unit fan when it enters low speed rotation mode with fan controller being operated. It is also used for protection of fan when strong winds, such as a typhoon, wind blowing through tall buildings, etc., directly strike the air outlet. In addition, installation of this product is necessary when cooling operation is to be performed in outdoor temperature of -5°C or lower (down to -15°C).

Note the followings when installing this guide:



- 1) Be sure not to use "upward discharge" in a place where snowing is possible. Snow may accumulate in the guard, which could damage the fan, etc.
- 2) Attaching this unit will decrease the performance (by 2-3%) and increase noise from outdoor unit (by approx. 1-2 dB).
- 3) Do not use "upward discharge" when there are any obstacles at the back and on both sides of outdoor unit (air is taken in from top of unit): This could cause a short cycle.
- 4) To eliminate the influence of external wind, be sure to install the unit with its back facing to wall.
- 5) Do not install this unit in a place where wind directly blows to the back of the unit.

How to Use / How to Install

For 2-fan type outdoor unit, two pieces are required.

1 Checking parts

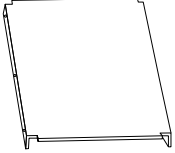
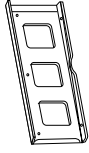
Make sure that all the following parts, in addition to this manual, are in this box:

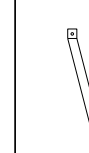
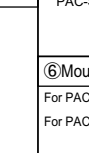
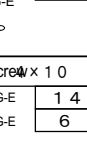
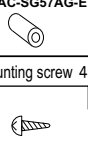
① Front plate	1	② Side plate	2	③ Side plate	2	④ Connecting plate	2	⑤ Mounting screw 5 × 3.5	4	⑦ Spacer	4	⑨ Washer (for screw ⑤)	4
				※Only for PAC-SG56AG-E 				※Only for PAC-SG57AG-E 		※Only for PAC-SG57AG-E 		※Only for PAC-SG57AG-E 	
								⑥ Mounting screw 4 × 1.0	4	⑧ Mounting screw 4 × 1.2	4	⑩ Washer (for screw ⑧)	4
								For PAC-SG56AG-E	1				
								For PAC-SG57AG-E	6				

2 Requirements of space for installation

(1) One unit installation:

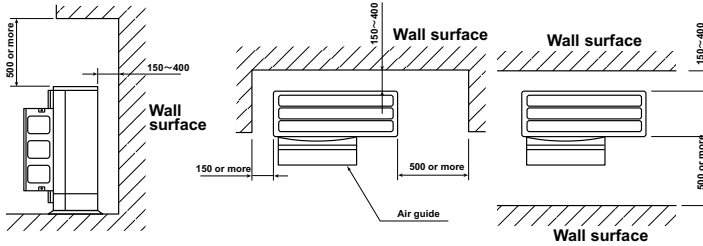

(2) Multiple unit installation: ※Installation of multiple units in series must be no more than five units.

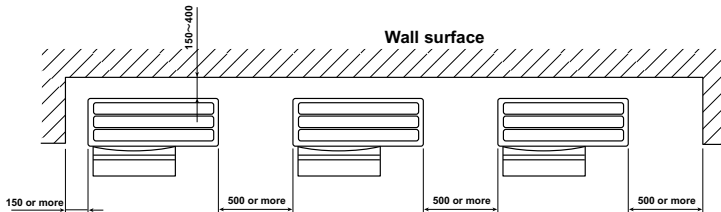

3 Installation procedure

For RP1.6, 2, 35, 50

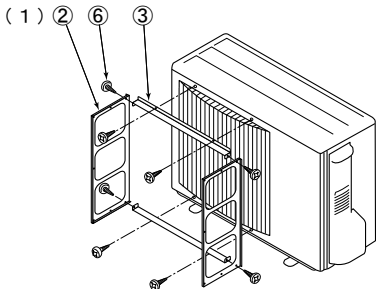

● Fix side plates ② and ③ (two each) using four screws ⑥ and attach them to outdoor unit using holes on side plate ③.

For other models:

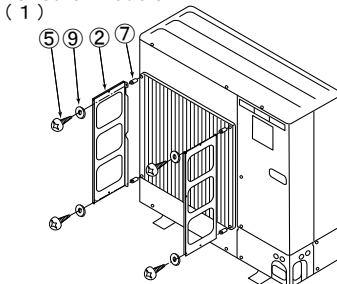

● For RP2.5~6, 60~140, remove the four screws securing fan guard from its circumference.

● Attach two side plates ② to outdoor unit using four screws ⑤.

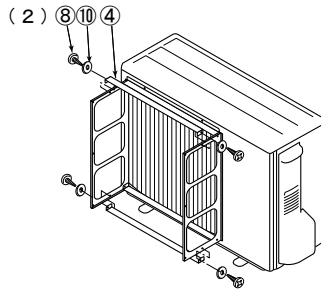

● Attach two connecting plates ④ to side plate ②, using four screws ⑧ with four washers ⑩.

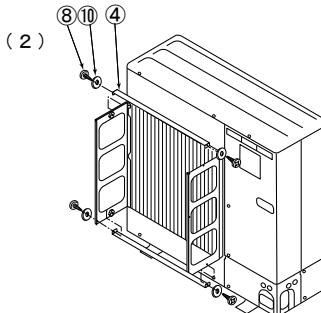

● Attach two connecting plates ④ to side plate ②, using four screws ⑧ with four washers ⑩.

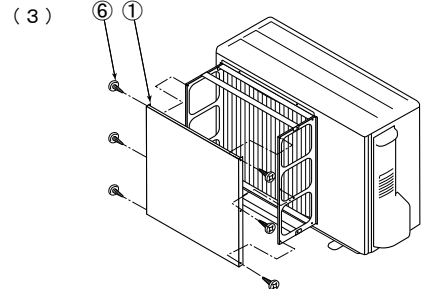

● Attach front plate ① to side plate ②, using six screws ⑥.

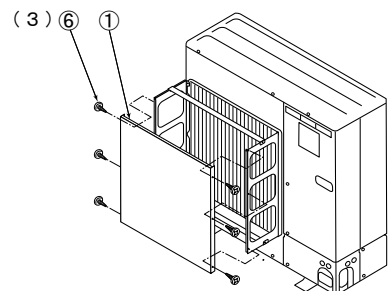

● Attach front plate ① to side plate ②, using six screws ⑥.