



Photo



Descriptions

A decoration cover to be attached to the upper section of ceiling suspended models. Possible to prevent dust accumulation.

Applicable Models

- PCA-RP71HAQ

Specifications

Material	SUS304 (0.8t)
Parts composition	Front cover x 1
	Suspension bracket cover x 4
	Tapping screw (4 x 10, with nylon washer) x 4
	Washer x 8 (hot-dip zinc-coated carbon steel sheet (t1. 2))

Dimensions

Unit : mm

Front cover

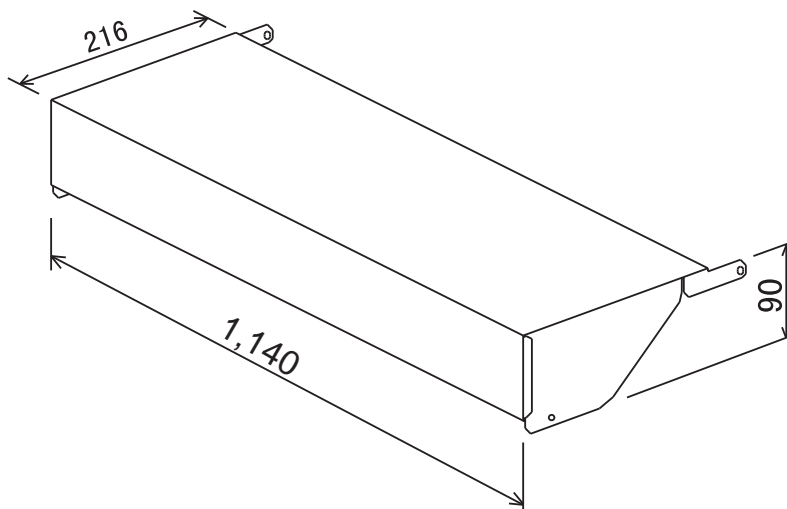

Suspension bracket cover

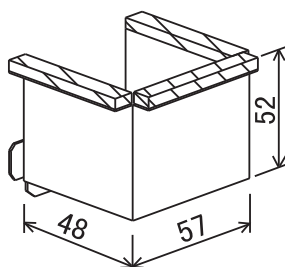



OPTIONAL PARTS

How to Use / How to Install

1. Checking Provided Parts

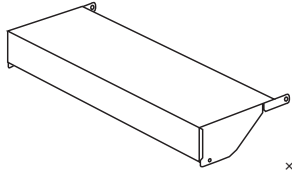
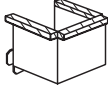
※Make sure that you have all the following parts before installation:

① Front cover	② Suspending bracket covers	③ Tapping screw (4x10)	④ Washers
 x 1	 x 4	 (with nylon washers) x 4	 x 8

2. Front Cover Installation Procedure

★ The following procedure shows how to attach the front cover after installing air-conditioner.

- Loosen the nuts of bolts suspending the unit, and lower the unit by approx. 5 mm.
 - When lowering the unit, be careful not to damage the wires, coolant pipe or drain pipe.
- Remove the screws that secure the front panel and top panel to the unit (at 4 points).
(The provided tapping screws ③ are spares for these screws.)
- Put front cover ① over the unit.
 - Be careful not to damage the insulation sheets pasted on the top surface of unit and the inside of front cover ①.
- Use the screws removed in step 2 to temporarily secure front cover ①.
(Do not tighten the screws at this time.)
- Tighten the nuts of bolts suspending the unit, and fit the unit onto ceiling.
 - Tighten the nuts while carefully watching the attached status of front cover ①.
- Tighten the screws that were temporarily secured in step 4.
 - Make sure that front cover holds the insulation sheet on the top surface of unit, and that the cover fits securely on the top surface of unit before tightening the screws. ①
- Separate the unit from ceiling to leave a gap of 2-3 mm from ceiling.
 - Be sure to provide this space: If the unit is in contact with ceiling, the vibrations could be transmitted to ceiling.
- Make sure that the unit is correctly installed, and then tighten the nuts of bolts suspending the unit.

[CAUTION] Do not tighten the lower double nuts yet, because installing suspending bracket covers must now be done.

※ If you attach the front cover before installing the unit, perform the procedure in steps 2 and 3, and then fully tighten the 2 screws on each side (4 in total).

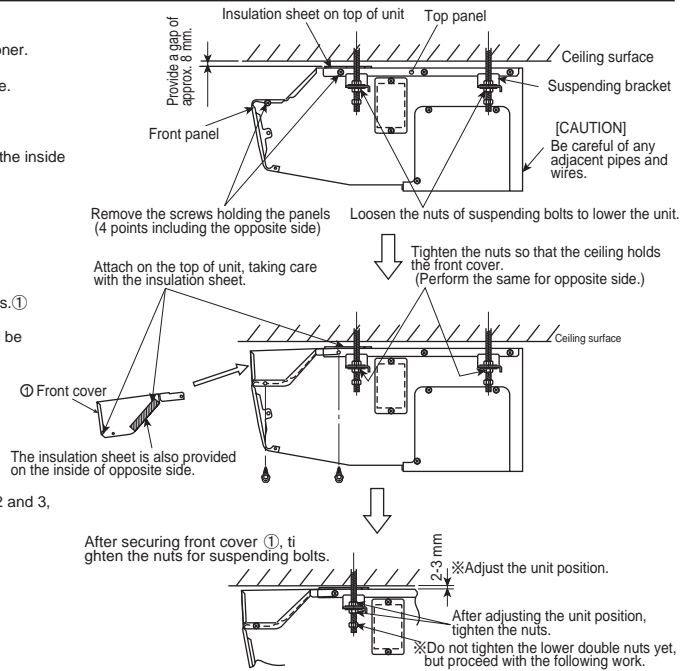

3. Suspending Bracket Installation Procedure

★ Attach the suspending bracket covers in succession.

- Remove the lower double nuts (from 4 points) from the suspending bolts.
- Put the provided washers (tops and bottoms of suspending bracket covers) and suspending bracket covers through suspending bolts. ④
- Tighten the nuts removed in step 1 for the suspending bolts.
 - Make sure that the suspending bracket covers are in close contact with the unit and ceiling.

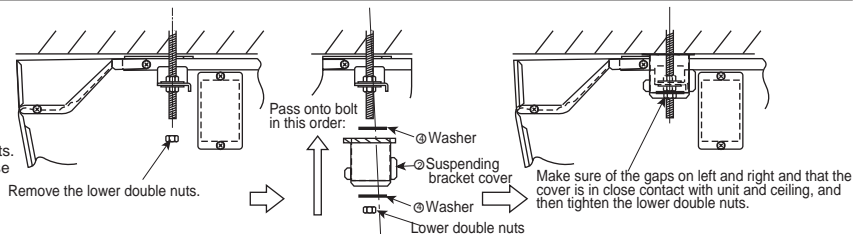

4. Test Run

※ Also refer to the installation manual of indoor unit.

★ Make sure that test run is performed without any abnormal sound, such as vibrations, fluttering sound, etc.

[Test Run Procedure]

- Turn power on.
- Press the TEST RUN button on remote controller twice.
- Press the MODE button on remote controller to set to the fan mode.
 - The fan will rotate to blow out air.
- Make sure that no abnormal sound, such as vibrations, fluttering sound, etc. is heard.
- Press the ON/OFF button on remote controller to release test run.
- Turn power off.