

Photo



Descriptions

- Both floor and inlet temperatures are measured to provide a comfort sensation fully in a room covering from the ceiling to the floor surfaces
- Install the I-SEE sensor corner panel to the corner of the decorative panel (the opposite side of refrigerant piping).

Applicable Models

- PLA-RP-BA/BA2/BA3

Specification

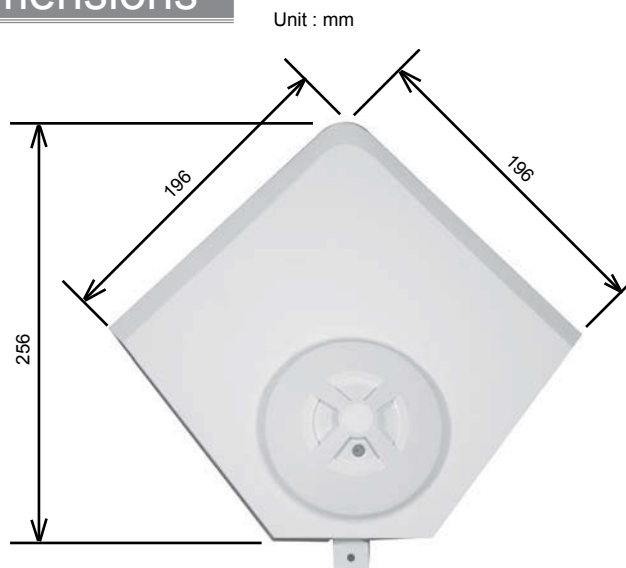

Adapter wiring	Connect the 9-core cord with connector to the indoor controller board of the indoor unit.
Exterior	ABS resin (Munsell No.6.4Y8.9/0.4)
I-SEE sensor operation	When there is a great difference between the room temperature and the set temperature, temperatures of four areas are measured once in two minutes. When the room temperature is stable, the i-see sensor rotates.

Dimensions



How to Use / How to Install

1. Included parts (This manual and following parts are included.)

Part Number/Name	① i-see sensor corner panel	② Plastic fastener
Quantity	1	2
Shapes/Sizes		

2. Preparation before installing the decorative panel

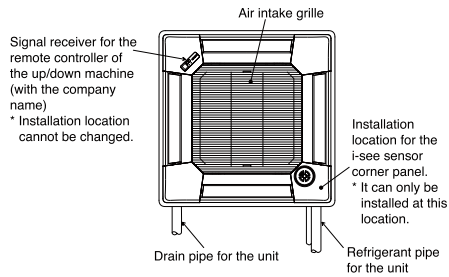

Warning Turn off the main power.
 • If the main power is not turned off, injury or electric shock may result.

Removing the corner panel

- It can only be installed at this location with corner panel.
- * If the corner panel with sensor is removed, a problem may occur when installing the decorative panel.
- Remove the screw on the corner, slide the panel in the direction of the arrow (1) in the figure and remove the corner panel.

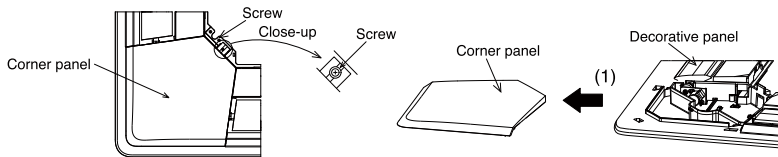

3. Installation of corner panels and air intake grille

- * You can set the direction of the air intake grille such as grids when installing multiple units as desired. If forced to be set at other than the position shown in the figure, failure may result.

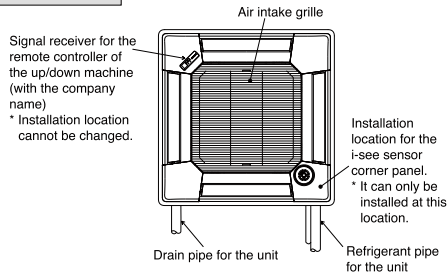

Installation of i-see sensor corner panel

- Optional part: PAC-SA1ME-E
- Take CN4Y (white) and CN6Y (red), lead wires of the i-see sensor corner panel ① from the side of the electric box on the unit and make sure to connect them to the connector of the control board.
 - Lead wires of the i-see sensor corner panel ① should be fixed at the rib of the decorative panel with the plastic fastener ② so that there is no slack.
 - Lead wires should be held together with the lead wires of the unit and fixed with two of the plastic fastener ② so that there is no slack.
 - Put the cover back on the electric box with three screws.
 - * Make sure wires are not caught in the cover of electric box. If they get caught, they will be cut off.
 - Adverse procedure of "Preparation before installing the decorative panel" in the Section 2 will be taken for installing the i-see sensor corner panels.
 - * The i-see sensor corner panel should be fixed onto the decorative panel with screw.

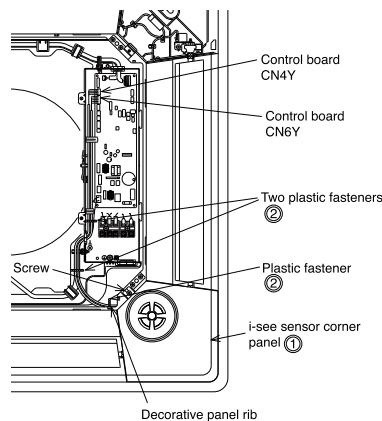

4. Verification

- For optional part PAC-SA1ME-E, check the rotating movement of the i-see sensor. If the i-see sensor does not rotate, review the procedure in "installation of i-see sensor corner panel" in section 3.

After verifying all the items above, hand all the documents including this manual and the manuals for the unit and separately sold parts to the user. Be sure to explain the descriptions of cleaning the filters and how to use the air intake grille up/down function (remote controller operation) in the operation manual of the decorative panel to the user.