

SERVICE MANUAL
R32
**No. OCH737
REVISED EDITION-A**
**Outdoor unit
[Model Name]**
[Service Ref.]

PUZ-M200YKA

PUZ-M200YKA.UK

PUZ-M250YKA

PUZ-M250YKA.UK

Revision:

- Connectable indoor units have been added in REVISED EDITION-A.

OCH737 is void.

Note:

- This manual describes service data of the outdoor units only.

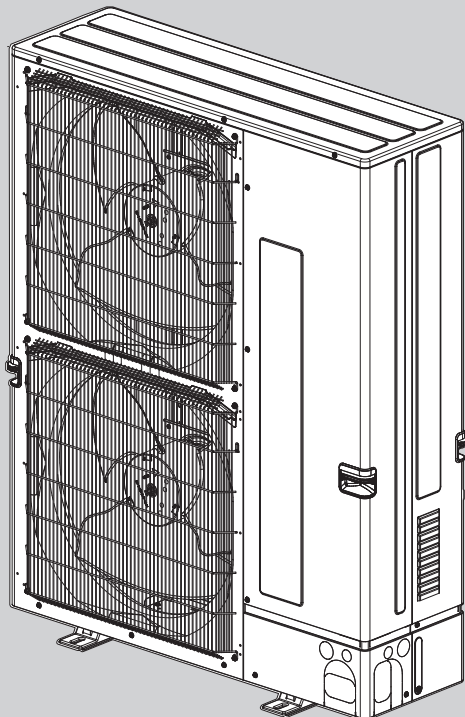
CONTENTS

1. REFERENCE MANUAL.....	2
2. SAFETY PRECAUTION.....	2
3. FEATURES	12
4. SPECIFICATIONS	13
5. DATA	14
6. OUTLINES AND DIMENSIONS.....	17
7. WIRING DIAGRAM.....	18
8. WIRING SPECIFICATIONS	19
9. REFRIGERANT SYSTEM DIAGRAM.....	24
10. TROUBLESHOOTING	26
11. FUNCTION SETTING	80
12. MONITORING THE OPERATION DATA BY THE REMOTE CONTROLLER ...	91
13. EASY MAINTENANCE FUNCTION.....	100
14. DISASSEMBLY PROCEDURE	103

PARTS CATALOG (OCB737)

1

REFERENCE MANUAL





INDOOR UNIT SERVICE MANUAL

Model Name	Service Ref.	Service Manual No.
PLA-M50/60/71/100/125EA	PLA-M50/60/71/100/125EA.UK	OCH697 OCB697
PCA-M71HA(-ET)	PCA-M71HA(-ET)	OCH725 OCB725
PCA-M50/60/71/100/125KA	PCA-M50/60/71/100/125KA	OCH659 OCB659
PKA-M50HA(L)	PKA-M50HA(L)	OCH660 OCB660
PKA-M60/71/100KA(L)	PKA-M60/71/100KA(L).TH	OCH661 OCB661
PEAD-M50/60/71/100/125JA(L)	PEAD-M50/60/71/100/125JA(L).UK	HWE16130 BWE017010
	PEAD-M50/60/71/100/125JA(L).TH	

2

SAFETY PRECAUTION

MEANINGS OF SYMBOLS DISPLAYED ON THE UNIT

	WARNING (Risk of fire)	This mark is for R32 refrigerant only. Refrigerant type is written on nameplate of outdoor unit. In the case that refrigerant type is R32, this unit uses a flammable refrigerant. If refrigerant leaks and comes in contact with fire or heating part, it will create harmful gas and there is risk of fire.
		Read the OPERATION MANUAL carefully before operation.
		Service personnel are required to carefully read the OPERATION MANUAL and INSTALLATION MANUAL before operation.
		Further information is available in the OPERATION MANUAL, INSTALLATION MANUAL, and the like.

2-1. ALWAYS OBSERVE FOR SAFETY

Before obtaining access to terminal, all supply circuits must be disconnected.

2-2. CAUTIONS RELATED TO NEW REFRIGERANT

Cautions for units utilizing refrigerant R32

Preparation before the repair service.

- Prepare the proper tools.
- Prepare the proper protectors.
- Provide adequate ventilation.
- After stopping the operation of the air conditioner, turn off the power-supply breaker.
- Discharge the condenser before the work involving the electric parts.

Precautions during the repair service.

- Do not perform the work involving the electric parts with wet hands.
- Do not pour water into the electric parts.
- Do not touch the refrigerant.
- Do not touch the hot or cold areas in the refrigerating cycle.
- When the repair or the inspection of the circuit needs to be done without turning off the power, exercise great caution not to touch the live parts.

Use new refrigerant pipes.

In the case of using the existing pipes for R22, be careful with the following:

- Be sure to clean the pipes and make sure that the insides of the pipes are clean.
- Change flare nut to the one provided with this product. Use a newly flared pipe.
- Avoid using thin pipes.

Make sure that the inside and outside of refrigerant piping is clean and it has no contaminants such as sulfur, oxides, dirt, shaving particles, etc, which are hazard to refrigerant cycle. In addition, use pipes with specified thickness.

Contamination inside refrigerant piping can cause deterioration of refrigerant oil, etc.

Store the piping indoors, and keep both ends of the piping sealed until just before brazing. (Leave elbow joints, etc. in their packaging.)

If dirt, dust or moisture enters into refrigerant cycle, that can cause deterioration of refrigerant oil or malfunction of compressor.

The refrigerant oil applied to flare and flange connections must be ester oil, ether oil or alkylbenzene oil in a small amount.

If large amount of mineral oil enters, that can cause deterioration of refrigerant oil, etc.

Charge refrigerant from liquid phase of gas cylinder.

If the refrigerant is charged from gas phase, composition change may occur in refrigerant and the efficiency will be lowered.

Do not use refrigerant other than R32.

If other refrigerant (R22, etc.) is used, chlorine in refrigerant can cause deterioration of refrigerant oil, etc.

Use a vacuum pump with a reverse flow check valve.

Vacuum pump oil may flow back into refrigerant cycle and that can cause deterioration of refrigerant oil, etc.

Use the following tools specifically designed for use with R32 refrigerant.

The following tools are necessary to use R32 refrigerant.

Tools for R32	
Gauge manifold	Flare tool
Charge hose	Size adjustment gauge
Gas leak detector	Vacuum pump adaptor
Torque wrench	Electronic refrigerant charging scale

Handle tools with care.

If dirt, dust or moisture enters into refrigerant cycle, that can cause deterioration of refrigerant oil or malfunction of compressor.

Do not use a charging cylinder.

If a charging cylinder is used, the composition of refrigerant will change and the efficiency will be lowered.

Use the specified refrigerant only.

Never use any refrigerant other than that specified. Doing so may cause a burst, an explosion, or fire when the unit is being used, serviced, or disposed of. Correct refrigerant is specified in the manuals and on the spec labels provided with our products. We will not be held responsible for mechanical failure, system malfunction, unit breakdown or accidents caused by failure to follow the instructions.

Ventilate the room if refrigerant leaks during operation. If refrigerant comes into contact with a flame, poisonous gases will be released.

[1] Warning for service

- (1) Do not alter the unit.
- (2) For installation and relocation work, follow the instructions in the Installation Manual and use tools and pipe components specifically made for use with refrigerant specified in the outdoor unit installation manual.
- (3) Ask a dealer or an authorized technician to install, relocate and repair the unit.
For appliances not accessible to the general public.
- (4) Refrigerant pipes connection shall be accessible for maintenance purposes.
- (5) If the air conditioner is installed in a small room or closed room, measures must be taken to prevent the refrigerant concentration in the room from exceeding the safety limit in the event of refrigerant leakage. Should the refrigerant leak and cause the concentration limit to be exceeded, hazards due to lack of oxygen in the room may result.
- (6) Keep gas-burning appliances, electric heaters, and other fire sources (ignition sources) away from the location where installation, repair, and other air conditioner work will be performed.
If refrigerant comes into contact with a flame, poisonous gases will be released.
- (7) When installing or relocating, or servicing the air conditioner, use only the specified refrigerant (R32) to charge the refrigerant lines.
Do not mix it with any other refrigerant and do not allow air to remain in the lines.
If air is mixed with the refrigerant, then it can be the cause of abnormal high pressure in the refrigerant line, and may result in an explosion and other hazards.
- (8) After installation has been completed, check for refrigerant leaks. If refrigerant leaks into the room and comes into contact with the flame of a heater or portable cooking range, poisonous gases will be released.
- (9) Do not use low temperature solder alloy in the case of brazing the refrigerant pipes.
- (10) When performing brazing work, be sure to ventilate the room sufficiently. Make sure that there are no hazardous or flammable materials nearby.
When performing the work in a closed room, small room, or similar location, make sure that there are no refrigerant leaks before performing the work.
If refrigerant leaks and accumulates, it may ignite or poisonous gases may be released.
- (11) Do not install the unit in places where refrigerant may build-up or places with poor ventilation such as a semi-basement or a sunken place in outdoor: Refrigerant is heavier than air, and inclined to fall away from the leak source.
- (12) Do not use means to accelerate the defrosting process or to clean, other than those recommended by the manufacturer.
- (13) The appliance shall be stored in a room without continuously operating ignition sources (for example: open flames, an operating gas appliance or an operating electric heater).
- (14) Do not pierce or burn.
- (15) Be aware that refrigerants may not contain an odour.
- (16) Pipe-work shall be protected from physical damage.
- (17) The installation of pipe-work shall be kept to a minimum.
- (18) Compliance with national gas regulations shall be observed.
- (19) Keep any required ventilation openings clear of obstruction.
- (20) Servicing shall be performed only as recommended by the manufacturer.
- (21) The appliance shall be stored in a well-ventilated area where the room size corresponds to the room area as specified for operation.
- (22) Maintenance, service and repair operations shall be performed by authorized technician with required qualification.
- (23) Be sure to have appropriate ventilation in order to prevent ignition. Furthermore, be sure to carry out fire prevention measures that there are no dangerous or flammable objects in the surrounding area.

[2] Cautions for service

- (1) Perform service after recovering the refrigerant left in unit completely.
- (2) Do not release refrigerant in the air.
- (3) After completing service, charge the cycle with specified amount of refrigerant.
- (4) When performing service, install a filter drier simultaneously.
Be sure to use a filter drier for new refrigerant.

[3] Additional refrigerant charge

When charging directly from cylinder

R32 is a single refrigerant and its composition does not change. Therefore, both liquid charging and gas charging are possible. Liquid charging of refrigerant all at once from the low pressure side may cause the compressor malfunction. Accordingly, make sure that charging is gradual.

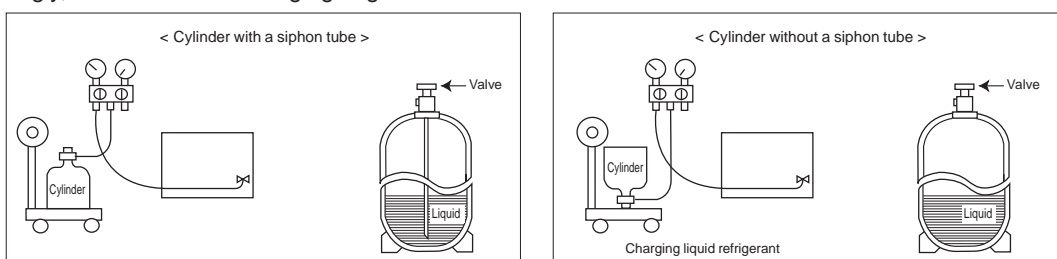

[4] Cautions for unit using R32 refrigerant

Basic work procedures are the same as those for conventional units using refrigerant R410A. However, pay careful attention to the following points.

(1) Information on servicing

(1-1) Checks on the Area

Prior to beginning work on systems containing flammable refrigerants, safety checks are necessary to ensure that the risk of ignition is minimized.

For repair to the refrigerating systems, (1-3) to (1-7) shall be completed prior to conducting work on the systems.

(1-2) Work Procedure

Work shall be undertaken under a controlled procedure so as to minimize the risk of a flammable gas or vapor being present while the work is being performed.

(1-3) General Work Area

All maintenance staff and others working in the local area shall be instructed on the nature of work being carried out.

Work in confined spaces shall be avoided. The area around the workspace shall be sectioned off. Ensure that the conditions within the area have been made safe by control of flammable material.

(1-4) Checking for Presence of Refrigerant

The area shall be checked with an appropriate refrigerant detector prior to and during work, to ensure the technician is aware of potentially toxic or flammable atmospheres. Ensure that the leak detection equipment being used is suitable for use with all applicable refrigerants, i.e. non-sparking, adequately sealed or intrinsically safe.

(1-5) Presence of Fire Extinguisher

If any hot work is to be conducted on the refrigeration equipment or any associated parts, appropriate fire extinguishing equipment shall be available to hand.

Have a dry powder or CO₂ fire extinguisher adjacent to the charging area.

(1-6) No Ignition Sources

No person carrying out work in relation to a refrigeration system which involves exposing any pipe work shall use any sources of ignition in such a manner that it may lead to the risk of fire or explosion. All possible ignition sources, including cigarette smoking, should be kept sufficiently far away from the site of installation, repairing, removing and disposal, during which refrigerant can possibly be released to the surrounding space. Prior to work taking place, the area around the equipment is to be surveyed to make sure that there are no flammable hazards or ignition risks. "No Smoking" signs shall be displayed.

(1-7) Ventilated Area

Ensure that the area is in the open or that it is adequately ventilated before breaking into the system or conducting any hot work. A degree of ventilation shall continue during the period that the work is carried out. The ventilation should safely disperse any released refrigerant and preferably expel it externally into the atmosphere.

(1-8) Checks on the Refrigeration Equipment

Where electrical components are being changed, they shall be fit for the purpose and to the correct specification. At all times the manufacturer's maintenance and service guidelines shall be followed. If in doubt, consult the manufacturer's technical department for assistance.

The following checks shall be applied to installations using flammable refrigerants:

- The charge size is in accordance with the room size within which the refrigerant containing parts are installed.
- The ventilation machinery and outlets are operating adequately and are not obstructed.
- Marking to the equipment continues to be visible and legible. Markings and signs that are illegible shall be corrected.
- Refrigeration pipe or components are installed in a position where they are unlikely to be exposed to any substance which may corrode refrigerant containing components, unless the components are constructed of materials which are inherently resistant to being corroded or are suitably protected against being corroded.

(1-9) Checks on Electrical Devices

Repair and maintenance to electrical components shall include initial safety checks and component inspection procedures. If a fault exists that could compromise safety, then no electrical supply shall be connected to the circuit until it is satisfactorily dealt with. If the fault cannot be corrected immediately but it is necessary to continue operation, an adequate temporary solution shall be used. This shall be reported to the owner of the equipment so all parties are advised. Initial safety checks shall include that:

- capacitors are discharged: this shall be done in a safe manner to avoid possibility of sparking;
- no live electrical components and wiring are exposed while charging, recovering or purging the system;
- there is continuity of earth bonding

(2) Repairs to Sealed Components

(2-1) During repairs to sealed components, all electrical supplies shall be disconnected from the equipment being worked upon prior to any removal of sealed covers, etc. If it is absolutely necessary to have an electrical supply to equipment during servicing, then a permanently operating form of leak detection shall be located at the most critical point to warn of a potentially hazardous situation.

(2-2) Particular attention shall be paid to the following to ensure that by working on electrical components, the casing is not altered in such a way that the level of protection is affected. This shall include damage to cables, excessive number of connections, terminals not made to original specification, damage to seals, incorrect fitting of glands, etc.

Ensure that the apparatus is mounted securely.

Ensure that seals or sealing materials have not degraded to the point that they no longer serve the purpose of preventing the ingress of flammable atmospheres.

Replacement parts shall be in accordance with the manufacturer's specifications.

(3) Repair to intrinsically Safe Components

Do not apply any permanent inductive or capacitance loads to the circuit without ensuring that this will not exceed the permissible voltage and current permitted for the equipment in use.

Intrinsically safe components are the only types that can be worked on while live in the presence of a flammable atmosphere. The test apparatus shall be at the correct rating.

Replace components only with parts specified by the manufacturer. Other parts may result in the ignition of refrigerant in the atmosphere from a leak.

(4) Cabling

Check that cabling will not be subject to wear, corrosion, excessive pressure, vibration, sharp edges or any other adverse environmental effects. The check shall also take into account the effects of aging or continual vibration from sources such as compressors or fans.

(5) Detection of Flammable Refrigerants

Under no circumstances shall potential sources of ignition be used in the searching for or detection of refrigerant leaks. A halide torch (or any other detector using a naked flame) shall not be used.

(6) Leak Detection Methods

Electronic leak detectors may be used to detect refrigerant leaks but, in the case of flammable refrigerants, the sensitivity may not be adequate, or may need re-calibration. (Detection equipment shall be calibrated in a refrigerant-free area.)

Ensure that the detector is not a potential source of ignition and is suitable for the refrigerant used. Leak detection equipment shall be set at a percentage of the LFL of the refrigerant and shall be calibrated to the refrigerant employed, and the appropriate percentage of gas (25% maximum) is confirmed.

Leak detection fluids are suitable for use with most refrigerants but the use of detergents containing chlorine shall be avoided as the chlorine may react with the refrigerant and corrode the copper pipe-work.

If a leak is suspected, all naked flames shall be removed/extinguished.

If a leakage of refrigerant is found which requires brazing, all of the refrigerant shall be recovered from the system, or isolated (by means of shut off valves) in a part of the system remote from the leak. For appliances containing flammable refrigerants, oxygen free nitrogen (OFN) shall then be purged through the system both before and during the brazing process.

(7) Removal and Evacuation

When breaking into the refrigerant circuit to make repairs – or for any other purpose conventional procedures shall be used. However, for flammable refrigerants it is important that best practice is followed since flammability is a consideration. The following procedure shall be adhered to:

- remove refrigerant
- purge the circuit with inert gas
- evacuate
- purge again with inert gas
- open the circuit by cutting or brazing.

The refrigerant charge shall be recovered into the correct recovery cylinders. For appliances containing flammable refrigerants, the system shall be “flushed” with OFN to render the unit safe. This process may need to be repeated several times.

Compressed air or oxygen shall not be used for purging refrigerant systems.

For appliances containing flammable refrigerants, flushing shall be achieved by breaking the vacuum in the system with OFN and continuing to fill until the working pressure is achieved, then venting to atmosphere, and finally pulling down to a vacuum. This process shall be repeated until no refrigerant is within the system. When the final OFN charge is used, the system shall be vented down to atmospheric pressure to enable work to take place. This operation is absolutely vital if brazing operations on the pipe-work are to take place.

Ensure that the outlet for the vacuum pump is not close to any ignition sources and that ventilation is available.

(8) Charging Procedures

In addition to conventional charging procedures, the following requirements shall be followed:

- Ensure that contamination of different refrigerants does not occur when using charging equipment. Hoses or lines shall be as short as possible to minimize the amount of refrigerant contained in them.
- Cylinders shall be kept upright.
- Ensure that the refrigeration system is earthed prior to charging the system with refrigerant.
- Label the system when charging is complete (if not already).
- Extreme care shall be taken not to overfill the refrigeration system.

Prior to recharging the system, it shall be pressure-tested with the appropriate purging gas. The system shall be leak-tested on completion of charging but prior to commissioning. A follow up leak test shall be carried out prior to leaving the site.

(9) Decommissioning

Before carrying out this procedure, it is essential that the technician is completely familiar with the equipment and all its detail. It is recommended good practice that all refrigerants are recovered safely. Prior to the task being carried out, an oil and refrigerant sample shall be taken in case analysis is required prior to re-use of reclaimed refrigerant. It is essential that electrical power is available before the task is commenced.

- a) Become familiar with the equipment and its operation.

Continued to the next page.

- b) Isolate system electrically.
- c) Before attempting the procedure, ensure that:
 - mechanical handling equipment is available, if required, for handling refrigerant cylinders;
 - all personal protective equipment is available and being used correctly;
 - the recovery process is supervised at all times by a competent person;
 - recovery equipment and cylinders conform to the appropriate standards.
- d) Pump down refrigerant system, if possible.
- e) If a vacuum is not possible, make a manifold so that refrigerant can be removed from various parts of the system.
- f) Make sure that cylinder is situated on the scales before recovery takes place.
- g) Start the recovery machine and operate in accordance with manufacturer's instructions.
- h) Do not overfill cylinders. (No more than 80 % volume liquid charge).
- i) Do not exceed the maximum working pressure of the cylinder, even temporarily.
- j) When the cylinders have been filled correctly and the process completed, make sure that the cylinders and the equipment are removed from site promptly and all isolation valves on the equipment are closed off.
- k) Recovered refrigerant shall not be charged into another refrigeration system unless it has been cleaned and checked.

(10) Labelling

Equipment shall be labelled stating that it has been de-commissioned and emptied of refrigerant. The label shall be dated and signed. For appliances containing flammable refrigerants, ensure that there are labels on the equipment stating the equipment contains flammable refrigerant.

(11) Recovery

When removing refrigerant from a system, either for servicing or decommissioning, it is recommended good practice that all refrigerants are removed safely. When transferring refrigerant into cylinders, ensure that only appropriate refrigerant recovery cylinders are employed. Ensure that the correct number of cylinders for holding the total system charge are available. All cylinders to be used are designated for the recovered refrigerant and labelled for that refrigerant (i.e. special cylinders for the recovery of refrigerant). Cylinders shall be complete with pressure-relief valve and associated shut-off valves in good working order. Empty recovery cylinders are evacuated and, if possible, cooled before recovery occurs.

The recovery equipment shall be in good working order with a set of instructions concerning the equipment that is at hand and shall be suitable for the recovery of all appropriate refrigerants including, when applicable, flammable refrigerants. In addition, a set of calibrated weighing scales shall be available and in good working order. Hoses shall be complete with leak-free disconnect couplings and in good condition. Before using the recovery machine, check that it is in satisfactory working order, has been properly maintained and that any associated electrical components are sealed to prevent ignition in the event of a refrigerant release. Consult manufacturer if in doubt.

The recovered refrigerant shall be returned to the refrigerant supplier in the correct recovery cylinder, and the relevant waste transfer note arranged. Do not mix refrigerants in recovery units and especially not in cylinders. If compressors or compressor oils are to be removed, ensure that they have been evacuated to an acceptable level to make certain that flammable refrigerant does not remain within the lubricant. The evacuation process shall be carried out prior to returning the compressor to the suppliers. Only electric heating to the compressor body shall be employed to accelerate this process. When oil is drained from a system, it shall be carried out safely.

[5] Service tools

Use the below service tools as exclusive tools for R32 refrigerant.

No.	Tool name	Specifications
①	Gauge manifold	<ul style="list-style-type: none"> · Only for R32 · Use the existing fitting specifications. (UNF1/2) · Use high-tension side pressure of 5.3MPa·G or over.
②	Charge hose	<ul style="list-style-type: none"> · Only for R32 · Use pressure performance of 5.09MPa·G or over.
③	Electronic weighing scale	—
④	Gas leak detector	· Use the detector for R134a, R407C, R410a or R32.
⑤	Adaptor for reverse flow check	· Attach on vacuum pump.
⑥	Refrigerant charge base	—
⑦	Refrigerant cylinder	<ul style="list-style-type: none"> · Only for R32 · Top of cylinder (Pink) · Cylinder with syphon
⑧	Refrigerant recovery equipment	—

2-3. PRECAUTIONS WHEN REUSING EXISTING R22/R410a REFRIGERANT PIPES

(1) Flowchart

- Refer to the flowchart below to determine if the existing pipes can be used and if it is necessary to use a filter drier.
- If the diameter of the existing pipes is different from the specified diameter, refer to technical data materials to confirm if the pipes can be used.

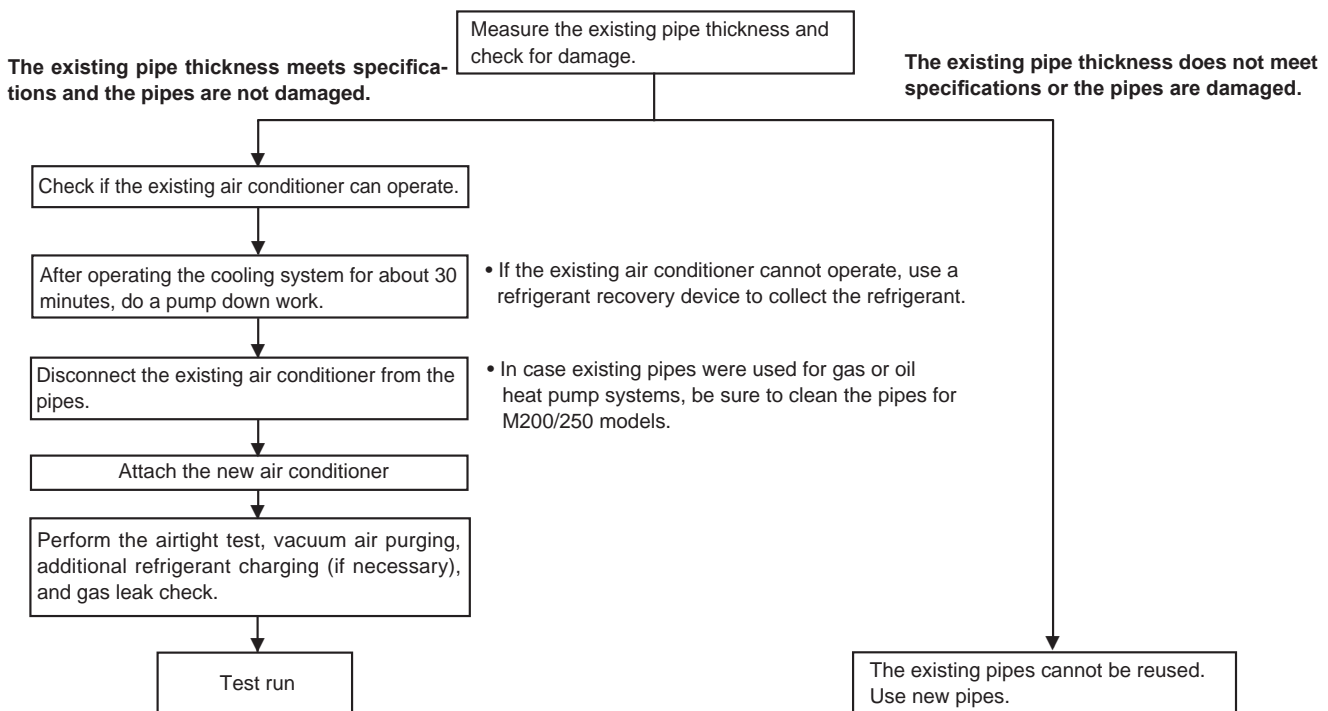

(2) Cautions for refrigerant piping work

New refrigerant R32 is adopted for replacement inverter series. Although the refrigerant piping work for R32 is same as for R22, exclusive tools are necessary so as not to mix with different kind of refrigerant. Furthermore as the working pressure of R32 is 1.6 times higher than that of R22, their sizes of flared sections and flare nuts are different.

① Thickness of pipes

Because the working pressure of R32 is higher compared to R22, be sure to use refrigerant piping with thickness shown below. (Never use pipes of 0.7 mm or below.)

Diagram below: Piping diameter and thickness

Nominal dimensions (inch)	Outside diameter (mm)	Thickness (mm)	
		R32/R410a	R22
1/4	6.35	0.8	0.8
3/8	9.52	0.8	0.8
1/2	12.70	0.8	0.8
5/8	15.88	1.0	1.0
3/4	19.05	—	1.0

② Dimensions of flare cutting and flare nut

The component molecules in HFC refrigerant are smaller compared to conventional refrigerants. In addition to that, R32 is a refrigerant, which has higher risk of leakage because its working pressure is higher than that of other refrigerants. Therefore, to enhance airtightness and strength, flare cutting dimension of copper pipe for R32 has been specified separately from the dimensions for other refrigerants as shown below. The dimension B of flare nut for R32 also has partly been changed to increase strength as shown below. Set copper pipe correctly referring to copper pipe flaring dimensions for R32 below. For 1/2 and 5/8 inch pipes, the dimension B changes. Use torque wrench corresponding to each dimension.

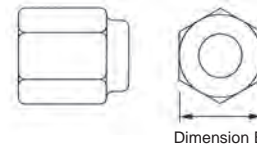
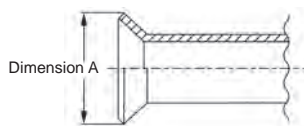

Flare cutting dimensions

Nominal dimensions (in)	Outside diameter (mm)	Dimension A (+0, -0.4) (mm)	
		R32/R410a	R22
1/4	6.35	9.1	9.0
3/8	9.52	13.2	13.0
1/2	12.70	16.6	16.2
5/8	15.88	19.7	19.4
3/4	19.05	—	23.3

Flare nut dimensions

Nominal dimensions (in)	Outside diameter (mm)	Dimension B (mm)	
		R32/R410a	R22
1/4	6.35	17.0	17.0
3/8	9.52	22.0	22.0
1/2	12.70	26.0	24.0
5/8	15.88	29.0	27.0
3/4	19.05	—	36.0

③ Tools for R32 (The following table shows whether conventional tools can be used or not.)

Tools and materials	Use	R32 tools	Can R22 tools be used?	Can R407C tools be used?	Can R410a tools be used?
Gauge manifold	Air purge, refrigerant charge and operation check	Tool exclusive for R32	×	×	○
Charge hose		Tool exclusive for R32	×	×	○
Gas leak detector	Gas leak check	Tool for HFC refrigerant	×	○	○
Refrigerant recovery equipment	Refrigerant recovery	Tool exclusive for R32	×	×	○
Refrigerant cylinder	Refrigerant charge	Tool exclusive for R32	×	×	×
Safety charger	Prevent compressor malfunction when charging refrigerant by spraying liquid refrigerant	Tool exclusive for R32	×	×	○
Charge valve	Prevent gas from blowing out when detaching charge hose	Tool exclusive for R32	×	×	○
Vacuum pump	Vacuum drying and air purge	Tools for other refrigerants can be used if equipped with adapter for reverse flow check	△ (Usable if equipped with adapter for reverse flow)	△ (Usable if equipped with adapter for reverse flow)	△ (Usable if equipped with adapter for reverse flow)
Flare tool	Flaring work of piping	Tools for other refrigerants can be used by adjusting flaring dimension	△ (Usable by adjusting flaring dimension)	△ (Usable by adjusting flaring dimension)	△ (Usable by adjusting flaring dimension)
Bender	Bend the pipes	Tools for other refrigerants can be used	○	○	○
Pipe cutter	Cut the pipes	Tools for other refrigerants can be used	○	○	○
Welder and nitrogen gas cylinder	Weld the pipes	Tools for other refrigerants can be used	○	○	○
Refrigerant charging scale	Refrigerant charge	Tools for other refrigerants can be used	○	○	○
Vacuum gauge or thermistor vacuum gauge and vacuum valve	Check the degree of vacuum. (Vacuum valve prevents back flow of oil and refrigerant to thermistor vacuum gauge)	Tools for other refrigerants can be used	○	○	○
Charging cylinder	Refrigerant charge	Tool exclusive for R32	×	—	×

× : Prepare a new tool. (Use the new tool as the tool exclusive for R32.)

△ : Tools for other refrigerants can be used under certain conditions.

○ : Tools for other refrigerants can be used.

2-4. Choosing the outdoor unit installation location

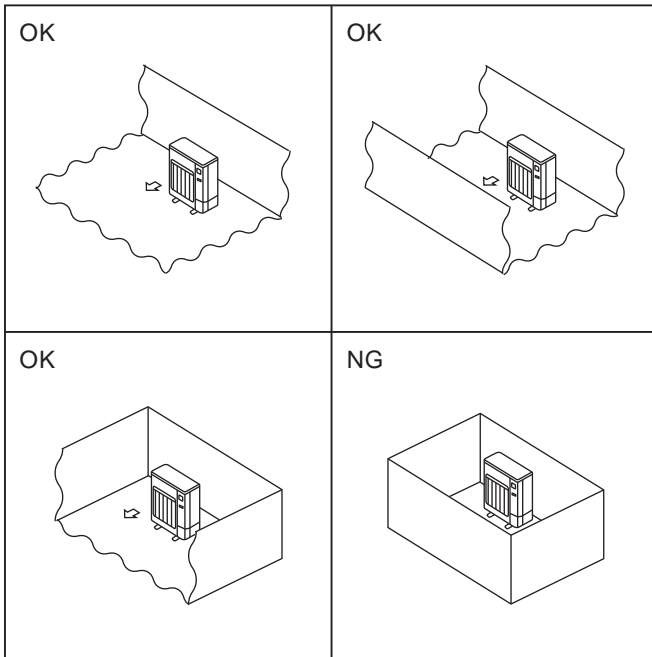

R32 is heavier than air—as well as other refrigerants—so tends to accumulate at the base (in the vicinity of the floor). If R32 accumulates around base, it may reach a flammable concentration in case room is small. To avoid ignition, maintaining a safe work environment is required by ensuring appropriate ventilation. If a refrigerant leak is confirmed in a room or an area where there is insufficient ventilation, refrain from using of flames until the work environment can be improved by ensuring appropriate ventilation.

Install outdoor units in a place where at least one of the four sides is open, and in a sufficiently large space without depressions.

2-5. Minimum installation area

If you unavoidably install a unit in a space where all four sides are blocked or there are depressions, confirm that one of these situations (A, B or C) is satisfied.

Note: These countermeasures are for keeping safety not for specification guarantee.

A) Secure sufficient installation space (minimum installation area A_{min}).

Install in a space with an installation area of A_{min} or more, corresponding to refrigerant quantity M (factory-charged refrigerant + locally added refrigerant).

M [kg]	A_{min} [m ²]
1.0	12
1.5	17
2.0	23
2.5	28
3.0	34
3.5	39
4.0	45
4.5	50
5.0	56
5.5	62
6.0	67
6.5	73
7.0	78
7.5	84
8.0	89
8.5	95
9.0	100
9.5	106

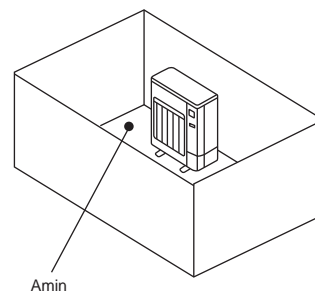

B) Install in a space with a depression height of ≤ 0.125 [m].

Height from the bottom of
0.125 [m] or less

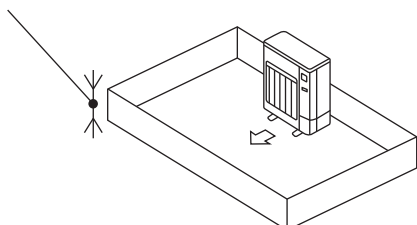

Height from the bottom of
0.125 [m] or less

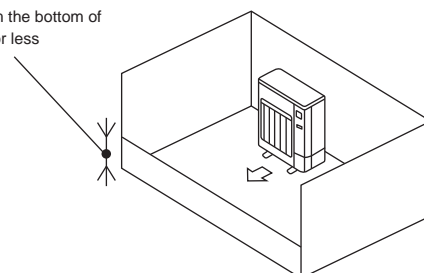

C) Create an appropriate ventilation open area.

Make sure that the width of the open area is 0.9 [m] or more and the height of the open area is 0.15 [m] or more. However, the height from the bottom of the installation space to the bottom edge of the open area should be 0.125 [m] or less.

Open area should be 75% or more opening.

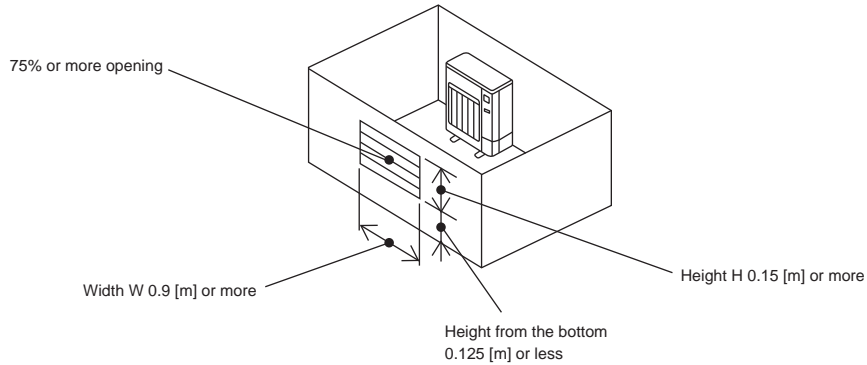

■ Indoor units

Install in a room with a floor area of A_{min} or more, corresponding to refrigerant quantity M (factory-charged refrigerant + locally added refrigerant).

* For the factory-charged refrigerant amount, refer to the spec nameplate or installation manual.

For the amount to be added locally, refer to the installation manual.

Install the indoor unit so that the height from the floor to the bottom of the indoor unit is h_0 .

For wall mounted: 1.8 m or more

For ceiling suspended, cassette and ceiling concealed: 2.2 m or more

For floor standing (PSA-M): 0 m

* There are restrictions in installation height for each model, so read the installation manual for the particular unit.

Case 1: for wall mounted, ceiling suspended, cassette and concealed

M [kg]	A_{min} [m ²]
1.0	4
1.5	6
2.0	8
2.5	10
3.0	12
3.5	14
4.0	16
4.5	20
5.0	24
5.5	29
6.0	35
6.5	41
7.0	47
7.5	54
8.0	62
8.5	69
9.0	78
9.5	87

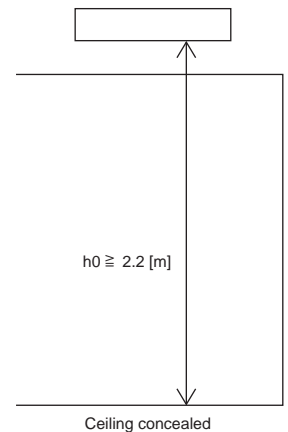
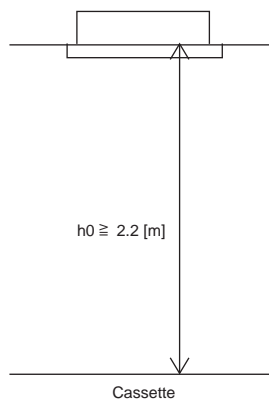
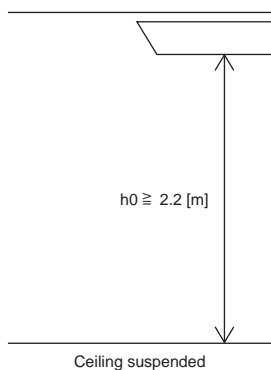
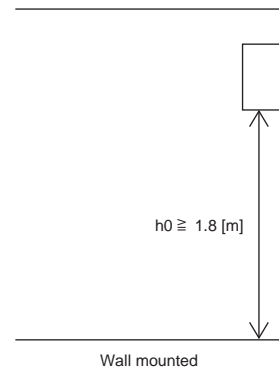

Case 2: for floor standing (PSA-M)

M [kg]	Amin [m ²]
< 1.84	No requirements
1.84	6
2.0	6
2.5	7
3.0	9
3.5	10
4.0	11
4.5	13
5.0	14
5.5	15
6.0	17
6.5	18
7.0	20
7.5	21
8.0	22
8.5	24
9.0	25
9.5	26

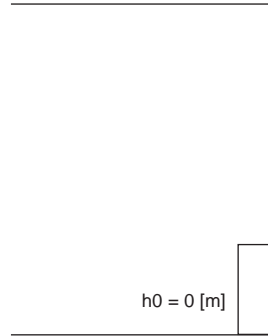

Floor standing (PSA-M)

3

FEATURES

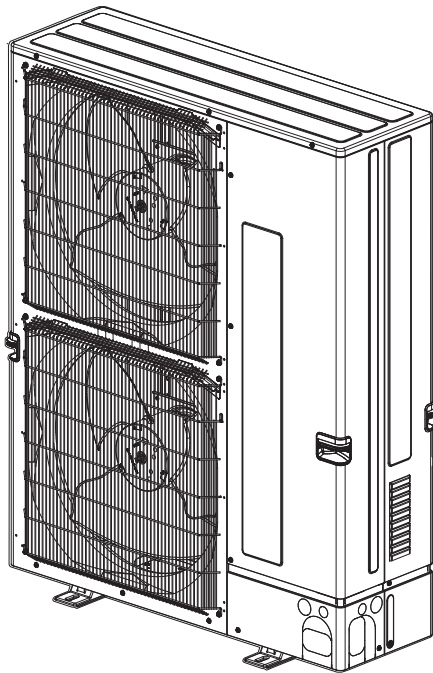

PUZ-M200YKA.UK
PUZ-M250YKA.UK

CHARGELESS SYSTEM

PRE-CHARGED REFRIGERANT IS SUPPLIED FOR PIPING LENGTH AT SHIPMENT

Maximum 30 m (PUZ-M200/250)

The refrigerant circuit with LEV (Linear Expansion Valve) and power receiver always control the optimal refrigerant level regardless of the length (30 m maximum and 5 m minimum) of piping. The additional refrigerant charging work during installation often causes problems. It is completely eliminated by chargeless system. This unique system improves the quality and reliability of the work done. It also helps to speed up the installation time.

4

SPECIFICATIONS

Service Ref.			PUZ-M200YKA.UK	PUZ-M250YKA.UK	
OUTDOOR UNIT	Power supply (phase, cycle, voltage)		3 phase 50 Hz, 400 V		
		Max. current	A	22.5	
	External finish		Munsell 3Y 7.8/1.1		
	Refrigerant control		Linear Expansion Valve		
	Compressor		Hermetic		
		Model	AVB52FBAMT		
		Motor output	kW	3.8	
		Starter type	Inverter		
		Protection devices	HP switch Comp surface thermo Over current detection Thermal protector		
		Crankcase heater	W	—	
	Heat exchanger		Plate fin coil		
	Fan	Fan (drive) o No.		Propeller fan o 2	
			Fan motor output	kW	0.200 + 0.200
			Airflow	m ³ /min(CFM)	140 (4,940)
	Defrost method		Reverse cycle		
	Sound pressure level	Cooling	dB	58	59
		Heating	dB	60	62
	Dimensions	W	mm (inch)	1,050 (41-5/16)	
D		mm (inch)	330 + 40 (13+1-9/16)		
H		mm (inch)	1,338 (52-11/16)		
Weight		kg (lb)	129 (284)	138 (304)	
Refrigerant		R32			
	Charge	kg (lb)	5.6 (12.3)	6.8 (15.0)	
	Oil (Model)	L	2.30 (FW68S)		
REFRIGERANT PIPING	Pipe size O.D.	Liquid	mm (inch)	9.52 (3/8)	12.7 (1/2)
		Gas	mm (inch)	25.4 (1)	25.4 (1)
	Connection method	Indoor side		Flared	
		Outdoor side		Flared & Brazing	
	Between the indoor & outdoor unit	Height difference		Maximum 30 m	
		Piping length		Maximum 70 m	

5-1. REFILLING REFRIGERANT CHARGE (R32: kg) PUZ-M200/250

Service Ref.	Piping length (one way)							Initial charged
	10 m	20 m	30 m	40 m	50 m	60 m	75 m	
PUZ-M200YKA.UK	5.1	5.4	5.6	+0.4 (6.0)	+0.8 (6.4)	+1.2 (6.8)	+1.6 (7.2)	5.6
PUZ-M250YKA.UK	6.2	6.5	6.8	+0.6 (7.4)	+1.2 (8.0)	+1.8 (8.6)	+2.4 (9.2)	6.8

Additional charge is required for pipes longer than 30 m.

5-2. ADJUSTING THE AMOUNT OF REFRIGERANT PUZ-M200/250

Service Ref.	Initial charged	Amount of additional refrigerant charge (kg)			
		31–40 m and less	41–50 m and less	51–60 m and less	61–70 m and less
PUZ-M200YKA.UK	5.6	0.4	0.8	1.2	1.6
PUZ-M250YKA.UK	6.8	0.6	1.2	1.8	2.4

5-3. COMPRESSOR TECHNICAL DATA

(Winding temperature at 20°C)

Service Ref.	PUZ-M200YKA.UK PUZ-M250YKA.UK	
Compressor model	AVB52FBAMT	
Winding Resistance (Ω)	U-V	0.305
	U-W	0.305
	W-V	0.305

5-4. NOISE CRITERION CURVES

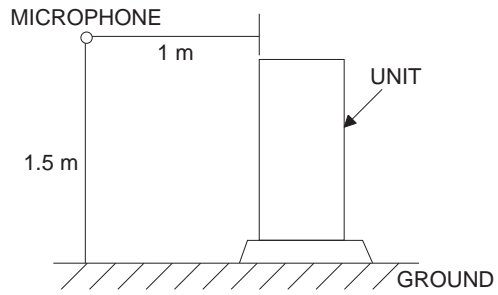

PUZ-M200YKA.UK

MODE	SPL(dB)	LINE
COOLING	58	○—○
HEATING	60	●—●

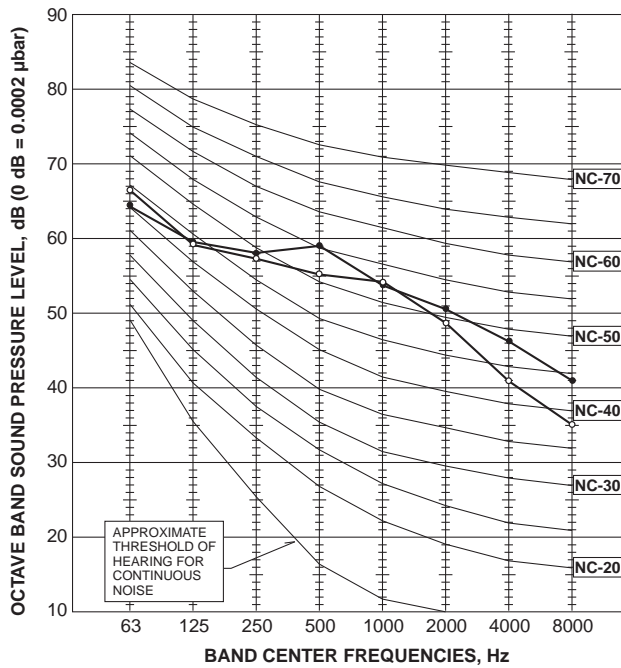

PUZ-M250YKA.UK

MODE	SPL(dB)	LINE
COOLING	59	○—○
HEATING	62	●—●

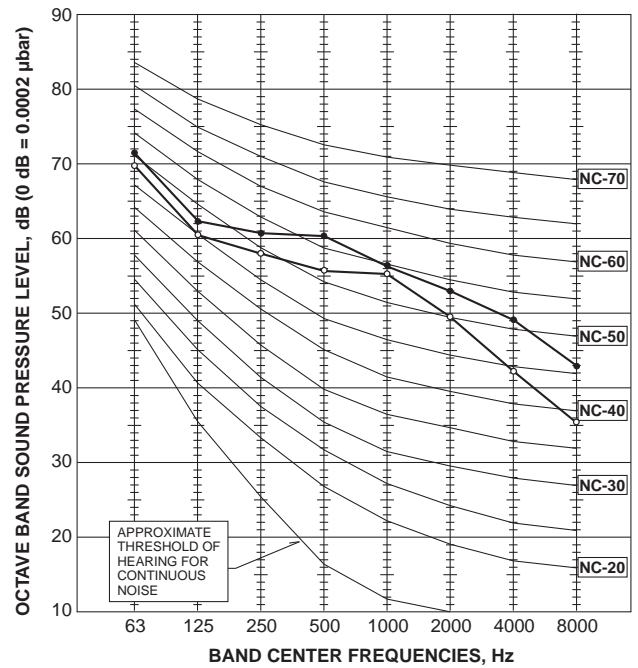

5-5. STANDARD OPERATION DATA

Representative matching			PLZ-M100EA.UK ×2		PLA-M125EA.UK ×2		
Mode			Cooling	Heating	Cooling	Heating	
Total	Capacity	W	19,000	22,400	22,000	27,000	
	Input	kW	5.21	5.93	6.84	7.78	
Electrical circuit	Indoor unit		PLZ-M100EA.UK		PLA-M125EA.UK		
	Phase , Hz		1, 50		1, 50		
	Voltage	V	230		230		
	Input	kW	0.07 × 2	0.07 × 2	0.10 × 2	0.10 × 2	
	Current	A	0.46 × 2	0.44 × 2	0.66 × 2	0.64 × 2	
	Outdoor unit		PUZ-M200YKA.UK		PUZ-M250YKA.UK		
	Phase , Hz		3, 50		3, 50		
	Voltage	V	400		400		
	Current	A	8.7	9.2	9.9	10.9	
Refrigerant circuit	Discharge pressure	MPa	3.13	2.69	3.16	2.69	
	Suction pressure	MPa	1.07	0.78	1.07	0.76	
	Discharge temperature	°C	78.6	78.8	86.0	82.9	
	Condensing temperature	°C	49.8	43.4	50.3	43.4	
	Suction temperature	°C	9	-1.2	8.8	-2.3	
	Ref. pipe length	m	7.5	7.5	7.5	7.5	
Indoor side	Intake air temperature	D.B.	°C	27	20	27	20
		W.B.	°C	19	15	19	15
	Discharge air temperature	D.B.	°C	9.9	38.9	10.7	41.6
Outdoor side	Intake air temperature	D.B.	°C	35	7	35	7
		W.B.	°C	24	6	24	6
SHF			0.85	—	0.73	—	
BF			0.05	—	0.06	—	

PUZ-M200YKA.UK
PUZ-M250YKA.UK

Unit: mm

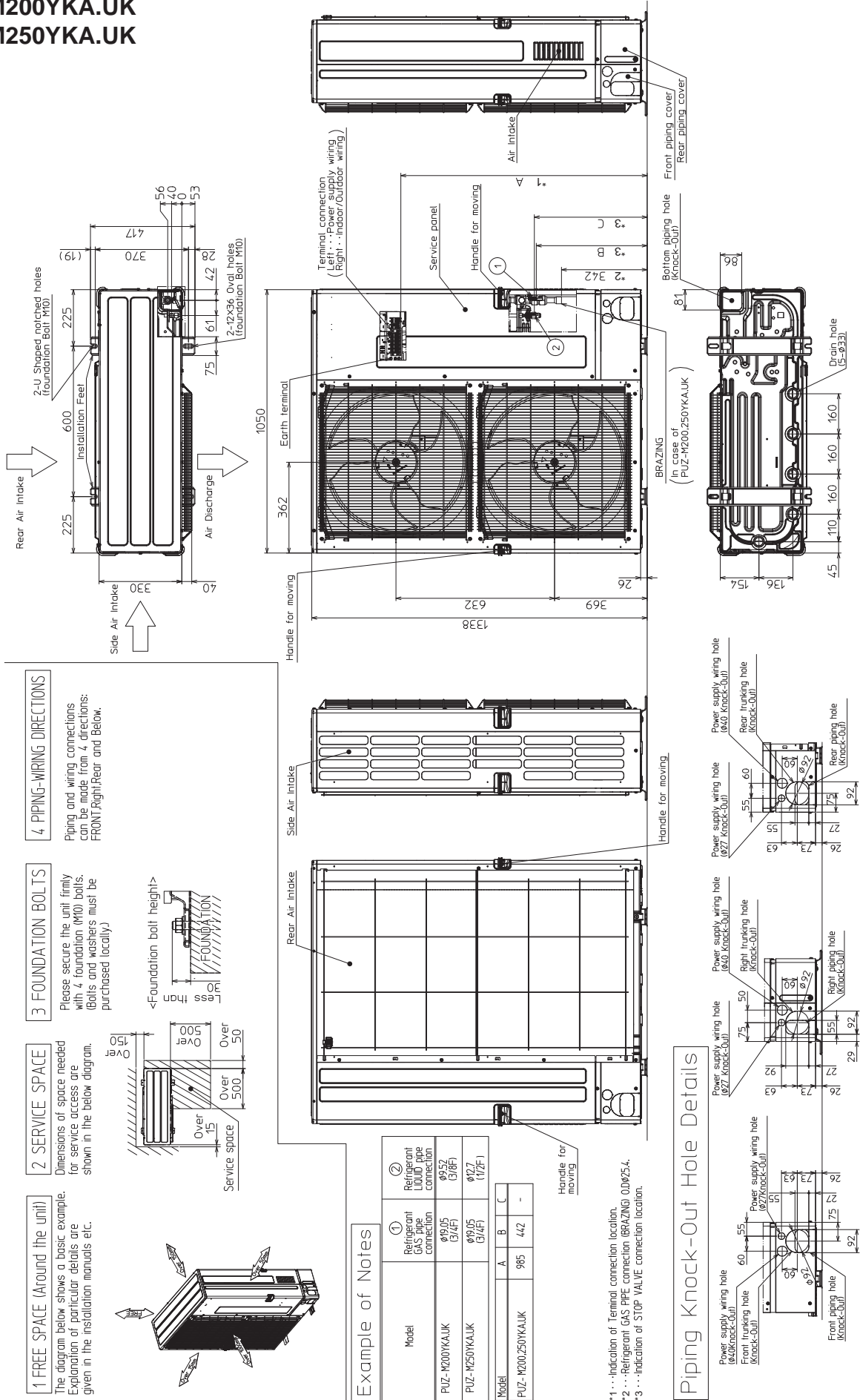

Example of Notes

Model	① Refrigerant Valve connection		② Refrigerant Valve connection	
	A	B	C	-
PUZ-M200YKAUK	ø19.05 (3/4F)	ø15.5 (3/8F)	ø15.5 (3/8F)	ø15.5 (3/8F)
PUZ-M250YKAUK	ø19.05 (3/4F)	ø15.5 (3/8F)	ø17.2 (1/2F)	ø17.2 (1/2F)
Model	A	B	C	-
PUZ-M200.250YKAUK	985	442	-	-

*1...Indication of Terminal connection location.
*2...Refrigerant GAS PIPE connection (BRAZING) 0.0W25.4.
*3...Indication of STOP VALVE connection location.

Piping Knock-Out Hole Details

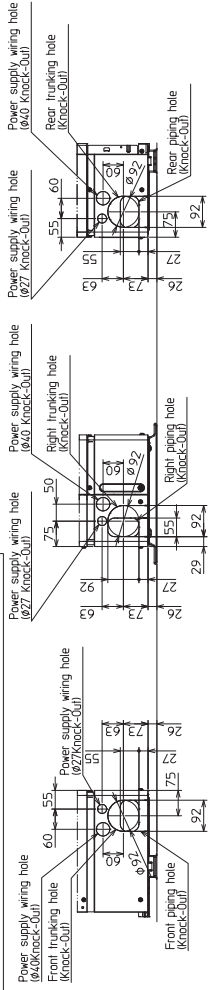

PUZ-M200YKA.UK

PUZ-M250YKA.UK

SYMBOL	NAME	SYMBOL	NAME	SYMBOL	NAME
TB1	Terminal Block <Power Supply>	P.B.	Power Circuit Board	SW9	Switch <Function Switch>
TB2	Terminal Block <Indoor/Outdoor>	TB-U/V/W	Connection Terminal <U/V/W-Phase>	SWP	Switch <Pump Down>
MC	Motor for Compressor	TB-L1/L2/L3	Connection Terminal <L1/L2/L3-Power Supply>	CN31	Connector <Emergency Operation>
MF1, MF2	Fan Motor	TB-P1/P3	Connection Terminal	CN3S	Connector <Connection for Option>
Z1S4	Solenoid Valve (4-Way Valve)	X52CA/B	52C Relay	CNDM	Connector <Connection for Option>
63H	High Pressure Switch	N.F.	Noise Filter Circuit Board	CN51	Connector <Connection for Option>
TRS	Thermal Protector	L1/L12/L13/NI	Connection Terminal <L1/L2/L3/N-Power Supply>	SV1/CH	Connector <Connection for Option>
TH3	Thermistor <Liquid>	LO1/LO2/LO3	Connection Terminal <L1/L2/L3-Power Supply>	SV3/SS	Connector <Connection for Option>
TH4	Thermistor <Discharge>	E1, E2	Connection Terminal <Ground>	CNM	Connector <Connection for Option>
TH6	Thermistor <2-Phase Pipe>	C.B.	Controller Circuit Board	CNMNT	Connector <Connect to Optional M-NET Adapter Board>
TH7	Thermistor <Ambient>	SW1	Switch <Manual Defrost, Defect History, Record Reset, Refrigerant Address>	CNMVNT	Connector <Connect to Optional M-NET Adapter Board>
TH8	Thermistor <Heat Sink>	SW4	Switch <Test Operation>	CNVMT	Connector <Connect to Optional M-NET Adapter Board>
TH33	Thermistor <Comp. Surface>	SW5	Switch <Function Switch>	LED1, LED2	LED <Operation Inspection Indicators>
LEV-A, LEV-B	Linear Expansion Valve	SW6	Switch <Model Select>	F3, F4	Fuse <T6.3AL250V>
ACL4	Reactor	SW7	Switch <Function Switch>	X51, X52, X54	Relay
DCL	Reactor	SW8	Switch <Function Switch>		
RS	Rush Current Protect Resistor				
FUSE1, FUSE2	Fuse <T15AL250V>				
CY1, CY2	Capacitor				

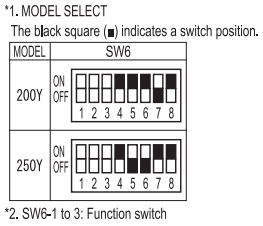
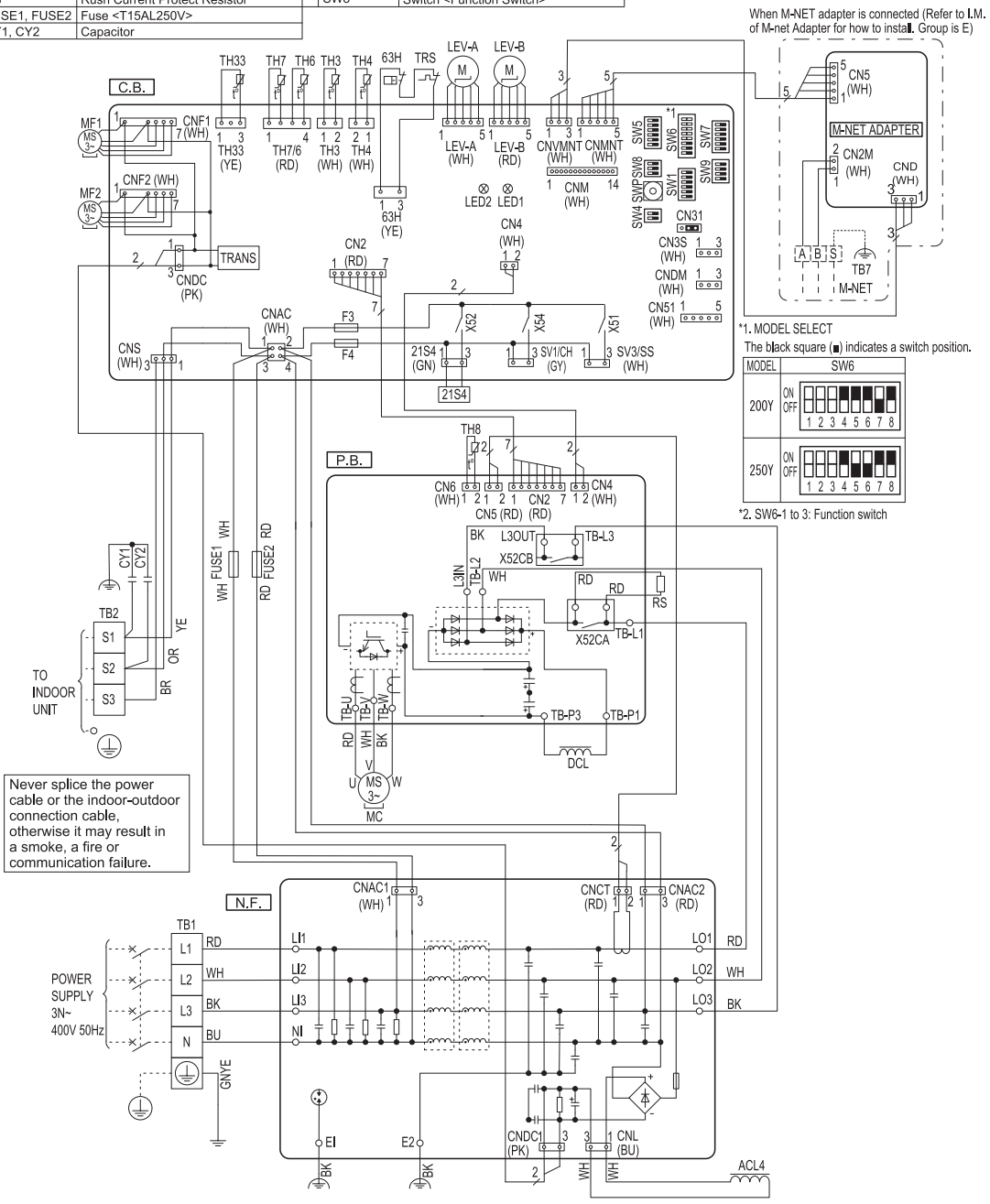

*1. MODEL SELECT
The black square (■) indicates a switch position.

MODEL	SW6
200Y	ON OFF ■ ■ ■ ■ ■ ■ ■ ■ 1 2 3 4 5 6 7 8
250Y	ON OFF ■ ■ ■ ■ ■ ■ ■ ■ 1 2 3 4 5 6 7 8

*2. SW6-1 to 3: Function switch

Never splice the power cable or the indoor-outdoor connection cable, otherwise it may result in a smoke, a fire or communication failure.

M-NET ADAPTER

SYMBOL	NAME
TB7	Terminal Block <M-NET connection>
CN5	Connector <Transmission>
CND	Connector <Power Supply>
CN2M	Connector <M-NET communication>

8-1. FIELD ELECTRICAL WIRING (power wiring specifications)

Outdoor unit model		M200/250
Outdoor unit power supply		3N~ (3 ph 4-wires), 50 Hz, 400 V
Outdoor unit input capacity main switch (Breaker) *1		32A
Wiring x Wire No. size (mm ²)	Outdoor unit power supply *5	5 x Min 4
	Indoor unit-Outdoor unit *2	Cable length 50 m:3x4 (Polar)/Cable length 80 m:3x6 (Polar)
	Indoor unit-Outdoor unit earth *2	1 x Min 2.5
	Remote controller-Indoor unit *3	2 x 0.3 (Non-polar)
Circuit rating	Outdoor unit L1-N, L2-N, L3-N (3 phase) *4	230 V AC
	Indoor unit-Outdoor unit S1-S2 *4	230 V AC
	Indoor unit-Outdoor unit S2-S3 *4	24 V DC
	Remote controller-Indoor unit *4	12 V DC

- *1. A breaker with at least 3.0 mm contact separation in each pole shall be provided. Use earth leakage breaker (NV). Make sure that the current leakage breaker is one compatible with higher harmonics. Always use a current leakage breaker that is compatible with higher harmonics as this unit is equipped with an inverter. The use of an inadequate breaker can cause the incorrect operation of inverter.
- *2. Maximum 80 m. Total maximum including all indoor/outdoor connection is 80 m.
 - Use one cable for S1 and S2 and another for S3 as shown in the picture.
- *3. The 10 m wire is attached in the remote controller accessory.
- *4. The figures are NOT always against the ground.
 - S3 terminal has 24 V DC against S2 terminal. However between S3 and S1, these terminals are NOT electrically insulated by the transformer or other device.
- *5. In multi-phase appliances, the colour of the neutral conductor of the supply cord, if any, shall be blue.

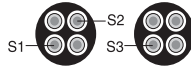

Caution: Be sure to install N-Line. Without N-Line, it could cause damage to the unit.

- Notes:**
1. Wiring size must comply with the applicable local and national code.
 2. Power supply cables and Indoor/Outdoor unit connecting cables shall not be lighter than polychloroprene sheathed flexible cable. (Design 60245 IEC 57)
 3. install an earth line longer than power cables.

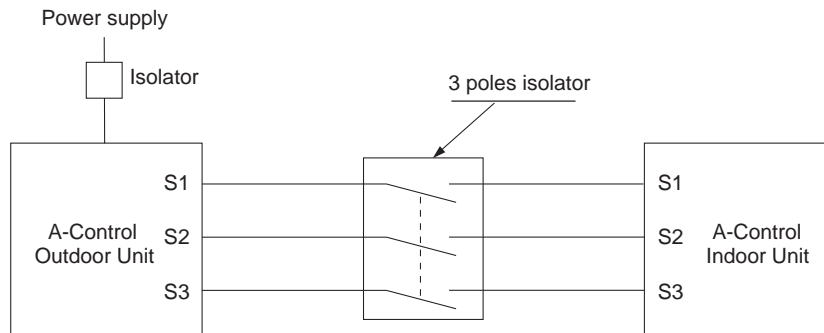

Warning: In the case of A-control wiring, there is high voltage potential on the S3 terminal caused by electrical circuit design that has no electrical insulation between power line and communication signal line. Therefore, please turn off the main power supply when servicing. And do not touch the S1, S2, S3 terminals when the power is energized. If isolator should be used between indoor unit and outdoor unit, please use 3-pole type.

Never splice the power cable or the indoor-outdoor connection cable, otherwise it may result in a smoke, a fire or communication failure.

Synchronized twin and triple system Electrical wiring

• Synchronized twin

• Synchronized triple

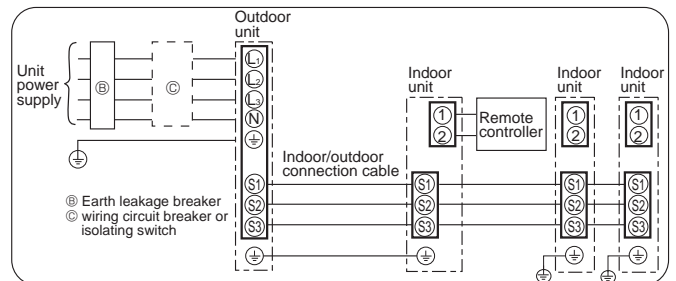
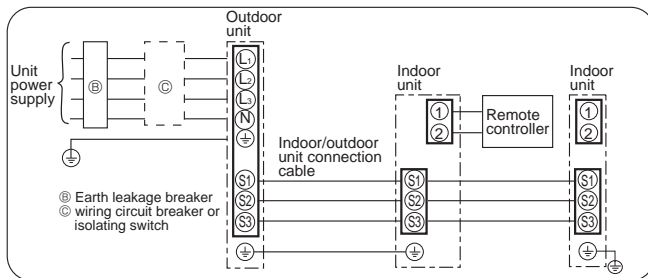

• Synchronized quadruple

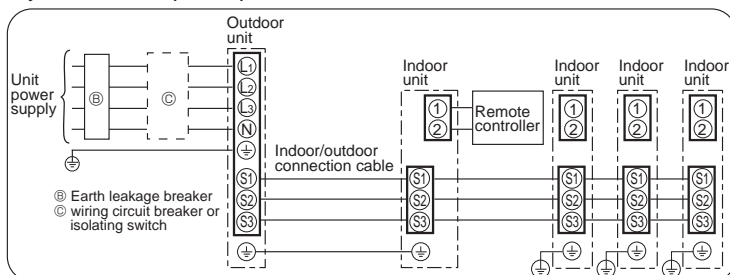

8-2. SEPARATE INDOOR UNIT/OUTDOOR UNIT POWER SUPPLIES

The following illustrations show available connection patterns.
The outdoor unit power supply patterns vary on models.

Simultaneous twin/triple system

<For models without heater>

The optional indoor power supply terminal kit is required.

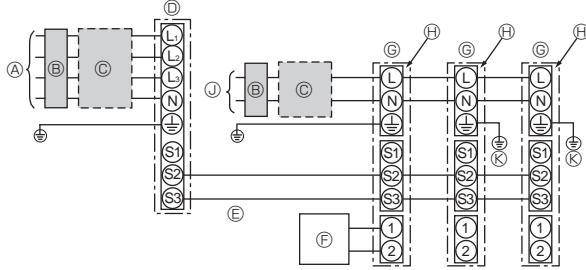

- Ⓐ Outdoor unit power supply
- Ⓑ Earth leakage breaker
- Ⓒ Wiring circuit breaker or isolating switch
- Ⓓ Outdoor unit
- Ⓔ Indoor unit/outdoor unit connecting cables
- Ⓕ Remote controller
- Ⓖ Indoor unit
- Ⓗ Option
- Ⓙ Indoor unit power supply
- Ⓚ Indoor unit earth

Affix a label B that is included with the manuals near each wiring diagram for the indoor and outdoor units.

If the indoor and outdoor units have separate power supplies, refer to the table below.
If the optional indoor power supply terminal kit is used, change the indoor unit electrical box wiring referring to the figure in the right and the DIP switch settings of the outdoor unit control board.

	Indoor unit specifications								
Indoor power supply terminal kit (option)	Required								
Indoor unit electrical box connector connection change	Required								
Label affixed near each wiring diagram for the indoor and outdoor units	Required								
Outdoor unit DIP switch settings (when using separate indoor unit/outdoor unit power supplies only)	<table border="1"> <tr> <td>ON</td> <td></td> <td></td> <td>3</td> </tr> <tr> <td>OFF</td> <td>1</td> <td>2</td> <td></td> </tr> </table> (SW8) Set the SW8-3 to ON.	ON			3	OFF	1	2	
ON			3						
OFF	1	2							

Note: There are 3 types of labels; A, B, and C.

Affix the appropriate labels to the units according to the wiring method.

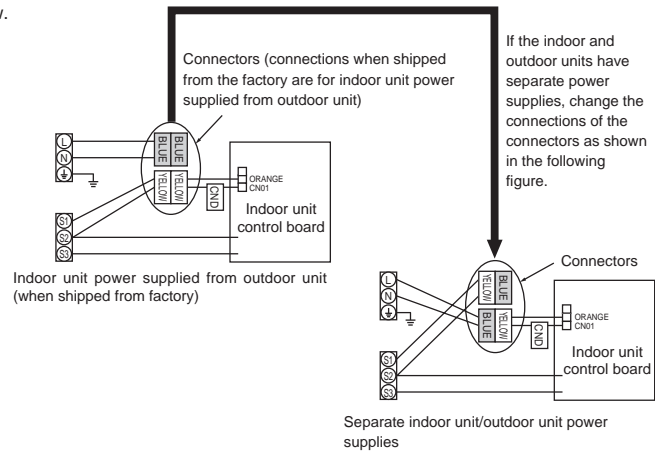

Indoor unit model		M50-125
Indoor unit power supply		~N (single), 50 Hz, 230 V
Indoor unit input capacity	*1	16 A
Main switch (Breaker)		
Indoor unit power supply		3 × Min 1.5
Indoor unit power supply earth		1 × Min 1.5
Indoor unit-Outdoor unit	*2	2 × Min 0.3
Indoor unit-Outdoor unit earth		-
Remote controller-Indoor unit	*3	2 × 0.3 (Non-polar)
Indoor unit L-N	*4	230 V AC
Indoor unit-Outdoor unit S1-S2	*4	-
Indoor unit-Outdoor unit S2-S3	*4	24 V DC
Remote controller-Indoor unit	*4	12 V DC

*1. A breaker with at least 3 mm contact separation in each pole shall be provided. Use earth leakage breaker (NV).

The breaker shall be provided to ensure disconnection of all active phase conductor of the supply.

*2. Maximum 120 m

*3. The 10 m wire is attached in the remote controller accessory. Maximum 500 m

*4. The figures are NOT always against the ground.





Notes: 1. Wiring size must comply with the applicable local and national code.

2. Power supply cables and indoor unit/outdoor unit connecting cables shall not be lighter than polychloroprene sheathed flexible cable. (Design 60245 IEC 57)

3. Install an earth line longer than power cables.

8-3. INDOOR – OUTDOOR CONNECTING CABLE

**WIRING SPECIFICATIONS FOR 220–240 V, 50 Hz
(INDOOR-OUTDOOR CONNECTING CABLE)**

Cross section of cable	Wire size (mm ²)	Number of wires	Polarity	L (m)*5
Round 	2.5	3	Clockwise : S1-S2-S3 (Pay attention to stripe of yellow and green.)	(30) *1
Flat 	2.5	3	Not applicable (Because center wire has no cover finish)	Not applicable *4
Flat 	1.5	4	From left to right : S1-Open-S2-S3	(18) *2
Round 	2.5	4	Clockwise : S1-S2-S3-Open (Connect S1 and S3 to the opposite angle.)	(30) *3

Note: Power supply cords of appliances shall not be lighter than design 60245 IEC or 227 IEC.

*1 In the case that cable with stripe of yellow and green is available.

*2 In the case of regular polarity connection (S1-S2-S3), wire size is 1.5 mm².

*3 In the case of regular polarity connection (S1-S2-S3).

*4 In the case that flat cables are connected as this picture, they can be used up to 30 m.

*5 Mentioned cable length is just a reference value.

It may be different depending on the condition of installation, humidity or materials, etc.



Indoor/Outdoor separate power supply	Wire No. × Size (mm ²)
	Max. 120m
Indoor unit-Outdoor unit	2 × Min. 0.3
Indoor unit-Outdoor unit earth	—

Note: The optional indoor power supply terminal kit is necessary.

Be sure to connect the indoor-outdoor connecting cables directly to the units (no intermediate connections). Intermediate connections can lead to communication errors if water enters the cables and causes insufficient insulation to earth or a poor electrical contact at the intermediate connection point.

8-4. M-NET WIRING METHOD

Points to note:

- (1) Outside the unit, transmission wires should stay away from electric wires in order to prevent electromagnetic noise from making an influence on the signal communication. Place them at intervals of more than 5 cm. Do not put them in the same conduit tube.
- (2) Terminal block (TB7) for transmission wires should never be connected to 220–240 V power supply. If it is connected, electronic parts on M-NET P.C. board may burn out.
- (3) Use 2-core × 1.25 mm² shield wire (CVVS, CPEVS) for the transmission wire. Transmission signals may not be sent or received normally if different types of transmission wires are put together in the same multi-conductor cable. Never do this because this may cause a malfunction.

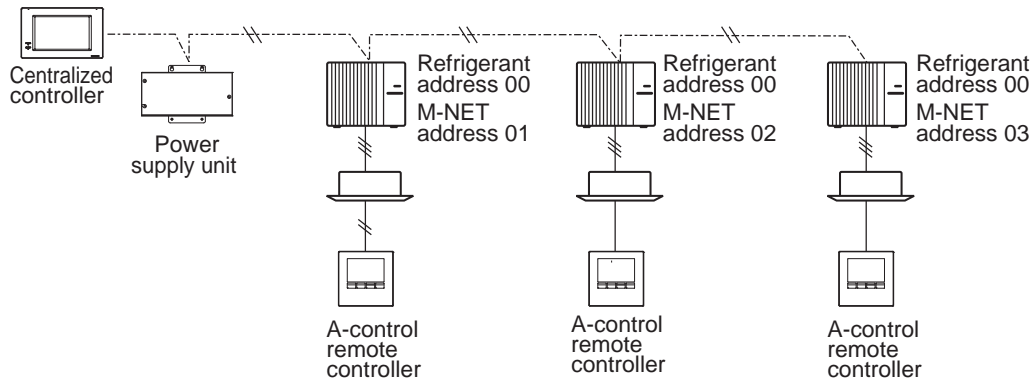

It is acceptable if M-NET wire (non-polar, 2-cores) is arranged in addition to the wiring for A-control.

- (4) Earth only one of any appliances through M-NET transmission wire (shield wire). Communication error may occur due to the influence of electromagnetic noise.

“Ed” error will appear on the LED display of outdoor unit.

“0403” error will appear on the centralized remote controller.

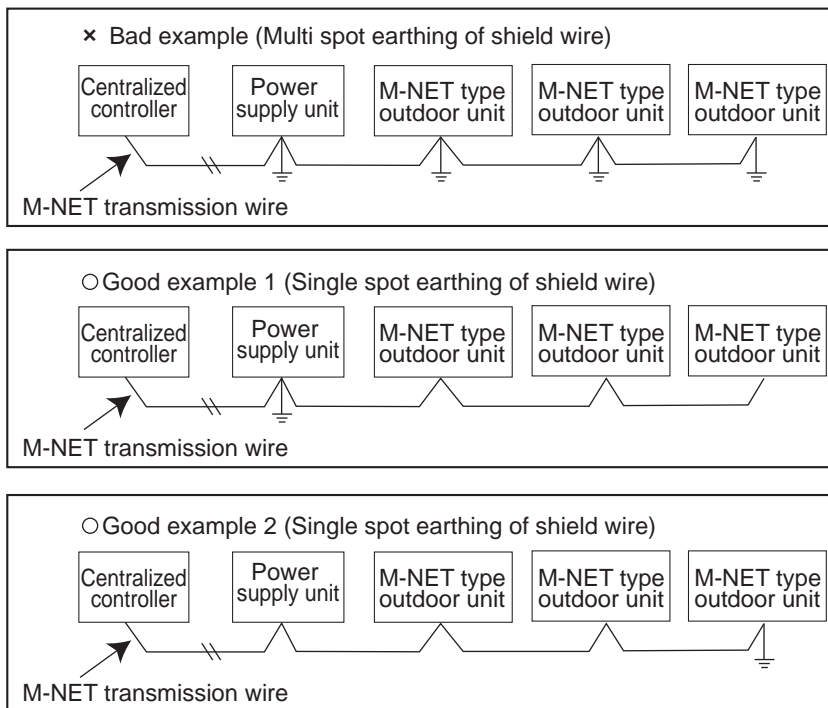

If there are more than 2 earthing spots on the shield wire, noise may enter into the shield wire because the earth wire and shield wire form 1 circuit and the electric potential difference occurs due to the impedance difference among earthing spots. In the case of single spot earthing, noise does not enter into the shield wire because the earth wire and shield wire do not form 1 circuit.

To avoid communication errors caused by noise, make sure to observe the single spot earthing method described in the installation manual.

• **M-NET wiring**

- (1) Use 2-core × 1.25 mm² shield wire for electric wires.
(Excluding the case connecting to system controller.)
- (2) Connect the wire to the M-NET terminal block. Connect one core of the transmission wire (non-polar) to A terminal and the other to B. Peel the shield wire, twist the shield part to a string and connect it to S terminal.
- (3) In the system which several outdoor units are being connected, the terminal (A, B, S) on M-NET terminal block should be individually wired to the other outdoor unit's terminal, i.e. A to A, B to B and S to S. In this case, choose one of those outdoor units and drive a screw to fix an earth wire on the plate as shown on the right figure.

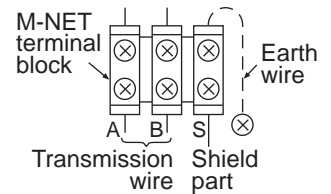

8-4-1. M-NET address setting

In A-control models, M-NET address and refrigerant address should be set only for the outdoor unit. Similar to CITY MULTI system, there is no need to set the address of outdoor unit and remote controller. To construct a central control system, the setting of M-NET address should be conducted only upon the outdoor unit. The setting range should be 1 to 50 (the same as that of the indoor unit in CITY MULTI system), and the address number should be consecutively set in a same group.

Address number can be set by using rotary switches (SW11 for 1s digit and SW12 for 10s digit), which is located on the M-NET board of outdoor unit. (Initial setting: all addresses are set to "0".)

<Setting example>

M-NET Address No.	1	2	...	50
SW11 1s digit			...	
SW12 10s digit			...	

8-4-2. Refrigerant address setting

In the case of multiple grouping system (multiple refrigerant circuits in 1 group), indoor units should be connected by remote controller wiring (TB5) and the refrigerant address needs to be set. Leave the refrigerant addresses to "00" if the group setting is not conducted. Set the refrigerant address by using DIP SW1-3 to -6 on the outdoor controller board. [Initial setting: all switches are OFF. (All refrigerant addresses are "00".)]

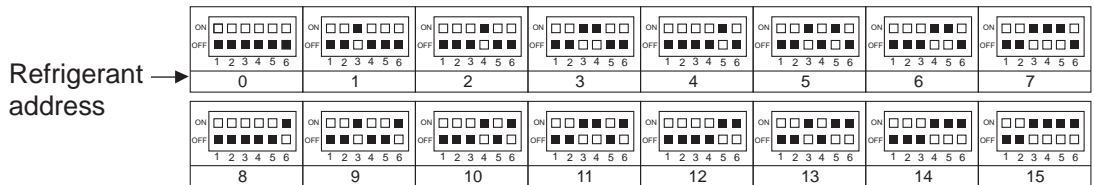

8-4-3. Regulations in address settings

In the case of multiple grouping system, M-NET and refrigerant address settings should be done as explained in the above section. Set the lowest number in the group for the outdoor unit whose refrigerant address is "00" as its M-NET address.

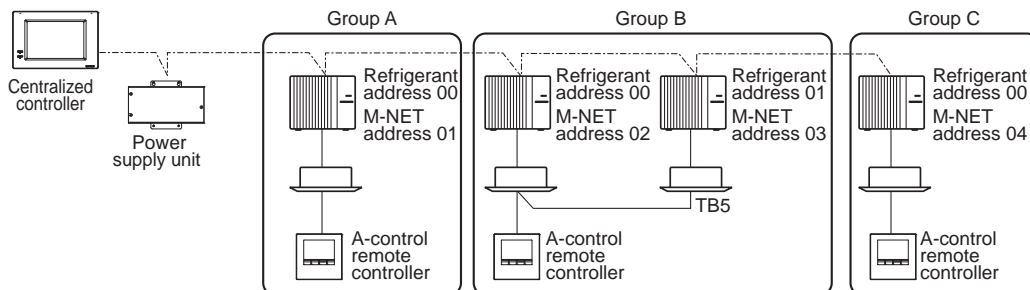

Refrigerant addresses can be overlapped if they are in the different group.

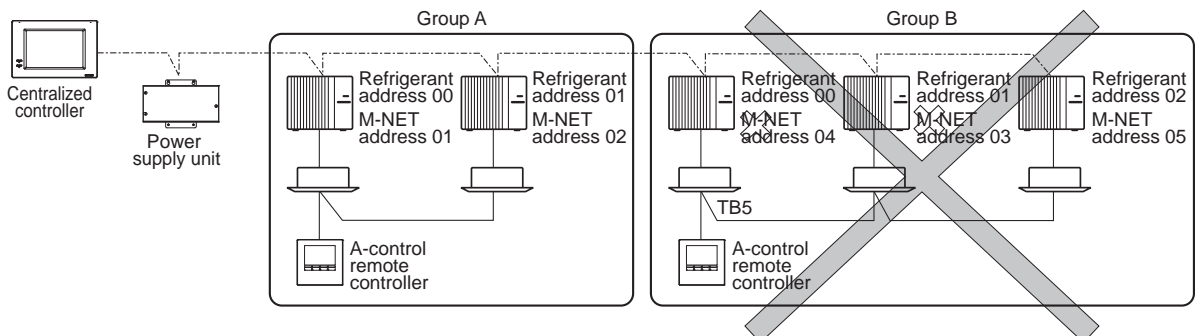

Note: In group B, M-NET address of the outdoor unit whose refrigerant address is "00" is not set to the minimum in the group. As "3" is right for this situation, the setting is wrong. Taking group A as a good sample, set the minimum M-NET address in the group for the outdoor unit whose refrigerant address is "00".

PUZ-M200YKA.UK

PUZ-M250YKA.UK

Unit: mm

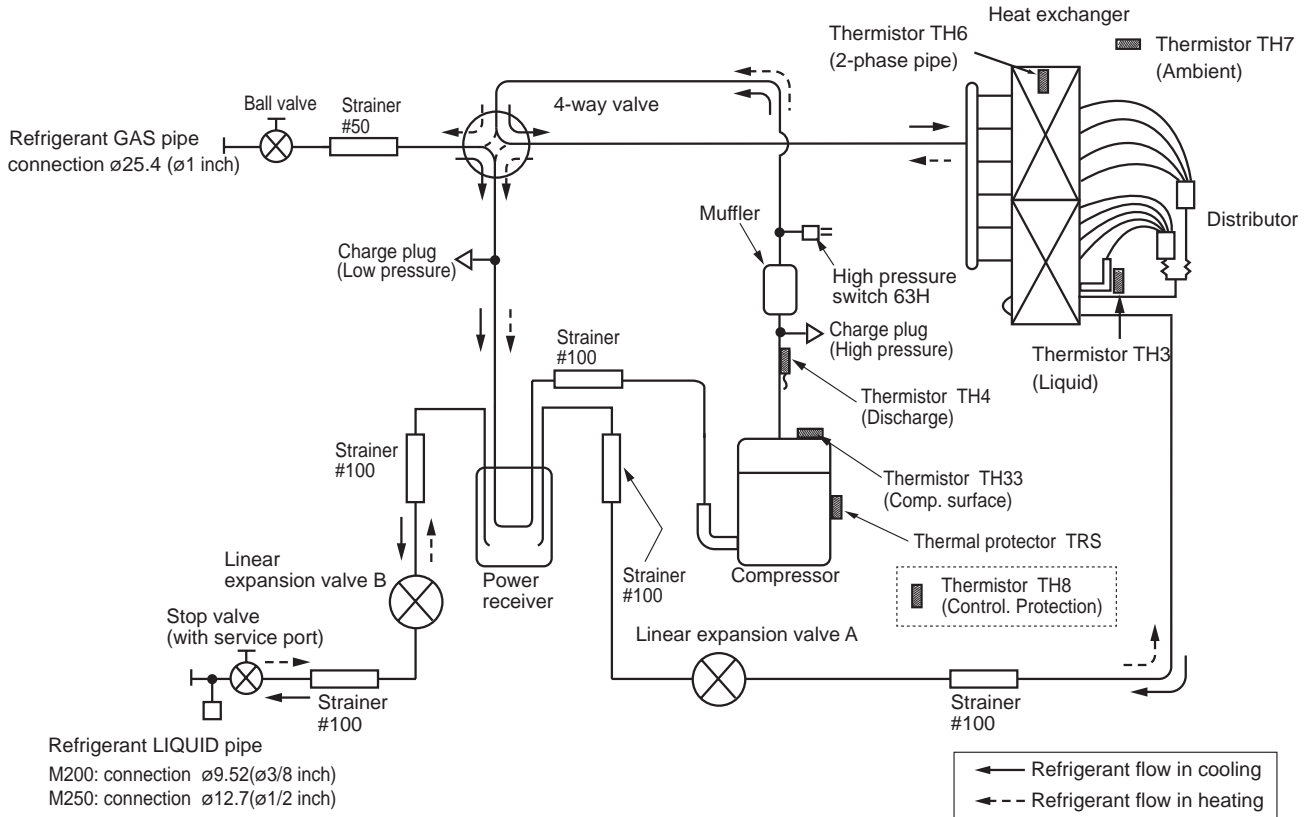

9-1. REFRIGERANT COLLECTING (PUMP DOWN)

When relocating or disposing of the indoor/outdoor unit, pump down the system following the procedure below so that no refrigerant is released into the atmosphere.

- ① Turn off the power supply (circuit breaker).
- ② Connect the low pressure valve on the gauge manifold to the charge plug (low pressure side) on the outdoor unit.
- ③ Close the liquid stop valve completely.
- ④ Supply power (circuit breaker).
 - When power is supplied, make sure that “Centrally controlled” is not displayed on the remote controller. If “Centrally controlled” is displayed, the refrigerant collecting (pump down) cannot be completed normally.
 - Startup of the indoor-outdoor communication takes about 3 minutes after the power (circuit breaker) is turned on. Start the pump-down operation 3 to 4 minutes after the power (circuit breaker) is turned on.
- ⑤ Perform the refrigerant collecting operation (cooling test run).
 - Push the pump-down SWP switch (push-button type) on the control board of the outdoor unit. The compressor and ventilators (indoor and outdoor units) start operating (refrigerant collecting operation begins). (LED1 and LED2 on the control board of the outdoor unit are lit.)
 - Only push the pump-down SWP switch if the unit is stopped. However, even if the unit is stopped and the pump-down SWP switch is pushed less than 3 minutes after the compressor stops, the refrigerant collecting operation cannot be performed. Wait until the compressor has been stopped for 3 minutes and then push the pump-down SWP switch again.
- ⑥ Fully close the ball valve on the gas pipe side of the outdoor unit when the pressure gauge on the gauge manifold shows 0.05 to 0 MPa [Gauge] (approx. 0.5 to 0 kgf/cm²) and quickly stop the air conditioner.
 - Because the unit automatically stops in about 3 minutes when the refrigerant collecting operation is completed (LED1 off, LED2 lit), be sure to quickly close the gas ball valve. However, if LED1 is lit, LED2 is off, and the unit is stopped, open the liquid stop valve completely, close the valve completely after 3 minutes or more have passed, and then repeat step ⑤. (Open the gas ball valve completely.)
 - If the refrigerant collecting operation has been completed normally (LED1 off, LED2 lit), the unit will remain stopped until the power supply is turned off.
 - Note that when the extension piping is very long with a large refrigerant amount, it may not be possible to perform a pump down operation. In this case, use refrigerant recovery equipment to collect all of the refrigerant in the system.
- ⑦ Turn off the power supply (circuit breaker), remove the gauge manifold, and then disconnect the refrigerant pipes.

⚠ Warning:

When pumping down the refrigerant, stop the compressor before disconnecting the refrigerant pipes.

- **If the refrigerant pipes are disconnected while the compressor is operating and the stop valve (ball valve) is open, the pressure in the refrigeration cycle could become extremely high if air is drawn in, causing the pipes to burst, personal injury, etc.**

9-2. START AND FINISH OF TEST RUN

- Operation from the indoor unit
Execute the test run using the installation manual for the indoor unit.
- Operation from the outdoor unit
By using the DIP switch SW4 on the control board of outdoor unit, test run can be started and finished, and its operation mode (cooling/heating) can be set up.

- ① Set the operation mode (cooling/heating) using SW4-2.
- ② Turn on SW4-1 to start test run with the operation mode set by SW4-2.
- ③ Turn off SW4-1 to finish the test run.

- There may be a faint knocking sound around the machine room after power is supplied. However, this is not a problem with product because the linear expansion pipe is just moving to adjust opening pulse.
- There may be a knocking sound around the machine room for several seconds after compressor starts operating. However, this is not a problem with product because it is generated by the check valve itself due to a small pressure difference in the refrigerant circuit.

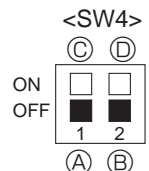

- Ⓐ Stop Ⓒ Operation
- Ⓑ Cooling Ⓓ Heating

Note:

The operation mode cannot be changed by SW4-2 during test run. (To change test run mode, stop the unit by SW4-1, change the operation mode and restart the test run by SW4-1.)

10-1. TROUBLESHOOTING

<Check code displayed by self-diagnosis and actions to be taken for service (summary)>

Present and past check codes are logged, and they can be displayed on the control board of outdoor unit. Actions to be taken for service, which depends on whether or not the trouble is reoccurring in the field, are summarized in the table below. Check the contents below before investigating details.

Unit conditions at service	Check code	Actions to be taken for service (summary)
The trouble is reoccurring.	Displayed	Judge the problem and take a corrective action according to "10-4. SELF-DIAGNOSIS ACTION TABLE".
	Not displayed	Conduct troubleshooting and ascertain the cause of the trouble according to "10-5. TROUBLESHOOTING OF PROBLEMS".
The trouble is not reoccurring.	Logged	①Consider the temporary defects such as the work of protection devices in the refrigerant circuit including compressor, poor connection of wiring, noise, etc. Re-check the symptom, and check the installation environment, refrigerant amount, weather when the trouble occurred, matters related to wiring, etc. ②Reset check code logs and restart the unit after finishing service. ③There is no abnormality in electrical component, controller board, remote controller, etc.
	Not logged	①Re-check the abnormal symptom. ②Conduct troubleshooting and ascertain the cause of the trouble according to "10-5. TROUBLESHOOTING OF PROBLEMS". ③Continue to operate unit for the time being if the cause is not ascertained. ④There is no abnormality concerning of parts such as electrical component, controller board, remote controller, etc.

10-2. CHECK POINT UNDER TEST RUN

10-2-1. Before test run

- After installation of indoor and outdoor units, piping work and electric wiring work, re-check that there is no refrigerant leakage, loosened connections and incorrect polarity.
- Measure impedance between the ground and the power supply terminal block (L, N) on the outdoor unit by 500 V Megger and check that it is 1.0 MΩ or over.
- Do not use 500 V Megger to indoor/outdoor connecting wire terminal block (S1, S2, S3) and remote controller terminal block (1, 2). This may cause malfunction.
- Make sure that test run switch (SW4) is set to OFF before turning on power supply.
- Turn on power supply 12 hours before test run in order to protect compressor.
- For specific models which require higher ceiling settings or auto-recovery feature from power failure, make proper changes of settings referring to the description of "11. FUNCTION SETTING".

Make sure to read operation manual before test run. (Especially items to secure safety.)

10-2-2. Test run for wired remote controller <PAR-4xMAA ("x" represents 0 or later)>

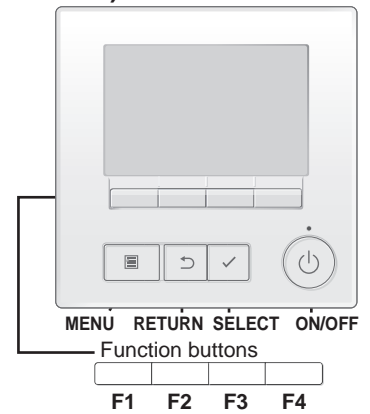

① Select "Service" from the Main menu, and press the [✓] button.



Select "Test run" with the [F1] or [F2] button, and press the [✓] button.

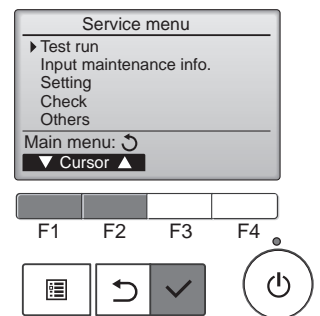

② Select "Test run" with the [F1] or [F2] button, and press the [✓] button.

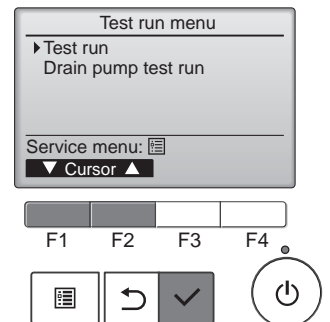

Test run operation

Press the [F1] button to go through the operation modes in the order of "Cool and Heat".

Cool mode: Check the cold air blows out.
Heat mode: Check the heat blows out.

Check the operation of the outdoor unit's fan.



Press the [✓] button and open the Vane setting screen.

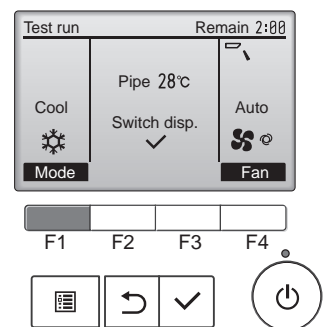

Auto vane check

Check the auto vane with the [F1] [F2] buttons.



Press the [↻] button to return to "Test run operation".



Press the [ON/OFF] button.

When the test run is completed, the "Test run menu" screen will appear.
The test run will automatically stop after 2 hours.

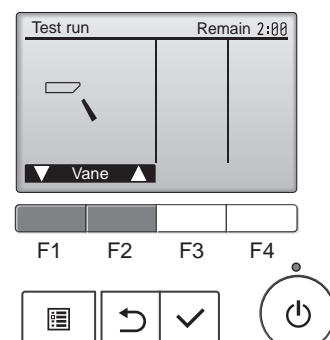

<Error information>

When an error occurs, the following screen will appear.
Check the error status, stop the operation, and consult your dealer.

- ① Check code, error unit, refrigerant address, unit model name, and serial number will appear. (Date and time of occurrence of the error will also appear on PAR-4xMAA.)
The model name and serial number will appear only if the information have been registered.

Press the **F1** or **F2** button to go to the next page.

Error information 1/2
 Error code A3
 Error unit IU 0 Unit#1
 Time Occurred 02/01 4:48
 Model name
 Serial No.
 Reset error: Reset button
 ▼ Page ▲ Reset



Contact information (dealer's phone number) will appear if the information has been registered.

Error information 2/2
 Contact information
 Dealer
 Tel
 Reset error: Reset button
 ▼ Page ▲ Reset

- ② Press the **F4** button or the button to reset the error that is occurring.

Errors cannot be reset while the ON/OFF operation is prohibited.

Error information 1/2
 Error code A3
 Error unit IU 0 Unit#1
 Time Occurred 02/01 4:48
 Model name
 Serial No.
 Reset error: Reset button
 ▼ Page ▲ Reset

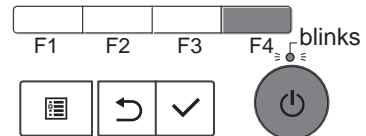

Select "OK" with the **F4** button.

Error reset
 Reset current error?
 Cancel OK

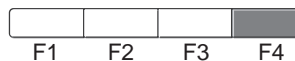

Error reset
 Error reset
 Main menu:

Navigating through the screens

- To go back to the Main menu [] button

<Checking the error information>

While no errors are occurring, page 2/2 of the error information can be viewed by selecting "Error information" from the Maintenance menu. Errors cannot be reset from this screen.

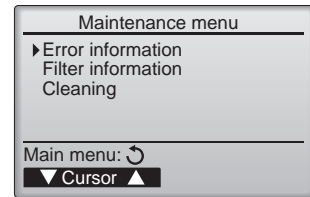

<Error history>

- ① Select "Service" from the Main menu, and press the [✓] button.



Select "Check" with the [F1] or [F2] button, and press the [✓] button.

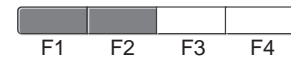
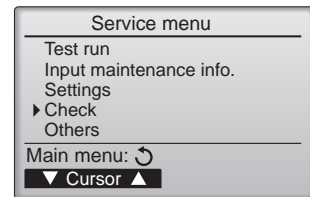

- ② Select "Error history" with the [F1] or [F2] button, and press the [✓] button.

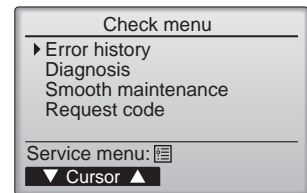

Error history

- ③ Select "Error history" from the Check menu, and press the [✓] button to view up to 16 error history records.

4 records are shown per page, and the top record on the first page indicates the latest error record.

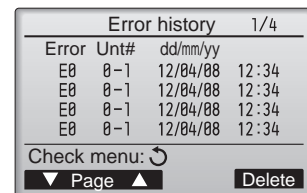

Deleting the error history

- ④ To delete the error history, press the [F4] button (Delete) on the screen that shows error history.

A confirmation screen will appear asking if you want to delete the error history.



Press the [F4] button (OK) to delete the history.







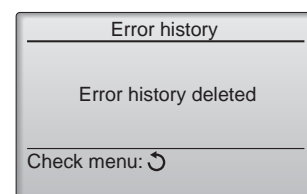
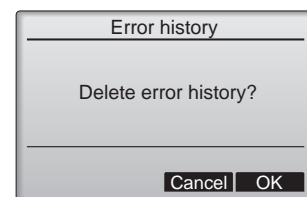





"Error history deleted" will appear on the screen.

Press the [↻] button to go back to the Check menu screen.



10-2-3. Test run for wireless remote controller (Type C)

Measure an impedance between the power supply terminal block on the outdoor unit and ground with a 500V Megger and check that it is equal to or greater than 1.0MΩ.







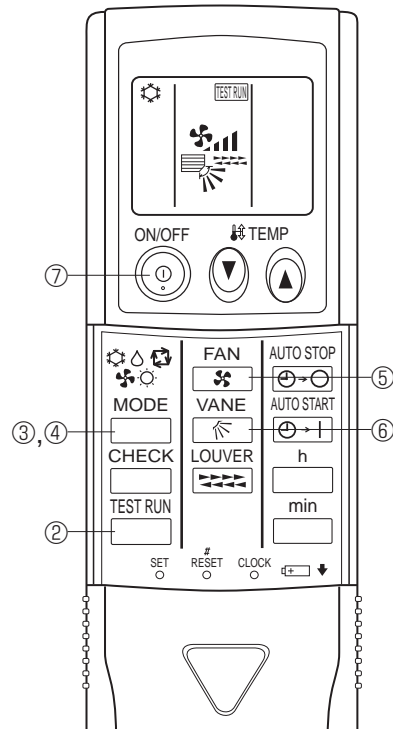







- ① Turn on the main power to the unit.
- ② Press the  button twice continuously.
(Start this operation from the status of remote controller display turned off.)
A  and current operation mode are displayed.
- ③ Press the  () button to activate  mode, then check whether cool air blows out from the unit.
- ④ Press the  () button to activate  mode, then check whether warm air blows out from the unit.
- ⑤ Press the  button and check whether strong air blows out from the unit.
- ⑥ Press the  button and check whether the auto vane operates properly.
- ⑦ Press the ON/OFF button to stop the test run.

Note:

- Point the remote controller towards the indoor unit receiver while following steps ② to ⑦.
- It is not possible to run in FAN, DRY or AUTO mode.



10-2-4. Test run for wireless remote controller <PAR-SL100A-E>

1. Press the  button ① to stop the air conditioner.
 - If the weekly timer is enabled ( is on), press the  button ③ to disable it ( is off).
2. Press the  button ② for 5 seconds.
 -  comes on and the unit enters the service mode.
3. Press the  button ②.
 -  ③ comes on and the unit enters the test run mode.
4. Press the following buttons to start the test run.
 -  : Switch the operation mode between cooling and heating and start the test run.
 -  : Switch the fan speed and start the test run.
 -  : Switch the airflow direction and start the test run.
 -  : Switch the louver and start the test run.
 -  : Start the test run.
5. Stop the test run.
 - Press the  button ① to stop the test run.
 - After 2 hours, the stop signal is transmitted.

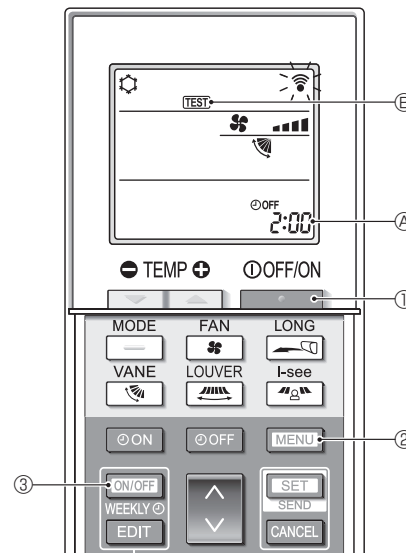



10-3. HOW TO PROCEED "SELF-DIAGNOSIS"

10-3-1. Self-diagnosis <PAR-4xMAA ("x" represents 0 or later)>

① Select "Service" from the Main menu, and press the [✓] button.

Select "Check" from the Service menu, and press the [✓] button.

Select "Diagnosis" from the Check menu, and press the [✓] button.

Select "Self check" with the [F1] or [F2] button, and press the [✓] button.

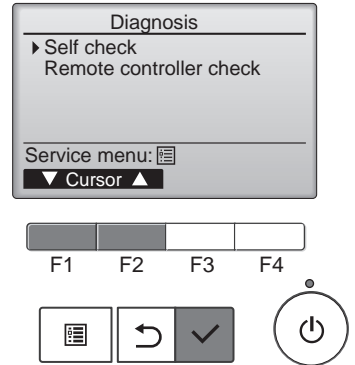

② With the [F1] or [F2] button, enter the refrigerant address, and press the [✓] button.

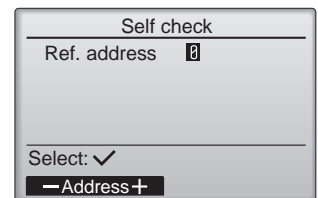

③ Check code, unit number, attribute will appear. "-" will appear if no error history is available.

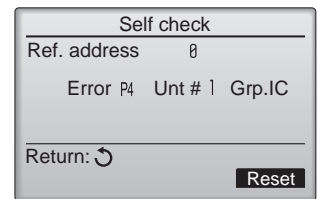

When there is no error history

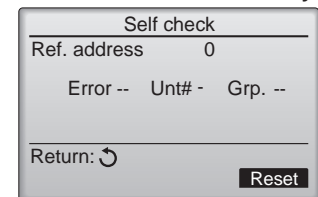

④ Resetting the error history

Press the [F4] button (Reset) on the screen that shows the error history.



A confirmation screen will appear asking if you want to delete the error history.

Press the [F4] button (OK) to delete the error history.

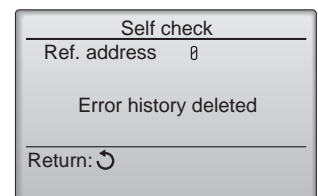
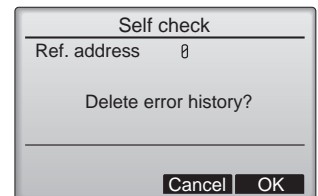
If deletion fails, "Request rejected" will appear. "Unit not exist" will appear if no indoor units that are correspond to the entered address are found.



Navigating through the screens

- To go back to the Service menu [] button
- To return to the previous screen..... [] button

10-3-2. Remote controller check <PAR-4xMAA ("x" represents 0 or later)>

If operations cannot be completed with the remote controller, diagnose the remote controller with this function.

- ① Select "Service" from the Main menu, and press the [✓] button.



Select "Check" from the Service menu, and press the [✓] button.



Select "Diagnosis" from the Check menu, and press the [✓] button.



Select "Remote controller check" with the [F1] or [F2] button, and press the [✓] button.

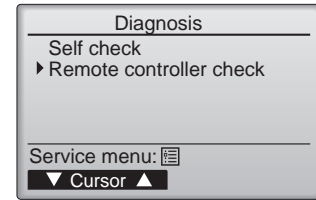

- ② Select "Remote controller check" from the Diagnosis menu, and press the [✓] button to start the remote controller check and see the check results.



To cancel the remote controller check and exit the "Remote controller check" menu screen, press the [List] or the [Refresh] button.



The remote controller will not reboot itself.

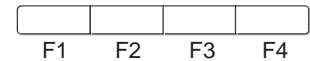
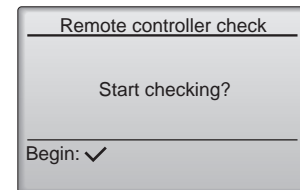

- ③
- OK: No problems are found with the remote controller. Check other parts for problems.
 - E3, 6832: There is noise on the transmission line, or the indoor unit or another remote controller is faulty. Check the transmission line and the other remote controllers.
 - NG (ALLO, ALL1): Send-receive circuit fault. The remote controller needs replacing.
 - ERC: The number of data errors is the discrepancy between the number of bits in the data transmitted from the remote controller and that of the data that was actually transmitted over the transmission line. If data errors are found, check the transmission line for external noise interference.



If the [✓] button is pressed after the remote controller check results are displayed, remote controller check will end, and the remote controller will automatically reboot itself.

Remote controller check results screen

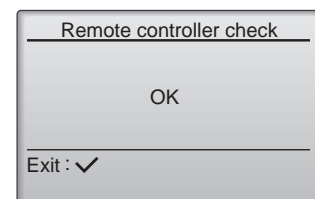

Check the remote controller display and see if anything is displayed (including lines). Nothing will appear on the remote controller display if the correct voltage (8.5–12 V DC) is not supplied to the remote controller. If this is the case, check the remote controller wiring and indoor units.

10-3-3. Self-diagnosis for wireless remote controller (Type C)

When a malfunction occurs to air conditioner, both indoor unit and outdoor unit will stop and operation lamp blinks to inform unusual stop.

<Malfunction-diagnosis method at maintenance service>

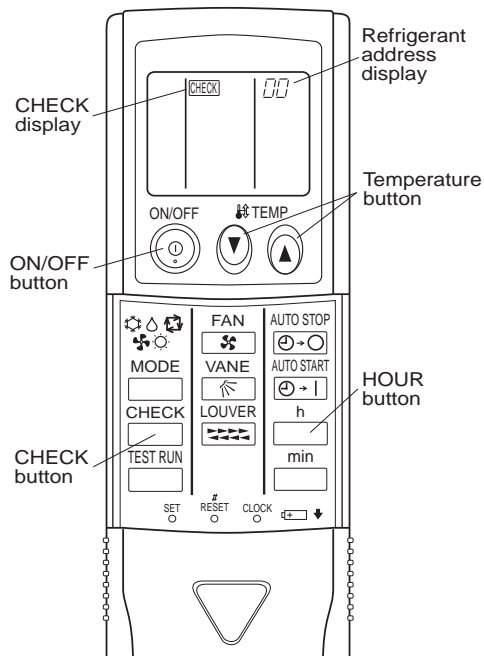

[Procedure]

1. Press the CHECK button twice.
 - "CHECK" lights, and refrigerant address "00" blinks.
 - Check that the remote controller's display has stopped before continuing.
2. Press the TEMP (TEMP) buttons.
 - Select the refrigerant address of the indoor unit for the self-diagnosis.
 - Note: Set refrigerant address using the outdoor unit's DIP switch (SW1). (For more information, see the outdoor unit installation manual.)
3. Point the remote controller at the sensor on the indoor unit and press the HOUR button.
 - If an air conditioner error occurs, the indoor unit's sensor emits an intermittent buzzer sound, the operation light blinks, and the check code is output. (It takes 3 seconds at most for check code to appear.)
4. Point the remote controller at the sensor on the indoor unit and press the ON/OFF button.
 - The check mode is cancelled.

10-3-4. Self-diagnosis for wireless remote controller (PAR-SL100A-E)

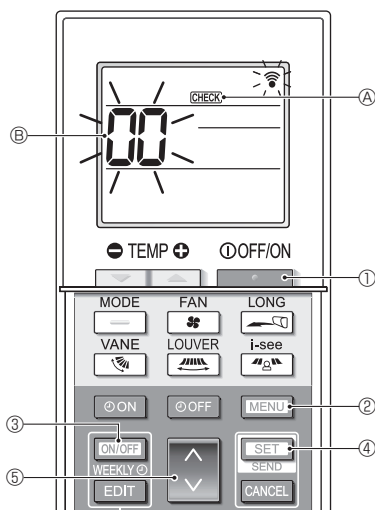

1. Press the [OFF/ON] button ① to stop the air conditioner.
 - If the weekly timer is enabled (WEEKLY is on), press the [ON/OFF WEEKLY] button ③ to disable it (WEEKLY is off).
2. Press the [MENU] button ② for 5 seconds.
 - [CHECK] (A) comes on and the unit enters the self-check mode.
3. Press the [ON/OFF] button ③ to select the refrigerant address (M-NET address) ② of the indoor unit for which you want to perform the self-check.
4. Press the [SET] button ④.
 - If an error is detected, the check code is indicated by the number of beeps from the indoor unit and the number of blinks of the OPERATION INDICATOR lamp.
5. Press the [OFF/ON] button ①.
 - [CHECK] (A) and the refrigerant address (M-NET address) ② go off and the self-check is completed.

• Refer to the following tables for details on the check codes.

[Output pattern A]

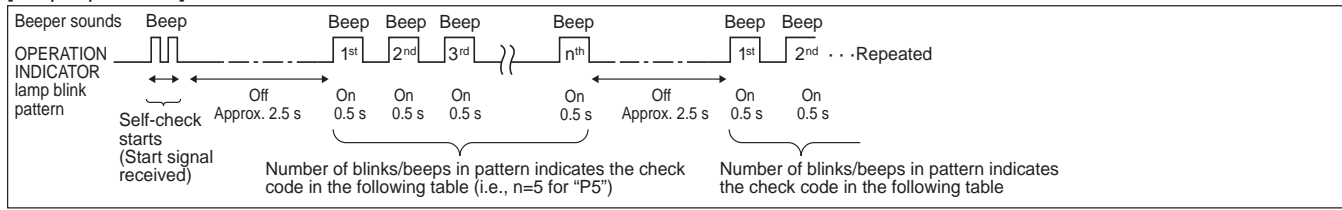

[Output pattern B]

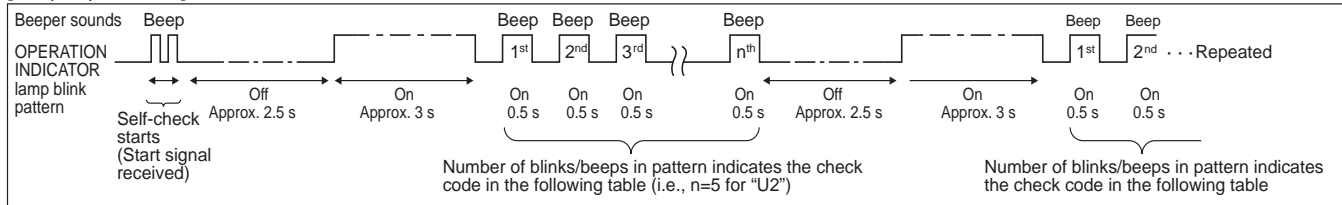

[Output pattern A] Errors detected by indoor unit

Wireless remote controller Beeper sounds/OPERATION INDICATOR lamp blinks (Number of times)	Wired remote controller Check code	Symptom	Remark
1	P1	Intake sensor error	As for indoor unit, refer to indoor unit's service manual.
2	P2	Pipe (TH2) sensor error	
	P9	Pipe (TH5) sensor error	
3	E6, E7	Indoor/outdoor unit communication error	
4	P4	Drain sensor error/Float switch connector (CN4F) open	
	P5	Drain pump error	
5	PA	Forced compressor stop (due to water leakage abnormality)	
6	P6	Freezing/Overheating protection operation	
7	EE	Combination error between indoor and outdoor units	
8	P8	Pipe temperature error	
9	E4, E5	Remote controller signal receiving error	
10	-	-	
11	Pb	Indoor unit fan motor error	
12	Fb (FB)*	Indoor unit control system error (memory error, etc.)	
14	PL	Abnormality of refrigerant circuit	
-	E0, E3	Remote controller transmission error	
-	E1, E2	Remote controller control board error	

[Output pattern B] Errors detected by unit other than indoor unit (outdoor unit, etc.)

Wireless remote controller Beeper sounds/OPERATION INDICATOR lamp blinks (Number of times)	Wired remote controller Check code	Symptom
1	E9	Indoor/outdoor unit communication error (Transmitting error) (Outdoor unit)
2	UP	Compressor overcurrent interruption
3	U3, U4	Open/short of outdoor unit thermistors
4	UF	Compressor overcurrent interruption (When compressor locked)
5	U2	Abnormal high discharging temperature/insufficient refrigerant
6	U1, Ud (UD)*	Abnormal high pressure (63H operated)/High compressor temperature (TRS operated) /Overheating protection operation
7	U5	Abnormal temperature of heat sink
8	U8	Outdoor unit fan protection stop
9	U6	Compressor overcurrent interruption/Abnormal of power module
10	U7	Abnormality of superheat due to low discharge temperature
11	U9, UH	Abnormality such as overvoltage or voltage shortage and abnormal synchronous signal to main circuit/Current sensor error
12	-	-
13	-	-
14	Others	Other errors (Refer to the technical manual for the outdoor unit.)

Notes: 1. If the beeper does not sound again after the initial 2 beeps to confirm the self-check start signal was received and the OPERATION INDICATOR lamp does not come on, there are no error records.

2. If the beeper sounds 3 times continuously "beep, beep, beep (0.4 + 0.4 + 0.4 seconds)" after the initial 2 beeps to confirm the self-check start signal was received, the specified refrigerant address is incorrect.

*The check code in the parenthesis indicates PAR-4xMAA model ("x" represents 0 or later).

10-4. SELF-DIAGNOSIS ACTION TABLE

<Abnormalities detected when the power is put on>

Note: Refer to indoor unit section for codes starting with P and E.

Check Code	Abnormal points and detection method	Cause	Judgment and action
None	—	<p>① No voltage is supplied to terminal block (TB1) of outdoor unit. a) Power supply breaker is turned off. b) Contact failure or disconnection of power supply terminal c) Open phase (L2 or N phase)</p> <p>② Electric power is not supplied to power supply terminal of outdoor power circuit board. a) Contact failure of power supply terminal b) Open phase on the outdoor power circuit board (Disconnection of terminal on outdoor power circuit board)</p> <p>③ Electric power is not supplied to outdoor controller circuit board. a) Disconnection of connector (CNDC)</p> <p>④ Disconnection of reactor (DCL or ACL4)</p> <p>⑤ Disconnection of outdoor noise filter circuit board or parts failure in outdoor noise filter circuit board.</p> <p>⑥ Defective outdoor power circuit board</p> <p>⑦ Open of rush current protect resistor (RS)</p> <p>⑧ Defective outdoor controller circuit board</p>	<p>① Check following items. a) Power supply breaker b) Connection of power supply terminal block. (TB1) c) Connection of power supply terminal block. (TB1)</p> <p>② Check following items. a) Connection of power supply terminal block. (TB1) b) Connection of terminal on outdoor power circuit board</p> <p>③ Check connection of the connector (CNDC) on the outdoor controller circuit board. Check connection of the connector CNDC on the noise filter circuit board. Refer to "10-9. TEST POINT DIAGRAM".</p> <p>④ Check connection of reactor. (DCL or ACL4) Refer to "7. WIRING DIAGRAM".</p> <p>⑤ a) Check connection of outdoor noise filter circuit board. b) Replace outdoor noise filter circuit board. Refer to "10-9. TEST POINT DIAGRAM".</p> <p>⑥ Replace outdoor power circuit board.</p> <p>⑦ Replace rush current protect resistor (RS). Power circuit board might be short-circuit. Check the power circuit board. (Refer to "10-9. TEST POINT DIAGRAM".)</p> <p>⑧ Replace controller board (When items above are checked but the units cannot be repaired.)</p>
F5 (5201)	<p>63H or TRS connector open Abnormal if 63H or TRS connector circuit is open for 3 minutes continuously after power supply. 63H: High pressure switch TRS:Thermal protector</p>	<p>① Disconnection or contact failure of 63H or TRS connector on outdoor controller circuit board</p> <p>② Disconnection or contact failure of 63H or TRS</p> <p>③ 63H or TRS is working due to defective parts.</p> <p>④ Defective outdoor controller circuit board</p>	<p>① Check connection of 63H and TRS connector on outdoor controller circuit board. Refer to "10-9. TEST POINT DIAGRAM".</p> <p>② Check the 63H and TRS side of connecting wire.</p> <p>③ Check continuity by tester. Replace the parts if the parts are defective.</p> <p>④ Replace outdoor controller circuit board.</p>



Check Code	Abnormal points and detection method	Cause	Judgment and action
EA (6844)	<p>Miswiring of indoor/outdoor unit connecting wire</p> <p>1. Outdoor controller circuit board can automatically check the number of connected indoor units. Abnormal if the number cannot be checked automatically due to miswiring of indoor/outdoor unit connecting wire, etc. after power is turned on for 4 minutes.</p> <p>2. Abnormal if outdoor controller circuit board recognizes excessive number of indoor units.</p>	<p>① Contact failure or miswiring of indoor/outdoor unit connecting wire</p> <p>② Diameter or length of indoor/outdoor unit connecting wire is out of specified capacity.</p> <p>③ Excessive number of indoor units are connected to 1 outdoor unit. (4 units or more)</p> <p>④ Defective transmitting receiving circuit of outdoor controller circuit board</p> <p>⑤ Defective transmitting receiving circuit of indoor controller board</p> <p>⑥ Defective indoor power board</p> <p>⑦ 2 or more outdoor units have refrigerant address "0" . (In the case of group control)</p> <p>⑧ Noise has entered into power supply or indoor/outdoor unit connecting wire.</p>	<p>① Check disconnection or looseness or polarity of indoor/outdoor unit connecting wire of indoor and outdoor units.</p> <p>② Check diameter and length of indoor/outdoor unit connecting wire. Total wiring length: 80 m (including wiring connecting each indoor unit and between indoor and outdoor unit) Also check if the connection order of flat cable is S1, S2, S3.</p> <p>③ Check the number of indoor units that are connected to one outdoor unit. (If EA is detected)</p> <p>④—⑥ Turn the power off once, and on again to check. Replace outdoor controller circuit board, indoor controller board or indoor power board if abnormality occurs again.</p>
Eb (6845)	<p>Miswiring of indoor/outdoor unit connecting wire (converse wiring or disconnection)</p> <p>Outdoor controller circuit board can automatically set the unit number of indoor units.</p> <p>Abnormal if the indoor unit number can not be set within 4 minutes after power on because of miswiring (converse wiring or disconnection) of indoor/outdoor unit connecting wire.</p>	<p>① Contact failure or miswiring of indoor/outdoor unit connecting wire</p> <p>② Diameter or length of indoor/outdoor unit connecting wire is out of specified capacity.</p> <p>④ Defective transmitting receiving circuit of outdoor controller circuit board</p> <p>⑤ Defective transmitting receiving circuit of indoor controller board</p> <p>⑥ Defective indoor power board</p> <p>⑦ 2 or more outdoor units have refrigerant address "0" . (In the case of group control)</p> <p>⑧ Noise has entered into power supply or indoor/outdoor unit connecting wire.</p>	<p>⑦ Check if refrigerant addresses (SW1-3 to SW1-6 on outdoor controller circuit board) are overlapping in the case of group control system.</p> <p>⑧ Check transmission path, and remove the cause.</p> <p>Note: The descriptions above, ①—⑧, are for EA, Eb and EC.</p>
EC (6846)	<p>Startup time over</p> <p>The unit cannot finish Startup process within 4 minutes after power on.</p>	<p>① Contact failure of indoor/outdoor unit connecting wire</p> <p>② Diameter or length of Indoor/outdoor unit connecting wire is out of specified capacity.</p> <p>③ 2 or more outdoor units have refrigerant address "0" . (In the case of group control)</p> <p>④ Noise has entered into power supply or indoor/outdoor unit connecting wire.</p>	

<Abnormalities detected while unit is operating>

Check Code	Abnormal points and detection method	Cause	Judgment and action
U1 (1302)	<p>High pressure(High pressure switch 63H operated)/High compressor temperature (Thermal protector TRS operated) Abnormal if high pressure switch 63H(4.15MPa) or thermal protector TRS(130°C) operated during compressor operation</p>	<p>① Short cycle of indoor unit ② Clogged filter of indoor unit ③ Decreased airflow caused by dirt of indoor fan ④ Dirt of indoor heat exchanger ⑤ Locked indoor fan motor ⑥ Malfunction of indoor fan motor ⑦ Defective operation of stop valve (Not full open) ⑧ Clogged or broken pipe ⑨ Locked outdoor fan motor ⑩ Malfunction of outdoor fan motor ⑪ Short cycle of outdoor unit ⑫ Dirt of outdoor heat exchanger ⑬ Decreased airflow caused by defective inspection of outside temperature thermistor (It detects lower temperature than actual temperature.) ⑭ Disconnection or contact failure of connector (63H or TRS) on outdoor controller board ⑮ Disconnection or contact failure of 63H or TRS connection ⑯ Defective outdoor controller board ⑰ Defective action of linear expansion valve ⑱ Malfunction of fan driving circuit ⑲ Overheated compressor operation caused by shortage of refrigerant ⑳ Defective operation of stop valve</p>	<p>①-⑥ Check indoor unit and repair defect. ⑦ Check if stop valve is fully open. ⑧ Check piping and repair defect. ⑨-⑫ Check outdoor unit and repair defect. ⑬ Check the detected temperature of outside temperature thermistor on LED display. (SW2 on A-Control Service Tool : Refer to "10-10. FUNCTION OF SWITCHES, CONNECTORS AND JUMPERS".) ⑭-⑮ Turn the power off and check if F5 is displayed when the power is turned on again. When F5 is displayed, refer to "Judgment and action" for F5. ⑰ Check linear expansion valve. Refer to "10-6. HOW TO CHECK THE PARTS". ⑱ Replace outdoor controller board. ⑲ Check intake superheat. Check leakage of refrigerant. Charge additional refrigerant. ⑳ Check if stop valve is fully open.</p>
U2 (TH4:1102) (TH33:1132)	<p>High comp. surface temperature 1. Abnormal if comp. surface temperature thermistor (TH4/TH33) exceeds 117°C or 110°C continuously for 5 minutes. Abnormal if condenser/evaporator temperature thermistor (TH5) exceeds 40°C during defrosting and comp. surface temperature thermistor (TH4/TH33) exceeds 110°C. 2. Abnormal if discharge superheat (Cooling: TH4/TH33-TH6 / Heating: TH4/TH33-TH5) increases. All the conditions in A or B are detected simultaneously for 10 minutes continuously after 6 minutes past from compressor Startup (including the thermostat indication or recovery from defrosting). <Condition A> • Heating mode • When discharge superheat is less than 70°C. • When the TH6 temp is more than the value obtained by TH7-5°C. • When the condensing temp of TH5 is less than 35°C. <Condition B> • During compressor operation (Cooling and Heating) • When discharge superheat is less than 80°C in Cooling. • When discharge superheat is less than 90°C in Heating. • When condensing temp of TH6 is more than -40°C. (In Cooling only.) 3. Abnormal if comp. surface temperature thermistor (TH4/TH33) exceeds 117°C or 110°C continuously for 5 minutes.</p>	<p>① Overheated compressor operation caused by shortage of refrigerant ② Defective operation of stop valve ③ Defective thermistor ④ Defective outdoor controller board ⑤ Defective action of linear expansion valve</p>	<p>① Check intake superheat. Check leakage of refrigerant. Charge additional refrigerant. ② Check if stop valve is fully open. ③④ Turn the power off and check if U3 is displayed when the power is on again. When U3 is displayed, refer to "Judgment and action" for U3. ⑤ Check linear expansion valve. Refer to "10-6. HOW TO CHECK THE PARTS".</p>
U3 (TH4:5104) (TH33:5132)	<p>Open/short circuit of discharge temperature thermistor (TH4)/comp. surface thermistor (TH33) Abnormal if open (-20°C or less) or short (≥17°C or more) is detected during compressor operation. (Detection is inoperative for 10 minutes of compressor starting process and for 10 minutes after and during defrosting.)</p>	<p>① Disconnection or contact failure of connector (TH4/TH33) on the outdoor controller circuit board ② Defective thermistor ③ Defective outdoor controller circuit board</p>	<p>① Check connection of connector (TH4/TH33) on the outdoor controller circuit board. Check breaking of the lead wire for thermistor (TH4/TH33). Refer to "10-9. TEST POINT DIAGRAM". ② Check resistance value of thermistor (TH4/TH33) or temperature by microprocessor. (Thermistor/TH32: Refer to "10-6. HOW TO CHECK THE PARTS".)(SW2 on A-Control Service Tool: Refer to "10-10. FUNCTION OF SWITCHES, CONNECTORS AND JUMPERS".) ③ Replace outdoor controller board.</p>



Check Code	Abnormal points and detection method	Cause	Judgment and action																								
U4 (TH3:5105) (TH6:5107) (TH7:5106) (TH8:5110)	<p>Open/short of outdoor unit thermistors (TH3, TH6, TH7, and TH8) Abnormal if open or short is detected during compressor operation. Open detection of thermistors TH3 and TH6 is inoperative for 10 seconds to 10 minutes after compressor starting and 10 minutes after and during defrosting. Note: Check which unit has abnormality in its thermistor by switching the mode of SW2. (PAC-SK52ST) (Refer to "10-10. FUNCTION OF SWITCHES, CONNECTORS AND JUMPERS".)</p>	<p>① Disconnection or contact failure of connectors (Outdoor controller circuit board: TH3, TH6/TH7 Outdoor power circuit board: CN3) </p> <p>② Defective thermistor</p> <p>③ Defective outdoor controller circuit board</p>	<p>① Check connection of connector (TH3,TH6/TH7) on the outdoor controller circuit board. Check connection of connector (CN3) on the outdoor power circuit board. Check breaking of the lead wire for thermistor (TH3,TH6,TH7,TH8). Refer to "10-9. TEST POINT DIAGRAM"</p> <p>② Check resistance value of thermistor (TH3,TH6,TH7,TH8) or check temperature by microprocessor. (Thermistor TH3,TH6, TH7, TH8: Refer to "10-6. HOW TO CHECK THE PARTS".) (SW2 on A-Control Service Tool: Refer to "10-10. FUNCTION OF SWITCHES, CONNECTORS AND JUMPERS".)</p> <p>③ Replace outdoor controller circuit board. Note: Emergency operation is available in the case of abnormalities of TH3, TH6 and TH7. Refer to "10-8. EMERGENCY OPERATION".</p>																								
<table border="1" style="width: 100%; border-collapse: collapse;"> <thead> <tr> <th colspan="4">Thermistors</th> </tr> <tr> <th>Symbol</th> <th>Name</th> <th>Open detection</th> <th>Short detection</th> </tr> </thead> <tbody> <tr> <td>TH3</td> <td>Thermistor <Liquid></td> <td>-40°C or below</td> <td>90°C or above</td> </tr> <tr> <td>TH6</td> <td>Thermistor <2-phase pipe></td> <td>-40°C or below</td> <td>90°C or above</td> </tr> <tr> <td>TH7</td> <td>Thermistor <Ambient></td> <td>-40°C or below</td> <td>90°C or above</td> </tr> <tr> <td>TH8</td> <td>Thermistor <Heat sink></td> <td>-27°C or below</td> <td>102°C or above</td> </tr> </tbody> </table>				Thermistors				Symbol	Name	Open detection	Short detection	TH3	Thermistor <Liquid>	-40°C or below	90°C or above	TH6	Thermistor <2-phase pipe>	-40°C or below	90°C or above	TH7	Thermistor <Ambient>	-40°C or below	90°C or above	TH8	Thermistor <Heat sink>	-27°C or below	102°C or above
Thermistors																											
Symbol	Name	Open detection	Short detection																								
TH3	Thermistor <Liquid>	-40°C or below	90°C or above																								
TH6	Thermistor <2-phase pipe>	-40°C or below	90°C or above																								
TH7	Thermistor <Ambient>	-40°C or below	90°C or above																								
TH8	Thermistor <Heat sink>	-27°C or below	102°C or above																								
U5 (4230)	<p>Temperature of heat sink Abnormal if heat sink thermistor (TH8) detects temperature indicated below. M200/250Y 86°C</p>	<p>① The outdoor fan motor is locked. ② Failure of outdoor fan motor ③ Airflow path is clogged. ④ Rise of ambient temperature</p> <p>⑤ Defective thermistor</p> <p>⑥ Defective input circuit of outdoor power circuit board ⑦ Failure of outdoor fan drive circuit</p>	<p>①② Check outdoor fan. ③ Check airflow path for cooling. ④ Check if there is something which causes temperature rise around outdoor unit. (Upper limit of ambient temperature is 46°C.) Turn off power, and on again to check if U5 is displayed within 30 minutes. If U4 is displayed instead of U5, follow the action to be taken for U4. ⑤ Check resistance value of thermistor (TH8) or temperature by microprocessor. (Thermistor/TH8: Refer to "10-6. HOW TO CHECK THE PARTS".) (SW2 on A-Control Service Tool: Refer to "10-10. FUNCTION OF SWITCHES, CONNECTORS AND JUMPERS".) ⑥ Replace outdoor power circuit board. ⑦ Replace outdoor controller circuit board.</p>																								
U6 (4250)	<p>Power module Check abnormality by driving power module in case overcurrent is detected. (UF or UP error condition)</p>	<p>① Outdoor stop valve is closed. ② Decrease of power supply voltage ③ Looseness, disconnection or converse of compressor wiring connection ④ Defective compressor</p> <p>⑤ Defective outdoor power circuit board</p>	<p>① Open stop valve. ② Check facility of power supply. ③ Correct the wiring (U-V/W phase) to compressor. Refer to "10-9. TEST POINT DIAGRAM". (Outdoor power circuit board). ④ Check compressor referring to "10-6. HOW TO CHECK THE PARTS". ⑤ Replace outdoor power circuit board.</p>																								
U7 (1520)	<p>Too low superheat due to low discharge temperature Abnormal if discharge superheat is continuously detected less than or equal to 0°C for 3 minutes even though linear expansion valve has minimum open pulse after compressor starts operating for 10 minutes.</p>	<p>① Disconnection or loose connection of discharge temperature thermistor (TH4) ② Defective holder of discharge temperature thermistor ③ Disconnection or loose connection of linear expansion valve's coil ④ Disconnection or loose connection of linear expansion valve's connector ⑤ Defective linear expansion valve</p>	<p>①② Check the installation conditions of discharge temperature thermistor (TH4). ③ Check the coil of linear expansion valve. Refer to "10-7. HOW TO CHECK THE COMPONENT". ④ Check the connection or contact of LEV-A and LEV-B on outdoor controller circuit board. ⑤ Check linear expansion valve. Refer to "10-6. HOW TO CHECK THE PARTS".</p>																								
U8 (4400)	<p>Outdoor fan motor Abnormal if rotational frequency of the fan motor is not detected during DC fan motor operation. Fan motor rotational frequency is abnormal if; <ul style="list-style-type: none"> • 100 rpm or below detected continuously for 15 seconds at 20°C or more outside air temperature. • 50 rpm or below or 1500 rpm or more detected continuously for 1 minute. </p>	<p>① Failure in the operation of the DC fan motor ② Failure in the outdoor circuit controller board</p>	<p>① Check or replace the DC fan motor. ② Check the voltage of the outdoor circuit controller board during operation. ③ Replace the outdoor circuit controller board. (when the failure is still indicated even after performing the action ① above.)</p>																								



Check Code	Abnormal points and detection method	Cause	Judgment and action	
U9 (4220)	Detailed codes	To find out the detail history (latest) about U9 error, turn ON SW2-1, 2-2 and 2-6. Refer to "10-10. FUNCTION OF SWITCHES, CONNECTORS AND JUMPERS".		
	01	Overvoltage error • Increase in DC bus voltage to M200/250Y: 760 V	① Abnormal increase in power source voltage ② Disconnection of compressor wiring ③ Defective outdoor power circuit board ④ Compressor has a ground fault.	① Check the field facility for the power supply. ② Correct the wiring (U-V-W phase) to compressor. Refer to "10-9. TEST POINT DIAGRAM" (Outdoor power circuit board). ③ Replace outdoor power circuit board. ④ Check compressor for electrical insulation. Replace compressor.
	02	Undervoltage error • Instantaneous decrease in DC bus voltage to M200/250Y: 400 V	① Decrease in power source voltage, instantaneous stop. ② Defective 52C drive circuit in outdoor power circuit board ③ Disconnection or loose connection of rush current protect resistor RS ④ Defective rush current protect resistor RS	① Check the field facility for the power supply. ② Replace outdoor power circuit board. ③ Check RS wiring. ④ Replace RS.
	04	Input current sensor error/ L1-phase open error • Decrease in input current through outdoor unit to 0.1 A only if operation frequency is more than or equal to 40 Hz or compressor current is more than or equal to 6 A.	① L1-phase open ② Disconnection or loose connection between TB1 and outdoor noise filter circuit board ③ Disconnection or loose connection of CN5 on the outdoor power circuit board/CNCT on the outdoor noise filter board ④ Defective ACCT (AC current trans) on the outdoor noise filter circuit board ⑤ Defective input current detection circuit in outdoor power circuit board ⑥ Defective outdoor controller circuit board	① Check the field facility for the power supply. ② Check the wiring between TB1 and outdoor noise filter circuit board. ③ Check CN5/CNCT wiring. ④ Replace outdoor noise filter circuit board. ⑤ Replace outdoor power circuit board. ⑥ Replace outdoor controller circuit board.
	08	Abnormal power synchronous signal • No input of power synchronous signal to power circuit board • Power synchronous signal of 44 Hz or less, or 65 Hz or more is detected on power circuit board.	① Distortion of power source voltage, noise superimposition. ② Disconnection or loose connection of earth wiring ③ Disconnection or loose connection of CN2 on the outdoor power circuit board/controller circuit board ④ Defective power synchronous signal circuit in outdoor controller circuit board ⑤ Defective power synchronous signal circuit in outdoor power circuit board	① Check the field facility for the power supply. ② Check earth wiring. ③ Check CN2 wiring. ④ Replace outdoor controller circuit board. ⑤ Replace outdoor power circuit board.
	10	PFC error (Overvoltage/ Undervoltage/Overcurrent) • PFC detected any of the following: a) Increase of DC bus voltage to 420 V. b) Decrease in PFC control voltage to 12 V DC or lower. c) Increase in input current to 50 A peak. (For models equipped with single-phase PFC only)	Not applicable for M200/250Y model.	Check the switch setting for Model Select on the outdoor controller circuit board.
20	PFC/IGBT error (Undervoltage) • When Compressor is running, DC bus voltage stays at 310V or lower for consecutive 10 seconds	Not applicable for M200/250Y model.	Check the switch setting for Model Select on the outdoor controller circuit board.	



Check Code	Abnormal points and detection method	Cause	Judgment and action
Ud (UD)* (1504)	Over heat protection Abnormal if outdoor pipe thermistor (TH3) detects 70°C or more during compressor operation.	① Defective outdoor fan (fan motor) or short cycle of outdoor unit during cooling operation ② Defective outdoor pipe thermistor (TH3) ③ Defective outdoor controller board	① Check outdoor unit air passage. ②③ Turn the power off and on again to check the check code. If U4 is displayed, follow the U4 processing direction. *The check code in the parenthesis indicates PAR-4xMAA model ("x" represents 0 or later).
UF (4100)	Compressor overcurrent interruption (When compressor locked) Abnormal if overcurrent of DC bus or compressor is detected within 30 seconds after compressor starts operating.	① Stop valve is closed. ② Decrease of power supply voltage ③ Looseness, disconnection or converse of compressor wiring connection ④ Defective compressor ⑤ Defective outdoor power board ⑥ DIP switch setting difference of outdoor controller circuit board	① Open stop valve. ② Check facility of power supply. ③ Correct the wiring (U-V-W phase) to compressor. Refer to "10-9. TEST POINT DIAGRAM" (Outdoor power circuit board). ④ Check compressor. Refer to "10-6. HOW TO CHECK THE PARTS". ⑤ Replace outdoor power circuit board. ⑥ Check the DIP switch setting of outdoor controller circuit board. Refer to "Model Select" in "(1) Function of switches" in "10-10. FUNCTION OF SWITCHES, CONNECTORS AND JUMPERS".
UH (5300)	Current sensor error or input current error • Abnormal if current sensor detects -1.0A to 1.0A during compressor operation. (This error is ignored in the case of test run mode.)	① Disconnection of compressor wiring ② Defective circuit of current sensor on outdoor power circuit board ③ Decrease of power supply voltage	① Correct the wiring (U-V-W phase) to compressor. Refer to "10-9. TEST POINT DIAGRAM" (Outdoor power circuit board). ② Replace outdoor power circuit board. ③ Check the facility of power supply.
UL (1300)	Low pressure Abnormal if the following conditions are detected for continuously 3 minutes after compressor starts heating operating for 10 minutes. TH7-TH3 \leq 4°C and TH5-Indoor room temperature \leq 2°C Thermistor TH3: Outdoor liquid pipe temperature TH5: Indoor cond./eva. temperature TH7: Ambient temperature	① Stop valve of outdoor unit is closed during operation. ② Leakage or shortage of refrigerant ③ Malfunction of linear expansion valve ④ Clogging with foreign objects in refrigerant circuit Note: If water enters in refrigerant circuit, clogging may occur where the part becomes below freezing point.	① Check stop valve. ② Check intake superheat. Check leakage of refrigerant. Check additional refrigerant. ③ Check linear expansion valve. Refer to "10-6. HOW TO CHECK THE PARTS". ④ After recovering refrigerant, remove water from entire refrigerant circuit under vacuum more than 1 hour.
UP (4210)	Compressor overcurrent interruption Abnormal if overcurrent DC bus or compressor is detected after compressor starts operating for 30 seconds.	① Stop valve of outdoor unit is closed. ② Decrease of power supply voltage ③ Looseness, disconnection or converse of compressor wiring connection ④ Defective fan of indoor/outdoor units ⑤ Short cycle of indoor/outdoor units ⑥ Defective input circuit of outdoor controller board ⑦ Defective compressor ⑧ Defective outdoor power circuit board ⑨ DIP switch setting difference of outdoor controller circuit board	① Open stop valve. ② Check facility of power supply. ③ Correct the wiring (U-V-W phase) to compressor. Refer to "10-9. TEST POINT DIAGRAM". (Outdoor power circuit board). ④ Check indoor/outdoor fan. ⑤ Solve short cycle. ⑥ Replace outdoor controller circuit board. ⑦ Check compressor. Refer to "10-6. HOW TO CHECK THE PARTS". Before the replacement of the outdoor controller circuit board, disconnect the wiring to compressor from the outdoor power circuit board and check the output voltage among phases, U, V, W, during test run. No defect on board if voltage among phases (U-V, V-W and W-U) is same. Make sure to perform the voltage check with same performing frequency. ⑧ Replace outdoor power circuit board ⑨ Check the DIP switch setting of outdoor controller circuit board

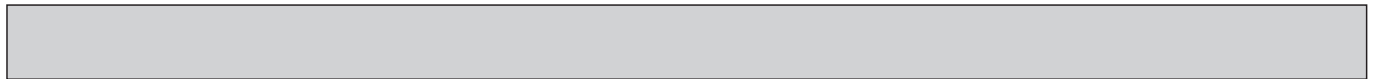

Check Code	Abnormal points and detection method	Cause	Judgment and action
E0 or E4	<p>Remote controller transmission error (E0)/ signal receiving error (E4)</p> <p>① Abnormal if main or sub remote controller cannot receive normally any transmission from indoor unit of refrigerant address "0" for 3 minutes. (Check code: E0)</p> <p>② Abnormal if sub remote controller could not receive any signal for 2 minutes. (Check code: E0)</p> <p>③ Abnormal if indoor controller board can not receive normally any data from remote controller board or from other indoor controller board for 3 minutes. (Check code: E4)</p> <p>④ Indoor controller board cannot receive any signal from remote controller for 2 minutes. (Check code: E4)</p>	<p>① Contact failure at transmission wire of remote controller</p> <p>② All remote controllers are set as "sub" remote controller. In this case, E0 is displayed on remote controller, and E4 is displayed at LED (LED1, LED2) on the outdoor controller circuit board.</p> <p>③ Miswiring of remote controller</p> <p>④ Defective transmitting receiving circuit of remote controller</p> <p>⑤ Defective transmitting receiving circuit of indoor controller board of refrigerant address "0"</p> <p>⑥ Noise has entered into the transmission wire of remote controller.</p>	<p>① Check disconnection or looseness of indoor unit or transmission wire of remote controller.</p> <p>② Set one of the remote controllers "main" if there is no problem with the action above.</p> <p>③ Check wiring of remote controller.</p> <ul style="list-style-type: none"> • Total wiring length: maximum 500 m (Do not use cable with 3 or more cores.) • The number of connecting indoor units: maximum 16 units • The number of connecting remote controller: maximum 2 units <p>If the cause of trouble is not any of ①-③ above,</p> <p>④ Diagnose remote controllers.</p> <p>a) When "OK" is displayed, remote controllers have no problem. Turn the power off, and on again to check. If abnormality occurs again, replace indoor controller board.</p> <p>b) When "NG" is displayed, replace remote controller.</p> <p>c) When "E3" or "ERC" is displayed, noise may be causing abnormality.</p> <p>Note: If the unit is not normal after replacing indoor controller board in group control, indoor controller board of address "0" may be abnormal.</p>
E1 or E2	<p>Remote controller control board</p> <p>① Abnormal if data cannot be normally read from the nonvolatile memory of the remote controller control board. (Check code: E1)</p> <p>② Abnormal if the clock function of remote controller cannot be normally operated. (Check code: E2)</p>	<p>① Defective remote controller</p>	<p>① Replace remote controller.</p>
E3 or E5	<p>Remote controller transmission error (E3)/ signal receiving error (E5)</p> <p>① Abnormal if remote controller could not find blank of transmission path for 6 seconds and could not transmit. (Check code: E3)</p> <p>② Remote controller receives transmitted data at the same time, compares the data, and when detecting it, judges different data to be abnormal 30 continuous times. (Check code: E3)</p> <p>③ Abnormal if indoor controller board could not find blank of transmission path. (Check code: E5)</p> <p>④ Indoor controller board receives transmitted data at the same time, compares the data, and when detecting it, judges different data to be abnormal 30 continuous times. (Check code: E5)</p>	<p>① 2 remote controllers are set as "main." (In the case of 2 remote controllers)</p> <p>② Remote controller is connected with 2 indoor units or more.</p> <p>③ Repetition of refrigerant address</p> <p>④ Defective transmitting receiving circuit of remote controller</p> <p>⑤ Defective transmitting receiving circuit of indoor controller board</p> <p>⑥ Noise has entered into transmission wire of remote controller.</p>	<p>① Set a remote controller to main, and the other to sub.</p> <p>② Remote controller is connected with only 1 indoor unit.</p> <p>③ The address changes to a separate setting.</p> <p>④-⑥ Diagnose remote controller.</p> <p>a) When "OK" is displayed, remote controllers have no problem. Turn the power off, and on again to check. When becoming abnormal again, replace indoor controller board.</p> <p>b) When "NG" is displayed, replace remote controller.</p> <p>c) When "E3" or "ERC" is displayed, noise may be causing abnormality.</p>

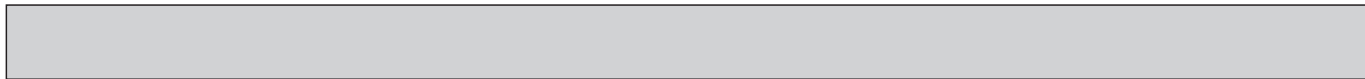

Check Code	Abnormal points and detection method	Cause	Judgment and action
E6 (6840)	Indoor/outdoor unit communication error (Signal receiving error) ① Abnormal if indoor controller board could not receive any signal normally for 6 minutes after turning the power on. ② Abnormal if indoor controller board could not receive any signal normally for 3 minutes. ③ Consider the unit as abnormal under the following condition. When 2 or more indoor units are connected to an outdoor unit, indoor controller board could not receive a signal for 3 minutes from outdoor controller circuit board, a signal which allows outdoor controller circuit board to transmit signals.	① Contact failure, short circuit or miswiring (converse wiring) of indoor/outdoor unit connecting wire ② Defective transmitting receiving circuit of outdoor controller circuit board. ③ Defective transmitting receiving circuit of indoor controller board. ④ Noise has entered into indoor/outdoor unit connecting wire. ⑤ Defective fan motor ⑥ Defective rush current resistor of outdoor power circuit board	Check LED display on outdoor controller circuit board. (Connect A-Control service tool (PAC-SK52ST)) Refer to EA-EC item if LED displays EA-AC. ① Check disconnecting or looseness of indoor/outdoor unit connecting wire of indoor unit or outdoor unit. Check all the units in the case of twin/triple/quadruple indoor unit system. ②-④ Turn the power off, and on again to check. If abnormality occurs again, replace indoor controller board or outdoor controller circuit board. Note: Other indoor controller board may have defect in the case of twin/triple/quadruple indoor unit system. ⑤ Turn the power off, and detach fan motor from connector (CNF1, 2). Then turn the power on again. If abnormality is not displayed, replace fan motor. If abnormality is displayed, replace outdoor controller circuit board. ⑥ Check the rush current resistor on outdoor power circuit board with tester. If open is detected, replace the power circuit board.
E7	Indoor/outdoor unit communication error (Transmitting error) Abnormal if "1" receiving is detected 30 times continuously though indoor controller board has transmitted "0".	① Defective transmitting receiving circuit of indoor controller board ② Noise has entered into power supply. ③ Noise has entered into outdoor control wire.	①-③ Turn the power off, and on again to check. If abnormality occurs again, replace indoor controller board.
E8 (6840)	Indoor/outdoor unit communication error (Signal receiving error) (Outdoor unit) Abnormal if outdoor controller circuit board could not receive anything normally for 3 minutes.	① Contact failure of indoor/outdoor unit connecting wire ② Defective communication circuit of outdoor controller circuit board ③ Defective communication circuit of indoor controller board ④ Noise has entered into Indoor/outdoor unit connecting wire.	① Check disconnection or looseness of Indoor/outdoor unit connecting wire of indoor or outdoor units. ②-④ Turn the power off, and on again to check. Replace indoor controller board or outdoor controller circuit board if abnormality is displayed again.
E9 (6841)	Indoor/outdoor unit communication error (Transmitting error) (Outdoor unit) ① Abnormal if "0" receiving is detected 30 times continuously though outdoor controller circuit board has transmitted "1". ② Abnormal if outdoor controller circuit board could not find blank of transmission path for 3 minutes.	① Indoor/outdoor unit connecting wire has contact failure. ② Defective communication circuit of outdoor controller circuit board ③ Noise has entered power supply. ④ Noise has entered Indoor/outdoor unit connecting wire.	① Check disconnection or looseness of indoor/outdoor unit connecting wire. ②-④ Turn the power off, and on again to check. Replace outdoor controller circuit board if abnormality is displayed again.
EE	Abnormal if a connection of indoor unit and outdoor unit which uses different refrigerant is detected.	Unauthorized connection of indoor unit and outdoor unit Connections other than below combination are not authorized; Outdoor unit: Models with R32 refrigerant Indoor unit: Floor standing type indoor unit (PSA-KA)	Alter the connection referring to the combination as shown in the "cause" column.
EF (6607 or 6608)	Non defined check code This code is displayed when non defined check code is received.	① Noise has entered transmission wire of remote controller. ② Noise has entered Indoor/outdoor unit connecting wire. ③ Outdoor unit is not a series of power-inverter.	①② Turn the power off, and on again to check. Replace indoor controller board or outdoor controller circuit board if abnormality is displayed again. ③ Replace outdoor unit with power-inverter type outdoor unit.



Check Code	Abnormal points and detection method	Cause	Judgment and action
Ed (0403)	<p>Serial communication error</p> <p>① Abnormal if serial communication between outdoor controller circuit board and outdoor power circuit board is defective.</p> <p>② Abnormal if communication between outdoor controller circuit board and M-NET board is not available.</p>	<p>① Breaking of wire or contact failure of connector CN2 between the outdoor controller circuit board and the outdoor power circuit board</p> <p>② Breaking of wire or contact failure of connector CN4 between the outdoor controller circuit board and the outdoor power circuit board</p> <p>③ Defective communication circuit of outdoor power circuit board</p> <p>④ Defective communication circuit of outdoor controller circuit board for outdoor power circuit board</p> <p>① Breaking of wire or contact failure of connector between outdoor controller circuit board and M-NET board</p> <p>② Contact failure of M-NET board power supply line</p> <p>③ Noise has entered into M-NET transmission wire.</p>	<p>①② Check connection of each connector CN2 and CN4 between the outdoor controller circuit board and the outdoor power circuit board.</p> <p>③ Replace outdoor power circuit board.</p> <p>④ Replace outdoor controller circuit board.</p> <p>① Check disconnection, looseness, or breaking of connection wire between outdoor controller circuit board (CNMNT) and M-NET board (CN5).</p> <p>② Check disconnection, looseness, or breaking of connection wire between outdoor controller circuit board (CNMNT) and M-NET board (CND).</p> <p>③ Check M-NET transmission wiring method.</p>
P8	<p>Pipe temperature <Cooling mode> Detected as abnormal when the pipe temperature is not in the cooling range 3 minutes after compressor start and 6 minutes after the liquid or condenser/evaporator pipe is out of cooling range. Note 1: It takes at least 9 minutes to detect. Note 2: Abnormality P8 is not detected in drying mode. Cooling range : Indoor pipe temperature (TH2 or TH5)-intake temperature (TH1) $\leq -3^{\circ}\text{C}$ TH: Lower temperature between liquid pipe temperature and condenser/evaporator temperature</p> <p><Heating mode> When 10 seconds have passed after the compressor starts operation and the hot adjustment mode has finished, the unit is detected as abnormal when condenser/evaporator pipe temperature is not in heating range within 20 minutes. Note 3: It takes at least 27 minutes to detect abnormality. Note 4: It excludes the period of defrosting (Detection restarts when defrosting mode is over) Heating range: $3^{\circ}\text{C} \leq (\text{Condenser/ Evaporator temperature}(\text{TH5})-\text{intake temperature}(\text{TH1}))$</p>	<p>① Slight temperature difference between indoor room temperature and pipe <liquid or condenser/evaporator> temperature thermistor</p> <ul style="list-style-type: none"> • Shortage of refrigerant • Disconnected holder of pipe <liquid or condenser/evaporator> thermistor • Defective refrigerant circuit <p>② Converse connection of extension pipe (on plural units connection)</p> <p>③ Converse wiring of indoor/outdoor unit connecting wire (on plural units connection)</p> <p>④ Defective detection of indoor room temperature and pipe <condenser/evaporator> temperature thermistor</p> <p>⑤ Stop valve is not opened completely.</p>	<p>①-④ Check pipe <liquid or condenser/evaporator> temperature with room temperature display on remote controller and outdoor controller circuit board. Pipe <liquid or condenser/evaporator> temperature display is indicated by setting SW2 of outdoor controller circuit board as follows.</p> <p>(Conduct temperature check with outdoor controller circuit board after connecting 'A-Control Service Tool (PAC-SK52ST)').</p> <div style="display: flex; justify-content: space-around;"> <div style="text-align: center;"> <p>Temperature display of indoor liquid pipe Indoor 1</p> </div> <div style="text-align: center;"> <p>Temperature display of indoor condenser/evaporator pipe Indoor 1</p> </div> </div> <div style="display: flex; justify-content: space-around;"> <div style="text-align: center;"> <p>Temperature display of indoor liquid pipe Indoor 2</p> </div> <div style="text-align: center;"> <p>Temperature display of indoor condenser/evaporator pipe Indoor 2</p> </div> </div> <p style="text-align: center; font-size: small;">A-Control Service Tool SW2 setting</p> <p>⑤ Check converse connection of extension pipe or converse wiring of indoor/outdoor unit connecting wire.</p>
PL	<p>Abnormal refrigerant circuit During Cooling, Dry, or Auto Cooling operation, the following conditions are regarded as failures when detected for 1 second.</p> <p>a)The compressor continues to run for 30 or more seconds.</p> <p>b)The liquid pipe temperature or the condenser/evaporator temperature is 75°C or more.</p> <p><u>These detected errors will not be cancelled until the power source is reset.</u></p>	<p>① Abnormal operation of 4-way valve</p> <p>② Disconnection of or leakage in refrigerant pipes</p> <p>③ Air into refrigerant piping</p> <p>④ Abnormal operation (no rotation) of indoor fan</p> <ul style="list-style-type: none"> • Defective fan motor • Defective indoor control board <p>⑤ Defective refrigerant circuit (clogging)</p>	<p>① <u>When this error occurs, be sure to replace the 4-way valve.</u></p> <p>② Check refrigerant pipes for disconnection or leakage.</p> <p>③ After the recovery of refrigerant, vacuum dry the whole refrigerant circuit.</p> <p>④ Refer to "10-6. HOW TO CHECK THE PARTS".</p> <p>⑤ Check refrigerant circuit for operation. <u>To avoid entry of moisture or air into refrigerant circuit which could cause abnormal high pressure, purge air in refrigerant circuit or replace refrigerant.</u></p>

<M-NET communication error>

Note: "Indoor unit" in the text indicates M-NET board in outdoor unit.

Check Code	Abnormal points and detection method	Cause	Judgment and action
A0 (6600)	Address duplicate definition This error is displayed when transmission from the units of same address is detected. Note: The address and attribute displayed at remote controller indicate the controller that detected abnormality.	① There are 2 or more same address of controller of outdoor unit, indoor unit, FRESH MASTER, or LOSSNAY. ② Noise has entered into transmission signal and signal was transformed.	Search the unit with same address as abnormality occurred. If the same address is found, shut the power supply of outdoor unit and indoor unit and FRESH MASTER or LOSSNAY at the same time for 2 minutes or more after the address is corrected, and turn the power on again. Check transmission waveform or noise on transmission wire.
A2 (6602)	Hardware error of transmission processor Transmission processor intended to transmit "0", but "1" appeared on transmission wire. Note: The address and attribute display at remote controller indicate the controller that detected abnormality.	① Error is detected if waveform is transformed when wiring works of transmission wire of outdoor unit, indoor unit, FRESH MASTER or LOSSNAY are done, or polarity is changed with the power on and transmission data collide each other. ② Defective transmitting receiving circuit of transmission processor ③ Transmission data is changed by the noise on transmission	① If the works of transmission wire is done with the power on, shut off the power supply of outdoor unit and indoor unit and FRESH MASTER or LOSSNAY at the same time for 2 minutes or more, and turn the power on again. ② Check transmission waveform or noise on transmission wire.
A3 (6603)	BUS BUSY 1. Overtime error by collision damage Abnormal if transmitting is not possible for 8 to 10 minutes continuously because of collision of transmission. 2. Data could not reach transmission wire for 8 to 10 minutes continuously because of noise, etc. Note: The address and attribute displayed at remote controller indicate the controller that detected abnormality.	① Transmission processor could not transmit signal because short cycle voltage of noise and the like have entered into transmission wire continuously. ② Transmission quantity has increased and transmission is not possible because there was wiring mistake of terminal block for transmission wire (TB3) and terminal block for central control (TB7) in outdoor unit. ③ Transmission are mixed with others and occupation rate on transmission wire rose because of defective repeater (a function to connector or disconnect transmission of control and central control system) of outdoor unit, then abnormality is detected.	① Check if transmission wire of indoor unit, FRESH MASTER, LOSSNAY, or remote controller is not connected to terminal block for central control (TB7) of outdoor unit. ② Check if transmission wire of indoor unit, FRESH MASTER or LOSSNAY is not connected to terminal block for transmission wire of outdoor unit. ③ Check if terminal block for transmission wire (TB3) and terminal block for central control (TB7) is not connected. ④ Check transmission waveform or noise on transmission wire.
A6 (6606)	Communication error with communication processor Defective communication between unit processor and transmission processor Note: The address and attribute display at remote controller indicate the controller that detected abnormality.	① Data of transmission processor or unit processor is not transmitted normally because of accidental trouble such as noise or thunder surge. ② Address forwarding from unit processor is not transmitted normally because of defective transmission processor hardware.	Turn off the power supply of outdoor unit, indoor unit and FRESH MASTER or LOSSNAY at the same time for 2 minutes or more, and turn the power on again. System returns normally if abnormality was accidental malfunction. If the same abnormality occurs again, abnormality-occurred controller may be defective.



Check Code	Abnormal points and detection method	Cause	Judgment and action
<p style="text-align: center;">A7 (6607)</p>	<p>NO ACK signal</p> <p>1. Transmitting side controller detects abnormal if a message was transmitted but there is no reply (ACK) that a message was received. Transmitting side detects abnormality every 30 seconds, 6 times continuously.</p> <p>Note: The address and attribute displayed at remote controller indicate the controller that did not reply (ACK).</p>	<p>Common factor that has no relation with abnormality source</p> <p>① The unit of former address does not exist as address switch has changed while the unit was energized.</p> <p>② Voltage drop and weak signal which lead communication error are caused by over-range transmission wire.</p> <ul style="list-style-type: none"> • Maximum distance.....200 m • Remote controller line..(12 m) <p>③ Voltage drop and weak signal which lead communication error are caused by type-unmatched transmission wire.</p> <p>Type.....</p> <ul style="list-style-type: none"> With shield wire- CVVS, CPEVS With normal wire (no shield)- VCTF, VCTFK, CVV CVS, VVR, VVF, VCT <p>Diameter.....1.25 mm² or more</p> <p>④ Voltage drop and weak signal which lead communication error are caused by over-numbered units.</p> <p>⑤ Accidental malfunction of abnormality-detected controller (noise, thunder surge)</p> <p>⑥ Defective of abnormality-generated controller</p>	<p>Always try the following when the error “A7” occurs.</p> <p>① Turn off the power supply of outdoor unit, indoor unit and FRESH MASTER or LOSSNAY at the same time for 2 minutes or more, and turn the power on again. If malfunction was accidental, the unit returns to normal.</p> <p>② Check address switch of abnormality-generated address.</p> <p>③ Check disconnection or looseness of abnormality-generated or abnormality-detected transmission wire (terminal block and connector)</p> <p>④ Check if tolerance range of transmission wire is not exceeded.</p> <p>⑤ Check if type of transmission wire is correct or not.</p> <p>If the cause of trouble is in ①–⑤ above, repair the defect, then turn off the power supply of outdoor unit, indoor unit and FRESH MASTER or LOSSNAY at the same time for 2 minutes or more, and turn the power on again.</p> <ul style="list-style-type: none"> • If the cause of trouble is not in ①–⑤ above in single refrigerant system (one outdoor unit), controller of displayed address or attribute is defective. • If the cause of trouble is not in ①–⑤ above in different refrigerant system (2 or more outdoor units), judge with ⑥.
	<p>2. If displayed address or attribute is outdoor unit, indoor unit detects abnormality when indoor unit transmits signal to outdoor unit and there was no reply (ACK).</p>	<p>① Contact failure of transmission wire of outdoor unit or indoor unit</p> <p>② Disconnection of transmission connector (CN2M) of outdoor unit</p> <p>③ Defective transmitting receiving circuit of outdoor unit or indoor unit</p>	<p>⑥ If address of abnormality source is the address that should not exist, there is the unit that memorizes nonexistent address information. Delete unused address information with manual setting function of remote controller.</p> <p>This applies only to the system FRESH MASTER or LOSSNAY is connected to, or the system that is equipped with group setting of different refrigerant system.</p>
	<p>3. If displayed address or attribute is indoor unit, remote controller detects abnormality when remote controller transmits signal to indoor unit and there was no reply (ACK).</p>	<p>① During group operation with indoor unit of multi-refrigerant system, if remote controller transmits signal to indoor unit while outdoor unit power supply of one refrigerant system is turned off or within 2 minutes of restart, abnormality is detected.</p> <p>② Contact failure of transmission wire of remote controller or indoor unit</p> <p>③ Disconnection of transmission connector (CN2M) of indoor unit</p> <p>④ Defective transmitting receiving circuit of indoor unit or remote controller</p>	<p>If the cause of trouble is not any of ①–⑥ above, replace the controller board of displayed address or attribute.</p> <p>If the unit does not return normally, multi controller board of outdoor unit may be defective (repeater circuit).</p> <p>Replace multi controller board one by one to check if the unit returns normally.</p>

Continue to the next page.



Check Code	Abnormal points and detection method	Cause	Judgment and action
A7 (6607)	4. If displayed address or attribute is remote controller, indoor unit detects abnormality when indoor unit transmits signal to remote controller and there was no reply (ACK).	<ul style="list-style-type: none"> ① During group operation with indoor unit of multi-refrigerant system, if indoor unit transmits signal to remote controller while outdoor unit power supply of one refrigerant system is turned off or within 2 minutes of restart, abnormality is detected. ② Contact failure of transmission wire of remote controller or indoor unit ③ Disconnection of transmission connector (CN2M) of indoor unit ④ Defective transmitting receiving circuit of indoor unit or remote controller 	Same as mentioned in “A7” of the previous page.
	5. If displayed address or attribute is FRESH MASTER, indoor unit detects abnormality when indoor unit transmits signal to FRESH MASTER and there was no reply (ACK).	<ul style="list-style-type: none"> ① During sequential operation of indoor unit and FRESH MASTER of other refrigerant system, if indoor unit transmits signal to FRESH MASTER while outdoor unit power supply of same refrigerant system with FRESH MASTER is turned off or within 2 minutes of restart, abnormality is detected. ② Contact failure of transmission wire of indoor unit or FRESH MASTER ③ Disconnection of transmission connector (CN2M) of indoor unit or FRESH MASTER ④ Defective transmitting receiving circuit of indoor unit or FRESH MASTER 	
	6. If displayed address or attribute is LOSSNAY, indoor unit detects abnormality when indoor unit transmits signal to LOSSNAY and there was no reply (ACK).	<ul style="list-style-type: none"> ① If the power supply of LOSSNAY is off, indoor unit detects abnormality when it transmits signal to LOSSNAY. ② During sequential operation of indoor unit and LOSSNAY of other refrigerant system, if indoor unit transmits signal to LOSSNAY while outdoor unit power supply of same refrigerant system with LOSSNAY is turned off or within 2 minutes of restart, abnormality is detected. ③ Contact failure of transmission wire of indoor unit of LOSSNAY ④ Disconnection of transmission connector (CN2M) of indoor unit ⑤ Defective transmitting receiving circuit of indoor unit or LOSSNAY 	
	7. If displayed address or attribute is nonexistent.	<ul style="list-style-type: none"> ① The unit of former address does not exist as address switch has changed while the unit was energized. ② Abnormality is detected when indoor unit transmits signal because the address of FRESH MASTER and LOSSNAY are changed after sequential operation of FRESH MASTER and LOSSNAY by remote controller. 	



Check Code	Abnormal points and detection method	Cause	Judgment and action
A8 (6608)	<p>M-NET NO RESPONSE</p> <p>Abnormal if a message was transmitted and there were reply (ACK) that message was received, but response command does not return. Transmitting side detects abnormality every 30 seconds, 6 times continuously.</p> <p>Note: The address and attribute displayed at remote controller indicate the controller that did not reply (ACK).</p>	<p>① Transmitting condition is repeated fault because of noise and the like.</p> <p>② Voltage drop and weak signal which lead communication error are caused by over-range transmission wire.</p> <ul style="list-style-type: none"> • Maximum distance 200 m • Remote controller line (12 m) <p>③ Voltage drop and weak signal which lead communication error are caused by type-unmatched transmission wire.</p> <p>Type.....</p> <p>With shield wire- CVVS, CPEVS</p> <p>With normal wire (no shield)- VCTF, VCTFK, CVV CVS, VVR, VVF, VCT</p> <p>Diameter 1.25 mm² or more</p> <p>④ Accidental malfunction of abnormality-generated controller</p>	<p>① Check transmission waveform or noise on transmission wire.</p> <p>② Turn off the power supply of outdoor unit and indoor unit and FRESH MASTER or LOSSNAY at the same time for 2 minutes or more, and turn the power on again. If malfunction was accidental, the unit returns to normal. If the same abnormality occurs again, controller of displayed address and attribute may be defective.</p>

10-5. TROUBLESHOOTING OF PROBLEMS

Phenomena	Factor	Countermeasure
1. Remote controller display does not work.	<p>① 12 V DC is not supplied to remote controller.</p> <p>② 12–15 V DC is supplied to remote controller, however, no display is indicated.</p> <ul style="list-style-type: none"> • "Please Wait" is not displayed. • "Please Wait" is displayed. 	<p>① Check LED2 on indoor controller board.</p> <p>(1) When LED2 is lit: check the remote controller wiring for breaking or contact failure.</p> <p>(2) When LED2 is blinking: check short circuit of remote controller wiring.</p> <p>(3) When LED2 is not lit: refer to phenomena No.3 below.</p> <p>② Check the following.</p> <ul style="list-style-type: none"> • Failure of remote controller if "Please Wait" is not displayed • Refer to phenomena No.2 below if "Please Wait" is displayed.
2. "Please Wait" display is remained on the remote controller.	<p>① At longest 2 minutes after the power supply "Please Wait" is displayed to start up.</p> <p>② Communication error between the remote controller and indoor unit</p> <p>③ Communication error between the indoor and outdoor unit</p> <p>④ Outdoor unit protection device connector is open.</p>	<p>① Normal operation</p> <p>② Self-diagnosis of remote controller</p> <p>③ "Please Wait" is displayed for 6 minutes at most in the case of indoor/outdoor unit communication error. Check LED3 on indoor controller board.</p> <p>(1) When LED3 is not blinking: check indoor/outdoor connecting wire for miswiring. (Converse wiring of S1 and S2, or break of S3 wiring.)</p> <p>(2) When LED3 is blinking: indoor/outdoor connecting wire is normal.</p> <p>④ Check LED display on outdoor controller circuit board. Refer to "10-10. FUNCTION OF SWITCHES, CONNECTORS AND JUMPERS". Check protection device connector (63H and TRS) for contact failure. Refer to "10-9. TEST POINT DIAGRAM".</p>
3. When pressing the remote controller operation switch, the OPERATION display is appeared but it will be turned off soon.	<p>① After cancelling to select function from the remote controller, the remote controller operation switch will not be accepted for approx. 30 seconds.</p>	<p>① Normal operation</p>

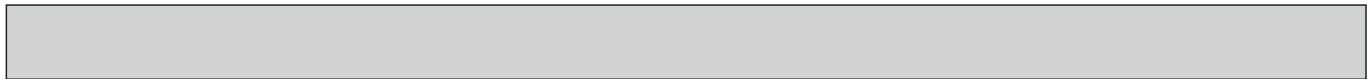

Phenomena	Factor	Countermeasure
4. Even controlling by the wireless remote controller, no beep is heard and the unit does not start operating. Operation display is indicated on wireless remote controller.	① The pair number settings of the wireless remote controller and indoor controller board are mismatched.	① Check the pair number settings.
5. When operating by the wireless remote controller, beep sound is heard, however, unit does not start operating.	① No operation for 2 minutes at most after the power supply ON. ② Local remote controller operation is prohibited. • Remote controlling adaptor is connected to CN32 on the indoor controller board. • Local remote controller operation is prohibited by centralized controller, etc. since it is connected to MELANS. ③ Phenomena of No.2.	① Normal operation ② Normal operation ③ Check the phenomena No.2.
6. Remote controller display works normally and the unit performs cooling operation, however, the capacity cannot be fully obtained. (The air does not cool well.)	① Refrigerant shortage ② Filter clogging ③ Heat exchanger clogging ④ Air duct short cycle	① • If refrigerant leaks, discharging temperature rises and LEV opening increases. Inspect leakage by checking the temperature and opening. • Check pipe connections for gas leakage. ② Open intake grille and check the filter. Clean the filter by removing dirt or dust on it. ③ • If the filter is clogged, indoor pipe temperature rises and discharging pressure increases. Check if heat exchanger is clogged by inspecting discharging pressure. • Clean the heat exchanger. ④ Remove the blockage.
7. Remote controller display works normally and the unit performs heating operation, however, the capacity cannot be fully obtained.	① Linear expansion valve fault Opening cannot be adjusted well due to linear expansion valve fault. ② Refrigerant shortage ③ Lack of insulation for refrigerant piping ④ Filter clogging ⑤ Heat exchanger clogging ⑥ Air duct short cycle ⑦ Bypass circuit of outdoor unit fault	① • Discharging temperature and indoor heat exchanger temperature does not rise. Inspect the failure by checking discharging pressure. • Replace linear expansion valve. ② • If refrigerant leaks, discharging temperature rises and LEV opening increases. Inspect leakage by checking the temperature and opening. • Check pipe connections for gas leakage. ③ Check the insulation. ④ Open intake grille and check the filter. Clean the filter by removing dirt or dust on it. ⑤ • If the filter is clogged, indoor pipe temperature rises and discharging pressure increases. Check if heat exchanger is clogged by inspecting discharging pressure. • Clean the heat exchanger. ⑥ Remove the blockage. ⑦ Check refrigerant system during operation.
8. ① For 3 minutes after temperature adjuster turns off, the compressor will not start operating even if temperature adjuster is turned on. ② For 3 minutes after temperature adjuster turns on, the compressor will not stop operating even if temperature adjuster is turned off. (Compressor stops operating immediately when turning off by the remote controller.)	①② Normal operation (For protection of compressor)	①② Normal operation

Symptoms: “Please Wait” is kept being displayed on the remote controller.





Diagnosis flow	Cause	Inspection method and troubleshooting
<pre> graph TD Start[Check the display time of "Please Wait" after turning on the main power.] --> D1{How long is "Please Wait" kept being displayed on the remote controller?} D1 -- "6 minutes or more" --> Step1[Check the LED display of the outdoor controller circuit board.] D1 -- "2 to 6 minutes" --> D2{Are any check codes displayed on the remote controller?} D1 -- "2 minutes or less" --> Cause1["• "Please Wait" will be displayed during the startup diagnosis after turning on the main power."] D2 -- NO --> Cause1 D2 -- YES --> HeatStandby[Heat Standby] Step1 --> D3{Are any check codes displayed on the LED?} D3 -- YES --> HeatStandby D3 -- NO --> Cause2["• Defective indoor controller board • Defective remote controller"] </pre>	<p>• “Please Wait” will be displayed during the startup diagnosis after turning on the main power.</p> <p>Heat Standby</p> <p>• Miswiring of indoor/ outdoor connecting wire • Breaking of indoor/ outdoor connecting wire (S3) • Defective indoor controller board • Defective outdoor controller circuit board</p> <p>• Defective indoor controller board • Defective remote controller</p>	<p>• Normal The startup diagnosis will be over in around 2 minutes.</p> <p>• Refer to “Self-diagnosis action table” in order to solve the trouble.</p> <p>• In the case of communication errors, the display of remote controller may not match the LED display of the outdoor unit.</p>

Symptoms: Nothing is displayed on the remote controller. ①

LED display of the indoor controller board
 LED1 : ○
 LED2 : ○
 LED3 : ○

Diagnosis flow	Cause	Inspection method and troubleshooting
<pre> graph TD Start[Check the voltage between S1 and S2 on the terminal block (TB4) of the indoor unit which is used to connect the indoor unit and the outdoor unit.] --> D1{198 to 264 V AC?} D1 -- NO --> S1[Check the voltage among L(L3) and N on the terminal block (TB1) of the outdoor power circuit board.] D1 -- YES --> S2[Check the voltage of indoor controller board (CN2D).] S1 --> D2{198 to 264 V AC?} D2 -- NO --> C1[• Troubles concerning power supply.] D2 -- YES --> S3[Check the voltage between S1 and S2 on the terminal block (TB1) of the outdoor unit which is used to connect the indoor unit and the outdoor unit.] S3 --> D3{198 to 264 V AC?} D3 -- NO --> C2[• Bad wiring of the outdoor controller board. • The fuses on the outdoor controller circuit board are blown.] D3 -- YES --> S4[Check the voltage of the unit after removing the indoor power board (CN2S).] S2 --> D4{12 to 16 V DC?} D4 -- YES --> C3[• Bad wiring of the outdoor controller board. • The fuses on the outdoor controller circuit board are blown.] D4 -- NO --> S5[Check the voltage of the unit after removing the indoor power board (CN2S).] S4 --> D5{12 to 16 V DC?} D5 -- YES --> C4[• Defective indoor controller board] D5 -- NO --> C5[• Miswiring, breaking or poor connection of indoor/outdoor connecting wire • Defective indoor power board] </pre>	<p>• Troubles concerning power supply.</p> <p>• Bad wiring of the outdoor controller board. • The fuses on the outdoor controller circuit board are blown.</p> <p>• Bad wiring of the outdoor controller board. • The fuses on the outdoor controller circuit board are blown.</p> <p>• Defective indoor controller board</p> <p>• Miswiring, breaking or poor connection of indoor/outdoor connecting wire • Defective indoor power board</p>	<p>• Check the power wiring to the outdoor unit. • Check the breaker.</p> <p>• Check the wiring of the outdoor unit. • Check if the wiring is bad. Check if the fuses are blown. The fuses on the outdoor controller circuit board will be blown when the indoor /outdoor connecting wire short-circuits.</p> <p>• Check if miswiring, breaking or poor contact is causing this problem. Indoor/outdoor connecting wire is polarized 3-core type. Connect the indoor unit and the outdoor unit by wiring each pair of S1, S2 and S3 on the both side of indoor/outdoor terminal blocks.</p> <p>• Replace the indoor controller board.</p> <p>• Check if there is miswiring or breaking of wire. • Replace the indoor power board.</p>

Symptoms: Nothing is displayed on the remote controller. ②

LED display of the indoor controller board
 LED1 : 
 LED2 : 
 LED3 :  or 



Diagnosis flow	Cause	Inspection method and troubleshooting
<p>Check the voltage between S1 and S2 on the terminal block (TB4) of the indoor unit which is used to connect the indoor unit and the outdoor unit.</p> <p>198 to 264 V AC?</p> <p>NO → Check the looseness or disconnection of the indoor/outdoor connecting wire.</p> <p>YES → Check the status of the indoor controller board LED3 display.</p> <p>Not lighting. → Check the looseness or disconnection of the indoor/outdoor connecting wire.</p> <p>Blinking. → Are there looseness or disconnection of the indoor/outdoor connecting wire?</p> <p>NO → Check the refrigerant address of the outdoor unit. (SW1-3 to 1-6)</p> <p>YES → Is the refrigerant address "0"?</p> <p>NO → Is anything displayed?</p> <p>YES → Check the LED display of the outdoor unit after turning on the main power again.</p> <p>Not displayed. → Is "EA" or "Eb" displayed?</p> <p>NO → Is "E8" displayed?</p> <p>YES → Can the unit be restarted?</p> <p>NO → Can all the indoor unit be operated?</p> <p>YES → Check the voltage between S2 and S3 on the terminal block of the outdoor unit.</p> <p>NO → 17 to 28 V DC?</p> <p>YES →</p>	<ul style="list-style-type: none"> • Breaking or poor contact of the indoor/outdoor connecting wire • Normal Only the unit which has the refrigerant address "0" supplies power to the remote controller. • Defective outdoor controller circuit board • Defective outdoor controller circuit board • Defective indoor controller board • Influence of electromagnetic noise • Defective outdoor power circuit board • Defective indoor power board 	<ul style="list-style-type: none"> • Fix the breaking or poor contact of the indoor/outdoor connecting wire. • Set the refrigerant address to "0". In the case of the multiple grouping system, recheck the refrigerant address again. • Replace the outdoor controller circuit board. • Replace the outdoor controller circuit board. • Replace the indoor controller board of the indoor unit which does not operate. • Not abnormal There may be the influence of electromagnetic noise. Check the transmission wire and get rid of the causes. • Replace the outdoor power circuit board. • Replace the indoor power board.



Symptoms: Nothing is displayed on the remote controller. ③	LED display of the indoor controller board LED1 : ● LED2 : ● or ● LED3 : —
---	---

Diagnosis flow	Cause	Inspection method and troubleshooting
<p>Check the voltage of the terminal block (TB6) of the remote controller.</p> <p>10 to 16 V DC?</p> <p>YES</p> <p>NO</p> <p>Check the status of the LED2.</p> <p>Lighting</p> <p>Blinking</p> <p>Check the status of the LED2 after disconnecting the remote controller wire from the terminal block (TB5) of the indoor unit.</p> <p>Lighting</p> <p>Blinking</p>	<ul style="list-style-type: none"> Defective remote controller Breaking or poor contact of the remote controller wire The remote controller wire short-circuits Defective indoor controller board 	<ul style="list-style-type: none"> Replace the remote controller. Check if there is breaking or poor contact of the remote controller wire. Check the voltage of the terminal block (TB5) connecting the remote controller wire. If it is not between 10 and 16 V DC, the indoor controller board must be defective. Check if the remote controller wire is short-circuited. Replace the indoor controller board.

• Before repair
Frequent calls from customers

Phone Calls From Customers		How to Respond	Note
Unit does not operate at all.	① The operating display of remote controller does not come on.	① Check if power is supplied to air conditioner. Nothing appears on the display unless power is supplied.	_____
	② Unit cannot be restarted for a while after it's stopped.	② Wait around 3 minutes to restart unit. The air conditioner is in a state of being protected by the microprocessor's directive. Once the compressor is stopped, the unit cannot be restarted for 3 minutes. This control is also applied when the unit is turned on and off by remote controller.	_____
	③ Check code appears and blinks on the display of remote controller.	③ Check code will be displayed if any protection devices of the air conditioner are actuated. What is check code? -----	Refer to "SELF-DIAGNOSIS ACTION TABLE". → Check if servicing is required for the error.
Remote controller	① "Please Wait" is displayed on the screen.	① Wait around 2 minutes. An automatic startup test will be conducted for 2 minutes when power is supplied to the air conditioner. "Please Wait" will be kept displayed while that time.	_____
	② "  " is displayed on the screen.	② This indicates that it is time to clean the air filters. Clean the air filters. "  " can be cleared from the filter information of the maintenance menu. See the operation manual that came with the product for how to clean the filters.	Display time of "  " depends on the model. Long life filter: 2500 hrs. Standard filter: 100 hrs.
	③ "Heat Standby" is displayed on the screen.	③ This is displayed when the unit starts HEAT operation, when the thermostat puts the compressor in operation mode, or when the outdoor unit ends DEFROST operation and returns to HEAT operation. The display will automatically disappear around 10 minutes later. While "Heat Standby" is displayed on the remote controller, the airflow amount will be restricted because the indoor unit's heat exchanger is not fully heated up. In addition to that, the up/down vane will be automatically set to horizontal blow in order to prevent cold air from directly blowing out to human body. The up/down vane will return to the setting specified by the remote controller when "Heat Standby" is released.	_____
	④ "Heat Defrost" is displayed on the screen. (No air comes out of the unit.)	④ The outdoor unit gets frosted when the outside temperature is low and the humidity is high. "Heat Defrost" indicates the DEFROST operation is being performed to melt this frost. The DEFROST operation ends in around 10 minutes (at most 15 minutes). During the DEFROST operation, the indoor unit's heat exchanger becomes cold, so the fan is stopped. The up/down vane will be automatically set to horizontal blow in order to prevent cold air from directly blowing out to human body. The display will turn into "Heat Standby" when DEFROST operation ends.	_____

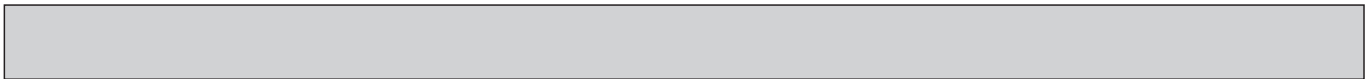

Phone Calls From Customers	How to Respond	Note	
The room cannot be cooled or heated sufficiently.	① Check the set temperature of remote controller. The outdoor unit cannot be operated if the set temperature is not appropriate. The outdoor unit operates in the following modes. COOL: When the set temperature is lower than the room temperature. HEAT: When the set temperature is higher than the room temperature.	_____	
	② Check if filters are not dirty and clogged. If filters are clogged, the airflow amount will be reduced and the unit capacity will be lowered. See the instruction manual that came with the product for how to clean the filters.	_____	
	③ Check there is enough space around the air conditioner. If there are any obstacles in the air intake or air outlet of indoor/outdoor units, they block the airflow direction so that the unit capacity will be lowered.	_____	
Sound comes out from the air conditioner.	① A gas escaping sound is heard sometimes.	① This is not a malfunction. This is the sound when the flow of refrigerant in the air conditioner is switched.	_____
	② A cracking sound is heard sometimes.	② This is not a malfunction. This is the sound when internal parts of units expand or contract when the temperature changes.	_____
	③ A buzzing sound is heard sometimes.	③ This is not a malfunction. This is the sound when the outdoor unit starts operating.	_____
	④ A ticking sound is heard from the outdoor unit sometimes.	④ This is not a malfunction. This is the sound when the fan of the outdoor unit is controlling the airflow amount in order to keep the optimum operating condition.	_____
	⑤ A sound, similar to water flowing, is heard from the unit.	⑤ This is not a malfunction. This is the sound when the refrigerant is flowing inside the indoor unit.	_____
Something is wrong with the blower.....	① The fan speed does not match the setting of the remote controller during DRY operation. (No air comes out sometimes during DRY operation.)	① This is not a malfunction. During the DRY operation, the blower's ON/OFF is controlled by the microprocessor to prevent overcooling and to ensure efficient dehumidification. The fan speed cannot be set by the remote controller during DRY operation.	_____
	② The fan speed does not match the setting of the remote controller in HEAT operation.	② This is not a malfunction. 1) When the HEAT operation starts, to prevent the unit from blowing cold air, the fan speed is gradually increased from zero to the set speed, in proportion to the temperature rise of the discharged air. 2) When the room temperature reaches the set temperature and the outdoor unit stops, the unit starts the LOW AIR operation. 3) During the HEAT operation, the DEFROST operation is performed to defrost the outdoor unit. During the DEFROST operation, the blower is stopped to prevent cold air coming out of the indoor unit.	The up/down vane will be automatically set to horizontal blow in these cases listed up on the left (①-③). After a while, the up/down vane will be automatically moved according to the setting of the remote controller.



Phone Calls From Customers	How to Respond	Note
Something is wrong with the blower.....	③ This is not a malfunction. The blower is operating just for cooling down the heated-up air conditioner. This will be done within 1 minute. This control is conducted only when the HEAT operation is stopped with the electric heater ON.	However, this control is also applied to the models which has no electric heater.
Something is wrong with the airflow direction....	① If the up/down vane is set to downward in COOL operation, it will be automatically set to horizontal blow by the microprocessor in order to prevent water from dropping down. “1 h” will be displayed on the remote controller if the up/down vane is set to downward with the fan speed set to be less than “LOW”.	_____
② The airflow direction is changed during HEAT operation. (The airflow direction cannot be set by remote controller.)	② In HEAT operation, the up/down vane is automatically controlled according to the temperature of the indoor unit’s heat exchanger. In the following cases written below, the up/down vane will be set to horizontal blow, and the setting cannot be changed by remote controller. 1) At the beginning of the HEAT operation 2) While the outdoor unit is being stopped by thermostat or when the outdoor unit gets started to operate. 3) During DEFROST operation The airflow direction will be back to the setting of remote controller when the above situations are released.	“Heat Standby” will be displayed on the remote controller in the case of ① and ②. “Heat Defrost” will be displayed on the screen in the case of ③.
③ The airflow direction does not change. (Up/down vane, left/right louver)	③ 1) Check if the vane is set to a fixed position. (Check if the vane motor connector is removed.) 2) Check if the air conditioner has a function for switching the air direction. 3) If the air conditioner does not have that function, “Unsupported function” will be displayed on the remote controller when “AIR DIRECTION” or “LOUVER” button is pressed.	_____
The air conditioner starts operating even though any buttons on the remote controller are not pressed.	① Check if you set ON/OFF timer. The air conditioner starts operating at the time designated if ON timer has been set before.	_____
	② Check if any operations are ordered by distant control system or the central remote controller. While “Centrally controlled” is displayed on the remote controller, the air conditioner is under the control of external directive.	There might be a case that “Centrally controlled” will not be displayed.
	③ Check if power is recovered from power failure (black out). The units will automatically start operating when power is recovered after power failure (black out) occurs. This function is called “auto recovery feature from power”.	_____
The air conditioner stops even though any buttons on the remote controller are not pressed.	① Check if you set ON/OFF timer. The air conditioner stops operating at the time designated if OFF timer has been set before. ② Check if any operations are ordered by distant control system or the central remote controller. While “Centrally controlled” is displayed on the remote controller, the air conditioner is under the control of external directive.	There might be a case that “Centrally controlled” will not be displayed.



Phone Calls From Customers	How to Respond	Note
A white mist is expelled from the indoor unit.	This is not a malfunction. This may occur when the operation is started in the room of high humidity.	_____
Water or moisture is expelled from the outdoor unit.	COOL: when pipes or piping joints are cooled, they sweat and water drips down. HEAT: water drips down from the heat exchanger. Note: Make use of optional parts "Drain Socket" and "Drain pan" if these water needs to be collected and drained out for once.	_____
The display of wireless remote controller gets dim or does not come on. The indoor unit does not receive a signal from remote controller at a long distance.	Batteries are being exhausted. Replace them and press the reset button of remote controller.	_____

10-6. HOW TO CHECK THE PARTS
PUZ-M200YKA.UK PUZ-M250YKA.UK

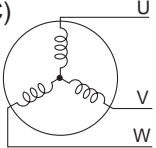
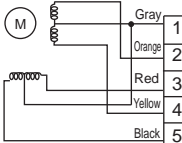
Parts name	Checkpoints																					
Thermistor (TH3) <Liquid> Thermistor (TH4) <Discharge> Thermistor (TH6) <2-phase pipe> Thermistor (TH7) <Ambient> Thermistor (TH8) <Heat sink> Thermistor (TH33) <Comp. Surface>	Disconnect the connector then measure the resistance with a tester. (At the ambient temperature 10 to 30°C) <table border="1" data-bbox="416 490 1115 721"> <thead> <tr> <th></th> <th colspan="2" data-bbox="587 499 850 528">Normal</th> <th colspan="2" data-bbox="850 499 1109 528">Abnormal</th> </tr> </thead> <tbody> <tr> <td data-bbox="416 528 587 566">TH4/TH33</td> <td colspan="2" data-bbox="587 528 850 566">160 to 410 kΩ</td> <td colspan="2" data-bbox="850 528 1109 566" rowspan="4">Open or short</td> </tr> <tr> <td data-bbox="416 566 587 604">TH3</td> <td colspan="2" data-bbox="587 566 850 604" rowspan="3">4.3 to 9.6 kΩ</td> </tr> <tr> <td data-bbox="416 604 587 642">TH6</td> </tr> <tr> <td data-bbox="416 642 587 680">TH7</td> </tr> <tr> <td data-bbox="416 680 587 719">TH8</td> <td colspan="2" data-bbox="587 680 850 719">39 to 105 kΩ</td> </tr> </tbody> </table>					Normal		Abnormal		TH4/TH33	160 to 410 kΩ		Open or short		TH3	4.3 to 9.6 kΩ		TH6	TH7	TH8	39 to 105 kΩ	
	Normal		Abnormal																			
TH4/TH33	160 to 410 kΩ		Open or short																			
TH3	4.3 to 9.6 kΩ																					
TH6																						
TH7																						
TH8	39 to 105 kΩ																					
Fan motor(MF1,MF2)	Refer to the next page.																					
Solenoid valve coil <4-way valve> (21S4)	Measure the resistance between the terminals with a tester. (At the ambient temperature 20°C) <table border="1" data-bbox="416 898 1498 1028"> <thead> <tr> <th colspan="3" data-bbox="416 898 1220 952">Normal</th> <th colspan="1" data-bbox="1220 898 1498 952">Abnormal</th> </tr> </thead> <tbody> <tr> <td colspan="3" data-bbox="416 952 1220 990">M200/250</td> <td data-bbox="1220 952 1498 990" rowspan="2">Open or short</td> </tr> <tr> <td colspan="3" data-bbox="416 990 1220 1028">1215 ± 122 Ω</td> </tr> </tbody> </table>				Normal			Abnormal	M200/250			Open or short	1215 ± 122 Ω									
Normal			Abnormal																			
M200/250			Open or short																			
1215 ± 122 Ω																						
Motor for compressor (MC) 	Measure the resistance between the terminals with a tester. (Winding temperature 20°C) <table border="1" data-bbox="416 1122 1498 1254"> <thead> <tr> <th colspan="3" data-bbox="416 1122 1220 1176">Normal</th> <th colspan="1" data-bbox="1220 1122 1498 1176">Abnormal</th> </tr> </thead> <tbody> <tr> <td colspan="3" data-bbox="416 1176 1220 1254">Refer to "5-3. COMPRESSOR TECHNICAL DATA".</td> <td data-bbox="1220 1176 1498 1254">Open or short</td> </tr> </tbody> </table>				Normal			Abnormal	Refer to "5-3. COMPRESSOR TECHNICAL DATA".			Open or short										
Normal			Abnormal																			
Refer to "5-3. COMPRESSOR TECHNICAL DATA".			Open or short																			
Linear expansion valve (LEV-A/LEV-B) 	Disconnect the connector then measure the resistance with a tester. (Winding temperature 20°C) <table border="1" data-bbox="416 1406 1498 1538"> <thead> <tr> <th colspan="4" data-bbox="416 1406 1220 1460">Normal</th> <th colspan="1" data-bbox="1220 1406 1498 1460">Abnormal</th> </tr> </thead> <tbody> <tr> <td data-bbox="416 1460 614 1498">Gray - Black</td> <td data-bbox="614 1460 813 1498">Gray - Red</td> <td data-bbox="813 1460 1013 1498">Gray - Yellow</td> <td data-bbox="1013 1460 1220 1498">Gray - Orange</td> <td data-bbox="1220 1460 1498 1498" rowspan="2">Open or short</td> </tr> <tr> <td colspan="4" data-bbox="416 1498 1220 1538">46 ± 3 Ω</td> </tr> </tbody> </table>				Normal				Abnormal	Gray - Black	Gray - Red	Gray - Yellow	Gray - Orange	Open or short	46 ± 3 Ω							
Normal				Abnormal																		
Gray - Black	Gray - Red	Gray - Yellow	Gray - Orange	Open or short																		
46 ± 3 Ω																						

Check method of DC fan motor (fan motor/outdoor controller circuit board)

① Notes

- High voltage is applied to the connector (CNF1, 2) for the fan motor. Pay attention to the service.
- Do not pull out the connector (CNF1, 2) for the motor with the power supply on.
(It causes trouble of the outdoor controller circuit board and fan motor.)

② Self check

Symptom : The outdoor fan cannot rotate.

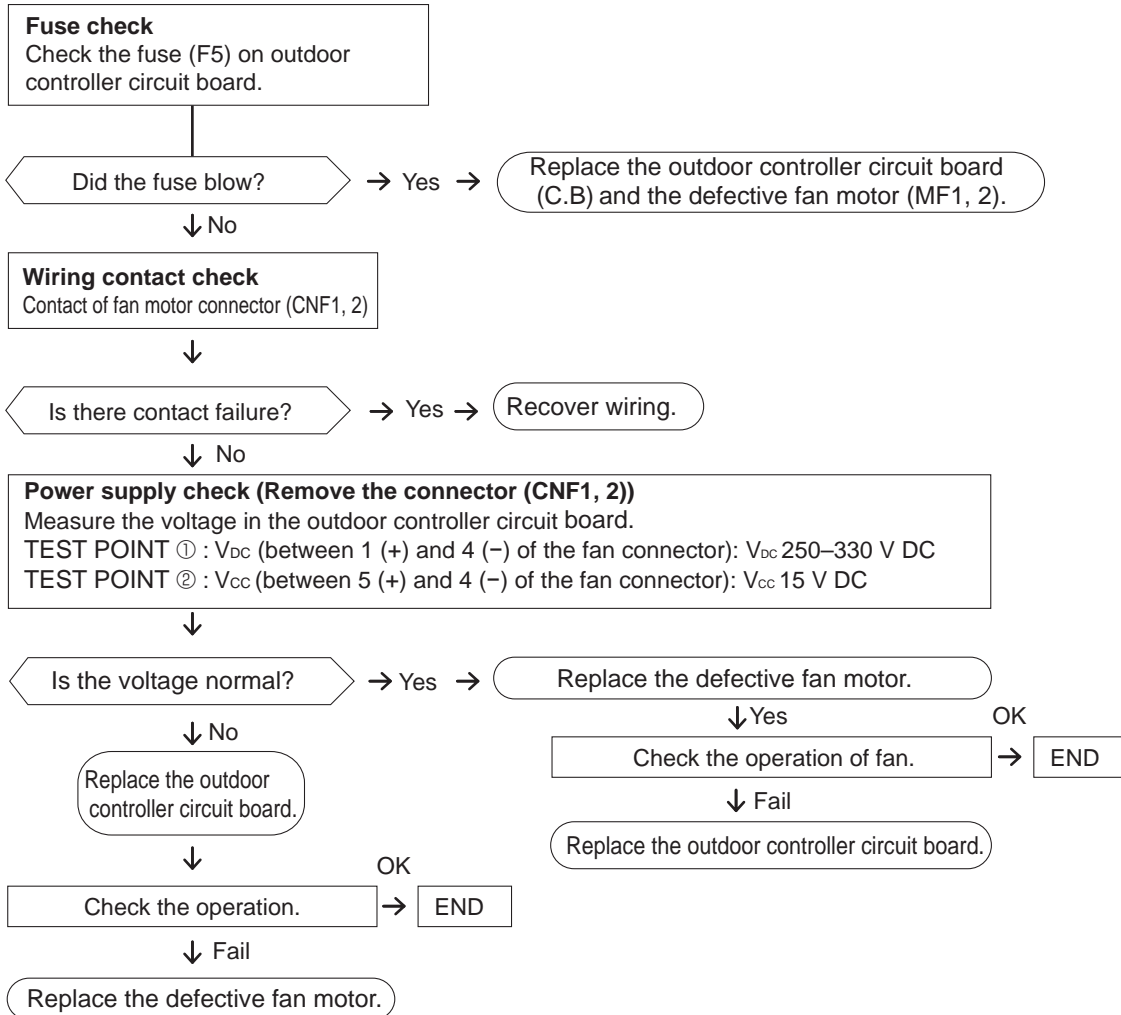

10-7. HOW TO CHECK THE COMPONENTS

<Thermistor feature chart>

Low temperature thermistors

- Thermistor <Liquid> (TH3)
- Thermistor <2-phase pipe> (TH6)
- Thermistor <Ambient> (TH7)

Thermistor R0 = 15 kΩ ± 3%
B constant = 3480 ± 2%

$$R_t = 15 \exp\left\{3480 \left(\frac{1}{273+t} - \frac{1}{273} \right)\right\}$$

0°C	15 kΩ	30°C	4.3 kΩ
10°C	9.6 kΩ	40°C	3.0 kΩ
20°C	6.3 kΩ		
25°C	5.2 kΩ		

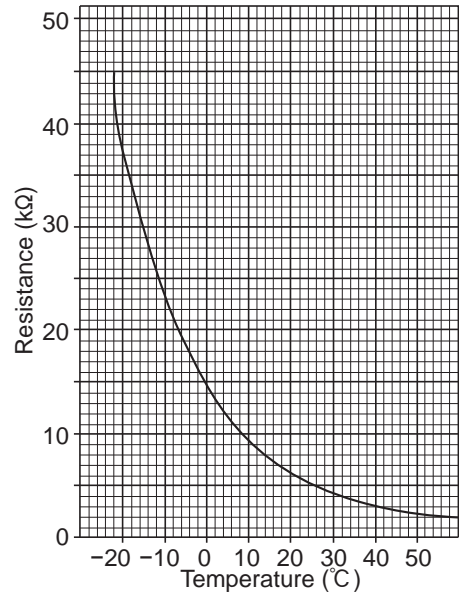

Medium temperature thermistor

- Thermistor <Heat Sink> (TH8)

Thermistor R50 = 17 kΩ ± 2%
B constant = 4150 ± 3%

$$R_t = 17 \exp\left\{4150 \left(\frac{1}{273+t} - \frac{1}{323} \right)\right\}$$

0°C	180 kΩ
25°C	50 kΩ
50°C	17 kΩ
70°C	8 kΩ
90°C	4 kΩ

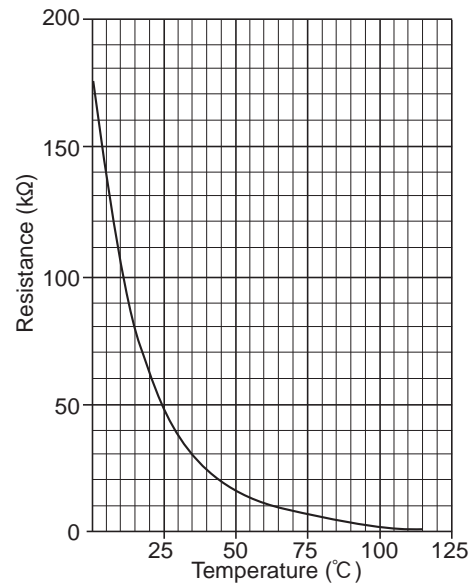

High temperature thermistors

- Thermistor <Discharge> (TH4)
- Thermistor <Comp. Surface> (TH33)

Thermistor R120 = 7.465 kΩ ± 2%
B constant = 4057 ± 2%

$$R_t = 7.465 \exp\left\{4057 \left(\frac{1}{273+t} - \frac{1}{393} \right)\right\}$$

20°C	250 kΩ	70°C	34 kΩ
30°C	160 kΩ	80°C	24 kΩ
40°C	104 kΩ	90°C	17.5 kΩ
50°C	70 kΩ	100°C	13.0 kΩ
60°C	48 kΩ	110°C	9.8 kΩ

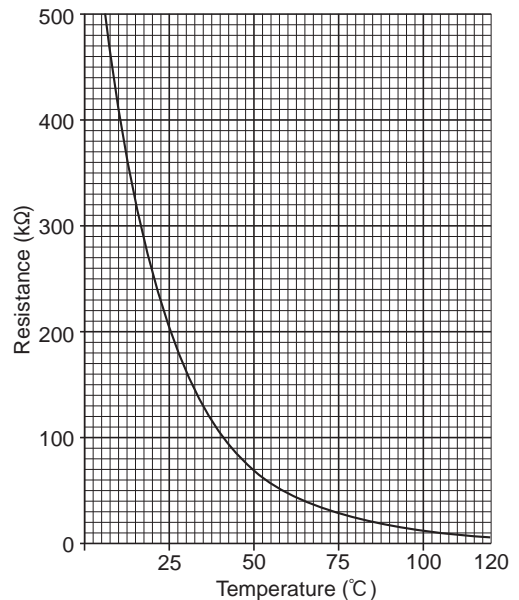

Linear expansion valve

(1) Operation summary of the linear expansion valve

- Linear expansion valve opens/closes through stepping motor after receiving the pulse signal from the outdoor controller circuit board.
 - Valve position can be changed in proportion to the number of pulse signal.
- <Connection between the outdoor controller board and the linear expansion valve>

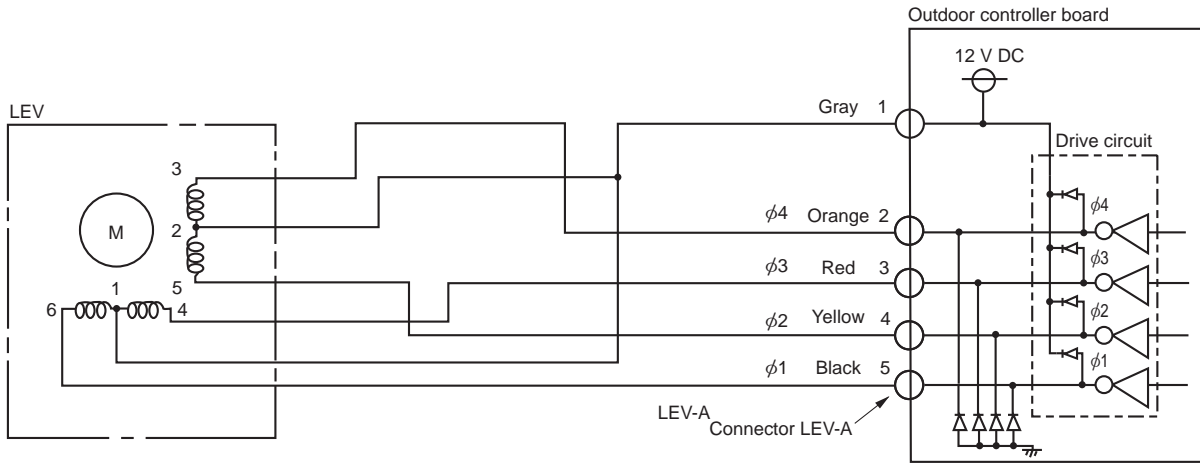

<Output pulse signal and the valve operation>

Output (Phase)	Output							
	1	2	3	4	5	6	7	8
$\phi 1$	ON	ON	OFF	OFF	OFF	OFF	OFF	ON
$\phi 2$	OFF	ON	ON	ON	OFF	OFF	OFF	OFF
$\phi 3$	OFF	OFF	OFF	ON	ON	ON	OFF	OFF
$\phi 4$	OFF	OFF	OFF	OFF	OFF	ON	ON	ON

The output pulse shifts in below order.

Opening a valve: 8 → 7 → 6 → 5 → 4 → 3 → 2 → 1 → 8

Closing a valve: 1 → 2 → 3 → 4 → 5 → 6 → 7 → 8 → 1

- When linear expansion valve operation stops, all output phases become OFF.

(2) Linear expansion valve operation

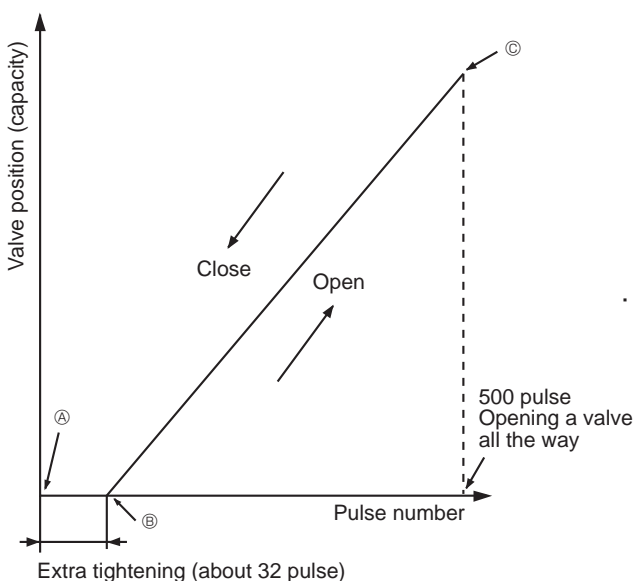

- When the power is turned on, 700 pulse closing valve signal will be sent till it goes to A point in order to define the valve position. (The pulse signal is being sent for about 20 seconds.)

When the valve moves smoothly, there is no sound or vibration occurring from the linear expansion valve : however, when the pulse number moves from B to A or when the valve is locked, more sound can be heard.

No sound is heard when the pulse number moves from A to B in case coil is burnt out or motor is locked by open-phase.

- Sound can be detected by placing the ear against the screw driver handle while putting the screw driver to the linear expansion valve.

(3) How to attach and detach the coil of linear expansion valve

<Composition>

Linear expansion valve is separable into the main body and the coil as shown in the diagram below.

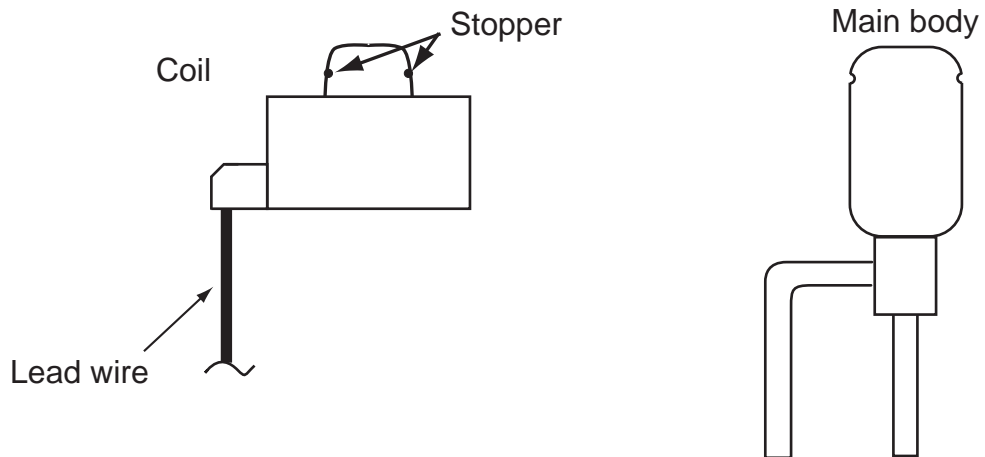

<How to detach the coil>

Hold the lower part of the main body (shown as A) firmly so that the main body does not move and detach the coil by pulling it upward.

Be sure to detach the coil holding main body firmly. Otherwise pipes can bend due to stress.

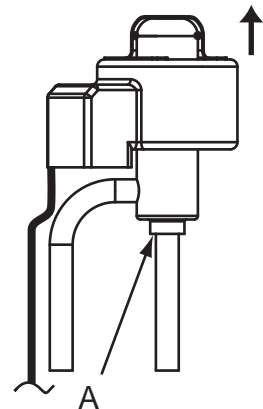

<How to attach the coil>

Hold the lower part of the main body (shown as A) firmly so that the main body does not move and attach the coil by inserting it downward into the main body. Then securely attach the coil stopper to main body. (At this time, be careful that stress is not added to lead wire and main body is not wound by lead wire.) If the stopper is not firmly attached to main body, coil may be detached from the main body and that can cause defective operation of linear expansion valve.

To prevent piping stress, be sure to attach the coil holding the main body of linear expansion valve firmly. Otherwise pipe may break.

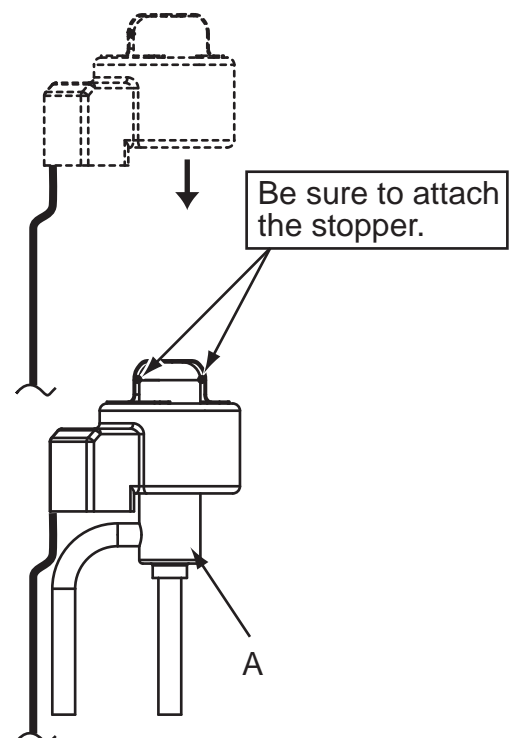

10-8. EMERGENCY OPERATION

(1) When any check codes shown below is displayed on outdoor unit, or microprocessor for wired remote controller or indoor unit has a failure while no other problems are found, emergency operation will be available by setting the emergency operation switch (SWE) ON and short-circuiting the connector (CN31) on outdoor controller board.

●When following abnormalities occur, emergency operation will be available.

Check code	Inspected content
U4	Open/short of outdoor unit thermistor (TH3/TH6/TH7/TH8)
E8	Indoor/outdoor unit communication error • Signal receiving error (Outdoor unit)
E9	Indoor/outdoor unit communication error • Transmitting error (Indoor unit)
E0–E7	Communication error other than outdoor unit
Ed	Communication error between outdoor controller board and M-NET board (Serial communication error)

(2) Check the following items and cautions for emergency operation

- ① Make sure that there is no abnormality in outdoor unit other than the above abnormalities. (Emergency operation will not be available when check code other than the above are indicated.)
- ② For emergency operation, it is necessary to set the emergency operation switch (SWE) on indoor controller board. Refer to the electrical wiring diagram of indoor unit for how to set the indoor unit.
- ③ During emergency operation, the air-conditioner will continuously be operated by supplying power and stopping it: It can not be turned on or off by remote control, and temperature control is not possible.
- ④ Do not perform emergency heating operation for an extended period of time: If the outdoor unit starts defrosting during this period, cold air will blow out from the indoor unit.
- ⑤ Do not perform emergency cooling operation for more than 10 hours: Neglecting this could result in freezing the heat exchanger in indoor unit.

(3) Emergency operation procedure

- ① Turn the main power supply off.
- ② Turn on the emergency operation switch (SWE) on indoor controller board.
- ③ Set the shorting pins of emergency operation connector (CN31) on outdoor controller board to ON.
- ④ Use SW4-2 on outdoor controller board to set the operation mode (cooling or heating). (SW4-1 is not used.)

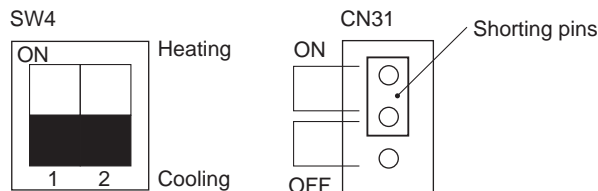

- ⑤ Turning the main power supply on will start the emergency operation.

(4) Releasing emergency operation

- ① Turn the main power supply off.
- ② Set the emergency operation switch (SWE) on indoor controller board to OFF.
- ③ Set the shorting pins of emergency operation connector (CN31) on outdoor controller board to OFF.
- ④ Set SW4-2 on outdoor controller board as shown in the right.

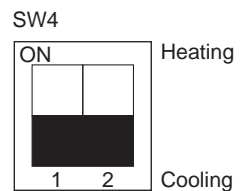

Note: If shorting pins are not set on emergency operation connector (CN31), the setting remains OFF.

(5) Operation data during emergency operation

During emergency operation, no communication is performed with the indoor unit, so the data items needed for operation are set to the following values:

Operation data	Operation mode		Remarks
	COOL	HEAT	
Intake temperature (TH1)	27°C	20.5°C	—
Indoor pipe temperature (TH2)	5°C	45°C	—
Indoor 2-phase pipe temperature (TH5)	5°C	50°C	—
Set temperature	25°C	22°C	—
Outdoor liquid pipe temperature (TH3)	45°C	5°C	(*1)
Outdoor discharge temperature (TH4) Outdoor comp. surface temperature (TH33)	80°C	80°C	(*1)
Outdoor 2-phase pipe temperature (TH6)	50°C	5°C	(*1)
Outdoor ambient temperature (TH7)	35°C	7°C	(*1)
Temperature difference code (room temperature - set temperature) (ΔT_j)	5	5	—
Discharge superheat (SHd)	30°C	30°C	(*2)
Sub-cool (SC)	5°C	5°C	(*2)

*1. If the thermistor temperature data is normal (not open/short), that data is loaded into the control as valid data. When the unit enters emergency operation and TH values are mismatched, set the thermistors to open/short. And the unit runs emergency operation with the values listed above.

*2. If one thermistor is set to open/short, the values for SHd/SC will be different from the list above. [Example] When liquid temperature thermistor (TH3) has an open or short circuit.

Thermistor	COOL	HEAT
TH3	45°C	5°C
TH6	Ta	Tb
	Regard normal figure as effective data.	
TH4/TH33	Tc	Td
	Regard normal figure as effective data.	
TH5	5°C	50°C
TH2	5°C	45°C

Discharge superheat (SHd)
Cooling = TH4(or TH33)-TH6 = Tc-Ta
Heating = TH4(or TH33)-TH5 = Td-50

Degree of subcooling (SC)
Cooling = TH6-TH3 = Ta-45
Heating = TH5-TH2 = 50-45 = 5°C

10-9. TEST POINT DIAGRAM

Outdoor controller circuit board
PUZ-M200YKA.UK

PUZ-M250YKA.UK

<CAUTION> TEST POINT① is high voltage.

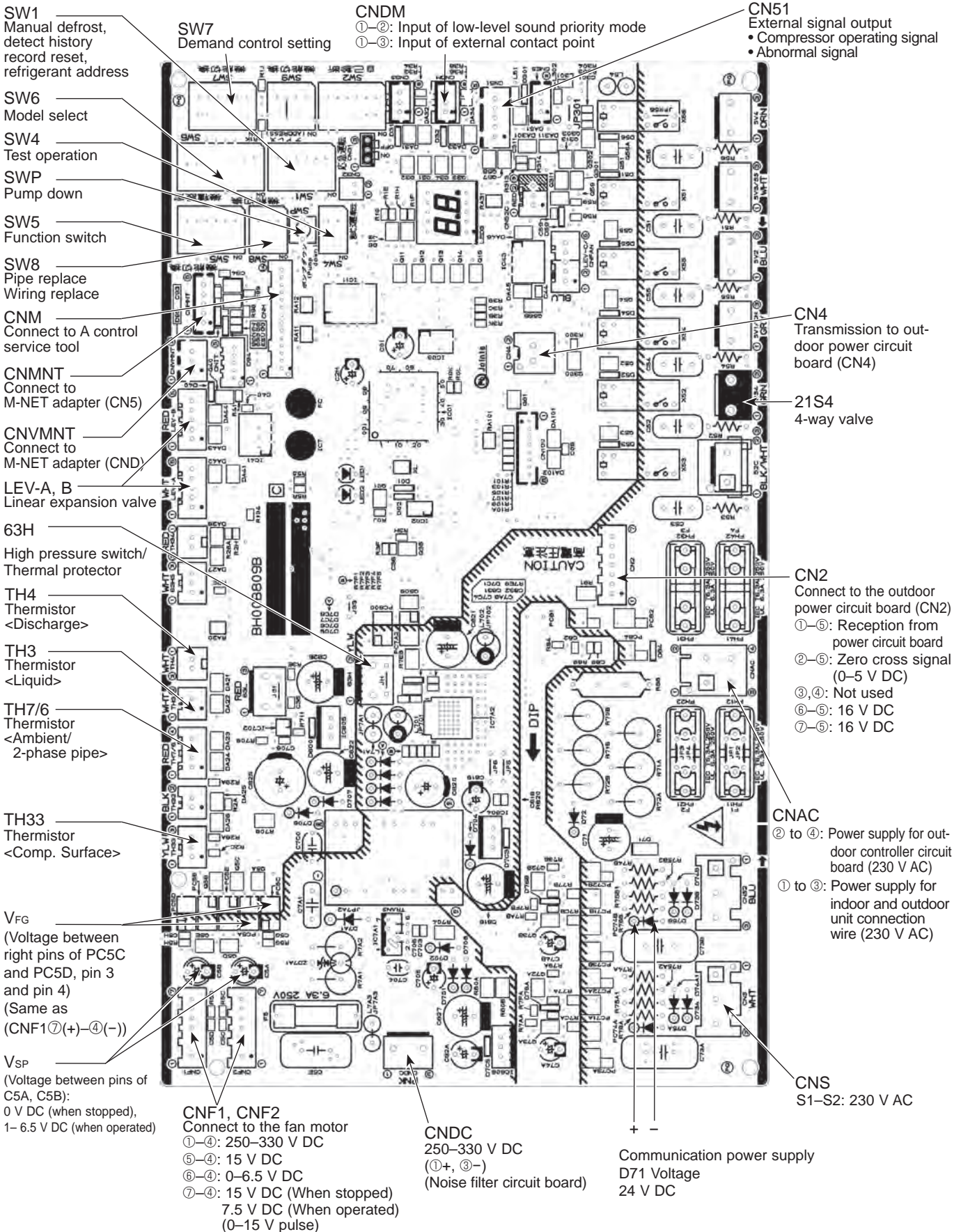

Outdoor noise filter circuit board
PUZ-M200YKA.UK **PUZ-M250YKA.UK**

LI1, LI2, LI3, NI
POWER SUPPLY
 LI1-LI2/LI2-LI3/LI3-LI1: 400 V AC input
 LI1-NI/LI2-NI/LI3-NI: 230 V AC input
 (Connect to the terminal block (TB1))

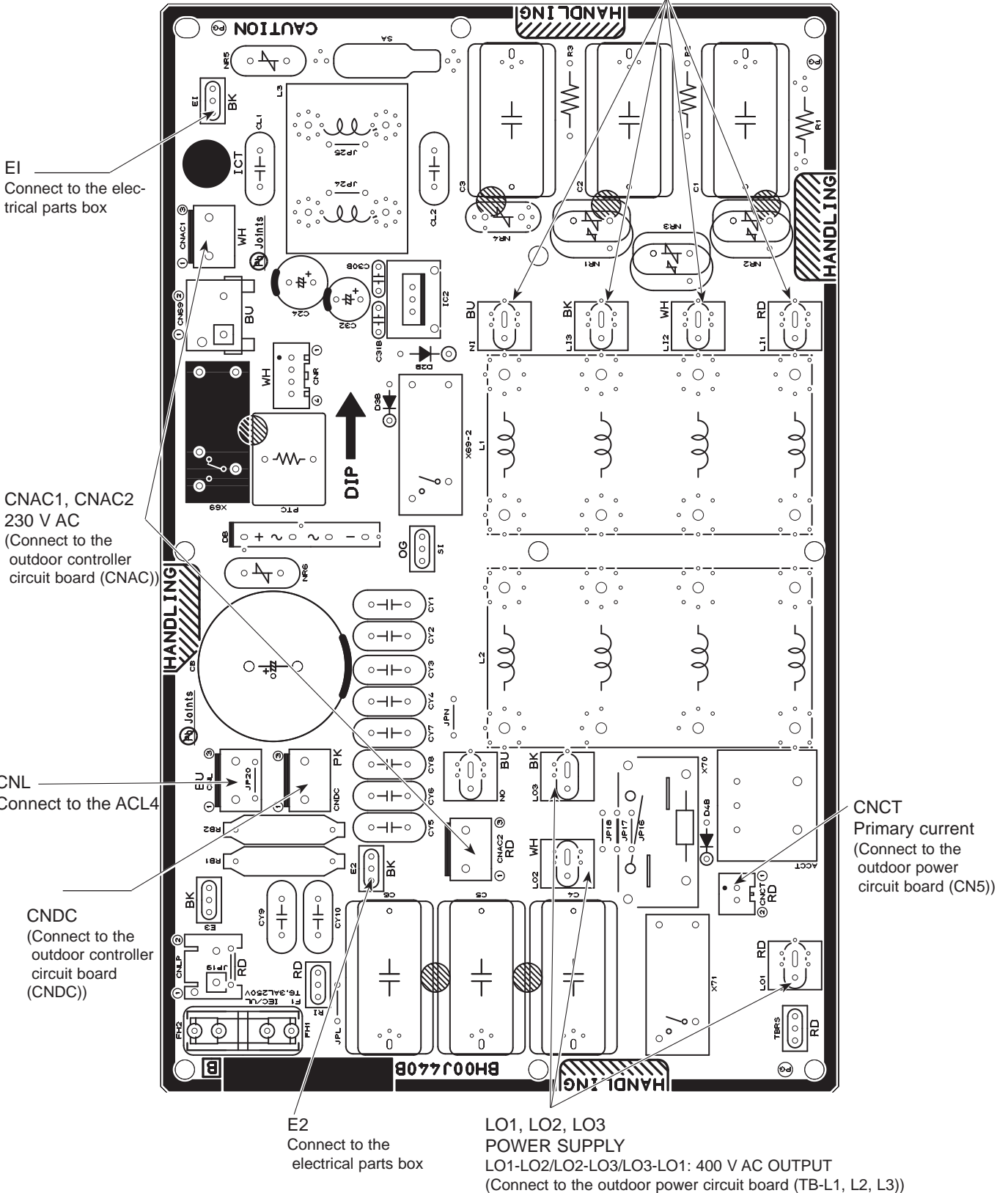

Outdoor power circuit board
PUZ-M200YKA.UK
PUZ-M250YKA.UK

Brief Check of POWER MODULE

Usually, they are in a state of being short-circuited if they are broken. Measure the resistance in the following points (connectors, etc.). If they are short-circuited, it means that they are broken.

1. Check of DIODE MODULE

L1-P1, **L2**-P1, **L3**-P1, **L1**-N1, **L2**-N1, **L3**-N1

2. Check of DIP-IPM

P2-U, **P2**-V, **P2**-W, **N2**-U, **N2**-V, **N2**-W

Note: The marks **L1**, **L2**, **L3**, **N1**, **N2**, **P1**, **P2**, **U**, **V** and **W** shown in the diagram are not actually printed on the board.

TB-P3
Connect to the DCL

TB-U, TB-V, TB-W
Connect to the compressor (MC)
Voltage among phases:
10-400 V AC

Diode module

TB-P1
Connect to the DCL

TAB connector
on X52CA
Connect to the
RS resistor

TB-L1,
TB-L2,
TB-L3
Connect to the outdoor
noise filter circuit board
(LO1, LO2, LO3)
400 V AC

CN4
Connect to the
outdoor controller
circuit board (CN4)

CN2
Connect to the outdoor controller circuit board (CN2)

①-⑤: Power circuit board → Transmitting
signal to the controller board (0-5 V DC)
②-⑤: Zero cross signal (0-5 V DC)

③-④: Not used

⑥-⑤: 16 V DC

⑦-⑤: 16 V DC

CN5
Detection of primary
current (Connect to
the outdoor noise filter
circuit board (CNCT))

CN6
Thermistor
<Heat sink> (TH8)

L3OUT-L3IN
Lead connect

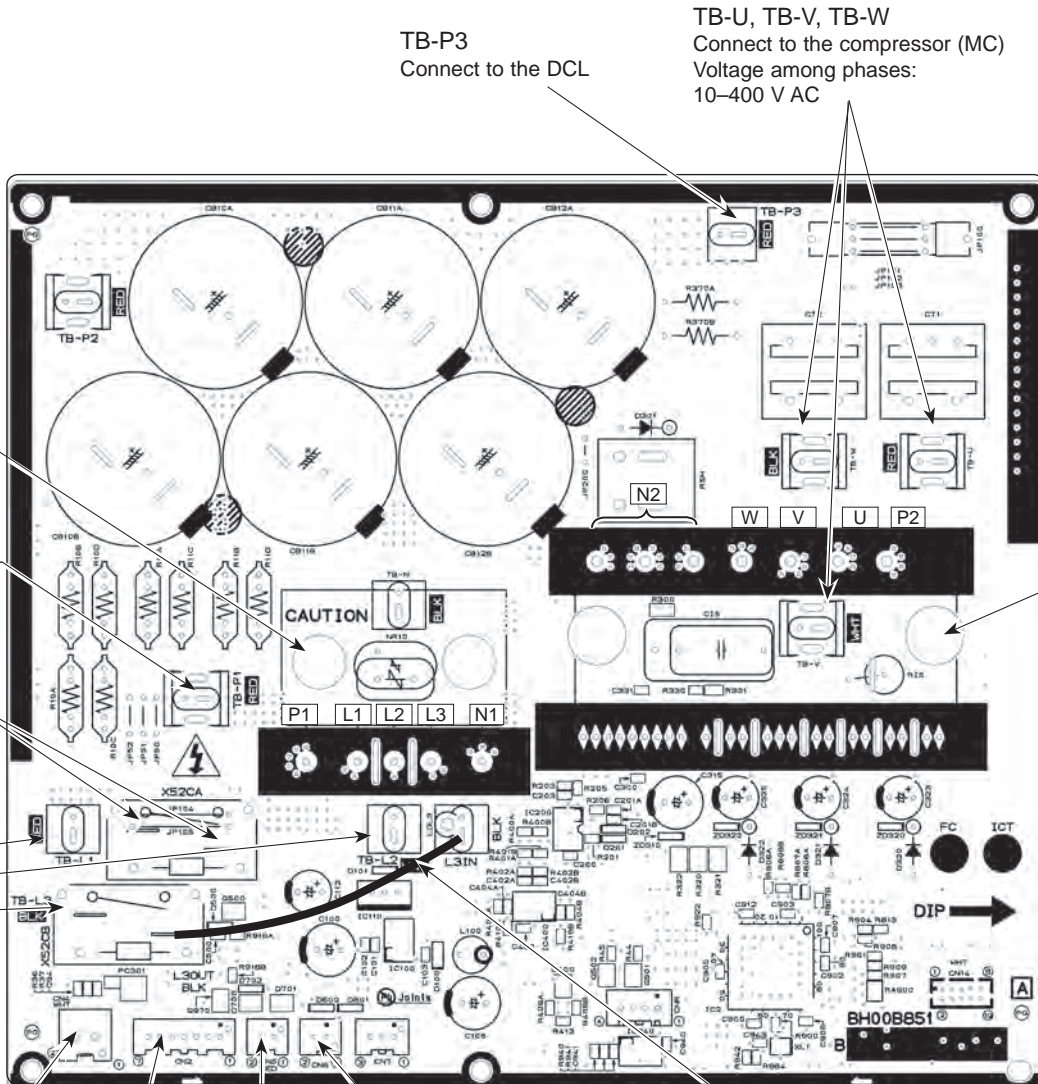

Outdoor M-NET board (optional)

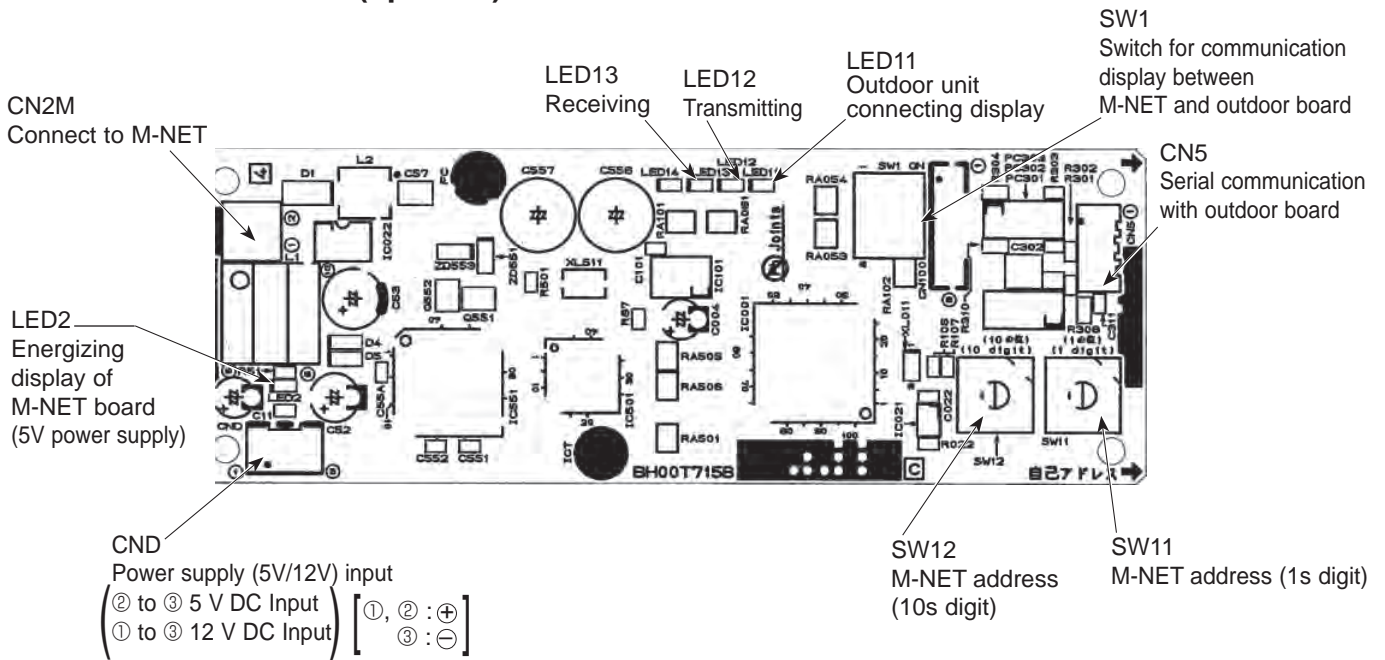

10-10. FUNCTION OF SWITCHES, CONNECTORS AND JUMPERS

(1) Function of switches

The black square (■) indicates a switch position.

Type of switch	Switch No.	Function	Action by the switch operation		Effective timing						
			ON	OFF							
DIP switch	SW1	1	Manual defrost *1	Start	Normal	When compressor is working in heating operation. *1					
		2	Abnormal history clear	Clear	Normal	off or operating					
		3-6	Refrigerant address setting	3	0	1	2	3	When power supply ON		
				4	4	5	6	7			
				5	8	9	10	11			
				6	12	13	14	15			
				1-2	SW4	1	Test run	Operating		OFF	Under suspension
						2	Test run mode setting	Heating		Cooling	
				Push switch	SWP	Pump down	Start	Normal		Under suspension	

*1 Manual defrost should be done as follows:

- ① Change the DIP SW1-1 on the outdoor controller board from OFF to ON.
- ② Manual defrost will start by the above operation ① if all these conditions written below are satisfied.
 - Heat mode setting
 - 10 minutes have passed since compressor started operating or previous manual defrost is finished.
 - Pipe temperature is less than or equal to 8°C.

Manual defrost will finish if certain conditions have been satisfied.

Manual defrost can be done if above conditions have been satisfied when DIP SW1-1 is changed from OFF to ON. After DIP SW1-1 is changed from OFF to ON, there is no problem if DIP SW1-1 is left ON or changed to OFF again. This depends on the service conditions.

Continue to the next page

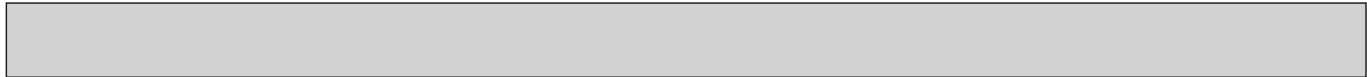

Type of Switch	Switch	No.	Function	Action by the switch operation		Effective timing
				ON	OFF	
DIP switch	SW5	1	No function	—	—	—
		2	Power failure automatic recovery *2	Auto recovery	No auto recovery	When power supply ON
		3,4,5	No function	—	—	—
		6	No function	—	—	—
	SW7*4	1	Mode select *3	Demand function	Low noise mode	Always
		2	No function	—	—	—
		3	Max Hz setting (cooling)	Max Hz (cooling) × 0.8	Normal	Always
		4	Max Hz setting (heating)	Max Hz (heating) × 0.8	Normal	Always
		5	No function	—	—	—
		6	Defrost setting	For high humidity	Normal	Always
	SW8	1	No function	—	—	—
		2	No function	—	—	—
		3	No function	—	—	—
	SW9	1	No function	—	—	—
		2	Function switch	Valid	Normal	Always
		3,4	No function	—	—	—
	SW6	1	No function	—	—	—
		2				
		3				
		4	Model select	—	—	—
		5				
		6				
		7				
		8				

MODEL	SW6								
200Y	ON	<input type="checkbox"/>	<input type="checkbox"/>	<input type="checkbox"/>	<input type="checkbox"/>	<input type="checkbox"/>	<input type="checkbox"/>	<input type="checkbox"/>	<input type="checkbox"/>
	OFF	<input type="checkbox"/>	<input type="checkbox"/>	<input type="checkbox"/>	<input type="checkbox"/>	<input type="checkbox"/>	<input type="checkbox"/>	<input type="checkbox"/>	<input type="checkbox"/>
250Y	ON	<input type="checkbox"/>	<input type="checkbox"/>	<input type="checkbox"/>	<input type="checkbox"/>	<input checked="" type="checkbox"/>	<input checked="" type="checkbox"/>	<input checked="" type="checkbox"/>	<input checked="" type="checkbox"/>
	OFF	<input type="checkbox"/>	<input type="checkbox"/>	<input type="checkbox"/>	<input type="checkbox"/>	<input type="checkbox"/>	<input type="checkbox"/>	<input type="checkbox"/>	<input type="checkbox"/>

The black square (■) indicates a switch position.

*2 'Power failure automatic recovery' can be set by either remote controller or this DIP SW. If one of them is set to ON, 'Auto recovery' activates. Please set "Auto recovery" basically by remote controller because all units do not have DIP SW. Please refer to the indoor unit installation manual.

*3 SW7-1 is setting change over of Demand/Low noise. It is effective only in the case of external input. (Local wiring is necessary. Refer to the next page: Special function)

*4 Please do not use SW7-3 to 7-6 usually. Trouble might be caused by the usage condition.

*5 SW5-1 to 5: Function switch

(2) Function of connector

Types	Connector	Function	Action by open/ short operation		Effective timing
			Short	Open	
Connector	CN31	Emergency operation	Start	Normal	When power supply ON

Special function

(a) Low-level sound priority mode (Local wiring)

By performing the following modification, operation noise of the outdoor unit can be reduced by about 3-4 dB.

The low noise mode will be activated when a commercially available timer or the contact input of an ON/OFF switch is added to the CNDM connector (option) on the control board of the outdoor unit.

• The ability varies according to the outdoor temperature and conditions, etc.

① Complete the circuit as shown when using the external input adapter (PAC-SC36NA-E). (Option)

② SW7-1 (Outdoor unit control board): OFF

③ SW1 ON: Low noise mode

SW1 OFF: Normal operation

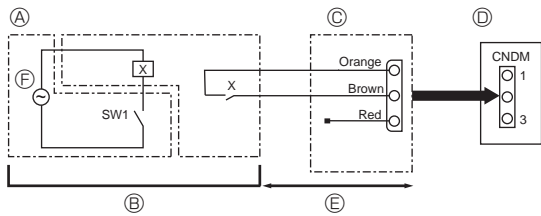

Ⓐ Circuit diagram example (low noise mode)
 Ⓑ On-site arrangement
 Ⓒ External input adapter (PAC-SC36NA-E)

X: Relay
 Ⓓ Outdoor unit control board
 Ⓔ Maximum 10 m
 Ⓕ Power supply for relay

(b) On demand control (Local wiring)

By performing the following modification, energy consumption can be reduced to 0–100% of the normal consumption.

The demand function will be activated when a commercially available timer or the contact input of an ON/OFF switch is added to the CNDM connector (option) on the control board of the outdoor unit.

① Complete the circuit as shown when using the external input adapter (PAC-SC36NA-E). (Option)

② By setting SW7-1 on the control board of the outdoor unit, the energy consumption (compared to the normal consumption) can be limited as shown below.

	SW7-1	SW2	SW3	Energy consumption
Demand function	ON	OFF	OFF	100%
		ON	OFF	75%
		ON	ON	50%
		OFF	ON	0% (Stop)

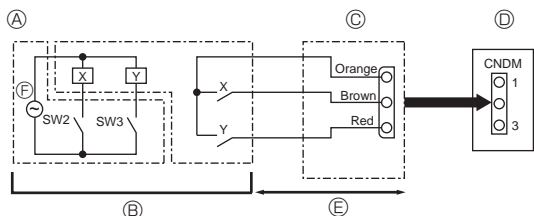

Ⓐ Circuit diagram example (Demand function)
 Ⓑ On-site arrangement
 X, Y: Relay

Ⓒ External input adapter (PAC-SC36NA-E)
 Ⓓ Outdoor unit control board
 Ⓔ Maximum 10 m
 Ⓕ Power supply for relay

<Display function of inspection for outdoor unit>

The blinking patterns of both LED1 (green) and LED2 (red) indicate the types of abnormality when it occurs. Types of abnormality can be indicated in details by connecting an optional part 'A-Control Service Tool (PAC-SK52ST)' to connector CNM on outdoor controller board.

[Display]

(1) Normal condition

Unit condition	Outdoor controller board		A-Control Service Tool	
	LED1 (Green)	LED2 (Red)	Check code	Indication of the display
When the power is turned on	Lit	Lit	— ⇄ —	Alternately blinking display
When unit stops	Lit	Not lit	00, etc.	Operation mode
When compressor is warming up	Lit	Not lit	08, etc.	
When unit operates	Lit	Lit	C5, H7, etc.	

(2) Abnormal condition

Indication		Error			
Outdoor controller board		Contents	Check code *1	Inspection method	Detailed reference page
LED1 (Green)	LED2 (Red)				
1 blinking	2 blinking	Connector (63H/TRS) is open.	F5	①Check if connector (63H and TRS) on the outdoor controller board is not disconnected. ②Check continuity of pressure switch (63H)/ Thermal protector (TRS) by tester.	P.35
2 blinking	1 blinking	Miswiring of indoor/outdoor unit connecting wire, excessive number of indoor units (5 units or more)	—	①Check if indoor/outdoor connecting wire is connected correctly. ②Check if 4 or more indoor units are connected to outdoor unit.	P.36(EA)
		Miswiring of indoor/outdoor unit connecting wire (converse wiring or disconnection)	—	③Check if noise entered into indoor/outdoor connecting wire or power supply.	P.36(Eb)
		Startup time over	—	④Re-check error by turning off power, and on again.	P.36(EC)
	2 blinking	Indoor/outdoor unit communication error (signal receiving error) is detected by indoor unit.	E6	①Check if indoor/outdoor connecting wire is connected correctly. ②Check if noise entered into indoor/outdoor connecting wire or power supply.	P.42
		Indoor/outdoor unit communication error (transmitting error) is detected by indoor unit.	E7	③Check if noise entered into indoor/outdoor controller board.	P.42
		Indoor/outdoor unit communication error (signal receiving error) is detected by outdoor unit.	—	④Re-check error by turning off power, and on again.	P.42(E8)
		Indoor/outdoor unit communication error (transmitting error) is detected by outdoor unit.	—		P.42(E9)
	3 blinking	Remote controller signal receiving error is detected by remote controller.	E0	①Check if connecting wire of indoor unit or remote controller is connected correctly.	P.41
		Remote controller transmitting error is detected by remote controller.	E3	②Check if noise entered into transmission wire of remote controller.	P.41
		Remote controller signal receiving error is detected by indoor unit.	E4	③Re-check error by turning off power, and on again.	P.41
Remote controller transmitting error is detected by indoor unit.		E5		P.41	
4 blinking	Abnormal if a connection of indoor unit and outdoor unit which uses different refrigerant is detected.	EE	Check if indoor/outdoor unit combination is authorized.	P.42	
	Check code is not defined.	EF	①Check if noise entered into transmission wire of remote controller. ②Check if noise entered into indoor/outdoor connecting wire. ③Re-check error by turning off power, and on again.	P.42	
		PL	①Be sure to replace the 4-way valve. ②Check refrigerant pipes for disconnection or leakage. ③After the recovery of refrigerant, vacuum dry the whole refrigerant circuit. ④Refer to "10-6.HOW TO CHECK THE PARTS". ⑤Check refrigerant circuit for operation.	P.43	
5 blinking	Serial communication error <Communication between outdoor controller board and outdoor power board>	Ed	①Check if connector (CN4) on outdoor controller board and outdoor power board is not disconnected. ②Check if there is poor connection of connector on outdoor controller board (CNMNT and CNVMNT). ③Check M-NET communication signal.	P.43	
	Communication error of M-NET system				A0-A8

Indication		Error			
Outdoor controller board		Contents	Check code *1	Inspection method	Detailed reference page
LED1 (Green)	LED2 (Red)				
3 blinking	1 blinking	Abnormality of discharge thermistor/comp. surface thermistor (TH4/TH33)	U2	①Check if stop valves are open. ②Check if connectors (TH4,TH33, LEV-A, LEV-B) on outdoor controller board are not disconnected. ③Check if unit is filled with specified amount of refrigerant. ④Measure resistance values among terminals on indoor valve and outdoor linear expansion valve using a tester.	P.37
		Abnormality of superheat due to low discharge temperature	U7		P.38
	2 blinking	Abnormal high pressure(63H operated)/High compressor temperature (TRS operated)	U1	①Check if indoor/outdoor units have a short cycle on their air ducts. ②Check if connector (63H and TRS) on outdoor controller board is not disconnected. ③Check if heat exchanger and filter is not dirty. ④Measure resistance values among terminals on linear expansion valve using a tester. ⑤Check if stop valves are open. ⑥Check if unit is filled with specified amount of refrigerant.	P.37
	3 blinking	Abnormality of outdoor fan motor rotational speed Protection from overheat operation(TH3)	U8	①Check the outdoor fan motor. ②Check if connector (TH3) on outdoor controller board is disconnected.	P.38
			Ud		P.40
	4 blinking	Compressor overcurrent breaking(Startup locked) Compressor overcurrent breaking Abnormality of current sensor (P.B.) Abnormality of power module	UF	①Check if stop valves are open. ②Check looseness, disconnection, and converse connection of compressor wiring. ③Measure resistance values among terminals on compressor using a tester. ④Check if outdoor unit has a short cycle on its air duct.	P.40
			UP		P.40
			UH		P.40
			U6		P.38
	5 blinking	Open/short of discharge thermistor (TH4) and comp. surface thermistor (TH33) Open/short of outdoor thermistors (TH3, TH6, TH7 and TH8)	U3	①Check if connectors(TH3,TH4,TH6,TH7 and TH33) on outdoor controller board and connector (CN3) on outdoor power board are not disconnected. ②Measure resistance value of outdoor thermistors.	P.37
			U4		P.38
	6 blinking	Abnormality of heat sink temperature	U5	①Check if indoor/outdoor units have a short cycle on their air ducts. ②Measure resistance value of outdoor thermistor(TH8).	P.38
7 blinking	Abnormality of voltage	U9	①Check looseness, disconnection, and converse connection of compressor wiring. ②Measure resistance value among terminals on compressor using a tester. ③Check if power supply voltage decreases. ④Check the wiring of CN52C.	P.39	
4 blinking	1 blinking	Abnormality of room temperature thermistor (TH1)	P1	①Check if connectors (CN20, CN21, CN29 and CN44) on indoor controller board are not disconnected. ②Measure resistance value of indoor thermistors.	*2
		Abnormality of pipe temperature thermistor / Liquid (TH2)	P2		*2
		Abnormality of pipe temperature thermistor/ Condenser-Evaporator	P9		*2
	2 blinking	Abnormality of drain sensor (DS) Float switch(FS) connector open Indoor drain overflow protection Leakage error (refrigerant system)	P4	①Check if connector (CN31)(CN4F) on indoor controller board is not disconnected. ②Measure resistance value of indoor thermistors. ③Measure resistance value among terminals on drain pump using a tester. ④Check if drain pump works. ⑤Check drain function.	*2
			PA		
	3 blinking	Freezing (cooling)/overheating (heating) protection	P6	①Check if indoor unit has a short cycle on its air duct. ②Check if heat exchanger and filter is not dirty. ③Measure resistance value on indoor and outdoor fan motors. ④Check if the inside of refrigerant piping is not clogged.	*2
	4 blinking	Abnormality of pipe temperature	P8	①Check if indoor thermistors(TH2 and TH5) are not disconnected from holder. ②Check if stop valve is open. ③Check converse connection of extension pipe. (on plural units connection) ④Check if indoor/outdoor connecting wire is connected correctly. (on plural units connection)	*2
	5 blinking	Indoor unit fan motor error	PB(Pb)	Defective fan motor winding	*2

*1 Check code displayed on remote controller

*2 Refer to the indoor unit's service manual.

<Outdoor unit operation monitor function>

[When optional part 'A-Control Service Tool (PAC-SK52ST)' is connected to outdoor controller board (CNM)]

Digital indicator LED1 displays 2 digit number or code to inform operation condition and the meaning of check code by controlling DIP SW2 on 'A-Control Service Tool'.

Operation indicator SW2: Indicator change of self-diagnosis

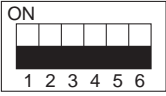
SW2 setting	Display detail	Explanation for display	Unit
			

<Digital indicator LED1 working details>

(Be sure that the 1 to 6 in the SW2 are set to OFF.)

- (1) Display when the power supply ON
When the power supply ON, blinking displays by turns.
Wait for 4 minutes at the longest.
- (2) When the display lights (Normal operation)
 - ① Operation mode display

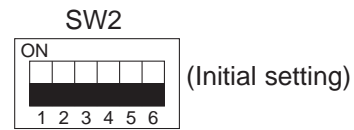
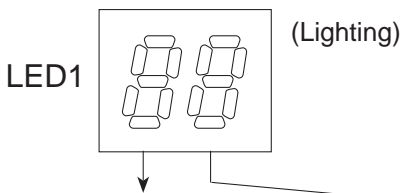
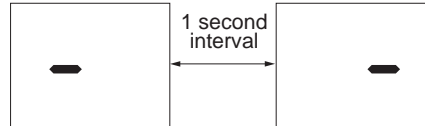

The tens digit: Operation mode

Display	Operation Mode
O	OFF/FAN
C	COOLING/DRY
H	HEATING
d	DEFROSTING

The ones digit: Relay output

Display	Warming-up Compressor	Compressor	4-way valve	Solenoid valve
0	—	—	—	—
1	—	—	—	ON
2	—	—	ON	—
3	—	—	ON	ON
4	—	ON	—	—
5	—	ON	—	ON
6	—	ON	ON	—
7	—	ON	ON	ON
8	ON	—	—	—
A	ON	—	ON	—

- ② Display during error postponement
Postponement code is displayed when compressor stops due to the work of protection device.
Postponement code is displayed while error is being postponed.





- (3) When the display blinks
Inspection code is displayed when compressor stops due to the work of protection devices.

Display	Inspection unit
0	Outdoor unit
1	Indoor unit 1
2	Indoor unit 2
3	Indoor unit 3
4	Indoor unit 4

Display	Contents to be inspected (During operation)
U1	Abnormal high pressure(63H operated)/High compressor temperature (TRS operated)
U2	Abnormal high discharge temperature and comp. surface thermistor, shortage of refrigerant
U3	Open/short circuit of discharge thermistor(TH4) and comp. surface thermistor (TH33)
U4	Open/short of outdoor unit thermistors (TH3, TH6, TH7 and TH8)
U5	Abnormal temperature of heat sink
U6	Abnormality of power module
U7	Abnormality of superheat due to low discharge temperature
U8	Abnormality in outdoor fan motor
Ud	Overheat protection
UF	Compressor overcurrent interruption (When Comp. locked)
UH	Current sensor error
UL	Abnormal low pressure
UP	Compressor overcurrent interruption
PL	Abnormality of refrigerant
P1-Pb	Abnormality of indoor units
A0-A7	Communication error of M-NET system

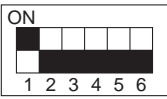
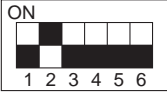
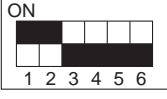
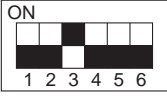
Display	Contents to be inspected (When power is turned on)
F5	63H connector(yellow) is open/TRS connector is open
E8	Indoor/outdoor communication error (Signal receiving error) (Outdoor unit)
E9	Indoor/outdoor communication error (Transmitting error) (Outdoor unit)
EA	Miswiring of indoor/outdoor unit connecting wire, excessive number of indoor units (4 units or more)
Eb	Miswiring of indoor/outdoor unit connecting wire(reversed wiring or disconnection)
EC	Startup time over
E0-E7	Communication error except for outdoor unit

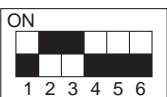
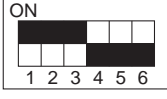
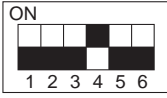
The black square (■) indicates a switch position.

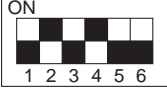
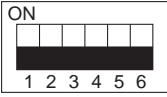
SW2 setting	Display detail	Explanation for display	Unit
	Pipe temperature/Liquid (TH3) -60 to 91	-60 to 91 (When the coil thermistor detects 0°C or below, “-” and temperature are displayed by turns.) (Example) When -10°C; 0.5 s 0.5 s 2 s -□ →10 →□□	°C
	Discharge temperature (TH4) -52 to 221	-52 to 221 (When the discharge thermistor detects 100°C or more, hundreds digit, tens digit and ones digit are displayed by turns.) (Example) When 105°C; 0.5 s 0.5 s 2 s □1 →05 →□□	°C
	Output step of outdoor FAN 0 to 10	0 to 10	Step
	The number of ON/OFF times of compressor 0 to 9999	0 to 9999 (When the number of times is 100 or more, hundreds digit, tens digit and ones digit are displayed by turns.) (Example) When 42500 times (425 ×100 times); 0.5 s 0.5 s 2 s □4 →25 →□□	100 times
	Compressor integrating operation times 0 to 9999	0 to 9999 (When it is 100 hours or more, hundreds digit, tens digit and ones digit are displayed by turns.) (Example) When 2450 hours (245 ×10 hours); 0.5 s 0.5 s 2 s □2 →45 →□□	10 hours
	Compressor operating current 0 to 50	0 to 50 (Omit the figures after the decimal fractions.)	A
	Compressor operating frequency 0 to 255	0 to 255 (When it is 100 Hz or more, hundreds digit, tens digit and ones digit are displayed by turns.) (Example) When 125Hz; 0.5 s 0.5 s 2 s □1 →25 →□□	Hz
	LEV-A opening pulse 0 to 480	0 to 480 (When it is 100 pulse or more, hundreds digit, tens digit and ones digit are displayed by turns.) (Example) When 150 pulse; 0.5 s 0.5 s 2 s □1 →50 →□□	Pulse
	Error postponement code history (1) of outdoor unit	Postponement code display Blinking: During postponement Lighting: Cancellation of postponement “00” is displayed in the case of no postponement.	Code display
	Operation mode on error occurring	Operation mode of when operation stops due to error is displayed by setting SW2 like below. (SW2) 	Code display

The black square (■) indicates a switch position.

SW2 setting	Display detail	Explanation for display	Unit
	Pipe temperature/Liquid (TH3) on error occurring -60 to 91	-60 to 91 (When the coil thermistor detects 0°C or below, “-” and temperature are displayed by turns.) (Example) When -15°C; 0.5 s 0.5 s 2 s -□ → 15 → □□ ↑	°C
	Discharge temperature (TH4) on error occurring -52 to 221	-52 to 221 (When the temperature is 100°C or more, the hundreds digit, tens digit and ones digit are displayed by turns.) (Example) When 130°C; 0.5 s 0.5 s 2 s □1 → 30 → □□ ↑	°C
	Compressor operating current on error occurring 0 to 50	0 to 50	A
	Error history (1) (latest) Alternate display of abnormal unit number and code	When no error history, “ 0 ” and “ - ” are displayed by turns.	Code display
	Error history (2) Alternate display of error unit number and code	When no error history, “ 0 ” and “ - ” are displayed by turns.	Code display
	Thermostat ON time 0 to 999	0 to 999 (When it is 100 minutes or more, the hundreds digit, tens digit and ones digit are displayed by turns.) (Example) When 245 minutes; 0.5 s 0.5 s 2 s □2 → 45 → □□ ↑	Minute
	Test run elapsed time 0 to 120	0 to 120 (When it is 100 minutes or more, the hundreds digit, tens digit and ones digit are displayed by turns.) (Example) When 105 minutes; 0.5 s 0.5 s 2 s □1 → 05 → □□ ↑	Minute

The black square (■) indicates a switch position.

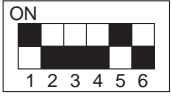
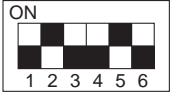
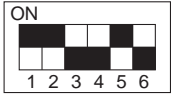
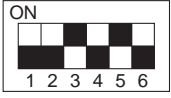
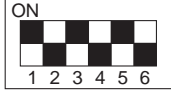
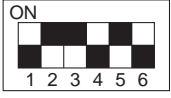
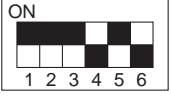
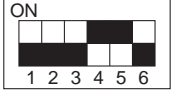
SW2 setting	Display detail	Explanation for display	Unit										
	The number of connected indoor units	0 to 4 (The number of connected indoor units are displayed.)	Unit										
	Capacity setting display	Displayed as an outdoor capacity code. <table border="1" data-bbox="821 526 1276 616"> <thead> <tr> <th>Capacity</th> <th>Code</th> </tr> </thead> <tbody> <tr> <td>M200</td> <td>40</td> </tr> <tr> <td>M250</td> <td>50</td> </tr> </tbody> </table>	Capacity	Code	M200	40	M250	50	Code display				
Capacity	Code												
M200	40												
M250	50												
	Outdoor unit setting information	<ul style="list-style-type: none"> The tens digit (Total display for applied setting) <table border="1" data-bbox="829 761 1396 884"> <thead> <tr> <th>Setting details</th> <th>Display details</th> </tr> </thead> <tbody> <tr> <td>H·P / Cooling only</td> <td>0: H·P 1: Cooling only</td> </tr> <tr> <td>Single phase / 3 phase</td> <td>0: Single phase 2: 3 phase</td> </tr> </tbody> </table> The ones digit <table border="1" data-bbox="829 929 1396 1019"> <thead> <tr> <th>Setting details</th> <th>Display details</th> </tr> </thead> <tbody> <tr> <td>Defrosting switch</td> <td>0: Normal 1: For high humidity</td> </tr> </tbody> </table> <p>(Example) When heat pump, 3 phase and defrosting (normal) are set up, "20" is displayed.</p>	Setting details	Display details	H·P / Cooling only	0: H·P 1: Cooling only	Single phase / 3 phase	0: Single phase 2: 3 phase	Setting details	Display details	Defrosting switch	0: Normal 1: For high humidity	Code display
Setting details	Display details												
H·P / Cooling only	0: H·P 1: Cooling only												
Single phase / 3 phase	0: Single phase 2: 3 phase												
Setting details	Display details												
Defrosting switch	0: Normal 1: For high humidity												
	Indoor pipe temperature/Liquid (TH2(1)) Indoor 1 -39 to 88	-39 to 88 (When the temperature is 0°C or less, "-" and temperature are displayed by turns.)	°C										
	Indoor pipe temperature/Cond./Eva. (TH5(1)) Indoor 1 -39 to 88	-39 to 88 (When the temperature is 0°C or less, "-" and temperature are displayed by turns.)	°C										
	Indoor pipe temperature/Liquid (TH2(2)) Indoor 2 -39 to 88	-39 to 88 (When the temperature is 0°C or less, "-" and temperature are displayed by turns.)	°C										
	Indoor pipe temperature/Cond./Eva. (TH5(2)) Indoor 2 -39 to 88	-39 to 88 (When the temperature is 0°C or less, "-" and temperature are displayed by turns.)	°C										
	Indoor room temperature (TH1) 8 to 39	8 to 39	°C										







The black square (■) indicates a switch position.

SW2 setting	Display detail	Explanation for display	Unit																		
	Indoor setting temperature 17 to 30	17 to 30	°C																		
	Outdoor pipe temperature/2-phase (TH6) -60 to 91	-60 to 91 (When the temperature is 0°C or less, “-” and temperature are displayed by turns.)	°C																		
	Outdoor Ambient temperature (TH7) -60 to 91	-60 to 91 (When the temperature is 0°C or less, “-” and temperature are displayed by turns.)	°C																		
	Outdoor Heat sink temperature (TH8) -40 to 200	-40 to 200 (When the temperature is 0°C or less, “-” and temperature are displayed by turns.) (When the thermistor detects 100°C or more, hundreds digit, tens digit and ones digit are displayed by turns.)	°C																		
	Discharge superheat SHd 0 to 255 [Cooling = TH4-TH6] [Heating = TH4-TH5]	0 to 255 (When the temperature is 100°C or more, hundreds digit, tens digit and ones digit are displayed by turns.)	°C																		
	Number of defrost cycles 0 to FFFE	0 to FFFE (in hexadecimal notation) (When more than FF in hex (255 in decimal), the number is displayed in order of 16 ³ 's and 16 ² 's, and 16 ¹ 's and 16 ⁰ 's places. (Example) When 5000 cycles; 0.5 s 0.5 s 2 s □9 → C4 → □□	2 cycles																		
	Input current of outdoor unit	0 to 500 (When it is 100 or more, hundreds digit, tens digit and ones digit are displayed by turns.)	0.1 A																		
	LEV-B opening pulse	0 to 480 (When it is 100 pulse or more, hundreds digit, tens digit and ones digit are displayed by turns.)	Pulse																		
	U9 error detail history (latest)	<table border="1"> <thead> <tr> <th>Description</th> <th>Display</th> </tr> </thead> <tbody> <tr> <td>Normal</td> <td>00</td> </tr> <tr> <td>Overtoltage error</td> <td>01</td> </tr> <tr> <td>Undervoltage error</td> <td>02</td> </tr> <tr> <td>Input current sensor error</td> <td>04</td> </tr> <tr> <td>L₁-phase open error</td> <td>08</td> </tr> <tr> <td>Abnormal power synchronous signal</td> <td>08</td> </tr> <tr> <td>PFC/IGBT error (ZM-VKA)</td> <td>20</td> </tr> <tr> <td>Undervoltage</td> <td>20</td> </tr> </tbody> </table> <p>Display examples for multiple errors: Overtoltage (01) + Undervoltage (02) = 03 Undervoltage (02) + Power-sync signal error (08) = 0A L₁ phase open error (04) + PFC/IGBT error (20) = 24</p>	Description	Display	Normal	00	Overtoltage error	01	Undervoltage error	02	Input current sensor error	04	L ₁ -phase open error	08	Abnormal power synchronous signal	08	PFC/IGBT error (ZM-VKA)	20	Undervoltage	20	Code display
Description	Display																				
Normal	00																				
Overtoltage error	01																				
Undervoltage error	02																				
Input current sensor error	04																				
L ₁ -phase open error	08																				
Abnormal power synchronous signal	08																				
PFC/IGBT error (ZM-VKA)	20																				
Undervoltage	20																				

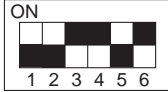
The black square (■) indicates a switch position.

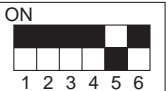
SW2 setting	Display detail	Explanation for display	Unit
	DC bus voltage 150 to 400 (ZM100-140V) 300 to 750 (ZM100-140Y)	150 to 400 (ZM100-140V) 300 to 750 (ZM100-140Y) (When it is 100 V or more, hundreds digit, tens digit and ones digit are displayed by turns.)	V
	Capacity save 0 to 100 When air conditioner is connected to M-NET and capacity save mode is demanded, a value from "0" to "100" is displayed. [When there is no setting of capacity save, "100" is displayed.]	0 to 100 (When the capacity is 100% hundreds digit, tens digit and ones digit are displayed by turns.) (Example) When 100%; 0.5 s 0.5 s 2 s □1 → 00 → □□ ↑—————┘	%
	Error postponement code history (2) of outdoor unit	Postponement code display Blinking: During postponement Lighting: Cancellation of postponement "00" is displayed in the case of no postponement.	Code display
	Error postponement code history (3) of outdoor unit	Postponement code display Blinking: During postponement Lighting: Cancellation of postponement "00" is displayed in the case of no postponement.	Code display
	Error history (3) (Oldest) Alternate display of abnormal unit number and code.	When no error history, "0" and "--" are displayed by turns.	Code display
	Error thermistor display [When there is no error thermistor, "--" is displayed.]	3: Outdoor pipe temperature/Liquid (TH3) 6: Outdoor pipe temperature/2-phase (TH6) 7: Outdoor ambient temperature (TH7) 8: Outdoor heat sink (TH8)	Code display
	Operation frequency on error occurring 0 to 255	0 to 255 (When it is 100 Hz or more, hundreds digit, tens digit and ones digit are displayed by turns.) (Example) When 125Hz; 0.5 s 0.5 s 2 s □1 → 25 → □□ ↑—————┘	Hz
	Fan step on error occurring 0 to 10	0 to 10	Step

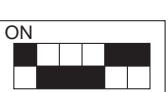
The black square (■) indicates a switch position.

SW2 setting	Display detail	Explanation for display	Unit
	LEV-C opening pulse 0 to 480 (ZM140)	0 to 480 (When it is 100 pulse or more, hundreds digit, tens digit and ones digit are displayed by turns.) (Example) When 130 pulse; 0.5 s 0.5 s 2 s □1 → 30 → □□	Pulse
	Indoor room temperature (TH1) on error occurring 8 to 39	8 to 39	°C
	Indoor pipe temperature/Liquid (TH2) on error occurring -39 to 88	-39 to 88 (When the temperature is 0°C or less, “-” and temperature are displayed by turns.) (Example) When -15°C; 0.5 s 0.5 s 2 s -□ → 15 → □□	°C
	Indoor pipe temperature/Cond./Eva. (TH5) on error occurring -39 to 88	-39 to 88 (When the temperature is 0°C or less, “-” and temperature are displayed by turns.) (Example) When -15°C; 0.5 s 0.5 s 2 s -□ → 15 → □□	°C
	Outdoor temperature/2-phase pipe (TH6) on error occurring -60 to 91	-60 to 91 (When the temperature is 0°C or less, “-” and temperature are displayed by turns.) (Example) When -15°C; 0.5 s 0.5 s 2 s -□ → 15 → □□	°C
	Outdoor temperature/Ambient (TH7) on error occurring -60 to 91	-60 to 91 (When the temperature is 0°C or less, “-” and temperature are displayed by turns.) (Example) When -15°C; 0.5 s 0.5 s 2 s -□ → 15 → □□	°C
	Outdoor temperature/Heat sink (TH8) on error occurring -40 to 200	-40 to 200 (When the temperature is 0°C or less, “-” and temperature are displayed by turns.) (When the temperature is 100°C or more, hundreds digit, tens digit and ones digit are displayed by turns.)	°C
	Discharge superheat on error occurring SHd 0 to 255 [Cooling = TH4-TH6] [Heating = TH4-TH5]	0 to 255 (When the temperature is 100°C or more, hundreds digit, tens digit and ones digit are displayed by turns.) (Example) When 150°C; 0.5 s 0.5 s 2 s □1 → 50 → □□	°C

The black square (■) indicates a switch position.

SW2 setting	Display detail	Explanation for display	Unit																
	Sub cool on error occurring SC 0 to 130 [Cooling = TH6-TH3] [Heating = TH5-TH2]	0 to 130 (When the temperature is 100°C or more, hundreds digit, tens digit and ones digit are displayed by turns.) (Example) When 115°C; 0.5 s 0.5 s 2 s □1 → 15 → □□	°C																
	Thermo-ON time until error stops 0 to 999	0 to 999 (When it is 100 minutes or more, hundreds digit, tens digit and ones digit are displayed by turns.) (Example) When 415 minutes; 0.5 s 0.5 s 2 s □4 → 15 → □□	Minute																
	Indoor pipe temperature/Liquid (TH2 (3)) Indoor 3 -39 to 88	-39 to 88 (When the temperature is 0°C or less, “-” and temperature are displayed by turns.)	°C																
	Indoor pipe temperature/Cond./Eva. (TH5 (3)) Indoor 3 -39 to 88	-39 to 88 (When the temperature is 0°C or less, “-” and temperature are displayed by turns.) When there is no indoor unit, “00” is displayed.	°C																
	Outdoor temperature/Comp. Surface (TH33) -52 to 221	-52 to 221 (When the comp. surface thermistor detects 100°C or more, hundreds digit, tens digit and ones digit are displayed by turns.) (Example) When 105°C; 0.5 s 0.5 s 2 s □1 → 05 → □□	°C																
	Controlling status of compressor operating frequency	The following code will be a help to know the operating status of unit. •The tens digit <table border="1"> <thead> <tr> <th>Display</th> <th>Compressor operating frequency control</th> </tr> </thead> <tbody> <tr> <td>1</td> <td>Primary current control</td> </tr> <tr> <td>2</td> <td>Secondary current control</td> </tr> </tbody> </table> •The ones digit (In this digit, the total number of activated control is displayed.) <table border="1"> <thead> <tr> <th>Display</th> <th>Compressor operating frequency control</th> </tr> </thead> <tbody> <tr> <td>1</td> <td>Preventive control for excessive temperature rise of discharge temperature</td> </tr> <tr> <td>2</td> <td>Preventive control for excessive temperature rise of condensing temperature</td> </tr> <tr> <td>4</td> <td>Frosting preventing control</td> </tr> <tr> <td>8</td> <td>Preventive control for excessive temperature rise of heat sink</td> </tr> </tbody> </table> (Example) The following controls are activated. • Primary current control • Preventive control for excessive temperature rise of condensing temperature • Preventive control for excessive temperature rise of heat sink <div style="text-align: right;"> LED </div>	Display	Compressor operating frequency control	1	Primary current control	2	Secondary current control	Display	Compressor operating frequency control	1	Preventive control for excessive temperature rise of discharge temperature	2	Preventive control for excessive temperature rise of condensing temperature	4	Frosting preventing control	8	Preventive control for excessive temperature rise of heat sink	Code display
Display	Compressor operating frequency control																		
1	Primary current control																		
2	Secondary current control																		
Display	Compressor operating frequency control																		
1	Preventive control for excessive temperature rise of discharge temperature																		
2	Preventive control for excessive temperature rise of condensing temperature																		
4	Frosting preventing control																		
8	Preventive control for excessive temperature rise of heat sink																		

11-1. UNIT FUNCTION SETTING BY THE REMOTE CONTROLLER

Each function can be set as necessary using the remote controller. The setting of function for each unit can only be done by the remote controller. Select function available from the table 1.

<Table 1> Function selections

(1) Functions available when setting the unit number to 00 (Select 00 referring to ④ setting the indoor unit number.)

Function	Settings	Mode No.	Setting No.	● : Initial setting (when sent from the factory)	Remarks
Power failure automatic recovery	OFF	01	1		The setting is applied to all the units in the same refrigerant system.
	ON		2	●	
Indoor temperature detection	Average data from each indoor unit	02	1	●	
	Data from the indoor unit with remote controller		2		
	Data from main remote controller*1		3		
LOSSNAY connectivity	Not supported	03	1	●	
	Supported (Indoor unit does not intake outdoor air through LOSSNAY)		2		
	Supported (Indoor unit intakes outdoor air through LOSSNAY)		3		
Power supply voltage	240V	04	1		
	220V, 230V		2	●	
Auto operation mode	Single set point	06	1		
	Dual set point		2	●	
Frost prevention temperature	2°C (Normal)	15	1		
	3°C		2		
Humidifier control	When the compressor operates, the humidifier also operates.	16	1	●	
	When the fan operates, the humidifier also operates.		2		
Change of defrosting control	Standard	17	1	●	
	For high humidity		2		

*1 The function is available only when the wired remote controller is used. The function is not available for floor standing models.

Meaning of "Function setting"

mode02:indoor temperature detecting

No	Indoor temperature(ta)=	Diagram	Initial setting	ta=(A+B)/2	ta=(A+B)/2	ta=A	ta=A
No.1	Average data of the sensor on all the indoor units		Initial setting	ta=(A+B)/2	ta=(A+B)/2	ta=A	ta=A
No.2	The data of the sensor on the indoor unit that connected with remote controller		Initial setting	ta=A	ta=B	ta=A	ta=A
No.3	The data of the sensor on main remote controller		Initial setting	ta=C	ta=C	ta=C	ta=C

- (2) Functions available when setting the unit number to 01–03 or AL (07 in the case of wireless remote controller)
- When setting functions for an indoor unit in an independent system, set the unit number to 01 referring to ④ setting the indoor unit number of Operating Procedure.
 - When setting functions for a simultaneous- Twin Triple indoor unit system, set the unit number to 01 to 03 for each indoor unit in the case of selecting different functions for each unit referring to ④ setting the indoor unit number of Operating Procedure.
 - When setting the same functions for an entire simultaneous Twin Triple-indoor unit system, set refrigerant address to AL (07 in the case of wireless remote controller) referring to ④ setting the indoor unit number of Operating Procedure.

Function	Settings	Mode No.	Setting No.	Initial setting (factory setting) --: Not available				
				4-way cassette PLA-RP•EA	Ceiling suspended PCA-HAQ	PCA-M•KA	Wall mounted PKA-M•HA(L)	PKA-M•KA(L)
Filter sign	100 h	07	1		•		•	•
	2500 h		2	•		•		
	No filter sign indicator		3					
Airflow (Fan speed)	Quiet	08	1		--		--	
	Standard		2	•	--	•	•	
	High ceiling		3		--		--	
No. of air outlets	4 directions	09	1	•	--	--	--	--
	3 directions		2		--	--	--	
	2 directions		3		--	--	--	
Optional high efficiency filter	Not supported	10	1	•	--	•	--	--
	Supported		2		--	--	--	
Vane setting	No vanes (Vane No. 3 setting: PLA only)	11	1		--	--	--	--
	Vane No.1 setting		2		--	•	--	--
	Vane No.2 setting		3	•	--	--	--	--
3D i-See sensor positioning	Position ① ("□" stamp position)	12	1		--	--	--	--
	(Position ②)		2		--	--	--	--
	Position ③ ("□" stamp position)		3	•	--	--	--	--
Optional humidifier (PLA only)	Not supported	13	1	•	--	--	--	--
	Supported		2	--	--	--	--	
Vane differential setting in heating mode (cold wind prevention)	No.1 setting (TH5: 24–28°C)	14	1		--	--	--	--
	No.2 setting (Standard, TH5: 28–32°C)		2	•	--	•	•	•
	No.3 setting (TH5: 32–38°C)		3		--	--	--	--
Swing	Not available	23	1	•	--	•	•	•
	Available } PLA-EA Swing Wave airflow							
Set temperature in heating mode (4 degree-up)*	Available	24	1	•	•	•	•	•
	Not available		2					
Fan speed during the heating thermo-OFF	Extra low	25	1	•	•	•	•	•
	Stop		2					
	Setting fan speed		3					
3D i-See sensor ceiling height setting	Low ceiling	26	1		--	--	--	--
	Standard		2		--	--	--	
	High ceiling		3	•	--	--	--	
Fan speed during the cooling thermo-OFF	Setting fan speed	27	1		•			
	Stop		2					
	Extra low		3	•	--	•	•	•
Detection of abnormality of the pipe temperature (P8)	Available	28	1	•	•	•	•	•
	Not available		2					

*PKA-HA/KA: 2 degree-up

PEAD-M-JA(L)

Function	Settings	Mode No.	Setting No.	● : Initial setting (Factory setting)
Filter sign	100h	07	1	
	2500h		2	
	No filter sign indicator		3	●
External static pressure	35/50/70/100/150Pa	08	Refer to the right table	
External static pressure	35/50/70/100/150Pa	10	Refer to the right table	
Set temperature in heating mode (4 degree-up)	Available	24	1	●
	Not available		2	
Fan speed during the heating thermo OFF	Extra low	25	1	●
	Stop		2	
	Set fan speed		3	
Fan speed during the cooling thermo OFF	Set fan speed	27	1	●
	Stop		2	
Detection of abnormality of the pipe	Available	28	1	●
	Not available		2	

External static pressure	Setting No.		Initial setting (Factory setting)
	Mode No. 08	Mode No. 10	
35Pa	2	1	
50Pa	3	1	●
70Pa	1	2	
100Pa	2	2	
150Pa	3	2	

Mode No.11

Setting No.	Settings	PLA-RP•EA	PCA-M•KA
1	Vane No.3 setting No Vanes	Less smudging (Downward position than the standard)	No vane function
2	Vane No.1 setting	Standard	Standard
3	Vane No.2 setting	Less draft * (Upward position than the standard)	Less draft * (Upward position than the standard)

* In this setting, the ceiling may be smudged.

11-1-1. Selecting functions using the wired remote controller <PAR-4xMAA ("x" represents 0 or later)>

<Service menu>

Maintenance password is required

① Select "Service" from the Main menu, and press the [✓] button.

*At the main display, the menu button and select "Service" to make the maintenance setting.

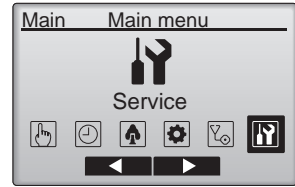

② When the Service menu is selected, a window will appear asking for the password.

To enter the current maintenance password (4 numerical digits), move the cursor to the digit you want to change with the [F1] or [F2] button.



Set each number (0 through 9) with the [F3] or [F4] button.



Then, press the [✓] button.

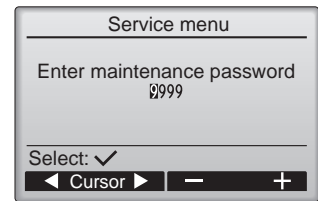

Note: The initial maintenance password is "9999". Change the default password as necessary to prevent unauthorized access. Have the password available for those who need it.

: If you forget your maintenance password, you can initialize the password to the default password "9999" by pressing and holding the [F1] button for 10 seconds on the maintenance password setting screen.

③ If the password matches, the Service menu will appear.

The type of menu that appears depends on the connected indoor units' type.

Note: Air conditioning units may need to be stopped to make only at "settings". There may be some settings that cannot be made when the system is centrally controlled.



A screen will appear that indicates the setting has been saved.

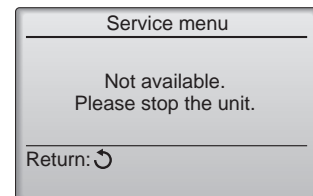
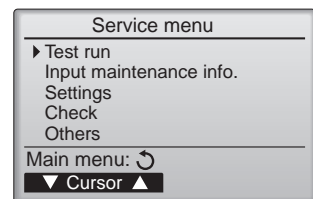

Navigating through the screens

- To go back to the Service menu[[Menu]] button
- To return to the previous screen.....[[Return]] button

<Function setting>

- ① Select "Service" from the Main menu, and press the [✓] button.

Select "Setting" from the Service menu, and press the [✓] button.

Select "Function setting", and press the [✓] button.

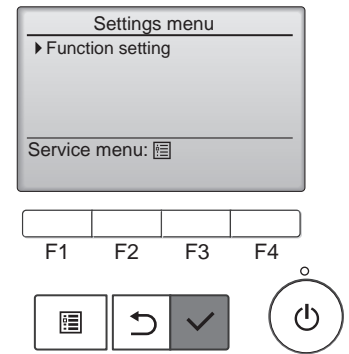

- ② Set the indoor unit refrigerant addresses and unit numbers with the [F1] through [F4] buttons, and then press the [✓] button to confirm the current setting.

<Checking the indoor unit No.>

When the [✓] button is pressed, the target indoor unit will start fan operation. If the unit is common or when running all units, all indoor units for the selected refrigerant address will start fan operation.

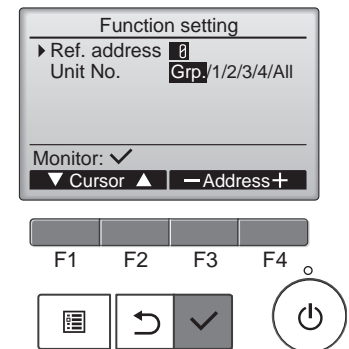

- ③ When data collection from the indoor units is completed, the current settings appears highlighted. Non-highlighted items indicate that no function settings are made. Screen appearance varies depending on the "Unit No." setting.

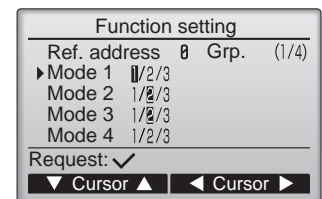

- ④ Use the [F1] or [F2] button to move the cursor to select the mode number, and change the setting number with the [F3] or [F4] button.

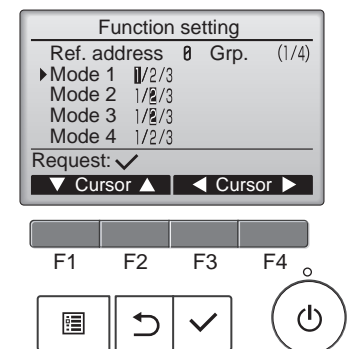

- ⑤ When the settings are completed, press the [✓] button to send the setting data from the remote controller to the indoor units. When the transmission is successfully completed, the screen will return to the Function setting screen.

Note: • Make the above settings only on Mr. Slim units as necessary.

- The above function settings are not available for the CITY MULTI units.
- Table 1 summarizes the setting options for each mode number. Refer to the indoor unit Installation Manual for the detailed information about initial settings, mode numbers, and setting numbers for the indoor units.
- Be sure to write down the settings for all functions if any of the initial settings has been changed after the completion of installation work.

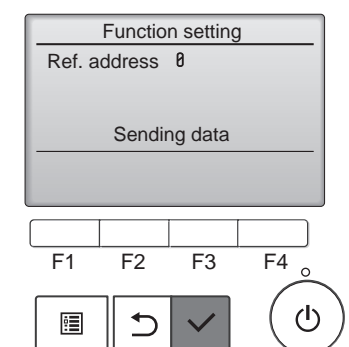

11-1-2. Selecting functions using the wireless remote controller (Type C)

Functions can be selected with the wireless remote controller. Function selection using wireless remote controller is available only for refrigerant system with wireless function. Refrigerant address cannot be specified by the wireless remote controller.

[Flow of function selection procedure]

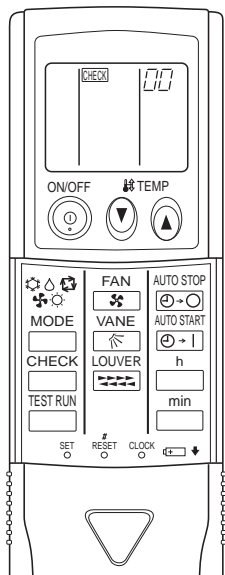

The flow of the function selection procedure is shown below. This example shows how to turn off the function that raises the set temperature by 4 degrees during HEAT operation. (Mode 24: 2)
The procedure is given after the flow chart.

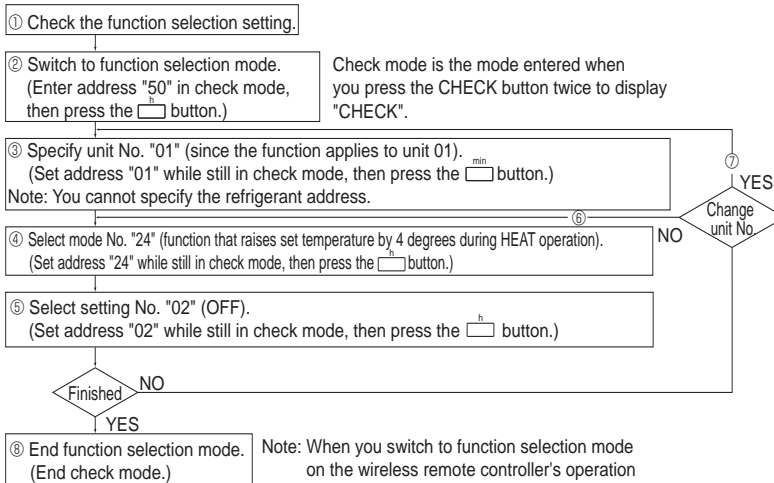

Note: When you switch to function selection mode on the wireless remote controller's operation area, the unit ends function selection mode automatically if nothing is input for 10 minutes or longer.

[Operating instructions]

- ① Check the function settings.
- ② Press the CHECK button twice continuously. → CHECK is lit and "00" blinks.
Press the TEMP button once to set "50". Direct the wireless remote controller toward the receiver of the indoor unit and press the button.
- ③ Set the unit number.
Press the TEMP button to set the unit number. (Press "01" to specify the indoor unit whose unit number is 01.)
Direct the wireless remote controller toward the receiver of the indoor unit and press the button.
(By setting unit number with the button, specified indoor unit starts performing fan operation.
Detect which unit is assigned to which number using this function. If unit number is set to AL, all the indoor units in same refrigerant system start performing fan operation simultaneously.)

Notes:

1. If a unit number that cannot be recognized by the unit is entered, 3 beeps of 0.4 seconds will be heard. Reenter the unit number setting.
2. If the signal was not received by the sensor, you will not hear a beep or a "double beep" may be heard. Reenter the unit number setting.

- ④ Select a mode.
Press the TEMP button to set a mode. Press "24" to turn on the function that raises the set temperature by 4 degrees during heat operation. Direct the wireless remote controller toward the sensor of the indoor unit and press the button.
→ The sensor-operation indicator will blink and beeps will be heard to indicate the current setting number.
Current setting number: 1 = 1 beep (1 second)
2 = 2 beeps (1 second each)
3 = 3 beeps (1 second each)

Notes:

1. If a mode number that cannot be recognized by the unit is entered, 3 beeps of 0.4 seconds will be heard. Reenter the mode number.
2. If the signal was not received by the sensor, you will not hear a beep or a "double beep" may be heard. Reenter the mode number.

- ⑤ Select the setting number.
Press the TEMP button to select the setting number. (02: Not available)
Direct the wireless remote controller toward the receiver of the indoor unit and press the button.
→ The sensor-operation indicator will blink and beeps will be heard to indicate the setting number.
Setting number: 1 = 2 beeps (0.4 seconds each)
2 = 2 beeps (0.4 seconds each, repeated twice)
3 = 2 beeps (0.4 seconds each, repeated 3 times)

Notes:

1. If a setting number that cannot be recognized by the unit is entered, the setting will turn back to the original setting.
2. If the signal was not received by the sensor, you will not hear a beep or a "double beep" may be heard. Reenter the setting number.

- ⑥ Repeat steps ④ and ⑤ to make an additional setting without changing unit number.
- ⑦ Repeat steps ③ to ⑤ to change unit number and make function settings on it.
- ⑧ Complete the function settings
Press button.

Do not use the wireless remote controller for 30 seconds after completing the function setting.

11-1-3. Selecting functions using the wireless remote controller <PAR-SL100A-E>

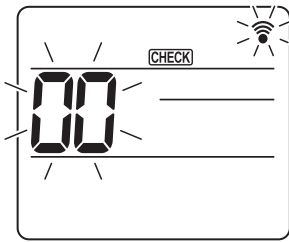

Fig. 11-1

- 1 Going to the function select mode
 Press the **[MENU]** button between of 5 seconds.
 (Start this operation from the status of remote controller display turned off.)
 [CHECK] is lit and "00" blinks. (Fig. 11-1)
 Press the **[↓]** button to set the "50".
 Direct the wireless remote controller toward the receiver of the indoor unit
 and press the **[SET]** button.

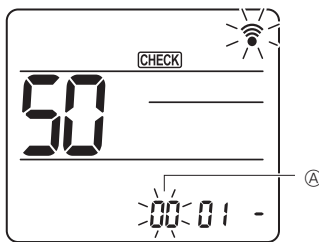

Fig. 11-2

- 2 Setting the unit number
 Press the **[↓]** button to set unit number A. (Fig. 11-2)
 Direct the wireless remote controller toward the receiver of the indoor unit
 and press the **[SET]** button.

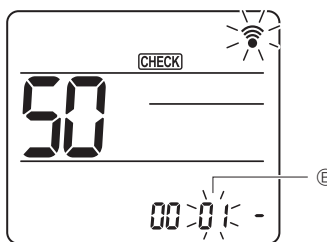

Fig. 11-3

- 3 Select a mode
 Press the **[↓]** button to set Mode number B. (Fig. 11-3)
 Direct the wireless remote controller toward the receiver of the indoor unit
 and press the **[SET]** button.
 Current setting number:

1=1 beep (1 second)
2=2 beep (1 second each)
3=3 beep (1 second each)

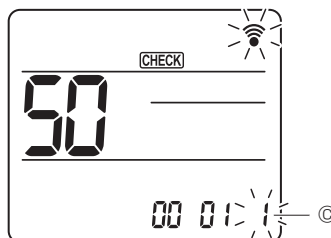

Fig. 11-4

- 4 Selecting the setting number
 Use the **[↓]** button to change the Setting number C. (Fig. 11-4)
 Direct the wireless remote controller toward the receiver of the indoor unit
 and press the **[SET]** button.
- 5 To select multiple functions continuously
 Repeat select 3 and 4 to change multiple function settings continuously.
- 6 Complete function selection
 Direct the wireless remote controller toward the sensor of the indoor unit
 and press the **[OFF/ON]** button.

Note:

Make the above settings on Mr. Slim units as necessary.

- Be sure to write down the settings for all functions if any of the initial settings has been changed after the completion of installation work.

11-2. FUNCTION SELECTION OF REMOTE CONTROLLER

11-2-1. <PAR-4xMAA ("x" represents 0 or later)>

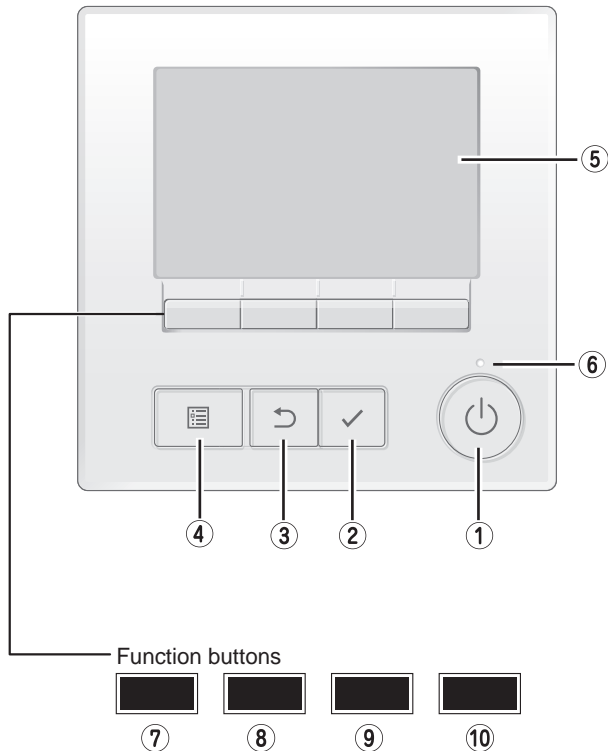

The functions of the function buttons change depending on the screen.

Refer to the button function guide that appears at the bottom of the LCD for the functions they serve on a given screen.

When the system is centrally controlled, the button function guide that corresponds to the locked button will not appear.

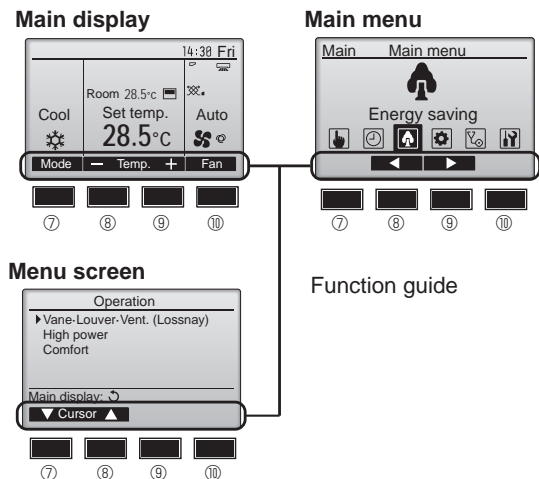

① ON/OFF button

Press to turn ON/OFF the indoor unit.

② SELECT button

Press to save the setting.

③ RETURN button

Press to return to the previous screen.

④ MENU button

Press to bring up the Main menu.

⑤ Backlit LCD

Operation settings will appear.
When the backlight is off, pressing any button turns the backlight on and it will stay lit for a certain period of time depending on the screen.

When the backlight is off, pressing any button turns the backlight on and does not perform its function. (except for the (ON/OFF) button)

⑥ ON/OFF lamp

This lamp lights up in green while the unit is in operation. It blinks while the remote controller is starting up or when there is an error.

⑦ Function button **F1**

Main display : Press to change the operation mode.
Main menu : Press to move the cursor down.

⑧ Function button **F2**

Main display : Press to decrease temperature.
Main menu : Press to move the cursor up.

⑨ Function button **F3**

Main display : Press to increase temperature.
Main menu : Press to go to the previous page.

⑩ Function button **F4**

Main display : Press to change the fan speed.
Main menu : Press to go to the next page.

Menu structure

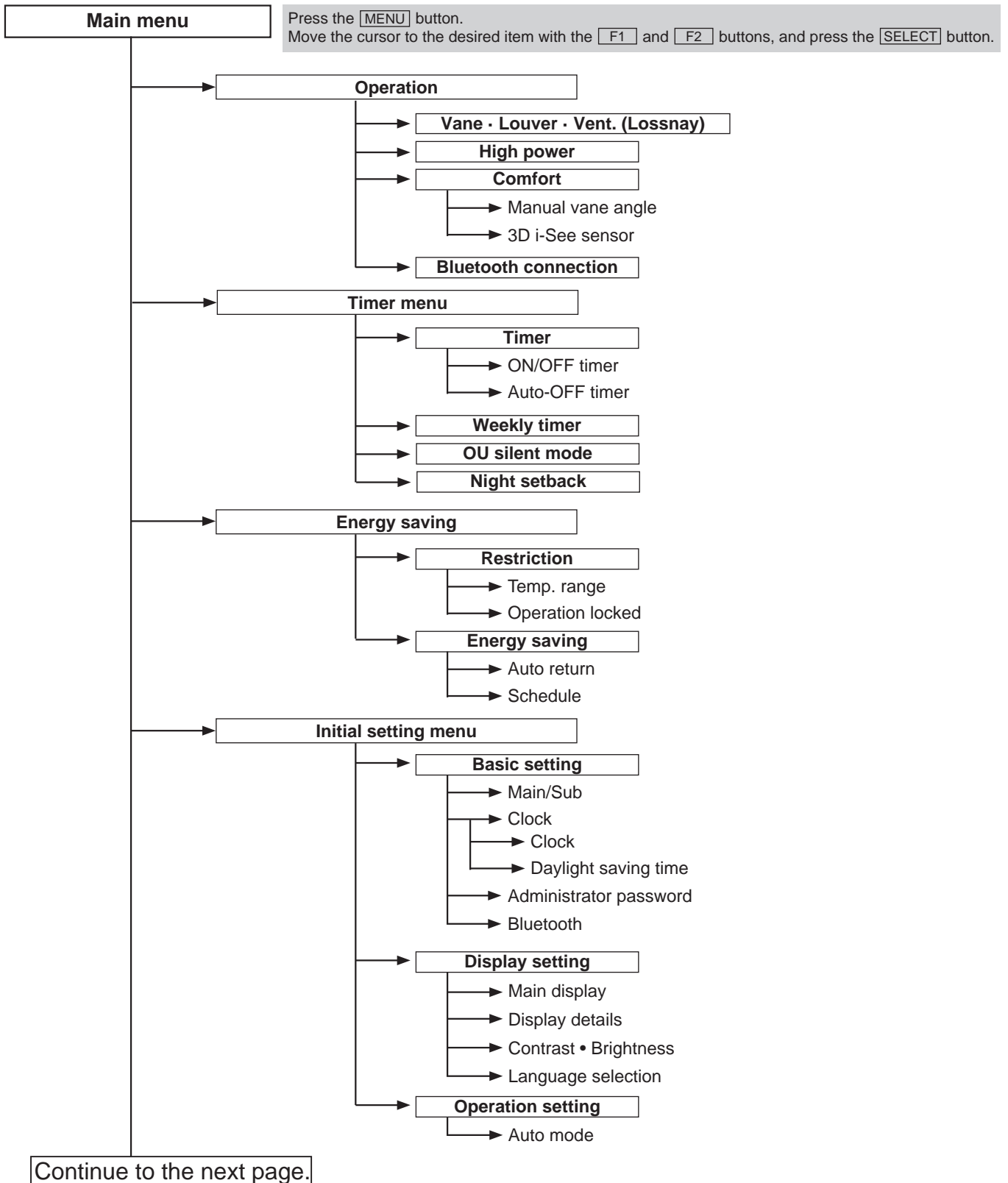

Not all functions are available on all models of indoor units.

Continue from the previous page.

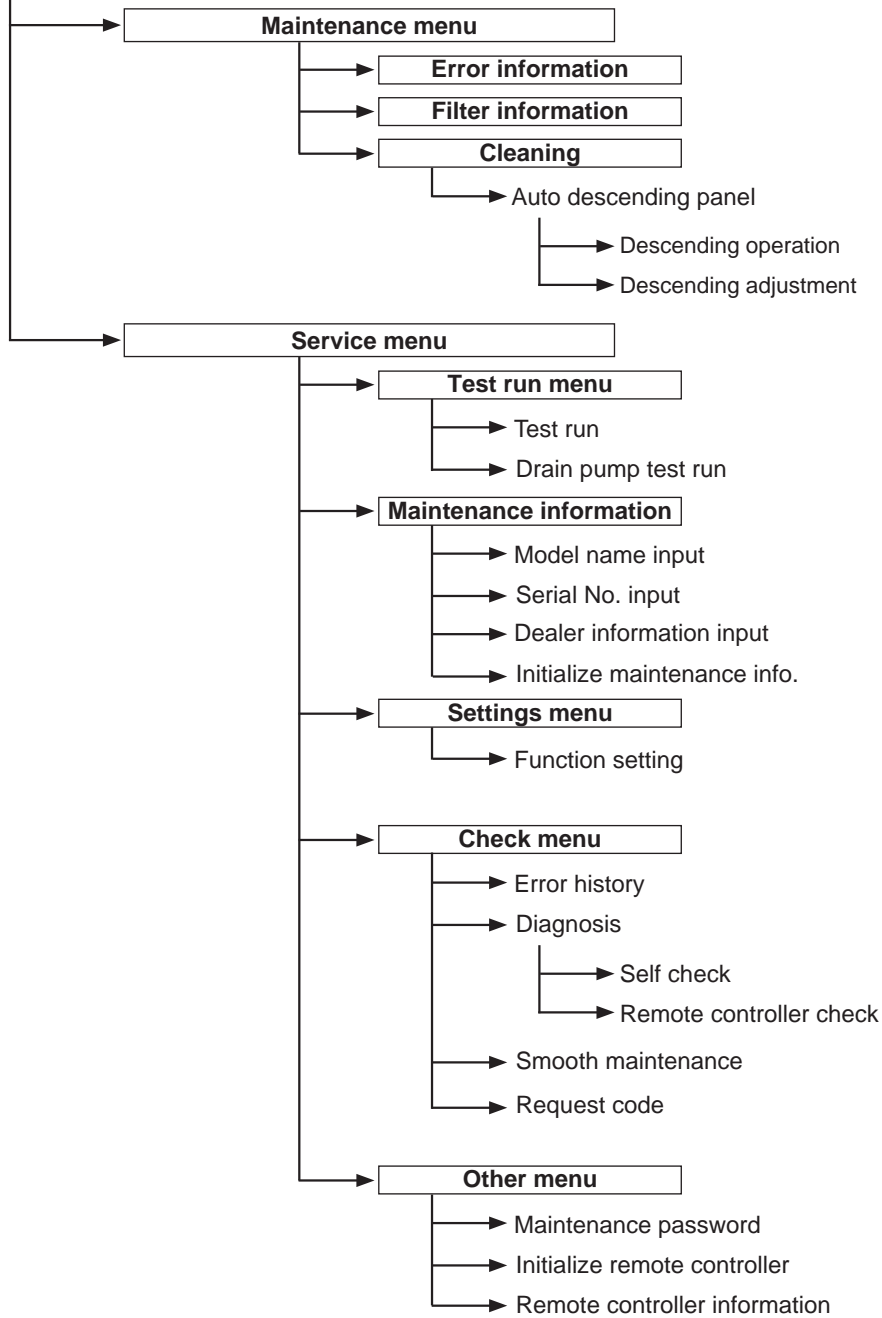

Not all functions are available on all models of indoor units.

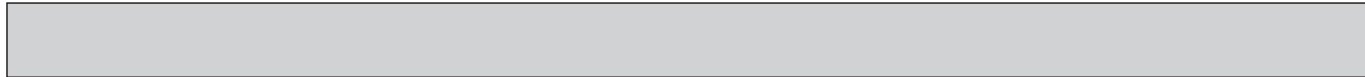

Main menu list

Main menu	Setting and display items		Setting details
Operation	Vane · Louver · Vent. (Lossnay)		<p>Use to set the vane angle.</p> <ul style="list-style-type: none"> • Select a desired vane setting from 5 different settings. <p>Use to turn ON/OFF the louver.</p> <ul style="list-style-type: none"> • Select a desired setting from "ON" and "OFF." <p>Use to set the amount of ventilation.</p> <ul style="list-style-type: none"> • Select a desired setting from "Off," "Low," and "High."
	High power *3		<p>Use to reach the comfortable room temperature quickly.</p> <ul style="list-style-type: none"> • Units can be operated in the High-power mode for up to 30 minutes.
	Comfort	Manual vane angle	Use to fix each vane angle.
		3D i-See sensor	<p>Use to set the following functions for 3D i-See sensor.</p> <ul style="list-style-type: none"> • Air distribution • Energy saving option • Seasonal airflow
	Bluetooth connection		Use to check the information about bluetooth connection between smartphone and the remote controller.
Timer	Timer	ON/OFF timer *1	<p>Use to set the operation ON/OFF times.</p> <ul style="list-style-type: none"> • Time can be set in 5-minute increments.
		Auto-Off timer	<p>Use to set the Auto-Off time.</p> <ul style="list-style-type: none"> • Time can be set to a value from 30 to 240 in 10-minute increments.
	Weekly timer *1, *2		<p>Use to set the weekly operation ON/OFF times.</p> <ul style="list-style-type: none"> • Up to 8 operation patterns can be set for each day. (Not valid when the ON/OFF timer is enabled.)
	OU silent mode *1, *3		<p>Use to set the time periods in which priority is given to quiet operation of outdoor units over temperature control. Set the Start/Stop times for each day of the week.</p> <ul style="list-style-type: none"> • Select the desired silent level from "Normal," "Middle," and "Quiet."
	Night setback *1		<p>Use to make Night setback settings.</p> <ul style="list-style-type: none"> • Select "Yes" to enable the setting, and "No" to disable the setting. The temperature range and the start/stop times can be set.
Energy saving	Restriction	Temp. range *2	<p>Use to restrict the preset temperature range.</p> <ul style="list-style-type: none"> • Different temperature ranges can be set for different operation modes.
		Operation lock	<p>Use to lock selected functions.</p> <ul style="list-style-type: none"> • The locked functions cannot be operated.
	Energy saving	Auto return *2	<p>Use to get the units to operate at the preset temperature after performing energy saving operation for a specified time period.</p> <ul style="list-style-type: none"> • Time can be set to a value from 30 and 120 in 10-minute increments. (This function will not be valid when the preset temperature ranges are restricted.)
		Schedule *1	<p>Set the start/stop times to operate the units in the energy saving mode for each day of the week, and set the energy saving rate.</p> <ul style="list-style-type: none"> • Up to 4 energy saving operation patterns can be set for each day. • Time can be set in 5-minute increments. • Energy saving rate can be set to a value from 0% or 50 to 90% in 10% increments.

*1 Clock setting is required.

*2 1°C increments.

*3 This function can only be set when certain outdoor units are connected.

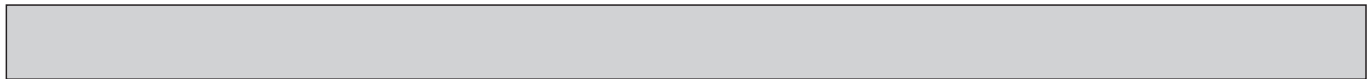

Main menu	Setting and display items		Setting details
Initial setting	Basic setting	Main/Sub	When connecting 2 remote controllers, one of them needs to be designated as a sub controller.
		Clock	Use to set the current time.
		Daylight saving time	Set the daylight saving time.
		Administrator password	The administrator password is required to make the settings for the following items. • Timer setting • Energy saving setting • Weekly timer setting • Restriction setting • Outdoor unit silent mode setting • Night set back
		Bluetooth	Make the settings for bluetooth function of a remote controller and PIN code.
	Display setting	Main display	Use to switch between "Full" and "Basic" modes for the Main display, and use to change the background colors of the display to black.
		Display details	Make the settings for the remote controller related items as necessary. Clock: The initial settings are "Yes" and "24h" format. Temperature: Set either Celsius (°C) or Fahrenheit (°F). Room temp. : Set Show or Hide. Auto mode: Set the Auto mode display or Only Auto display.
		Contrast • Brightness	Use to adjust screen contrast and brightness.
		Language selection	Use to select the desired language.
	Operation setting	Auto mode	Whether or not to use the Auto mode can be selected by using the button. This setting is valid only when indoor units with the Auto mode function are connected.
Maintenance	Error information		Use to check error information when an error occurs. • Check code, error source, refrigerant address, unit model, manufacturing number, contact information (dealer's phone number) can be displayed. (The unit model, manufacturing number, and contact information need to be registered in advance to be displayed.)
	Filter information		Use to check the filter status. • The filter sign can be reset.
	Cleaning	Auto descending panel	Use to lift and lower the auto descending panel (Optional parts).
Service	Test run		Select "Test run" from the Service menu to bring up the Test run menu. • Test run • Drain pump test run
	Input maintenance info.		Select "Input maintenance Info." from the Service menu to bring up the Maintenance information screen. The following settings can be made from the Maintenance Information screen. • Model name input • Serial No. input • Dealer information input • Initialize maintenance info.
	Settings	Function setting	Make the settings for the indoor unit functions via the remote controller as necessary.
	Check	Error history	Display the error history and execute "delete error history".
		Diagnosis	Self check: Error history of each unit can be checked via the remote controller. Remote controller check: When the remote controller does not work properly, use the remote controller checking function to troubleshoot the problem.
		Smooth maintenance * ³	Use to display the maintenance data of indoor/outdoor units.
		Request code * ³	Use to check operation data such as thermistor temperature and error information.
	Others	Maintenance password	Use to change the maintenance password.
		Initialize remote controller	Use to initialize the remote controller to the factory shipment status.
		Remote controller information	Use to display the remote controller model name, software version, and serial number.

*³ This function can only be set when certain outdoor units are connected.

12-1. HOW TO "MONITOR THE OPERATION DATA" <PAR-4xMAA ("x" represents 0 or later)>

Details on the operation data including each thermistor temperature and error history can be confirmed with the remote controller.

① Select "Service" from the Main menu, and press the [✓] button.

Select "Check" with the [F1] or [F2] button, and press the [✓] button.

Select "Request code" with the [F1] or [F2] button, and press the [✓] button.

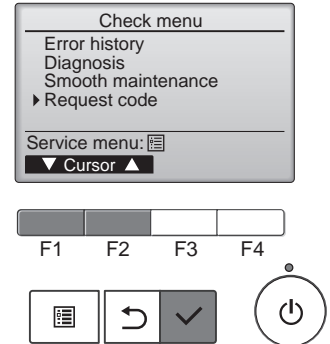

② Set the Refrigerant address and Request code.

Select the item to be changed with the [F1] or [F2] button.

Select the required setting with the [F3] or [F4] button.

- <Ref.address>setting [0] – [15]
- <Request code>setting

Press the [✓] button, Data will be collected and displayed.

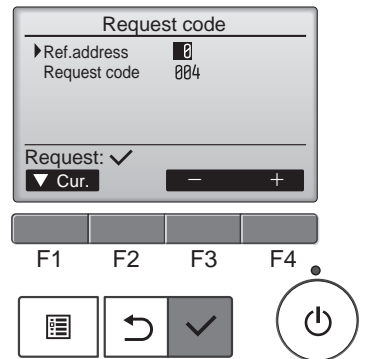

Request code: 004
Discharge temperature: 69°C

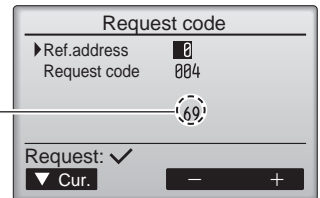

12-2. Request code list

Certain indoor/outdoor combinations do not have the request code function; therefore, no request codes are displayed.

Request code	Request content	Description (Display range)	Unit	Remarks
0	Operation state	Refer to 12-2-1. Detail Contents in Request Code.	—	
1	Compressor-Operating current (rms)	0–50	A	
2	Compressor-Accumulated operating time	0–9999	10 hours	
3	Compressor-Number of operation times	0–9999	100 times	
4	Discharge temperature (TH4)	3–217	°C	
5	Outdoor unit -Liquid pipe 1 temperature (TH3)	–40–90	°C	
6				
7	Outdoor unit-2-phase pipe temperature (TH6)	–39–88	°C	
8				
9	Outdoor unit-Outside air temperature (TH7)	–39–88	°C	
10	Outdoor unit-Heatsink temperature (TH8)	–40–200	°C	
11				
12	Discharge superheat (SHd)	0–255	°C	
13	Sub-cool (SC)	0–130	°C	
14				
15				
16	Compressor-Operating frequency	0–255	Hz	
17	Compressor-Target operating frequency	0–255	Hz	
18	Outdoor unit-Fan output step	0–10	Step	
19	Outdoor unit-Fan 1 speed (Only for air conditioners with DC fan motor)	0–9999	rpm	
20	Outdoor unit-Fan 2 speed (Only for air conditioners with DC fan motor)	0–9999	rpm	"0" is displayed if the air conditioner is a single-fan type.
21				
22	LEV (A) opening	0–500	Pulses	
23	LEV (B) opening	0–500	Pulses	
24	LEV (C) opening	5–500	Pulses	
25	Primary current	0–50	A	
26	DC bus voltage	180–370	V	
27				
28				
29	Number of connected indoor units	0–4	Units	
30	Indoor unit-Setting temperature	17–30	°C	
31	Indoor unit-Intake air temperature <Measured by thermostat>	8–39	°C	
32	Indoor unit-Intake air temperature (Unit No. 1) <Heat mode-4-deg correction>	8–39	°C	"0" is displayed if the target unit is not present.
33	Indoor unit-Intake air temperature (Unit No. 2) <Heat mode-4-deg correction>	8–39	°C	↑
34	Indoor unit-Intake air temperature (Unit No. 3) <Heat mode-4-deg correction>	8–39	°C	↑
35	Indoor unit-Intake air temperature (Unit No. 4) <Heat mode-4-deg correction>	8–39	°C	↑
36				
37	Indoor unit -Liquid pipe temperature (Unit No. 1)	–39–88	°C	"0" is displayed if the target unit is not present.
38	Indoor unit -Liquid pipe temperature (Unit No. 2)	–39–88	°C	↑
39	Indoor unit -Liquid pipe temperature (Unit No. 3)	–39–88	°C	↑
40	Indoor unit -Liquid pipe temperature (Unit No. 4)	–39–88	°C	↑
41				
42	Indoor unit-Cond./Eva. pipe temperature (Unit No. 1)	–39–88	°C	"0" is displayed if the target unit is not present.
43	Indoor unit-Cond./Eva. pipe temperature (Unit No. 2)	–39–88	°C	↑
44	Indoor unit-Cond./Eva. pipe temperature (Unit No. 3)	–39–88	°C	↑
45	Indoor unit-Cond./Eva. pipe temperature (Unit No. 4)	–39–88	°C	↑
46				
47				
48	Thermostat ON operating time	0–999	Minutes	
49	Test run elapsed time	0–120	Minutes	← Not possible to activate maintenance mode during the test run.

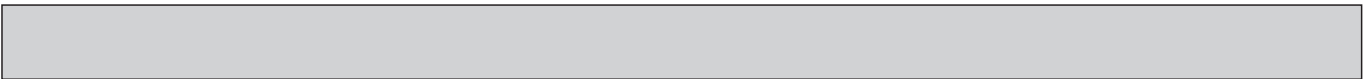

Request code	Request content	Description (Display range)	Unit	Remarks
50	Indoor unit-Control state	Refer to 12-2-1.Detail Contents in Request Code.	—	
51	Outdoor unit-Control state	Refer to 12-2-1.Detail Contents in Request Code.	—	
52	Compressor-Frequency control state	Refer to 12-2-1.Detail Contents in Request Code.	—	
53	Outdoor unit-Fan control state	Refer to 12-2-1.Detail Contents in Request Code.	—	
54	Actuator output state	Refer to 12-2-1.Detail Contents in Request Code.	—	
55	Error content (U9)	Refer to 12-2-1.Detail Contents in Request Code.	—	
56				
57				
58				
59				
60	Signal transmission demand capacity	0–255	%	
61	Contact demand capacity	Refer to 12-2-1.Detail Contents in Request Code.	—	
62	External input state (silent mode, etc.)	Refer to 12-2-1.Detail Contents in Request Code.	—	
63				
64				
65				
66				
67				
68				
69				
70	Outdoor unit-Capacity setting display	Refer to 12-2-1.Detail Contents in Request Code.	—	
71	Outdoor unit-Setting information	Refer to 12-2-1.Detail Contents in Request Code.	—	
72				
73			—	
74			—	
75				
76			—	
77			—	
78			—	
79			—	
80			—	
81			—	
82			—	
83				
84	M-NET adapter connection (presence/absence)	"0000": Not connected "0001": Connected	—	
85				
86				
87				
88				
89	Display of execution of replace/wash operation	"0000": Not washed "0001": Washed	—	
90	Outdoor unit-Microprocessor version information	Examples) Ver 5.01 → "0501"	Ver	
91	Outdoor unit-Microprocessor version information (sub No.)	Auxiliary information (displayed after version information) Examples) Ver 5.01 A000 → "A000"	—	
92				
93				
94				
95				
96				
97				
98				
99				
100	Outdoor unit - Error postponement history 1 (latest)	Displays postponement code. (" - " is displayed if no postponement code is present)	Code	
101	Outdoor unit - Error postponement history 2 (previous)	Displays postponement code. (" - " is displayed if no postponement code is present)	Code	
102	Outdoor unit - Error postponement history 3 (last but one)	Displays postponement code. (" - " is displayed if no postponement code is present)	Code	

Request code	Request content	Description (Display range)	Unit	Remarks
103	Error history 1 (latest)	Displays error history. ("-" is displayed if no history is present.)	Code	
104	Error history 2 (second to last)	Displays error history. ("-" is displayed if no history is present.)	Code	
105	Error history 3 (third to last)	Displays error history. ("-" is displayed if no history is present.)	Code	
106	Abnormal thermistor display (TH3/TH6/TH7/TH8)	3 : TH3 6 : TH6 7 : TH7 8 : TH8 0 : No thermistor error	Sensor number	
107	Operation mode at time of error	Displayed in the same way as request code "0".	-	
108	Compressor-Operating current at time of error	0-50	A	
109	Compressor-Accumulated operating time at time of error	0-9999	10 hours	
110	Compressor-Number of operation times at time of error	0-9999	100 times	
111	Discharge temperature (TH4) or comp. surface temperature (TH33) at time of error	3-217	°C	
112	Outdoor unit -Liquid pipe 1 temperature (TH3) at time of error	-40-90	°C	
113				
114	Outdoor unit-2-phase pipe temperature (TH6) at time of error	-39-88	°C	
115				
116	Outdoor unit-Outside air temperature (TH7) at time of error	-39-88	°C	
117	Outdoor unit-Heatsink temperature (TH8) at time of error	-40-200	°C	
118	Discharge superheat (SHd) at time of error	0-255	°C	
119	Sub-cool (SC) at time of error	0-130	°C	
120	Compressor-Operating frequency at time of error	0-255	Hz	
121	Outdoor unit at time of error • Fan output step	0-10	Step	
122	Outdoor unit at time of error • Fan 1 speed (Only for air conditioners with DC fan)	0-9999	rpm	
123	Outdoor unit at time of error • Fan 2 speed (Only for air conditioners with DC fan)	0-9999	rpm	"0" is displayed if the air conditioner is a single-fan type.
124				
125	LEV (A) opening at time of error	0-500	Pulses	
126	LEV (B) opening at time of error	0-500	Pulses	
127				
128				
129				
130	Thermostat ON time until operation stops due to error	0-999	Minutes	
131				
132	Indoor -Liquid pipe temperature at time of error	-39-88	°C	Average value of all indoor units is displayed if the air conditioner consists of 2 or more indoor units (twin, triple, quad).
133	Indoor -Cond/Eva. pipe temperature at time of error	-39-88	°C	Average value of all indoor units is displayed if the air conditioner consists of 2 or more indoor units (twin, triple, quad).
134	Indoor at time of error • Intake air temperature <Thermostat judge temperature>	-39-88	°C	
135				
136				
137				
138				
139				
140				
~				
146				
147				
148				
149				
150	Indoor -Actual intake air temperature	-39-88	°C	
151	Indoor -Liquid pipe temperature	-39-88	°C	
152	Indoor -Cond/Eva. pipe temperature	-39-88	°C	

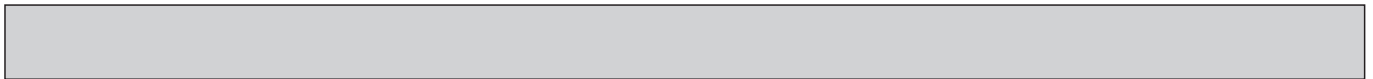

Request code	Request content	Description (Display range)	Unit	Remarks
153				
154	Indoor-Fan operating time (After filter is reset)	0-9999	1 hour	
155	Indoor-Total operating time (Fan motor ON time)	0-9999	10 hours	
156				
157	Indoor fan output value (Sj value)	0-255 Fan control data	-	For indoor fan phase control
158	Indoor fan output value (Pulsation ON/OFF)	"00 *** **** indicates fan control data.	-	For indoor fan pulsation control
159	Indoor fan output value (duty value)	"00 *** **** indicates fan control data.	-	For indoor DC brushless motor control
160				
161				
162				
163	Indoor unit-Capacity setting information	Refer to 12-2-1. Detail Contents in Request Code.	-	
164	Indoor unit-SW3 information	Undefined	-	
165	Wireless pair No. (indoor control board side) setting	Refer to 12-2-1. Detail Contents in Request Code.	-	
166	Indoor unit-SW5 information	Undefined	-	
167				
~				
189				
190	Indoor unit-Microprocessor version information	Examples) Ver 5.01 → "0501"	Ver	
191	Indoor unit-Microprocessor version information (sub No.)	Auxiliary information (displayed after version information) Examples) Ver 5.01 A000 → "A000"	-	
192				

12-2-1. Detail Contents in Request Code

[Operation state] (Request code : "0")

Data display

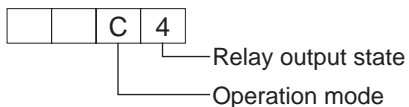

Operation mode

Display	Operation mode
0	STOP • FAN
C	COOL • DRY
H	HEAT
d	DEFROST

Relay output state

Display	Power currently supplied to compressor	Compressor	Four-way valve	Solenoid valve
0	—	—	—	—
1				ON
2			ON	
3			ON	ON
4		ON		
5		ON		ON
6		ON	ON	
7		ON	ON	ON
8	ON			
A	ON		ON	

[Indoor unit – Control state] (Request code : "50")

Data display

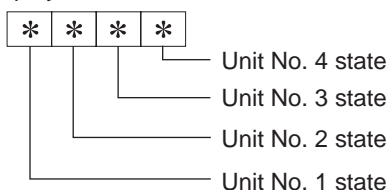

Display	State
0	Normal
1	Preparing for heat operation
2	—
3	—
4	Heater is ON.
5	Anti-freeze protection is ON.
6	Overheat protection is ON.
7	Requesting compressor to turn OFF
F	There are no corresponding units.

[Outdoor unit – Control state] (Request code : "51")

Data display	State
0 0 0 0	Normal
0 0 0 1	Preparing for heat operation
0 0 0 2	Defrost

[Compressor – Frequency control state] (Request code : "52")

Data display

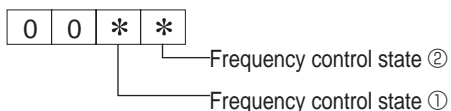

Frequency control state ①

Display	Current limit control
0	No current limit
1	Primary current limit control is ON.
2	Secondary current limit control is ON.

Frequency control state ②

Display	Discharge temperature overheat prevention	Condensation temperature overheat prevention	Anti-freeze protection control	Heat sink temperature overheat prevention
0				
1	Controlled			
2		Controlled		
3	Controlled	Controlled		
4			Controlled	
5	Controlled		Controlled	
6		Controlled	Controlled	
7	Controlled	Controlled	Controlled	
8				Controlled
9	Controlled			Controlled
A		Controlled		Controlled
b	Controlled	Controlled		Controlled
C			Controlled	Controlled
d	Controlled		Controlled	Controlled
E		Controlled	Controlled	Controlled
F	Controlled	Controlled	Controlled	Controlled

[Fan control state] (Request code : "53")

Data display

0	0	*	*
---	---	---	---

Fan step correction value by heat sink temperature overheat prevention control

Fan step correction value by cool condensation temperature overheat prevention control

Display	Correction value
- (minus)	-1
0	0
1	+1
2	+2

[Actuator output state] (Request code : "54")

Data display

0	0	*	*
---	---	---	---

Actuator output state ①

Actuator output state ②

Actuator output state ①

Display	SV1	Four-way valve	Compressor	Compressor is warming up
0				
1	ON			
2		ON		
3	ON	ON		
4			ON	
5	ON		ON	
6		ON	ON	
7	ON	ON	ON	
8				ON
9	ON			ON
A		ON		ON
b	ON	ON		ON
C			ON	ON
d	ON		ON	ON
E		ON	ON	ON
F	ON	ON	ON	ON

Actuator output state ②

Display	52C	SV2	SS
0			
1	ON		
2		ON	
3	ON	ON	
4			ON
5	ON		ON
6		ON	ON
7	ON	ON	ON

[Error content (U9)] (Request code : "55")

Data display

0	0	*	*
---	---	---	---

Error content ①

Error content ②

Error content ①

● : Detected

Display	Oversvoltage error	Undersvoltage error	L1-phase open error	Power synchronizing signal error
0				
1	●			
2		●		
3	●	●		
4			●	
5	●		●	
6		●	●	
7	●	●	●	
8				●
9	●			●
A		●		●
b	●	●		●
C			●	●
d	●		●	●
E		●	●	●
F	●	●	●	●

Error content ②

● : Detected

Display	Converter Fo error	PAM error
0		
1	●	
2		●
3	●	●

[Contact demand capacity] (Request code : "61")

Data display

0	0	0	*
---	---	---	---

 Setting content

Setting content

Display	Setting value
0	0%
1	50%
2	75%
3	100%

[External input state] (Request code : "62")

Data display

0	0	0	*
---	---	---	---

 Input state

Input state ● : Input present

Display	Contact demand input	Silent mode input	Spare 1 input	Spare 2 input
0				
1	●			
2		●		
3	●	●		
4			●	
5	●		●	
6		●	●	
7	●	●	●	
8				●
9	●			●
A		●		●
b	●	●		●
C			●	●
d	●		●	●
E		●	●	●
F	●	●	●	●

[Outdoor unit --Capacity setting display] (Request code : "70")

Data display	Capacity
9	35
10	50
11	60
14	71
20	100
25	125
28	140
40	200
50	250

[Outdoor unit – Setting information] (Request code : "71")

Data display

0	0	*	*
---	---	---	---

 Setting information ①
Setting information ②

Setting information ①

Display	Defrost mode
0	Standard
1	For high humidity

Setting information ②

Display	Single-/3-phase	Heat pump/cooling only
0	Single-phase	Heat pump
1		Cooling only
2	3-phase	Heat pump
3		Cooling only

[Indoor unit – Capacity setting information] (Request code : "163")

Data display

0	0	*	*
---	---	---	---

See the table on the right.

Display	Capacity setting state	Display	Capacity setting state
00	12	10	112
01	16	11	125
02	22	12	140
03	25	13	160
04	28	14	200
05	32	15	224
06	35, 36	16	250
07	40	17	280
08	45	18	
09	50	19	
0A	56	1A	
0b	63	1b	
0C	71	1C	
0d	80	1d	
0E	90	1E	
0F	100	1F	

[Wireless pair No. (indoor control board side) setting] (Request code : "165")

Data display

0	0	*	*
---	---	---	---

See the table on the right.

Display	Pair No. setting state
00	No. 0
01	No. 1 J41 disconnected
02	No. 2 J42 disconnected
03	No. 3 J41, J42 disconnected

13-1. SMOOTH MAINTENANCE

13-1-1. <PAR-4xMAA ("x" represents 0 or later)>

Maintenance data, such as the indoor/outdoor unit's heat exchanger temperature and compressor operation current can be displayed with "Smooth maintenance".

This cannot be executed during test operation.

Depending on the combination with the outdoor unit, this may not be supported by some models.

- Reduces maintenance work drastically.
- Enables you to check operation data of the indoor and outdoor units by remote controller.

Furthermore, use of maintenance stable-operation control that fixes the operating frequency, allows smooth inspection, even for inverter models.

Smooth Maintenance Function

Discharge temperature 60°C

Smooth maintenance 2/3	
Ref.address	0 Cool
Sub cool	3°C
OU TH4 temp.	60°C
OU TH6 temp.	38°C
OU TH7 temp.	30°C
Return:	⏪
▼ Page ▲	

• Conventional inspection work

• Outdoor unit •

Remove the service panel.

• Indoor unit •

Measure the intake air temperature.

Measure the discharge temperature.

Measure the outside air temperature.

Easy maintenance information (unit)

Compressor	Outdoor unit	Indoor unit
① Accumulated operating time (×10 hours)	④ Heat exchanger temperature (°C)	⑦ Intake air temperature (°C)
② Number of ON/OFF times (×10 times)	⑤ Discharge temperature (°C)	⑧ Heat exchanger temperature (°C)
③ Operating current (A)	⑥ Outside air temperature (°C)	⑨ Filter operating time* (Hours)

* The filter operating time is the time that has elapsed since the filter was reset.

① Select "Service" from the Main menu, and press the [✓] button.



Select "Check" with the [F1] or [F2] button, and press the [✓] button.



Select "Smooth maintenance" with the [F1] or [F2] button, and press the [✓] button.

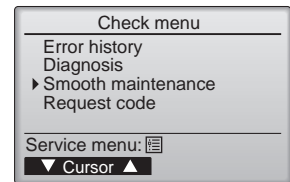

② Set each item.

Select the item to be changed with the [F1] or [F2] button.

Select the required setting with the [F3] or [F4] button.

- <Ref.address> setting [0] - [15]
- <Stable mode> setting [Cool] / [Heat] / [Normal]

Press the [✓] button, Fixed operation will start.

Note: Stable mode will take approx. 20 minutes.

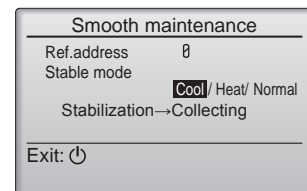
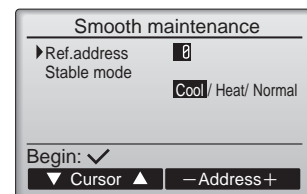

Continue to the next page

③ The operation data will appear.



The Compressor-Accumulated operating (COMP. run) time is 10-hour unit, and the Compressor-Number of operation times (COMP. ON/OFF) is a 100-time unit (fractions discarded).

Smooth maintenance 1/3	
Ref. address	0 Cool
COMP. current	12 A
COMP. run time	1000 Hr
COMP. On / Off	2000 times
COMP. frequency	80 Hz
Return: ⤵	
▼ Page ▲	

Smooth maintenance 2/3	
Ref. address	0 Cool
Sub cool	3 °C
OU TH4 temp.	60 °C
OU TH6 temp.	38 °C
OU TH7 temp.	30 °C
Return: ⤵	
▼ Page ▲	

Smooth maintenance 3/3	
Ref. address	0 Cool
IU air temp.	28 °C
IU HEX temp.	10 °C
IU filter time	120 Hr
Return: ⤵	
▼ Page ▲	

Navigating through the screens

- To go back to the Service menu [] button
- To return to the previous screen..... [] button

■ Refrigerant address

Single refrigerant system

In the case of single refrigerant system, the refrigerant address is "00" and no operation is required.

Simultaneous twin, triple units belong to this category (single refrigerant system).

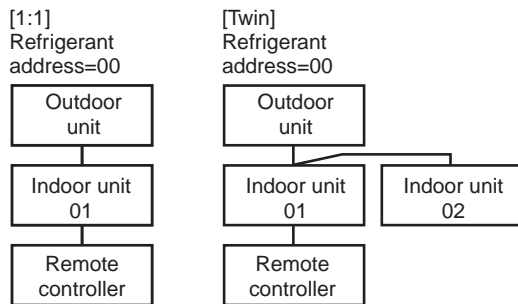

Multi refrigerant system (group control)

Up to 16 refrigerant systems (16 outdoor units) can be connected as a group by 1 remote controller. To check or set the refrigerant addresses.

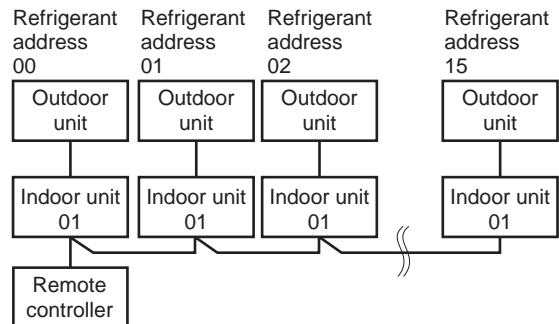

<Guide for operation condition>

Checkpoints

Enter the temperature differences between ⑤, ④, ⑦ and ⑧ into the graph given below.
Operation state is determined according to the plotted areas on the graph.

For data measurements, set the fan speed to "Hi" before activating maintenance mode.

Inspection item		Result		
Power supply	Loose connection	Breaker	Good Retightened	
		Outdoor Unit	Good Retightened	
		Indoor Unit	Good Retightened	
	Terminal block	Good Retightened		
	(Insulation resistance)		MΩ	
	(Voltage)		V	
Compressor	① Accumulated operating time		Time	
	② Number of ON/OFF times		Times	
	③ Current		A	
Outdoor Unit	Temperature	④ Refrigerant/heat exchanger temperature	COOL °C HEAT °C	
		⑤ Refrigerant/discharge temperature	COOL °C HEAT °C	
		⑥ Air/outside air temperature	COOL °C HEAT °C	
		(Air/discharge temperature)	COOL °C HEAT °C	
	Cleanliness	Appearance	Good	Cleaning required
		Heat exchanger	Good	Cleaning required
Indoor Unit	Temperature	⑦ Air/intake air temperature	COOL °C HEAT °C	
		(Air/discharge temperature)	COOL °C HEAT °C	
		⑧ Refrigerant/heat exchanger temperature	COOL °C HEAT °C	
		⑨ Filter operating time*		Time
	Cleanliness	Decorative panel	Good	Cleaning required
		Filter	Good	Cleaning required
	Fan	Good	Cleaning required	
	Heat exchanger	Good	Cleaning required	
	Sound/vibration	None	Present	

Classification	Item	Result	
Cool	Inspection	Is "D000" displayed stably on the remote controller?	Stable Unstable
	Temperature difference	(⑤ Discharge temperature) – (④ Outdoor heat exchanger temperature)	°C
Heat	Inspection	Is "D000" displayed stably on the remote controller?	Stable Unstable
	Temperature difference	(⑤ Discharge temperature) – (⑧ Indoor heat exchanger temperature) – (⑦ Indoor intake air temperature)	°C

Notes:

- Fixed Hz operation may not be possible under the following temperature ranges.
 - In cool mode, outdoor intake air temperature is 40°C or higher or indoor intake air temperature is 23°C or lower.
 - In heat mode, outdoor intake air temperature is 20°C or higher or indoor intake air temperature is 25°C or lower.
- If the air conditioner is operated at a temperature range other than the ones above but operation is not stabilized after 30 minutes or more have elapsed, carry out inspection.
- In heat mode, the operation state may vary due to frost forming on the outdoor heat exchanger.

* The filter operating time is the time that has elapsed since the filter was reset.

Cool mode

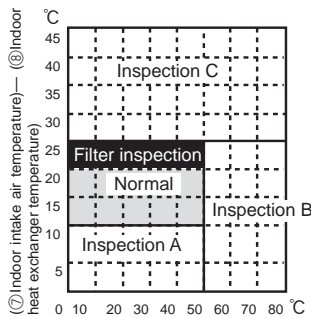

[(⑤ Discharge temperature) – (④ Outdoor heat exchanger temperature)]

Heat mode

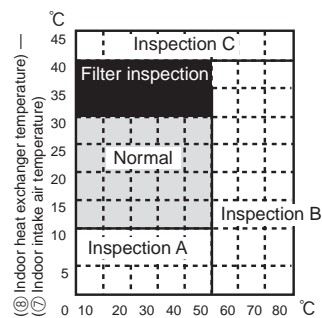

[(⑤ Discharge temperature) – (⑧ Indoor heat exchanger temperature)]

Result

Area	Check item	Judgment	
		Cool	Heat
Normal	Normal operation state		
Filter inspection	Filter may be clogged.*		
Inspection A	Performance has dropped. Detailed inspection is necessary.		
Inspection B	Refrigerant amount is dropping.		
Inspection C	Filter or indoor heat exchanger may be clogged.		

Note: The above judgment is just guide based on Japanese standard conditions.
It may be changed depending on the indoor and outdoor temperature.

PUZ-M200YKA.UK

PUZ-M250YKA.UK

→ : Indicates the visible parts in the photos/figures.

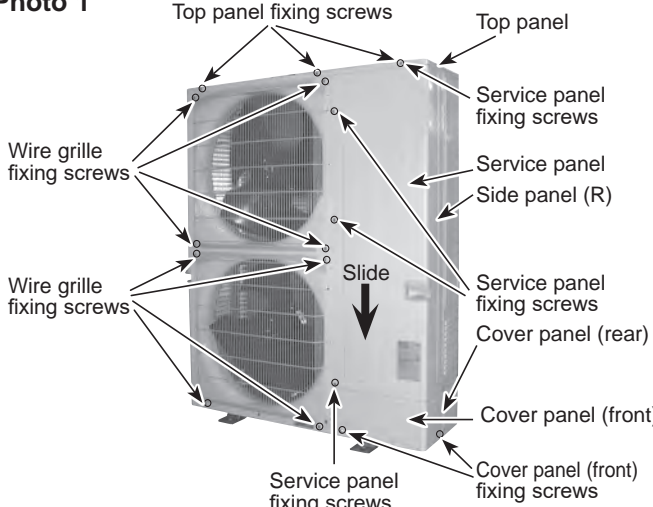
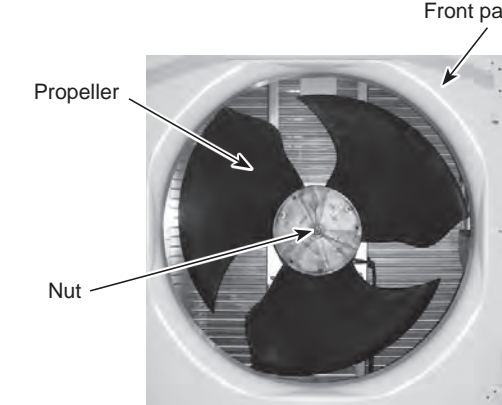
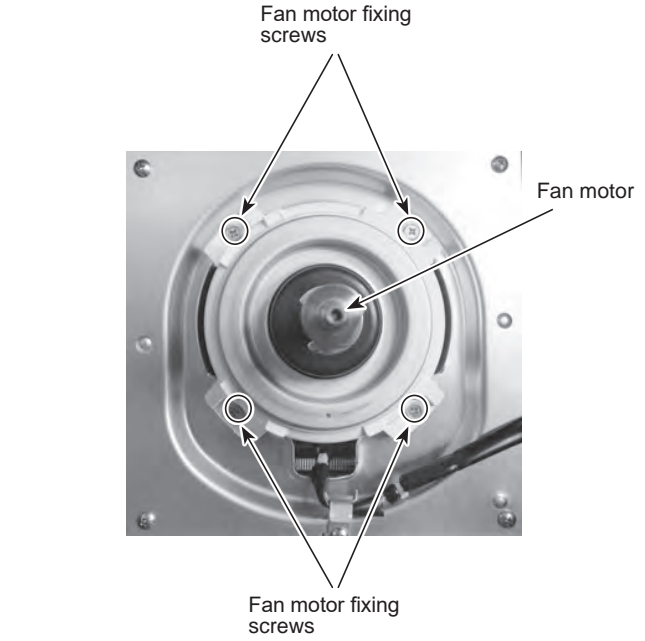
OPERATING PROCEDURE	PHOTOS/FIGURES
<p>1. Removing the service panel and top panel</p> <p>(1) Remove the service panel fixing screws (4 for front/ 5 x 12), then slide the service panel downward to remove it. (The service panel is fixed to the side panel (R) with a hook on the right side.)</p> <p>(2) Remove the top panel fixing screws (3 for front and 3 for rear/ 5 x 12) to remove the top panel.</p> <p>Note: When removing service panel and top panel at the same time, count one less screw since they share a screw.</p>	<p>Photo 1</p> 
<p>2. Removing the fan motor (MF1, MF2)</p> <p>(1) Remove the service panel. (See Photo 1)</p> <p>(2) Remove the wire grille fixing screws (4 for front/ 5 x 12), then slide the wire grille upward to remove it. (See Photo 1) (For the each fan motor on top and under)</p> <p>(3) Remove the screw of nut (1 for front/ M6), then slide the propeller fan forward to remove it. (For the each fan motor on top and under)</p> <p>(4) Disconnect the connectors, CNF1 (WHT) and CNF2 (WHT) on the controller circuit board in the electrical parts box. (See Photo 4)</p> <p>(5) Loosen the clamp for the lead wire on motor support and separator.</p> <p>(6) Release the lead wire from the hole on separator.</p> <p>(7) Remove the fan motor fixing screws (4 for front/ 5 x 20) to remove the fan motor. (For the each fan motor on top and under)</p>	<p>Photo 2</p> 
	<p>Photo 3</p> 

OPERATING PROCEDURE

3. Removing the electrical parts box

- (1) Remove the service panel. (See Photo 1)
- (2) Remove the top panel. (See Photo 1)
- (3) Disconnect the power supply cable from terminal block.
- (4) Disconnect the indoor/outdoor connecting wire from terminal block.
- (5) Disconnect the connector CNF1 (WHT), CNF2 (WHT), TH3 (WHT), TH4 (WHT), TH7/6 (RED), TH33 (YE), 63H(YLW), 21S4 (GRN), LEV-A (WHT), LEV-B (RD) from the controller circuit board.
<Symbols on the board>
 - Fan motor (CNF1, CNF2)
 - Thermistor <Liquid> (TH3)
 - Thermistor <Ambient/ 2-Phase Pipe> (TH7/6)
 - Thermistor <Comp. Surface> (TH33)
 - Thermistor <Discharge> (TH4)
 - High pressure switch (63H)
 - 4-way valve (21S4)
 - LEV (LEV-A/LEV-B)
- (6) Loosen the clamps, fasteners and cable strap for the lead wire in the electrical parts box and separator.
- (7) Loosen the lead wires fixed to the pipes with bands.
- (8) To disconnect the COMP lead wire, remove the terminal cover, then remove the COMP lead wire fixing screws (3 for front/ 5 x 12).
- (9) Remove the electrical parts box fixing screws (2 for front/ 4 x 10), then slide the electrical parts box upward to remove it.
(The electrical parts box is fixed to the side panel (R) with a hook on the right side, and to the separator duct with a hook on the left side.)

PHOTOS/FIGURES

Photo 4

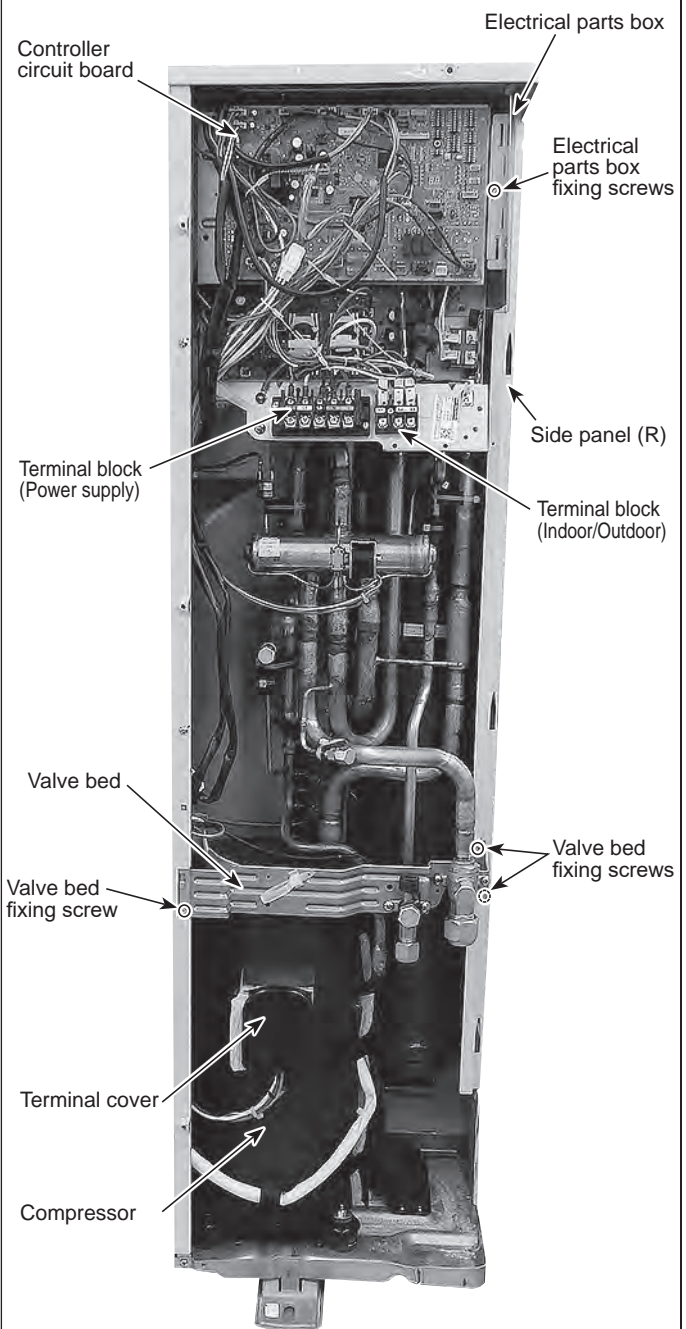

OPERATING PROCEDURE

4. Disassembling the electrical parts box

- (1) Disconnect all the connectors on the controller circuit board.
- (2) To remove the controller circuit board, release it from the support.
- (3) Remove cont. base fixing screws (2 for front/ 4 x 10) and clip. (Photo 5)
(The cont. base is fixed to the cont. base piece with a hook on the left side.)
- (4) Disconnect all the connectors on the noise filter circuit board. (Photo 6)
- (5) To remove the noise filter circuit board, release it from the support.
- (6) Remove N.F. base fixing screws (2 for front/ 4 x 10). (Photo 7)
- (7) Disconnect all the connectors on the power circuit board.
- (8) To remove the power circuit board, remove power board fixing screws (4 for front/ 4 x 12), then release the board from the support. (Photo 8)
- (9) The reactor is attached to the rear side of the electrical parts box. (Photo 9)
(To remove the reactor, the electrical parts box must be separated from the outdoor unit.)

Note: When reassembling the electrical parts box, make sure the wirings are correct.

PHOTOS/FIGURES

Photo 5

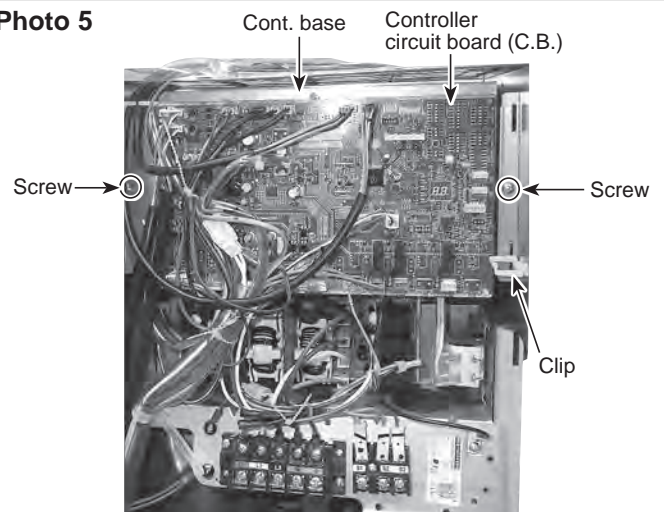

Photo 6

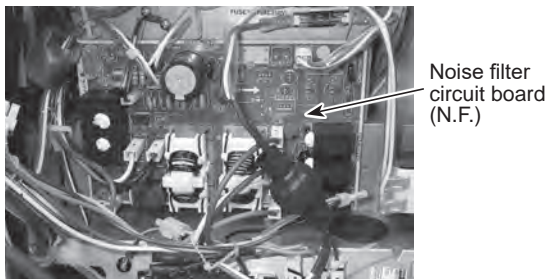

Photo 7

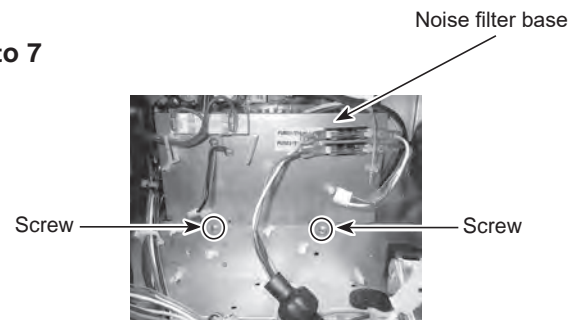

Photo 8

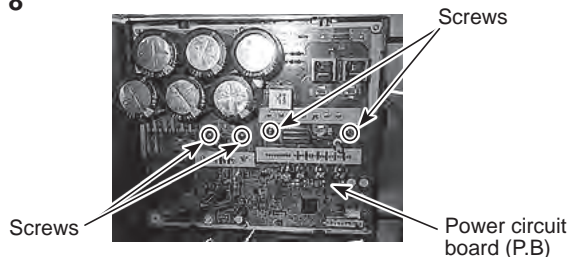
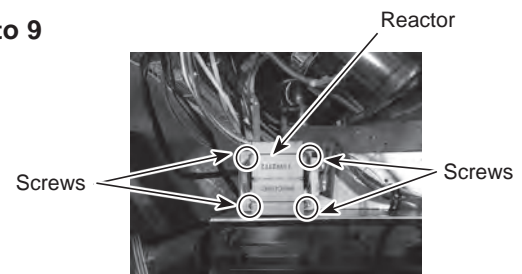

Photo 9



5. Removing the thermistor <2-Phase Pipe> (TH6)

- (1) Remove the service panel. (See Photo 1)
- (2) Remove the top panel. (See Photo 1)
- (3) Disconnect the connector TH7/6 (RED) on the controller circuit board in the electrical parts box. (See Photo 4)
- (4) Loosen the fastener for the lead wire in the electrical parts box.
- (5) Loosen the clamp for the lead wire on the top of electrical parts box.
- (6) Pull out the thermistor <2-phase pipe> (TH6) from thermistor clip.

Note: When replacing thermistor <2-phase pipe> (TH6), replace it together with thermistor <Ambient> (TH7) since they are combined together. Refer to procedure No.6 on the next page to remove the thermistor <Ambient> (TH7).

Photo 10

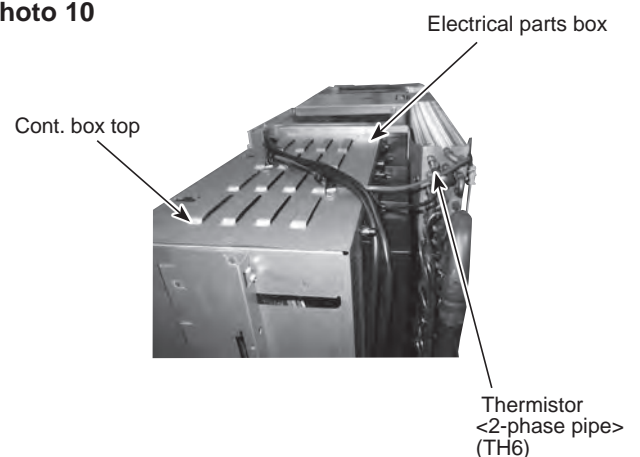

OPERATING PROCEDURE

6. Removing the thermistor <Ambient> (TH7)

- (1) Remove the service panel. (See Photo 1)
- (2) Remove the top panel. (See Photo 1)
- (3) Disconnect the connector TH7/6 (RED) on the controller circuit board in the electrical parts box. (See Photo 4)
- (4) Loosen the fastener for the lead wire in the electrical parts box.
- (5) Loosen the clamps for the lead wire on top of the electrical parts box.
- (6) Pull out the thermistor <Ambient> (TH7) from thermistor holder.

Note: When replacing thermistor <Ambient> (TH7), replace it together with thermistor <2-phase pipe> (TH6), since they are combined together. Refer to procedure No.5 in the previous page to remove the thermistor <2-phase pipe>(TH6).

7. Removing the thermistor <Liquid> (TH3), thermistor <Discharge> (TH4) and thermistor <Comp. surface> (TH33), Thermal protector (TRS).

- (1) Remove the service panel. (See Photo 1)
- (2) Disconnect the connector, TH3 (WHT), TH4(WH) and TH33(YE) on the controller circuit board in the electrical parts box. (See Photo 4)
- (3) Loosen the fastener, cable strap and band for the lead wire on the controller circuit board in the electrical parts box.
- (4) Loosen the clamp for the lead wire on separator.
- (5) Pull out the thermistor <Liquid> (TH3) from thermistor clip and thermistor <Discharge> (TH4) from thermistor holder.
- (6) Remove the damper cover and damper top, then pull out the thermistor <Comp. surface> (TH33) from thermistor holder.
- (7) Remove the lead wire on the thermal protector (TRS) from the hook-and-loop fastener on the damper.
- (8) Remove the damper and pull out the thermal protector (TRS) from the holder.

PHOTOS/FIGURES

Photo 11

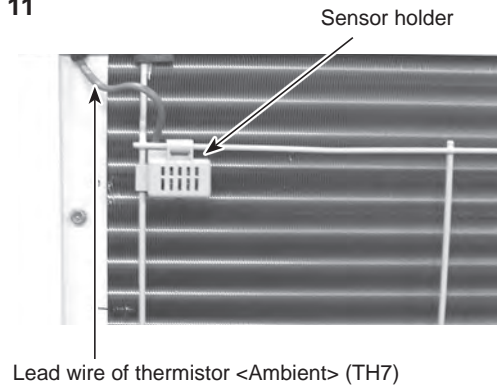
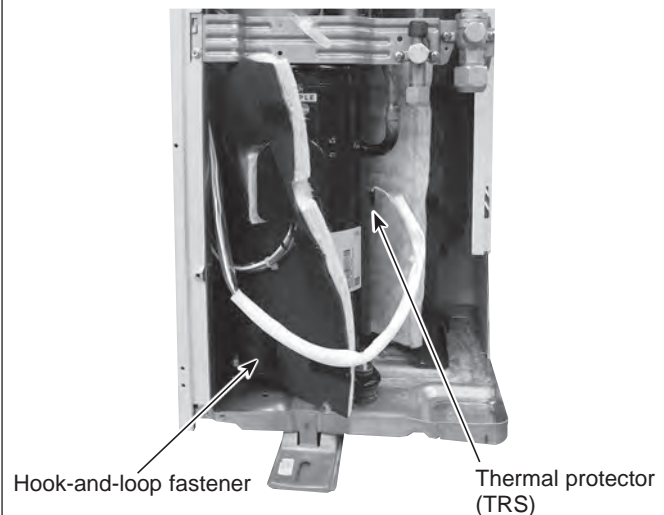
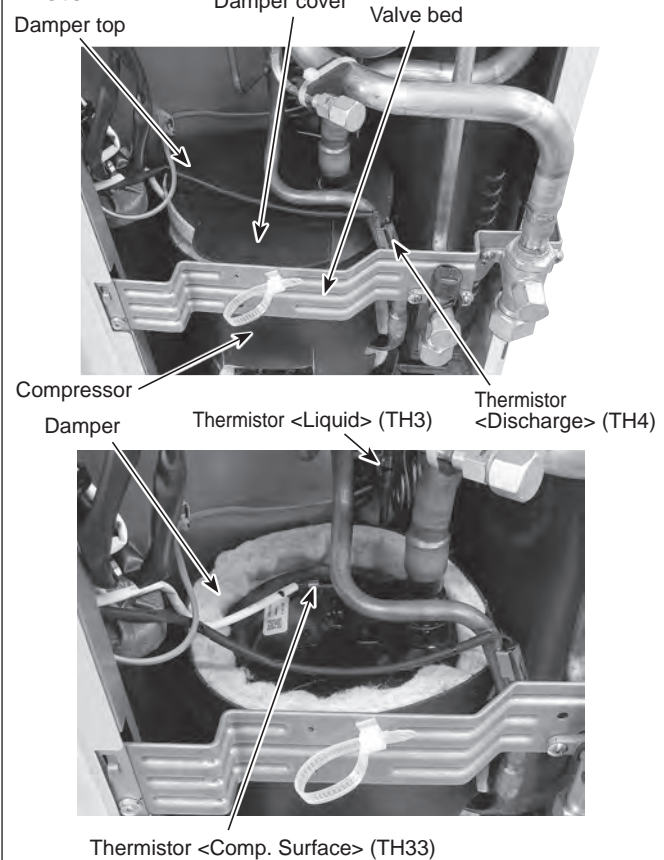

Photo 12



OPERATING PROCEDURE

8. Removing the 4-way valve coil (21S4), LEV coil (LEV(A)/LEV(B)) and lead wire for high pressure switch.

- (1) Remove the electrical parts box. (See Photo 4)
- (2) Loosen the clamp for the lead wire on separator.

[Removing the lead wire for high pressure switch]

- (3) Disconnect the lead wire from the high pressure switch.

[Removing the 4-way valve coil]

- (3) Remove the 4-way valve coil fixing screw (1 for front/M5) to remove the 4-way valve coil.
- (4) Slide the 4-way valve coil forward to remove it.

[Removing the LEV coil]

- (3) Loosen the lead wires fixed to the pipes with bands.
- (4) Slide the LEV coil upward to remove it.

9. Removing the 4-way valve, LEV (LEV(A)/LEV(B)) and high pressure switch.

- (1) Remove the electrical parts box. (See Photo 4)
- (2) Remove the cover panel (front). (See Photo 1)
- (3) Remove the cover panel (rear). (See Photo 1)
- (4) Remove the valve bed. (See Photo 14)
- (5) Remove the side panel (R).
- (6) Recover refrigerant.

[Removing the 4-way valve]

- (7) Remove the 4-way valve coil. (See photo 13)
- (8) Remove the welded part of 4-way valve (4 positions) to remove the 4-way valve.

[Removing the LEV]

- (7) Remove the LEV coil. (See photo 13)
- (8) Remove the welded part of LEV (2 positions) to remove the LEV.

[Removing the high pressure switch]

- (7) Disconnect the lead wire from the high pressure switch.
- (8) Remove the welded part of high pressure switch (1 position) to remove the high pressure switch.

Note 1: Recover refrigerant without spreading it in the air.

Note 2: The welded part can be removed easily by removing the side panel (R).

Note 3: When installing the following parts, cover it with a wet cloth to prevent it from heating as the temperature below, then braze the pipes so that the inside of pipes are not oxidized;

- 4-way valve, 120°C or more
- LEV, 120°C or more
- High pressure switch, 100°C or more

PHOTOS/FIGURES

Photo 13

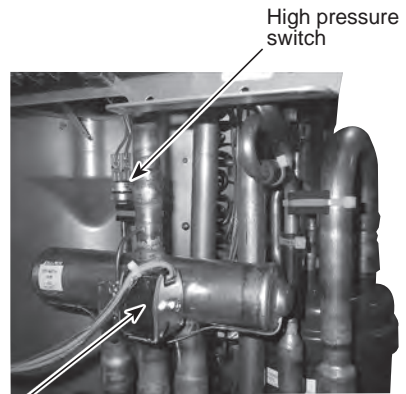

4-way valve coil (21S4)

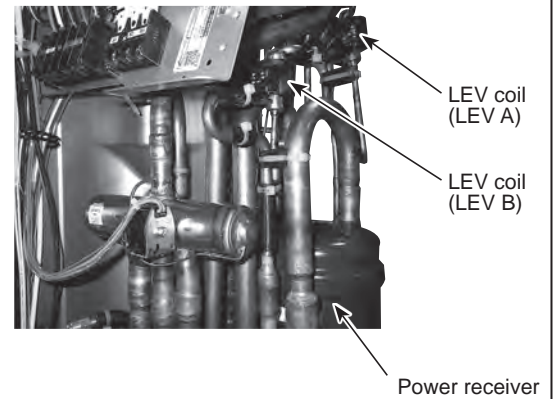

OPERATING PROCEDURE

10. Removing the compressor (MC)

- (1) Remove the electrical parts box. (See Photo 4)
- (2) Remove the cover panel (front). (See Photo 1)
- (3) Remove the cover panel (rear). (See Photo 1)
- (4) Remove the valve bed. (See photo 14)
- (5) Remove the side panel (R). (See Photo 1)
- (6) Remove the front panel fixing screws (5 for front/ 5x12 and 2 for front/ 4x10), then slide the front panel upward to remove it.
(The front panel is fixed with 4 hooks; 3 on the left side fixing to the side panel (L), and the other on the right side fixing to the separator.)
- (7) Release the lead wire for FM1 and FM2 from the hole on separator.
- (8) Remove the separator fixing screws (4 for front/ 4x10), then slide the separator upward to remove it. (The separator is fixed to a hook of the side plate.)
- (9) Recover refrigerant.
- (10) Remove the welded part of compressor (2 positions).
- (11) Remove the 3 compressor fixing nuts (M6) to remove the compressor.

Note 1: Recover refrigerant without spreading it in the air.
Note 2: The compressor can be easily removed by removing separator.

PHOTOS/FIGURES

Photo 14

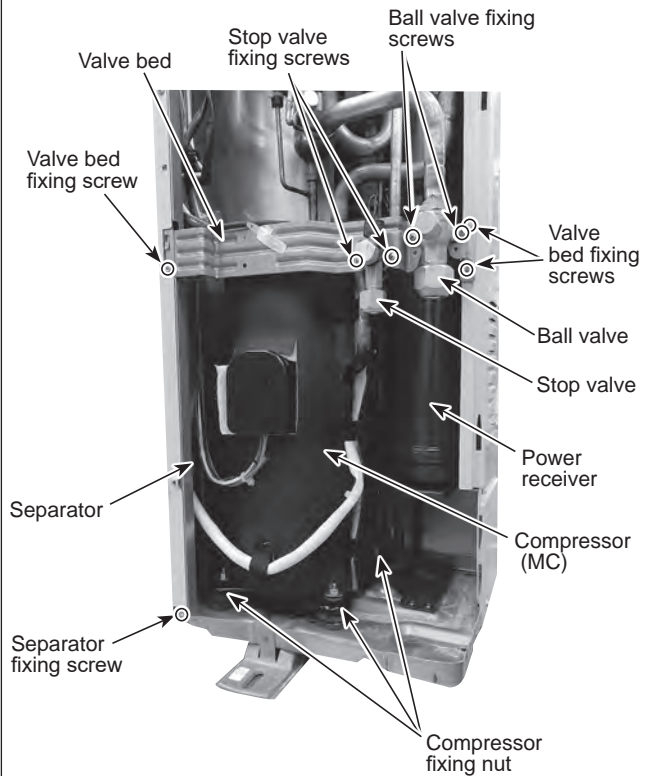

11. Removing the power receiver

- (1) Remove the electrical parts box. (See photo 4)
- (2) Remove the cover panel (front). (See Photo 1)
- (3) Remove the cover panel (rear). (See Photo 1)
- (4) Remove the ball valve fixing screws (2 for front/ 5x16). (See Photo14)
- (5) Remove the stop valve fixing screws (2 for front/ 5x16). (See Photo14)
- (6) Remove the valve bed. (See Photo 14)
- (7) Remove the side panel (R). (See Photo 1)
- (8) Recover refrigerant.
- (9) Remove the welded part of the power receiver (4 positions) to remove the receiver.
- (10) Remove receiver leg fixing screws (2 for front/ 4 x 10), then slide the power receiver forward to remove it.
(The power receiver is fixed to the base with a hook on the bottom.)

Note: Recover refrigerant without spreading it in the air.

Photo 15

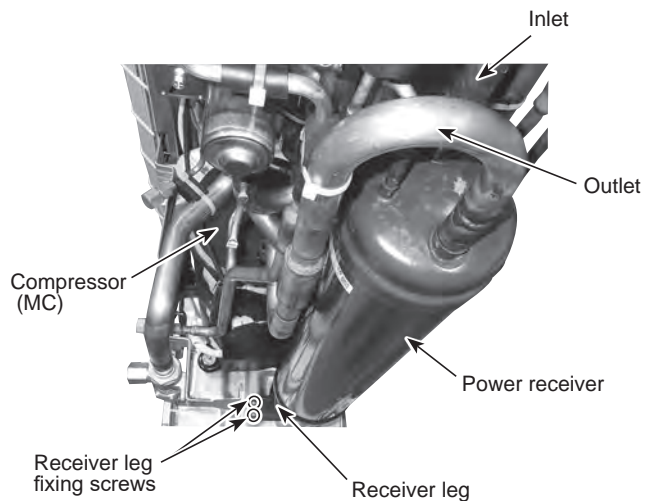



Mr. SLIM

mitsubishi electric corporation

HEAD OFFICE: TOKYO BUILDING, 2-7-3, MARUNOUCHI, CHIYODA-KU, TOKYO 100-8310, JAPAN