

**August 2013**

**No. OCH466  
REVISED EDITION-B**

# SERVICE MANUAL

**R410A**

[Model name]

[Service Ref.]

PUHZ-HRP200YKA

**PUHZ-HRP200YKA**

Revision:

- "7. REFRIGERANT SYSTEM DIAGRAM" has been modified in REVISED EDITION-B.
- Some descriptions have been modified.

- Please void OCH466 REVISED EDITION-A.

Note:

- This manual describes only service data of the outdoor unit.
- Refer to Technical manual of ATW, I/F and FTC.
- RoHS compliant products have <G> mark on the spec name plate.

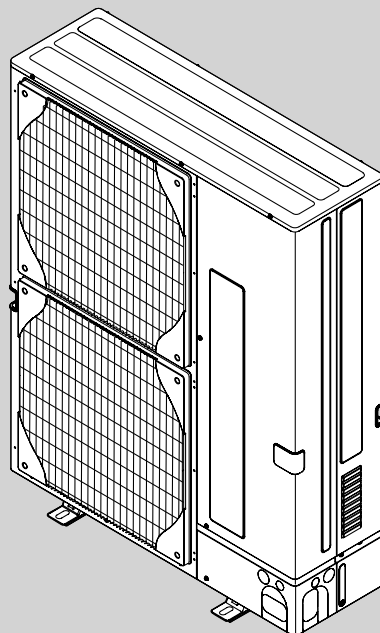

**PUHZ-HRP200YKA**

## CONTENTS

1. SAFETY PRECAUTION.....	2
2. SPECIFICATIONS.....	5
3. DATA .....	7
4. OUTLINES AND DIMENSIONS.....	9
5. WIRING DIAGRAM.....	10
6. WIRING SPECIFICATIONS .....	11
7. REFRIGERANT SYSTEM DIAGRAM .....	13
8. TROUBLESHOOTING .....	14
9. DISASSEMBLY PROCEDURE .....	47

**PARTS CATALOG (OCB466)**

**1-1. ALWAYS OBSERVE FOR SAFETY**

**Before obtaining access to terminal, all supply circuits must be disconnected.**

**Preparation before the repair service.**

- Prepare the proper tools.
- Prepare the proper protectors.
- Provide adequate ventilation.
- After stopping the operation of the air conditioner, turn off the power-supply beaker.
- Discharge the condenser before the work involving the electric parts.

**Precautions during the repair service.**

- Do not perform the work involving the electric parts with wet hands.
- Do not pour water into the electric parts.
- Do not touch the refrigerant.
- Do not touch the hot or cold areas in the refrigerating cycle.
- When the repair or the inspection of the circuit needs to be done without turning off the power, exercise great caution not to touch the live parts.

**1-2. CAUTIONS RELATED TO NEW REFRIGERANT****Cautions for units utilizing refrigerant R410A****Do not use refrigerant other than R410A.**

If other refrigerant (R22 etc.) is used, chlorine in refrigerant can cause deterioration of refrigerant oil etc.

**Use a vacuum pump with a reverse flow check valve.**

Vacuum pump oil may flow back into refrigerant cycle and that can cause deterioration of refrigerant oil etc.

**Use the following tools specifically designed for use with R410A refrigerant.**

The following tools are necessary to use R410A refrigerant.

Tools for R410A	
Gauge manifold	Vacuum pump adaptor
Charge hose	Electronic refrigerant charging scale
Gas leak detector	
Torque wrench	

**Handle tools with care.**

If dirt, dust or moisture enters into refrigerant cycle, that can cause deterioration of refrigerant oil or malfunction of compressor.

**Do not use a charging cylinder.**

If a charging cylinder is used, the composition of refrigerant will change and the efficiency will be lowered.

**Charge refrigerant from liquid phase of gas cylinder.**

If the refrigerant is charged from gas phase, composition change may occur in refrigerant and the efficiency will be lowered.

**Use the specified refrigerant only.**

**Never use any refrigerant other than that specified.** Doing so may cause a burst, an explosion, or fire when the unit is being used, serviced, or disposed of. Correct refrigerant is specified in the manuals and on the spec labels provided with our products. We will not be held responsible for mechanical failure, system malfunction, unit breakdown or accidents caused by failure to follow the instructions.

**Ventilate the room if refrigerant leaks during operation. If refrigerant comes into contact with a flame, poisonous gases will be released.**

### [1] Cautions for service

- (1) Perform service after recovering the refrigerant left in unit completely.
- (2) Do not release refrigerant in the air.
- (3) After completing service, charge the cycle with specified amount of refrigerant.

### [2] Additional refrigerant charge

#### When charging directly from cylinder

- Check that cylinder for R410A on the market is syphon type.
- Charging should be performed with the cylinder of syphon stood vertically. (Refrigerant is charged from liquid phase.)

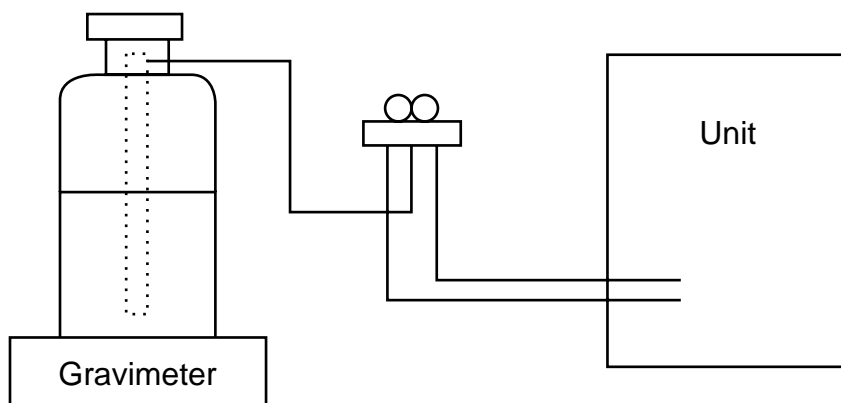

### [3] Service tools

Use the below service tools as exclusive tools for R410A refrigerant.

No.	Tool name	Specifications
①	Gauge manifold	· Only for R410A
		· Use the existing fitting specifications. (UNF1/2)
		· Use high-tension side pressure of 5.3 MPa·G or over.
②	Charge hose	· Only for R410A
		· Use pressure performance of 5.09 MPa·G or over.
③	Electronic scale	—
④	Gas leak detector	· Use the detector for R134a, R407C or R410A.
⑤	Adaptor for reverse flow check	· Attach on vacuum pump.
⑥	Refrigerant charge base	—
⑦	Refrigerant cylinder	· Only for R410A Top of cylinder (Pink) Cylinder with syphon
⑧	Refrigerant recovery equipment	—

### 1-3. CAUTIONS FOR REFRIGERANT PIPING WORK

Tools for R410A (The following table shows whether conventional tools can be used or not.)

Tools and materials	Use	R410A tools	Can R22 tools be used?	Can R407C tools be used?
Gauge manifold	Air purge, refrigerant charge and operation check	Tool exclusive for R410A	×	×
Charge hose		Tool exclusive for R410A	×	×
Gas leak detector	Gas leak check	Tool for HFC refrigerant	×	○
Refrigerant recovery equipment	Refrigerant recovery	Tool exclusive for R410A	×	×
Refrigerant cylinder	Refrigerant charge	Tool exclusive for R410A	×	×
Safety charger	Prevent compressor malfunction when charging refrigerant by spraying liquid refrigerant	Tool exclusive for R410A	×	×
Charge valve	Prevent gas from blowing out when detaching charge hose	Tool exclusive for R410A	×	×
Vacuum pump	Vacuum drying and air purge	Tools for other refrigerants can be used if equipped with adapter for reverse flow check	△ (Usable if equipped with adapter for reverse flow)	△ (Usable if equipped with adapter for reverse flow)
Bender	Bend the pipes	Tools for other refrigerants can be used	○	○
Pipe cutter	Cut the pipes	Tools for other refrigerants can be used	○	○
Welder and nitrogen gas cylinder	Weld the pipes	Tools for other refrigerants can be used	○	○
Refrigerant charging scale	Charge refrigerant	Tools for other refrigerants can be used	○	○
Vacuum gauge or thermistor vacuum gauge and vacuum valve	Check the degree of vacuum. (Vacuum valve prevents back flow of oil and refrigerant to thermistor vacuum gauge)	Tools for other refrigerants can be used	○	○
Charging cylinder	Refrigerant charge	Tool exclusive for R410A	×	—

× : Prepare a new tool. (Use the new tool as the tool exclusive for R410A.)

△ : Tools for other refrigerants can be used under certain conditions.

○ : Tools for other refrigerants can be used.

# 2

# SPECIFICATIONS

## 2-1. SPECIFICATION

### 2-1-1. PUHZ-HRP200YKA

<Reference data> Plate heat exchanger (ACH50-50 plates) \*2pcs [connected in parallel]

<b>Nominal water flow</b>		L/min	65.9
<b>Heating (A7/W35)</b>	Capacity	kW	23.0
	COP		3.65
	Power input	kW	6.31
<b>Heating (A7/W45)</b>	Capacity	kW	23.0
	COP		2.77
	Power input	kW	8.29
<b>Heating (A7/W55)</b>	Capacity	kW	23.0
	COP		2.27
	Power input	kW	10.15
<b>Heating (A-7/W35)</b>	Capacity	kW	23.0
	COP		2.24
	Power input	kW	10.25
<b>Heating (A-7/W45)</b>	Capacity	kW	23.0
	COP		1.93
	Power input	kW	11.90
<b>Heating (A-7/W55)</b>	Capacity	kW	23.0
	COP		1.66
	Power input	kW	13.86
<b>Heating (A-15/W35)</b>	Capacity	kW	23.0
	COP		2.05
	Power input	kW	11.24
<b>Heating (A-15/W45)</b>	Capacity	kW	22.2
	COP		1.80
	Power input	kW	12.36
<b>Heating (A-15/W55)</b>	Capacity	kW	21.2
	COP		1.36
	Power input	kW	15.64
<b>Heating (A2/W35)</b>	Capacity	kW	23.0
	COP		2.37
	Power input	kW	9.69
<b>Nominal water flow</b>		L/min	57.3
<b>Cooling (A35/W7)</b>	Capacity	kW	20.00
	EER		2.22
	Power input	kW	9.01
<b>Cooling (A35/W18)</b>	Capacity	kW	20.00
	EER		3.55
	Power input	kW	5.64

#### Rating conditions

<b>Nominal operating condition</b>	
<b>Heating (A2/W35)</b>	
Outside air temperature (Dry-bulb)	+ 2 °C
Outside air temperature (Wet-bulb)	+ 1 °C
Water temperature (inlet/outlet)	+ 30 °C/+ 35 °C
<b>Heating (A7/W35)</b>	
Outside air temperature (Dry-bulb)	+ 7 °C
Outside air temperature (Wet-bulb)	+ 6 °C
Water temperature (inlet/outlet)	+ 30 °C/+ 35 °C
<b>Heating (A7/W45)</b>	
Outside air temperature (Dry-bulb)	+ 7 °C
Outside air temperature (Wet-bulb)	+ 6 °C
Water temperature (inlet/outlet)	+ 40 °C/+ 45 °C
<b>Heating (A7/W55)</b>	
Outside air temperature (Dry-bulb)	+ 7 °C
Outside air temperature (Wet-bulb)	+ 6 °C
Water temperature (inlet/outlet)	+ 50 °C/+ 55 °C
<b>Heating (A-7/W35)</b>	
Outside air temperature (Dry-bulb)	- 7 °C
Outside air temperature (Wet-bulb)	—
Water temperature (inlet/outlet)	— °C/+ 35 °C
<b>Heating (A-7/W45)</b>	
Outside air temperature (Dry-bulb)	- 7 °C
Outside air temperature (Wet-bulb)	—
Water temperature (inlet/outlet)	— °C/+ 45 °C
<b>Heating (A-7/W55)</b>	
Outside air temperature (Dry-bulb)	- 7 °C
Outside air temperature (Wet-bulb)	—
Water temperature (inlet/outlet)	— °C/+ 55 °C
<b>Heating (A-15/W35)</b>	
Outside air temperature (Dry-bulb)	- 15 °C
Outside air temperature (Wet-bulb)	—
Water temperature (inlet/outlet)	— °C/+ 35 °C
<b>Heating (A-15/W45)</b>	
Outside air temperature (Dry-bulb)	- 15 °C
Outside air temperature (Wet-bulb)	—
Water temperature (inlet/outlet)	— °C/+ 45 °C
<b>Heating (A-15/W55)</b>	
Outside air temperature (Dry-bulb)	- 15 °C
Outside air temperature (Wet-bulb)	—
Water temperature (inlet/outlet)	— °C/+ 55 °C
<b>Cooling (A35/W7)</b>	
Outside air temperature (Dry-bulb)	+ 35 °C
Outside air temperature (Wet-bulb)	+ 24 °C
Water temperature (inlet/outlet)	+ 12 °C/+ 7 °C
<b>Cooling (A35/W18)</b>	
Outside air temperature (Dry-bulb)	+ 35 °C
Outside air temperature (Wet-bulb)	+ 24 °C
Water temperature (inlet/outlet)	+ 23 °C/+ 18 °C

Note: "COP" and "Power input" in the above table are values that does **NOT** contains the "pump input (based on EN 14511)".

## 2-1-2. Outdoor unit

Model name		PUHZ-HRP200YKA	
Running current	Heating(A7/W35)	A	9.6
	Cooling(A35/W7)	A	13.7
Power factor	Heating(A7/W35)	%	95
	Cooling(A35/W7)	%	95
Power supply (phase, cycle, voltage)		3 phase, 50 Hz, 400 V	
Max. current		A	25.0
Breaker size		A	32
Outer casing	Galvanized plate		
External finish	Munsell 3Y 7.8/1.1		
Refrigerant control	Liner expansion valve		
Compressor	Hermetic scroll		
	Model	ANB66FJHMT	
	Motor output	kW	4.7
	Start type	Inverter	
	Protection devices	HP switch LP switch Discharge thermo	
	Oil (Model)	L	1.7 (FV50S)
Crankcase heater		W	—
Heat exchanger	Air	Plate fin coil	
	Water	Plate heat exchanger	
Fan	Fan (drive) x No.	Propeller fan x 2	
	Fan motor output	kW	0.150 x 2
	Air flow	m <sup>3</sup> /min (CFM)	140 (4,940)
Defrost method	Reverse cycle *1		
Noise level (SPL)	Heating	dB	59 *2
	Cooling	dB	58 *2
Dimensions	Width	mm (in)	1050 (41-5/16)
	Depth	mm (in)	330 + 30 *3 (13+1-3/16)
	Height	mm (in)	1338 (52-11/16)
Weight		kg (lbs)	145 (320)
Refrigerant	R410A		
	Quantity	kg (lbs)	7.1 (15.7)
Guaranteed operating range (Outdoor)	Heating	°C	-25 ~ +35
	Cooling	°C	-5 *4 ~ +46
Outlet water temp. (Max. in heating, Min. in cooling)	Heating	°C	+60
	Cooling	°C	+5
Nominal return water temperature range	Heating	°C	+10 ~ +59
	Cooling	°C	+8 ~ +28
Water flow rate range		L/min	28.7 ~ 68.9

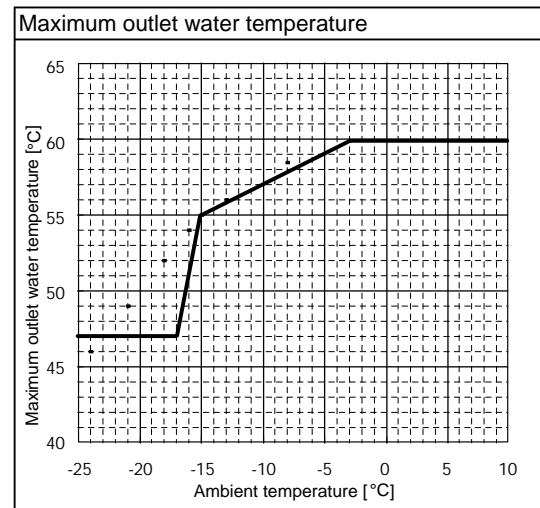

\*1 Hot gas with 4-way valve

\*2 at distance of 1m from outdoor unit

\*3 grill

\*4 With the optional air outlet guide, the operation at -15°C outdoor temperature is possible.

### 3-1. ADDITION OF REFRIGERANT

	At time of shipping	Total piping length (one way)					
		Amount of additional refrigerant charge (kg)					
		30 m and less	31-40 m	41-50 m	51-60 m	61-70 m	71-80 m
For single combination (1 indoor unit)	7.1 kg	No additional charge necessary	1.4 kg	2.8 kg	4.2 kg	5.6 kg	7.0 kg
For twin / triple / quadruple combination (2-4 indoor units)			0.9 kg	1.8 kg	Calculate the amount of additional refrigerant charge using formula provided below.		

**When length exceeds 50 m for twin / triple / quadruple combination**

When the total length of the piping exceeds 50 m, calculate the amount of additional charge based on the following requirements.  
 Note: If the calculation produces a negative number (i.e. a "minus" charge), of if calculation results in an amount that is less than the "Additional charge amount for 50 m", perform the additional charge using the amount shown in "Additional charge amount for 50 m".

Amount of additional charge (kg)	=	Main piping: Liquid line size $\phi 12.7$ overall length $\times 0.17$ (m) $\times 0.17$ (kg/m)	+	Main piping: Liquid line size $\phi 9.52$ overall length $\times 0.14$ (Gas line: $\phi 25.4$ ) (m) $\times 0.14$ (kg/m)	+	Branch piping: Liquid line size $\phi 9.52$ overall length $\times 0.05$ (Gas line: $\phi 15.88$ ) (m) $\times 0.05$ (kg/m)	+	Branch piping: Liquid line size $\phi 6.35$ overall length $\times 0.02$ (m) $\times 0.02$ (kg/m)	-	4.3 (kg)
Additional charge amount for 50 meters	1.8 kg									

<Limits of refrigerant piping installation>

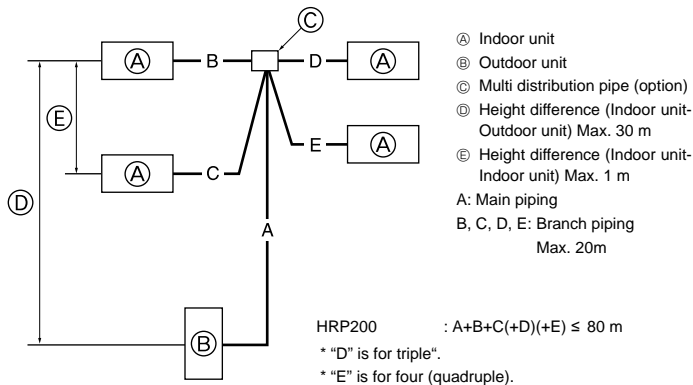

Permissible total piping length A+B+C+D+E	A+B or A+C or A+D or A+E	Charge-less piping length A+B+C+D+E
80 m and less	70 m and less	30 m and less

B-C   or   B-D   or   B-E   or   C-D   or   C-E   or   D-E	No. of bends
8 m and less	Within 15

### 3-2. NOISE CRITERION CURVES

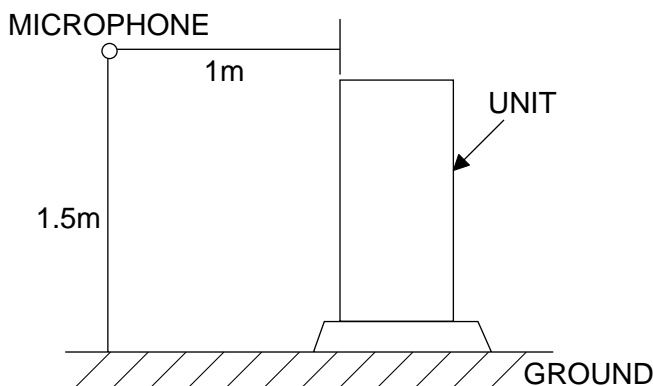

### PUHZ-HRP200YKA

MODE	SPL(dB)	LINE
COOLING	58	○—○
HEATING	59	●—●

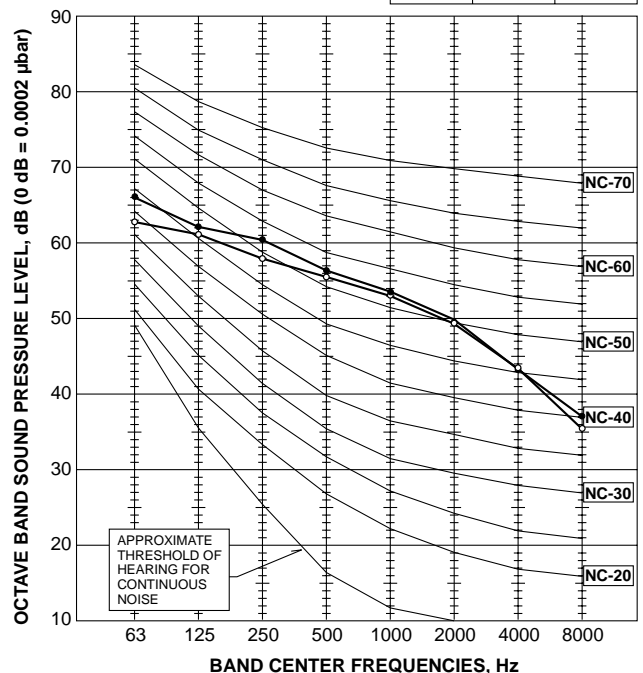

### 3-3. STANDARD OPERATION DATA

### Reference data (connect to Plate HEX)

			(ACH50-50 plates) × 2 pcs [connected in parallel]	
Mode			Cooling (A35/W7)	Heating (A7/W35)
Total	Capacity	W	20,000	23,000
	Input	kW	9.01	6.31
Electrical circuit	Outdoor unit		PUHZ-HRP200YKA	
	Phase, Hz		3, 50	
	Voltage	V	400	
	Current	A	13.7	9.6
Refrigerant circuit	Discharge pressure	MPa	3.0	2.0
	Suction pressure	MPa	0.7	0.6
	Discharge temperature	°C	79	73
	Condensing temperature	°C	49	35
	Suction temperature	°C	8	8
	Evaporating temperature	°C	6	2
	Evaporator inlet temperature	°C	7	—
	Evaporator outlet temperature	°C	6	—
	Condenser inlet temperature	°C	—	65
	Condenser outlet temperature	°C	—	34
Water conditions	Flow volume	L/min	57.3	65.9
	Outlet water temperature	°C	7	35
Outdoor conditions	Intake air temperature	D.B. °C	35	7
		W.B. °C	24	6

Piping length : Main 2.5m, Branch 2.5m / 2.5m

The unit of pressure has been changed to MPa based on international SI system.

The conversion factor is: 1 (MPa) = 10.2 (kgf/cm<sup>2</sup>)

### 3-4. CAPACITY CORRECTION (Refrigerant piping length)

Cooling and heating capacity is lowered according to the piping length. Capacity can be obtained by referring to the following capacity curves.

Corrected pipe length (m) = actual pipe length (m) + number of bends × 0.3 (m)

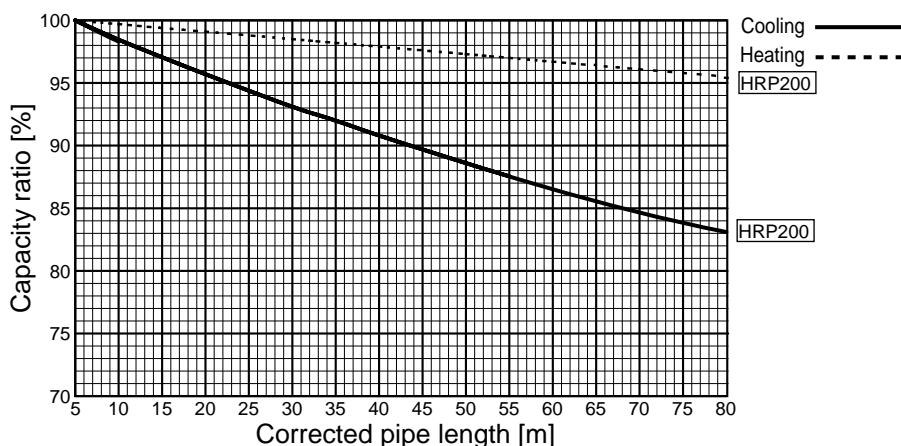



1 FREE SPACE (Around the unit)

The diagram below shows a basic example. Explanation of particular details are given in the installation manuals etc.

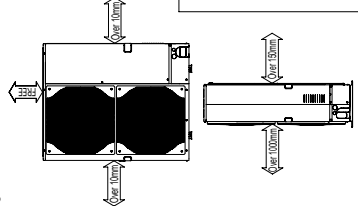

2 SERVICE SPACE

Dimensions of space needed for service access are shown in the below diagram.

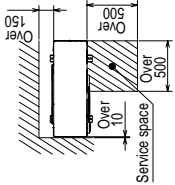

3 FOUNDATION BOLTS

Please secure the unit firmly with 4 foundation (M10) bolts. (Bolts and washers must be purchased locally).

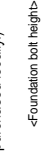

4 PIPING-WIRING DIRECTIONS

Piping and wiring connections can be made from 4 directions: FRONT, Right, Rear and Below.

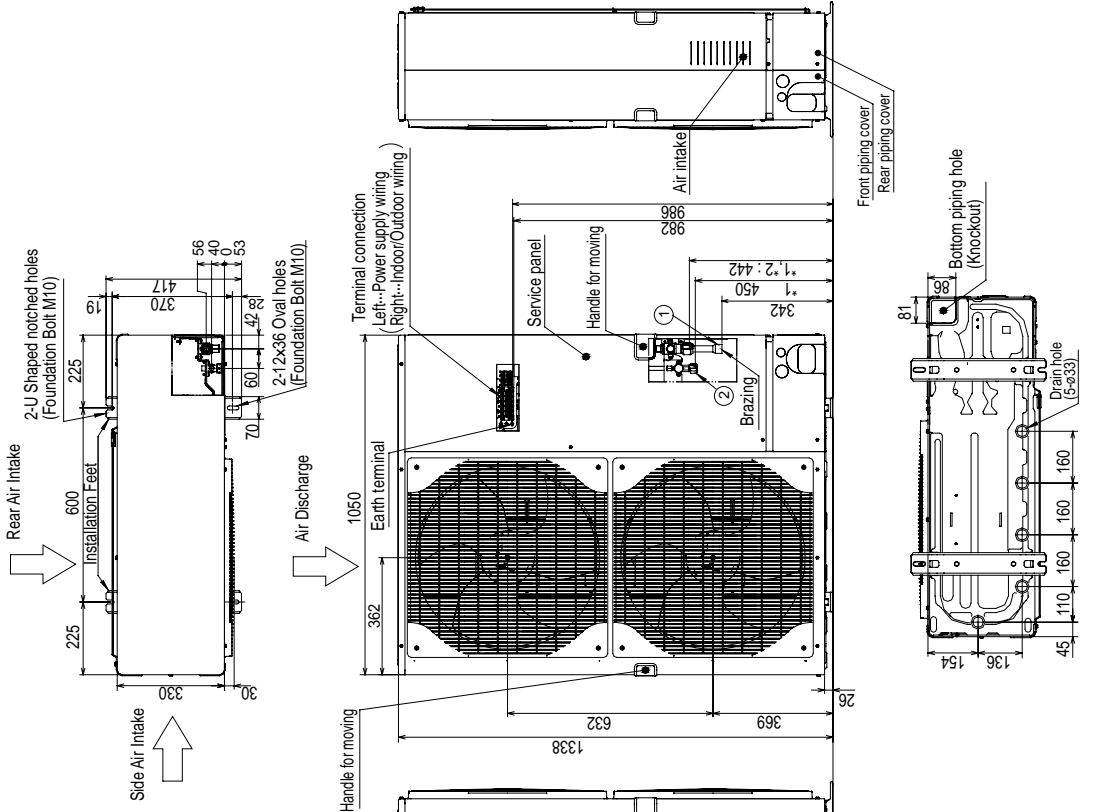

Example of Notes

- ① ...Refrigerant GAS pipe connection (attached JOINT)φ25.4(Brazing locally)
- ② ...Refrigerant LIQUID pipe connection (FLARE)φ9.52(3/8F)
- \*1--Indication of STOP VALVE connection location.
- \*2--FLAREφ19.05(3/4F)

Piping Knockout Hole Details

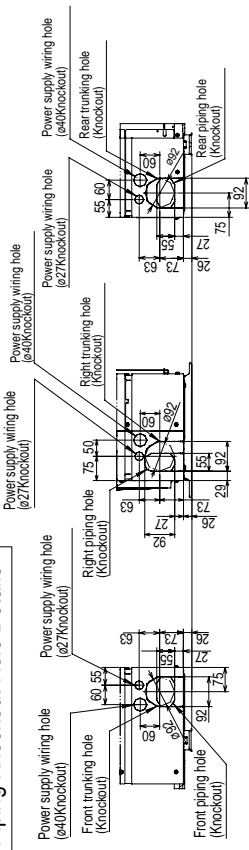

PUHZ-HRP200YKA

SYMBOL	NAME	SYMBOL	NAME	SYMBOL	NAME
TB1	Terminal Block<Power Supply>	P.B.	Power Circuit Board	SW9	Switch
TB2	Terminal Block<Indoor/Outdoor>	SC-U/V/W	Connection Terminal<U/V/W-Phase>	SWP	Switch<Pump Down>
MC	Motor for Compressor	TB-L1/L2/L3	Connection Terminal<L1/L2/L3-Power supply>	CN31	Connector<Emergency Operation>
MF1,MF2	Fan Motor	TB-P1	Connection Terminal	LED1,LED2	LED<Operation Inspection Indicators>
21S4	Solenoid Valve (Four-Way Valve)	TB-P2	Connection Terminal	F3,F4	Fuse<T6.3AL250V>
63H	High Pressure Switch	TB-C1	Connection Terminal	SV1	Connector<Connection for Option>
63L	Low Pressure Switch	TB-N1	Connection Terminal	SS	Connector<Connection for Option>
63HS	High Pressure Sensor	X52A	52C Relay	CNM	Connector<A-Control Service Inspection Kit>
TH3	Thermistor<Outdoor Pipe>	N.F.	Noise Filter Circuit Board	CNMNT	Connector<Connected to Optional M-NET Adapter Board>
TH4	Thermistor<Discharge>	LI1/LI2/LI3/NI	Connection Terminal<L1/L2/L3/NI-Power supply>	CNMNT	Connector<Connected to Optional M-NET Adapter Board>
TH6	Thermistor<Outdoor 2-Phase Pipe>	LO1/LO2/LO3	Connection Terminal<L1/L2/L3-Power supply>	CNDM	Connector<Connected for Option (Contact Input)>
TH7	Thermistor<Outdoor>	GD1,GD2	Connection Terminal<Ground>	CN3S	Connector<Connection for Option>
TH32	Thermistor<Suction>	C.B.	Controller Circuit Board	CN51	Connector<Connection for Option>
LEV-A,LEV-B,LEV-C	Electronic Expansion Valve	SW1	Switch<Forced Defrost, Defect History Record Reset, Refrigerant Address>	X51,X52,X54	Relay
ACL4	Reactor	SW4	Switch<Test Operation>		
DCL	Reactor	SW5	Switch<Function Switch>		
CB1,CB2	Main Smoothing Capacitor	SW6	Switch<Model Select>		
RS	Rush Current Protect Resistor	SW7	Switch<Function Setup>		
FUSE1, FUSE2	Fuse<T15AL250V>	SW8	Switch<Function Setup>		
CY1,CY2	Capacitor				

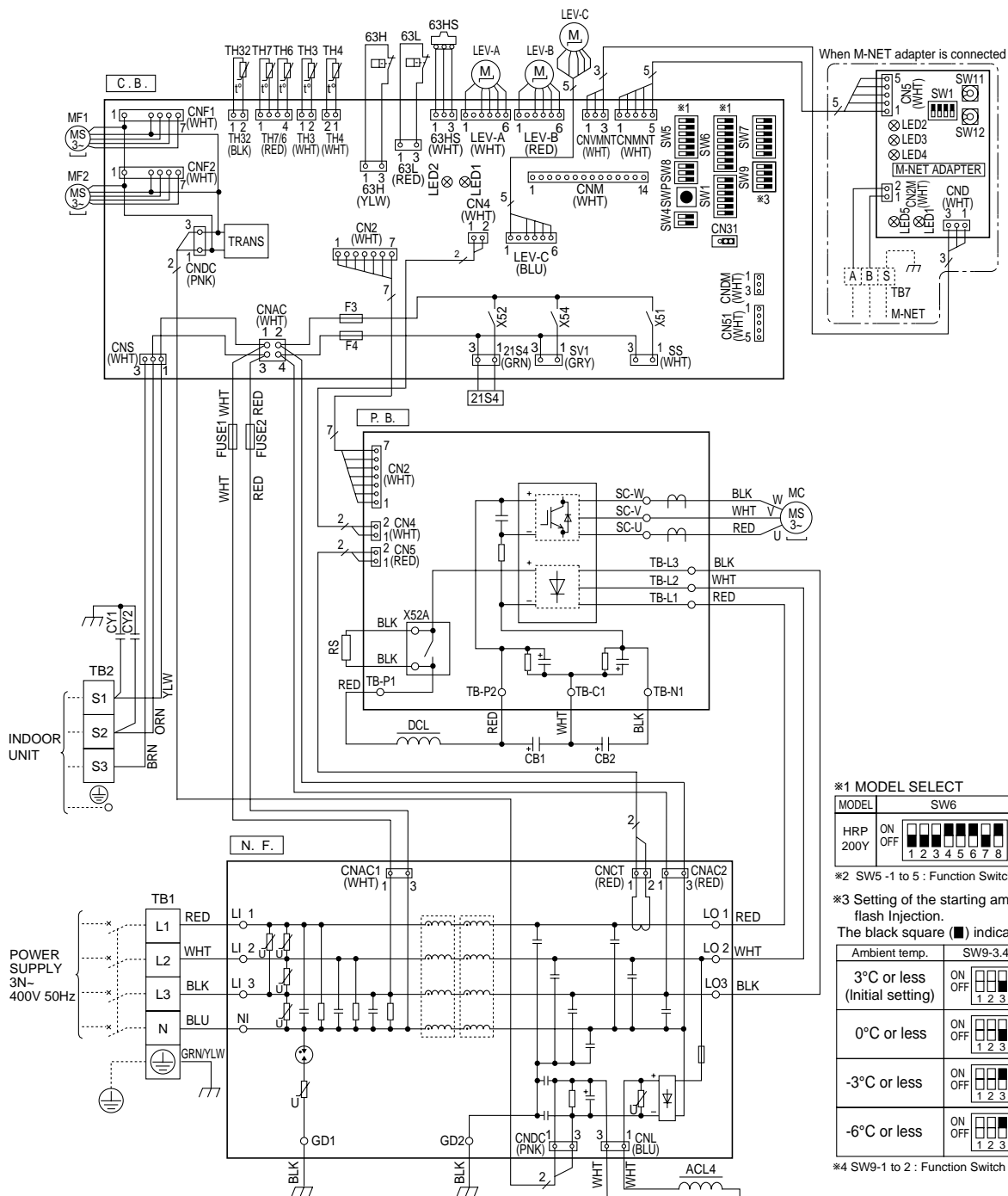

**\*1 MODEL SELECT**

MODEL	SW6	SW5-6 *2
HRP 200Y	ON OFF	ON OFF
	<input type="checkbox"/> 1 <input type="checkbox"/> 2 <input type="checkbox"/> 3 <input type="checkbox"/> 4 <input type="checkbox"/> 5 <input type="checkbox"/> 6 <input type="checkbox"/> 7 <input type="checkbox"/> 8	<input type="checkbox"/> 1 <input type="checkbox"/> 2 <input type="checkbox"/> 3 <input type="checkbox"/> 4 <input type="checkbox"/> 5 <input type="checkbox"/> 6

\*2 SW5 -1 to 5 : Function Switch.  
 \*3 Setting of the starting ambient temp. of the flash Injection.  
 The black square (■) indicates a switch position.

Ambient temp.	SW9-3,4 *4
3°C or less (Initial setting)	ON OFF
0°C or less	ON OFF
-3°C or less	ON OFF
-6°C or less	ON OFF

\*4 SW9-1 to 2 : Function Switch

# 6

# WIRING SPECIFICATIONS

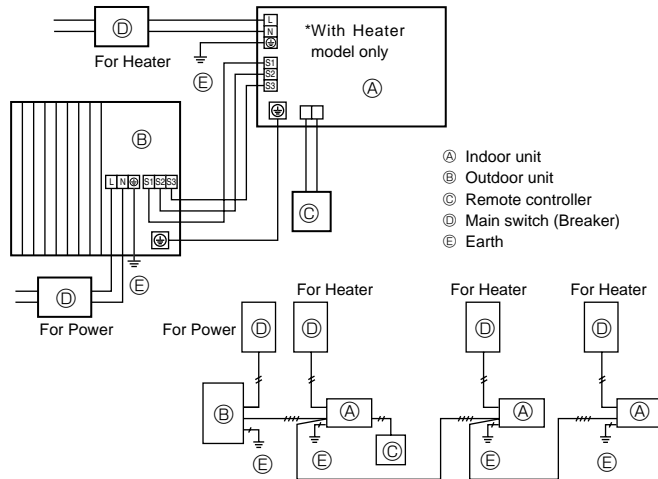

- Ⓐ Indoor unit
- Ⓑ Outdoor unit
- Ⓒ Remote controller
- Ⓓ Main switch (Breaker)
- Ⓔ Earth

**Note: Only for Air to water application**

**When multiple indoor units (Hydro boxes) are connected to the outdoor unit, wire the PCB of either one of the indoor unit and the outdoor unit (S1,S2,S3).**

**It is impossible to connect the PCBs of multiple indoor units to the outdoor unit.**

## FIELD ELECTRICAL WIRING (power wiring specifications)

Outdoor unit model		HRP200Y
Outdoor unit power supply		3N~ (3 ph 4-wires), 50 Hz, 400 V
Outdoor unit input capacity Main switch (Breaker)		*1 32 A
Wiring Wire No. x size (mm <sup>2</sup> )	Outdoor unit power supply	5 x Min. 4
	Indoor unit-Outdoor unit	*2 Cable length 50m:3x4 (Polar)/ Cable length 80m:3x6 (Polar)
	Indoor unit-Outdoor unit earth	*2 1 x Min. 2.5
Remote controller-Indoor unit		*3 2 x 0.3 (Non-polar)
Circuit rating	Outdoor unit L-N (single)	*4 AC 230 V
	Outdoor unit L1-N, L2-N, L3-N (3 phase)	AC 230 V
	Indoor unit-Outdoor unit S1-S2	*4 AC 230 V
	Indoor unit-Outdoor unit S2-S3	*4 DC 24 V
Remote controller-Indoor unit		*4 DC 12 V

\*1. A breaker with at least 3.0 mm contact separation in each poles shall be provided. Use earth leakage breaker (NV).

\*2. Max. 80 m Total Max. including all indoor/indoor connection is 80 m.

• Use one cable for S1 and S2 and another for S3 as shown in the picture.

\*3. The 10 m wire is attached in the remote controller accessory.

\*4. The figures are NOT always against the ground.

S3 terminal has DC 24 V against S2 terminal. However between S3 and S1, these terminals are NOT electrically insulated by the transformer or other device.



**Notes: 1. Wiring size must comply with the applicable local and national code.**

**2. Power supply cords and Indoor/Outdoor unit connecting cords shall not be lighter than polychloroprene sheathed flexible cord. (Design 60245 IEC 57)**

**3. Use an earth wire which is longer than the other cords so that it will not become disconnected when tension is applied.**



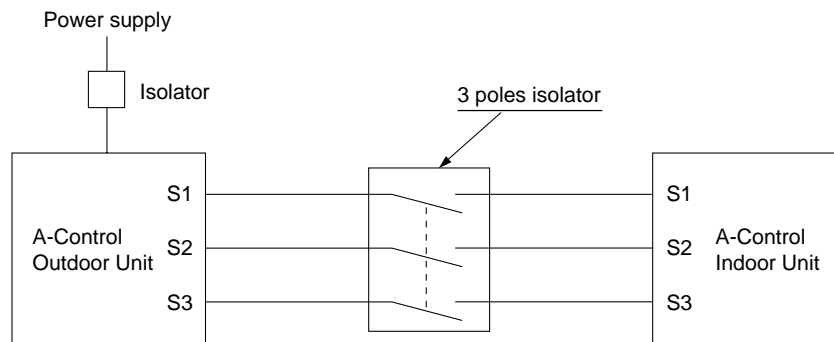

**⚠ Caution: Be sure to install N-line. Without N-line, it could cause damage to the unit.**



**⚠ Warning:**

- In case of A-control wiring, there is high voltage potential on the S3 terminal caused by electrical circuit design that has no electrical insulation between power line and communication signal line. Therefore, please turn off the main power supply when servicing. And do not touch the S1, S2, S3 terminals when the power is energized. If isolator should be used between indoor unit and outdoor unit, please use 3-pole type.
- Turn on the main power when the ambient temperature is - 20°C or higher.
- In below - 20°C condition, it needs at least 4hr stand by to operate in order to warm the electrical parts.

**INDOOR-OUTDOOR CONNECTING CABLE (HRP200)**

Cross section of cable	Wire size (mm <sup>2</sup> )	Number of wires	Polarity	L (m)*6
Round 	2.5	3	Clockwise : S1-S2-S3 *Pay attention to stripe of yellow and green	(30) *2
Flat 	2.5	3	Not applicable (Because center wire has no cover finish)	Not applicable *5
Flat 	1.5	4	From left to right : S1-Open-S2-S3	(18) *3
Round 	2.5	4	Clockwise : S1-S2-S3-Open *Connect S1 nad S3 to the opposite angle	(30) *4

\*1 :Power supply cords of appliances shall not be lighter than design 60245 IEC or 227 IEC.

\*2 :In case that cable with stripe of yellow and green is available.

\*3 :In case of regular polarity connection (S1-S2-S3), wire size is 1.5 mm<sup>2</sup>.

\*4 :In case of regular polarity connection (S1-S2-S3).

\*5 :In the flat cables are connected as this picture, they can be used up to 30 m.

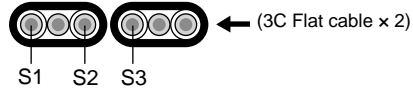

\*6 :Mentioned cable length is just a reference value.  
It may be different depending on the condition of installation, humidity or materials, etc.

Be sure to connect the indoor-outdoor connecting cables directly to the units (no intermediate connections). Intermediate connections can lead to communication error if water enters the cables and causes insufficient insulation to ground or a poor electrical contact at the intermediate connection point.

## PUHZ-HRP200YKA

&lt;Reference&gt; System example: Plate HEX (ACH50 \* 2pcs) + FTC (TH1/2)

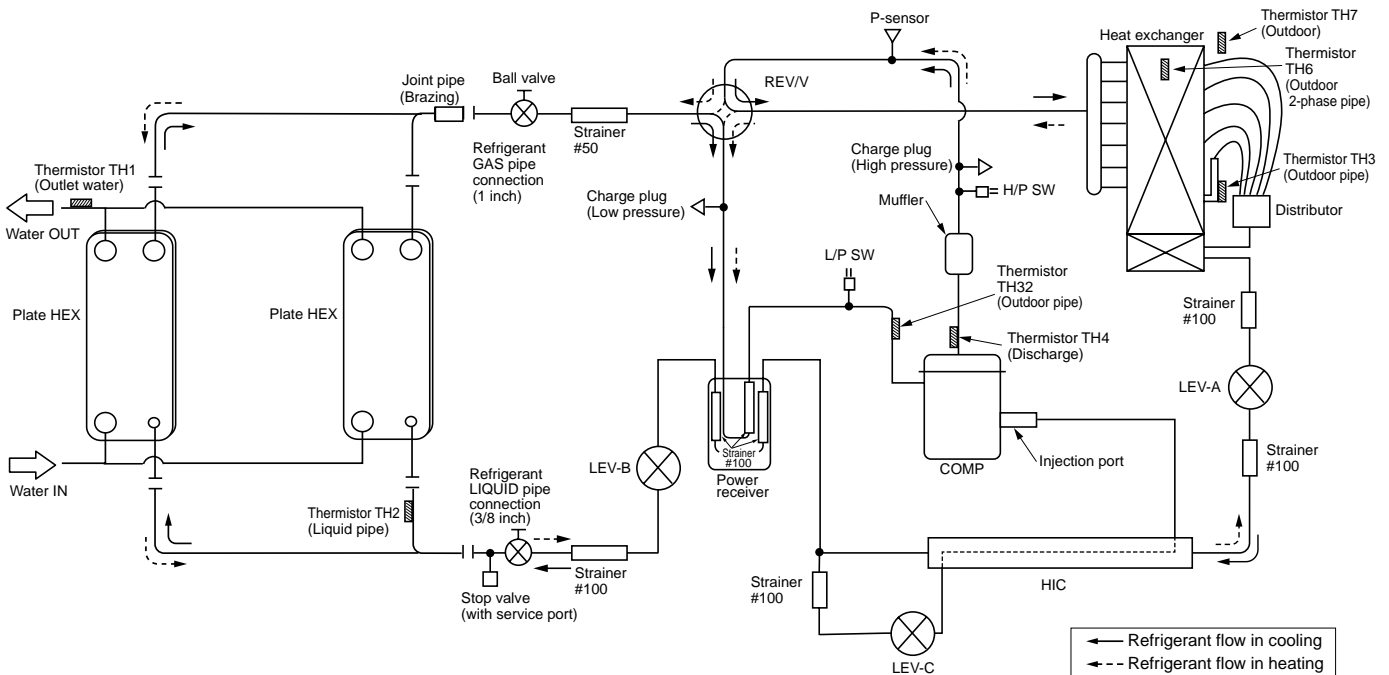

Symbol	Part name	Detail	
COMP	Compressor	DC inverter scroll compressor (Mitsubishi Electric Corporation)	
H/P SW	High pressure switch (63H)	For protection (OFF: 4.15MPa)	
L/P SW	Low pressure switch (63L)	For protection (OFF: -0.03MPa)	
REV/V	Reversing (4-way) valve (21S4)	Change the refrigerant circuit (Heating / Cooling) and for Defrosting	
Charge plug	Charge plug	High pressure / Low pressure / For production test use	
P-Sensor	Pressure sensor (63HS)	For calculation of the condensing temperature from high pressure	
LEV-A	Linear expansion valve -A	Heating:Secondary LEV Cooling:Primary LEV	
LEV-B	Linear expansion valve -B	Heating:Primary LEV Cooling:Secondary LEV	
LEV-C	Linear expansion valve -C	For HIC (heating only)	
TH32	Suction temperature thermistor	For LEV control	
TH3	Liquid temperature thermistor	Heating:Evaporating temperature Cooling:Sub cool liquid temperature	
TH4	Discharge temperature thermistor	For LEV control and for compressor protection	
TH6	2-phase pipe temperature thermistor	Outdoor 2-phase pipe temperature	
TH7	Ambient temperature thermistor	For fan control and for compressor frequency control	
Power Receiver	Power Receiver	For accumulation of refrigerant	
HIC	Heat interchange circuit	For high heating capacity	
Plate HEX	Plate Heat Exchanger	ACH50 - 50 Plates (Alfa Laval)	
TH1	Outlet water temperature thermistor	For flow temp. controller	<Reference> System example
TH2	Liquid pipe temperature thermistor	For flow temp. controller	

### 8-1. TROUBLESHOOTING

#### <Error code display by self-diagnosis and actions to be taken for service (summary)>

Present and past error codes are logged and displayed on the control board of outdoor unit. Actions to be taken for service, which depends on whether or not the trouble is reoccurring at service, are summarized in the table below. Check the contents below before investigating details.

Unit conditions at service	Error code	Actions to be taken for service (summary)
The trouble is reoccurring.	Displayed	Judge what is wrong and take a corrective action according to "8-3. Self-diagnosis action table".
	Not displayed	Conduct troubleshooting and ascertain the cause of the trouble.
The trouble is not reoccurring.	Logged	<ul style="list-style-type: none"> <li>① Consider the temporary defects such as the work of protection devices in the refrigerant circuit including compressor, poor connection of wiring, noise and etc. Re-check the symptom, and check the installation environment, refrigerant amount, weather when the trouble occurred, matters related to wiring and etc.</li> <li>② Reset error code logs and restart the unit after finishing service.</li> <li>③ There is no abnormality in electrical component, controller board, and etc.</li> </ul>
	Not logged	<ul style="list-style-type: none"> <li>① Re-check the abnormal symptom.</li> <li>② Conduct troubleshooting and ascertain the cause of the trouble.</li> <li>③ Continue to operate unit for the time being if the cause is not ascertained.</li> <li>④ There is no abnormality concerning of parts such as electrical component, controller board, and etc.</li> </ul>

## 8-2. CHECK POINT UNDER TEST RUN

### Before test run

- After installation of outdoor unit, piping work and electric wiring work, re-check that there is no water leakage, loosened connections and incorrect polarity.
- Measure impedance between the ground and the power supply terminal block (L, N) on the outdoor unit by 500 V Megger and check that it is 1.0 MΩ or over.
- Turn on power supply 12 hours before test run in order to protect compressor.
- Make sure to read operation manual before test run. (Especially items to secure safety.)

### Warning:

**Do not use the system if the insulation resistance is less than 1.0 MΩ.**

### Caution:

**Do not carry out this test on the control wiring (low voltage circuit) terminals.**

### Self-check

- ① Turn on the power.
- ② Press [CHECK] button twice.
- ③ Press [CHECK] button twice to finish self-check.

Ⓐ CHECK button   Ⓑ IC : Interface or FTC unit   Ⓒ OC : Outdoor unit   Ⓓ Check code

Check code	Symptom
P1	Flow water (TH1) sensor error
P2	Refrigerant liquid Pipe (TH2) sensor error
P6	Freezing/Overheating protection operation
P9	Actual tank temp. (TH5) sensor error
Fb	FTC unit control system error (memory error, etc.)
E0~E5	Signal transmission failure between remote controller and FTC.
E6~EF	Signal transmission failure between outdoor unit and FTC.
----	No trouble generated in the past.
FFFF	No corresponding unit
U*, F*	Outdoor unit failure. Refer to the outdoor unit wiring diagram.

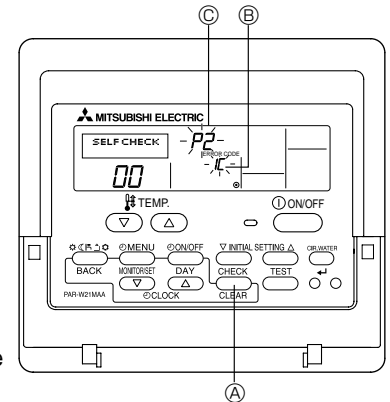

For description of each LED (LED1~5) provided on the FTC, refer to the following table.

LED 1 (Power for microprocessor)	Indicates whether control power is supplied. Make sure that this LED is always lit.
LED 2 (Power for remote controller)	Indicates whether power is supplied to the remote controller. This LED lights only in the case of the FTC unit which is connected to the outdoor unit refrigerant address "0".
LED 3 (Communication between FTC and outdoor unit)	Indicates state of communication between the FTC and outdoor unit. Make sure that this LED is always blinking.
LED 4	—
LED 5	—

### 8-3. SELF-DIAGNOSIS ACTION TABLE

<Abnormalities detected when the power is turned on>

Error Code	Abnormal point and detection method	Case	Judgment and action
None	—	<p>① No voltage is supplied to terminal block (TB1) of outdoor unit. a) Power supply breaker is turned off. b) Contact failure or disconnection of power supply terminal c) Open phase (L or N phase)</p> <p>② Electric power is not charged to power supply terminal of outdoor power circuit board. a) Contact failure of power supply terminal b) Open phase on the outdoor power circuit board</p> <p>③ Electric power is not supplied to outdoor controller circuit board. a) Disconnection of connector (CNDC)</p> <p>④ Disconnection of reactor (DCL or ACL)</p> <p>⑤ Disconnection of outdoor noise filter circuit board or parts failure in outdoor noise filter circuit board</p> <p>⑥ Defective outdoor power circuit board</p> <p>⑦ Defective outdoor controller circuit board</p>	<p>① Check following items. a) Power supply breaker b) Connection of power supply terminal block (TB1) c) Connection of power supply terminal block (TB1)</p> <p>② Check following items. a) Connection of power supply terminal block (TB1) b) Connection of terminal on outdoor power circuit board</p> <p>③ Check connection of the connector (CNDC) on the outdoor controller circuit board. Check connection of the connector CNDC on the outdoor noise filter. Refer to 8-7.</p> <p>④ Check connection of reactor. (DCL or ACL)</p> <p>⑤ a) Check connection of outdoor noise filter circuit board. b) Replace outdoor noise filter circuit board. Refer to 8-7.</p> <p>⑥ Replace outdoor power circuit board.</p> <p>⑦ Replace controller board (When items above are checked but the units can not be repaired).</p>
F3	<p><b>63L connector open</b> Abnormal if 63L connector circuit is open for 3 minutes continuously after power supply. 63L: Low-pressure switch</p>	<p>① Disconnection or contact failure of 63L connector on outdoor controller circuit board</p> <p>② Disconnection or contact failure of 63L</p> <p>③ 63L is working due to refrigerant leakage or defective parts.</p> <p>④ Defective outdoor controller circuit board</p>	<p>① Check connection of 63L connector on outdoor controller circuit board. Refer to 8-7.</p> <p>② Check the 63L side of connecting wire.</p> <p>③ Check refrigerant pressure. Charge additional refrigerant. Check continuity by tester. Replace the parts if the parts are defective.</p> <p>④ Replace outdoor controller circuit board.</p>
F5	<p><b>63H connector open</b> Abnormal if 63H connector circuit is open for 3 minutes continuously after power supply. 63H: High-pressure switch</p>	<p>① Disconnection or contact failure of 63H connector on outdoor controller circuit board</p> <p>② Disconnection or contact failure of 63H</p> <p>③ 63H is working due to defective parts.</p> <p>④ Defective outdoor controller circuit board</p>	<p>① Check connection of 63H connector on outdoor controller circuit board. Refer to 8-7.</p> <p>② Check the 63H side of connecting wire.</p> <p>③ Check continuity by tester. Replace the parts if the parts are defective.</p> <p>④ Replace outdoor controller circuit board.</p>
F9	<p><b>2 connector open</b> Abnormal if both 63H and 63L connector circuits are open for three minutes continuously after power supply. 63H: High-pressure switch 63L: Low-pressure switch</p>	<p>① Disconnection or contact failure of connector (63H,63L) on outdoor controller circuit board.</p> <p>② Disconnection or contact failure of 63H, 63L</p> <p>③ 63H and 63L are working due to defective parts.</p> <p>④ Defective outdoor controller board.</p>	<p>① Check connection of connector (63H,63L) on outdoor controller circuit board. Refer to 8-7.</p> <p>② Check the 63H and 63L side of connecting wire.</p> <p>③ Check continuity by tester. Replace the parts if the parts are defective.</p> <p>④ Replace outdoor controller circuit board.</p>





Error Code	Abnormal point and detection method	Case	Judgment and action
EA	<p><b>Miswiring of Interface unit/Flow temp. controller-outdoor unit connecting wire</b></p> <p>1. Outdoor controller circuit board can automatically check the number of connected Interface unit/Flow temp. controller. Abnormal if the number cannot be checked automatically due to miswiring of Interface unit/Flow temp. controller-outdoor unit connecting wire and etc. after power is turned on for 4 minutes.</p> <p>2. Abnormal if outdoor controller circuit board recognizes excessive number of Interface unit/Flow temp. controller.</p>	<p>① Contact failure or miswiring of Interface unit/Flow temp. controller-outdoor unit connecting wire</p> <p>② Diameter or length of Interface unit/Flow temp. controller-outdoor unit connecting wire is out of specified capacity.</p> <p>③ Excessive number of Interface unit/Flow temp. controller is connected to 1 outdoor unit. (2 units or more)</p> <p>④ Defective transmitting receiving circuit of outdoor controller circuit board</p> <p>⑤ Defective transmitting receiving circuit of Interface/Flow temp. controller board</p> <p>⑥ Noise has entered into power supply or Interface/Flow temp. controller-outdoor unit connecting wire.</p>	<p>① Check disconnection or looseness or polarity of Interface unit/Flow temp. controller-outdoor unit connecting wire of Interface unit/Flow temp. controller and outdoor units.</p> <p>② Check diameter and length of Interface unit/Flow temp. controller-outdoor unit connecting wire. Total wiring length: 80 m (Including wiring connecting each Interface unit/Flow temp. controller unit and between Interface unit/Flow temp. controller and outdoor unit) Also check if the connection order of flat cable is S1, S2, S3.</p> <p>③ Check the number of Interface unit/Flow temp. controller that is connected to 1 outdoor unit. (If EA is detected.)</p> <p>④~⑤ Turn the power off once, and on again to check. Replace outdoor controller circuit board or Interface/Flow temp. controller board if abnormality occurs again.</p>
Eb	<p><b>Miswiring of Interface unit/Flow temp. controller-outdoor unit connecting wire (converse wiring or disconnection)</b></p> <p>Outdoor controller circuit board can automatically set the unit number of Interface unit/Flow temp. controller.</p> <p>Abnormal if the Interface unit/Flow temp. controller number cannot be set within 4 minutes after power on because of miswiring (converse wiring or disconnection) of Interface unit/Flow temp. controller-outdoor unit connecting wire.</p>	<p>① Contact failure or miswiring of Interface unit/Flow temp. controller-outdoor unit connecting wire</p> <p>② Diameter or length of Interface unit/Flow temp. controller-outdoor unit connecting wire is out of specified capacity.</p> <p>④ Defective transmitting receiving circuit of outdoor controller circuit board</p> <p>⑤ Defective transmitting receiving circuit of Interface/Flow temp. controller board</p> <p>⑥ Noise has entered into power supply or Interface unit/Flow temp. controller-outdoor unit connecting wire.</p>	<p>⑥ Check transmission path, and remove the cause.</p> <p>&lt;Note&gt; The descriptions above, ①-⑥, are for EA, Eb and EC.</p>
EC	<p><b>Start-up time over</b></p> <p>The unit cannot finish start-up process within 4 minutes after power on.</p>	<p>① Contact failure of Interface unit/Flow temp. controller-outdoor unit connecting wire</p> <p>② Diameter or length of Interface unit/Flow temp. controller-outdoor unit connecting wire is out of specified capacity.</p> <p>⑥ Noise has entered into power supply or Interface unit/Flow temp. controller-outdoor unit connecting wire.</p>	

<Abnormalities detected while unit is operating>

Error Code	Abnormal point and detection method	Case	Judgment and action
U1	<p><b>High pressure (High-pressure switch 63H operated)</b> Abnormal if high-pressure switch 63H operated ( * ) during compressor operation. * 4.15 MPa</p> <p>63H: High-pressure switch</p>	<p>① Short cycle of indoor unit ② Clogged filter of indoor unit ③ Decreased airflow caused by dirt of indoor fan ④ Dirt of indoor heat exchanger ⑤ Locked indoor fan motor ⑥ Malfunction of indoor fan motor ⑦ Defective operation of stop valve (Not full open) ⑧ Clogged or broken pipe ⑨ Locked outdoor fan motor ⑩ Malfunction of outdoor fan motor ⑪ Short cycle of outdoor unit ⑫ Dirt of outdoor heat exchanger ⑬ Decreased airflow caused by defective inspection of outside temperature thermistor (It detects lower temperature than actual temperature.) ⑭ Disconnection or contact failure of connector (63H) on outdoor controller board ⑮ Disconnection or contact failure of 63H connection ⑯ Defective outdoor controller board ⑰ Defective action of linear expansion valve ⑱ Malfunction of fan driving circuit</p>	<p>①~⑥ Check indoor unit and repair defectives.  ⑦ Check if stop valve is fully open.  ⑧ Check piping and repair defect. ⑨~⑫ Check outdoor unit and repair defect.  ⑬ Check the detected temperature of outside temperature thermistor on LED display. (SW2 on A-Control Service Tool : Refer to 8-8.)  ⑭~⑯ Turn the power off and check F5 is displayed when the power is turned again. When F5 is displayed, refer to "Judgment and action" for F5.  ⑰ Check linear expansion valve. Refer to 8-6. ⑱ Replace outdoor controller board.</p>
U2	<p><b>High discharging temperature</b> (1) Abnormal if discharge temperature thermistor (TH4) exceeds 125°C or 110°C continuously for 5 minutes. Abnormal if discharge temperature thermistor (TH4) exceeds 110°C or more continuously for 30 seconds after 90 seconds have passed since the defrosting operation started.  (2) Abnormal if discharge superheat (Cooling: TH4 – T<sub>63HS</sub> / Heating: TH4 – T<sub>63HS</sub>) exceeds 70°C continuously for 10 minutes.</p>	<p>① Overheated compressor operation caused by shortage of refrigerant ② Defective operation of stop valve ③ Defective thermistor ④ Defective outdoor controller board ⑤ Defective action of linear expansion valve ⑥ Clogging with foreign objects in refrigerant circuit * Clogging occur in the parts which become below freezing point when water enters in refrigerant circuit.</p>	<p>① Check intake superheat. Check leakage of refrigerant. Charge additional refrigerant. ② Check if stop valve is fully open. ③④ Turn the power off and check if U3 is displayed when the power is turned on again. When U3 is displayed, refer to "Judgement and action" for U3. ⑤ Check linear expansion valve. Refer to 8-6. ⑥ After recovering refrigerant, remove water from entire refrigerant circuit under vacuum more than 1 hour.</p>
U3	<p><b>Open/short circuit of discharge temperature thermistor (TH4)</b> Abnormal if open (3°C or less) or short (217°C or more) is detected during compressor operation. (Detection is inoperative for 10 minutes of compressor starting process and for 10 minutes after and during defrosting.)</p>	<p>① Disconnection or contact failure of connector (TH4) on the outdoor controller circuit board ② Defective thermistor  ③ Defective outdoor controller circuit board</p>	<p>① Check connection of connector (TH4) on the outdoor controller circuit board. Check breaking of the lead wire for thermistor (TH4). Refer to 8-7. ② Check resistance value of thermistor (TH4) or temperature by microprocessor. (Thermistor/TH4: Refer to 8-4.) (SW2 on A-Control Service Tool: Refer to 8-8.) ③ Replace outdoor controller board.</p>



Error Code	Abnormal point and detection method	Case	Judgment and action																					
U4	<p><b>Open/short of outdoor unit thermistors (TH3, TH32, TH6, TH7, and TH8)</b>            Abnormal if open or short is detected during compressor operation.            Open detection of thermistors TH3, TH32 and TH6 is inoperative for 10 seconds to 10 minutes after compressor starting and 10 minutes after and during defrosting.            * Check which unit has abnormality in its thermistor by switching the mode of SW2. (PAC-SK52ST)            (Refer to 8-7.)            * Heatsink thermistor (TH8) is in the power module.</p>	<p>① Disconnection or contact failure of connectors            Outdoor controller circuit board: (TH3, TH32, TH7/6)            Outdoor power circuit board: (CN3)            ② Defective thermistor            ③ Defective outdoor controller circuit board</p>	<p>① Check connection of connector (TH3, TH32, TH7/6) on the outdoor controller circuit board. Check connection of connector (CN3) on the outdoor power circuit board. Check breaking of the lead wire for thermistor (TH3, TH32, TH6, TH7, TH8). Refer to 8-7.            ② Check resistance value of thermistor (TH3, TH32, TH6, TH7, TH8) or check temperature by microprocessor.            (Thermistor/TH3, TH6, TH7, TH32, TH8: Refer to 8-5.)            (SW2 on A-Control Service Tool: Refer to 8-8.)            ③ Replace outdoor controller circuit board.</p>																					
	<table border="1" style="width: 100%; border-collapse: collapse;"> <thead> <tr> <th colspan="2">Thermistors</th> <th rowspan="2">Open detection</th> <th rowspan="2">Short detection</th> </tr> <tr> <th>Symbol</th> <th>Name</th> </tr> </thead> <tbody> <tr> <td>TH3, TH32</td> <td>Thermistor &lt;Outdoor pipe&gt;</td> <td>-40°C or below</td> <td>90°C or above</td> </tr> <tr> <td>TH6</td> <td>Thermistor &lt;Outdoor 2-phase pipe&gt;</td> <td>-40°C or below</td> <td>90°C or above</td> </tr> <tr> <td>TH7</td> <td>Thermistor &lt;Outdoor&gt;</td> <td>-40°C or below</td> <td>90°C or above</td> </tr> <tr> <td>TH8</td> <td>Internal thermistor</td> <td>-35°C or below</td> <td>170°C or above</td> </tr> </tbody> </table>		Thermistors		Open detection	Short detection	Symbol	Name	TH3, TH32	Thermistor <Outdoor pipe>	-40°C or below	90°C or above	TH6	Thermistor <Outdoor 2-phase pipe>	-40°C or below	90°C or above	TH7	Thermistor <Outdoor>	-40°C or below	90°C or above	TH8	Internal thermistor	-35°C or below	170°C or above
Thermistors		Open detection	Short detection																					
Symbol	Name																							
TH3, TH32	Thermistor <Outdoor pipe>	-40°C or below	90°C or above																					
TH6	Thermistor <Outdoor 2-phase pipe>	-40°C or below	90°C or above																					
TH7	Thermistor <Outdoor>	-40°C or below	90°C or above																					
TH8	Internal thermistor	-35°C or below	170°C or above																					
U5	<p><b>Temperature of heatsink</b>            Abnormal if heatsink thermistor (TH8) detects 95°C</p>	<p>① The outdoor fan motor is locked.            ② Failure of outdoor fan motor            ③ Air flow path is clogged.            ④ Rise of ambient temperature            ⑤ Defective thermistor            ⑥ Defective input circuit of outdoor power circuit board            ⑦ Failure of outdoor fan drive circuit</p>	<p>①② Check outdoor fan.            ③ Check air flow path for cooling.            ④ Check if there is something which causes temperature rise around outdoor unit. (Upper limit of ambient temperature is 46°C.) Turn off power, and on again to check if U5 is displayed within 30 minutes. If U4 is displayed instead of U5, follow the action to be taken for U4.            ⑤ Check the thermistor (TH8) temperature by microprocessor. (SW2 on A-Control Service Tool: Refer to 8-7.)            ⑥ Replace outdoor power circuit board.            ⑦ Replace outdoor controller circuit board.</p>																					
U6	<p><b>Power module</b>            Check abnormality by driving power module in case overcurrent is detected. (UF or UP error condition)</p>	<p>① Outdoor stop valve is closed.            ② Decrease of power supply voltage            ③ Looseness, disconnection or converse of compressor wiring connection            ④ Defective compressor            ⑤ Defective outdoor power circuit board</p>	<p>① Open stop valve.            ② Check facility of power supply.            ③ Correct the wiring (U·V·W phase) to compressor. Refer to 8-7 (Outdoor power circuit board).            ④ Check compressor referring to 8-5.            ⑤ Replace outdoor power circuit board.</p>																					
U7	<p><b>Too low superheat due to low discharge temperature</b>            Abnormal if discharge superheat is continuously detected less than or equal to -15°C for 3 minutes even though linear expansion valve has minimum open pulse after compressor starts operating for 10 minutes.</p>	<p>① Disconnection or loose connection of discharge temperature thermistor (TH4)            ② Defective holder of discharge temperature thermistor            ③ Disconnection or loose connection of linear expansion valve's coil            ④ Disconnection or loose connection of linear expansion valve's connector            ⑤ Defective linear expansion valve</p>	<p>①② Check the installation conditions of discharge temperature thermistor (TH4).            ③ Check the coil of linear expansion valve. Refer to 8-6.            ④ Check the connection or contact of LEV-A and LEV-B on outdoor controller circuit board.            ⑤ Check linear expansion valve. Refer to 8-6.</p>																					



Error Code	Abnormal point and detection method	Case	Judgment and action
U8	<b>Outdoor fan motor</b> Abnormal if rotational frequency of the fan motor is not detected during DC fan motor operation. Fan motor rotational frequency is abnormal if; <ul style="list-style-type: none"> <li>• 100 rpm or below detected continuously for 15 seconds at 20°C or more outside air temperature.</li> <li>• 50 rpm or below or 1500 rpm or more detected continuously for 1 minute.</li> </ul>	① Failure in the operation of the DC fan motor ② Failure in the outdoor circuit controller board	① Check or replace the DC fan motor. ② Check the voltage of the outdoor circuit controller board during operation. ③ Replace the outdoor circuit controller board. (When the failure is still indicated even after performing the action ① above.)
U9	<b>Overvoltage or voltage shortage and synchronous signal to main circuit</b> Abnormal if any of followings are detected during compressor operation; <ul style="list-style-type: none"> <li>• Instantaneous decrease of DC bus voltage 400V</li> <li>• Increase of DC bus voltage to 760V</li> <li>• Decrease of input current of outdoor unit to 0.1A only if operation frequency is more than or equal to 40Hz or compressor current is more than or equal to 6A.</li> </ul> * Check U9 error detail (SW2 all ON). Refer to 8-8.	① Decrease of power supply voltage ② Disconnection of compressor wiring ③ Disconnection or loose connection of CN5 on the outdoor power circuit board ④ Disconnection or loose connection of CN2 on the outdoor power circuit board	① Check the facility of power supply. ② Correct the wiring (U-V-W phase) to compressor. Refer to 8-7 (Outdoor power circuit board). ③ Check CN5 wiring on the outdoor power circuit board. Refer to 8-7. ④ Check CN2 wiring on the outdoor power circuit board. Refer to 8-7.
Ud	<b>Overheat protection</b> Abnormal if outdoor pipe thermistor (TH3), condensing temperature $T_{63HS}$ detects 70°C or more during compressor operation.	① Defective outdoor fan (fan motor) or short cycle of outdoor unit during cooling operation ② Defective outdoor pipe thermistor (TH3), condensing temperature $T_{63HS}$ ③ Defective outdoor controller board	① Check outdoor unit air passage. ②③ Turn the power off and on again to check the error code. If U4 is displayed, follow the U4 processing direction.
UE	<b>Abnormal pressure of pressure sensor (63HS)</b> Abnormal if pressure sensor (63HS) detects 0.1 MPa or less. Detection is inoperative for 3 minutes after compressor starting and 3 minutes after and during defrosting.	① Disconnection or contact failure of connector (63HS) on the outdoor controller circuit board ② Defective pressure sensor ③ Defective outdoor controller circuit board	① Check connection of connector (63HS) on the outdoor controller circuit board. Check breaking of the lead wire for thermistor (63HS). ② Check pressure by microprocessor. (Pressure sensor/ 63HS) (SW2: Refer to 8-8.) ③ Replace outdoor controller board.
UF	<b>Compressor overcurrent interruption (When compressor locked)</b> Abnormal if overcurrent of DC bus or compressor is detected within 30 seconds after compressor starts operating.	① Stop valve is closed. ② Decrease of power supply voltage ③ Looseness, disconnection or converse of compressor wiring connection ④ Defective compressor ⑤ Defective outdoor power board	① Open stop valve. ② Check facility of power supply. ③ Correct the wiring (U-V-W phase) to compressor. Refer to 8-7 (Outdoor power circuit board). ④ Check compressor. Refer to 8-5. ⑤ Replace outdoor power circuit board.



Error Code	Abnormal point and detection method	Case	Judgment and action
UH	<b>Current sensor error or input current error</b> • Abnormal if current sensor detects -1.0A to 1.0A during compressor operation. (This error is ignored in case of test run mode.)	① Disconnection of compressor wiring ② Defective circuit of current sensor on outdoor power circuit board ③ Decrease of power supply voltage	① Correct the wiring (U·V·W phase) to compressor. Refer to 8-7 (Outdoor power circuit board). ② Replace outdoor power circuit board. ③ Check the facility of power supply.
UL	<b>Low pressure (63L operated)</b> Abnormal if 63L is operated (under -0.03MPa) during compressor operation. 63L: Low-pressure switch	① Stop valve of outdoor unit is closed during operation. ② Disconnection or loose connection of connector (63L) on outdoor controller board ③ Disconnection or loose connection of 63L ④ Defective outdoor controller board ⑤ Leakage or shortage of refrigerant ⑥ Malfunction of linear expansion valve	① Check stop valve. ②~④ Turn the power off and on again to check if F3 is displayed on restarting. If F3 is displayed, follow the F3 processing direction. ⑤ Correct to proper amount of refrigerant. ⑥ Check linear expansion valve. Refer to 8-6.
UP	<b>Compressor overcurrent interruption</b> Abnormal if overcurrent DC bus or compressor is detected after compressor starts operating for 30 seconds.	① Stop valve of outdoor unit is closed. ② Decrease of power supply voltage ③ Looseness, disconnection or converse of compressor wiring connection ④ Defective fan of indoor/outdoor units ⑤ Short cycle of indoor/outdoor units ⑥ Defective input circuit of outdoor controller board ⑦ Defective compressor ⑧ Defective outdoor power circuit board ⑨ Dip switch setting difference of outdoor controller circuit board	① Open stop valve. ② Check facility of power supply. ③ Correct the wiring (U·V·W phase) to compressor. Refer to 8-7 (Outdoor power circuit board). ④ Check indoor/outdoor fan. ⑤ Solve short cycle. ⑥ Replace outdoor controller circuit board. * Before the replacement of the outdoor controller circuit board, disconnect the wiring to compressor from the outdoor power circuit board and check the output voltage among phases, U, V, W, during test run. No defect on board if voltage among phases (U-V, V-W and W-U) is same. Make sure to perform the voltage check with same performing frequency. ⑦ Check compressor. Refer to 8-5. ⑧ Replace outdoor power circuit board. ⑨ Check the dip switch setting of outdoor controller circuit board.



Error Code	Abnormal point and detection method	Cause	Judgment and action
E0 or E4	<p><b>Remote controller transmission error (E0)/signal receiving error (E4)</b></p> <p>① Abnormal if main or sub remote controller cannot receive any transmission normally from Interface unit/Flow temp. controller of refrigerant address "0" for 3 minutes. (Error code: E0)</p> <p>② Abnormal if sub-remote controller could not receive any signal for 2 minutes. (Error code: E0)</p> <p>① Abnormal if Interface unit/Flow temp. controller can not receive any data normally from remote controller board or from other Interface/Flow temp. controller board for 3 minutes. (Error code: E4)</p> <p>② Interface unit/Flow temp. controller cannot receive any signal from remote controller for 2 minutes. (Error code: E4)</p>	<p>① Contact failure at transmission wire of remote controller</p> <p>② All remote controllers are set as "sub" remote controller. In this case, E0 is displayed on remote controller, and E4 is displayed at LED (LED1, LED2) on the outdoor controller circuit board.</p> <p>③ Miswiring of remote controller</p> <p>④ Defective transmitting receiving circuit of remote controller</p> <p>⑤ Noise has entered into the transmission wire of remote controller.</p>	<p>① Check disconnection or looseness of Interface unit/Flow temp. controller or transmission wire of remote controller.</p> <p>② Set one of the remote controllers "main", If there is no problem with the action above.</p> <p>③ Check wiring of remote controller.</p> <ul style="list-style-type: none"> <li>• Total wiring length: max. 500 m (Do not use cable x 3 or more.)</li> <li>• The number of connecting remote controller: max. 2 units</li> </ul> <p>When it is not the above-mentioned problem of ①-③</p> <p>④ Diagnose remote controllers.</p> <p>a) When "RC OK" is displayed, remote controllers have no problem. Turn the power off, and on again to check. If abnormality generates again, replace PCB of Interface unit/Flow temp. controller.</p> <p>b) When "RC NG" is displayed, replace remote controller.</p> <p>c) When "RC E3" or "ERC 00-66" is displayed, noise may be causing abnormality.</p>
E1 or E2	<p><b>Remote controller control board</b></p> <p>① Abnormal if data cannot be read normally from the nonvolatile memory of the remote controller control board. (Error code: E1)</p> <p>② Abnormal if the clock function of remote controller cannot be operated normally. (Error code: E2)</p>	<p>① Defective remote controller</p>	<p>① Replace remote controller.</p>
E3 or E5	<p><b>Remote controller transmission error (E3)/signal receiving error (E5)</b></p> <p>① Abnormal if remote controller could not find blank of transmission path for 6 seconds and could not transmit. (Error code: E3)</p> <p>② When remote controller receives the transmitted data same time and compares these data. Abnormal if the data is judged to be different for 30 continuous times. (Error code: E3)</p> <p>① Abnormal if Interface unit/Flow temp. controller could not find blank of transmission path. (Error code: E5)</p> <p>② When Interface unit/Flow temp. controller receives the transmitted data same time and compares these data. Abnormal if the data is judged to be different for 30 continuous times. (Error code: E5)</p>	<p>① 2 remote controllers are set as "main." (In case of 2 remote controllers)</p> <p>② Defective transmitting receiving circuit of remote controller</p> <p>③ Defective transmitting receiving circuit of Interface unit/Flow temp. controller</p> <p>④ Noise has entered into transmission wire of remote controller.</p>	<p>① Set a remote controller to main, and the other to sub.</p> <p>②-④ Diagnose remote controller.</p> <p>a) When "RC OK" is displayed, remote controllers have no problem. Turn the power off, and on again to check. When becoming abnormal again, replace indoor controller board.</p> <p>b) When "RC NG" is displayed, replace remote controller.</p> <p>c) When "RC E3" or "ERC 00-66" is displayed, noise may be causing abnormality.</p>
E6	<p><b>Interface unit/Flow temp. controller or outdoor unit communication error (Signal receiving error)</b></p> <p>① Abnormal if Interface unit/Flow temp. controller cannot receive any signal normally for 6 minutes after turning the power on.</p> <p>② Abnormal if Interface unit/Flow temp. controller cannot receive any signal normally for 3 minutes.</p>	<p>① Contact failure, short circuit or, miswiring (converse wiring) of Interface unit/Flow temp. controller or outdoor unit connecting wire</p> <p>② Defective transmitting receiving circuit of outdoor controller circuit board</p> <p>③ Defective transmitting receiving circuit of Interface unit/Flow temp. controller</p> <p>④ Noise has entered into Interface unit/Flow temp. controller or outdoor unit connecting wire.</p>	<p>* Check LED display on the outdoor controller circuit board. (Connect A-control service tool, PAC-SK52ST.)</p> <p>① Check disconnection or looseness of Interface unit/Flow temp. controller or outdoor unit connecting wire of Interface unit/Flow temp. controller or outdoor unit.</p> <p>②-④ Turn the power off, and on again to check. If abnormality generates again, replace Interface unit/Flow temp. controller or outdoor controller circuit board.</p>







Error Code	Abnormal point and detection method	Case	Judgment and action
E8	<b>Interface unit/Flow temp. controller or outdoor unit communication error (Signal receiving error) (Outdoor unit)</b> (1) Abnormal if outdoor controller circuit board could not receive anything normally for 3 minutes.	① Contact failure of Interface unit/Flow temp. controller or outdoor unit connecting wire ② Defective communication circuit of outdoor controller circuit board ③ Defective communication circuit of Interface unit/Flow temp. controller ④ Noise has entered into Interface unit/Flow temp. controller or outdoor unit connecting wire.	① Check disconnection or looseness of Interface unit/Flow temp. controller or outdoor unit connecting wire of Interface unit/Flow temp. controller or outdoor unit. ②~④ Turn the power off, and on again to check. Replace PCB of Interface unit/Flow temp. controller or outdoor controller circuit board if abnormality is displayed again.
E9	<b>Interface unit/Flow temp. controller or outdoor unit communication error (Transmitting error) (Outdoor unit)</b> (1) Abnormal if "0" receiving is detected 30 times continuously though outdoor controller circuit board has transmitted "1". (2) Abnormal if outdoor controller circuit board could not find blank of transmission path for 3 minutes.	① Interface unit/Flow temp. controller or outdoor unit connecting wire has contact failure. ② Defective communication circuit of outdoor controller circuit board ③ Noise has entered power supply. ④ Noise has entered Interface unit/Flow temp. controller or outdoor unit connecting wire.	① Check disconnection or looseness of Interface unit/Flow temp. controller or outdoor unit connecting wire. ②~④ Turn the power off, and on again to check. Replace outdoor controller circuit board if abnormality is displayed again.
EF	<b>Non defined error code</b> This code is displayed when non defined error code is received.	① Noise has entered transmission wire of remote controller. ② Noise has entered Interface unit/Flow temp. controller-outdoor unit connecting wire.	①② Turn the power off, and on again to check. Replace Interface/FTC or outdoor controller circuit board if abnormality is displayed again.
Ed	<b>Serial communication error</b> Abnormal if serial communication between outdoor controller circuit board and outdoor power circuit board is defective.	① Wire disconnection or contact failure of connector CN2 between the outdoor controller circuit board and the outdoor power circuit board ② Wire disconnection or contact failure of connector CN4 between the outdoor controller circuit board and the outdoor power circuit board ③ Defective communication circuit of outdoor power circuit board ④ Defective communication circuit of outdoor controller circuit board for outdoor power circuit board	①② Check connection of each connector CN2 and CN4 between the outdoor controller circuit board and the outdoor power circuit board. ③ Replace outdoor power circuit board. ④ Replace outdoor controller circuit board.

Error Code	Abnormal point and detection method	Cause	Judgment and action										
P1	<p><b>Actual flow water temperature thermistor (TH1)</b></p> <p>① The unit is in 3-minute resume prevention mode if short/open of thermistor is detected. Abnormal if the unit does not reset normally after 3 minutes. (The unit returns to normal operation, if it has been reset normally.)</p> <p>② Constantly detected during cooling, heating ECO, anti freeze, hot water and heating operation. Short: -90°C or more Open: -40°C or less</p>	<p>① Defective thermistor characteristics</p> <p>② Contact failure of TB61 No.1-2 on PCB of Interface unit/Flow temp. controller</p> <p>③ Breaking of wire or contact failure of thermistor wiring</p> <p>④ Defective PCB of Interface unit/Flow temp. controller</p>	<p>①~③ Check resistance value of thermistor.</p> <table border="1"> <tr><td>0°C</td><td>15.0kΩ</td></tr> <tr><td>10°C</td><td>9.6kΩ</td></tr> <tr><td>20°C</td><td>6.3kΩ</td></tr> <tr><td>30°C</td><td>4.3kΩ</td></tr> <tr><td>40°C</td><td>3.0kΩ</td></tr> </table> <p>If you put force on (draw or bend) the lead wire with measuring resistance value of thermistor, breaking of wire or contact failure can be detected.</p> <p>② Check contact failure of TB61 No.1-2 on PCB of Interface unit/Flow temp. controller. Refer to 8. Turn the power on again and check restart after inserting connector again.</p> <p>④ Check actual flow water temperature display on remote controller. Replace PCB of Interface unit/Flow temp. controller if there is abnormal difference with actual flow water temperature. Turn the power off, and on again to operate after check.</p>	0°C	15.0kΩ	10°C	9.6kΩ	20°C	6.3kΩ	30°C	4.3kΩ	40°C	3.0kΩ
0°C	15.0kΩ												
10°C	9.6kΩ												
20°C	6.3kΩ												
30°C	4.3kΩ												
40°C	3.0kΩ												
P2	<p><b>Pipe temperature thermistor/Liquid (TH2)</b></p> <p>① The unit is in 3-minute resume prevention mode if short/open of thermistor is detected. Abnormal if the unit does not reset normally after 3 minutes. (The unit returns to normal operation, if it has been reset normally.)</p> <p>② Constantly detected during cooling, heating ECO, anti freeze, hot water and heating (except defrosting) operation Short: 90°C or more Open: -40°C or less</p>	<p>① Defective thermistor characteristics</p> <p>② Contact failure of TB61 No.3-4 on PCB of Interface unit/Flow temp. controller</p> <p>③ Breaking of wire or contact failure of thermistor wiring</p> <p>④ Defective refrigerant circuit is causing thermistor temperature of 90°C or more or -40°C or less.</p> <p>⑤ Defective PCB of Interface unit/Flow temp. controller</p>	<p>①~③ Check resistance value of thermistor. For characteristics, refer to (P1) above.</p> <p>② Check contact failure of TB61 No.3-4 on PCB of Interface unit/Flow temp. controller. Refer to 8. Turn the power on and check restart after inserting connector again.</p> <p>④ Check pipe &lt;liquid&gt; temperature with remote controller in test run mode. If pipe &lt;liquid&gt; temperature is extremely low (in cooling mode) or high (in heating mode), refrigerant circuit may have defective.</p> <p>⑤ Check pipe &lt;liquid&gt; temperature with remote controller in test run mode. If there is extremely difference with actual pipe &lt;liquid&gt; temperature, replace PCB of Interface unit/Flow temp. controller.</p> <p>Turn the power off, and on again to operate after check.</p>										
P6	<p><b>Freezing/overheating protection is working</b></p> <p>① Freezing protection (Cooling mode) The unit is in 6-minute resume prevention mode if pipe temperature stays under -15°C for 3 minutes, 3 minutes after the compressor started. Abnormal if it stays under -15°C for 3 minutes again within 16 minutes after 6-minute resume prevention mode.</p> <p>② Overheating protection (Heating, heating ECO, Anti freeze, Hot water mode) The units is in 6 minute resume prevention mode if pipe temperature is detected as over 70°C after the compressor started. Abnormal if the temperature of over 70°C is detected again within 30 minutes after 6 minute resume prevention mode.</p>	<p>(Cooling mode)</p> <p>① Short cycle of air path</p> <p>② Low-load (low temperature) operation out of the tolerance range</p> <p>③ Defective outdoor fan control</p> <p>④ Overcharge of refrigerant</p> <p>⑤ Defective refrigerant circuit (clogs)</p> <p>(Heating mode)</p> <p>① Short cycle of air path</p> <p>② Over-load (high temperature) operation out of the tolerance range</p> <p>③ Defective outdoor fan control</p> <p>④ Overcharge of refrigerant</p> <p>⑤ Defective refrigerant circuit (clogs)</p> <p>⑥ Bypass circuit of outdoor unit is defective.</p>	<p>(Cooling mode)</p> <p>① Remove blockage.</p> <p>③ Check outdoor fan motor.</p> <p>④⑤ Check operating condition of refrigerant circuit.</p> <p>(Heating mode)</p> <p>① Remove blockage.</p> <p>③ Check outdoor fan motor.</p> <p>④~⑥ Check operating condition of refrigerant circuit.</p>										
P9	<p><b>Actual tank temperature thermistor (TH5)</b></p> <p>① The unit is 3-minute resume prevention mode if short/open of thermistor is detected. Abnormal if the unit does not reset normally after 3 minutes. (The unit returns to normal operation, if it has been reset normally)</p> <p>② Constantly detected during cooling, heating, heating ECO, anti freeze and hot water operation.</p>	<p>① Defective thermistor characteristics</p> <p>② Contact failure of TB61 No. 5-6 on PCB of interface unit/Flow temp. controller</p> <p>③ Breaking of wire or contact failure of thermistor wiring</p> <p>④ Defective PCB of interface unit/Flow temp. controller</p>	<p>①~③ Check resistance value of thermistor.</p> <table border="1"> <tr><td>0°C</td><td>15.0kΩ</td></tr> <tr><td>10°C</td><td>9.6kΩ</td></tr> <tr><td>20°C</td><td>6.3kΩ</td></tr> <tr><td>30°C</td><td>4.3kΩ</td></tr> <tr><td>40°C</td><td>3.0kΩ</td></tr> </table> <p>If you put force on (draw or bend) the lead wire with measuring resistance value of thermistor, breaking of wire or contact failure can be detected.</p> <p>② Check contact failure of TB61 No.5-6 on PCB of Interface unit/Flow temp. controller. Refer to 8. Turn the power on again and check restart after inserting connector again.</p> <p>④ Check actual tank temperature display on remote controller. Replace PCB of Interface unit/Flow temp. controller if there is abnormal difference with actual tank temperature. Turn the power off, and on again to operate after check.</p>	0°C	15.0kΩ	10°C	9.6kΩ	20°C	6.3kΩ	30°C	4.3kΩ	40°C	3.0kΩ
0°C	15.0kΩ												
10°C	9.6kΩ												
20°C	6.3kΩ												
30°C	4.3kΩ												
40°C	3.0kΩ												



## 8-4. TROUBLESHOOTING

A flowing water sound or occasional hissing sound is heard.	<ul style="list-style-type: none"> <li>These sounds can be heard when refrigerant and/or water is (are) flowing in the indoor unit or refrigerant pipe, or when the refrigerant and/or water is (are) chugging.</li> </ul>
Water does not heat or cool well.	<ul style="list-style-type: none"> <li>Clean the filter of water piping. (Flow is reduced when the filter is dirty or clogged.)</li> <li>Check the temperature adjustment and adjust the set temperature.</li> <li>Make sure that there is plenty of space around the outdoor unit.</li> </ul>
Water or vapour is emitted from the outdoor unit.	<ul style="list-style-type: none"> <li>During cooling mode, water may form and drip from the cool pipes and joints.</li> <li>During heating mode, water may form and drip from the heat exchanger of outdoor unit.</li> <li>During defrosting mode, water on the heat exchanger of outdoor unit evaporates and water vapour may be emitted.</li> </ul>
The operation indicator does not appear in the remote controller display.	<ul style="list-style-type: none"> <li>Turn on the power switch. "●" will appear in the remote controller display.</li> </ul>
"  appears in the remote controller display.	<ul style="list-style-type: none"> <li>During external signal control, " appears in the remote controller display and FTC operation cannot be started or stopped using the remote controller.</li> </ul>
When restarting the outdoor unit soon after stopping it, it does not operate even though the ON/OFF button is pressed.	<ul style="list-style-type: none"> <li>Wait approximately 3 minutes. (Operation has stopped to protect the outdoor unit.)</li> </ul>
FTC operates without the ON/OFF button being pressed.	<ul style="list-style-type: none"> <li>Is the on timer set? Press the ON/OFF button to stop operation.</li> <li>Is the FTC connected to a external signal? Consult the concerned people who control the FTC.</li> <li>Does " appear in the remote controller display? Consult the concerned people who control the FTC.</li> <li>Has the auto recovery feature from power failures been set? Press the ON/OFF button to stop operation.</li> </ul>
FTC stops without the ON/OFF button being pressed.	<ul style="list-style-type: none"> <li>Is the off timer set? Press the ON/OFF button to restart operation.</li> <li>Is the air conditioner connected to a central remote controller? Consult the concerned people who control the FTC.</li> <li>Does " appear in the remote controller display? Consult the concerned people who control the FTC.</li> </ul>
Remote controller timer operation cannot be set.	<ul style="list-style-type: none"> <li>Are timer settings invalid? If the timer can be set, (WEEKLY), (SIMPLE), or (AUTO OFF) appears in the remote controller display.</li> </ul>
"PLEASE WAIT" appears in the remote controller display.	<ul style="list-style-type: none"> <li>The initial settings are being performed. Wait approximately 3 minutes.</li> <li>If the remote controller is not only for FTC, change it.</li> </ul>
An error code appears in the remote controller display.	<ul style="list-style-type: none"> <li>The protection devices have operated to protect the FTC and outdoor unit.</li> <li>Do not attempt to repair this equipment by yourself. Turn off the power switch immediately and consult your dealer. Be sure to provide the dealer with the model name and information that appeared in the remote controller display.</li> </ul>

- If the unit cannot be operated properly after test run, refer to the following table to find the cause.

Symptom		Cause
Wired remote controller	LED 1, 2 (PCB in outdoor unit)	
PLEASE WAIT	For about 2 minutes after power-on	After LED 1, 2 are lighted, LED 2 is turned off, then only LED 1 is lighted. (Correct operation)
PLEASE WAIT → Error code	Subsequent to about 2 minutes after power-on	Only LED 1 is lighted. → LED 1, 2 blink.
Display messages do not appear even when operation switch is turned ON (operation lamp does not light up).		Only LED 1 is lighted. → LED 1 blinks twice, LED 2 blinks once.

**Note: Operation is not possible for about 30 seconds after cancellation of function selection. (Correct operation)**

For description of each LED (LED1, 2, 3) provided on the FTC, refer to the following table.

LED1 (power for microprocessor)	Indicates whether control power is supplied. Make sure that this LED is always lit.
LED2 (power for remote controller)	Indicates whether power is supplied to the remote controller. This LED lights only in the case of the FTC which is connected to the outdoor unit refrigerant addresses "0".
LED3 (communication between FTC and outdoor units)	Indicates state of communication between the FTC and outdoor units. Make sure that this LED is always blinking.

## 8-5. HOW TO CHECK THE PARTS

### PUHZ-HRP200YKA

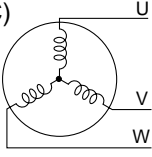
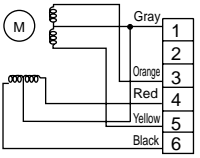
Parts name	Check points														
TH3: Liquid pipe temperature TH4: Discharge temperature TH6: 2-phase pipe temperature TH7: Ambient temperature TH32: Suction pipe temperature	Disconnect the connector then measure the resistance with a tester. (At the ambient temperature 10°C ~30°C) <table border="1" style="margin-top: 10px;"> <thead> <tr> <th></th> <th>Normal</th> <th>Abnormal</th> </tr> </thead> <tbody> <tr> <td>TH4</td> <td>160kΩ ~ 410kΩ</td> <td rowspan="4">Open or short</td> </tr> <tr> <td>TH3</td> <td rowspan="4">4.3kΩ ~ 9.6kΩ</td> </tr> <tr> <td>TH6</td> </tr> <tr> <td>TH7 TH32</td> </tr> </tbody> </table>		Normal	Abnormal	TH4	160kΩ ~ 410kΩ	Open or short	TH3	4.3kΩ ~ 9.6kΩ	TH6	TH7 TH32				
	Normal	Abnormal													
TH4	160kΩ ~ 410kΩ	Open or short													
TH3	4.3kΩ ~ 9.6kΩ														
TH6															
TH7 TH32															
Fan motor(MF1,MF2)		Refer to next page.													
Solenoid valve coil <4-way valve> (21S4)	Measure the resistance between the terminals with a tester. (At the ambient temperature 20°C) <table border="1" style="margin-top: 10px;"> <thead> <tr> <th>Normal</th> <th>Abnormal</th> </tr> </thead> <tbody> <tr> <td>1435±150Ω</td> <td>Open or short</td> </tr> </tbody> </table>	Normal	Abnormal	1435±150Ω	Open or short										
Normal	Abnormal														
1435±150Ω	Open or short														
Motor for compressor (MC) 	Measure the resistance between the terminals with a tester. (Winding temperature 20°C) <table border="1" style="margin-top: 10px;"> <thead> <tr> <th>Normal (U-V, U-W, W-V)</th> <th>Abnormal</th> </tr> </thead> <tbody> <tr> <td>0.37Ω</td> <td>Open or short</td> </tr> </tbody> </table>	Normal (U-V, U-W, W-V)	Abnormal	0.37Ω	Open or short										
Normal (U-V, U-W, W-V)	Abnormal														
0.37Ω	Open or short														
Linear expansion valve (LEV-A/LEV-B/LEV-C) 	Disconnect the connector then measure the resistance with a tester. (Winding temperature 20°C) <table border="1" style="margin-top: 10px;"> <thead> <tr> <th colspan="4">Normal</th> <th>Abnormal</th> </tr> </thead> <tbody> <tr> <td>Gray - Black</td> <td>Gray - Red</td> <td>Gray - Yellow</td> <td>Gray - Orange</td> <td rowspan="2">Open or short</td> </tr> <tr> <td colspan="4" style="text-align: center;">46±3Ω</td> </tr> </tbody> </table>	Normal				Abnormal	Gray - Black	Gray - Red	Gray - Yellow	Gray - Orange	Open or short	46±3Ω			
Normal				Abnormal											
Gray - Black	Gray - Red	Gray - Yellow	Gray - Orange	Open or short											
46±3Ω															

## Check method of DC fan motor (fan motor / outdoor controller circuit board)

### ① Notes

- High voltage is applied to the connector (CNF1, 2) for the fan motor. Pay attention to the service.
- Do not pull out the connector (CNF1, 2) for the motor with the power supply on.  
(It causes trouble of the outdoor controller circuit board and fan motor.)

### ② Self check

Symptom : The outdoor fan cannot turn around.

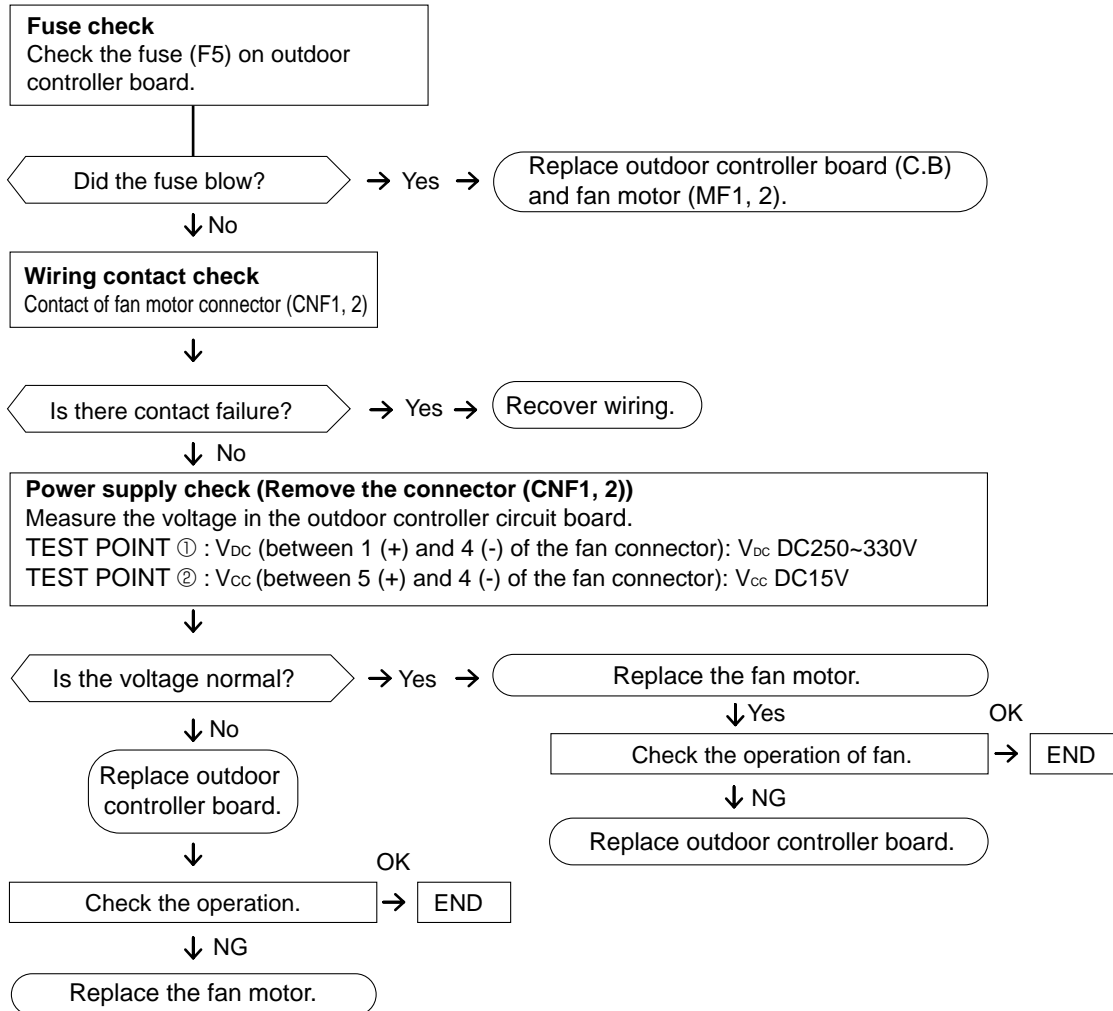

## 8-6. HOW TO CHECK THE COMPONENTS

### <Thermistor feature chart>

#### Low temperature thermistors

- Thermistor <Liquid pipe> (TH3)
- Thermistor <2-phase pipe> (TH6)
- Thermistor <Ambient> (TH7)
- Thermistor <Suction pipe> (TH32)

Thermistor R0 = 15kΩ ± 3%

B constant = 3480 ± 2%

$$R_t = 15 \exp\left\{3480 \left( \frac{1}{273+t} - \frac{1}{273} \right)\right\}$$

0°C	15kΩ	30°C	4.3kΩ
10°C	9.6kΩ	40°C	3.0kΩ
20°C	6.3kΩ		
25°C	5.2kΩ		

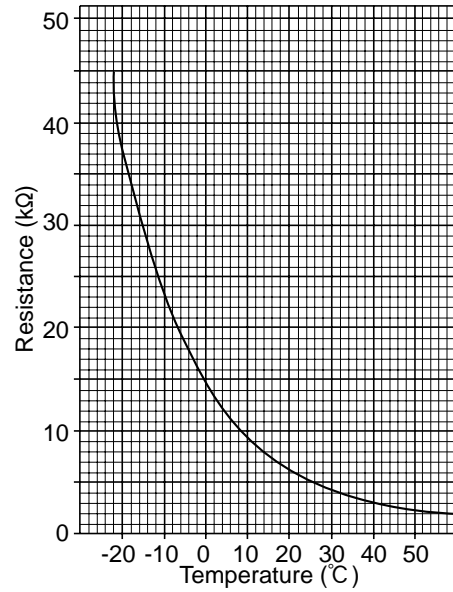

#### High temperature thermistor

- Thermistor <Discharge pipe> (TH4)

Thermistor R120 = 7.465kΩ ± 2%

B constant = 4057 ± 2%

$$R_t = 7.465 \exp\left\{4057 \left( \frac{1}{273+t} - \frac{1}{393} \right)\right\}$$

20°C	250kΩ	70°C	34kΩ
30°C	160kΩ	80°C	24kΩ
40°C	104kΩ	90°C	17.5kΩ
50°C	70kΩ	100°C	13.0kΩ
60°C	48kΩ	110°C	9.8kΩ

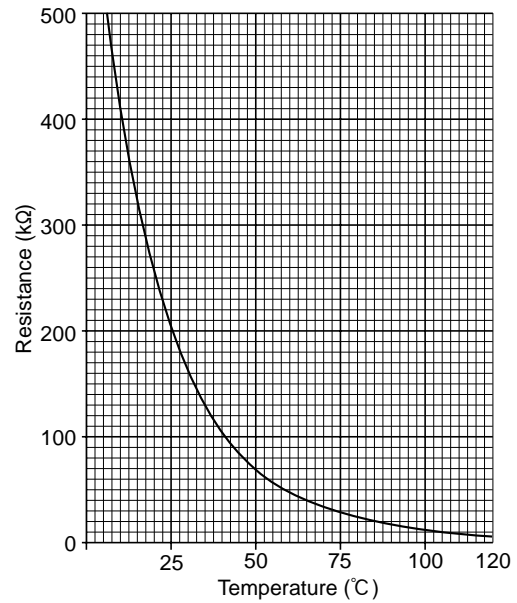

### <HIGH PRESSURE SENSOR>

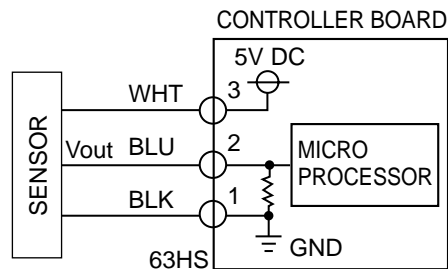
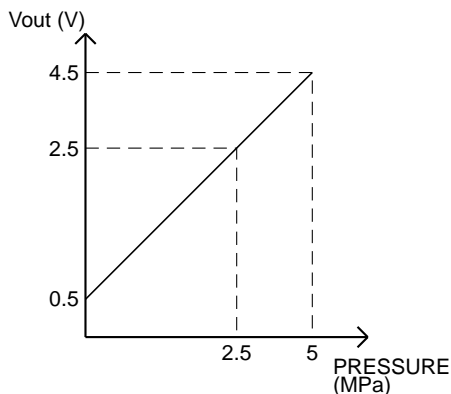

- ③-① : 5V (DC)
- ②-① : Output Vout (DC)

## Linear expansion valve

### (1) Operation summary of the linear expansion valve

- Linear expansion valve opens/closes through stepping motor after receiving the pulse signal from the outdoor controller board.
- Valve position can be changed in proportion to the number of pulse signal.

<Connection between the outdoor controller board and the linear expansion valve>

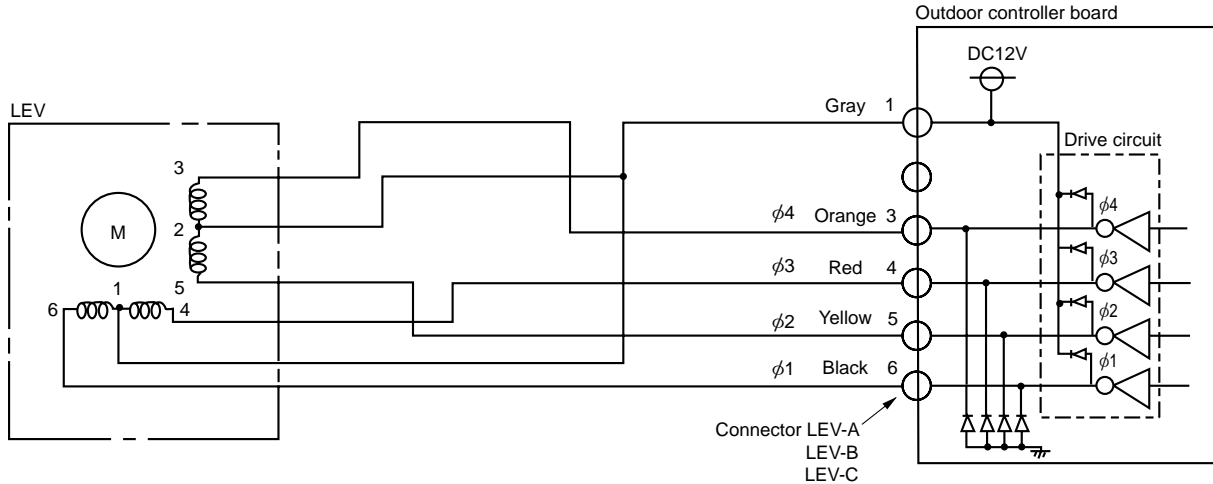

### <Output pulse signal and the valve operation>

Output (Phase)	Output							
	1	2	3	4	5	6	7	8
$\phi 1$	ON	ON	OFF	OFF	OFF	OFF	OFF	ON
$\phi 2$	OFF	ON	ON	ON	OFF	OFF	OFF	OFF
$\phi 3$	OFF	OFF	OFF	ON	ON	ON	OFF	OFF
$\phi 4$	OFF	OFF	OFF	OFF	OFF	ON	ON	ON

Opening a valve : 8 → 7 → 6 → 5 → 4 → 3 → 2 → 1 → 8

Closing a valve : 1 → 2 → 3 → 4 → 5 → 6 → 7 → 8 → 1

The output pulse shifts in above order.

- When linear expansion valve operation stops, all output phase become OFF.

### (2) Linear expansion valve operation

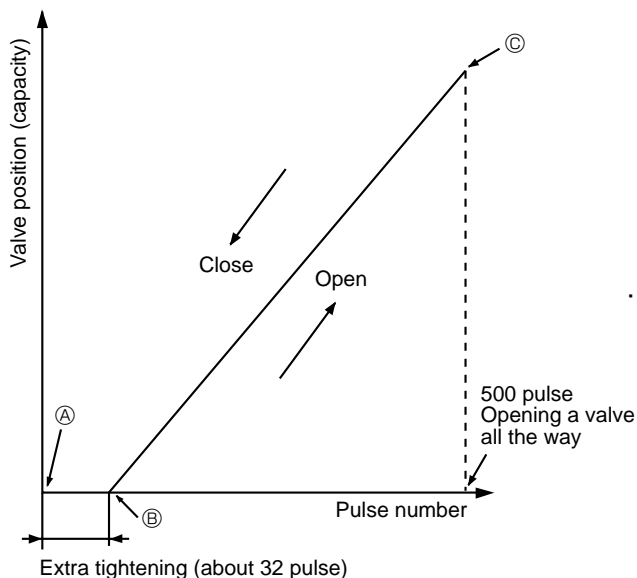

- When the switch is turned on, 700 pulse closing valve signal will be sent till it goes to A point in order to define the valve position. (The pulse signal is being sent for about 20 seconds.)

When the valve moves smoothly, there is no sound or vibration occurring from the linear expansion valve : however, when the pulse number moves from B to A or when the valve is locked, more sound can be heard. No sound is heard when the pulse number moves from B to A in case coil is burnt out or motor is locked by open-phase.

- Sound can be detected by placing the ear against the screw driver handle while putting the screw driver to the linear expansion valve.

### (3) How to attach and detach the coil of linear expansion valve

<Composition>

Linear expansion valve is separable into the main body and the coil as shown in the diagram below.

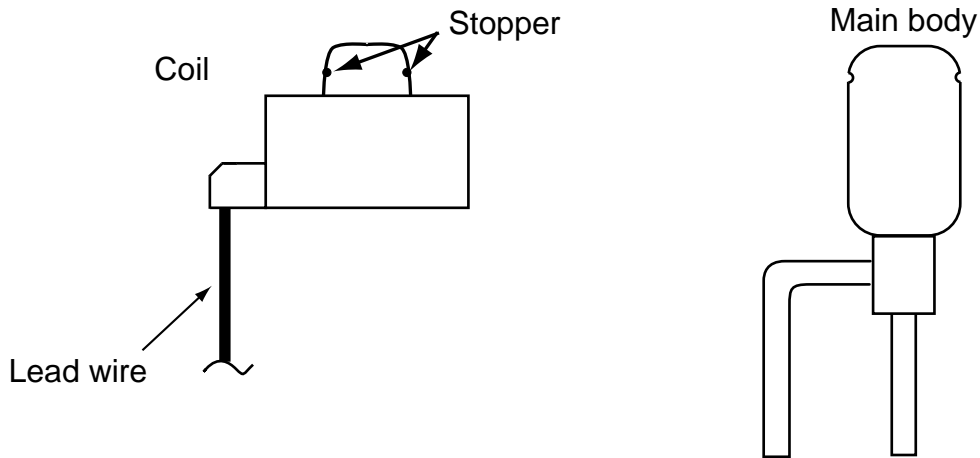

#### <How to detach the coil>

Hold the lower part of the main body (shown as A) firmly so that the main body does not move and detach the coil by pulling it upward.

Be sure to detach the coil holding main body firmly. Otherwise pipes can bend due to pressure.

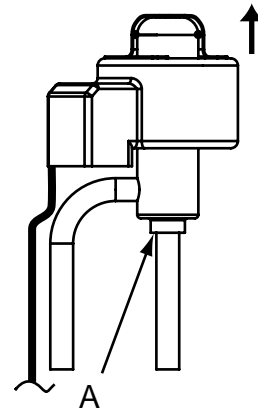

#### <How to attach the coil>

Hold the lower part of the main body (shown as A) firmly so that the main body does not move and attach the coil by inserting it downward into the main body. Then securely attach the coil stopper to main body. (At this time, be careful that stress is not added to lead wire and main body is not wound by lead wire.) If the stopper is not firmly attached to main body, coil may be detached from the main body and that can cause defective operation of linear expansion valve.

To prevent piping stress, be sure to attach the coil holding main body of linear expansion valve firmly. Otherwise pipe may break.

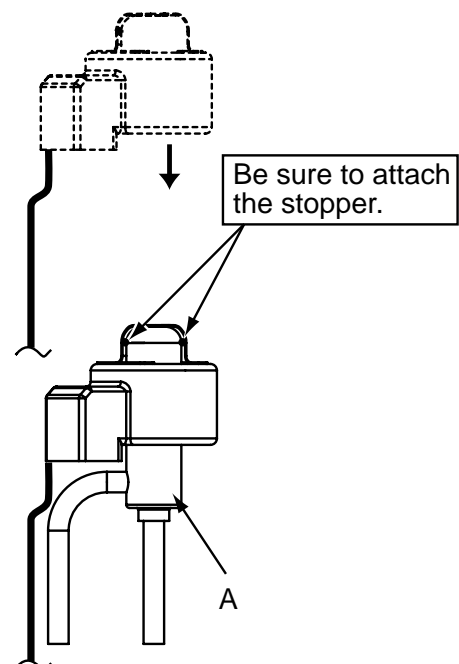

## 8-7. TEST POINT DIAGRAM

### Outdoor controller circuit board PUHZ-HRP200YKA

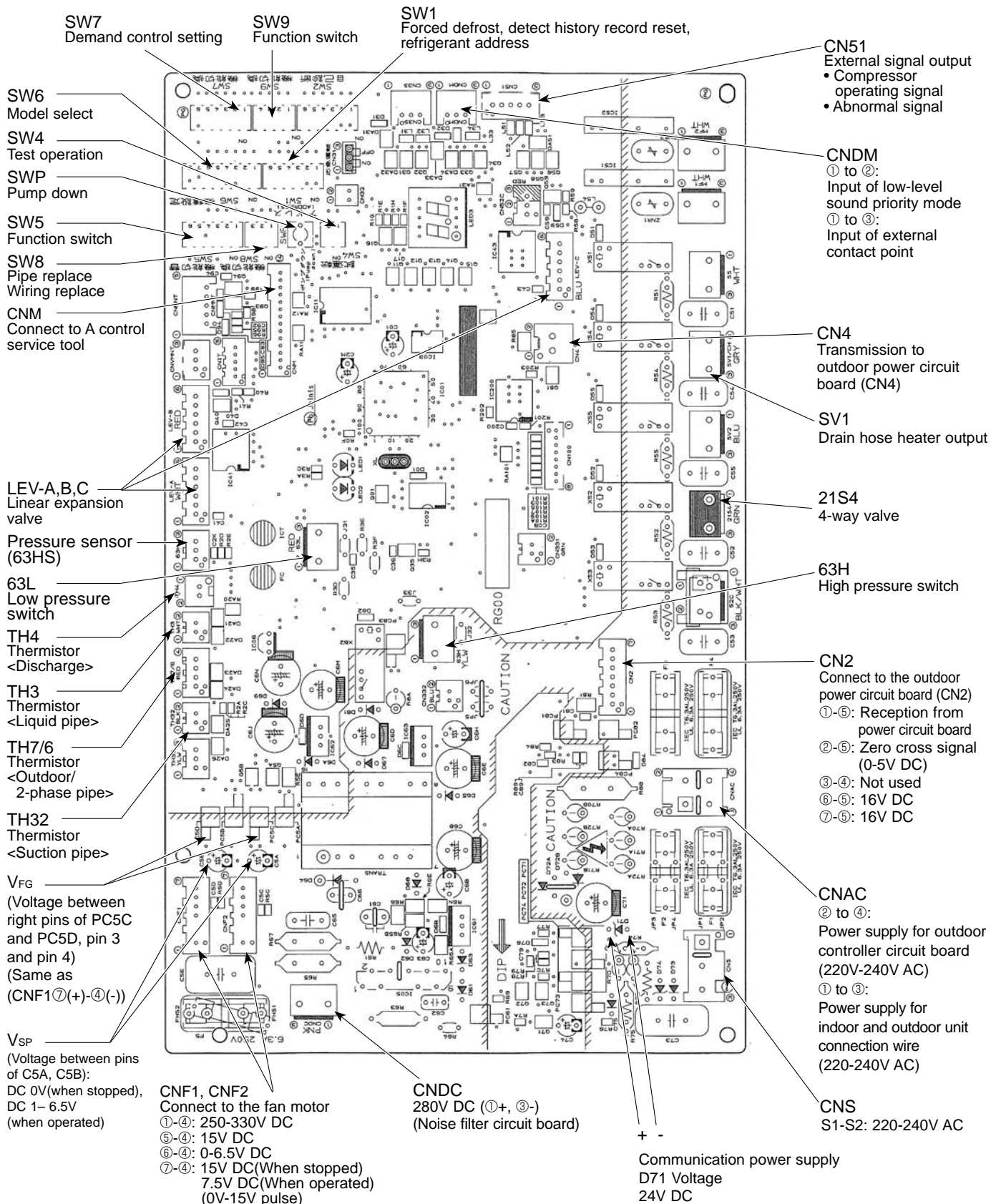

**Outdoor noise filter circuit board  
PUHZ-HRP200YKA**

**LI1, LI2, LI3, NI  
POWER SUPPLY**  
LI1-LI2/LI-LI3/LI3-LI1 : AC380/400/415V input  
LI1-NI/LI2-NI/LI3-NI : AC220/230/240V input  
(Connect to the terminal block (TB1))

**GD1**  
Connect to the earth

**CNAC1, CNAC2**  
AC220/230/240V  
(Connect to the outdoor controller circuit board (CNAC))

**GD3**  
Connect to the earth

**CNDC**  
(Connect to the outdoor controller circuit board (CNDC))

**CNCT**  
Primary current  
(Connect to the outdoor power circuit board (CN5))

**CNL**  
Connect to the ACL4

**LO1, LO2, LO3  
POWER SUPPLY**  
LO1-LO2/LO2-LO3/LO3-LO1 : AC380/400/415V OUTPUT  
(Connect to the outdoor power circuit board (TB1-L1, L2, L3))

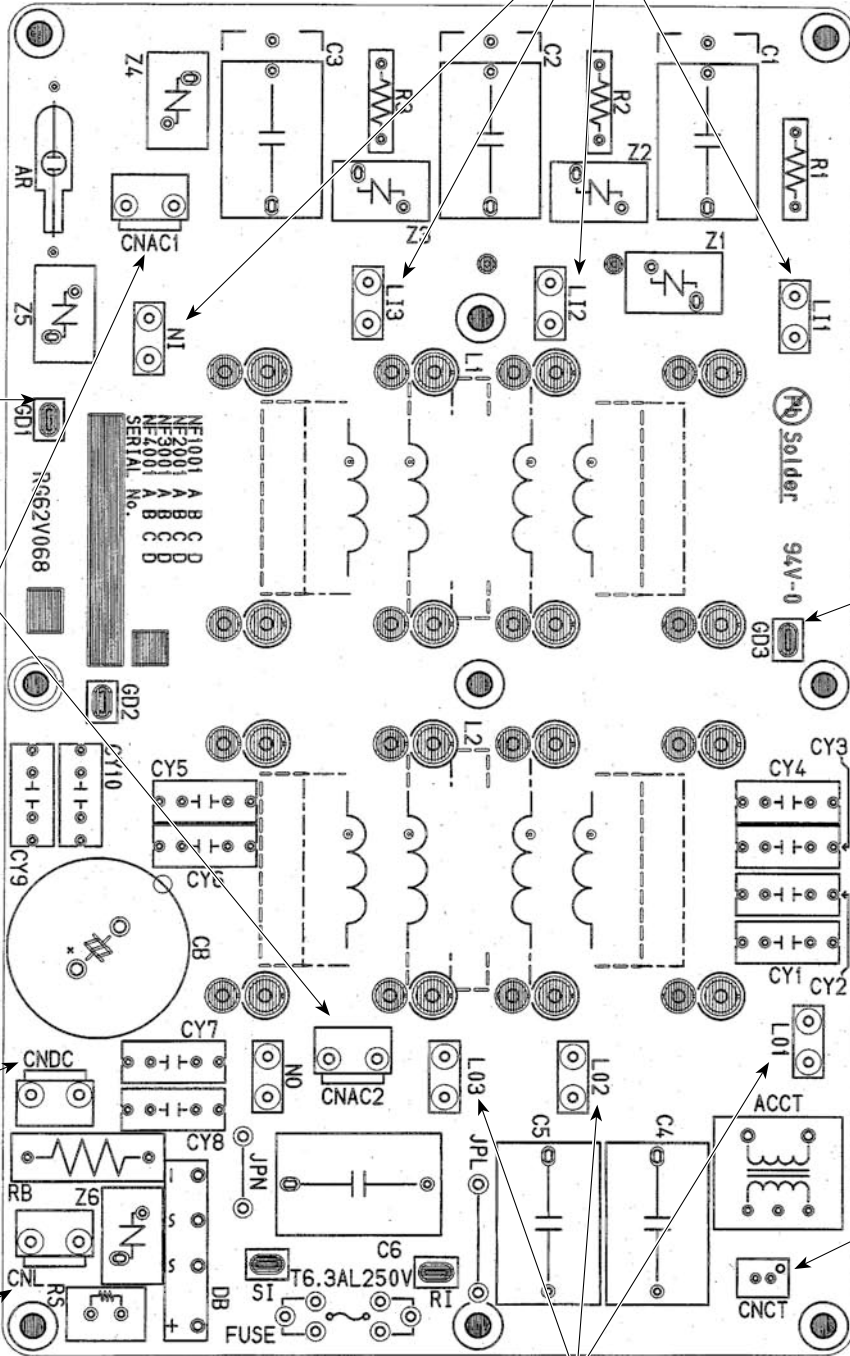



# Outdoor power circuit board PUHZ-HRP200YKA

## Brief Check of POWER MODULE

\* Usually, they are in a state of being short-circuited if they are broken. Measure the resistance in the following points (connectors, etc.). If they are short-circuited, it means that they are broken.

### 1. Check of POWER MODULE

#### ① Check of DIODE circuit

**L1**-P1, **L2**-P1, **L3**-P1, **L1**-N1, **L2**-N1, **L3**-N1

#### ② Check of IGBT circuit

**P2**-U, **P2**-V, **P2**-W, **N2**-U, **N2**-V, **N2**-W

Note: The marks, **L1**, **L2**, **L3**, **N1**, **N2**, **P1**, **P2**, **U**, **V** and **W** shown in the diagram are not actually printed on the board.

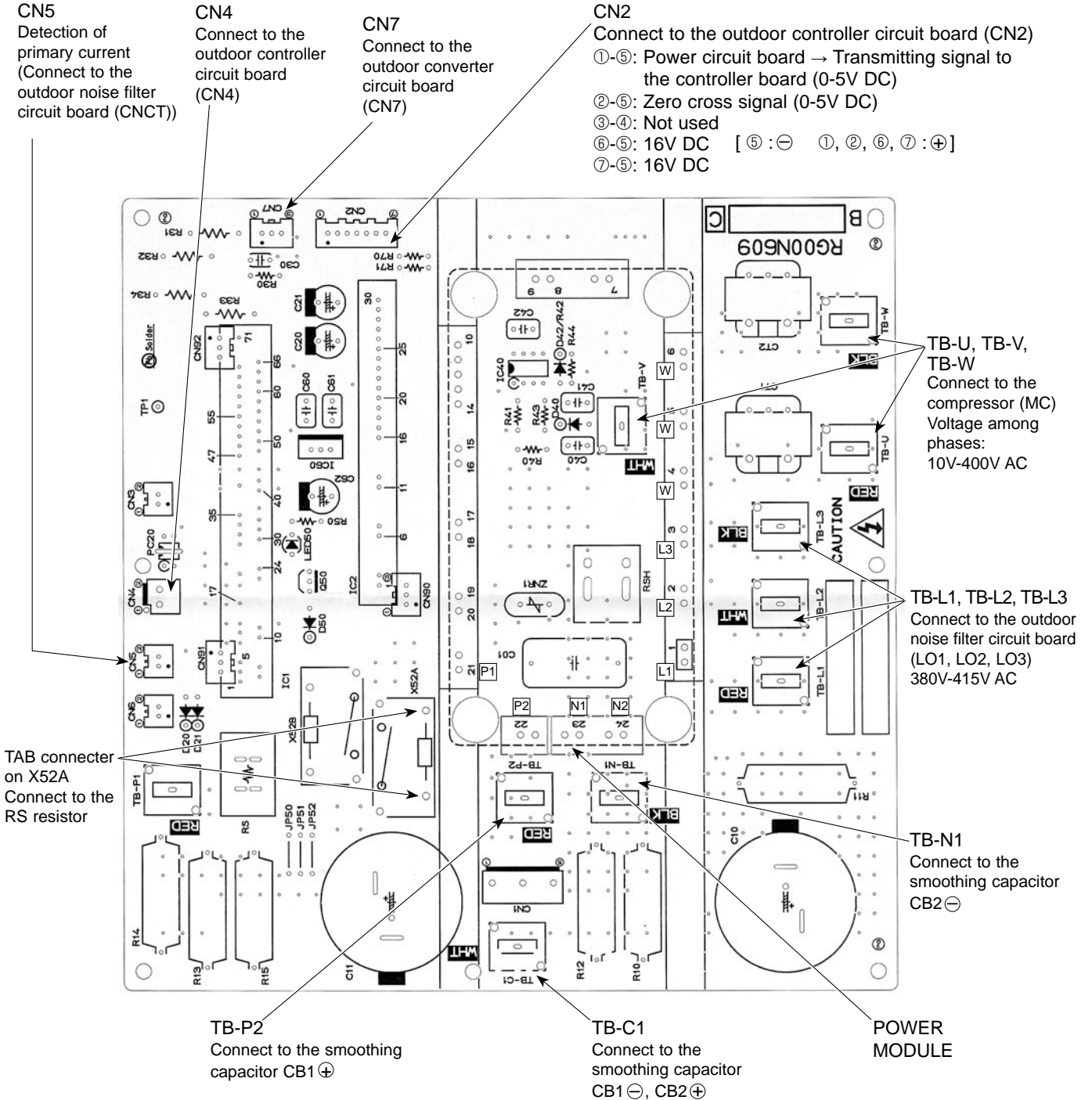

## 8-8. FUNCTION OF SWITCHES, CONNECTORS AND JUMPERS

### Function of switches

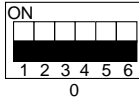
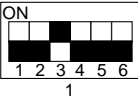
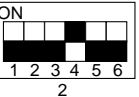
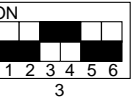
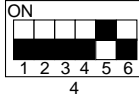
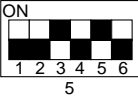
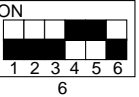
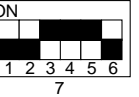
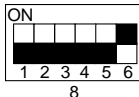
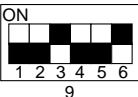
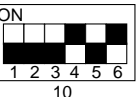
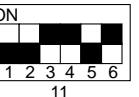
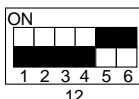
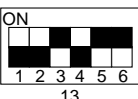
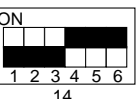
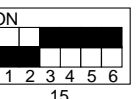
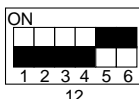
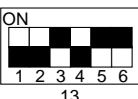
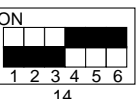
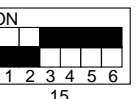
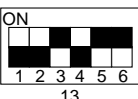
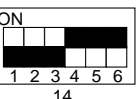
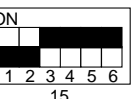
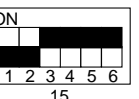
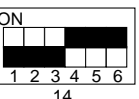
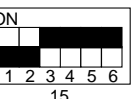
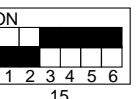
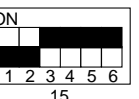
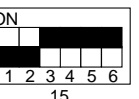
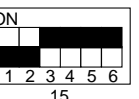
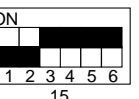
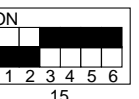
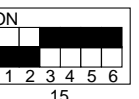
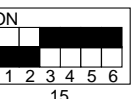
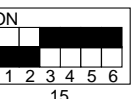
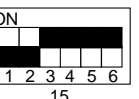
Type of switch	Switch	No.	Function	Action by the switch operation		Effective timing		
				ON	OFF			
Dip switch	SW1	1	Forced defrost *1	Start	Normal	When compressor is working in heating operation. *1		
		2	Abnormal history clear	Clear	Normal	off or operating		
		3	Refrigerant address setting					When power supply ON
		4						
		5						
		6						
	12							
	13							
	14							
	15							
	15							
	SW4	1	Test run	Operating	OFF	Under suspension		
	2	Test run mode setting	Heating	Cooling				
	SW8	1	No function	—	—	—		
		2	No function	—	—	—		
3		Separate indoor/outdoor unit power supplies	Used	Not used	When power supply ON			
Push switch	SWP		Pump down	Start	Normal	Under suspension		

\*1 Forced defrost should be done as follows.

① Change the DIP SW1-1 on the outdoor controller board from OFF to ON.

② Forced defrost will start by the above operation ① if all these conditions written below are satisfied.

- Heat mode setting
- 10 minutes have passed since compressor started operating or previous forced defrost finished.
- Pipe temperature is less than or equal to 8°C.

Forced defrost will finish if certain conditions are satisfied.

Forced defrost can be done if above conditions are satisfied when DIP SW1-1 is changed from OFF to ON.

After DIP SW1-1 is changed from OFF to ON, there is no problem if DIP SW1-1 is left ON or changed to OFF again.

This depends on the service conditions.



Type of Switch	Switch	No.	Function	Action by the switch operation		Effective timing																																											
				ON	OFF																																												
Dip switch	SW5	1	No function	—	—	—																																											
		2	Power failure automatic recovery *2	Auto recovery	No auto recovery	When power supply ON																																											
		3,4,5	No function	—	—	—																																											
		6	Model select	Following SW5-6 reference																																													
	SW7 *4	1	Setting of demand control *3	<table border="1"> <thead> <tr> <th>SW7-1</th> <th>SW7-2</th> <th>Power consumption (Demand switch ON)</th> </tr> </thead> <tbody> <tr> <td>OFF</td> <td>OFF</td> <td>0% (Operation stop)</td> </tr> <tr> <td>ON</td> <td>OFF</td> <td>50%</td> </tr> <tr> <td>OFF</td> <td>ON</td> <td>75%</td> </tr> </tbody> </table>			SW7-1	SW7-2	Power consumption (Demand switch ON)	OFF	OFF	0% (Operation stop)	ON	OFF	50%	OFF	ON	75%	Always																														
				SW7-1	SW7-2	Power consumption (Demand switch ON)																																											
				OFF	OFF	0% (Operation stop)																																											
				ON	OFF	50%																																											
		OFF	ON	75%																																													
		3	Defrost Hz setting	Defrost Hz × 0.54	Normal	Always																																											
	4	Max Hz setting (heating)	Max Hz(heating) × 0.8	Normal	Always																																												
	5	No function	—	—	—																																												
	6	Defrost setting	For high humidity	Normal	Always																																												
	SW9	1	No function	—	—	—																																											
		2	Function switch	Valid	Normal	Always																																											
		3,4	Starting Ambient temp. of flash injection	<table border="1"> <thead> <tr> <th>SW9-3</th> <th>SW9-4</th> <th>Ambient temp.</th> </tr> </thead> <tbody> <tr> <td>OFF</td> <td>OFF</td> <td>≤ 3°C (Initial setting)</td> </tr> <tr> <td>OFF</td> <td>ON</td> <td>≤ 0°C</td> </tr> <tr> <td>ON</td> <td>OFF</td> <td>≤ -3°C</td> </tr> <tr> <td>ON</td> <td>ON</td> <td>≤ -6°C</td> </tr> </tbody> </table>			SW9-3	SW9-4	Ambient temp.	OFF	OFF	≤ 3°C (Initial setting)	OFF	ON	≤ 0°C	ON	OFF	≤ -3°C	ON	ON	≤ -6°C	Always																											
				SW9-3	SW9-4	Ambient temp.																																											
	OFF			OFF	≤ 3°C (Initial setting)																																												
	OFF			ON	≤ 0°C																																												
	ON	OFF	≤ -3°C																																														
	ON	ON	≤ -6°C																																														
	SW6	1	Model select	<table border="1"> <thead> <tr> <th colspan="8">SW6</th> <th colspan="6">SW5-6</th> </tr> </thead> <tbody> <tr> <td>ON</td><td>OFF</td><td>ON</td><td>OFF</td><td>ON</td><td>OFF</td><td>ON</td><td>OFF</td> <td>ON</td><td>OFF</td><td>ON</td><td>OFF</td><td>ON</td><td>OFF</td> </tr> <tr> <td>1</td><td>2</td><td>3</td><td>4</td><td>5</td><td>6</td><td>7</td><td>8</td> <td>1</td><td>2</td><td>3</td><td>4</td><td>5</td><td>6</td> </tr> </tbody> </table>				SW6								SW5-6						ON	OFF	ON	OFF	ON	OFF	ON	OFF	ON	OFF	ON	OFF	ON	OFF	1	2	3	4	5	6	7	8	1	2	3	4	5	6
		SW6								SW5-6																																							
		ON						OFF	ON	OFF	ON	OFF	ON	OFF	ON	OFF	ON	OFF	ON	OFF																													
1		2						3	4	5	6	7	8	1	2	3	4	5	6																														
2																																																	
3																																																	
4																																																	
5																																																	
6																																																	
7																																																	
8																																																	
SW5	6																																																

\*2 “Power failure automatic recovery” can be set by either remote controller or this DIP SW. If one of them is set to ON, “Auto recovery” activates. Please set “Auto recovery” basically by remote controller because all units do not have DIP SW.

Please refer to the indoor unit installation manual.

\*3 SW7-1,2 are used for demand control. SW7-1,2 are effective only at the demand control. (Refer to next page : Special function (b))

\*4 Please do not use SW7-3, 4 ,6 usually. Trouble might be caused by the usage condition.

## Special function

### (a) Low-level sound priority mode (Local wiring)

Unit enters into Low-level sound priority mode by external signal input setting.

Inputting external signals to the outdoor unit decreases the outdoor unit operation sound 3 to 4 dB lower than that of usual. Adding a commercial timer or on-off switch contactor setting to the CNDM connector which is optional connector for demand input located on the outdoor controller board enables to control compressor operation frequency.

\* The performance depends on the load of conditioned outdoor temperature.

### Note:

When the Dip SW9-1 on the control board of the outdoor unit is ON, set Dip SW9-1 to OFF.

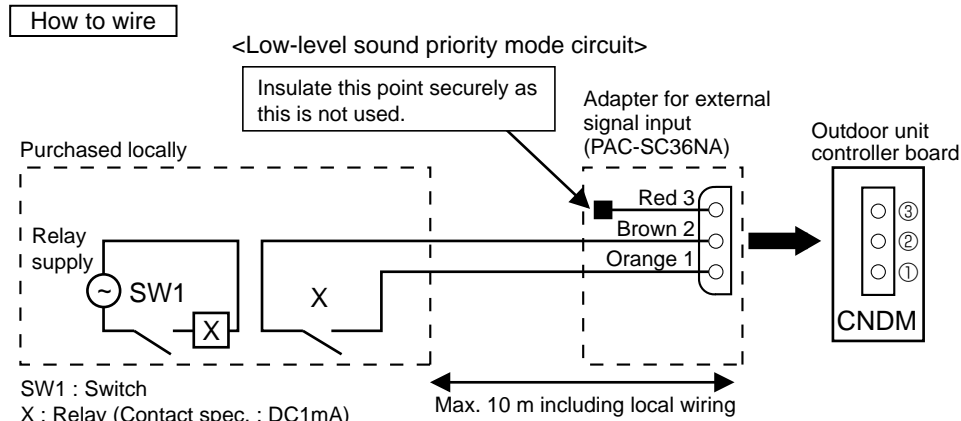

- 1) Make the circuit as shown above with adapter for external signal input (PAC-SC36NA).
- 2) Turn SW1 to on for Low-level sound priority mode.  
Turn SW1 to off to release Low-level sound priority mode and normal operation.

### (b) On demand control (Local wiring)

Demand control is available by external input. In this mode, power consumption is decreased within the range of usual 0~100%.

#### How to wire

Basically, the wiring is same with (a).

Connect an SW 1 which is procured locally between Orange and Red (1 and 3) of the adapter for external signal input (PAC-SC36NA), and insulate the tip of the brown lead wire.

It is possible to set it to the following power consumption (compared with ratings) by setting the SW7-1, 2.

SW7-1	SW7-2	Power consumption (SW1 on)
OFF	OFF	0% (Operation stop)
ON	OFF	50%
OFF	ON	75%

**<Display function of inspection for outdoor unit>**

The blinking patterns of both LED1 (green) and LED2 (red) indicate the types of abnormality when it occurs. Types of abnormality can be indicated in details by connecting an optional part "A-Control Service Tool (PAC-SK52ST)" to connector CNM on outdoor controller board.

[Display]

(1)Normal condition

Unit condition	Outdoor controller board		A-Control Service Tool	
	LED1 (Green)	LED2 (Red)	Error code	Indication of the display
When the power is turned on	Lighted	Lighted	— ↔ —	Alternately blinking display
When unit stops	Lighted	Not lighted	00, etc.	Operation mode
When compressor is warming up	Lighted	Not lighted	08, etc.	
When unit operates	Lighted	Lighted	C5, H7 etc.	

(2)Abnormal condition

Indication		Error		
Outdoor controller board		Contents	Error code *1	Inspection method
LED1 (Green)	LED2 (Red)			
1 blinking	2 blinking	Connector(63L) is open.	F3	①Check if connector (63H or 63L) on the outdoor controller board is not disconnected. ②Check continuity of pressure switch (63H or 63L) by tester.
		Connector(63H) is open.	F5	
		2 connectors are open.	F9	
2 blinking	1 blinking	Miswiring of I/F or FTC or outdoor unit connecting wire, excessive number of indoor units (4 units or more)	—	①Check if I/F or FTC or outdoor connecting wire is connected correctly. ②Check if 4 or more I/F or FTC units are connected to outdoor unit. ③Check if noise entered into I/F or FTC or outdoor connecting wire or power supply. ④Re-check error by turning off power, and on again.
		Miswiring of I/F or FTC or outdoor unit connecting wire (converse wiring or disconnection)	—	
		Startup time over	—	
2 blinking	2 blinking	I/F or FTC or outdoor unit communication error (signal receiving error) is detected by FTC unit.	E6	①Check if I/F or FTC or outdoor connecting wire is connected correctly. ②Check if noise entered into I/F or FTC or outdoor connecting wire or power supply. ③Check if noise entered into I/F or FTC or outdoor controller board. ④Re-check error by turning off power, and on again.
		I/F or FTC or outdoor unit communication error (signal receiving error) is detected by outdoor unit.	(E8)	
		I/F or FTC or outdoor unit communication error (transmitting error) is detected by outdoor unit.	(E9)	
3 blinking	3 blinking	Remote controller signal receiving error is detected by remote controller.	E0	①Check if connecting wire of I/F or FTC unit or remote controller is connected correctly. ②Check if noise entered into transmission wire of remote controller. ③Re-check error by turning off power, and on again.
		Remote controller transmitting error is detected by remote controller.	E3	
		Remote controller signal receiving error is detected by I/F or FTC unit.	E4	
		Remote controller transmitting error is detected by I/F or FTC unit.	E5	
4 blinking	4 blinking	Error code is not defined.	EF	①Check if noise entered into transmission wire of remote controller. ②Check if noise entered into I/F or FTC or outdoor connecting wire. ③Re-check error by turning off power, and on again.

\*1 Error code displayed on remote controller

\*2 Refer to Technical manual of ATW, I/F, FTC.



Indication		Error			
Outdoor controller board		Contents	Error code *1	Inspection method	
LED1 (Green)	LED2 (Red)				
3 blinking	1 blinking	Abnormality of shell thermostat and discharging temperature (TH4)	U2	①Check if stop valves are open. ②Check if connectors (TH4, LEV-A, and LEV-B) on outdoor controller board are not disconnected. ③Check if unit is filled with specified amount of refrigerant. ④Measure resistance values among terminals on indoor valve and outdoor linear expansion valve using a tester.	
		Abnormality of superheat due to low discharge temperature	U7		
	2 blinking	Abnormal high pressure (High pressure switch 63H operated.)	U1	①Check if outdoor unit have a short cycle on their air ducts. ②Check if connector(63H)(63L) on outdoor controller board is not disconnected. ③Check if heat exchanger and filter is not dirty. ④Measure resistance values among terminals on linear expansion valve using a tester.	
		Abnormal low pressure (Low pressure switch 63L operated.)	UL		
	3 blinking	Abnormality of outdoor fan motor rotational speed	U8	①Check the outdoor fan motor. ②Check if connector (TH3) (63HS) on outdoor controller board is disconnected.	
		Protection from overheat operation (TH3), (T <sub>63HS</sub> )	Ud		
	4 blinking	Compressor overcurrent breaking(Start-up locked)	Compressor overcurrent breaking	UF	①Check if stop valves are open. ②Check looseness, disconnection, and converse connection of compressor wiring. ③Measure resistance values among terminals on compressor using a tester. ④Check if outdoor unit has a short cycle on its air duct.
			Compressor overcurrent breaking	UP	
			Abnormality of current sensor (P.B.)	UH	
			Abnormality of power module	U6	
	5 blinking	Open/short of discharge thermistor (TH4)	Open/short of outdoor thermistors (TH3, TH32, TH6, TH7 and TH8)	U3	①Check if connectors(TH3,TH32,TH4, and TH7/6)on outdoor controller board and connector (CN3) on outdoor power board are not disconnected. ②Measure resistance value of outdoor thermistors.
				U4	
	6 blinking	Abnormality of heatsink temperature	U5	①Check if outdoor unit have a short cycle on their air ducts. ②Measure resistance value of outdoor thermistor (TH8).	
7 blinking	Abnormality of voltage	U9	①Check looseness, disconnection, and converse connection of compressor wiring. ②Measure resistance value among terminals on compressor using a tester. ③Check if power supply voltage decreases.		
4 blinking	1 blinking	Abnormality of water temperature thermistor (TH1)	P1	①Check if terminal on I/F or FTC are not disconnected. ②Measure resistance value of I/F or FTC thermistors.	
		Abnormality of pipe temperature thermistor / Liquid (TH2)	P2		
		Abnormality of actual tank temperature thermistor (TH5)	P9		
	3 blinking	Freezing (cooling)/overheating (heating, heating ECO, anti freeze, hot water) protection	P6	①Check if short cycle of air path. ②Check if heat exchanger and filter is not dirty. ③Measure resistance value on outdoor fan motor. ④Check if the inside of refrigerant piping is not clogged.	

\*1 Error code displayed on remote controller

\*2 Refer to Technical manual of ATW, I/F and FTC.

**<Outdoor unit operation monitor function>**

[When optional part "A-Control Service Tool (PAC-SK52ST)" is connected to outdoor controller board (CNM)]

Digital indicator LED1 displays 2 digit number or code to inform operation condition and the meaning of error code by controlling DIP SW2 on "A-Control Service Tool".



Operation indicator SW2 : Indicator change of self diagnosis

SW2 setting	Display detail	Explanation for display	Unit																																																						
	<p><b>&lt;Digital indicator LED1 working details&gt;</b>                      (Be sure that 1 to 6 in the SW2 are set to OFF.)</p> <p>(1) Display when the power supply ON                      When the power supply ON, blinking displays by turns.                      Wait for 4 minutes at the longest.</p> <p>(2) When the display lights (Normal operation)</p> <p>① Operation mode display.</p> <div style="display: flex; align-items: center;"> <div style="text-align: center;"> <p>LED1</p> </div> <div style="margin-left: 20px;"> <p>(Lighting)</p> </div> </div> <p>The tens digit : Operation mode</p> <table border="1"> <thead> <tr> <th>Display</th> <th>Operation Model</th> </tr> </thead> <tbody> <tr> <td>O</td> <td>OFF / FAN</td> </tr> <tr> <td>C</td> <td>COOLING / DRY *</td> </tr> <tr> <td>H</td> <td>HEATING</td> </tr> <tr> <td>d</td> <td>DEFROSTING</td> </tr> </tbody> </table> <p>* C5 is displayed during replacement operation.</p> <p>② Display during error postponement                      Postponement code is displayed when compressor stops due to the work of protection device.                      Postponement code is displayed while error is being postponed.</p> <p>(3) When the display blinks                      Inspection code is displayed when compressor stops due to the work of protection devices.</p> <table border="1"> <thead> <tr> <th>Display</th> <th>Contents to be inspected (During operation)</th> </tr> </thead> <tbody> <tr><td>U1</td><td>Abnormal high pressure (63H operated)</td></tr> <tr><td>U2</td><td>Abnormal high discharging temperature, shortage of refrigerant</td></tr> <tr><td>U3</td><td>Open/short circuit of discharging thermistor (TH4)</td></tr> <tr><td>U4</td><td>Open/short of outdoor unit thermistors (TH3, TH32, TH6, TH7 and TH8)</td></tr> <tr><td>U5</td><td>Abnormal temperature of heatsink</td></tr> <tr><td>U6</td><td>Abnormality of power module</td></tr> <tr><td>U7</td><td>Abnormality of superheat due to low discharge temperature</td></tr> <tr><td>U8</td><td>Abnormality in outdoor fan motor</td></tr> <tr><td>Ud</td><td>Overheat protection</td></tr> <tr><td>UF</td><td>Compressor overcurrent interruption (When Comp. locked)</td></tr> <tr><td>UH</td><td>Current sensor error</td></tr> <tr><td>UL</td><td>Abnormal low pressure (63L operated)</td></tr> <tr><td>UP</td><td>Compressor overcurrent interruption</td></tr> <tr><td>P1~P9</td><td>Abnormality of Interface or FTC units</td></tr> </tbody> </table>	Display	Operation Model	O	OFF / FAN	C	COOLING / DRY *	H	HEATING	d	DEFROSTING	Display	Contents to be inspected (During operation)	U1	Abnormal high pressure (63H operated)	U2	Abnormal high discharging temperature, shortage of refrigerant	U3	Open/short circuit of discharging thermistor (TH4)	U4	Open/short of outdoor unit thermistors (TH3, TH32, TH6, TH7 and TH8)	U5	Abnormal temperature of heatsink	U6	Abnormality of power module	U7	Abnormality of superheat due to low discharge temperature	U8	Abnormality in outdoor fan motor	Ud	Overheat protection	UF	Compressor overcurrent interruption (When Comp. locked)	UH	Current sensor error	UL	Abnormal low pressure (63L operated)	UP	Compressor overcurrent interruption	P1~P9	Abnormality of Interface or FTC units	<p>1 second interval</p>	<p>SW2 (Initial setting)</p>														
Display	Operation Model																																																								
O	OFF / FAN																																																								
C	COOLING / DRY *																																																								
H	HEATING																																																								
d	DEFROSTING																																																								
Display	Contents to be inspected (During operation)																																																								
U1	Abnormal high pressure (63H operated)																																																								
U2	Abnormal high discharging temperature, shortage of refrigerant																																																								
U3	Open/short circuit of discharging thermistor (TH4)																																																								
U4	Open/short of outdoor unit thermistors (TH3, TH32, TH6, TH7 and TH8)																																																								
U5	Abnormal temperature of heatsink																																																								
U6	Abnormality of power module																																																								
U7	Abnormality of superheat due to low discharge temperature																																																								
U8	Abnormality in outdoor fan motor																																																								
Ud	Overheat protection																																																								
UF	Compressor overcurrent interruption (When Comp. locked)																																																								
UH	Current sensor error																																																								
UL	Abnormal low pressure (63L operated)																																																								
UP	Compressor overcurrent interruption																																																								
P1~P9	Abnormality of Interface or FTC units																																																								
	<p>The ones digit : Relay output</p> <table border="1"> <thead> <tr> <th>Display</th> <th>Warming-up Compressor</th> <th>Compressor</th> <th>4-way valve</th> <th>Solenoid valve</th> </tr> </thead> <tbody> <tr><td>0</td><td>—</td><td>—</td><td>—</td><td>—</td></tr> <tr><td>1</td><td>—</td><td>—</td><td>—</td><td>ON</td></tr> <tr><td>2</td><td>—</td><td>—</td><td>ON</td><td>—</td></tr> <tr><td>3</td><td>—</td><td>—</td><td>ON</td><td>ON</td></tr> <tr><td>4</td><td>—</td><td>ON</td><td>—</td><td>—</td></tr> <tr><td>5</td><td>—</td><td>ON</td><td>—</td><td>ON</td></tr> <tr><td>6</td><td>—</td><td>ON</td><td>ON</td><td>—</td></tr> <tr><td>7</td><td>—</td><td>ON</td><td>ON</td><td>ON</td></tr> <tr><td>8</td><td>ON</td><td>—</td><td>—</td><td>—</td></tr> <tr><td>A</td><td>ON</td><td>—</td><td>ON</td><td>—</td></tr> </tbody> </table>	Display	Warming-up Compressor	Compressor	4-way valve	Solenoid valve	0	—	—	—	—	1	—	—	—	ON	2	—	—	ON	—	3	—	—	ON	ON	4	—	ON	—	—	5	—	ON	—	ON	6	—	ON	ON	—	7	—	ON	ON	ON	8	ON	—	—	—	A	ON	—	ON	—	
Display	Warming-up Compressor	Compressor	4-way valve	Solenoid valve																																																					
0	—	—	—	—																																																					
1	—	—	—	ON																																																					
2	—	—	ON	—																																																					
3	—	—	ON	ON																																																					
4	—	ON	—	—																																																					
5	—	ON	—	ON																																																					
6	—	ON	ON	—																																																					
7	—	ON	ON	ON																																																					
8	ON	—	—	—																																																					
A	ON	—	ON	—																																																					
	<table border="1"> <thead> <tr> <th>Display</th> <th>Inspection unit</th> </tr> </thead> <tbody> <tr> <td>0</td> <td>Outdoor unit</td> </tr> <tr> <td>1</td> <td>Interface or FTC</td> </tr> </tbody> </table>	Display	Inspection unit	0	Outdoor unit	1	Interface or FTC																																																		
Display	Inspection unit																																																								
0	Outdoor unit																																																								
1	Interface or FTC																																																								
	<table border="1"> <thead> <tr> <th>Display</th> <th>Contents to be inspected (When power is turned on)</th> </tr> </thead> <tbody> <tr><td>F3</td><td>63L connector (red) is open.</td></tr> <tr><td>F5</td><td>63H connector(yellow) is open.</td></tr> <tr><td>F9</td><td>2 connectors(63H/63L) are open.</td></tr> <tr><td>E8</td><td>Interface or FTC/outdoor communication error (Signal receiving error) (Outdoor unit)</td></tr> <tr><td>E9</td><td>Interface or FTC/outdoor communication error (Transmitting error) (Outdoor unit)</td></tr> <tr><td>EA</td><td>Miswiring of Interface or FTC/outdoor unit connecting wire</td></tr> <tr><td>Eb</td><td>Miswiring of Interface or FTC/outdoor unit connecting wire (converse wiring or disconnection)</td></tr> <tr><td>EC</td><td>Startup time over</td></tr> <tr><td>E0~E6</td><td>Communication error except for outdoor unit</td></tr> </tbody> </table>	Display	Contents to be inspected (When power is turned on)	F3	63L connector (red) is open.	F5	63H connector(yellow) is open.	F9	2 connectors(63H/63L) are open.	E8	Interface or FTC/outdoor communication error (Signal receiving error) (Outdoor unit)	E9	Interface or FTC/outdoor communication error (Transmitting error) (Outdoor unit)	EA	Miswiring of Interface or FTC/outdoor unit connecting wire	Eb	Miswiring of Interface or FTC/outdoor unit connecting wire (converse wiring or disconnection)	EC	Startup time over	E0~E6	Communication error except for outdoor unit																																				
Display	Contents to be inspected (When power is turned on)																																																								
F3	63L connector (red) is open.																																																								
F5	63H connector(yellow) is open.																																																								
F9	2 connectors(63H/63L) are open.																																																								
E8	Interface or FTC/outdoor communication error (Signal receiving error) (Outdoor unit)																																																								
E9	Interface or FTC/outdoor communication error (Transmitting error) (Outdoor unit)																																																								
EA	Miswiring of Interface or FTC/outdoor unit connecting wire																																																								
Eb	Miswiring of Interface or FTC/outdoor unit connecting wire (converse wiring or disconnection)																																																								
EC	Startup time over																																																								
E0~E6	Communication error except for outdoor unit																																																								



SW2 setting	Display detail	Explanation for display	Unit
	Pipe temperature / Liquid (TH3) -40~90	-40~90 (When the coil thermistor detects 0°C or below, “-” and temperature are displayed by turns.) (Example) When -10°C; 0.5 secs. 0.5secs. 2 secs. -□ → 10 → □□	°C
	Discharge temperature (TH4) 3~217	3~217 (When the discharge thermistor detects 100°C or more, hundreds digit, tens digit and ones digit are displayed by turns.) (Example) When 105°C; 0.5 secs. 0.5secs. 2 secs. □1 → 05 → □□	°C
	Output step of outdoor FAN 0~10	0~10	Step
	The number of ON / OFF times of compressor 0~9999	0~9999 (When the number of times is 100 or more, hundreds digit, tens digit and ones digit are displayed by turns.) (Example) When 42500 times (425 × 100 times); 0.5 secs. 0.5secs. 2 secs. □4 → 25 → □□	100 times
	Compressor integrating operation times 0~9999	0~9999 (When it is 100 hours or more, hundreds digit, tens digit and ones digit are displayed by turns.) (Example) When 2450 hours (245 × 10 hours); 0.5 secs. 0.5secs. 2 secs. □2 → 45 → □□	10 hours
	Compressor operating current 0~50	0~50 * Omit the figures after the decimal fractions.	A
	Compressor operating frequency 0~225	0~255 (When it is 100Hz or more, hundreds digit, tens digit and ones digit are displayed by turns.) (Example) When 125Hz; 0.5 secs. 0.5secs. 2 secs. □1 → 25 → □□	Hz
	LEV-A opening pulse 0~480	0~480 (When it is 100 pulse or more, hundreds digit, tens digit and ones digit are displayed by turns.) (Example) When 150 pulse; 0.5 secs. 0.5secs. 2 secs. □1 → 50 → □□	Pulse
	Error postponement code history (1) of outdoor unit	Postponement code display Blinking: During postponement Lighting: Cancellation of postponement “00” is displayed in case of no postponement.	Code display
	Operation mode on error occurring	Operation mode of when operation stops due to error is displayed by setting SW2 like below.  (SW2)	Code display

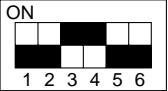
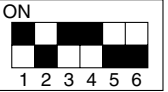
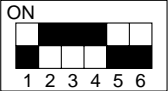
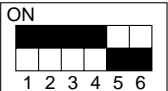

SW2 setting	Display detail	Explanation for display	Unit
	Pipe temperature / Liquid (TH3) on error occurring -40~90	-40~90 (When the coil thermistor detects 0°C or below, “-” and temperature are displayed by turns.) (Example) When -15°C; 0.5 secs. 0.5secs. 2 secs. -□ → 15 → □□	°C
	Compressor temperature (TH4) or discharge temperature (TH4) on error occurring 3~217	3~217 (When the temperature is 100°C or more, the hundreds digit, tens digit and ones digit are displayed by turns.) (Example) When 130°C; 0.5 secs. 0.5secs. 2 secs. □1 → 30 → □□	°C
	Compressor operating current on error occurring 0~20	0~20	A
	Error code history (1) (latest) Alternate display of abnormal unit number and code	When no error history, “ 0 ” and “ - - ” are displayed by turns.	Code display
	Error code history (2) Alternate display of error unit number and code	When no error history, “ 0 ” and “ - - ” are displayed by turns.	Code display
	Thermo ON time 0~999	0~999 (When it is 100 minutes or more, the hundreds digit, tens digit and ones digit are displayed by turns.) (Example) When 245 minutes; 0.5 secs. 0.5secs. 2 secs. □2 → 45 → □□	Minute
	Test run elapsed time 0~120	0~120 (When it is 100 minutes or more, the hundreds digit, tens digit and ones digit are displayed by turns.) (Example) When 105 minutes; 0.5 secs. 0.5secs. 2 secs. □1 → 05 → □□	Minute





SW2 setting	Display detail	Explanation for display	Unit										
	The number of connected indoor units	0~3 (The number of connected indoor units are displayed.)	Unit										
	Capacity setting display	Displayed as an outdoor capacity code. <table border="1"> <tr> <td>Model</td> <td>Code</td> </tr> <tr> <td>HRP200</td> <td>40</td> </tr> </table>	Model	Code	HRP200	40	Code display						
Model	Code												
HRP200	40												
	Outdoor unit setting information	<ul style="list-style-type: none"> <li>The tens digit (Total display for applied setting) <table border="1"> <tr> <th>Setting details</th> <th>Display details</th> </tr> <tr> <td>H·P / Cooling only</td> <td>0 : H·P      1 : Cooling only</td> </tr> <tr> <td>Single phase / 3 phase</td> <td>0 : Single phase    2 : 3 phase</td> </tr> </table> </li> <li>The ones digit <table border="1"> <tr> <th>Setting details</th> <th>Display details</th> </tr> <tr> <td>Defrosting switch</td> <td>0 : Normal      1 : For high humidity</td> </tr> </table> </li> </ul> <p>(Example) When heat pump, 3 phase and defrosting (normal) are set up, "20" is displayed.</p>	Setting details	Display details	H·P / Cooling only	0 : H·P      1 : Cooling only	Single phase / 3 phase	0 : Single phase    2 : 3 phase	Setting details	Display details	Defrosting switch	0 : Normal      1 : For high humidity	Code display
Setting details	Display details												
H·P / Cooling only	0 : H·P      1 : Cooling only												
Single phase / 3 phase	0 : Single phase    2 : 3 phase												
Setting details	Display details												
Defrosting switch	0 : Normal      1 : For high humidity												
	Pipe temperature / Liquid (TH2) -39~88	-39~88 (When the temperature is 0°C or less, "-" and temperature are displayed by turns.)	°C										
	Actual flow water temperature (TH1) 8~39	8~39	°C										



SW2 setting	Display detail	Explanation for display	Unit
	Pressure saturation temperature (T <sub>63HS</sub> ) -39~88	-39~88 (When the temperature is 0°C or less, “-” and temperature are displayed by turns.)	°C
	Ambient temperature (TH7) -39~88	-39~88 (When the temperature is 0°C or less, “-” and temperature are displayed by turns.)	°C
	Outdoor heatsink temperature (TH8) -40~200	-40~200 (When the temperature is 0°C or less, “-” and temperature are displayed by turns.) (When the thermistor detects 100°C or more, hundreds digit, tens digit and ones digit are displayed by turns.)	°C
	Discharge superheat SHd 0~255 [Cooling = TH4-T <sub>63HS</sub> Heating = TH4-T <sub>63HS</sub> ]	0~255 (When the temperature is 100°C or more, hundreds digit, tens digit and ones digit are displayed by turns.)	°C
	Sub cool. SC 0~130 [Cooling = T <sub>63HS</sub> -TH3 Heating = T <sub>63HS</sub> -TH2]	0~130 (When the temperature is 100°C or more, hundreds digit, tens digit and ones digit are displayed by turns.)	°C
	<From 17U***** (unit No.) onward> Number of defrost cycles 0 – FFFE	0 – FFFE (in hexadecimal notation) (When more than FF in hex (255 in decimal), the number is displayed in order of 16 <sup>3</sup> 's and 16 <sup>2</sup> 's, and 16 <sup>1</sup> 's and 16 <sup>0</sup> 's places. (Example) When 5000 cycles; 0.5 secs. 0.5 secs. 2 secs. <div style="text-align: center;"> <span style="border: 1px solid black; padding: 2px;">9</span> → C4 → <span style="border: 1px solid black; padding: 2px;">  </span> </div>	2 cycles
	Input current of outdoor unit	0~500 (When it is 100 or more, hundreds digit, tens digit and ones digit are displayed by turns.)	0.1 A
	LEV-B opening pulse 0~480	0~480 (When it is 100 pulse or more, hundreds digit, tens digit and ones digit are displayed by turns.)	Pulse
	Targeted operation frequency 0~255	0~255 (When it is 100Hz or more, hundreds digit, tens digit and ones digit are displayed by turns.)	Hz
	DC bus voltage 180~370	180~370 (When it is 100V or more, hundreds digit, tens digit and ones digit are displayed by turns.)	V

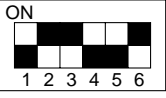
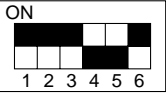
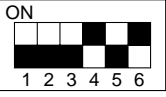
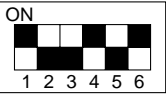
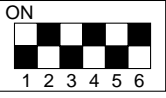

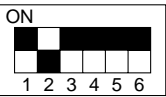
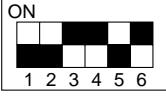
SW2 setting	Display detail	Explanation for display	Unit
	Capacity save 0~255 [ When there is no setting of capacity save "100" is displayed. ]	0~255 (When the capacity is 100% hundreds digit, tens digit and ones digit are displayed by turns.) (Example) When 100%; 0.5 secs.    0.5secs.    2 secs. □1        → 00        → □□	%
	Error postponement code history (2) of outdoor unit	Postponement code display Blinking: During postponement Lighting: Cancellation of postponement "00" is displayed in case of no postponement.	Code display
	Error postponement code history (3) of outdoor unit	Postponement code display Blinking: During postponement Lighting: Cancellation of postponement "00" is displayed in case of no postponement.	Code display
	Error code history (3) (Oldest) Alternate display of abnormal unit number and code	When no error history, "0" and "--" are displayed by turns.	Code display
	Error thermistor display [ When there is no error thermistor, "--" is displayed. ]	3: Liquid pipe thermistor (TH3) 6: 2-phase pipe thermistor (TH6) 7: Ambient temp. thermistor (TH7) 8: Heatsink thermistor (TH8) 32: Suction pipe thermistor (TH32)	Code display
	Operation frequency on error occurring 0~255	0~255 (When it is 100Hz or more, hundreds digit, tens digit and ones digit are displayed by turns.) (Example) When 125Hz; 0.5 secs.    0.5secs.    2 secs. □1        → 25        → □□	Hz
	Fan step on error occurring 0~10	0~10	Step
	Outdoor pipe temperature (TH33) -39~88	-39~88 (When the temperature is 0°C or less, "--" and temperature are displayed by turns.)	°C
	LEV-A opening pulse on error occurring 0~480	0~480 (When it is 100 pulse or more, hundreds digit, tens digit and ones digit are displayed by turns.) (Example) When 130 pulse; 0.5 secs.    0.5secs.    2 secs. □1        → 30        → □□	Pulse

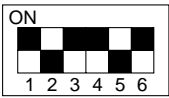
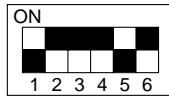
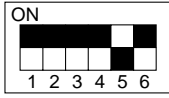
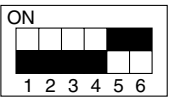
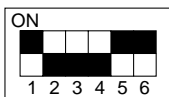
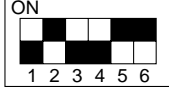
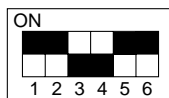
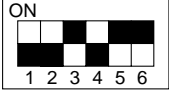

SW2 setting	Display detail	Explanation for display	Unit
	Actual water temperature (TH1) on error occurring 8~39	8~39	°C
	Pipe temperature / Liquid (TH2) on error occurring -39~88	-39~88 (When the temperature is 0°C or less, “-” and temperature are displayed by turns.) (Example) When -15°C; 0.5 secs. 0.5secs. 2 secs. -□ → 15 → □□	°C
	Pressure saturation temperature (T <sub>63HS</sub> ) on error occurring -39~88	-39~88 (When the temperature is 0°C or less, “-” and temperature are displayed by turns.) (Example) When -15°C; 0.5 secs. 0.5secs. 2 secs. -□ → 15 → □□	°C
	Outdoor pipe temperature / 2-phase. (TH6) on error occurring -39~88	-39~88 (When the temperature is 0°C or less, “-” and temperature are displayed by turns.) (Example) When -15°C; 0.5 secs. 0.5secs. 2 secs. -□ → 15 → □□	°C
	Outdoor outside temperature (TH7) on error occurring -39~88	-39~88 (When the temperature is 0°C or less, “-” and temperature are displayed by turns.) (Example) When -15°C; 0.5 secs. 0.5secs. 2 secs. -□ → 15 → □□	°C
	Outdoor heatsink temperature (TH8) on error occurring -40~200	-40~200 (When the temperature is 0°C or less, “-” and temperature are displayed by turns.) (When the temperature is 100°C or more, hundreds digit, tens digit and ones digit are displayed by turns.)	°C
	Discharge superheat on error occurring SHd 0~255 [Cooling = TH4-T <sub>63HS</sub> ] [Heating = TH4-T <sub>63HS</sub> ]	0~255 (When the temperature is 100°C or more, hundreds digit, tens digit and ones digit are displayed by turns.) (Example) When 150°C; 0.5 secs. 0.5secs. 2 secs. □1 → 50 → □□	°C
	Sub cool on error occurring SC 0~130 [Cooling = T <sub>63HS</sub> -TH3] [Heating = T <sub>63HS</sub> -TH2]	0~130 (When the temperature is 100°C or more, hundreds digit, tens digit and ones digit are displayed by turns.) (Example) When 115°C; 0.5 secs. 0.5secs. 2 secs. □1 → 15 → □□	°C



SW2 setting	Display detail	Explanation for display	Unit																			
	Thermo-on time until error stops 0~999	0~999 (When it is 100 minutes or more, hundreds digit, tens digit and ones digit are displayed by turns.) (Example) When 415 minutes; 0.5 secs. 0.5secs. 2 secs. 	Minute																			
	Pipe temperature / Liquid (TH2 (3)) Indoor 3 -39~88	-39~88 (When the temperature is 0°C or less, “-” and temperature are displayed by turns.)	°C																			
	Replacement operation * If replacement operation is conducted even once, “1” is displayed. If replacement operation time is less than 2 hrs. “0” is displayed.	1: Conducted. 0: Not yet.	-																			
	U9 Error status during the Error postponement period	<table border="1"> <thead> <tr> <th>Description</th> <th>Detection point</th> <th>Display</th> </tr> </thead> <tbody> <tr> <td>Normal</td> <td>—</td> <td>00</td> </tr> <tr> <td>Overtoltage error</td> <td>Power circuit board</td> <td>01</td> </tr> <tr> <td>Undervoltage error</td> <td>Controller circuit board</td> <td>02</td> </tr> <tr> <td>Input current sensor error</td> <td rowspan="2">Controller circuit board</td> <td rowspan="2">04</td> </tr> <tr> <td>L<sub>1</sub>-phase open error</td> </tr> <tr> <td>Abnormal power synchronous signal</td> <td>Power circuit board</td> <td>08</td> </tr> </tbody> </table> <p>Display examples for multiple errors:            Overtoltage (01) + Undervoltage (02) = 03            Undervoltage (02) + Power-sync signal error (08) = 0A</p>	Description	Detection point	Display	Normal	—	00	Overtoltage error	Power circuit board	01	Undervoltage error	Controller circuit board	02	Input current sensor error	Controller circuit board	04	L <sub>1</sub> -phase open error	Abnormal power synchronous signal	Power circuit board	08	Code display
Description	Detection point	Display																				
Normal	—	00																				
Overtoltage error	Power circuit board	01																				
Undervoltage error	Controller circuit board	02																				
Input current sensor error	Controller circuit board	04																				
L <sub>1</sub> -phase open error																						
Abnormal power synchronous signal	Power circuit board	08																				
	Controlling status of compressor operating frequency	The following code will be a help to know the operating status of unit. •The tens digit <table border="1"> <thead> <tr> <th>Display</th> <th>Compressor operating frequency control</th> </tr> </thead> <tbody> <tr> <td>1</td> <td>Primary current control</td> </tr> <tr> <td>2</td> <td>Secondary current control</td> </tr> </tbody> </table> •The ones digit (In this digit, the total number of activated control is displayed.) <table border="1"> <thead> <tr> <th>Display</th> <th>Compressor operating frequency control</th> </tr> </thead> <tbody> <tr> <td>1</td> <td>Preventive control for excessive temperature rise of discharge temperature</td> </tr> <tr> <td>2</td> <td>Preventive control for excessive temperature rise of condensing temperature</td> </tr> <tr> <td>4</td> <td>Frosting preventing control</td> </tr> <tr> <td>8</td> <td>Preventive control for excessive temperature rise of radiator panel</td> </tr> </tbody> </table> (Example) The following controls are activated. • Primary current control • Preventive control for excessive temperature rise of condensing temperature • Preventive control for excessive temperature rise of heatsink	Display	Compressor operating frequency control	1	Primary current control	2	Secondary current control	Display	Compressor operating frequency control	1	Preventive control for excessive temperature rise of discharge temperature	2	Preventive control for excessive temperature rise of condensing temperature	4	Frosting preventing control	8	Preventive control for excessive temperature rise of radiator panel	Code display			
Display	Compressor operating frequency control																					
1	Primary current control																					
2	Secondary current control																					
Display	Compressor operating frequency control																					
1	Preventive control for excessive temperature rise of discharge temperature																					
2	Preventive control for excessive temperature rise of condensing temperature																					
4	Frosting preventing control																					
8	Preventive control for excessive temperature rise of radiator panel																					
	LEV-C opening pulse 0~480	0~480 (When it is 100 pulse or more, hundreds digit, tens digit and ones digit are displayed by turns.)	Pulse																			

## PUHZ-HRP200YKA

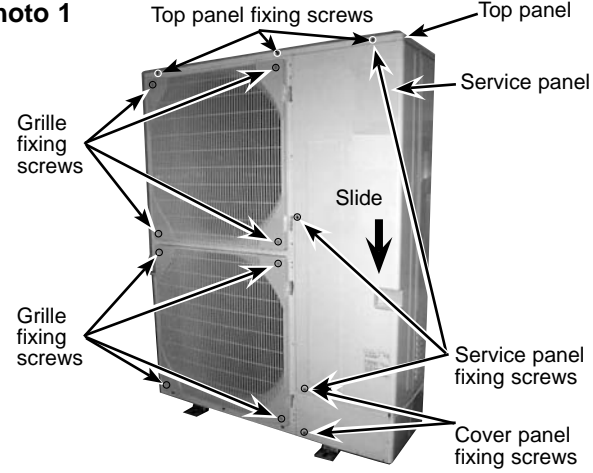
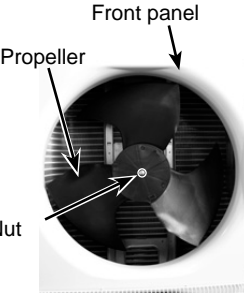
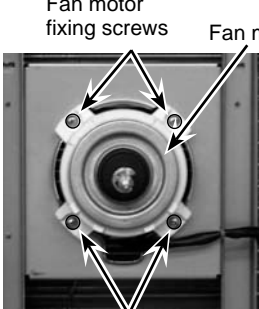
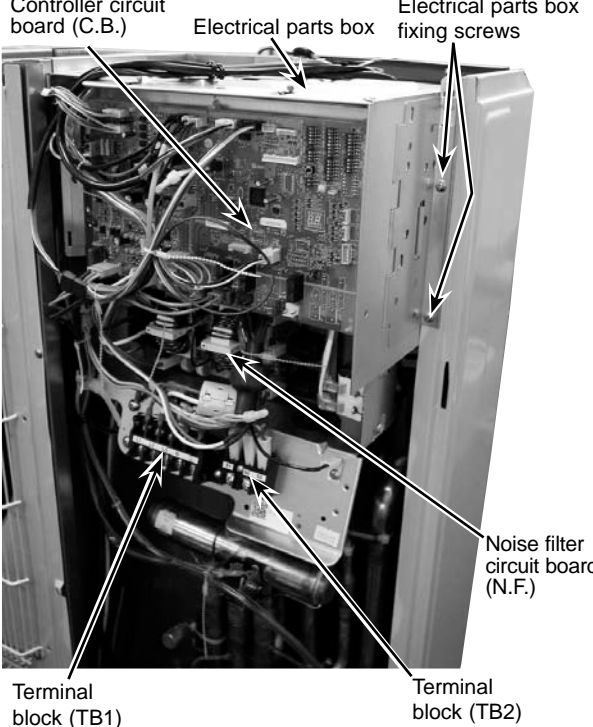
OPERATING PROCEDURE	PHOTOS & ILLUSTRATION
<p><b>1. Removing the service panel and top panel</b></p> <p>(1) Remove 3 service panel fixing screws (5 × 12) and slide the hook on the right downward to remove the service panel.</p> <p>(2) Remove screws (3 for front, 3 for rear/5 × 12) of the top panel and remove it.</p>	<p><b>Photo 1</b></p> 
<p><b>2. Removing the fan motor (MF1, MF2)</b></p> <p>(1) Remove the service panel. (See Photo 1)</p> <p>(2) Remove the top panel. (See Photo 1)</p> <p>(3) Remove 4 fan grille fixing screws (5 × 12) to detach the fan grille. (See Photo 1)</p> <p>(4) Remove a nut (for right handed screw of M6) to detach the propeller. (See Photo 2)</p> <p>(5) Disconnect the connectors, CNF1, CNF2 on controller circuit board in electrical parts box.</p> <p>(6) Remove 4 fan motor fixing screws (5 × 20) to detach the fan motor. (See Photo 3)</p>	<p><b>Photo 2</b></p>  <p><b>Photo 3</b></p> 
<p><b>3. Removing the electrical parts box</b></p> <p>(1) Remove the service panel. (See Photo 1)</p> <p>(2) Remove the top panel. (See Photo 1)</p> <p>(3) Disconnect the connecting wires from terminal block.</p> <p>(4) Disconnect the connectors on the controller circuit board.</p> <p>(5) Remove the terminal cover and disconnect the compressor lead wire.</p> <p>(6) Remove 2 electrical parts box fixing screws (4 × 10) and detach the electrical parts box by pulling it upward. The electrical parts box is fixed with 2 hooks on the left and 1 hook on the right.</p>	<p><b>Photo 4</b></p> 

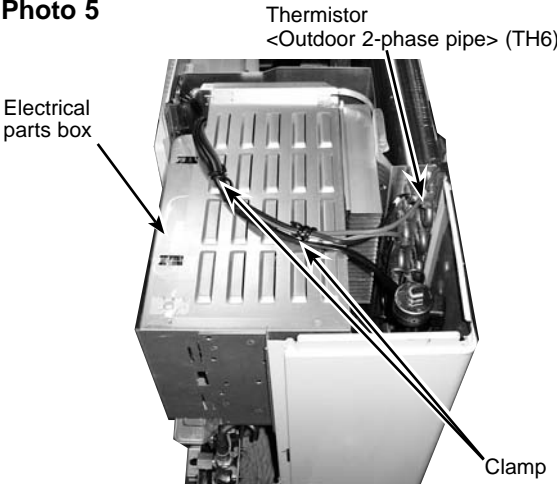
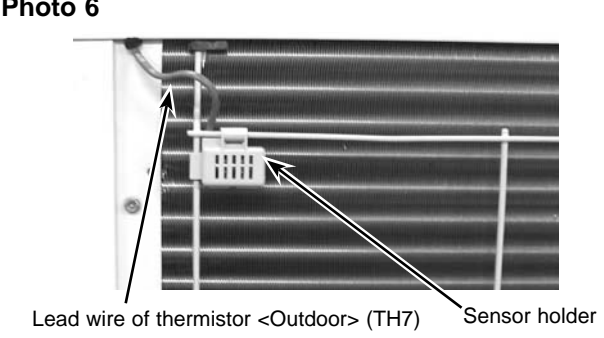
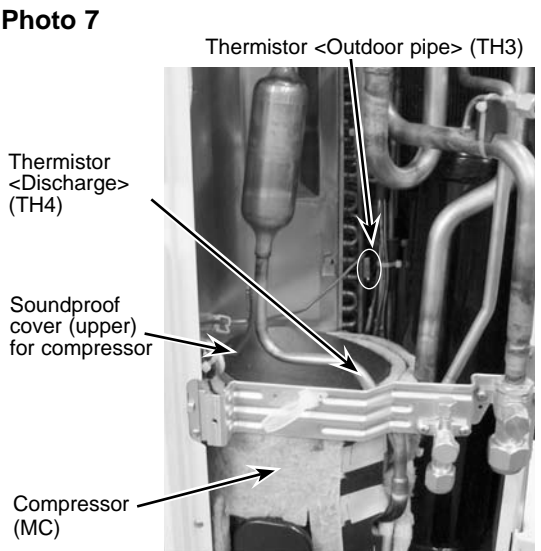

OPERATING PROCEDURE	PHOTOS
<p><b>4. Removing the thermistor &lt;Outdoor 2-phase pipe&gt; (TH6)</b></p> <ol style="list-style-type: none"> <li>(1) Remove the service panel. (See Photo 1)</li> <li>(2) Remove the top panel. (See Photo 1)</li> <li>(3) Disconnect the connectors, TH6 and TH7 (red), on the controller circuit board in the electrical parts box.</li> <li>(4) Loosen the 2 wire clamps on top of the electrical parts box.</li> <li>(5) Pull out the thermistor &lt;Outdoor 2-phase pipe&gt; (TH6) from the sensor holder.</li> </ol> <p><b>Note: When replacing thermistor &lt;Outdoor 2-phase pipe&gt; (TH6), replace it together with thermistor &lt;Outdoor&gt; (TH7) since they are combined together. Refer to No.6 below to remove thermistor &lt;Outdoor&gt;.</b></p>	<p><b>Photo 5</b></p> 
<p><b>5. Removing the thermistor &lt;Outdoor&gt; (TH7)</b></p> <ol style="list-style-type: none"> <li>(1) Remove the service panel. (See Photo 1)</li> <li>(2) Remove the top panel. (See Photo 1)</li> <li>(3) Disconnect the connector TH7 (red) on the controller circuit board in the electrical parts box.</li> <li>(4) Loosen the 2 wire clamps on top of the electrical parts box. (See Photo 5)</li> <li>(5) Pull out the thermistor &lt;Outdoor&gt; (TH7) from the sensor holder.</li> </ol> <p><b>Note: When replacing thermistor &lt;Outdoor&gt; (TH7), replace it together with thermistor &lt;Outdoor 2-phase pipe&gt; (TH6), since they are combined together. Refer to No.5 above to remove thermistor &lt;Outdoor 2-phase pipe&gt;.</b></p>	<p><b>Photo 6</b></p> 
<p><b>6. Removing the thermistor &lt;Liquid pipe&gt; (TH3), thermistor &lt;Discharge&gt; (TH4) and thermistor &lt;Suction pipe&gt; (TH32)</b></p> <ol style="list-style-type: none"> <li>(1) Remove the service panel. (See Photo 1)</li> <li>(2) Disconnect the connectors, TH3 (white) and TH4 (white) on the controller circuit board in the electrical parts box.</li> <li>(3) Loosen the clamp for the lead wire in the rear of the electrical parts box.</li> </ol> <p><b>[Removing the thermistor&lt;Liquid pipe&gt;(TH3)]</b></p> <ol style="list-style-type: none"> <li>(4) Pull out the thermistor &lt;Liquid pipe&gt; (TH3) from the sensor holder.</li> </ol> <p><b>[Removing the thermistor&lt;Suction pipe&gt;(TH32)]</b></p> <ol style="list-style-type: none"> <li>(4) Pull out the thermistor &lt;Suction pipe&gt; (TH32) from the thermo-holder. (TH32 : See Figure 2)</li> </ol> <p><b>[Removing the thermistor&lt;Discharge&gt;(TH4)]</b></p> <ol style="list-style-type: none"> <li>(4) Pull out the thermistor &lt;Discharge&gt; (TH4) from the sensor holder.</li> </ol>	<p><b>Photo 7</b></p> 



## OPERATING PROCEDURE

### 7. Removing the 4-way valve coil (21S4) and linear expansion valve coil (LEV-A, LEV-B, LEV-C)

- (1) Remove the service panel. (See Photo 1)
- (2) Remove the top panel. (See Photo 1)
- (3) Remove the electrical parts box. (See Photo 4)

#### [Removing the 4-way valve coil]

- (4) Remove 4-way valve coil fixing screw (M4 × 6).
- (5) Remove the 4-way valve coil by sliding the coil toward you.

#### [Removing the linear expansion valve coil]

- (4) Remove 3 right side panel fixing screws (5 × 12) in the rear of the unit then remove the right side panel.
- (5) Remove the linear expansion valve coil by sliding the coil upward.

### 8. Removing the 4-way valve

- (1) Remove the service panel. (See Photo 1)
- (2) Remove the top panel. (See Photo 1)
- (3) Remove the electrical parts box. (See Photo 4)
- (4) Remove 3 valve bed fixing screws (4 × 10), 4 ball valve and stop valve fixing screws (5 × 16) then remove the valve bed.
- (5) Remove 3 right side panel fixing screws (5 × 12) in the rear of the unit then remove the right side panel.
- (6) Remove the 4-way valve coil.
- (7) Recover refrigerant.
- (8) Remove the welded part of 4-way valve.

### 9. Removing the linear expansion valve

- (1) Remove the service panel. (See Photo 1)
- (2) Remove the top panel. (See Photo 1)
- (3) Remove 3 valve bed fixing screws (4 × 10), 4 ball valve and stop valve fixing screws (5 × 16) then remove the valve bed.
- (4) Remove 3 right side panel fixing screws (5 × 12) in the rear of the unit then remove the right side panel.
- (5) Remove the linear expansion valve coil.
- (6) Recover refrigerant.
- (7) Remove the welded part of linear expansion valve.

## PHOTOS

Figure 1

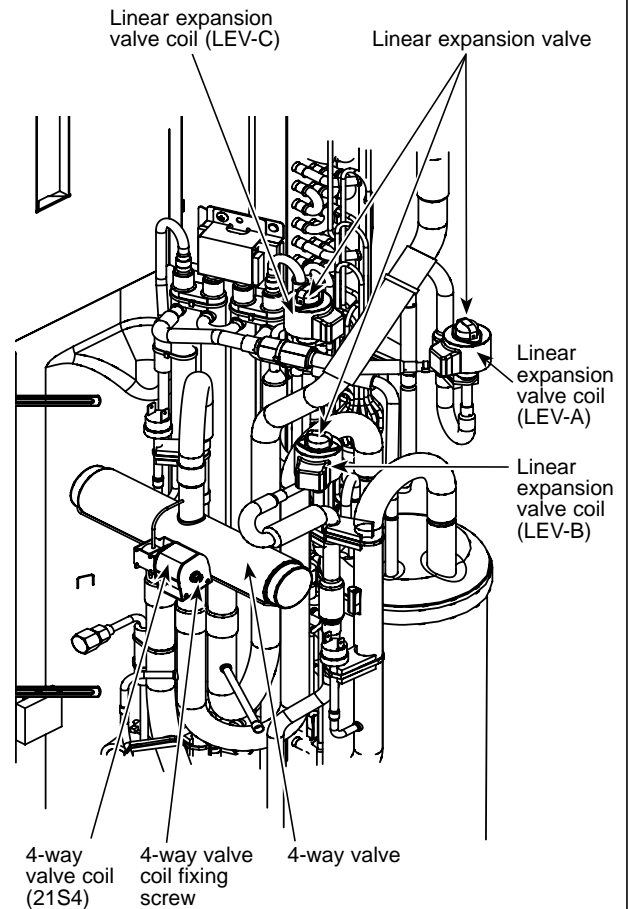

**Note 1:** Recover refrigerant without spreading it in the air.

**Note 2:** The welded part can be removed easily by removing the right side panel.

**Note 3:** When installing the parts of refrigerant circuit, cover it with a wet cloth to prevent it from heating (120°C or more), then braze the pipes so that the inside of pipes are not oxidized.

## OPERATING PROCEDURE

### 10. Removing the high pressure switch (63H) and low pressure switch (63L)

- (1) Remove the service panel. (See Photo 1)
- (2) Remove the top panel. (See Photo 1)
- (3) Remove 3 right side panel fixing screws (5 × 12) in the rear of the unit and remove the right side panel.
- (4) Pull out the lead wire of high pressure switch and low pressure switch.
- (5) Recover refrigerant.
- (6) Remove the welded part of high pressure switch and low pressure switch.

**Note 1:** Recover refrigerant without spreading it in the air.

**Note 2:** The welded part can be removed easily by removing the right side panel.

**Note 3:** When installing the parts of refrigerant circuit, cover it with a wet cloth to prevent it from heating (100°C or more), then braze the pipes so that the inside of pipes are not oxidized.

## PHOTOS

Photo 8



High pressure switch

Figure 2

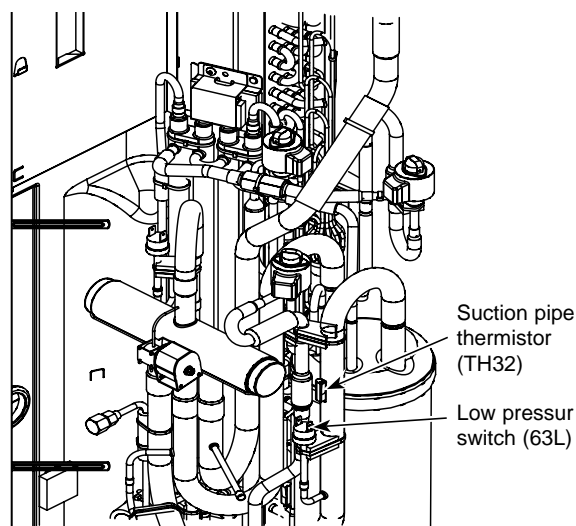

### 11. Removing the compressor (MC)

- (1) Remove the service panel. (See Photo 1)
- (2) Remove the top panel. (See Photo 1)
- (3) Remove 2 front cover panel fixing screws (5 × 12) and remove the front cover panel.
- (4) Remove 4 back cover panel fixing screws (5 × 12) and remove the back cover panel.
- (5) Remove the electrical parts box. (See Photo 4)
- (6) Remove 3 valve bed fixing screws (4 × 10), 4 ball valve and stop valve fixing screws (5 × 16), then remove the valve bed.
- (7) Remove 3 right side panel fixing screws (5 × 12) in the rear of the unit and remove the right side panel.
- (8) Remove 3 separator fixing screws (4 × 10) and remove the separator.
- (9) Remove the soundproof cover for compressor.
- (10) Remove the terminal cover and remove the compressor lead wire.
- (11) Recover refrigerant.
- (12) Remove the 3 points of the compressor fixing nut using a spanner or an adjustable wrench.
- (13) Remove the welded pipe of compressor inlet and outlet and remove the compressor.

**Note:** Recover refrigerant without spreading it in the air.

Photo 9

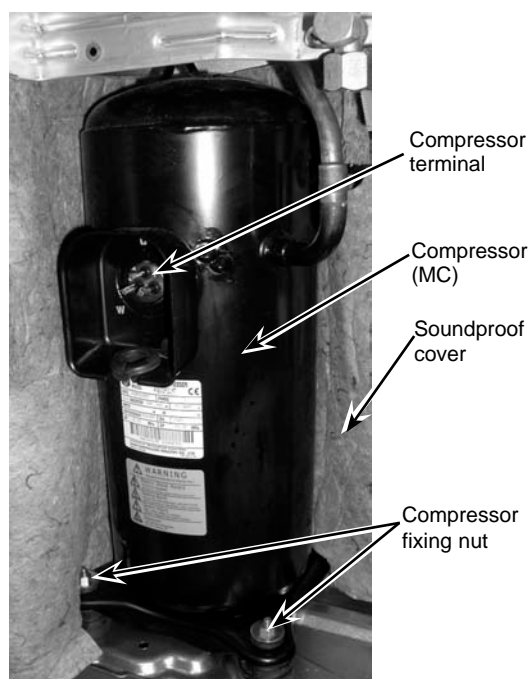

## OPERATING PROCEDURE

### 12. Removing the power receiver

- (1) Remove the service panel. (See Photo 1)
- (2) Remove the top panel. (See Photo 1)
- (3) Remove 2 front cover panel fixing screws (5 × 12) and remove the front cover panel.
- (4) Remove 4 back cover panel fixing screws (5 × 12) and remove the back cover panel.
- (5) Remove the electrical parts box. (See Photo 4)
- (6) Remove 3 valve bed fixing screws (4 × 10) and 4 ball valve and stop valve fixing screws (5 × 16) and then remove the valve bed.
- (7) Remove 3 right side panel fixing screws (5 × 12) in the rear of the unit and then remove the right side panel.
- (8) Recover refrigerant.
- (9) Remove 4 welded pipes of power receiver inlet and outlet.
- (10) Remove 2 receiver leg fixing screws (4 × 10).

**Note:** Recover refrigerant without spreading it in the air.

## PHOTOS

**Photo 10**

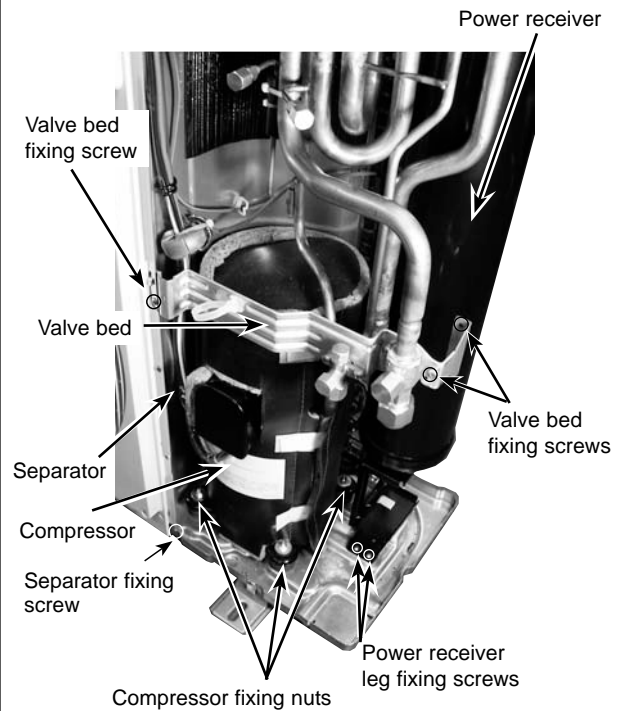

**Photo 11**

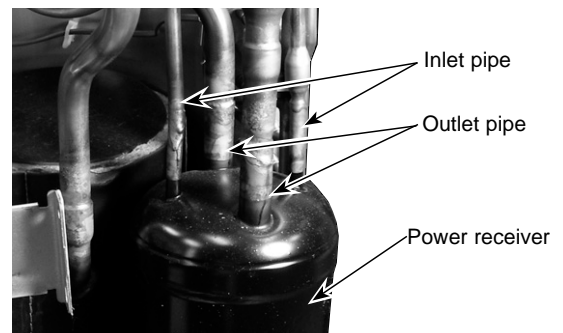

### 13. Removing the pressure sensor (63HS)

- (1) Remove the service panel. (See Photo 1)
- (2) Remove the top panel. (See Photo 1)
- (3) Pull out the lead wire of pressure sensor.
- (4) Remove the band that is fixing the rubber mount and the sensor.
- (5) Recover refrigerant.
- (6) Remove the welded part of pressure sensor.

**Note 1:** Recover refrigerant without spreading it in the air.

**Note 2:** The welded part can be removed easily by removing the right side panel.

**Note 3:** When installing the pressure sensor, make sure to cover it with a wet cloth to prevent it from heating (100°C or more), then braze the pipes so that the inside of pipes are not oxidized.

**Figure 3**

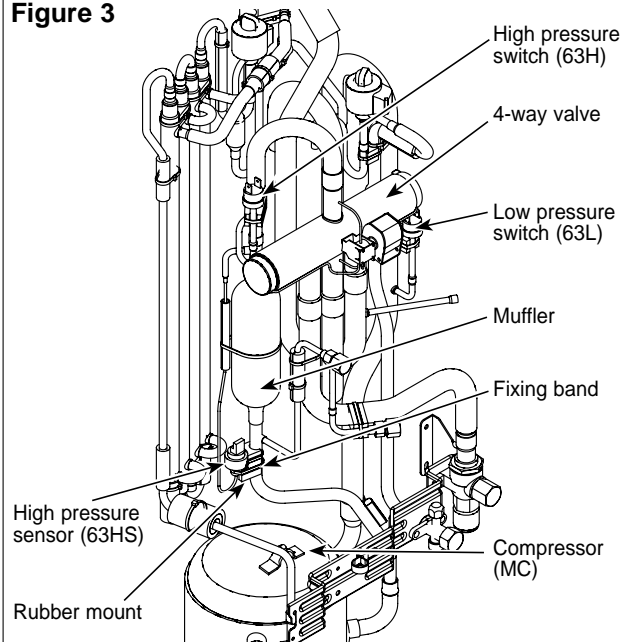

**Mr. SLIM™**

**MITSUBISHI ELECTRIC CORPORATION**

HEAD OFFICE : TOKYO BLDG., 2-7-3, MARUNOUCHI, CHIYODA-KU, TOKYO 100-8310, JAPAN