

# SERVICE MANUAL R410A

Outdoor unit  
[Model name]  
PUHZ-FRP71VHA

[Service Ref.]

## PUHZ-FRP71VHA

**Note:**

- This manual describes only service data of the outdoor units.
- RoHS compliant products have <G> mark on the spec name plate.

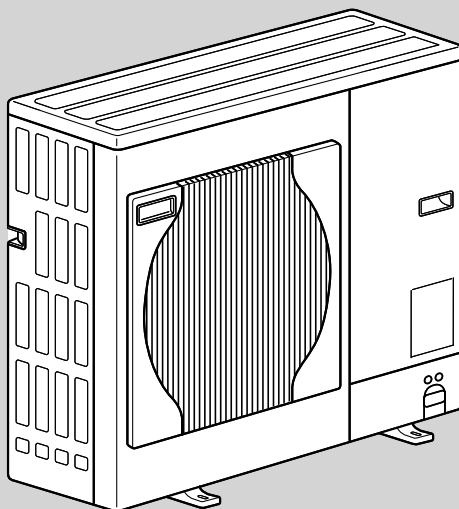

PUHZ-FRP71VHA

### CONTENTS

1. REFERENCE MANUAL .....	2...
2. SAFETY PRECAUTION .....	3...
3. FEATURES .....	7.....
4. SPECIFICATIONS .....	8.....
5. DATA .....	9.....
6. OUTLINES AND DIMENSIONS .....	11
7. WIRING DIAGRAM .....	12..
8. WIRING SPECIFICATIONS .....	13
9. REFRIGERANT SYSTEM DIAGRAM .....	15
10. TROUBLESHOOTING .....	17..
11. FUNCTION SETTING .....	71..
12. MONITORING THE OPERATION DATA BY THE REMOTE CONTROLLER .....	84
13. EASY MAINTENANCE FUNCTION .....	95
14. DISASSEMBLY PROCEDURE .....	99

PARTS CATALOG (OCB544)

## INDOOR UNIT SERVICE MANUAL

### For Air to Air system

Model name	Service Ref.	Service Manual No.
PLA-ZRP35/50/60/71/125/140BA	PLA-ZRP35/50/60/71/125/140BA.UK	OCH535 OCB535
PCA-RP35/50/60/71/100/125/140KAQ	PCA-RP35/100/125/140KAQ PCA-RP50/60/71KAQR1	OCH491 OCB491
PCA-RP71/125HAQ	PCA-RP71/125HAQ	OCH492 OCB492
PKA-RP35/50HAL	PKA-RP35/50HAL	OCH453 OCB453
PKA-RP60/71/100KAL	PKA-RP60/71/100KAL	OCH452 OCB452
PSA-RP71/100/125/140KA	PSA-RP71/100/125/140KA	OCH528 OCB528
PEAD-RP35/50/60/71/100/125/140JA(L)Q	PEAD-RP35/50/60/71/100/125/140JA(L)QR1.UK	HWE10090 BWE10160

### For Air to Water system

Model name	Service ref.	Service manual No.
EHST20C-VM6HB EHST20C-YM9HB EHST20C-TM9HB EHST20C-VM2B EHST20C-VM6B EHST20C-YM9B EHST20C-VM6EB EHST20C-YM9EB EHST20C-VM6SB EHPT20X-VM2HB EHPT20X-VM6HB EHPT20X-YM9HB EHPT20X-TM9HB EHPT20X-VM6B EHPT20X-YM9B	EHST20C-VM6HB.UK EHST20C-YM9HB.UK EHST20C-TM9HB.UK EHST20C-VM2B.UK EHST20C-VM6B.UK EHST20C-YM9B.UK EHST20C-VM6EB.UK EHST20C-YM9EB.UK EHST20C-VM6SB.UK EHPT20X-VM2HB.UK EHPT20X-VM6HB.UK EHPT20X-YM9HB.UK EHPT20X-TM9HB.UK EHPT20X-VM6B.UK EHPT20X-YM9B.UK	OCH531
EHSC-VM2B EHSC-VM6B EHSC-YM9B EHSC-TM9B EHSC-VM6EB EHSC-YM9EB EHPX-VM2B EHPX-VM6B EHPX-YM9B ERSC-VM2B	EHSC-VM2B.UK EHSC-VM6B.UK EHSC-YM9B.UK EHSC-TM9B.UK EHSC-VM6EB.UK EHSC-YM9EB.UK EHPX-VM2B.UK EHPX-VM6B.UK EHPX-YM9B.UK ERSC-VM2B.UK	OCH532

## 2-1. ALWAYS OBSERVE FOR SAFETY

**Before obtaining access to terminal, all supply circuits must be disconnected.**

## 2-2. CAUTIONS RELATED TO NEW REFRIGERANT

### Cautions for units utilizing refrigerant R410A

#### Preparation before the repair service.

- Prepare the proper tools.
- Prepare the proper protectors.
- Provide adequate ventilation.
- After stopping the operation of the air conditioner, turn off the power-supply beaker.
- Discharge the condenser before the work involving the electric parts.

#### Precautions during the repair service.

- Do not perform the work involving the electric parts with wet hands.
- Do not pour water into the electric parts.
- Do not touch the refrigerant.
- Do not touch the hot or cold areas in the refrigerating cycle.
- When the repair or the inspection of the circuit needs to be done without turning off the power, exercise great caution not to touch the live parts.

#### Use new refrigerant pipes.

In case of using the existing pipes for R22, be careful with the followings.

- Be sure to clean the pipes and make sure that the insides of the pipes are clean.
- Change flare nut to the one provided with this product. Use a newly flared pipe.
- Avoid using thin pipes.

**Make sure that the inside and outside of refrigerant piping is clean and it has no contaminants such as sulfur, oxides, dirt, shaving particles, etc, which are hazard to refrigerant cycle. In addition, use pipes with specified thickness.**

Contamination inside refrigerant piping can cause deterioration of refrigerant oil etc.

**Store the piping indoors, and both ends of the piping sealed until just before brazing. (Leave elbow joints, etc. in their packaging.)**

If dirt, dust or moisture enters into refrigerant cycle, that can cause deterioration of refrigerant oil or malfunction of compressor.

**The refrigerant oil applied to flare and flange connections must be ester oil, ether oil or alkylbenzene oil in a small amount.**

If large amount of mineral oil enters, that can cause deterioration of refrigerant oil etc.

**Charge refrigerant from liquid phase of gas cylinder.**

If the refrigerant is charged from gas phase, composition change may occur in refrigerant and the efficiency will be lowered.

**Do not use refrigerant other than R410A.**

If other refrigerant (R22 etc.) is used, chlorine in refrigerant can cause deterioration of refrigerant oil etc.

#### Use a vacuum pump with a reverse flow check valve.

Vacuum pump oil may flow back into refrigerant cycle and that can cause deterioration of refrigerant oil etc.

#### Use the following tools specifically designed for use with R410A refrigerant.

The following tools are necessary to use R410A refrigerant.

Tools for R410A	
Gauge manifold	Flare tool
Charge hose	Size adjustment gauge
Gas leak detector	Vacuum pump adaptor
Torque wrench	Electronic refrigerant charging scale

#### Handle tools with care.

If dirt, dust or moisture enters into refrigerant cycle, that can cause deterioration of refrigerant oil or malfunction of compressor.

#### Do not use a charging cylinder.

If a charging cylinder is used, the composition of refrigerant will change and the efficiency will be lowered.

#### Use the specified refrigerant only.

**Never use any refrigerant other than that specified.**

Doing so may cause a burst, an explosion, or fire when the unit is being used, serviced, or disposed of.

Correct refrigerant is specified in the manuals and on the spec labels provided with our products.

We will not be held responsible for mechanical failure, system malfunction, unit breakdown or accidents caused by failure to follow the instructions.

**Ventilate the room if refrigerant leaks during operation. If refrigerant comes into contact with a flame, poisonous gases will be released.**

## [1] Cautions for service

- (1) Perform service after recovering the refrigerant left in unit completely.
- (2) Do not release refrigerant in the air.
- (3) After completing service, charge the cycle with specified amount of refrigerant.
- (4) When performing service, install a filter drier simultaneously.  
Be sure to use a filter drier for new refrigerant.

## [2] Additional refrigerant charge

### When charging directly from cylinder

- Check that cylinder for R410A on the market is syphon type.
- Charging should be performed with the cylinder of syphon stood vertically. (Refrigerant is charged from liquid phase.)

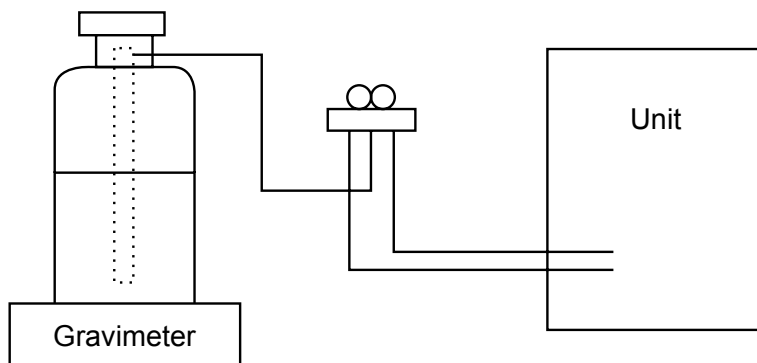

## [3] Service tools

Use the below service tools as exclusive tools for R410A refrigerant.

No.	Tool name	Specifications
①	Gauge manifold	· Only for R410A
		· Use the existing fitting specifications. (UNF1/2)
		· Use high-tension side pressure of 5.3MPa·G or over.
②	Charge hose	· Only for R410A
		· Use pressure performance of 5.09MPa·G or over.
③	Electronic scale	—
④	Gas leak detector	· Use the detector for R410A.
⑤	Adaptor for reverse flow check	· Attach on vacuum pump.
⑥	Refrigerant charge base	—
⑦	Refrigerant cylinder	· Only for R410A · Top of cylinder (Pink)
		· Cylinder with syphon
⑧	Refrigerant recovery equipment	—



## 2-3. PRECAUTIONS WHEN REUSING EXISTING R22 REFRIGERANT PIPES

### (1) Flowchart

- Refer to the flowchart below to determine if the existing pipes can be used and if it is necessary to use a filter dryer.
- If the diameter of the existing pipes is different from the specified diameter, refer to technological data materials to confirm if the pipes can be used.

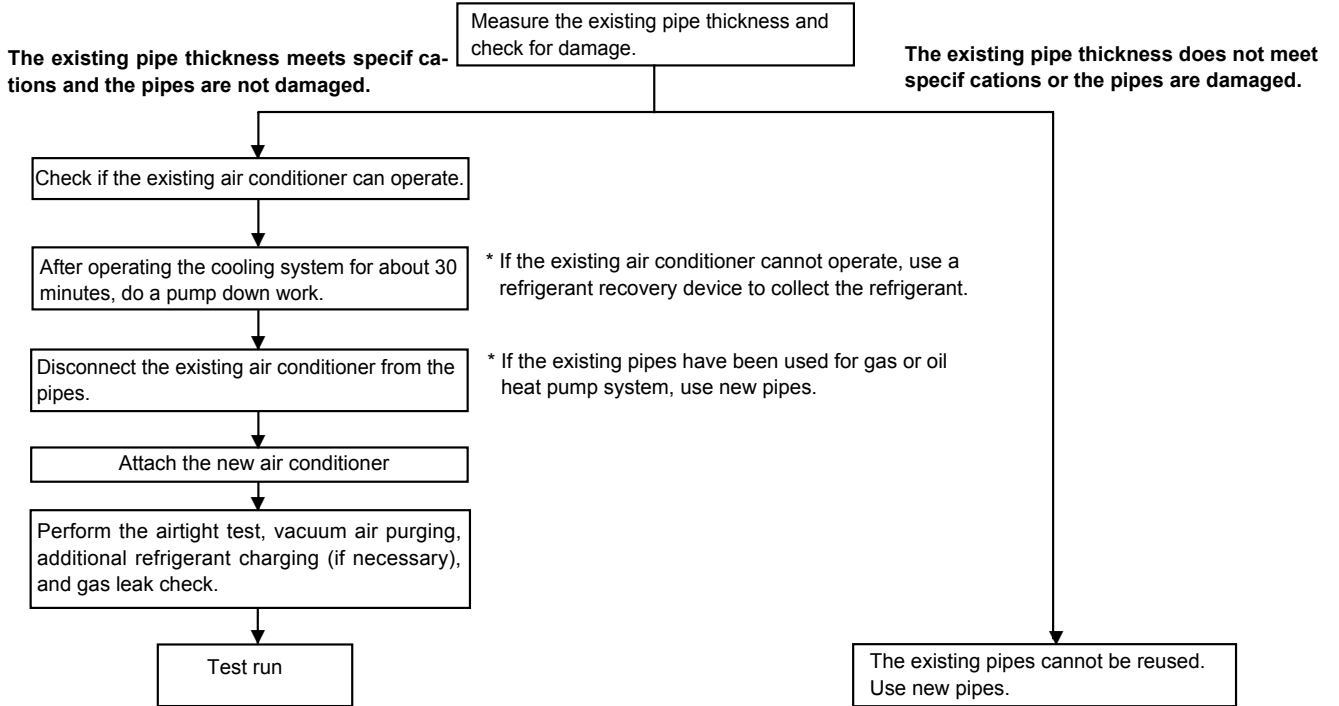

## (2) Cautions for refrigerant piping work

New refrigerant R410A is adopted for replacement inverter series. Although the refrigerant piping work for R410A is same as for R22, exclusive tools are necessary so as not to mix with different kind of refrigerant. Furthermore as the working pressure of R410A is 1.6 times higher than that of R22, their sizes of flared sections and flare nuts are different.

### ① Thickness of pipes

Because the working pressure of R410A is higher compared to R22, be sure to use refrigerant piping with thickness shown below. (Never use pipes of 0.7 mm or below.)

Diagram below: Piping diameter and thickness

Nominal dimensions(inch)	Outside diameter (mm)	Thickness (mm)	
		R410A	R22
1/4	6.35	0.8	0.8
3/8	9.52	0.8	0.8
1/2	12.70	0.8	0.8
5/8	15.88	1.0	1.0
3/4	19.05	—	1.0

### ② Dimensions of flare cutting and flare nut

The component molecules in HFC refrigerant are smaller compared to conventional refrigerants. In addition to that, R410A is a refrigerant, which has higher risk of leakage because its working pressure is higher than that of other refrigerants. Therefore, to enhance airtightness and intensity, flare cutting dimension of copper pipe for R410A has been specified separately from the dimensions for other refrigerants as shown below. The dimension B of flare nut for R410A also has partly been changed to increase intensity as shown below. Set copper pipe correctly referring to copper pipe flaring dimensions for R410A below. For 1/2 and 5/8 inch, the dimension B changes. Use torque wrench corresponding to each dimension.

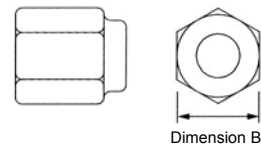
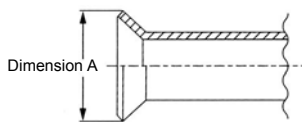

Flare cutting dimensions (mm)

Nominal dimensions(inch)	Outside diameter	Dimension A (mm)	
		R410A	R22
1/4	6.35	9.1	9.0
3/8	9.52	13.2	13.0
1/2	12.70	16.6	16.2
5/8	15.88	19.7	19.4
3/4	19.05	—	23.3

Flare nut dimensions (mm)

Nominal dimensions(inch)	Outside diameter	Dimension B	
		R410A	R22
1/4	6.35	17.0	17.0
3/8	9.52	22.0	22.0
1/2	12.70	26.0	24.0
5/8	15.88	29.0	27.0
3/4	19.05	—	36.0

### ③ Tools for R410A (The following table shows whether conventional tools can be used or not.)

Tools and materials	Use	R410A tools	Can R22 tools be used?	Can R407C tools be used?
Gauge manifold	Air purge, refrigerant charge and operation check	Tool exclusive for R410A	×	×
Charge hose	Refrigerant recovery	Tool exclusive for R410A	×	×
Gas leak detector	Gas leak check	Tool for HFC refrigerant	×	○
Refrigerant recovery equipment	Refrigerant recovery	Tool exclusive for R410A	×	×
Refrigerant cylinder	Refrigerant charge	Tool exclusive for R410A	×	×
Applied oil	Apply to flared section	Ester oil and alkylbenzene oil (minimum amount)	×	Ester oil: ○ Alkylbenzene oil: minimum amount
Safety charger	Prevent compressor malfunction when charging refrigerant by spraying liquid refrigerant	Tool exclusive for R410A	×	×
Charge valve	Prevent gas from blowing out when detaching charge hose	Tool exclusive for R410A	×	×
Vacuum pump	Vacuum drying and air purge	Tools for other refrigerants can be used if equipped with adapter for reverse flow check	△ (Usable if equipped with adapter for reverse flow)	△ (Usable if equipped with adapter for reverse flow)
Flare tool	Flaring work of piping	Tools for other refrigerants can be used by adjusting flaring dimension	△ (Usable by adjusting flaring dimension)	△ (Usable by adjusting flaring dimension)
Bender	Bend the pipes	Tools for other refrigerants can be used	○	○
Pipe cutter	Cut the pipes	Tools for other refrigerants can be used	○	○
Welder and nitrogen gas cylinder	Weld the pipes	Tools for other refrigerants can be used	○	○
Refrigerant charging scale	Refrigerant charge	Tools for other refrigerants can be used	○	○
Vacuum gauge or thermistor vacuum gauge and vacuum valve	Check the degree of vacuum. (Vacuum valve prevents back flow of oil and refrigerant to thermistor vacuum gauge)	Tools for other refrigerants can be used	○	○
Charging cylinder	Refrigerant charge	Tool exclusive for R410A	×	—

× : Prepare a new tool. (Use the new tool as the tool exclusive for R410A.)

△ : Tools for other refrigerants can be used under certain conditions.

○ : Tools for other refrigerants can be used.

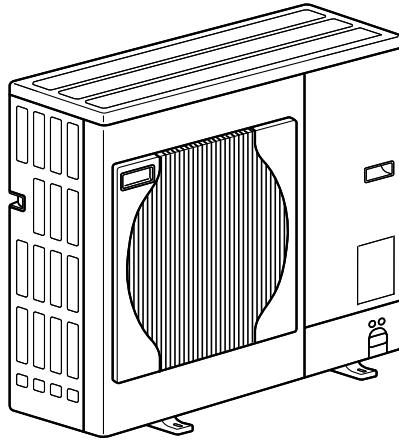
**PUAZ-FRP71VHA****CHARGELESS SYSTEM****PRE-CHARGED REFRIGERANT IS SUPPLIED FOR PIPING LENGTH AT SHIPMENT.****Max. 30m (Air conditioner side and hot water side total)**

The refrigerant circuit with LEV (Linear Expansion Valve) always control the optimal refrigerant level regardless of the length (Total 30 m max. and 5 m min.) of piping. The additional refrigerant charging work during installation often causes problems. It is completely eliminated by chargeless system. This unique system improves the quality and reliability of the work done. It also helps to speed up the installation time.

# 4

# SPECIFICATIONS

Service Ref.				PUHZ-FRP71VHA	
Power supply (phase, cycle, voltage)				Single, 50 Hz, 230 V	
Max. current		A		19	
External finish				Munsell 3Y 7.8/1.1	
Refrigerant control				Linear Expansion Valve	
Compressor				Hermetic	
Model				SNB172FSHM1	
Motor output		kW		1.6	
Starter type				Inverter	
Protection devices				HP switch Comp. surface thermo Discharge thermo	
Crankcase heater		W		—	
Heat exchanger				Plate fin coil	
Fan (drive) × No.				Propeller fan × 1	
Fan motor output		kW		0.086	
Airflow		m³/min(CFM)		55 (1,940)	
Defrost method				Reverse cycle	
Noise level		ATA Cooling HR Cooling	dB	47	
		ATA Heating ATW Heating	dB	48	
Dimensions		W	mm(in.)	950 (37-3/8)	
		D	mm(in.)	330+30 (13+1-3/16)	
		H	mm(in.)	943 (37-1/8)	
Weight		kg(lbs)		73 (161)	
Refrigerant				R410A	
Charge		kg(lbs)		3.8 (8.4)	
Oil (Model)		L		0.70 (FV50S)	
Pipe size O.D.		ATA	Liquid	mm(in.)	9.52 (3/8)
			Gas	mm(in.)	15.88 (5/8)
		ATW	Liquid	mm(in.)	9.52 (3/8)
			Gas	mm(in.)	15.88 (5/8)
Connection method		ATA indoor side		Flared	
		ATW indoor side		Flared	
		Outdoor side		Flared	
Between the indoor & outdoor unit		Height difference		Max. 20 m	
		Piping length		Max. 60 m total, Max. 30 m for each	



# 5

# DATA

## 5-1. REFILLING REFRIGERANT CHARGE (R410A : kg)

Service Ref.	Total piping length (one way)							Initial charged
	10m	20m	30m	40m	50m	60m	75m	
PUHZ-FRP71VHA	3.4	3.6	3.8	4.4	5.0	5.6	—	3.8

Additional charge is required for pipes longer than total 30 m.

## 5-2. COMPRESSOR TECHNICAL DATA

(at 20°C)

Service Ref.	PUHZ-FRP71VHA	
Compressor model	SNB172FSHM1	
Winding Resistance (Ω)	U-V	1.34
	U-W	1.34
	W-V	1.34

## 5-3. NOISE CRITERION CURVES

PUHZ-FRP71VHA

MODE	SPL(dB)	LINE
ATA Cooling, HR Cooling	47	○—○
ATA Heating, ATW Heating	48	●—●

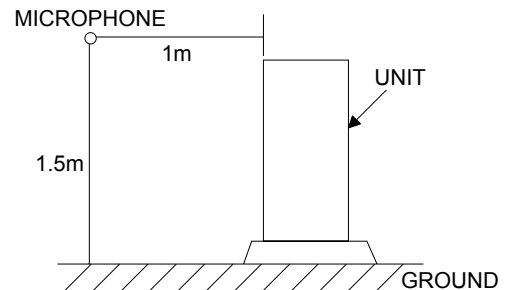
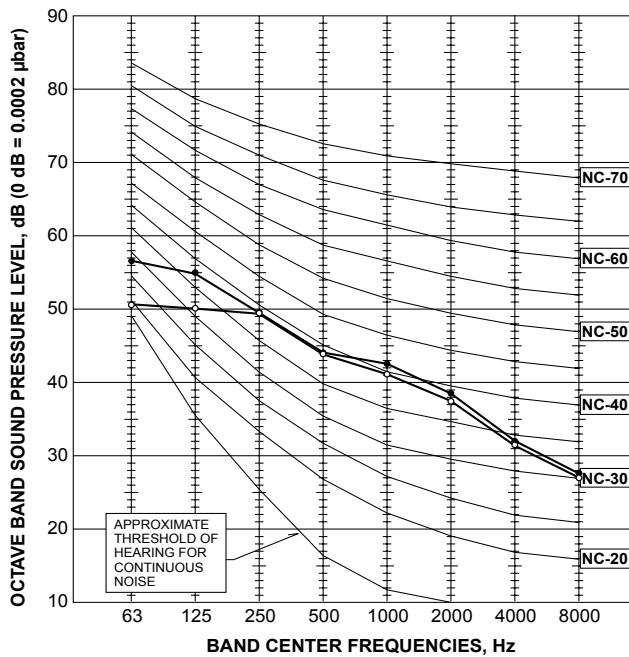

## 5-4. STANDARD OPERATION DATA

Representative matching				PEAD-RP71JA				
Plate HEX				ACH70-40				
Mode				ATA Cooling	ATA Heating	ATW Heating	HR Cooling	
Total	ATA capacity	W		7,100	8,000	—	7,100	
	ATW capacity	W		—	—	8,000	9,000	
	Input	kW		2.10	2.09	1.96	3.22	
	COP			3.38	3.83	4.08	5.00	
Electrical circuit	Indoor unit			PEAD-RP71JA				
	Phase, Hz			1, 50	1, 50	—	1, 50	
	Voltage		V	230	230	—	230	
	Current		A	0.17	0.15	—	0.17	
	Outdoor unit			PUHZ-FRP71VHA				
	Phase, Hz			1, 50	1, 50	1, 50	1, 50	
	Voltage		V	230	230	230	230	
	Current		A	9.15	9.12	8.70	13.97	
Refrigerant circuit	Discharge pressure		MPa	2.79	2.46	2.13	3.39	
	Suction pressure		MPa	0.96	0.71	0.70	0.94	
	Discharge temperature		°C	71	62	53	80	
	Condensing temperature		°C	47	42	37	57	
	Suction temperature		°C	10	0	0	9	
	Ref. pipe length		m	5 + 5	5 + 5	5 + 5	5 + 5	
ATA indoor side	Intake air temperature		DB	°C	27	20	—	27
			WB	°C	19	15	—	19
	Discharge air temperature		DB	°C	14.5	36	—	14.5
ATW side	Return temperature		°C	—	—	30	50	
	Flow temperature		°C	—	—	35	55	
	Flow rate		L/min	—	—	23	23	
Outdoor side	Intake air temperature		DB	°C	35	7	7	35
			WB	°C	24	6	6	24
SHF				0.81	—	—	0.81	
BF				0.11	—	—	0.11	

The unit of pressure has been changed to MPa based on international SI system.  
The conversion factor is : 1(MPa)=10.2(kgf/cm<sup>2</sup>)

PUHZ-FRP71VHA

Unit : mm

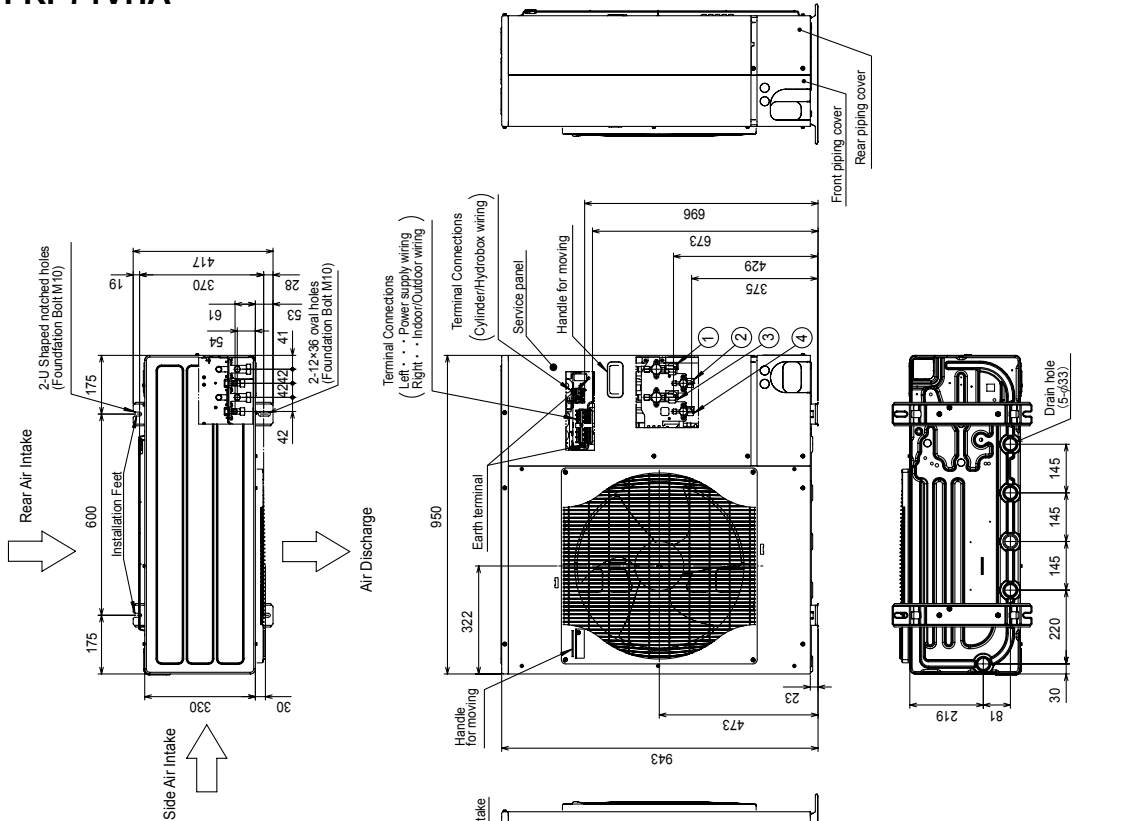

**1 FREE SPACE (Around the unit)**  
The diagram below shows a basic example. Explanation of particular details are given in the installation manuals etc.

**2 SERVICE SPACE**  
Dimensions of space needed for service access are shown in the below diagram.

**3 FOUNDATION BOLTS**  
Please secure the unit firmly with 4 foundation (M10) bolts. (Bolts and washers must be purchased locally.)

**4 PIPING-WIRING DIRECTIONS**  
Piping and wiring connections can be made from 4 directions: Front, right, rear and below.

- Example of Notes**
- 1 ... Refrigerant GAS pipe connection (FLARE) φ15.88 (5/8F)  
\*Connect to indoor unit.
  - 2 ... Refrigerant LIQUID pipe connection (FLARE) φ9.52 (3/8F)  
\*Connect to indoor unit.
  - 3 ... Refrigerant GAS pipe connection (FLARE) φ15.88 (5/8F)  
\*Connect to cylinder unit or hydrobox.
  - 4 ... Refrigerant LIQUID pipe connection (FLARE) φ9.52 (3/8F)  
\*Connect to cylinder unit or hydrobox.

This tap mark indicates the cylinder/hydro unit connection side for the following parts.  
 \* Terminal bed for the connecting cables, S1/S2/S3.  
 \* Stop valves, gas and liquid for the refrigerant connection.

**Piping Knockout Hole Details**

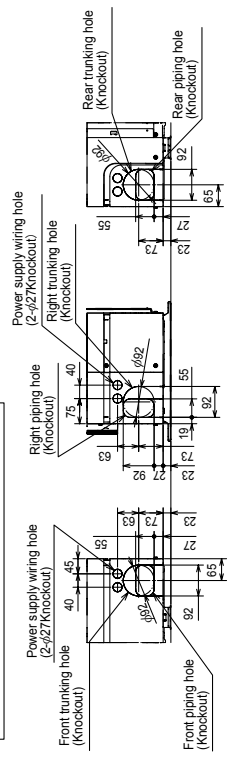

PUHZ-FRP71VHA

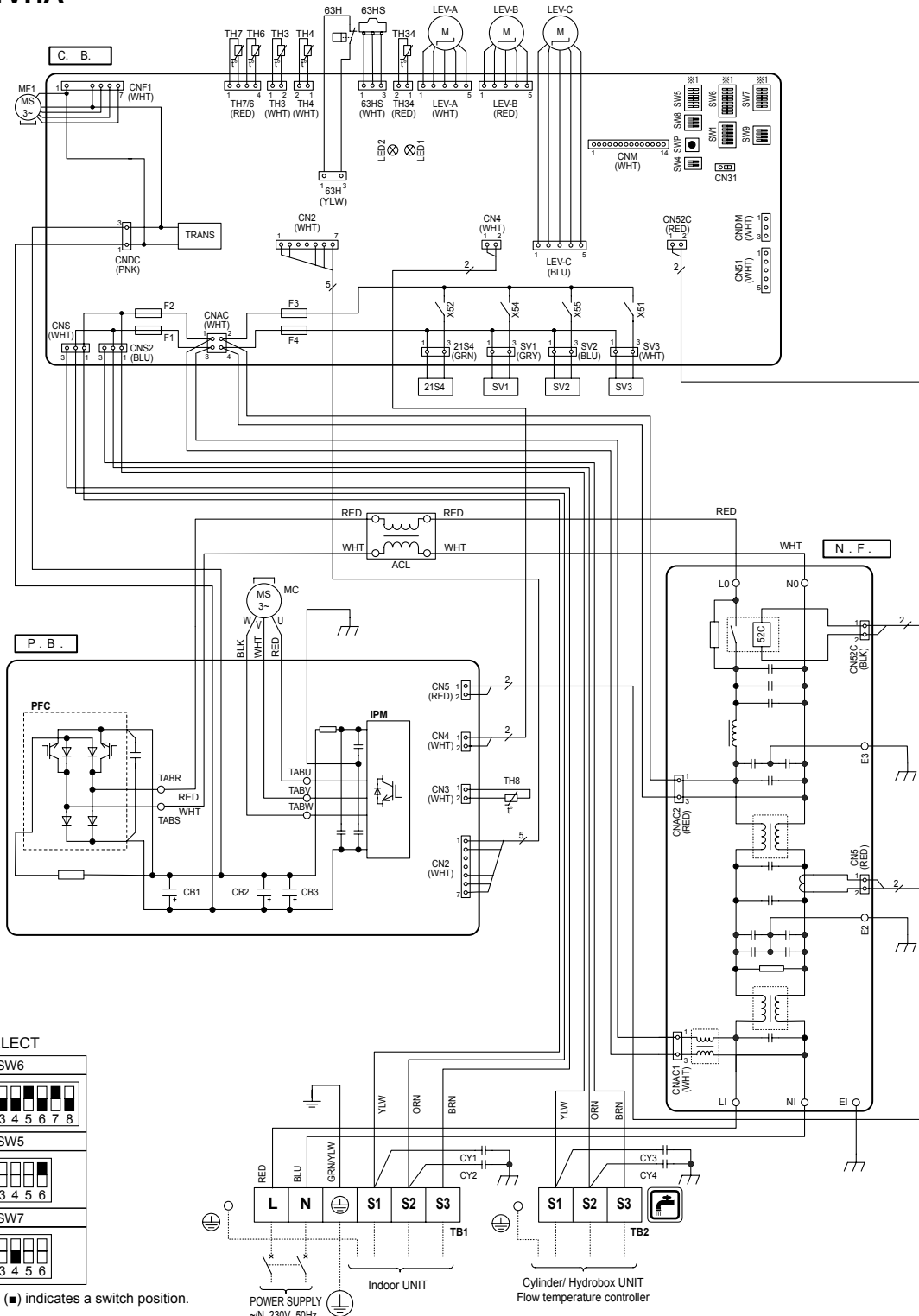

※1 MODEL SELECT

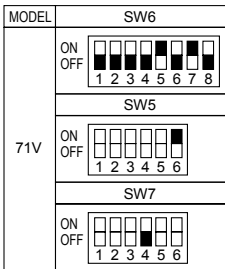

The black square (■) indicates a switch position.

SYMBOL	NAME	SYMBOL	NAME	SYMBOL	NAME
TB1	Terminal Block<Power Supply, Indoor/Outdoor>	P.B.	Power Circuit Board	SW7	Switch<Function Switch, Model Select>
TB2	Terminal Block<Cylinder/HydroboxUNIT/Outdoor>	TABR/S	Connection Terminal<L/N-Phase>	SW8	Switch<Function Switch>
MC	Motor for Compressor	TABU/V/W	Connection Terminal<U/V/W-Phase>	SW9	Switch<Function Switch>
MF1	Fan Motor	IPM	Power Module	LED1,LED2	LED
21S4	Solenoid Valve (Four-Way Valve)	PFC	Converter		<Operation Inspection Indicators>
SV1-3	Solenoid Valve	CB1-CB3	Main Smoothing Capacitor	F1-4	Fuse<T6.3AL250V>
63H	High Pressure Switch	N.F.	Noise Filter Circuit Board	SWP	Switch<Pump Down>
63HS	High Pressure Sensor	L/L/O	Connection Terminal<L-Phase>	CN31	Connector<Emergency Operation>
TH3	Thermistor<Outdoor Pipe>	N/I/NO	Connection Terminal<N-Phase>	CN51	Connector<Connection for Option>
TH4	Thermistor<Discharge>	EI,E2,E3	Connection Terminal<Ground>	CNM	Connector<A-Control Service Inspection Kit>
TH6	Thermistor<Outdoor 2-Phase Pipe>	52C	52C Relay	CNDM	Connector
TH7	Thermistor<Outdoor>				< Connected for Option (Contact Input)>
TH8	Thermistor<Heat Sink>	C.B.	Controller Circuit Board		
TH34	Thermistor<Comp. Surface>	SW1	Switch<Forced Defrost, Defect History Record Reset, Refrigerant Address>		
LEV-A, LEV-B, LEV-C	Linear Expansion Valve	SW4	Switch<Test Operation>		
ACL	Reactor	SW5	Switch<Function Switch, Model Select>		
CY1-4	Capacitor	SW6	Switch<Model Select>		
				X51,X52,X54,X55	Relay

8-1. FIELD ELECTRICAL WIRING (power wiring specifications)

Outdoor unit power supply		~N (single), 50 Hz, 230 V
Outdoor unit input capacity Main switch (Breaker)		*1 25 A
Wiring Wire No. x size (mm <sup>2</sup> )	Outdoor unit power supply	3 × Min. 2.5
	Indoor unit – Outdoor unit Cylinder– or Hydrobox – Outdoor unit	*2 3 × 1.5 (Polar)
	Indoor unit – Outdoor unit earth Cylinder– or Hydrobox – Outdoor unit earth	*2 1 × Min. 1.5
	Remote controller – Indoor unit Cylinder– or Hydrobox-side remote controller – its unit	*3 2 × 0.3 (Non-polar)
Circuit rating	Outdoor unit L – N (single)	*4 AC 230 V
	Outdoor unit L1 – N, L2 – N, L3 – N (3 phase)	*4 AC 230 V
	Indoor unit – Outdoor unit S1-S2 Cylinder– or Hydrobox – Outdoor unit S1-S2	*4 AC 230 V
	Indoor unit – Outdoor unit S2-S3 Cylinder– or Hydrobox – Outdoor unit S2-S3	*4 DC 24 V
	Remote controller – Indoor unit Cylinder– or Hydrobox-side remote controller – its unit	*4 DC 12 V
	Remote controller – Indoor unit Cylinder– or Hydrobox-side remote controller – its unit	*4 DC 12 V

\*1. A breaker with at least 3.0 mm contact separation in each pole shall be provided. Use earth leakage breaker (NV).  
Make sure that the current leakage breaker is one compatible with higher harmonics.  
Always use a current leakage breaker that is compatible with higher harmonics as this unit is equipped with an inverter.  
The use of an inadequate breaker can cause the incorrect operation of inverter.

\*2. Max. 45 m  
If 2.5 mm<sup>2</sup> used, Max. 50 m  
If 2.5 mm<sup>2</sup> used and S3 separated, Max. 80 m

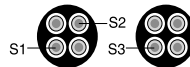

\*3. The 10 m wire is attached in the remote controller accessory.  
\*4. The figures are NOT always against the ground.  
S3 terminal has DC 24 V against S2 terminal. However between S3 and S1, these terminals are NOT electrically insulated by the transformer or other device.

**Caution:** Be sure to install N-Line. Without N-Line, it could cause damage to the unit.

- Notes:
1. Wiring size must comply with the applicable local and national code.
  2. Power supply cables and Indoor/Outdoor unit connecting cables shall not be lighter than polychloroprene sheathed flexible cable. (Design 60245 IEC 57)
  3. Install an earth longer than other cables.

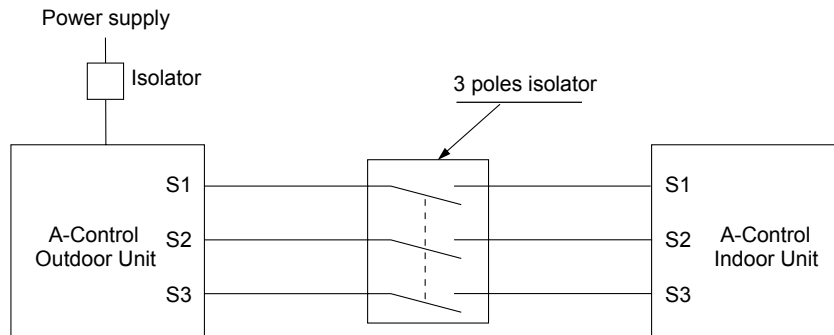

**Warning:**

In case of A-control wiring, there is high voltage potential on the S3 terminal caused by electrical circuit design that has no electrical insulation between power line and communication signal line. Therefore, please turn off the main power supply when servicing. And do not touch the S1, S2, S3 terminals when the power is energized. If isolator should be used between indoor unit and outdoor unit, please use 3-pole type.

1:1 system electrical wiring

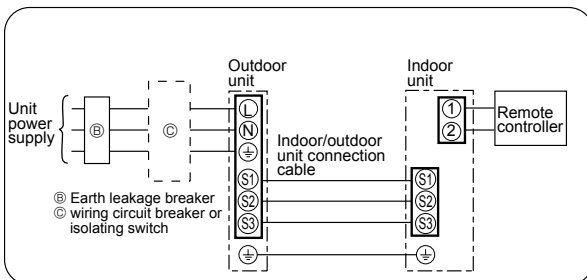

Synchronized twin system electrical wiring

• Synchronized twin

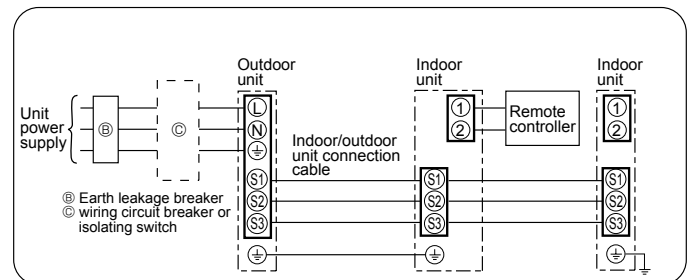

## 8-2. SEPARATE INDOOR UNIT/ OUTDOOR UNIT POWER SUPPLIES

The following connection patterns are available.  
The outdoor unit power supply patterns vary on models.

### 1:1 System

<For models without heater>

\* The optional indoor power supply terminal kit is required.

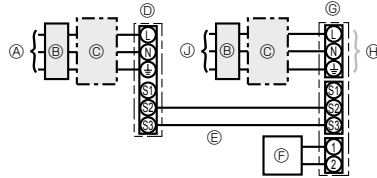

- Ⓐ Outdoor unit power supply
- Ⓑ Earth leakage breaker
- Ⓒ Wiring circuit breaker or isolating switch
- Ⓓ Outdoor unit
- Ⓔ Indoor unit/outdoor unit connecting cords
- Ⓕ Remote controller
- Ⓖ Indoor unit
- Ⓗ Option
- Ⓘ Indoor unit power supply

\* Affix a label B that is included with the manuals near each wiring diagram for the indoor and outdoor units.

### Simultaneous twin system

<For models without heater>

\* The optional indoor power supply terminal kit is required.

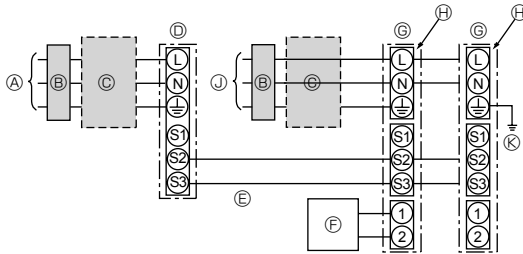

- Ⓐ Outdoor unit power supply
- Ⓑ Earth leakage breaker
- Ⓒ Wiring circuit breaker or isolating switch
- Ⓓ Outdoor unit
- Ⓔ Indoor unit/outdoor unit connecting cales
- Ⓕ Remote controller
- Ⓖ Indoor unit
- Ⓗ Option
- Ⓙ Indoor unit power supply
- Ⓚ Indoor unit earth

\* Affix a label B that is included with the manuals near each wiring diagram for the indoor and outdoor units.

If the indoor and outdoor units have separate power supplies, refer to the table below.  
If the optional indoor power supply terminal kit is used, change the indoor unit electrical box wiring referring to the figure in the right and the DIP switch settings of the outdoor unit control board.

	Indoor unit specifications								
Indoor power supply terminal kit (option)	Required								
Indoor unit electrical box connector connection change	Required								
Label affixed near each wiring diagram for the indoor and outdoor units	Required								
Outdoor unit DIP switch settings (when using separate indoor unit/outdoor unit power supplies only)	<table border="1"> <tr> <td>ON</td> <td></td> <td></td> <td>3</td> </tr> <tr> <td>OFF</td> <td>1</td> <td>2</td> <td></td> </tr> </table> (SW8) Set the SW8-3 to ON.	ON			3	OFF	1	2	
ON			3						
OFF	1	2							

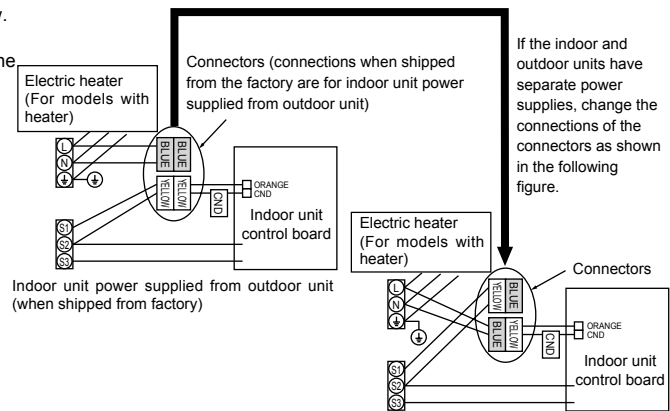

\* There are 3 types of labels (labels A, B, and C). Affix the appropriate labels to the units according to the wiring method.

Indoor unit model		RP71
Indoor unit power supply		~N (single), 50 Hz, 230 V
Indoor unit input capacity		
Main switch (Breaker)		*1 16 A
Wiring	Wire No. x size (mm <sup>2</sup> )	
	Indoor unit power supply	2 × Min. 1.5
	Indoor unit power supply earth	1 × Min. 1.5
	Indoor unit-Outdoor unit	*2 2 × Min. 0.3
Circuit rating	Indoor unit-Outdoor unit earth	-
	Remote controller-Indoor unit	*3 2 × 0.3 (Non-polar)
	Indoor unit L-N	*4 AC 230 V
	Indoor unit-Outdoor unit S1-S2	*4 -
	Indoor unit-Outdoor unit S2-S3	*4 DC24 V
	Remote controller-Indoor unit	*4 DC12 V

\*1. A breaker with at least 3 mm contact separation in each pole shall be provided. Use earth leakage breaker (NV).  
The breaker shall be provided to ensure disconnection of all active phase conductor of the supply.

\*2. Max. 120 m

\*3. The 10 m wire is attached in the remote controller accessory. Max. 500 m

\*4. The figures are NOT always against the ground.

**Notes:** 1. Wiring size must comply with the applicable local and national code.

2. Power supply cables and indoor unit/outdoor unit connecting cables shall not be lighter than polychloroprene sheathed flexible cable. (Design 60245 IEC 57)

3. Install an earth longer than other cables.

PUHZ-FRP71VHA

Unit : mm (inch)

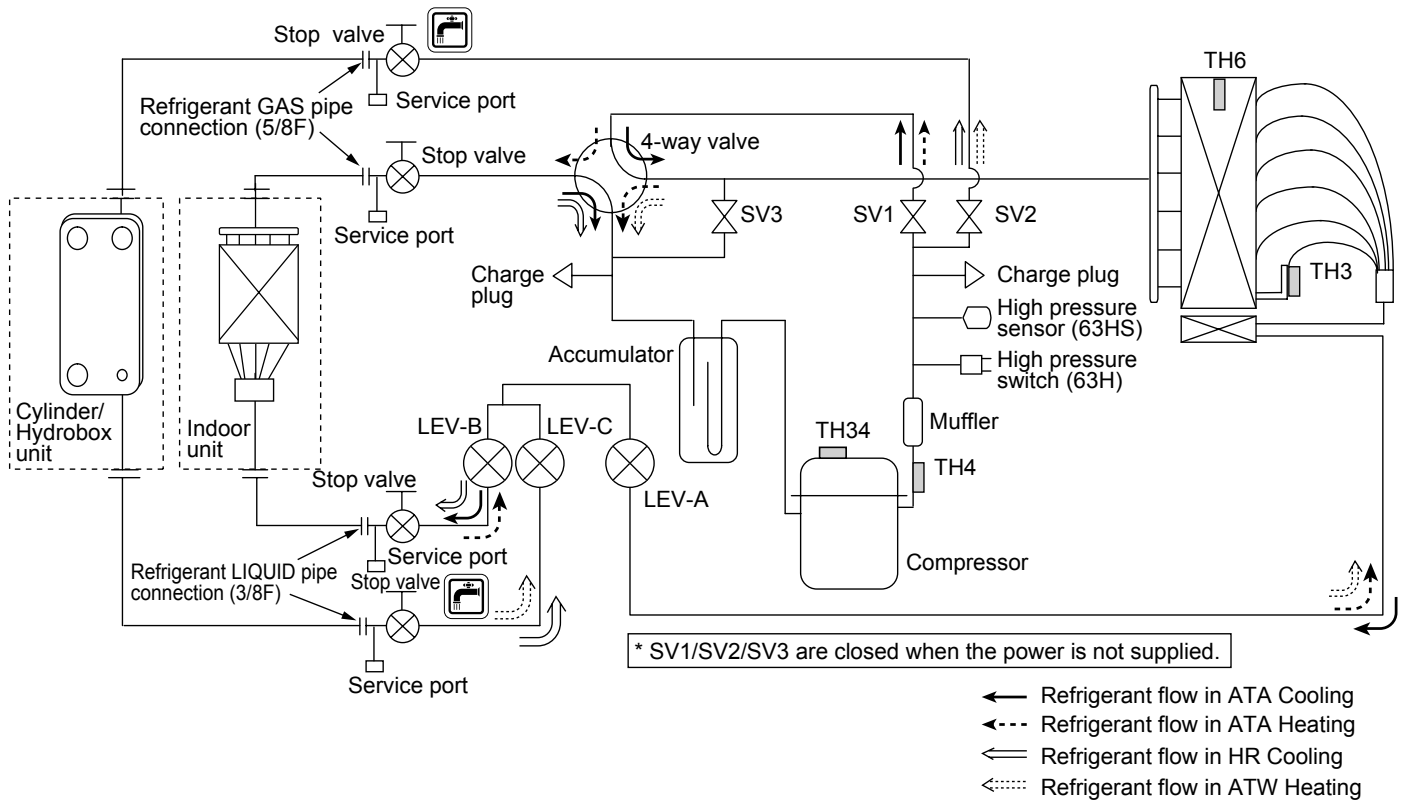

## 9-1. REFRIGERANT COLLECTING (PUMP DOWN)

The refrigerant collecting function is available by performing the following procedure.

- ① Close the 2 liquid stop valves and the cylinder/hydro unit side gas valve.  
Only the indoor unit side gas valve remains open.
- ② Connect the 2 gas stop valve service ports with a hose.
- ③ Turn on the main power and wait for 3-4 minutes.
- ④ Press the SWP button on the outdoor controller board, then the refrigerant collecting operation starts.
- ⑤ After confirming the low pressure is lowered to 0 MPa (gauge), close the indoor unit side gas valve.  
The refrigerant collecting operation stops automatically in 5 minutes.
- ⑥ Turn off the main power.

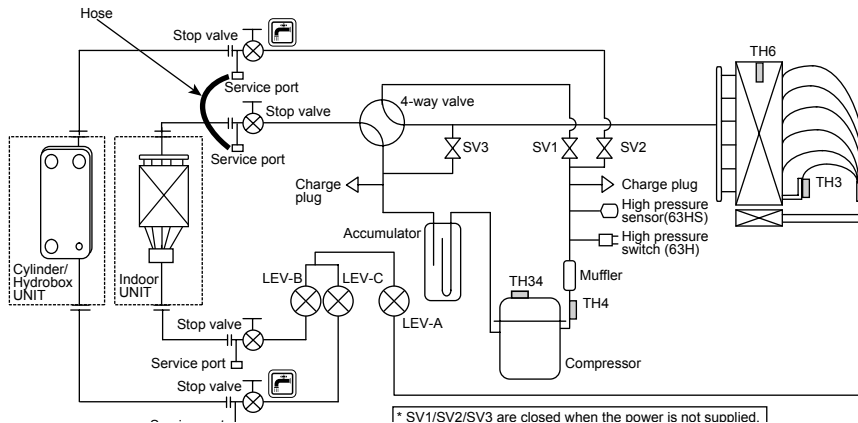

### ⚠ Warning:

**Do not disconnect extension pipes during the refrigerant collecting operation is running.**

If you open the stop valves to the air during the compressor is running, the pressure could be abnormal high level and this may cause a rupture of the compressor or other hazardous situation.

\* Use a refrigerant recovery machinery if the refrigerant collecting is not completed in case of long pipe length or too much refrigerant contained.

## 9-2. START AND FINISH OF TEST RUN (ATA only)

- Operation from the indoor unit  
Execute the test run using the installation manual for the indoor unit.
- Operation from the outdoor unit  
By using the DIP switch SW4 on the control board of outdoor unit, test run can be started and finished, and its operation mode (cooling/heating) can be set up.

- ① Set the operation mode (cooling/heating) using SW4-2.
- ② Turn on SW4-1 to start test run with the operation mode set by SW4-2.
- ③ Turn off SW4-1 to finish the test run.

- There may be a faint knocking sound around the machine room after power is supplied, but this is no problem with product because the linear expansion pipe is just moving to adjust opening pulse.
- There may be a knocking sound around the machine room for several seconds after compressor starts operating, but this is no problem with product because the check valve itself, generates the sound because pressure difference is small in the refrigerant circuit.

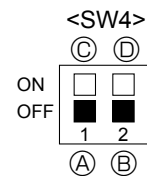

- Ⓐ Stop      Ⓒ Operation
- Ⓑ Cooling   Ⓓ Heating

**Note:**  
The operation mode cannot be changed by SW4-2 during test run. (To change test run mode, stop the unit by SW4-1, change the operation mode and restart the test run by SW4-1.)



### 10-1. TROUBLESHOOTING

#### <Error code display by self-diagnosis and actions to be taken for service (summary)>

Present and past error codes are logged and displayed on the wired remote controller and control board of outdoor unit. Actions to be taken for service, which depends on whether or not the trouble is reoccurring at service, are summarized in the table below. Check the contents below before investigating details.

Unit conditions at service	Error code	Actions to be taken for service (summary)
The trouble is reoccurring.	Displayed	Judge what is wrong and take a corrective action according to "10-4. Self-diagnosis action table".
	Not displayed	Conduct trouble shooting and ascertain the cause of the trouble according to "10-5. Troubleshooting of problems".
The trouble is not reoccurring.	Logged	①Consider the temporary defects such as the work of protection devices in the refrigerant circuit including compressor, poor connection of wiring, noise and etc. Re-check the symptom, and check the installation environment, refrigerant amount, weather when the trouble occurred, matters related to wiring and etc. ②Reset error code logs and restart the unit after finishing service. ③There is no abnormality in electrical component, controller board, remote controller and etc.
	Not logged	①Re-check the abnormal symptom. ②Conduct trouble shooting and ascertain the cause of the trouble according to "10-5. Troubleshooting of problems". ③Continue to operate unit for the time being if the cause is not ascertained. ④There is no abnormality concerning of parts such as electrical component, controller board, remote controller and etc.

### 10-2. CHECK POINT UNDER TEST RUN

#### 10-2-1. Before test run

- After installation of indoor and outdoor units, piping work and electric wiring work, re-check that there is no refrigerant leakage, loosened connections and incorrect polarity.
  - Measure impedance between the ground and the power supply terminal block (L, N) on the outdoor unit by 500V Megger and check that it is 1.0MΩ or over.  
\*Do not use 500V Megger to indoor/outdoor connecting wire terminal block (S1, S2, S3) and remote controller terminal block (1, 2). This may cause malfunction.
  - Make sure that test run switch (SW4) is set to OFF before turning on power supply.
  - Turn on power supply 12 hours before test run in order to protect compressor.
  - For specific models which require higher ceiling settings or auto-recovery feature from power failure, make proper changes of settings referring to the description of "12. FUNCTION SETTING".
- Make sure to read operation manual before test run. (Especially items to secure safety.)

## 10-2-2. Test run for wired remote controller <PAR-31MAA>

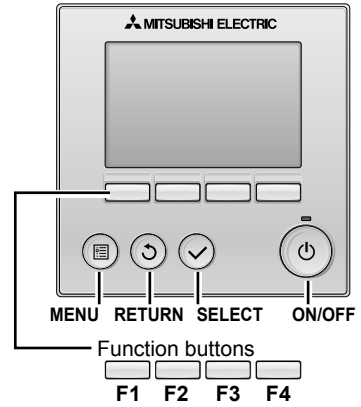

① Select "Service" from the Main menu, and press the button.



Select "Test run" with the **F1** or **F2** button, and press the button.

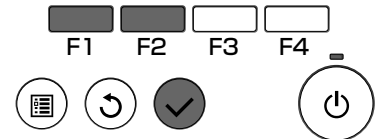
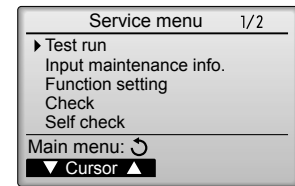

② Select "Test run" with the **F1** or **F2** button, and press the button.

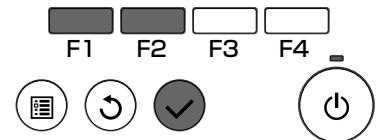
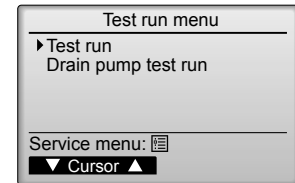

### Test run operation

Press the **F1** button to go through the operation modes in the order of "Cool and Heat".

Cool mode: Check the cold air blow off.  
Heat mode: Check the heat blow off.



Press the button and open the Vane setting screen.

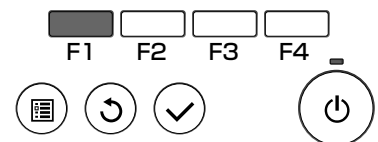
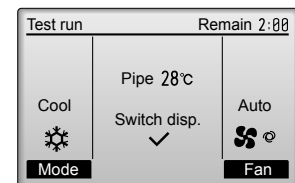

### Auto vane check

Check the auto vane with the **F1** **F2** buttons.  
\* Check the operation of the outdoor unit's fan.



Press the button to return to "Test run operation".



Press the button.

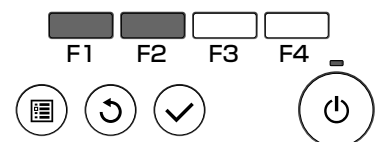
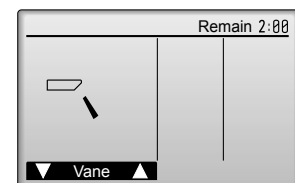

When the test run is completed, the "Test run menu" screen will appear.  
\* The test run will automatically stop after two hours.

## <Error information>

**When an error occurs, the following screen will appear.  
Check the error status, stop the operation, and consult your dealer.**

- ① Error code, error unit, refrigerant address, unit model name, and serial number will appear.  
The model name and serial number will appear only if the information have been registered.

Press the **F1** or **F2** button to go to the next page.

Contact information (dealer's phone number) will appear if the information have been registered.

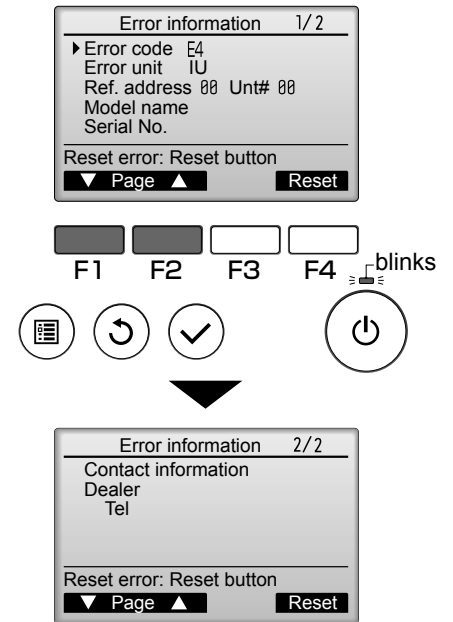

- ② Press the **F4** button or the  button to reset the error that is occurring.

**Errors cannot be reset while the ON/OFF operation is prohibited.**

Select "OK" with the **F4** button.

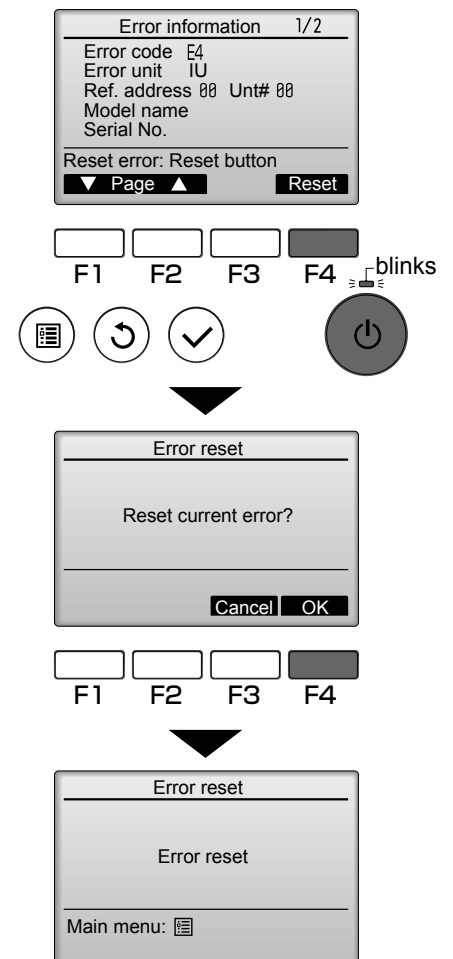

### Navigating through the screens

- To go back to the Main menu .....  button

## <Checking the error information>

While no errors are occurring, page 2/2 of the error information can be viewed by selecting "Error information" from the Main menu. Errors cannot be reset from this screen.

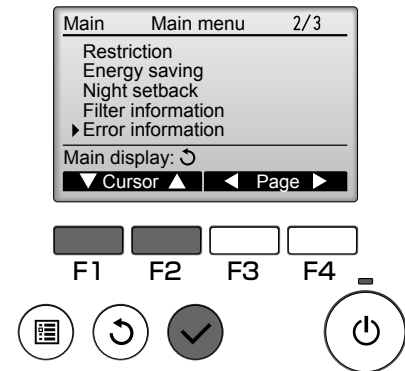

## <Error history>

① Select "Service" from the Main menu, and press the button.



Select "Check" with the **F1** or **F2** button, and press the button.

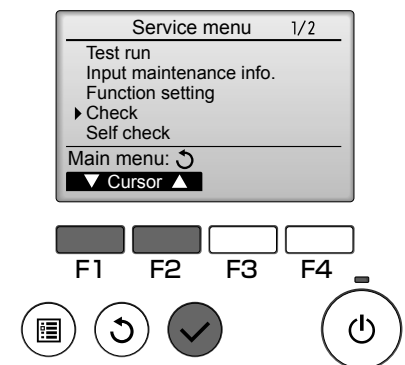

② Select "Error history" with the **F1** or **F2** button, and press the button.

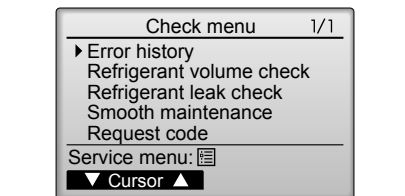

### Error history

③ Select "Error history" from the Check menu, and press the button to view up to 16 error history records.

Four records are shown per page, and the top record on the first page indicates the latest error record.

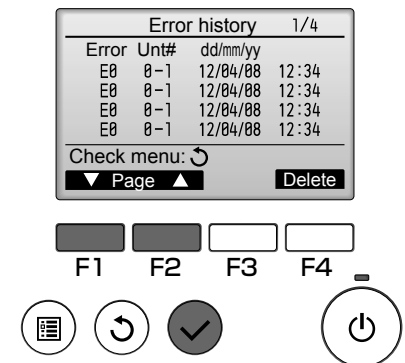

### Deleting the error history

④ To delete the error history, press the **F4** button (Delete) on the screen that shows error history. A confirmation screen will appear asking if you want to delete the error history.

Press the **F4** button (OK) to delete the history.

"Error history deleted" will appear on the screen.

Press the button to go back to the Check menu screen.

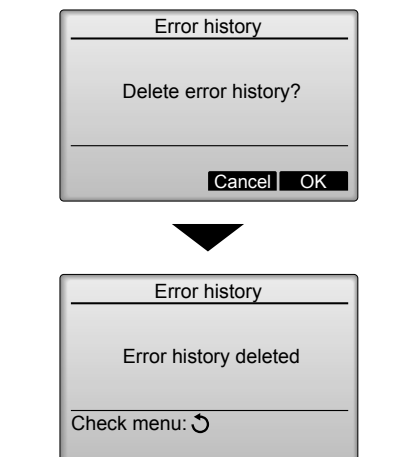

### 10-2-3. Test run for wired remote controller <PAR-21MAA>

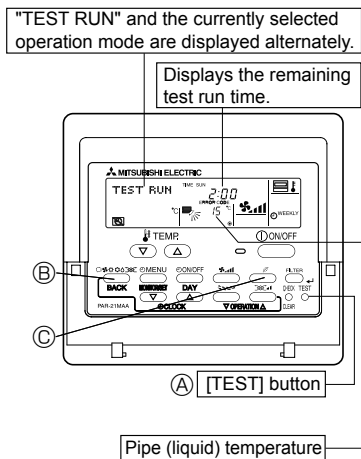

Operating procedures	
1. Turn on the main power supply.	While the room temperature display on the remote controller is "PLEASE WAIT", the remote controller is disabled. Wait until "PLEASE WAIT" disappears before using remote controller. "PLEASE WAIT" appears for about 2 minutes after power supply is turned on. *1
2. Press (A) [TEST] button twice.	The [TEST RUN] appears on the screen.
3. Press (B) [OPERATION SWITCH] button.	Cooling mode: Check if cool air blows and water is drained. Heating mode: Check if warm air blows. (It takes a little while until warm air blows.)
4. Press (C) [AIR DIRECTION] button.	Check for correct motion of auto-vanes.
5. Check the outdoor unit fan for correct running.	The outdoor unit features automatic capacity control to provide optimum fan speeds. Therefore, the fan keeps running at a low speed to meet the current outside air condition unless it exceeds its available maximum power. Then, in actuality, the fan may stop or run in the reverse direction depending on the outside air, but this does not mean malfunction.
6. Press the [ON/OFF] button to reset the test run in progress.	
7. Register the contact number.	

- In case of test run, the OFF timer will be activated, and the test run will automatically stop after 2 hours.
- The room temperature display section shows the pipe temperature of indoor units during the test run.
- Check that all the indoor units are running properly in case of simultaneous twin and triple operation. Malfunctions may not be displayed regardless of incorrect wiring.
- \*1 After turning on the power supply, the system will go into startup mode, "PLEASE WAIT" will blink on the display section of the room temperature, and lamp (green) of the remote controller will blink.  
As to INDOOR BOARD LED, LED1 will be lit up, LED2 will either be lit up in case the address is 0 or turned off in case the address is not 0. LED3 will blink.  
As to OUTDOOR BOARD LED, LED1 (green) and LED2 (red) will be lit up. (After the startup mode of the system finishes, LED2 (red) will be turned off.)  
In case OUTDOOR BOARD LED is digital display, [ ] and [ ] will be displayed alternately every second.
- If one of the above operations does not function correctly, the causes written below should be considered. Find causes from the symptoms.  
The below symptoms are under test run mode. "Startup" in the table means the display status of \*1 written above.

Symptoms in test run mode		Cause
Remote Controller Display	OUTDOOR BOARD LED Display <-> indicates digital display.	
Remote controller displays "PLEASE WAIT", and cannot be operated.	After "startup" is displayed, only green lights up. <00>	• After power is turned on, "PLEASE WAIT" is displayed for 2 minutes during system startup. (Normal)
After power is turned on, "PLEASE WAIT" is displayed for 3 minutes, then error code is displayed.	After "startup" is displayed, green(once) and red(once) blink alternately. <F1>	• Incorrect connection of outdoor terminal block (L1, L2, L3 and S1, S2, S3.)
	After "startup" is displayed, green(once) and red(twice) blink alternately. <F3, F5, F9>	• Outdoor unit's protection device connector is open.
No display appears even when remote controller operation switch is turned on. (Operation lamp does not light up.)	After "startup" is displayed, green(twice) and red(once) blink alternately. <EA, Eb>	• Incorrect wiring between the indoor and outdoor unit (Polarity is wrong for S1, S2, S3.) • Remote controller transmission wire short.
	After "startup" is displayed, only green lights up. <00>	• There is no outdoor unit of address 0. (Address is other than 0.) • Remote controller transmission wire open.
Display appears but soon disappears even when remote controller is operated.	After "startup" is displayed, only green lights up. <00>	• After canceling function selection, operation is not possible for about 30 seconds. (Normal)

\* Press the remote controller's [CHECK] button twice to perform self-diagnosis. See the table below for the contents of LCD display.







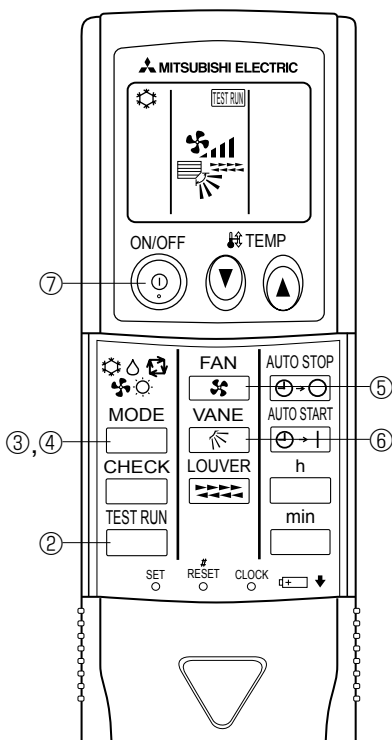



LCD	Contents of trouble	LCD	Contents of trouble
P1	Abnormality of room temperature thermistor	U1~UP	Malfunction outdoor unit
P2	Abnormality of pipe temperature thermistor/Liquid	F3~F9	Malfunction outdoor unit
P4	Abnormality of drain sensor/ Float switch connector open	E0~E5	Remote controller transmitting error
P5	Drain overflow protection is operating.	E6~EF	Indoor/outdoor unit communication error
P6	Freezing/overheating protection is operating.	----	No error history
P8	Abnormality of pipe temperature	FFFF	No applied unit
P9	Abnormality of pipe temperature thermistor/Cond./Eva	PA	Forced compressor stop(due to water leakage abnormality)
Fb	Abnormality of indoor controller board	PL	Abnormality of refrigerant circuit

See the table below for details of the LED display (LED 1, 2, 3) on the indoor controller board.

LED1 (microprocessor power supply)	Lights when power is supplied.
LED2 (remote controller)	Lights when power is supplied for wired remote controller. The indoor unit should be connected to the outdoor unit with address "0" setting.
LED3 (indoor/outdoor communication)	Flashes when indoor and outdoor unit are communicating.



#### 10-2-4. Test run for wireless remote controller

- ① Turn on the main power to the unit.
- ② Press the  button twice continuously.  
(Start this operation from the status of remote controller display turned off.)  
A  and current operation mode are displayed.
- ③ Press the  (  ) button to activate  mode, then check whether cool air is blown out from the unit.
- ④ Press the  (  ) button to activate  mode, then check whether warm air is blown out from the unit.
- ⑤ Press the  button and check whether strong air is blown out from the unit.
- ⑥ Press the  button and check whether the auto vane operates properly.
- ⑦ Press the ON/OFF button to stop the test run.

**Note:**

- Point the remote controller towards the indoor unit receiver while following steps ② to ⑦.
- It is not possible to run in FAN, DRY or AUTO mode.

## 10-3. HOW TO PROCEED "SELF-DIAGNOSIS"

### 10-3-1. Self-diagnosis <PAR-31MAA>

- ① Select "Service" from the Main menu, and press the  button.



Select "Self check" with the **F1** or **F2** button, and press the  button.

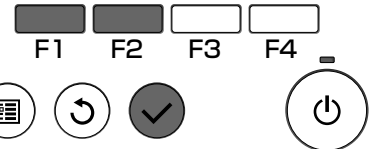
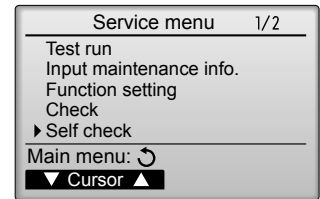

- ② With the **F1** or **F2** button, enter the refrigerant address, and press the  button.

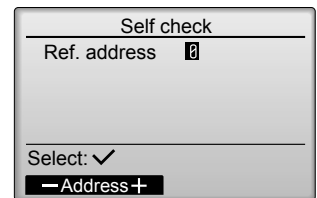

- ③ Error code, unit number, attribute will appear.  
"-" will appear if no error history is available.

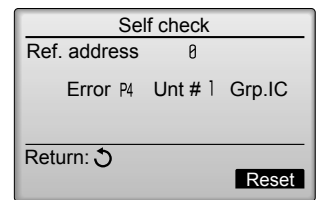

#### When there is no error history

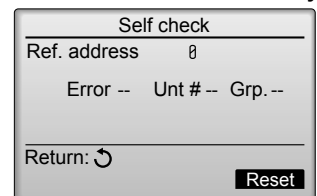

- ④ Resetting the error history.

Press the **F4** button (Reset) on the screen that shows the error history.



A confirmation screen will appear asking if you want to delete the error history.



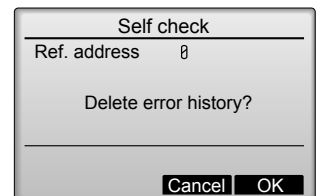

Press the **F4** button (OK) to delete the error history.

If deletion fails, "Request rejected" will appear.  
"Unit not exist" will appear if no indoor units that correspond to the entered address are found.





#### Navigating through the screens

- To go back to the Main menu .....  button
- To return to the previous screen .....  button

### 10-3-2. Remote controller check <PAR-31MAA>



\* If operations cannot be completed with the remote controller, diagnose the remote controller with this function.

- ① Select "Service" from the Main menu, and press the  button.

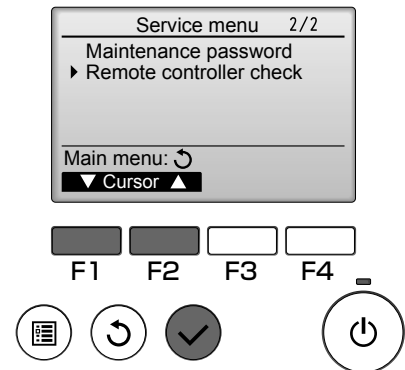
Select "Remote controller check" with the **F1** or **F2** button, and press the  button.



- ② Select "Remote controller check" from the Service menu, and press the  button to start the remote controller check and see the check results.

To cancel the remote controller check and exit the Remote controller check menu screen, press the  or the  button.

The remote controller will not reboot itself.

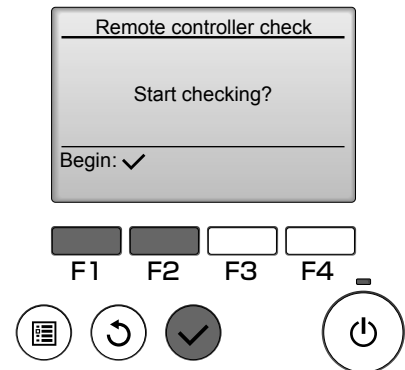

- ③ **OK:** No problems are found with the remote controller. Check other parts for problems.  
**E3, 6832:** There is noise on the transmission line, or the indoor unit or another remote controller is faulty. Check the transmission line and the other remote controllers.  
**NG (ALL0, ALL1):** Send-receive circuit fault. Remote controller needs replacing.  
**ERC:** The number of data errors is the discrepancy between the number of bits in the data transmitted from the remote controller and that of the data that was actually transmitted over the transmission line. If data errors are found, check the transmission line for external noise interference.

#### Remote controller check results screen

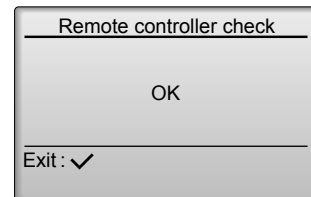

If the  button is pressed after the remote controller check results are displayed, remote controller check will end, and the remote controller will automatically reboot itself.

**Check the remote controller display and see if anything is displayed (including lines). Nothing will appear on the remote controller display if the correct voltage (8.5 – 12 VDC) is not supplied to the remote controller. If this is the case, check the remote controller wiring and indoor units.**



### 10-3-3. Self-dignosis <PAR-21MAA>

If a problem occurs in the air conditioner, the indoor and outdoor units will stop, and the problem is shown in the remote controller display.

[CHECK] and the refrigerant address are displayed on the temperature display, and the error code and unit number are displayed alternately as shown below.

- ① (If the outdoor unit is malfunctioning, the unit number will be "00".)
- ② In the case of group control, for which one remote controller controls multiple refrigerant systems, the refrigerant address and error code of the unit that first experienced trouble (i.e., the unit that transmitted the error code) will be displayed.
- ③ To clear the error code, press the **① ON/OFF** button.

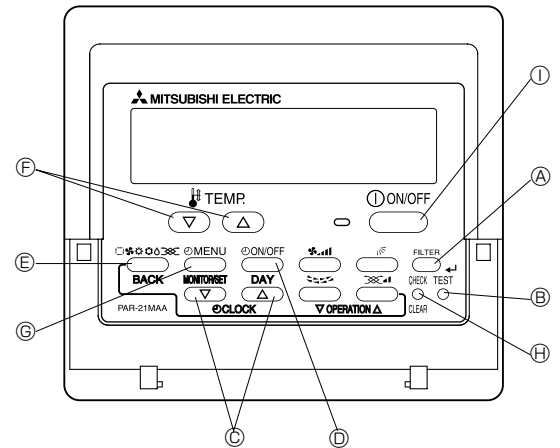

(Alternating Display)

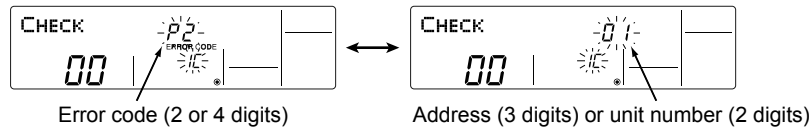

When using remote-/local-controller combined operation, cancel the error code after turning off remote operation. During central control by a MELANS controller, cancel the error code by pressing the **① ON/OFF** button.

### 10-3-4. Self-diagnosis during maintenance or service

Since each unit has a function that stores error codes, the latest check code can be recalled even if it is cancelled by the remote controller or power is turned off.

Check the error code history for each unit using the remote controller.

① Switch to self-diagnosis mode.

Press the **⊕ CHECK** button twice within 3 seconds.  
The display content will change as shown below.

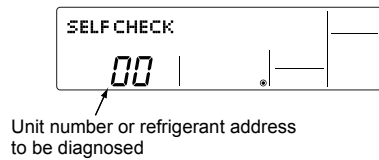

② Set the unit number or refrigerant address you want to diagnose.

Press the **Ⓣ [TEMP]** buttons (**▽** and **△**) to select the desired number or address. The number (address) changes between [01] and [50] or [00] and [15].

③ Display self-diagnosis results.

<When there is error code history>

(For the definition of each error code, refer to the indoor unit's installation manual or service handbook.)

(Alternating Display)

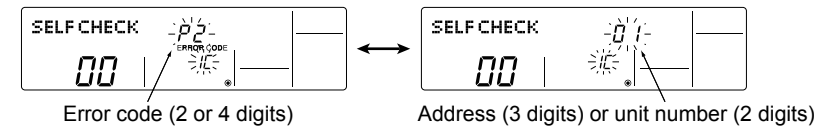

<When there is no error code history>

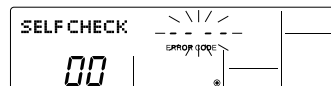

<When there is no corresponding unit>

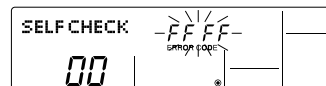

④ Reset the error history.

Display the error history in the diagnosis result display screen (see step ③).

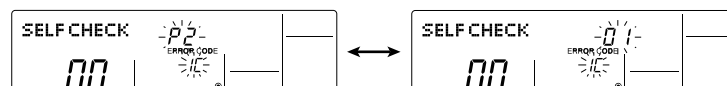

Press the **ON/OFF** button twice within 3 seconds.  
The self-diagnosis address or refrigerant address will blink.

When the error history is reset, the display will look like the one shown below.  
However, if you fail to reset the error history, the error content will be displayed again.

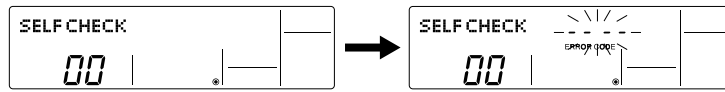

⑤ Cancel self-diagnosis.

Self-diagnosis can be cancelled by the following 2 methods.

- Press the **CHECK** button twice within 3 seconds. → Self-diagnosis will be cancelled and the screen will return to the previous state in effect before the start of self-diagnosis.
- Press the **ON/OFF** button. → Self-diagnosis will be cancelled and the indoor unit will stop.

### 10-3-5. Remote Controller Diagnosis

If the air conditioner cannot be operated from the remote controller, diagnose the remote controller as explained below.

- ① First, check that the power-on indicator is lit.  
If the correct voltage (DC12 V) is not supplied to the remote controller, the indicator will not light.  
If this occurs, check the remote controller's wiring and the indoor unit.

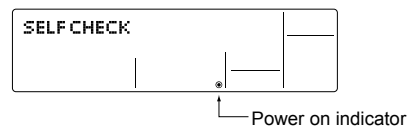

- ② Switch to the remote controller self-diagnosis mode.  
Press the **CHECK** button for 5 seconds or more.  
The display content will change as shown below.

Press the **FILTER** button to start self-diagnosis.

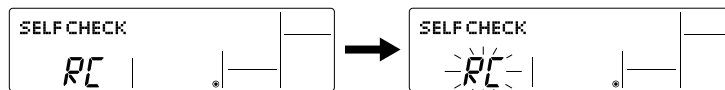

③ Remote controller self-diagnosis result

[When the remote controller is functioning correctly]

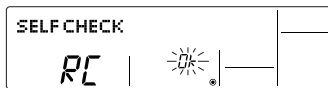

Check for other possible causes, as there is no problem with the remote controller.

[When the remote controller malfunctions]  
(Error display 1) "NG" blinks. → The remote controller's transmitting-receiving circuit is defective.

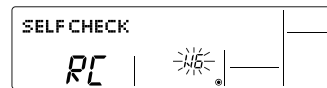

The remote controller must be replaced with a new one.

[Where the remote controller is not defective, but cannot be operated.]  
(Error display 2) [E3], [6833] or [6832] blinks. → Transmission is not possible.

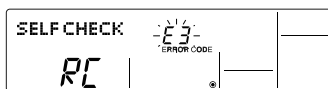

There might be noise or interference on the transmission path, or the indoor unit or other remote controllers are defective. Check the transmission path and other controllers.

(Error display 3) "ERC" and the number of data errors are displayed.  
→ Data error has occurred.

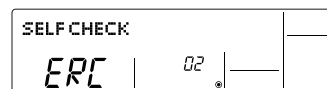

The number of data errors is the difference between the number of bits sent from the remote controller and the number actually transmitted through the transmission path. If such a problem is occurring, the transmitted data is affected by noise, etc. Check the transmission path.

👉 When the number of data errors is "02":  
Transmission data from remote controller   
Transmission data on transmission path

④ To cancel remote controller diagnosis

Press the **CHECK** button for 5 seconds or more. Remote controller diagnosis will be cancelled, "PLEASE WAIT" and operation lamp will blink.  
After approximately 30 seconds, the state in effect before the diagnosis will be restored.

### 10-3-6. Self-diagnosis <wireless remote controller>

#### <In case of trouble during operation>

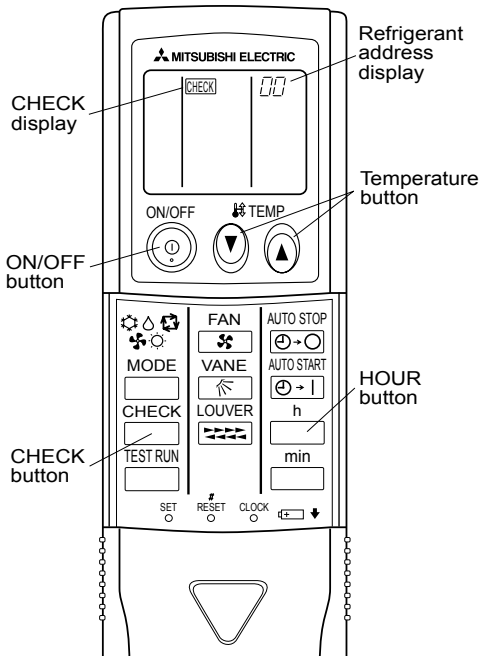

When a malfunction occurs to air conditioner, both indoor unit and outdoor unit will stop and operation lamp blinks to inform unusual stop.

#### <Malfunction-diagnosis method at maintenance service>



#### [Procedure]

1. Press the CHECK button twice.

2. Press the temperature   buttons.

3. Point the remote controller at the sensor on the indoor unit and press the HOOR button.

4. Point the remote controller at the sensor on the indoor unit and press the ON/OFF button.

- "CHECK" lights, and refrigerant address "00" flashes.
- Check that the remote controller's display has stopped before continuing.

- Select the refrigerant address of the indoor unit for the self-diagnosis.
- Note: Set refrigerant address using the outdoor unit's DIP switch (SW1). (For more information, see the outdoor unit installation manual.)

- If an air conditioner error occurs, the indoor unit's sensor emits an intermittent buzzer sound, the operation light flashes, and the error code is output. (It takes 3 seconds at most for error code to appear.)

- The check mode is cancelled.

• Refer to the following tables for details on the check codes.

[Output pattern A]

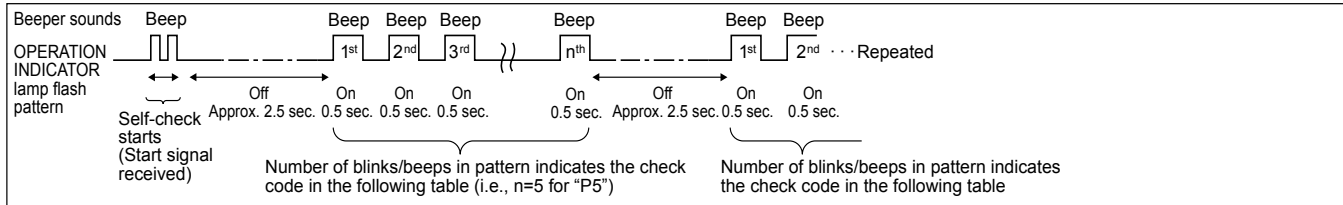

[Output pattern B]

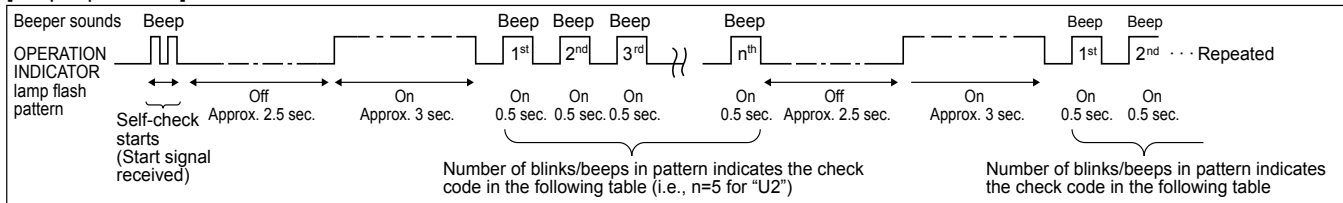

[Output pattern A] Errors detected by indoor unit

Wireless remote controller Beeper sounds/OPERATION INDICATOR lamp flashes (Number of times)	Wired remote controller Check code	Symptom	Remark
1	P1	Intake sensor error	As for indoor unit, refer to indoor unit's service manual.
2	P2	Pipe (TH2) sensor error	
	P9	Pipe (TH5) sensor error	
3	E6,E7	Indoor/outdoor unit communication error	
4	P4	Drain sensor error/Float switch connector (CN4F) open	
5	P5	Drain pump error	
	PA	Forced compressor stop (due to water leakage abnormality)	
6	P6	Freezing/Overheating protection operation	
7	EE	Communication error between indoor and outdoor units	
8	P8	Pipe temperature error	
9	E4, E5	Remote controller signal receiving error	
10	-	-	
11	-	-	
12	Fb	Indoor unit control system error (memory error, etc.)	
14	PL	Abnormality of refrigerant circuit	
-	E0, E3	Remote controller transmission error	
-	E1, E2	Remote controller control board error	

[Output pattern B] Errors detected by unit other than indoor unit (outdoor unit, etc.)

Wireless remote controller Beeper sounds/OPERATION INDICATOR lamp flashes (Number of times)	Wired remote controller Check code	Symptom	Remark
1	E9	Indoor/outdoor unit communication error (Transmitting error) (Outdoor unit)	For details, check the LED display of the outdoor controller board.
2	UP	Compressor overcurrent interruption	
3	U3,U4	Open/short of outdoor unit thermistors	
4	UF	Compressor overcurrent interruption (When compressor locked)	
5	U2	Abnormal high discharging temperature/insufficient refrigerant	
6	U1,Ud	Abnormal high pressure (63H operated)/Overheating protection operation	
7	U5	Abnormal temperature of heatsink	
8	U8	Outdoor unit fan protection stop	
9	U6	Compressor overcurrent interruption/Abnormal of power module	
11	U9,UH	Abnormality such as overvoltage or voltage shortage and abnormal synchronous signal to main circuit/Current sensor error	
12	-	-	
13	-	-	
14	Others	Other errors (Refer to the technical manual for the outdoor unit.)	

\*1 If the beeper does not sound again after the initial 2 beeps to confirm the self-check start signal was received and the OPERATION INDICATOR lamp does not come on, there are no error records.

\*2 If the beeper sounds 3 times continuously "beep, beep, beep (0.4 + 0.4 + 0.4 sec.)" after the initial 2 beeps to confirm the self-check start signal was received, the specified refrigerant address is incorrect.

## 10-4. SELF-DIAGNOSIS ACTION TABLE

<Abnormalities detected when the power is put on>

(Note 1) Refer to indoor unit section for code P and code E.

Error Code	Abnormal points and detection method	Case	Judgment and action
None	—	<p>① No voltage is supplied to terminal block (TB1) of outdoor unit.</p> <p>a) Power supply breaker is turned off.</p> <p>b) Contact failure or disconnection of power supply terminal</p> <p>c) Open phase (L or N phase)</p> <p>② Electric power is not supplied to power supply terminal of outdoor power circuit board.</p> <p>a) Contact failure of power supply terminal</p> <p>b) Open phase on the outdoor power circuit board (Disconnection of terminal on outdoor power circuit board)</p> <p>③ Electric power is not supplied to outdoor controller circuit board.</p> <p>a) Disconnection of connector (CNDC)</p> <p>④ Disconnection of reactor (ACL)</p> <p>⑤ Defective outdoor power circuit board</p> <p>⑥ Defective outdoor controller circuit board</p>	<p>① Check following items.</p> <p>a) Power supply breaker</p> <p>b) Connection of power supply terminal block. (TB1)</p> <p>c) Connection of power supply terminal block. (TB1)</p> <p>② Check following items.</p> <p>a) Connection of power supply terminal block. (TB1)</p> <p>b) Connection of terminal on outdoor power circuit board.</p> <p>③ Check connection of the connector (CNDC) on the outdoor controller circuit board. Check connection of the connector, LD1 and LD2 on the outdoor power circuit board. Refer to 10-9.</p> <p>④ Check connection of reactor. (ACL) Check connection of "LO" and "NO" on the outdoor noise filter circuit board. Check connection of "R" and "S" on the outdoor power circuit board. Refer to 10-9.</p> <p>⑤ Replace outdoor power circuit board.</p> <p>⑥ Replace controller board (When items above are checked but the units can not be repaired.)</p>
F5 (5201)	<p><b>63H connector open</b></p> <p>Abnormal if 63H connector circuit is open for 3 minutes continuously after power supply.</p> <p>63H: High-pressure switch</p>	<p>① Disconnection or contact failure of 63H connector on outdoor controller circuit board</p> <p>② Disconnection or contact failure of 63H</p> <p>③ 63H is working due to defective parts.</p> <p>④ Defective outdoor controller circuit board</p>	<p>① Check connection of 63H connector on outdoor controller circuit board. Refer to 10-9.</p> <p>② Check the 63H side of connecting wire.</p> <p>③ Check continuity by tester. Replace the parts if the parts are defective.</p> <p>④ Replace outdoor controller circuit board.</p>



Error Code	Abnormal points and detection method	Case	Judgment and action
EA (6844)	<p><b>Miswiring of indoor/outdoor unit connecting wire</b></p> <p>1. Outdoor controller circuit board can automatically check the number of connected indoor units. Abnormal if the number cannot be checked automatically due to miswiring of indoor/outdoor unit connecting wire and etc. after power is turned on for 4 minutes.</p> <p>2. Abnormal if outdoor controller circuit board recognizes excessive number of indoor units.</p>	<p>① Contact failure or miswiring of indoor/outdoor unit connecting wire</p> <p>② Diameter or length of indoor/outdoor unit connecting wire is out of specified capacity.</p> <p>③ Excessive number of indoor units are connected to 1 outdoor unit. (4 units or more)</p> <p>④ Defective transmitting receiving circuit of outdoor controller circuit board</p> <p>⑤ Defective transmitting receiving circuit of indoor controller board</p> <p>⑥ Defective indoor power board</p> <p>⑦ Noise has entered into power supply or indoor/outdoor unit connecting wire.</p>	<p>① Check disconnection or looseness or polarity of indoor/outdoor unit connecting wire of indoor and outdoor units.</p> <p>② Check diameter and length of indoor/outdoor unit connecting wire. Total wiring length: 80 m (including wiring connecting each indoor unit and between indoor and outdoor unit) Also check if the connection order of flat cable is S1, S2, S3.</p> <p>③ Check the number of indoor units that are connected to one outdoor unit. (If EA is detected)</p> <p>④~⑥ Turn the power off once, and on again to check. Replace outdoor controller circuit board, indoor controller board or indoor power board if abnormality occurs again.</p> <p>⑦ Check transmission path, and remove the cause.</p>
Eb (6845)	<p><b>Miswiring of indoor/outdoor unit connecting wire (converse wiring or disconnection)</b></p> <p>Outdoor controller circuit board can automatically set the unit number of indoor units. Abnormal if the indoor unit number can not be set within 4 minutes after power on because of Miswiring (converse wiring or disconnection) of indoor/outdoor unit connecting wire.</p>	<p>① Contact failure or miswiring of indoor/outdoor unit connecting wire</p> <p>② Diameter or length of indoor/outdoor unit connecting wire is out of specified capacity.</p> <p>④ Defective transmitting receiving circuit of outdoor controller circuit board</p> <p>⑤ Defective transmitting receiving circuit of indoor controller board</p> <p>⑥ Defective indoor power board</p> <p>⑦ Noise has entered into power supply or indoor/outdoor unit connecting wire.</p>	<p>* The descriptions above, ①-⑧, are for EA, Eb and EC.</p>
EC (6846)	<p><b>Start-up time over</b></p> <p>The unit cannot finish start-up process within 4 minutes after power on.</p>	<p>① Contact failure of indoor/outdoor unit connecting wire</p> <p>② Diameter or length of indoor/outdoor unit connecting wire is out of specified capacity.</p> <p>⑦ Noise has entered into power supply or indoor/outdoor unit connecting wire.</p>	

<Abnormalities detected while unit is operating>

Error Code	Abnormal points and detection method	Case	Judgment and action
U1 (1302)	<p><b>High pressure (High pressure switch 63H operated)</b> Abnormal if high pressure switch 63H operated (4.15 MPa) during compressor operation.</p> <p>63H: High pressure switch</p>	<ul style="list-style-type: none"> <li>① Short cycle of indoor unit</li> <li>② Clogged filter of indoor unit</li> <li>③ Decreased airflow caused by dirt of indoor fan</li> <li>④ Dirt of indoor heat exchanger</li> <li>⑤ Locked indoor fan motor</li> <li>⑥ Malfunction of indoor fan motor</li> <li>⑦ Defective operation of stop valve (Not full open)</li> <li>⑧ Clogged or broken pipe</li> <li>⑨ Locked outdoor fan motor</li> <li>⑩ Malfunction of outdoor fan motor</li> <li>⑪ Short cycle of outdoor unit</li> <li>⑫ Dirt of outdoor heat exchanger</li> <li>⑬ Decreased airflow caused by defective inspection of outside temperature thermistor (It detects lower temperature than actual temperature.)</li> <li>⑭ Disconnection or contact failure of connector (63H) on outdoor controller board</li> <li>⑮ Disconnection or contact failure of 63H connection</li> <li>⑯ Defective outdoor controller board</li> <li>⑰ Defective action of linear expansion valve</li> <li>⑱ Malfunction of fan driving circuit</li> </ul>	<ul style="list-style-type: none"> <li>①~⑥ Check indoor unit and repair defect.</li> <li>⑦ Check if stop valve is fully open.</li> <li>⑧ Check piping and repair defect.</li> <li>⑨~⑫ Check outdoor unit and repair defect.</li> <li>⑬ Check the detected temperature of outside temperature thermistor on LED display. (SW2 on A-Control Service Tool : Refer to 10-10.)</li> <li>⑭~⑯ Turn the power off and check F5 is displayed when the power is turned again. When F5 is displayed, refer to "Judgment and action" for F5.</li> <li>⑰ Check linear expansion valve. Refer to 10-6.</li> <li>⑱ Replace outdoor controller board.</li> </ul>
U2 (TH4:1102) (TH34:1132)	<p><b>High discharging temperature</b> <b>High comp. surface temperature</b></p> <p>(1) Abnormal if discharge temperature thermistor (TH4) exceeds 125°C or 110°C continuously for 5 minutes. Abnormal if condenser/evaporator temperature thermistor (TH5) exceeds 40°C during defrosting and discharge temperature thermistor (TH4) exceeds 110°C.</p> <p>(2) Abnormal if comp. surface temperature thermistor (TH34) exceeds 125°C or 110°C continuously for 5 minutes.</p>	<ul style="list-style-type: none"> <li>① Overheated compressor operation caused by shortage of refrigerant</li> <li>② Defective operation of stop valve</li> <li>③ Defective thermistor</li> <li>④ Defective outdoor controller board</li> <li>⑤ Defective action of linear expansion valve</li> </ul>	<ul style="list-style-type: none"> <li>① Check intake superheat. Check leakage of refrigerant. Charge additional refrigerant.</li> <li>② Check if stop valve is fully open.</li> <li>③④ Turn the power off and check if U3 is displayed when the power is turned on again. When U3 is displayed, refer to "Judgement and action" for U3.</li> <li>⑤ Check linear expansion valve. Refer to 10-6.</li> </ul>
U3 (TH4:5104) (TH34:5132)	<p><b>Open/short circuit of discharge temperature thermistor (TH4) / comp. surface thermistor (TH34)</b></p> <p>Abnormal if open (3°C or less) or short (217°C or more) is detected during compressor operation. (Detection is inoperative for 17 minutes of compressor starting process and for 17 minutes after and during defrosting.)</p>	<ul style="list-style-type: none"> <li>① Disconnection or contact failure of connector (TH4/TH34) on the outdoor controller circuit board</li> <li>② Defective thermistor</li> <li>③ Defective outdoor controller circuit board</li> </ul>	<ul style="list-style-type: none"> <li>① Check connection of connector (TH4/TH34) on the outdoor controller circuit board. Check breaking of the lead wire for thermistor (TH4/TH34). Refer to 10-9.</li> <li>② Check resistance value of thermistor (TH4/TH34) or temperature by microcomputer. (Thermistor/TH4/TH34: Refer to 10-6.) (SW2 on A-Control Service Tool: Refer to 10-10.)</li> <li>③ Replace outdoor controller board.</li> </ul>



Error Code	Abnormal points and detection method	Case	Judgment and action																							
U4 (TH3:5105) (TH6:5107) (TH7:5106) (TH8:5110)	<b>Open/short of outdoor unit thermistors (TH3, TH6, TH7, and TH8)</b> Abnormal if open or short is detected during compressor operation. Open detection of thermistors TH3 and TH6 is inoperative for 10 seconds to 10 minutes after compressor starting and 10 minutes after and during defrosting. * Check which unit has abnormality in its thermistor by switching the mode of SW2. (PAC-SK52ST) (Refer to 10-10.)	① Disconnection or contact failure of connectors ( Outdoor controller circuit board: TH3, TH6/TH7 Outdoor power circuit board: CN3 ) ② Defective thermistor ③ Defective outdoor controller circuit board	① Check connection of connector (TH3,TH6/TH7) on the outdoor controller circuit board. Check connection of connector (CN3) on the outdoor power circuit board. Check breaking of the lead wire for thermistor (TH3,TH6,TH7,TH8). Refer to 10-9. ② Check resistance value of thermistor (TH3,TH6,TH7,TH8) or check temperature by microcomputer. (Thermistor/TH3,TH6,TH7,TH8: Refer to 10-6.) (SW2 on A-Control Service Tool: Refer to 10-10.) ③ Replace outdoor controller circuit board. * Emergency operation is available in case of abnormalities of TH3, TH6 and TH7. Refer to 10-8.																							
	<table border="1" style="width: 100%; text-align: center;"> <thead> <tr> <th colspan="2">Thermistors</th> <th>Open detection</th> <th>Short detection</th> </tr> <tr> <th>Symbol</th> <th>Name</th> <th></th> <th></th> </tr> </thead> <tbody> <tr> <td>TH3</td> <td>Thermistor &lt;Outdoor pipe&gt;</td> <td>- 40°C or below</td> <td>90°C or above</td> </tr> <tr> <td>TH6</td> <td>Thermistor &lt;Outdoor 2-phase pipe&gt;</td> <td>- 40°C or below</td> <td>90°C or above</td> </tr> <tr> <td>TH7</td> <td>Thermistor &lt;Outdoor&gt;</td> <td>- 40°C or below</td> <td>90°C or above</td> </tr> <tr> <td>TH8</td> <td>Thermistor &lt;Heatsink&gt;</td> <td>- 35°C or below</td> <td>102°C or above</td> </tr> </tbody> </table>		Thermistors		Open detection	Short detection	Symbol	Name			TH3	Thermistor <Outdoor pipe>	- 40°C or below	90°C or above	TH6	Thermistor <Outdoor 2-phase pipe>	- 40°C or below	90°C or above	TH7	Thermistor <Outdoor>	- 40°C or below	90°C or above	TH8	Thermistor <Heatsink>	- 35°C or below	102°C or above
Thermistors		Open detection	Short detection																							
Symbol	Name																									
TH3	Thermistor <Outdoor pipe>	- 40°C or below	90°C or above																							
TH6	Thermistor <Outdoor 2-phase pipe>	- 40°C or below	90°C or above																							
TH7	Thermistor <Outdoor>	- 40°C or below	90°C or above																							
TH8	Thermistor <Heatsink>	- 35°C or below	102°C or above																							
U5 (4230)	<b>Temperature of heatsink</b> Abnormal if heatsink thermistor (TH8) detects temperature indicated below. FRP71 .....77°C	① The outdoor fan motor is locked. ② Failure of outdoor fan motor ③ Air flow path is clogged. ④ Rise of ambient temperature ⑤ Defective thermistor ⑥ Defective input circuit of outdoor power circuit board ⑦ Failure of outdoor fan drive circuit	①② Check outdoor fan. ③ Check air flow path for cooling. ④ Check if there is something which causes temperature rise around outdoor unit. (Upper limit of ambient temperature is 46°C.) Turn off power, and on again to check if U5 is displayed within 30 minutes. If U4 is displayed instead of U5, follow the action to be taken for U4. ⑤ Check resistance value of thermistor (TH8) or temperature by microcomputer. (Thermistor/TH8: Refer to 10-6.) (SW2 on A-Control Service Tool: Refer to 10-10.) ⑥ Replace outdoor power circuit board. ⑦ Replace outdoor controller circuit board.																							
U6 (4250)	<b>Power module</b> Check abnormality by driving power module in case overcurrent is detected. (UF or UP error condition)	① Outdoor stop valve is closed. ② Decrease of power supply voltage ③ Looseness, disconnection or converse of compressor wiring connection ④ Defective compressor ⑤ Defective outdoor power circuit board	① Open stop valve. ② Check facility of power supply. ③ Correct the wiring (U·V·W phase) to compressor. Refer to 10-9 (Outdoor power circuit board). ④ Check compressor referring to 10-6. ⑤ Replace outdoor power circuit board.																							
U8 (4400)	<b>Outdoor fan motor</b> Abnormal if rotational frequency of the fan motor is not detected during DC fan motor operation. Fan motor rotational frequency is abnormal if; <ul style="list-style-type: none"> <li>• 100 rpm or below detected continuously for 15 seconds at 20°C or more outside air temperature.</li> <li>• 50 rpm or below or 1500 rpm or more detected continuously for 1 minute.</li> </ul>	① Failure in the operation of the DC fan motor ② Failure in the outdoor circuit controller board	① Check or replace the DC fan motor. ② Check the voltage of the outdoor circuit controller board during operation. ③ Replace the outdoor circuit controller board. (when the failure is still indicated even after performing the action ① above.)																							





Error Code	Abnormal point and detection method	Case	Judgment and action	
U9 (4220)	Detailed codes	To find out the detail history (latest) about U9 error, turn ON SW2-1, 2-2, 2-6. Refer to 10-10.		
	01	<b>Overvoltage error</b> • Increase in DC bus voltage to 420V	① Abnormal increase in power source voltage ② Disconnection of compressor wiring  ③ Defective outdoor power circuit board ④ Compressor has a ground fault.	① Check the field facility for the power supply. ② Correct the wiring (U·V·W phase) to compressor. Refer to 10-9 (Outdoor power circuit board). ③ Replace outdoor power circuit board. ④ Check compressor for electrical insulation. Replace compressor.
	02	<b>Undervoltage error</b> • Instantaneous decrease in DC bus voltage to 200V	① Decrease in power source voltage, instantaneous stop. ② Disconnection or loose connection of CN52C on the outdoor noise filter circuit board/controller circuit board ③ Defective converter drive circuit of outdoor power circuit board ④ Defective 52C drive circuit in outdoor noise filter circuit board	① Check the field facility for the power supply. ② Check CN52C wiring.  ③ Replace outdoor power circuit board. ④ Replace outdoor noise filter circuit board.
	04	<b>Input current sensor error/ L1-phase open error</b> • Decrease in input current through outdoor unit to 0.1A only if operation frequency is more than or equal to 40Hz or compressor current is more than or equal to 6A.	① Disconnection or loose connection between TB1 and outdoor noise filter circuit board ② Disconnection or loose connection of CN5 on the outdoor power circuit board/CNCT on the outdoor noise filter board ③ Defective ACCT(AC current trans) on the outdoor noise filter circuit board ④ Defective input current detection circuit of outdoor power circuit board ⑤ Defective outdoor controller circuit board	① Check the wiring between TB1 and outdoor noise filter circuit board ② Check CN5 wiring.  ③ Replace outdoor noise filter circuit board. ④ Replace outdoor power circuit board. ⑤ Replace outdoor controller circuit board.
	08	<b>Abnormal power synchronous signal</b> • No input of power synchronous signal to power circuit board • Power synchronous signal of 44 Hz or less, or 65 Hz or more is detected on power circuit board.	① Distortion of power source voltage, Noise superimposition. ② Disconnection or loose connection of earth wiring ③ Disconnection or loose connection of CN2 on the outdoor power circuit board /controller circuit board ④ Defective power synchronous signal circuit in outdoor controller circuit board ⑤ Defective power synchronous signal circuit in outdoor power circuit board	① Check the field facility for the power supply. ② Check earth wiring. ③ Check CN2 wiring.  ④ Replace outdoor controller circuit board. ⑤ Replace outdoor power circuit board.
	10	<b>PFC error (Overvoltage/ Undervoltage/Overcurrent)</b> • PFC detected any of the followings a) Increase in DC bus voltage to 420V b) Decrease in PFC control voltage to 12V DC or lower c) Increase in input current to 50A peak	① Abnormal increase in power source voltage ② Decrease in power source voltage, instantaneous stop. ③ Disconnection of compressor wiring ④ Misconnection of reactor (ACL) ⑤ Defective outdoor power circuit board ⑥ Defective Reactor(ACL) ⑦ Disconnection or loose connection of CN2 on the outdoor power circuit board/controller circuit board	①② Check the field facility for the power supply.  ③ Correct the wiring (U·V·W phase) to compressor. Refer to 10-9 (Outdoor power circuit board). ④ Correct the wiring of reactor (ACL) ⑤ Replace outdoor power circuit board. ⑥ Replace Reactor (ACL). ⑦ Check CN2 wiring.
	20	<b>PFC/IGBT error (Undervoltage)</b> • When Compressor is running, DC bus voltage stays at 310V or lower for consecutive 10 seconds.	① Incorrect switch settings on the outdoor controller circuit board for model select ② Defective outdoor power circuit board ③ Defective outdoor controller circuit board	① Correction of a model select  ② Replace outdoor power circuit board. ③ Replace outdoor controller circuit board.



Error Code	Abnormal point and detection method	Case	Judgment and action
Ud (1504)	<b>Over heat protection</b> Abnormal if outdoor pipe thermistor (TH3) detects 70°C or more during compressor operation.	① Defective outdoor fan (fan motor) or short cycle of outdoor unit during cooling operation ② Defective outdoor pipe thermistor (TH3) ③ Defective outdoor controller board	① Check outdoor unit air passage.  ②③ Turn the power off and on again to check the error code. If U4 is displayed, follow the U4 processing direction.
UE (1509)	<b>Abnormal pressure of pressure sensor (63HS)</b> Abnormal if pressure sensor (63HS) detects 0.1 MPa or less. Detection is inoperative for 3 minutes after compressor starting and 3 minutes after and during defrosting.	① Disconnection or contact failure of connector (63HS) on the outdoor controller circuit board ② Defective pressure sensor  ③ Defective outdoor controller circuit board	① Check connection of connector (63HS) on the outdoor controller circuit board. Check breaking of the lead wire for thermistor (63HS). ② Check pressure by microprocessor. (Pressure sensor/ 63HS) (SW2: Refer to 10-10.) ③ Replace outdoor controller board.
UF (4100)	<b>Compressor overcurrent interruption (When compressor locked)</b> Abnormal if overcurrent of DC bus or compressor is detected within 30 seconds after compressor starts operating.	① Stop valve is closed. ② Decrease of power supply voltage ③ Looseness, disconnection or converse of compressor wiring connection ④ Defective compressor ⑤ Defective outdoor power board ⑥ Dip switch setting difference of outdoor controller circuit board.	① Open stop valve. ② Check facility of power supply.  ③ Correct the wiring (U-V-W phase) to compressor. Refer to 10-9 (Outdoor power circuit board). ④ Check compressor. Refer to 10-6. ⑤ Replace outdoor power circuit board. ⑥ Check the dip switch setting of outdoor controller circuit board. Refer to "Model Select" in "1) Function of switches" in 10-10.
UH (5300)	<b>Current sensor error or input current error</b> • Abnormal if 38A of input current is detected or 34A or more of input current is detected for 10 seconds continuously.	① Defective circuit of current sensor on outdoor power circuit board ② Decrease of power supply voltage	① Replace outdoor power circuit board.  ② Check the facility of power supply.
UP (4210)	<b>Compressor overcurrent interruption</b> Abnormal if overcurrent DC bus or compressor is detected after compressor starts operating for 30 seconds.	① Stop valve of outdoor unit is closed. ② Decrease of power supply voltage ③ Looseness, disconnection or converse of compressor wiring connection ④ Defective fan of indoor/outdoor units ⑤ Short cycle of indoor/outdoor units ⑥ Defective input circuit of outdoor controller board ⑦ Defective compressor ⑧ Defective outdoor power circuit board ⑨ Dip switch setting difference of outdoor controller circuit board	① Open stop valve. ② Check facility of power supply.  ③ Correct the wiring (U-V-W phase) to compressor. Refer to 10-9 (Outdoor power circuit board). ④ Check indoor/outdoor fan. ⑤ Solve short cycle. ⑥ Replace outdoor controller circuit board. ⑦ Check compressor. Refer to 10-6. * Before the replacement of the outdoor controller circuit board, disconnect the wiring to compressor from the outdoor power circuit board and check the output voltage among phases, U, V, W, during test run. No defect on board if voltage among phases (U-V, V-W and W-U) is same. Make sure to perform the voltage check with same performing frequency. ⑧ Replace outdoor power circuit board ⑨ Check the dip switch setting of outdoor controller circuit board



Error Code	Abnormal points and detection method	Case	Judgment and action
E0 or E4 (6831)	<p><b>Remote controller transmission error (E0)/signal receiving error (E4)</b></p> <p>① Abnormal if main or sub remote controller cannot receive normally any transmission from indoor unit of refrigerant address "0" for 3 minutes. (Error code : E0)</p> <p>② Abnormal if sub remote controller could not receive any signal for 2 minutes. (Error code: E0)</p> <p>① Abnormal if indoor controller board can not receive normally any data from remote controller board or from other indoor controller board for 3 minutes. (Error code: E4)</p> <p>② Indoor controller board cannot receive any signal from remote controller for 2 minutes. (Error code: E4)</p>	<p>① Contact failure at transmission wire of remote controller</p> <p>② All remote controllers are set as "sub" remote controller. In this case, E0 is displayed on remote controller, and E4 is displayed at LED (LED1, LED2) on the outdoor controller circuit board.</p> <p>③ Miswiring of remote controller</p> <p>④ Defective transmitting receiving circuit of remote controller</p> <p>⑤ Defective transmitting receiving circuit of indoor controller board of refrigerant address "0"</p> <p>⑥ Noise has entered into the transmission wire of remote controller.</p>	<p>① Check disconnection or looseness of indoor unit or transmission wire of remote controller.</p> <p>② Set one of the remote controllers "main" if there is no problem with the action above.</p> <p>③ Check wiring of remote controller.</p> <ul style="list-style-type: none"> <li>• Total wiring length: max. 500m (Do not use cable × 3 or more.)</li> <li>• The number of connecting indoor units: max. 16 units</li> <li>• The number of connecting remote controller: max. 2 units</li> </ul> <p>When it is not the above-mentioned problem of ①~③</p> <p>④ Diagnose remote controllers.</p> <p>a) When "RC OK" is displayed, remote controllers have no problem. Turn the power off, and on again to check. If abnormality generates again, replace indoor controller board.</p> <p>b) When "RC NG" is displayed, replace remote controller.</p> <p>c) When "RC E3" or "ERC 00-66" is displayed, noise may be causing abnormality.</p> <p>* If the unit is not normal after replacing indoor controller board in group control, indoor controller board of address "0" may be abnormal.</p>
E1 or E2	<p><b>Remote controller control board</b></p> <p>① Abnormal if data cannot be normally read from the nonvolatile memory of the remote controller control board. (Error code: E1)</p> <p>② Abnormal if the clock function of remote controller cannot be normally operated. (Error code: E2)</p>	<p>① Defective remote controller</p>	<p>① Replace remote controller.</p>
E3 or E5 (6831)	<p><b>Remote controller transmission error (E3)/signal receiving error (E5)</b></p> <p>① Abnormal if remote controller could not find blank of transmission path for 6 seconds and could not transmit. (Error code: E3)</p> <p>② Remote controller receives transmitted data at the same time, compares the data, and when detecting it, judges different data to be abnormal 30 continuous times. (Error code: E3)</p> <p>① Abnormal if indoor controller board could not find blank of transmission path. (Error code: E5)</p> <p>② Indoor controller board receives transmitted data at the same time, compares the data, and when detecting it, judges different data to be abnormal 30 continuous times. (Error code: E5)</p>	<p>① 2 remote controller are set as "main." (When connecting 2 remote controllers)</p> <p>② Remote controller is connected with 2 indoor units or more.</p> <p>③ Repetition of refrigerant address</p> <p>④ Defective transmitting receiving circuit of remote controller</p> <p>⑤ Defective transmitting receiving circuit of indoor controller board</p> <p>⑥ Noise has entered into transmission wire of remote controller.</p>	<p>① Set a remote controller to main, and the other to sub.</p> <p>② Remote controller is connected with only one indoor unit.</p> <p>③ The address changes to a separate setting.</p> <p>④~⑥ Diagnose remote controller.</p> <p>a) When "RC OK" is displayed, remote controllers have no problem. Turn the power off, and on again to check. When becoming abnormal again, replace indoor controller board.</p> <p>b) When "RC NG" is displayed, replace remote controller.</p> <p>c) When "RC E3" or "ERC 00-66" is displayed, noise may be causing abnormality.</p>

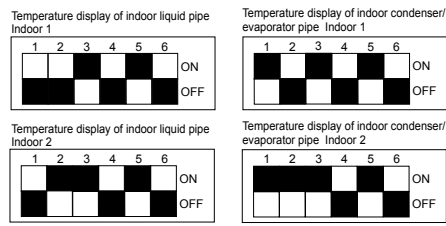

Error Code	Abnormal points and detection method	Case	Judgment and action
E6 (6840)	<b>Indoor/outdoor unit communication error (Signal receiving error)</b> ① Abnormal if indoor controller board could not receive any signal normally for 6 minutes after turning the power on. ② Abnormal if indoor controller board could not receive any signal normally for 3 minutes. ③ Consider the unit as abnormal under the following condition. When 2 or more indoor units are connected to an outdoor unit, indoor controller board could not receive a signal for 3 minutes from outdoor controller circuit board, a signal which allows outdoor controller circuit board to transmit signals.	① Contact failure, short circuit or miswiring (converse wiring) of indoor/outdoor unit connecting wire ② Defective transmitting receiving circuit of outdoor controller circuit board. ③ Defective transmitting receiving circuit of indoor controller board. ④ Noise has entered into indoor/outdoor unit connecting wire. ⑤ Defective fan motor ⑥ Defective rush current resistor of outdoor power circuit board	* Check LED display on outdoor controller circuit board. (Connect A-Control service tool (PAC-SK52ST)) Refer to EA~EC item if LED displays EA~AC. ① Check disconnecting or looseness of indoor/outdoor unit connecting wire of indoor unit or outdoor unit. Check all the units in case of twin/triple/quadruple indoor unit system. ②~④ Turn the power off, and on again to check. If abnormality generates again, replace indoor controller board or outdoor controller circuit board. * Other indoor controller board may have defect in case of twin/triple/quadruple indoor unit system. ⑤ Turn the power off, and detach fan motor from connector (CNF1, 2). Then turn the power on again. If abnormality is not displayed, replace fan motor. If abnormality is displayed, replace outdoor controller circuit board. ⑥ Check the rush current resistor on outdoor power circuit board with tester. If open is detected, replace the power circuit board.
E7 (6842)	<b>Indoor/outdoor unit communication error (Transmitting error)</b> Abnormal if "1" receiving is detected 30 times continuously though indoor controller board has transmitted "0".	① Defective transmitting receiving circuit of indoor controller board ② Noise has entered into power supply. ③ Noise has entered into outdoor control wire.	①~③ Turn the power off, and on again to check. If abnormality generates again, replace indoor controller board.
E8 (6843)	<b>Indoor/outdoor unit communication error (Signal receiving error) (Outdoor unit)</b> Abnormal if outdoor controller circuit board could not receive anything normally for 3 minutes.	① Contact failure of indoor/outdoor unit connecting wire ② Defective communication circuit of outdoor controller circuit board ③ Defective communication circuit of indoor controller board ④ Noise has entered into indoor/outdoor unit connecting wire.	① Check disconnection or looseness of indoor/outdoor unit connecting wire of indoor or outdoor units. ②~④ Turn the power off, and on again to check. Replace indoor controller board or outdoor controller circuit board if abnormality is displayed again.
E9 (6841)	<b>Indoor/outdoor unit communication error (Transmitting error) (Outdoor unit)</b> ① Abnormal if "0" receiving is detected 30 times continuously though outdoor controller circuit board has transmitted "1". ② Abnormal if outdoor controller circuit board could not find blank of transmission path for 3 minutes.	① Indoor/outdoor unit connecting wire has contact failure. ② Defective communication circuit of outdoor controller circuit board ③ Noise has entered power supply. ④ Noise has entered indoor/outdoor unit connecting wire.	① Check disconnection or looseness of indoor/outdoor unit connecting wire. ②~④ Turn the power off, and on again to check. Replace outdoor controller circuit board if abnormality is displayed again.
EE (7130)	<b>Reverse connection of ATA/ATW communication wire</b> Abnormal if communication wire of ATA side and FTC side are connected in reverse.	① Each S1, S2, S3 of TB1 and TB2 are connected in reverse. ② The connection from TB1 and TB2 to indoor controller board CNS and CNS2 are in reverse.	① Correct the wiring according to 7. WIRING DIAGRAM. ( TB1 — Indoor unit ) ( TB2 — Cylinder/Hydrobox unit ) ② Correct the wiring according to 7. WIRING DIAGRAM. ( TB1 — CNS ) ( TB2 — CNS2 )
EF (6607 or 6608)	<b>Non defined error code</b> This code is displayed when non defined error code is received.	① Noise has entered transmission wire of remote controller. ② Noise has entered indoor/outdoor unit connecting wire. ③ Outdoor unit is not a series of power-inverter. ④ Model name of remote controller is PAR-S25A.	①② Turn the power off, and on again to check. Replace indoor controller board or outdoor controller circuit board if abnormality is displayed again. ③ Replace outdoor unit with power-inverter type outdoor unit. ④ Replace remote controller with MA remote controller.

Error Code	Abnormal points and detection method	Case	Judgment and action
Ed (0403)	<b>Serial communication error</b> ① Abnormal if serial communication between outdoor controller circuit board and outdoor power circuit board is defective.	① Breaking of wire or contact failure of connector CN2 between the outdoor controller circuit board and the outdoor power circuit board ② Breaking of wire or contact failure of connector CN4 between the outdoor controller circuit board and the outdoor power circuit board ③ Defective communication circuit of outdoor power circuit board ④ Defective communication circuit of outdoor controller circuit board for outdoor power circuit board	①② Check connection of each connector CN2 and CN4 between the outdoor controller circuit board and the outdoor power circuit board.  ③ Replace outdoor power circuit board. ④ Replace outdoor controller circuit board.
	② Abnormal if communication between outdoor controller circuit board and M-NET board is not available.	① Breaking of wire or contact failure of connector between outdoor controller circuit board and M-NET board ② Contact failure of M-NET board power supply line ③ Noise has entered into M-NET transmission wire.	① Check disconnection, looseness, or breaking of connection wire between outdoor controller circuit board (CNMNT) and M-NET board (CN5). ② Check disconnection, looseness, or breaking of connection wire between outdoor controller circuit board (CNMNT) and M-NET board (CND). ③ Check M-NET transmission wiring method.
P8	<b>Pipe temperature</b> <b>&lt;Cooling mode&gt;</b> Detected as abnormal when the pipe temperature is not in the cooling range 3 minutes after compressor start and 6 minutes after the liquid or condenser/evaporator pipe is out of cooling range. Note 1) It takes at least 9 minutes to detect. Note 2) Abnormality P8 is not detected in drying mode. Cooling range : Indoor pipe temperature (TH2 or TH5) – intake temperature (TH1) $\leq$ -3 deg TH: Lower temperature between liquid pipe temperature and condenser/evaporator temperature  <b>&lt;Heating mode&gt;</b> When 10 seconds have passed after the compressor starts operation and the hot adjustment mode has finished, the unit is detected as abnormal when condenser/evaporator pipe temperature is not in heating range within 20 minutes.  Note 3) It takes at least 27 minutes to detect abnormality. Note 4) It excludes the period of defrosting (Detection restarts when defrosting mode is over) Heating range : 3 deg $\leq$ (Condenser/Evaporator temperature(TH5) – intake temperature(TH1))	① Slight temperature difference between indoor room temperature and pipe <liquid or condenser / evaporator> temperature thermistor • Shortage of refrigerant • Disconnected holder of pipe <liquid or condenser / evaporator> thermistor • Defective refrigerant circuit ② Converse connection of extension pipe (on plural units connection) ③ Converse wiring of indoor/outdoor unit connecting wire (on plural units connection) ④ Defective detection of indoor room temperature and pipe <condenser / evaporator> temperature thermistor ⑤ Stop valve is not opened completely.	①~④ Check pipe <liquid or condenser / evaporator> temperature with room temperature display on remote controller and outdoor controller circuit board. Pipe <liquid or condenser / evaporator> temperature display is indicated by setting SW2 of outdoor controller circuit board as follows. (Conduct temperature check with outdoor controller circuit board after connecting 'A-Control Service Tool (PAC-SK52ST)'. )  ②③ Check converse connection of extension pipe or converse wiring of indoor/outdoor unit connecting wire.
PL	<b>Abnormal refrigerant circuit</b> During Cooling, Dry, or Auto Cooling operation, when the following are regarded as failures when detected for one second. a) The compressor continues to run for 30 or more seconds. b) The liquid pipe temperature or the condense/evaporator temperature is 75°C or more. <u>*These detected errors will not be cancelled until the power source is reset.</u>	① Abnormal operation of 4-way valve ② Disconnection of or leakage in refrigerant pipes ③ Air into refrigerant piping  ④ Abnormal operation (no rotation) of indoor fan • Defective fan motor. • Defective indoor control board. ⑤ Defective refrigerant circuit (clogging)	① <u>When this error occurs, be sure to replace the 4-way valve.</u> ② Check refrigerant pipes for disconnection or leakage. ③ After the recovery of refrigerant, vacuum dry the whole refrigerant circuit. ④ Refer to section 10-6 HOW TO CHECK THE PARTS.  ⑤ Check refrigerant circuit for operation. <u>*To avoid entry of moisture or air into refrigerant circuit which could cause abnormal high pressure, purge air in refrigerant circuit or replace refrigerant.</u>

## 10-5. TROUBLESHOOTING OF PROBLEMS

Phenomena	Factor	Countermeasure
1. Remote controller display does not work.	<ul style="list-style-type: none"> <li>① DC12V is not supplied to remote controller. (Power supply display ● is not indicated on LCD.)</li> <li>② DC12~15V is supplied to remote controller, however, no display is indicated. <ul style="list-style-type: none"> <li>• "PLEASE WAIT" is not displayed.</li> <li>• "PLEASE WAIT" is displayed.</li> </ul> </li> </ul>	<ul style="list-style-type: none"> <li>① Check LED2 on indoor controller board. <ul style="list-style-type: none"> <li>(1) When LED2 is lit. Check the remote controller wiring for breaking or contact failure.</li> <li>(2) When LED2 is blinking. Check short circuit of remote controller wiring.</li> <li>(3) When LED2 is not lit. Refer to phenomena No.3 below.</li> </ul> </li> <li>② Check the following. <ul style="list-style-type: none"> <li>• Failure of remote controller if "PLEASE WAIT" is not displayed</li> <li>• Refer to phenomena No.2 below if "PLEASE WAIT" is displayed.</li> </ul> </li> </ul>
2. "PLEASE WAIT" display is remained on the remote controller.	<ul style="list-style-type: none"> <li>① At longest 2 minutes after the power supply "PLEASE WAIT" is displayed to start up.</li> <li>② Communication error between the remote controller and indoor unit</li> <li>③ Communication error between the indoor and outdoor unit</li> <li>④ Outdoor unit protection device connector is open.</li> </ul>	<ul style="list-style-type: none"> <li>① Normal operation</li> <li>② Self-diagnosis of remote controller</li> <li>③ "PLEASE WAIT" is displayed for 6 minutes at most in case of indoor/outdoor unit communication error. Check LED3 on indoor controller board. <ul style="list-style-type: none"> <li>(1) When LED3 is not blinking. Check indoor/outdoor connecting wire for Miswiring. (Converse wiring of S1 and S2, or break of S3 wiring.)</li> <li>(2) When LED3 is blinking. Indoor/outdoor connecting wire is normal.</li> </ul> </li> <li>④ Check LED display on outdoor controller circuit board. Refer to 10-10. Check protection device connector (63H) for contact failure. Refer to 10-9.</li> </ul>
3. When pressing the remote controller operation switch, the OPERATION display is appeared but it will be turned off soon.	<ul style="list-style-type: none"> <li>① After cancelling to select function from the remote controller, the remote controller operation switch will be not accepted for approx. 30 seconds.</li> </ul>	<ul style="list-style-type: none"> <li>① Normal operation</li> </ul>
4. Even controlling by the wireless remote controller, no beep is heard and the unit does not start operating. Operation display is indicated on wireless remote controller.	<ul style="list-style-type: none"> <li>① The pair number settings of the wireless remote controller and indoor controller board are mismatched.</li> </ul>	<ul style="list-style-type: none"> <li>① Check the pair number settings.</li> </ul>
5. When operating by the wireless remote controller, beep sound is heard, however, unit does not start operating.	<ul style="list-style-type: none"> <li>① No operation for 2 minutes at most after the power supply ON.</li> <li>② Local remote controller operation is prohibited. <ul style="list-style-type: none"> <li>• Remote controlling adaptor is connected to CN32 on the indoor controller board.</li> <li>• Local remote controller operation is prohibited by centralised controller etc. since it is connected to MELANS.</li> </ul> </li> <li>③ Phenomena of No.2.</li> </ul>	<ul style="list-style-type: none"> <li>① Normal operation</li> <li>② Normal operation</li> <li>③ Check the phenomena No.2.</li> </ul>



Phenomena	Factor	Countermeasure
<p>6. Remote controller display works normally and the unit performs cooling operation, however, the capacity cannot be fully obtained. (The air does not cool well.)</p>	<p>① Refrigerant shortage            ② Filter clogging            ③ Heat exchanger clogging            ④ Air duct short cycle</p>	<p>① • If refrigerant leaks, discharging temperature rises and LEV opening increases. Inspect leakage by checking the temperature and opening.            • Check pipe connections for gas leakage.            ② Open intake grille and check the filter. Clean the filter by removing dirt or dust on it.            ③ • If the filter is clogged, indoor pipe temperature rises and discharging pressure increases. Check if heat exchanger is clogged by inspecting discharging pressure.            • Clean the heat exchanger.            ④ Remove the blockage.</p>
<p>7. Remote controller display works normally and the unit performs heating operation, however, the capacity cannot be fully obtained.</p>	<p>① Linear expansion valve fault            Opening cannot be adjusted well due to linear expansion valve fault.            ② Refrigerant shortage            ③ Lack of insulation for refrigerant piping            ④ Filter clogging            ⑤ Heat exchanger clogging            ⑥ Air duct short cycle            ⑦ Bypass circuit of outdoor unit fault</p>	<p>① • Discharging temperature and indoor heat exchanger temperature does not rise. Inspect the failure by checking discharging pressure.            • Replace linear expansion valve.            ② • If refrigerant leaks, discharging temperature rises and LEV opening increases. Inspect leakage by checking the temperature and opening.            • Check pipe connections for gas leakage.            ③ Check the insulation.            ④ Open intake grille and check the filter. Clean the filter by removing dirt or dust on it.            ⑤ • If the filter is clogged, indoor pipe temperature rises and discharging pressure increases. Check if heat exchanger is clogged by inspecting discharging pressure.            • Clean the heat exchanger.            ⑥ Remove the blockage.            ⑦ Check refrigerant system during operation.</p>
<p>8. ① For 3 minutes after temperature adjuster turns off, the compressor will not start operating even if temperature adjuster is turned on.            ② For 3 minutes after temperature adjuster turns on, the compressor will not stop operating even if temperature adjuster is turned off. (Compressor stops operating immediately when turning off by the remote controller.)</p>	<p>①② Normal operation            (For protection of compressor)</p>	<p>①② Normal operation</p>

**Symptoms: "PLEASE WAIT" is kept being displayed on the remote controller.**

Diagnosis flow	Cause	Inspection method and troubleshooting
<pre> graph TD     Start[Check the display time of "PLEASE WAIT" after turning on the main power.] --&gt; D1{How long is "PLEASE WAIT" kept being displayed on the remote controller?}     D1 -- "6 minutes or more" --&gt; Step1[Check the LED display of the outdoor controller circuit board.]     D1 -- "2 to 6 minutes" --&gt; D2{Are any error codes displayed on the remote controller?}     D1 -- "2 minutes or less" --&gt; Cause1["• "PLEASE WAIT" will be displayed during the start-up diagnosis after turning on the main power."]     Step1 --&gt; D3{Are any error codes displayed on the LED?}     D3 -- NO --&gt; Cause2["• Defective indoor controller board • Defective remote controller"]     D3 -- YES --&gt; D2     D2 -- YES --&gt; Cause3["• Miswiring of indoor/outdoor connecting wire • Breaking of indoor/outdoor connecting wire (S3) • Defective indoor controller board • Defective outdoor controller circuit board"]     D2 -- NO --&gt; Cause1     </pre>	<ul style="list-style-type: none"> <li>• "PLEASE WAIT" will be displayed during the start-up diagnosis after turning on the main power.</li> <li>• Miswiring of indoor/outdoor connecting wire</li> <li>• Breaking of indoor/outdoor connecting wire (S3)</li> <li>• Defective indoor controller board</li> <li>• Defective outdoor controller circuit board</li> <li>• Defective indoor controller board</li> <li>• Defective remote controller</li> </ul>	<ul style="list-style-type: none"> <li>• Normal. The start-up diagnosis will be over in around 2 minutes.</li> <li>• Refer to "Self-diagnosis action table" in order to solve the trouble.</li> <li>• In case of communication errors, the display of remote controller may not match the LED display of the outdoor unit.</li> </ul>







**Symptoms: Nothing is displayed on the remote controller ①**

LED display of the indoor controller board  
 LED1 : ○  
 LED2 : ○  
 LED3 : ○





Diagnosis flow	Cause	Inspection method and troubleshooting
<pre>                     graph TD                         Start[Check the voltage between S1 and S2 on the terminal block (TB4) of the indoor unit which is used to connect the indoor unit and the outdoor unit.] --&gt; D1{AC 198V to AC 264V?}                         D1 -- NO --&gt; S1[Check the voltage among L(L3) and N on the terminal block (TB1) of the outdoor power circuit board.]                         D1 -- YES --&gt; S2[Check the voltage of indoor controller board (CN2D).]                         S1 --&gt; D2{AC 198V to AC 264V?}                         D2 -- NO --&gt; C1[• Troubles concerning power supply.]                         D2 -- YES --&gt; S3[Check the voltage between S1 and S2 on the terminal block (TB1) of the outdoor unit which is used to connect the indoor unit and the outdoor unit.]                         S3 --&gt; D3{AC 198V to AC 264V?}                         D3 -- NO --&gt; C2[• Bad wiring of the outdoor controller board. • The fuses on the outdoor controller circuit board are blown.]                         D3 -- YES --&gt; S4[Check the voltage of indoor controller board (CN2D).]                         S4 --&gt; D4{DC 12V to DC 16V?}                         D4 -- YES --&gt; C3[• Bad wiring of the outdoor controller board. • The fuses on the outdoor controller circuit board are blown.]                         D4 -- NO --&gt; S5[Check the voltage of the unit after removing the indoor power board (CN2S).]                         S5 --&gt; D5{DC 12V to DC 16V?}                         D5 -- YES --&gt; C4[• Defective indoor controller board]                         D5 -- NO --&gt; C5[• Miswiring, breaking or poor connection of indoor/outdoor connecting wire • Defective indoor power board]                     </pre>	<ul style="list-style-type: none"> <li>• Troubles concerning power supply.</li> <li>• Bad wiring of the outdoor controller board.</li> <li>• The fuses on the outdoor controller circuit board are blown.</li> <li>• Bad wiring of the outdoor controller board.</li> <li>• The fuses on the outdoor controller circuit board are blown.</li> <li>• Defective indoor controller board</li> <li>• Miswiring, breaking or poor connection of indoor/outdoor connecting wire</li> <li>• Defective indoor power board</li> </ul>	<ul style="list-style-type: none"> <li>• Check the power wiring to the outdoor unit.</li> <li>• Check the breaker.</li> <li>• Check the wiring of the outdoor unit.</li> <li>• Check if the wiring is bad. Check if the fuses are blown. The fuses on the outdoor controller circuit board will be blown when the indoor /outdoor connecting wire short-circuits.</li> <li>• Check if miswiring, breaking or poor contact is causing this problem. Indoor/outdoor connecting wire is polarized 3-core type. Connect the indoor unit and the outdoor unit by wiring each pair of S1, S2 and S3 on the both side of indoor/outdoor terminal blocks.</li> <li>• Replace the indoor controller board.</li> <li>• Check if there is miswiring or breaking of wire.</li> <li>• Replace the indoor power board.</li> </ul>

## Symptoms: Nothing is displayed on the remote controller ②

LED display of the indoor controller board  
 LED1 :   
 LED2 :   
 LED3 :  or 

Diagnosis flow	Cause	Inspection method and troubleshooting
<p>Check the voltage between S1 and S2 on the terminal block (TB4) of the indoor unit which is used to connect the indoor unit and the outdoor unit.</p> <p>AC 198V to AC 264V?</p> <p>NO</p> <p>YES</p> <p>Check the status of the indoor controller board LED3 display.</p> <p>Not lighting.</p> <p>Blinking.</p> <p>Check the looseness or disconnection of the indoor/outdoor connecting wire.</p> <p>Are there looseness or disconnection of the indoor/outdoor connecting wire?</p> <p>YES</p> <p>NO</p> <p>Check the refrigerant address of the outdoor unit. (SW1-3 to 1-6)</p> <p>Is the refrigerant address "0"?</p> <p>NO</p> <p>YES</p> <p>Check the LED display of the outdoor unit after turning on the main power again.</p> <p>Is anything displayed?</p> <p>Not displayed.</p> <p>Displayed.</p> <p>Is "EA" or "Eb" displayed?</p> <p>NO</p> <p>YES</p> <p>Is "E8" displayed?</p> <p>YES</p> <p>NO</p> <p>Can the unit be restarted?</p> <p>Can all the indoor unit be operated?</p> <p>NO</p> <p>YES</p> <p>Check the voltage between S2 and S3 on the terminal block of the outdoor unit.</p> <p>DC 17V to DC 28V?</p> <p>NO</p> <p>YES</p>	<ul style="list-style-type: none"> <li>• Breaking or poor contact of the indoor/outdoor connecting wire</li> <li>• Normal. Only the unit which has the refrigerant address "0" supplies power to the remote controller.</li> <li>• Defective outdoor controller circuit board</li> <li>• Defective outdoor controller circuit board</li> <li>• Defective indoor controller board</li> <li>• Influence of electromagnetic noise</li> <li>• Defective outdoor power circuit board</li> <li>• Defective indoor power board</li> </ul>	<ul style="list-style-type: none"> <li>• Fix the breaking or poor contact of the indoor/outdoor connecting wire.</li> <li>• Set the refrigerant address to "0". In case of the multiple grouping system, recheck the refrigerant address again.</li> <li>• Replace the outdoor controller circuit board.</li> <li>• Replace the outdoor controller circuit board.</li> <li>• Replace the indoor controller board of the indoor unit which doesn't operate.</li> <li>• Not abnormal. There may be the influence of electromagnetic noise. Check the transmission wire and get rid of the causes.</li> <li>• Replace the outdoor power circuit board.</li> <li>• Replace the indoor power board.</li> </ul>

**Symptoms: Nothing is displayed on the remote controller ③**

LED display of the indoor controller board  
 LED1 :   
 LED2 :  or   
 LED3 : 

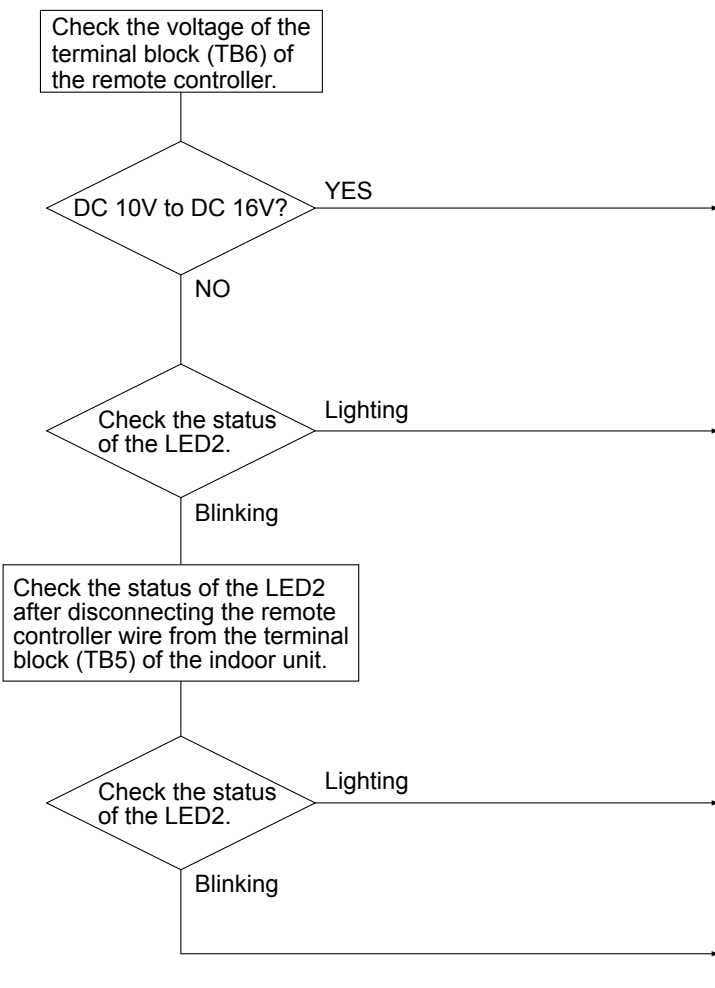
Diagnosis flow	Cause	Inspection method and troubleshooting
 <pre> graph TD     A[Check the voltage of the terminal block (TB6) of the remote controller.] --&gt; B{DC 10V to DC 16V?}     B -- YES --&gt; C[Defective remote controller]     B -- NO --&gt; D{Check the status of the LED2.}     D -- Lighting --&gt; E[Breaking or poor contact of the remote controller wire]     D -- Blinking --&gt; F[Check the status of the LED2 after disconnecting the remote controller wire from the terminal block (TB5) of the indoor unit.]     F --&gt; G{Check the status of the LED2.}     G -- Lighting --&gt; H[The remote controller wire short-circuits]     G -- Blinking --&gt; I[Defective indoor controller board]                     </pre>	<ul style="list-style-type: none"> <li>• Defective remote controller</li> <li>• Breaking or poor contact of the remote controller wire</li> <li>• The remote controller wire short-circuits</li> <li>• Defective indoor controller board</li> </ul>	<ul style="list-style-type: none"> <li>• Replace the remote controller.</li> <li>• Check if there is breaking or poor contact of the remote controller wire. Check the voltage of the terminal block (TB5) connecting the remote controller wire. If it is not between DC 10V and DC16V, the indoor controller board must be defective.</li> <li>• Check if the remote controller wire is short-circuited.</li> <li>• Replace the indoor controller board.</li> </ul>

• Before repair

**Frequent calling from customers**

Phone Calls From Customers		How to Respond	Note
Unit does not operate at all.	① The operating display of remote controller does not come on.	① Check if power is supplied to air conditioner. Nothing appears on the display unless power is supplied.	_____
	② Unit cannot be restarted for a while after it's stopped.	② Wait around 3 minutes to restart unit. The air conditioner is in a state of being protected by the microcomputer's directive. Once the compressor is stopped, the unit cannot be restarted for 3 minutes. This control is also applied when the unit is turned on and off by remote controller.	_____
	③ Error code appears and blinks on the display of remote controller.	③ Error code will be displayed if any protection devices of the air conditioner are actuated. What is error code? -----	Refer to "SELF-DIAGNOSIS ACTION TABLE". ▶Check if servicing is required for the error.
Remote controller	① "PLEASE WAIT" is displayed on the screen.	① Wait around 2 minutes. An automatic startup test will be conducted for 2 minutes when power is supplied to the air conditioner. "PLEASE WAIT" will be kept being displayed while that time.	_____
	② "FILTER" is displayed on the screen.	② This indicates that it is time to clean the air filters. Clean the air filters. Press the FILTER button on the remote controller twice to clear "FILTER" from the display. See the operation manual that came with the product for how to clean the filters.	Display time of "FILTER" depends on the model. Long life filter: 2500 hrs. Standard filter: 100 hrs.
	③ "STANDBY" is displayed on the screen.	③ This is displayed when the unit starts HEAT operation, when the thermostat puts the compressor in operation mode, or when the outdoor unit ends DEFROST operation and returns to HEAT operation. The display will automatically disappear around 10 minutes later. While "STANDBY" is displayed on the remote controller, the airflow amount will be restricted because the indoor unit's heat exchanger is not fully heated up. In addition to that, the up/down vane will be automatically set to horizontal blow in order to prevent cold air from directly blowing out to human body. The up/down vane will return to the setting specified by the remote controller when "STANDBY" is released.	_____
	④ "DEFROST" is displayed on the screen. (No air comes out of the unit.)	④ The outdoor unit gets frosted when the outside temperature is low and the humidity is high. "DEFROST" indicates the DEFROST operation is being performed to melt this frost. The DEFROST operation ends in around 10 minutes (at most 15 minutes). During the DEFROST operation, the indoor unit's heat exchanger becomes cold, so the fan is stopped. The up/down vane will be automatically set to horizontal blow in order to prevent cold air from directly blowing out to human body. The display will turn into "STANDBY" when DEFROST operation ends.	_____



Phone Calls From Customers	How to Respond	Note	
The room cannot be cooled or heated sufficiently.	① Check the set temperature of remote controller. The outdoor unit cannot be operated if the set temperature is not appropriate. The outdoor unit operates in the following modes. COOL: When the set temperature is lower than the room temperature. HEAT: When the set temperature is higher than the room temperature.	_____	
	② Check if filters are not dirty and clogged. If filters are clogged, the airflow amount will be reduced and the unit capacity will be lowered. See the instruction manual that came with the product for how to clean the filters.	_____	
	③ Check there is enough space around the air conditioner. If there are any obstacles in the air intake or air outlet of indoor/outdoor units, they block the airflow direction so that the unit capacity will be lowered.	_____	
Sound comes out from the air conditioner.	① A gas escaping sound is heard sometimes.	① This is not a malfunction. This is the sound which is heard when the flow of refrigerant in the air conditioner is switched.	_____
	② A cracking sound is heard sometimes.	② This is not a malfunction. This is the sound which is heard when internal parts of units expand or contract when the temperature changes.	_____
	③ A buzzing sound is heard sometimes.	③ This is not a malfunction. This is the sound which is heard when the outdoor unit starts operating.	_____
	④ A ticking sound is heard from the outdoor unit sometimes.	④ This is not a malfunction. This is the sound which is heard when the fan of the outdoor unit is controlling the airflow amount in order to keep the optimum operating condition.	_____
	⑤ A sound, similar to water flowing, is heard from the unit.	⑤ This is not a malfunction. This is the sound which is heard when the refrigerant is flowing inside the indoor unit.	_____
Something is wrong with the blower.....	① The fan speed does not match the setting of the remote controller during DRY operation.(No air comes out sometimes during DRY operation.)	① This is not a malfunction. During the DRY operation, the blower's ON/OFF is controlled by the microcomputer to prevent overcooling and to ensure efficient dehumidification. The fan speed cannot be set by the remote controller during DRY operation.	_____
	② The fan speed does not match the setting of the remote controller in HEAT operation.	② This is not a malfunction. 1) When the HEAT operation starts, to prevent the unit from blowing cold air, the fan speed is gradually increased from zero to the set speed, in proportion to the temperature rise of the discharged air. 2) When the room temperature reaches the set temperature and the outdoor unit stops, the unit starts the LOW AIR operation. 3) During the HEAT operation, the DEFROST operation is performed to defrost the outdoor unit. During the DEFROST operation, the blower is stopped to prevent cold air coming out of the indoor unit.	The up/down vane will be automatically set to horizontal blow in these cases listed up on the left (①~③). After a while, the up/down vane will be automatically moved according to the setting of the remote controller.



Phone Calls From Customers	How to Respond	Note
Something is wrong with the blower.....	③ This is not a malfunction. The blower is operating just for cooling down the heated-up air conditioner. This will be done within 1 minute. This control is conducted only when the HEAT operation is stopped with the electric heater ON.	However, this control is also applied to the models which has no electric heater.
Something is wrong with the airflow direction....	① If the up/down vane is set to downward in COOL operation, it will be automatically set to horizontal blow by the microcomputer in order to prevent water from dropping down. "1 Hr." will be displayed on the remote controller if the up/down vane is set to downward with the fan speed set to be less than "LOW".	_____
② The airflow direction is changed during HEAT operation. (The airflow direction cannot be set by remote controller.)	② In HEAT operation, the up/down vane is automatically controlled according to the temperature of the indoor unit's heat exchanger. In the following cases written below, the up/down vane will be set to horizontal blow, and the setting cannot be changed by remote controller. 1) At the beginning of the HEAT operation 2) While the outdoor unit is being stopped by thermostat or when the outdoor unit gets started to operate. 3) During DEFROST operation The airflow direction will be back to the setting of remote controller when the above situations are released.	"STANDBY" will be displayed on the remote controller in case of ① and ②. "DEFROSTING" will be displayed on the screen in case of ③.
③ The airflow direction does not change. (Up/down vane, left/right louver)	③ 1) Check if the vane is set to a fixed position. (Check if the vane motor connector is removed.) 2) Check if the air conditioner has a function for switching the air direction. 3) If the air conditioner doesn't have that function, "NOT AVAILABLE" will be displayed on the remote controller when "AIR DIRECTION" or "LOUVER" button is pressed.	_____
The air conditioner starts operating even though any buttons on the remote controller are not pressed.	① Check if you set ON/OFF timer. The air conditioner starts operating at the time designated if ON timer has been set before.	_____
	② Check if any operations are ordered by distant control system or the central remote controller. While "CENTRALLY CONTROLLED INDICATOR" is displayed on the remote controller, the air conditioner is under the control of external directive.	There might be a case that "CENTRALLY CONTROLLED INDICATOR" will not be displayed.
	③ Check if power is recovered from power failure (black out). The units will automatically start operating when power is recovered after power failure (black out) occurs. This function is called "auto recovery feature from power".	_____
The air conditioner stops even though any buttons on the remote controller are not pressed.	① Check if you set ON/OFF timer. The air conditioner stops operating at the time designated if OFF timer has been set before. ② Check if any operations are ordered by distant control system or the central remote controller. While "CENTRALLY CONTROLLED INDICATOR" is displayed on the remote controller, the air conditioner is under the control of external directive.	There might be a case that "CENTRALLY CONTROLLED INDICATOR" will not be displayed.



Phone Calls From Customers	How to Respond	Note
A white mist is expelled from the indoor unit.	This is not a malfunction. This may occur when the operation gets started in the room of high humidity.	_____
Water or moisture is expelled from the outdoor unit.	Cooling; when pipes or piping joints are cooled, they get sweated and water drips down. Heating; water drips down from the heat exchanger. * Make use of optional parts "Drain Socket" and "Drain pan" if these water needs to be collected and drained out for once.	_____
The display of wireless remote controller gets dim or does not come on. The indoor unit does not receive a signal from remote controller at a long distance.	Batteries are being exhausted. Replace them and press the reset button of remote controller.	_____

## 10-6. HOW TO CHECK THE PARTS

### PUHZ-FRP71VHA

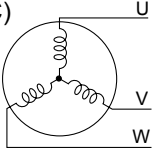
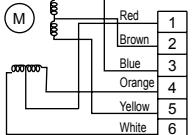
Parts name	Check points														
Thermistor (TH3) <Outdoor pipe> Thermistor (TH4) <Discharge> Thermistor (TH6) <Outdoor 2-phase pipe> Thermistor (TH7) <Outdoor> Thermistor (TH8) <Heatsink> Thermistor (TH34) <Comp. surface>	Disconnect the connector then measure the resistance with a tester. (At the ambient temperature 10°C~30°C) <table border="1" style="margin-left: 20px;"> <thead> <tr> <th></th> <th>Normal</th> <th>Abnormal</th> </tr> </thead> <tbody> <tr> <td>TH4, TH34</td> <td>160kΩ~410kΩ</td> <td rowspan="4">Open or short</td> </tr> <tr> <td>TH3</td> <td rowspan="3">4.3kΩ~9.6kΩ</td> </tr> <tr> <td>TH6</td> </tr> <tr> <td>TH7</td> </tr> <tr> <td>TH8</td> <td>39kΩ~105kΩ</td> </tr> </tbody> </table>		Normal	Abnormal	TH4, TH34	160kΩ~410kΩ	Open or short	TH3	4.3kΩ~9.6kΩ	TH6	TH7	TH8	39kΩ~105kΩ		
	Normal	Abnormal													
TH4, TH34	160kΩ~410kΩ	Open or short													
TH3	4.3kΩ~9.6kΩ														
TH6															
TH7															
TH8	39kΩ~105kΩ														
Fan motor (MF1)	Refer to next page.														
Solenoid valve coil <Four-way valve> (21S4)	Measure the resistance between the terminals with a tester. (At the ambient temperature 20°C) <table border="1" style="margin-left: 20px;"> <thead> <tr> <th>Normal</th> <th>Abnormal</th> </tr> </thead> <tbody> <tr> <td>2350 ± 170Ω</td> <td>Open or short</td> </tr> </tbody> </table>	Normal	Abnormal	2350 ± 170Ω	Open or short										
Normal	Abnormal														
2350 ± 170Ω	Open or short														
Solenoid valve coil (SV1, SV2)	Measure the resistance between the terminals with a tester. (At the ambient temperature 20°C) <table border="1" style="margin-left: 20px;"> <thead> <tr> <th>Normal</th> <th>Abnormal</th> </tr> </thead> <tbody> <tr> <td>1567 ± 150Ω</td> <td>Open or short</td> </tr> </tbody> </table>	Normal	Abnormal	1567 ± 150Ω	Open or short										
Normal	Abnormal														
1567 ± 150Ω	Open or short														
Solenoid valve coil (SV3)	Measure the resistance between the terminals with a tester. (At the ambient temperature 20°C) <table border="1" style="margin-left: 20px;"> <thead> <tr> <th>Normal</th> <th>Abnormal</th> </tr> </thead> <tbody> <tr> <td>1450 ± 150Ω</td> <td>Open or short</td> </tr> </tbody> </table>	Normal	Abnormal	1450 ± 150Ω	Open or short										
Normal	Abnormal														
1450 ± 150Ω	Open or short														
Motor for compressor (MC) 	Measure the resistance between the terminals with a tester. (Winding temperature 20°C) <table border="1" style="margin-left: 20px;"> <thead> <tr> <th>Normal</th> <th>Abnormal</th> </tr> </thead> <tbody> <tr> <td>Refer to 5-2.</td> <td>Open or short</td> </tr> </tbody> </table>	Normal	Abnormal	Refer to 5-2.	Open or short										
Normal	Abnormal														
Refer to 5-2.	Open or short														
Linear expansion valve (LEV-A/LEV-B/LEV-C) 	Disconnect the connector then measure the resistance with a tester. (Winding temperature 20°C) <table border="1" style="margin-left: 20px;"> <thead> <tr> <th colspan="4">Normal</th> <th>Abnormal</th> </tr> </thead> <tbody> <tr> <td>Red - White</td> <td>Red - Orange</td> <td>Brown - Yellow</td> <td>Brown - Blue</td> <td rowspan="2">Open or short</td> </tr> <tr> <td colspan="4">46 ± 4Ω</td> </tr> </tbody> </table>	Normal				Abnormal	Red - White	Red - Orange	Brown - Yellow	Brown - Blue	Open or short	46 ± 4Ω			
Normal				Abnormal											
Red - White	Red - Orange	Brown - Yellow	Brown - Blue	Open or short											
46 ± 4Ω															



## Check method of DC fan motor (fan motor / outdoor controller circuit board)

### ① Notes

- High voltage is applied to the connector (CNF1, 2) for the fan motor. Pay attention to the service.
- Do not pull out the connector (CNF1, 2) for the motor with the power supply on.  
(It causes trouble of the outdoor controller circuit board and fan motor.)

### ② Self check

Symptom : The outdoor fan cannot turn around.

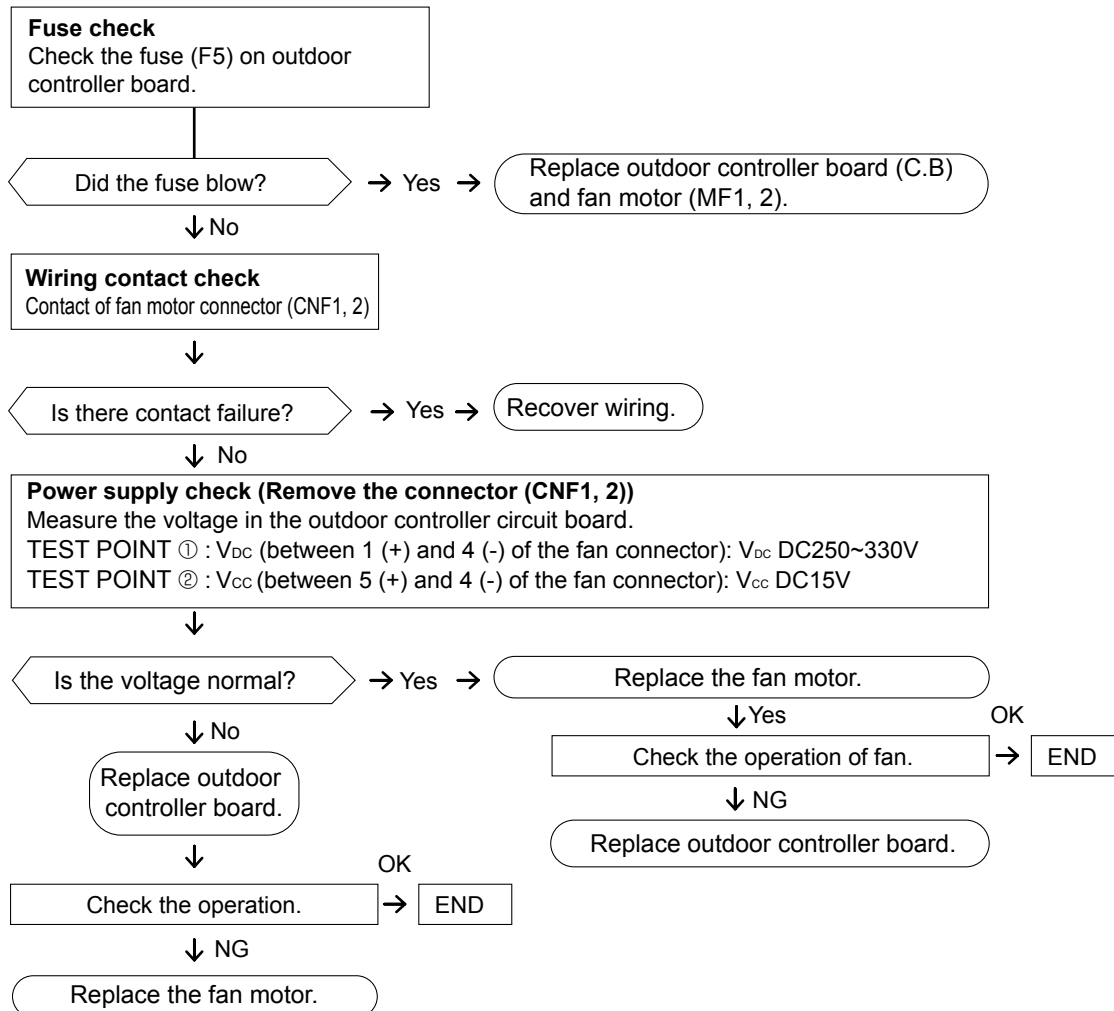

## 10-7. HOW TO CHECK THE COMPONENTS

### <Thermistor feature chart>

#### Low temperature thermistors

- Thermistor <Outdoor pipe> (TH3)
- Thermistor <Outdoor 2-phase pipe> (TH6)
- Thermistor <Outdoor> (TH7)

Thermistor R0 = 15kΩ ± 3%

B constant = 3480 ± 2%

$$R_t = 15 \exp\left\{3480 \left( \frac{1}{273+t} - \frac{1}{273} \right)\right\}$$

0°C	15kΩ	30°C	4.3kΩ
10°C	9.6kΩ	40°C	3.0kΩ
20°C	6.3kΩ		
25°C	5.2kΩ		

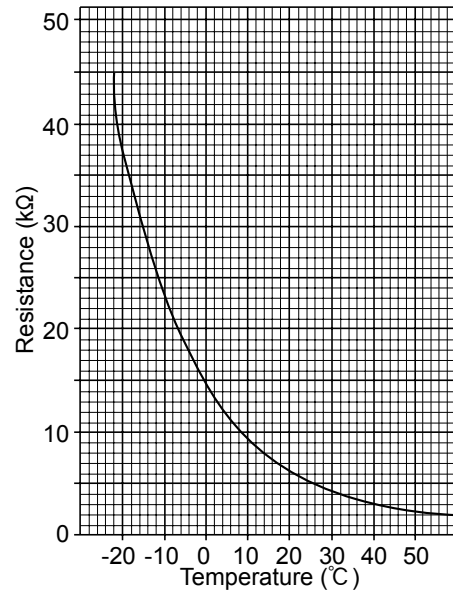

#### Medium temperature thermistor

- Thermistor <Heatsink> (TH8)

Thermistor R50 = 17kΩ ± 2%

B constant = 4150 ± 3%

$$R_t = 17 \exp\left\{4150 \left( \frac{1}{273+t} - \frac{1}{323} \right)\right\}$$

0°C	180kΩ
25°C	50kΩ
50°C	17kΩ
70°C	8kΩ
90°C	4kΩ

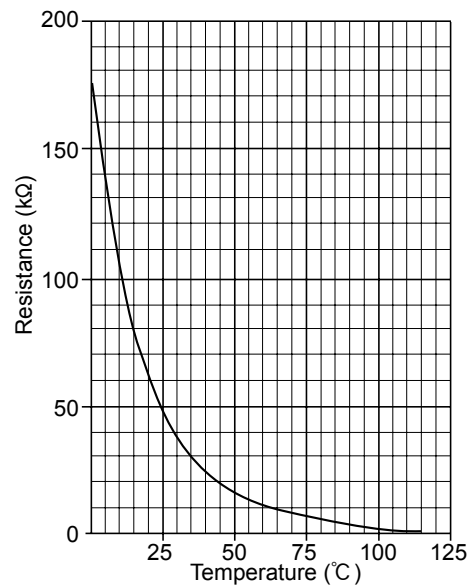

#### High temperature thermistor

- Thermistor <Discharge> (TH4)
- Thermistor <Comp. surface> (TH34)

Thermistor R120 = 7.465kΩ ± 2%

B constant = 4057 ± 2%

$$R_t = 7.465 \exp\left\{4057 \left( \frac{1}{273+t} - \frac{1}{393} \right)\right\}$$

20°C	250kΩ	70°C	34kΩ
30°C	160kΩ	80°C	24kΩ
40°C	104kΩ	90°C	17.5kΩ
50°C	70kΩ	100°C	13.0kΩ
60°C	48kΩ	110°C	9.8kΩ

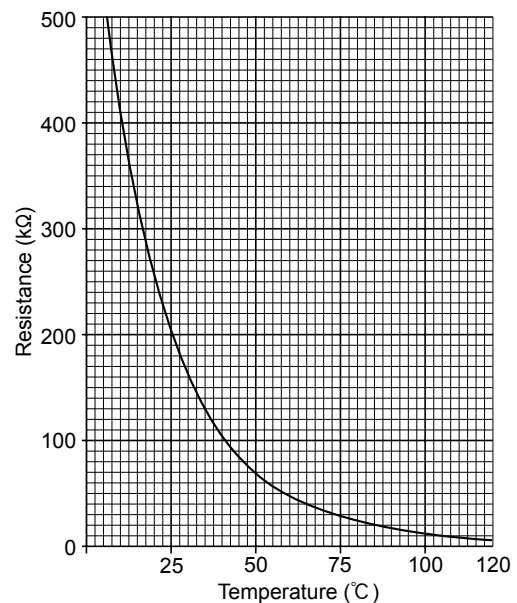

## Linear expansion valve

### (1) Operation summary of the linear expansion valve

- Linear expansion valve opens/closes through stepping motor after receiving the pulse signal from the outdoor controller board.
  - Valve position can be changed in proportion to the number of pulse signal.
- <Connection between the outdoor controller board and the linear expansion valve>

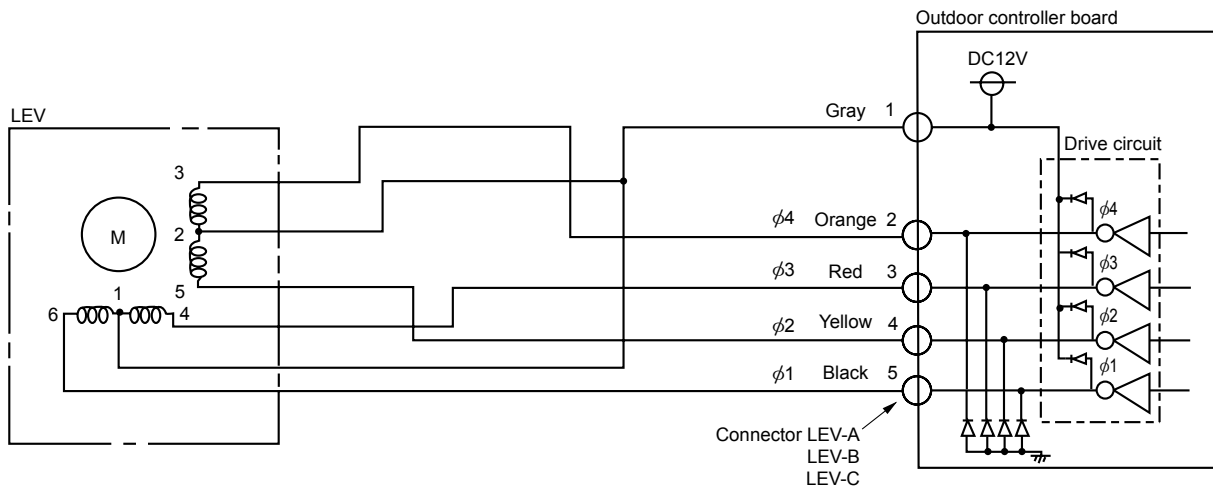

### <Output pulse signal and the valve operation>

Output (Phase)	Output							
	1	2	3	4	5	6	7	8
$\phi 1$	ON	ON	OFF	OFF	OFF	OFF	OFF	ON
$\phi 2$	OFF	ON	ON	ON	OFF	OFF	OFF	OFF
$\phi 3$	OFF	OFF	OFF	ON	ON	ON	OFF	OFF
$\phi 4$	OFF	OFF	OFF	OFF	OFF	ON	ON	ON

Opening a valve : 8 → 7 → 6 → 5 → 4 → 3 → 2 → 1 → 8

Closing a valve : 1 → 2 → 3 → 4 → 5 → 6 → 7 → 8 → 1

The output pulse shifts in above order.

- When linear expansion valve operation stops, all output phase become OFF.

### (2) Linear expansion valve operation

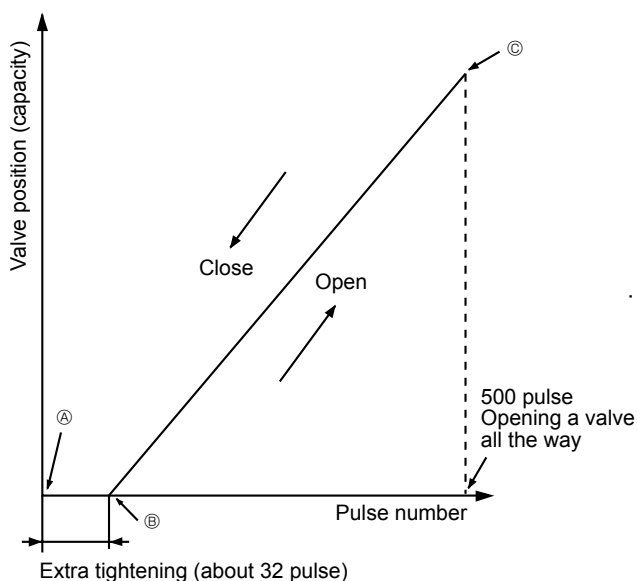

- When the switch is turned on, 700 pulse closing valve signal will be sent till it goes to ① point in order to define the valve position. (The pulse signal is being sent for about 20 seconds.)

When the valve moves smoothly, there is no sound or vibration occurring from the linear expansion valve : however, when the pulse number moves from ② to ① or when the valve is locked, more sound can be heard.

No sound is heard when the pulse number moves from ③ to ① in case coil is burnt out or motor is locked by open-phase.

- Sound can be detected by placing the ear against the screw driver handle while putting the screw driver to the linear expansion valve.

### (3) How to attach and detach the coil of linear expansion valve

<Composition>

Linear expansion valve is separable into the main body and the coil as shown in the diagram below.

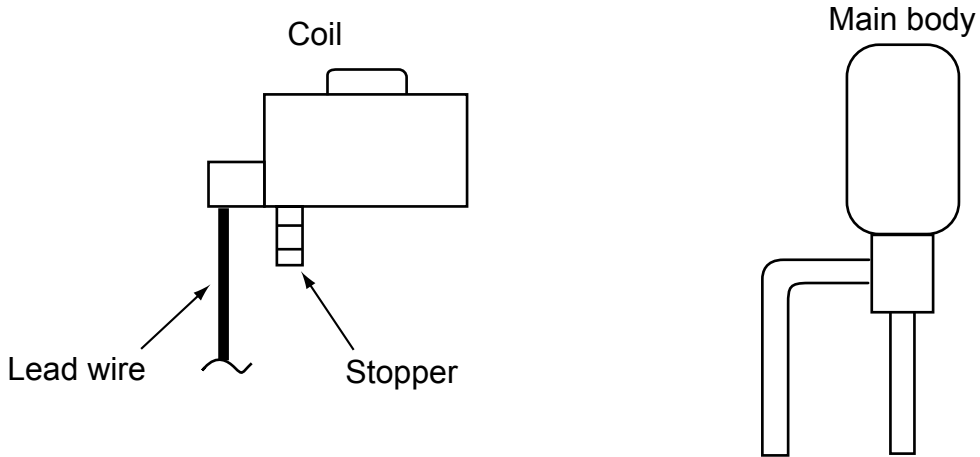

#### <How to detach the coil>

Hold the lower part of the main body (shown as A) firmly so that the main body does not move and detach the coil by pulling it upward.

Be sure to detach the coil holding main body firmly. Otherwise pipes can bend due to pressure.

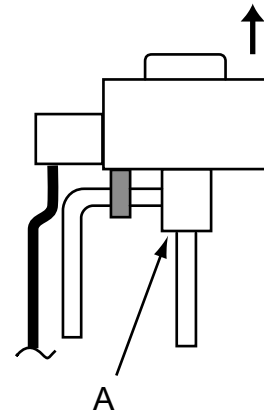

#### <How to attach the coil>

Hold the lower part of the main body (shown as A) firmly so that the main body does not move and attach the coil by inserting it downward into the main body. Then securely attach the coil stopper to pipe B. (At this time, be careful that stress is not added to lead wire and main body is not wound by lead wire.) If the stopper is not firmly attached to pipe B, coil may be detached from the main body and that can cause defective operation of linear expansion valve.

To prevent piping stress, be sure to attach the coil holding the main body of linear expansion valve firmly. Otherwise pipe may break.

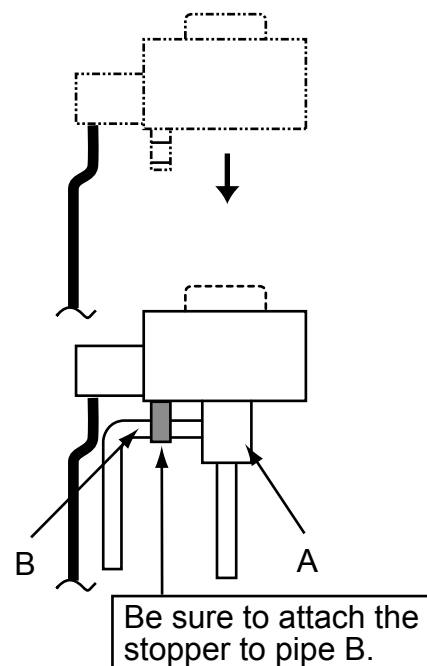

## 10-8. EMERGENCY OPERATION (ATA only)

(1) When the error codes shown below are displayed on outdoor unit or microcomputer for wired remote controller or indoor unit has a failure, but no other problems are found, emergency operation will be available by setting the emergency operation switch (SWE) on indoor controller board to ON and short-circuiting the connector (CN31) on outdoor controller board.

●When following abnormalities occur, emergency operation will be available.

Error code	Inspected content
U4	Open/short of pipe thermistor (TH3/TH6/TH7/TH8)
E8	Indoor/outdoor unit communication error • Signal receiving error (Outdoor unit)
E9	Indoor/outdoor unit communication error • Transmitting error (Indoor unit)
E0 ~ E7	Communication error other than outdoor unit
Ed	Communication error between outdoor controller board and M-NET board (Serial communication error)

### (2) Check the following items and cautions for emergency operation

- ① Make sure that there is no abnormality in outdoor unit other than the above abnormalities. (Emergency operation will not be available when error code other than the above are indicated.)
- ② For emergency operation, it is necessary to set the emergency operation switch (SWE) on indoor controller board. Refer to the electrical wiring diagram of indoor unit for how to set the indoor unit.
- ③ During emergency operation, the air-conditioner will continuously be operated by supplying power and stopping it: It can not be turned on or off by remote control, and temperature control is not possible.
- ④ Do not perform emergency heating operation for an extended period of time: If the outdoor unit starts defrosting during this period, cold air will blow out from the indoor unit.
- ⑤ Do not perform emergency cooling operation for more than 10 hours: Neglecting this could result in freezing the heat exchanger in indoor unit.

### (3) Emergency operation procedure

- ① Turn the main power supply off.
- ② Turn on the emergency operation switch (SWE) on indoor controller board.
- ③ Set the shorting pins of emergency operation connector (CN31) on outdoor controller board to ON.
- ④ Use SW4-2 on outdoor controller board to set the operation mode (cooling or heating). (SW4-1 is not used.)

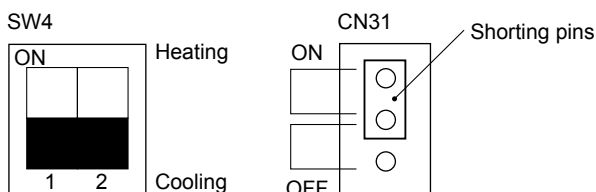

- ⑤ Turning the main power supply on will start the emergency operation.

### (4) Releasing emergency operation

- ① Turn the main power supply off.
- ② Set the emergency operation switch (SWE) on indoor controller board to OFF.
- ③ Set the shorting pins of emergency operation connector (CN31) on outdoor controller board to OFF.
- ④ Set SW4-2 on outdoor controller board as shown in the right.

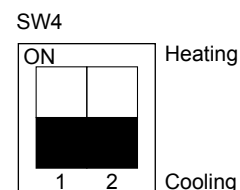

\* If shorting pins are not set on emergency operation connector (CN31), the setting remains OFF.

### (5) Operation data during emergency operation

During emergency operation, no communication is performed with the indoor unit, so the data items needed for operation are set to the following values:

Operation data	Operation mode		Remarks
	COOL	HEAT	
Intake temperature (TH1)	27°C	20.5°C	—
Indoor pipe temperature (TH2)	5°C	45°C	—
Indoor 2-phase pipe temperature (TH5)	5°C	50°C	—
Set temperature	25°C	22°C	—
Outdoor pipe temperature (TH3)	45°C	5°C	(*1)
Outdoor 2-phase pipe temperature (TH6)	50°C	5°C	(*1)
Outdoor ambient temperature (TH7)	35°C	7°C	(*1)
Pressure sensor saturated temperature (63HS)	50°C	50°C	(*1)
Temperature difference code (room temperature - set temperature) ( $\Delta T_j$ )	5	5	—

\*1 If the thermistor temperature data is normal (not open/short), that data is loaded into the control as valid data. When the unit enters emergency operation and TH values are mismatched, set the thermistors to open/short. And the unit runs emergency operation with the values listed above.

# 10-9. TEST POINT DIAGRAM

## Outdoor controller circuit board

### PUHZ-FRP71VHA

<CAUTION> TEST POINT① is high voltage.

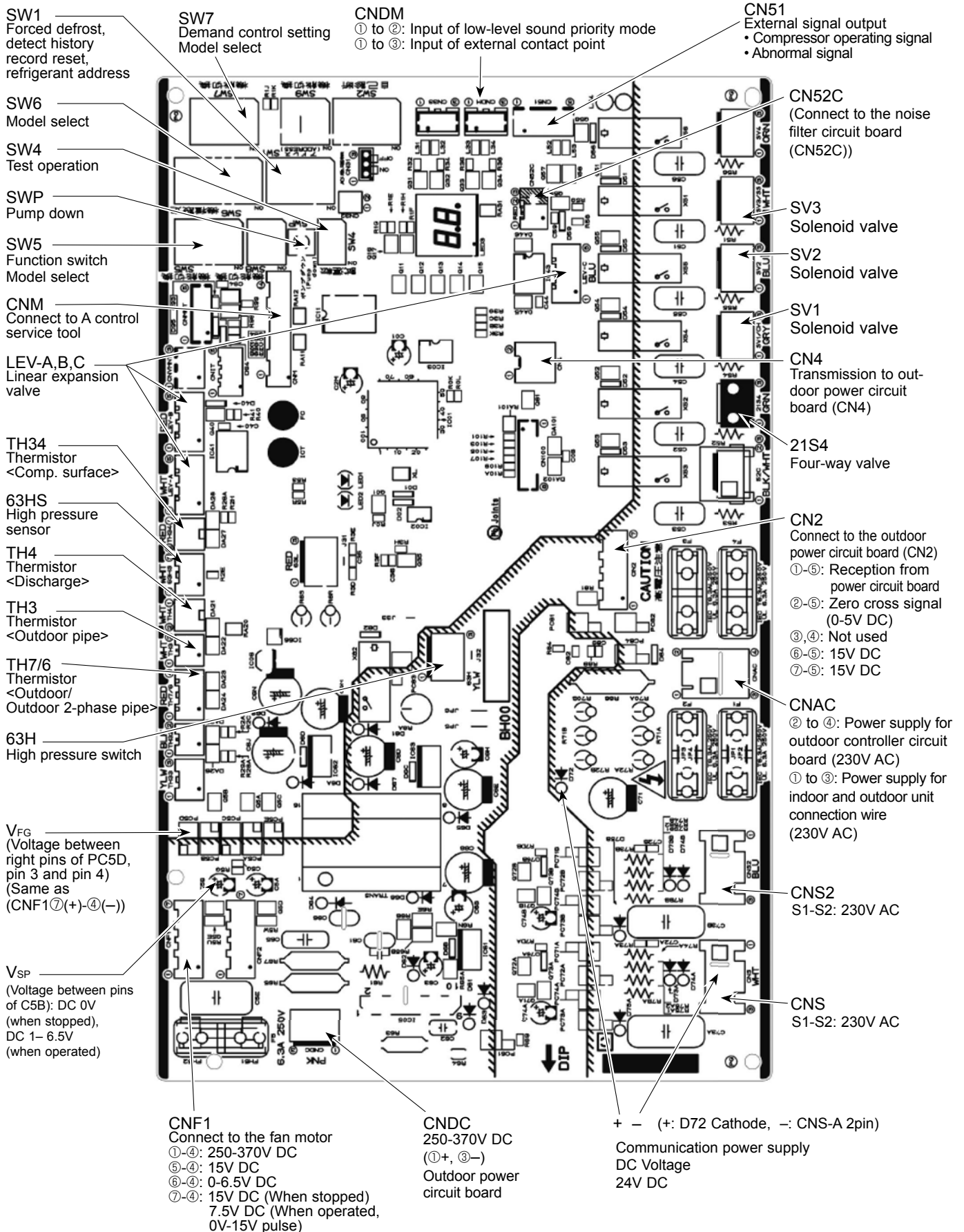

# Outdoor noise filter circuit board PUHZ-FRP71VHA

E1, E2  
Connect to the earth

CNAC1, CNAC2  
220-240V AC  
(Connect to the  
outdoor controller  
circuit board  
(CNAC))

CN5  
Primary current  
(Connect to the  
outdoor power  
circuit board  
(CN5))

CN52C  
52C relay signal  
(Connect to the  
outdoor controller  
circuit board  
(CN52C))

LO, NO  
Voltage of 220-240V AC is output.  
(Connect ACL)

E3  
Connect to  
the earth

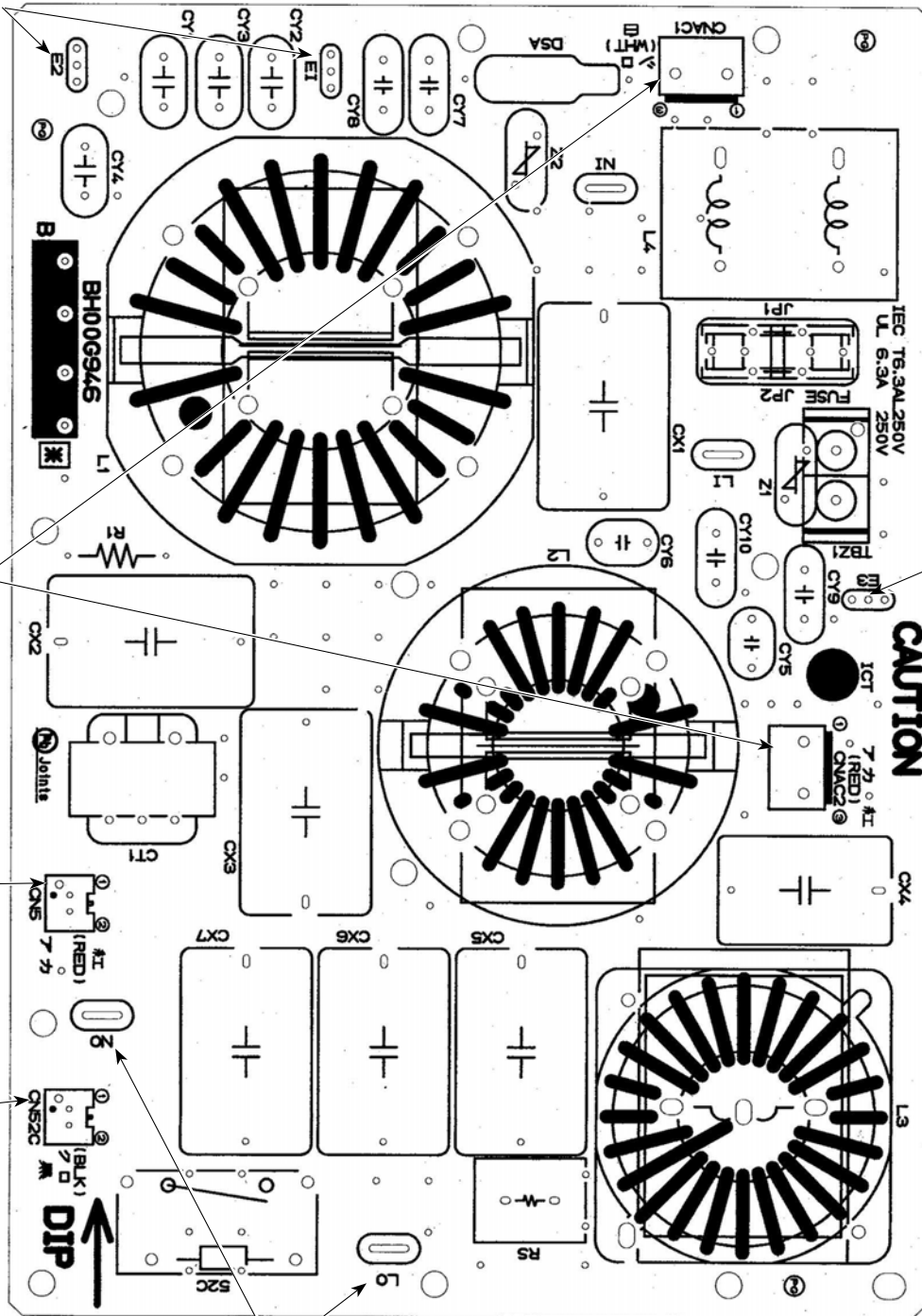



# Outdoor power circuit board PUHZ-FRP71VHA

## Brief Check of DIP-IPM and DIP-PFC

\* Usually, they are in a state of being short-circuited if they are broken. Measure the resistance in the following points (connectors, etc.). If they are short-circuited, it means that they are broken.

### 1. Check of DIP-IPM

**P2-U**, **P2-V**, **P2-W**, **N2-U**, **N2-V**, **N2-W**

### 2. Check of DIP-PFC

**P1-L**, **P1-N**, **L-N1**, **N-N1**

Note: The marks, **L**, **N**, **N1**, **N2**, **P1**, **P2**, **U**, **V** and **W** shown in the diagram are not actually printed on the board.

R, S  
Connect to the ACL  
220-240V AC

U, V, W  
Connect to the compressor (MC)  
Voltage among phases: 5V to 180V AC

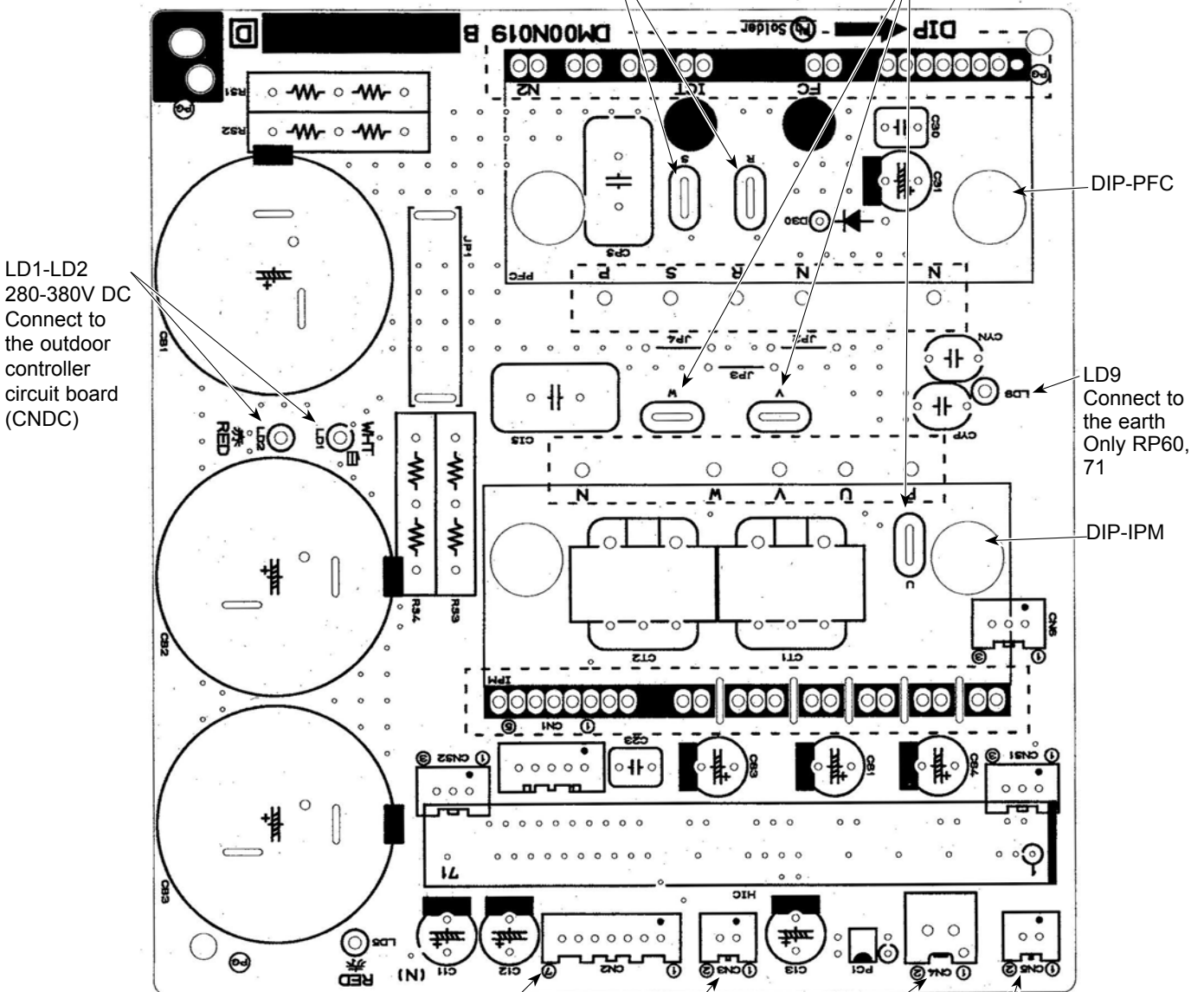

LD1-LD2  
280-380V DC  
Connect to the outdoor controller circuit board (CNDC)

DIP-PFC

LD9  
Connect to the earth  
Only RP60, 71

DIP-IPM

CN2  
Connect to the outdoor controller circuit board (CN2)  
①-⑤: Outdoor power circuit board → Transmitting signal to the outdoor controller circuit board (0-5V DC)  
②-⑥: Zero cross signal (0-5V DC)  
③-④: Not used  
⑥-⑦: 16V DC  
⑦-⑧: 16V DC

①, ②, ⑥, ⑦	⊕
⑤	⊖

CN3  
Thermistor  
<Heatsink>  
(TH8)

CN4  
Connect from the outdoor controller circuit board (CN4)

CN5  
Primary current detection  
(Connect to the outdoor noise filter circuit board (CN5))

## 10-10. FUNCTION OF SWITCHES, CONNECTORS AND JUMPERS

### (1) Function of switches

The black square (■) indicates a switch position.

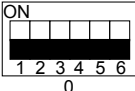
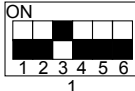
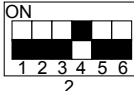
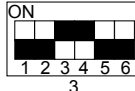
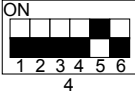
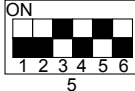
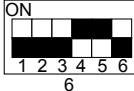
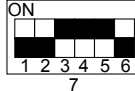
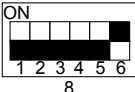
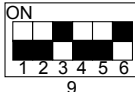
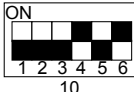
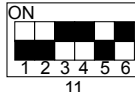
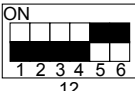
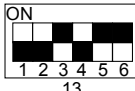
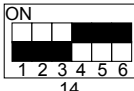
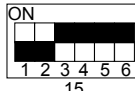
Type of switch	Switch No.	Function	Action by the switch operation		Effective timing			
			ON	OFF				
Dip switch	SW1	1	Forced defrost *1	Start	Normal	When compressor is working in ATA heating and ATW heating operation. *1		
		2	Abnormal history clear	Clear	Normal		OFF or operating	
		3	Refrigerant address setting	 0	 1	 2	 3	When power supply ON
		4		 4	 5	 6	 7	
		5		 8	 9	 10	 11	
		6		 12	 13	 14	 15	
	SW4	1		Test run	Operating	OFF	OFF	
		2		Test run mode setting	Heating	Cooling		
	Push switch	SWP	Pump down	Start	Normal	OFF		

\*1 Forced defrost should be done as follows.

① Change the DIP SW1-1 on the outdoor controller board from OFF to ON.

② Forced defrost will start by the above operation ① if all these conditions written below are satisfied.

- Heat mode setting
- 10 minutes have passed since compressor started operating or previous compulsory defrosting finished.
- Pipe temperature is less than or equal to 8°C.

Forced defrost will finish if certain conditions are satisfied.

Forced defrost can be done if above conditions are satisfied when DIP SW1-1 is changed from OFF to ON.

After DIP SW1-1 is changed from OFF to ON, there is no problem if DIP SW1-1 is left ON or changed to OFF again.

This depends on the service conditions.

The black square (■) indicates a switch position.

Type of Switch	Switch	No.	Function	Action by the switch operation		Effective timing																																						
				ON	OFF																																							
Dip switch	SW5	1	No function	—	—	—																																						
		2	Power failure automatic recovery *2	Auto recovery	No auto recovery	When power supply ON																																						
		3,4	No function	—	—	—																																						
		5	Forced refrigerant recovery	Start	Normal	When compressor is working in ATA cooling, ATA heating and ATW heating.																																						
		6	Model select	<table border="1"> <tr> <td>MODEL</td> <td colspan="6">SW5-6</td> </tr> <tr> <td>71</td> <td>ON</td> <td><input type="checkbox"/></td> <td><input type="checkbox"/></td> <td><input type="checkbox"/></td> <td><input type="checkbox"/></td> <td><input checked="" type="checkbox"/></td> </tr> <tr> <td></td> <td>OFF</td> <td><input type="checkbox"/></td> <td><input type="checkbox"/></td> <td><input type="checkbox"/></td> <td><input type="checkbox"/></td> <td><input type="checkbox"/></td> </tr> <tr> <td></td> <td></td> <td>1</td> <td>2</td> <td>3</td> <td>4</td> <td>5</td> <td>6</td> </tr> </table>				MODEL	SW5-6						71	ON	<input type="checkbox"/>	<input type="checkbox"/>	<input type="checkbox"/>	<input type="checkbox"/>	<input checked="" type="checkbox"/>		OFF	<input type="checkbox"/>	<input type="checkbox"/>	<input type="checkbox"/>	<input type="checkbox"/>	<input type="checkbox"/>			1	2	3	4	5	6								
		MODEL	SW5-6																																									
	71	ON	<input type="checkbox"/>	<input type="checkbox"/>	<input type="checkbox"/>	<input type="checkbox"/>	<input checked="" type="checkbox"/>																																					
		OFF	<input type="checkbox"/>	<input type="checkbox"/>	<input type="checkbox"/>	<input type="checkbox"/>	<input type="checkbox"/>																																					
			1	2	3	4	5	6																																				
	SW7	1	Mode select *3	Demand function	Low noise mode	Always																																						
		2	No function	—	—	—																																						
		3	No function	—	—	—																																						
		4	Model select	<table border="1"> <tr> <td>MODEL</td> <td colspan="6">SW7-4</td> </tr> <tr> <td>71</td> <td>ON</td> <td><input type="checkbox"/></td> <td><input type="checkbox"/></td> <td><input type="checkbox"/></td> <td><input checked="" type="checkbox"/></td> <td><input type="checkbox"/></td> </tr> <tr> <td></td> <td>OFF</td> <td><input type="checkbox"/></td> <td><input type="checkbox"/></td> <td><input type="checkbox"/></td> <td><input type="checkbox"/></td> <td><input type="checkbox"/></td> </tr> <tr> <td></td> <td></td> <td>1</td> <td>2</td> <td>3</td> <td>4</td> <td>5</td> <td>6</td> </tr> </table>				MODEL	SW7-4						71	ON	<input type="checkbox"/>	<input type="checkbox"/>	<input type="checkbox"/>	<input checked="" type="checkbox"/>	<input type="checkbox"/>		OFF	<input type="checkbox"/>	<input type="checkbox"/>	<input type="checkbox"/>	<input type="checkbox"/>	<input type="checkbox"/>			1	2	3	4	5	6								
		MODEL	SW7-4																																									
		71	ON	<input type="checkbox"/>	<input type="checkbox"/>	<input type="checkbox"/>	<input checked="" type="checkbox"/>	<input type="checkbox"/>																																				
		OFF	<input type="checkbox"/>	<input type="checkbox"/>	<input type="checkbox"/>	<input type="checkbox"/>	<input type="checkbox"/>																																					
			1	2	3	4	5	6																																				
	5	Operation priority	ATW	ATA	When power supply ON																																							
	6	Defrost setting	For high humidity	Normal	Always																																							
	SW8	1	Cooling operation limit	None	16 hr	Always																																						
		2	Fan table select	2nd table	1st table	Always																																						
		3	Separate power supply	Separate	Normal	When power supply ON																																						
	SW9	1	No function	—	—	—																																						
		2	No function	—	—	—																																						
		3,4	No function	—	—	—																																						
	SW6	1	Model select	<table border="1"> <tr> <td>MODEL</td> <td colspan="8">SW6</td> </tr> <tr> <td>71</td> <td>ON</td> <td><input checked="" type="checkbox"/></td> <td><input checked="" type="checkbox"/></td> <td><input checked="" type="checkbox"/></td> <td><input checked="" type="checkbox"/></td> <td><input checked="" type="checkbox"/></td> <td><input checked="" type="checkbox"/></td> <td><input checked="" type="checkbox"/></td> </tr> <tr> <td></td> <td>OFF</td> <td><input type="checkbox"/></td> <td><input type="checkbox"/></td> <td><input type="checkbox"/></td> <td><input type="checkbox"/></td> <td><input type="checkbox"/></td> <td><input type="checkbox"/></td> <td><input type="checkbox"/></td> </tr> <tr> <td></td> <td></td> <td>1</td> <td>2</td> <td>3</td> <td>4</td> <td>5</td> <td>6</td> <td>7</td> <td>8</td> </tr> </table>				MODEL	SW6								71	ON	<input checked="" type="checkbox"/>	<input checked="" type="checkbox"/>	<input checked="" type="checkbox"/>	<input checked="" type="checkbox"/>	<input checked="" type="checkbox"/>	<input checked="" type="checkbox"/>	<input checked="" type="checkbox"/>		OFF	<input type="checkbox"/>	<input type="checkbox"/>	<input type="checkbox"/>	<input type="checkbox"/>	<input type="checkbox"/>	<input type="checkbox"/>	<input type="checkbox"/>			1	2	3	4	5	6	7	8
		MODEL						SW6																																				
71		ON						<input checked="" type="checkbox"/>	<input checked="" type="checkbox"/>	<input checked="" type="checkbox"/>	<input checked="" type="checkbox"/>	<input checked="" type="checkbox"/>	<input checked="" type="checkbox"/>	<input checked="" type="checkbox"/>																														
		OFF						<input type="checkbox"/>	<input type="checkbox"/>	<input type="checkbox"/>	<input type="checkbox"/>	<input type="checkbox"/>	<input type="checkbox"/>	<input type="checkbox"/>																														
								1	2	3	4	5	6	7	8																													
2																																												
3																																												
4																																												
5																																												
6																																												
7																																												
8																																												
SW5	6																																											

\*2 'Power failure automatic recovery' can be set by either remote controller or this DIP SW. If one of them is set to ON, 'Auto recovery' activates. Please set "Auto recovery" basically by remote controller because all units do not have DIP SW. Please refer to the indoor unit installation manual.

\*3 SW7-1 is setting change over of Demand/Low noise. It is effective only in case of external input. (Local wiring is necessary. Refer to next page: Special function)

## (2) Function of connector

Types	Connector	Function	Action by open/ short operation		Effective timing
			Short	Open	
Connector	CN31	Emergency operation	Start	Normal	When power supply ON

### Special function

#### (a) Low-level sound priority mode (Local wiring)

By performing the following modification, operation noise of the outdoor unit can be reduced by about 3-4 dB.

The low noise mode will be activated when a commercially available timer or the contact input of an ON/OFF switch is added to the CNDM connector (option) on the control board of the outdoor unit.

• The ability varies according to the outdoor temperature and conditions, etc.

① Complete the circuit as shown when using the external input adapter (PAC-SC36NA-E). (Option)

② SW7-1 (Outdoor unit control board): OFF

③ SW1 ON: Low noise mode

SW1 OFF: Normal operation

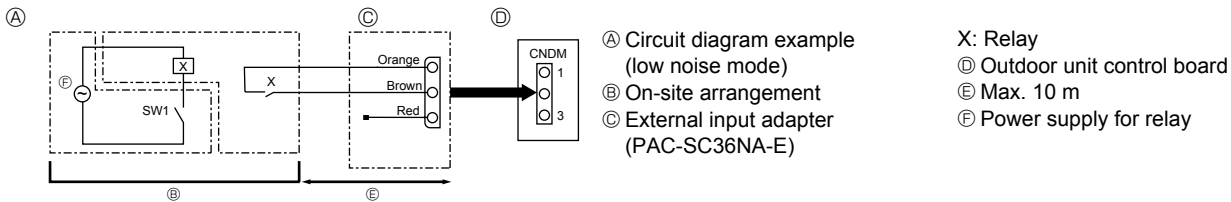

#### (b) On demand control (Local wiring)

By performing the following modification, energy consumption can be reduced to 0–100% of the normal consumption.

The demand function will be activated when a commercially available timer or the contact input of an ON/OFF switch is added to the CNDM connector (option) on the control board of the outdoor unit.

① Complete the circuit as shown when using the external input adapter (PAC-SC36NA-E). (Option)

② By setting SW7-1 on the control board of the outdoor unit, the energy consumption (compared to the normal consumption) can be limited as shown below.

	SW7-1	SW2	SW3	Energy consumption
Demand function	ON	OFF	OFF	100%
		ON	OFF	75%
		ON	ON	50%
		OFF	ON	0% (Stop)

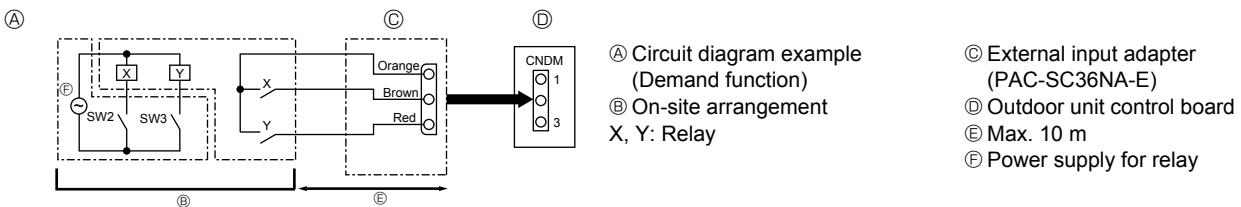

**<Display function of inspection for outdoor unit>**

The blinking patterns of both LED1 (green) and LED2 (red) indicate the types of abnormality when it occurs. Types of abnormality can be indicated in details by connecting an optional part 'A-Control Service Tool (PAC-SK52ST)' to connector CNM on outdoor controller board.

[Display]

(1)Normal condition

Unit condition	Outdoor controller board		A-Control Service Tool	
	LED1 (Green)	LED2 (Red)	Error code	Indication of the display
When the power is turned on	Lighted	Lighted	— ↔ —	Alternately blinking display
When unit stops	Lighted	Not lighted	00, etc.	Operation mode
When compressor is warming up	Lighted	Not lighted	08, etc.	
When unit operates	Lighted	Lighted	C5, H7 etc.	

(2)Abnormal condition

Indication		Contents	Error code *1	Error	Inspection method	Detailed reference page	
Outdoor controller board							
LED1 (Green)	LED2 (Red)						
1 blinking	2 blinking	Connector (63H) is open.	F5		①Check if connector (63H) on the outdoor controller board is not disconnected. ②Check continuity of pressure switch (63H) by tester.	P.29	
2 blinking	1 blinking	Miswiring of indoor/outdoor unit connecting wire, excessive number of indoor units (4 units or more)	—		①Check if indoor/outdoor connecting wire is connected correctly. ②Check if 4 or more indoor units are connected to outdoor unit.	P.30 (EA)	
		Miswiring of indoor/outdoor unit connecting wire (converse wiring or disconnection)	—		③Check if noise entered into indoor/outdoor connecting wire or power supply. ④Re-check error by turning off power, and on again.	P.30 (Eb)	
		Startup time over	—			P.30 (EC)	
	2 blinking		Indoor/outdoor unit communication error (signal receiving error) is detected by indoor unit.	E6		①Check if indoor/outdoor connecting wire is connected correctly. ②Check if noise entered into indoor/outdoor connecting wire or power supply.	P.36
			Indoor/outdoor unit communication error (transmitting error) is detected by indoor unit.	E7		③Check if noise entered into indoor/outdoor controller board. ④Re-check error by turning off power, and on again.	P.36
			Indoor/outdoor unit communication error (signal receiving error) is detected by outdoor unit.	—			P.36 (E8)
			Indoor/outdoor unit communication error (transmitting error) is detected by outdoor unit.	—			P.36 (E9)
	3 blinking		Remote controller signal receiving error is detected by remote controller.	E0		①Check if connecting wire of indoor unit or remote controller is connected correctly.	P.35
			Remote controller transmitting error is detected by remote controller.	E3		②Check if noise entered into transmission wire of remote controller. ③Re-check error by turning off power, and on again.	P.35
			Remote controller signal receiving error is detected by indoor unit.	E4			P.35
Remote controller transmitting error is detected by indoor unit.			E5			P.35	
4 blinking		Error code is not defined.	EF		①Check if remote controller is MA remote controller(PAR-21MAA). ②Check if noise entered into transmission wire of remote controller. ③Check if noise entered into indoor/outdoor connecting wire. ④Re-check error by turning off power, and on again.	P.36	
			EE		①Correct the wiring according to 7 WIRING DIAGRAM. ( TB1 — Indoor unit TB2 — Cylinder/Hydrobox unit ) ②Correct the wiring according to 7 WIRING DIAGRAM. ( TB1 — CNS TB2 — CNS2 )	P.36	
			PL		①Be sure to replace the 4-way valve. ②Check refrigerant pipes for disconnection or leakage. ③After the recovery of refrigerant, vacuum dry the whole refrigerant circuit. ④Refer to section 10-6 HOW TO CHECK THE PARTS. ⑤Check refrigerant circuit for operation.	P.37	
5 blinking		Serial communication error <Communication between outdoor controller board and outdoor power board> <Communication between outdoor controller board and M-NET P.C. board>	Ed		①Check if connector (CN4) on outdoor controller board and outdoor power board is not disconnected. ②Check if there is poor connection of connector on outdoor controller board(CNMNT and CNVMNT). ③Check M-NET communication signal.	P.37	

\*1.Error code displayed on remote controller



Indication		Error			
Outdoor controller board		Contents	Error code *1	Inspection method	Detailed reference page
LED1 (Green)	LED2 (Red)				
3 blinking	1 blinking	Abnormality of comp. surface thermistor (TH32) and discharging temperature (TH4)	U2	①Check if stop valves are open. ②Check if connectors (TH4, TH32, LEV-A, and LEV-B) on outdoor controller board are not disconnected. ③Check if unit is filled with specified amount of refrigerant. ④Measure resistance values among terminals on indoor valve and outdoor linear expansion valve using a tester.	P.31
	2 blinking	Abnormal high pressure (High pressure switch 63H operated.)	U1	①Check if indoor/outdoor units have a short cycle on their air ducts. ②Check if connector (63H) on outdoor controller board is not disconnected. ③Check if heat exchanger and filter is not dirty. ④Measure resistance values among terminals on linear expansion valve using a tester.	P.31
	3 blinking	Abnormality of outdoor fan motor rotational speed	U8	①Check the outdoor fan motor. ②Check if connector (TH3) on outdoor controller board is disconnected.	P.32
		Protection from overheat operation(TH3)	Ud		P.34
	4 blinking	Compressor overcurrent breaking (Start-up locked)	UF	①Check if stop valves are open. ②Check looseness, disconnection, and converse connection of compressor wiring. ③Measure resistance values among terminals on compressor using a tester. ④Check if outdoor unit has a short cycle on its air duct.	P.34
			UP		P.34
		Abnormality of current sensor (P.B.)	UH		P.34
		Abnormality of power module	U6		P.32
	5 blinking	Open/short of discharge thermistor (TH4) and comp. surface thermistor (TH32)	U3	①Check if connectors(TH3,TH4,TH6 ,TH7 and TH32)on outdoor controller board and connector (CN3) on outdoor power board are not disconnected. ②Measure resistance value of outdoor thermistors.	P.31
		Open/short of outdoor thermistors (TH3, TH6, TH7 and TH8)	U4		P.32
6 blinking	Abnormality of heatsink temperature	U5	①Check if indoor/outdoor units have a short cycle on their air ducts. ②Measure resistance value of outdoor thermistor(TH8).	P.32	
7 blinking	Abnormality of voltage	U9	①Check looseness, disconnection, and converse connection of compressor wiring. ②Measure resistance value among terminals on compressor using a tester. ③Check the continuity of contactor (52C). ④Check if power supply voltage decreases. ⑤Check the wiring of CN52C. ⑥Check the wiring of CNAF.	P.33	
4 blinking	1 blinking	Abnormality of room temperature thermistor (TH1)	P1	①Check if connectors (CN20, CN21, CN29 and CN44) on indoor controller board are not disconnected. ②Measure resistance value of indoor thermistors.	*2
		Abnormality of pipe temperature thermistor /Liquid (TH2)	P2		*2
		Abnormality of pipe temperature thermistor/Condenser-Evaporator	P9		*2
	2 blinking	Abnormality of drain sensor (DS) Float switch(FS) connector open	P4	①Check if connector (CN31)(CN4F) on indoor controller board is not disconnected. ②Measure resistance value of indoor thermistors. ③Measure resistance value among terminals on drain pump using a tester. ④Check if drain pump works. ⑤Check drain function.	*2
		Indoor drain overflow protection	P5		
	3 blinking	Freezing (cooling)/overheating (heating) protection	P6	①Check if indoor unit has a short cycle on its air duct. ②Check if heat exchanger and filter is not dirty. ③Measure resistance value on indoor and outdoor fan motors. ④Check if the inside of refrigerant piping is not clogged.	*2
	4 blinking	Abnormality of pipe temperature	P8	①Check if indoor thermistors(TH2 and TH5) are not disconnected from holder. ②Check if stop valve is open. ③Check converse connection of extension pipe. (on plural units connection) ④Check if indoor/outdoor connecting wire is connected correctly. (on plural units connection)	*2

\*1 Error code displayed on remote controller

\*2 Refer to service manual for indoor unit.

**<Outdoor unit operation monitor function>**

**[When optional part 'A-Control Service Tool (PAC-SK52ST)' is connected to outdoor controller board (CNM)]**

Digital indicator LED1 displays 2 digit number or code to inform operation condition and the meaning of error code by controlling DIP SW2 on 'A-Control Service Tool'.

Operation indicator SW2 : Indicator change of self diagnosis

SW2 setting	Display detail	Explanation for display	Unit
			

**<Digital indicator LED1 working details>**

(Be sure that the 1 to 6 in the SW2 are set to OFF.)

- (1) Display when the power supply ON  
When the power supply ON, blinking displays by turns.  
Wait for 4 minutes at the longest.
- (2) When the display lights (Normal operation)
  - ① Operation mode display.

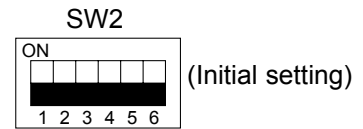
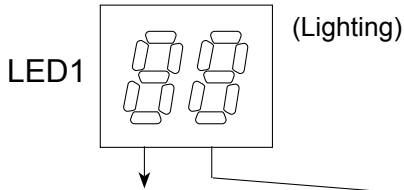
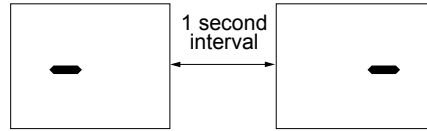

The tens digit : Operation mode

Display	Operation Model
O	OFF / FAN
C	ATA COOLING / DRY
H	ATA HEATING / ATW HEATING
r	HR COOLING
d	DEFROSTING

The ones digit : Relay output

Display	Warming-up Compressor	Compressor	4-way valve	Solenoid valve
0	—	—	—	—
1	—	—	—	ON
2	—	—	ON	—
3	—	—	ON	ON
4	—	ON	—	—
5	—	ON	—	ON
6	—	ON	ON	—
7	—	ON	ON	ON
8	ON	—	—	—
A	ON	—	ON	—

- ② Display during error postponement  
Postponement code is displayed when compressor stops due to the work of protection device.  
Postponement code is displayed while error is being postponed.





- (3) When the display blinks  
Inspection code is displayed when compressor stops due to the work of protection devices.

Display	Inspection unit
0	Outdoor unit
A1	ATA indoor unit 1
A2	ATA indoor unit 2
b1	Cylinder unit or Hydrobox

Display	Contents to be inspected (During operation)
U1	Abnormal high pressure (63H operated)
U2	Abnormal high discharging temperature and comp. surface thermistor, shortage of refrigerant
U3	Open/short circuit of discharging thermistor (TH4) and comp. surface thermistor (TH32)
U4	Open/short of outdoor unit thermistors (TH3, TH6, TH7 and TH8)
U5	Abnormal temperature of heatsink
U6	Abnormality of power module
U8	Abnormality in outdoor fan motor
Ud	Overheat protection
UE	Abnormal pressure of pressure sensor (63HS)
UF	Compressor overcurrent interruption (When Comp. locked)
UH	Current sensor error
UL	Abnormal low pressure
UP	Compressor overcurrent interruption
P1~P8	Abnormality of indoor units
PL	Abnormality of refrigerant
A0~A7	Communication error of M-NET system

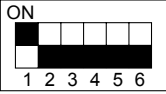
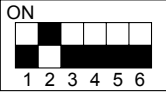
Display	Contents to be inspected (When power is turned on)
F5	63H connector(yellow) is open.
E8	Indoor/outdoor communication error (Signal receiving error) (Outdoor unit)
E9	Indoor/outdoor communication error (Transmitting error) (Outdoor unit)
EA	Miswiring of indoor/outdoor unit connecting wire, excessive number of indoor units (4 units or more)
Eb	Miswiring of indoor/outdoor unit connecting wire(converse wiring or disconnection)
EC	Startup time over
EE	Reverse connection of ATA/ATW communication wire
E0~E7	Communication error except for outdoor unit

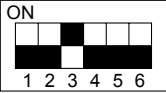
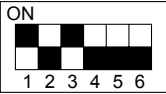
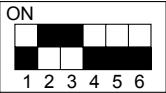
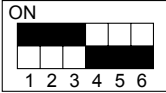
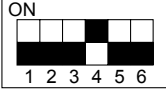
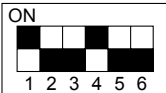
The black square (■) indicates a switch position.

SW2 setting	Display detail	Explanation for display	Unit
	Pipe temperature / Outdoor pipe (TH3) -40 – 90	-40 – 90 (When the coil thermistor detects 0°C or below, “-” and temperature are displayed by turns.) (Example) When -10°C; 0.5 secs. 0.5secs. 2 secs. -□ → 10 → □□	°C
	Discharge temperature (TH4) 3 – 217	3 – 217 (When the discharge thermistor detects 100°C or more, hundreds digit, tens digit and ones digit are displayed by turns.) (Example) When 105°C; 0.5 secs. 0.5secs. 2 secs. □1 → 05 → □□	°C
	Output step of outdoor FAN 0 – 10	0 – 10	Step
	The number of ON / OFF times of compressor 0 – 9999	0 – 9999 (When the number of times is 100 or more, hundreds digit, tens digit and ones digit are displayed by turns.) (Example) When 42500 times (425 × 100 times); 0.5 secs. 0.5secs. 2 secs. □4 → 25 → □□	100 times
	Compressor integrating operation times 0 – 9999	0 – 9999 (When it is 100 hours or more, hundreds digit, tens digit and ones digit are displayed by turns.) (Example) When 2450 hours (245 × 10 hours); 0.5 secs. 0.5secs. 2 secs. □2 → 45 → □□	10 hours
	Compressor operating current 0 – 50	0 – 50 * Omit the figures after the decimal fractions.	A
	Compressor operating frequency 0 – 255	0 – 255 (When it is 100Hz or more, hundreds digit, tens digit and ones digit are displayed by turns.) (Example) When 125Hz; 0.5 secs. 0.5secs. 2 secs. □1 → 25 → □□	Hz
	LEV-A opening pulse 0 – 480	0 – 480 (When it is 100 pulse or more, hundreds digit, tens digit and ones digit are displayed by turns.) (Example) When 150 pulse; 0.5 secs. 0.5secs. 2 secs. □1 → 50 → □□	Pulse
	Error postponement code history (1) of outdoor unit	Postponement code display Blinking: During postponement Lighting: Cancellation of postponement “00” is displayed in case of no postponement.	Code display
	Operation mode on error occurring	Operation mode of when operation stops due to error is displayed by setting SW2 like below.  (SW2) 	Code display



The black square (■) indicates a switch position.

SW2 setting	Display detail	Explanation for display	Unit
	Pipe temperature / Outdoor pipe (TH3) on error occurring -40 – 90	-40 – 90 (When the coil thermistor detects 0°C or below, “-” and temperature are displayed by turns.) (Example) When -15°C; 0.5 secs.   0.5secs.   2 secs. -□   → 15   → □□ 	°C
	Discharge temperature (TH4) on error occurring 3 – 217	3 – 217 (When the temperature is 100°C or more, the hundreds digit, tens digit and ones digit are displayed by turns.) (Example) When 130°C; 0.5 secs.   0.5secs.   2 secs. □1   → 30   → □□ 	°C
	Compressor operating current on error occurring 0 – 50	0 – 50	A
	Error code history (1) (latest) Alternate display of abnormal unit number and code	When no error history, “ 0 ” and “ - - ” are displayed by turns.	Code display
	Error code history (2) Alternate display of error unit number and code	When no error history, “ 0 ” and “ - - ” are displayed by turns.	Code display
	Thermostat ON time 0 – 999	0 – 999 (When it is 100 minutes or more, the hundreds digit, tens digit and ones digit are displayed by turns.) (Example) When 245 minutes; 0.5 secs.   0.5secs.   2 secs. □2   → 45   → □□ 	Minute
	Test run elapsed time 0 – 120	0 – 120 (When it is 100 minutes or more, the hundreds digit, tens digit and ones digit are displayed by turns.) (Example) When 105 minutes; 0.5 secs.   0.5secs.   2 secs. □1   → 05   → □□ 	Minute

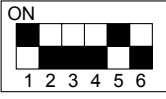
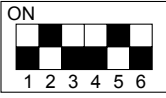
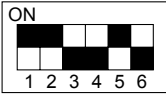
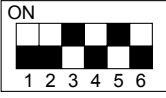
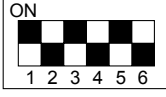
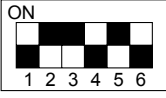
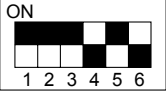
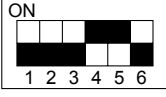

The black square (■) indicates a switch position.

SW2 setting	Display detail	Explanation for display	Unit										
	The number of connected indoor units	0 – 2 (The number of connected indoor units are displayed.)	Unit										
	Capacity setting display	Displayed as an outdoor capacity code. <table border="1" data-bbox="778 510 1083 573"> <thead> <tr> <th>Capacity</th> <th>Code</th> </tr> </thead> <tbody> <tr> <td>FRP71V</td> <td>14</td> </tr> </tbody> </table>	Capacity	Code	FRP71V	14	Code display						
Capacity	Code												
FRP71V	14												
	Outdoor unit setting information	<ul style="list-style-type: none"> <li>The tens digit (Total display for applied setting)</li> </ul> <table border="1" data-bbox="746 719 1318 837"> <thead> <tr> <th>Setting details</th> <th>Display details</th> </tr> </thead> <tbody> <tr> <td>H·P / Cooling only</td> <td>0 : H·P      1 : Cooling only</td> </tr> <tr> <td>Single phase / 3 phase</td> <td>0 : Single phase    2 : 3 phase</td> </tr> </tbody> </table> <ul style="list-style-type: none"> <li>The ones digit</li> </ul> <table border="1" data-bbox="746 898 1318 976"> <thead> <tr> <th>Setting details</th> <th>Display details</th> </tr> </thead> <tbody> <tr> <td>Defrosting switch</td> <td>0 : Normal    1 : For high humidity</td> </tr> </tbody> </table> <p>(Example) When heat pump, 3 phase and defrosting (normal) are set up, “20” is displayed.</p>	Setting details	Display details	H·P / Cooling only	0 : H·P      1 : Cooling only	Single phase / 3 phase	0 : Single phase    2 : 3 phase	Setting details	Display details	Defrosting switch	0 : Normal    1 : For high humidity	Code display
Setting details	Display details												
H·P / Cooling only	0 : H·P      1 : Cooling only												
Single phase / 3 phase	0 : Single phase    2 : 3 phase												
Setting details	Display details												
Defrosting switch	0 : Normal    1 : For high humidity												
	Indoor pipe temperature / Liquid (TH2(1)) Indoor 1 -39 – 88	-39 – 88 (When the temperature is 0°C or less, “-” and temperature are displayed by turns.)	°C										
	Indoor pipe temperature / Cond. / Eva. (TH5(1)) Indoor 1 -39 – 88	-39 – 88 (When the temperature is 0°C or less, “-” and temperature are displayed by turns.)	°C										
	Indoor pipe temperature / Liquid (TH2(2)) Indoor 2 -39 – 88	-39 – 88 (When the temperature is 0°C or less, “-” and temperature are displayed by turns.)	°C										
	Indoor pipe temperature / Cond. / Eva. (TH5(2)) Indoor 2 -39 – 88	-39 – 88 (When the temperature is 0°C or less, “-” and temperature are displayed by turns.)	°C										
	Indoor room temperature (TH1) 8 – 39	8 – 39	°C										

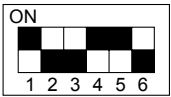
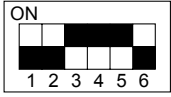
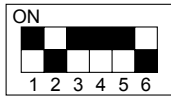
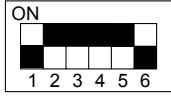
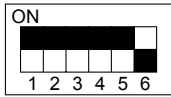
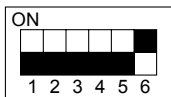
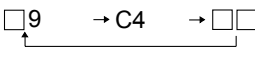
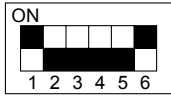
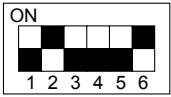
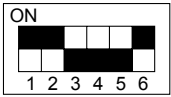

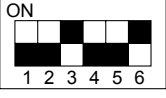
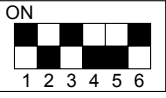
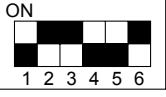
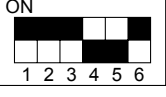
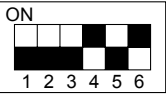
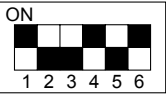

The black square (■) indicates a switch position.

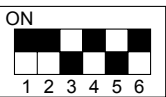
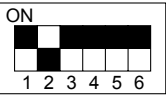
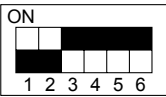
SW2 setting	Display detail	Explanation for display	Unit																		
	Indoor setting temperature 17 – 30	17 – 30	°C																		
	Outdoor pressure sensor saturated temperature (63HS) -39 – 88	-39 – 88 (When the temperature is 0°C or less, “-” and temperature are displayed by turns.)	°C																		
	Outdoor temperature (TH7) -39 – 88	-39 – 88 (When the temperature is 0°C or less, “-” and temperature are displayed by turns.)	°C																		
	Outdoor heatsink temperature (TH8) -40 – 200	-40 – 200 (When the temperature is 0°C or less, “-” and temperature are displayed by turns.) (When the thermistor detects 100°C or more, hundreds digit, tens digit and ones digit are displayed by turns.)	°C																		
	Discharge superheat SHd 0 – 255  [ TH4 - 63HS ]	0 – 255 (When the temperature is 100°C or more, hundreds digit, tens digit and ones digit are displayed by turns.)	°C																		
	Number of defrost cycles 0 – FFFE	0 – FFFE (in hexadecimal notation) (When more than FF in hex (255 in decimal), the number is displayed in order of 16 <sup>3</sup> 's and 16 <sup>2</sup> 's, and 16 <sup>1</sup> 's and 16 <sup>0</sup> 's places. (Example) When 5000 cycles; 0.5 secs. 0.5 secs. 2 secs. 	2 cycles																		
	Input current of outdoor unit	0 – 500 (When it is 100 or more, hundreds digit, tens digit and ones digit are displayed by turns.)	0.1 A																		
	Sub cool step	1 – 5	Step																		
	U9 error detail history (latest)	<table border="1"> <thead> <tr> <th>Description</th> <th>Display</th> </tr> </thead> <tbody> <tr> <td>(No error)</td> <td>00</td> </tr> <tr> <td>Overvoltage error</td> <td>01</td> </tr> <tr> <td>Undervoltage error</td> <td>02</td> </tr> <tr> <td>Input current sensor error</td> <td>04</td> </tr> <tr> <td>L-phase open error</td> <td>08</td> </tr> <tr> <td>Abnormal power synchronous signal</td> <td>10</td> </tr> <tr> <td>PFC error (Overvoltage / Undervoltage / Overcurrent)</td> <td>20</td> </tr> <tr> <td>PFC/ IGBT error (Undervoltage)</td> <td></td> </tr> </tbody> </table> <p>* Display examples for multiple errors: Overvoltage (01) + Undervoltage (02) = 03 Undervoltage (02) + Power-sync signal error (08) = 0A L-phase open error (04) + PFC error (10) = 14</p>	Description	Display	(No error)	00	Overvoltage error	01	Undervoltage error	02	Input current sensor error	04	L-phase open error	08	Abnormal power synchronous signal	10	PFC error (Overvoltage / Undervoltage / Overcurrent)	20	PFC/ IGBT error (Undervoltage)		Code display
Description	Display																				
(No error)	00																				
Overvoltage error	01																				
Undervoltage error	02																				
Input current sensor error	04																				
L-phase open error	08																				
Abnormal power synchronous signal	10																				
PFC error (Overvoltage / Undervoltage / Overcurrent)	20																				
PFC/ IGBT error (Undervoltage)																					

The black square (■) indicates a switch position.

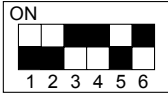
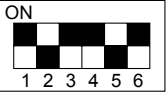
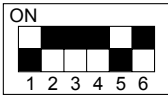
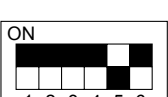
SW2 setting	Display detail	Explanation for display	Unit
	DC bus voltage 180 – 370	180 – 370 (When it is 100V or more, hundreds digit, tens digit and ones digit are displayed by turns.)	v
	Capacity save 0 – 100 When air conditioner is connected to M-NET and capacity save mode is demanded, "0" – "100" is displayed.  [ When there is no setting of capacity save "100" is displayed. ]	0~100 (When the capacity is 100% hundreds digit, tens digit and ones digit are displayed by turns.) (Example) When 100%; 0.5 secs.    0.5secs.    2 secs. □1        →00        →□□	%
	Error postponement code history (2) of outdoor unit	Postponement code display Blinking: During postponement Lighting: Cancellation of postponement "00" is displayed in case of no postponement.	Code display
	Error postponement code history (3) of outdoor unit	Postponement code display Blinking: During postponement Lighting: Cancellation of postponement "00" is displayed in case of no postponement.	Code display
	Error code history (3) (Oldest) Alternate display of abnormal unit number and code.	When no error history, "0" and "--" are displayed by turns.	Code display
	Error thermistor display  [ When there is no error thermistor, "--" is displayed. ]	3: Outdoor pipe temperature (TH3) 6: Outdoor 2-phase temperature (TH6) 7: Outdoor temperature (TH7) 8: Outdoor heatsink (TH8)	Code display
	Operation frequency on error occurring 0 – 255	0 – 255 (When it is 100Hz or more, hundreds digit, tens digit and ones digit are displayed by turns.) (Example) When 125Hz; 0.5 secs.    0.5secs.    2 secs. □1        →25        →□□	Hz
	Fan step on error occurring 0 – 10	0 – 10	Step
	FTC Δtj	0 – 99	Code
	ATA Δtj	0 – 99	Code

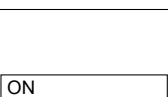
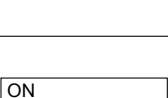
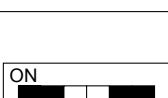
The black square (■) indicates a switch position.

SW2 setting	Display detail	Explanation for display	Unit
	LEV-A opening pulse on error occurring 0 – 480	0 – 480 (When it is 100 pulse or more, hundreds digit, tens digit and ones digit are displayed by turns.) (Example) When 130 pulse; 0.5 secs. 0.5secs. 2 secs. □1 → 30 → □□	Pulse
	Indoor room temperature (TH1) on error occurring 8 – 39	8 – 39	°C
	Indoor pipe temperature / Liquid (TH2) on error occurring -39 – 88	-39 – 88 (When the temperature is 0°C or less, “-” and temperature are displayed by turns.) (Example) When -15°C; 0.5 secs. 0.5secs. 2 secs. -□ → 15 → □□	°C
	Indoor pipe temperature / Cond./ Eva. (TH5) on error occurring -39 – 88	-39 – 88 (When the temperature is 0°C or less, “-” and temperature are displayed by turns.) (Example) When -15°C; 0.5 secs. 0.5secs. 2 secs. -□ → 15 → □□	°C
	Outdoor pressure sensor saturated temperature (63HS) on error occurring -39 – 88	-39 – 88 (When the temperature is 0°C or less, “-” and temperature are displayed by turns.) (Example) When -15°C; 0.5 secs. 0.5secs. 2 secs. -□ → 15 → □□	°C
	Outdoor temperature (TH7) on error occurring -39 – 88	-39 – 88 (When the temperature is 0°C or less, “-” and temperature are displayed by turns.) (Example) When -15°C; 0.5 secs. 0.5secs. 2 secs. -□ → 15 → □□	°C
	Outdoor heatsink temperature (TH8) on error occurring -40 – 200	-40 – 200 (When the temperature is 0°C or less, “-” and temperature are displayed by turns.) (When the temperature is 100°C or more, hundreds digit, tens digit and ones digit are displayed by turns.)	°C
	Discharge superheat on error occurring SHd 0 – 255 [ TH4 - 63HS ]	0 – 255 (When the temperature is 100°C or more, hundreds digit, tens digit and ones digit are displayed by turns.) (Example) When 150°C; 0.5 secs. 0.5secs. 2 secs. □1 → 50 → □□	°C
	Sub cool on error occurring SC 0 – 130	0 – 130 (When the temperature is 100°C or more, hundreds digit, tens digit and ones digit are displayed by turns.) (Example) When 115°C; 0.5 secs. 0.5secs. 2 secs. □1 → 15 → □□	°C

The black square (■) indicates a switch position.

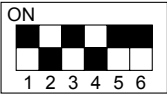
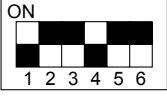
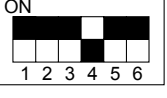
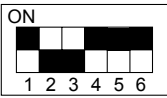
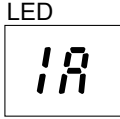
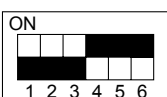
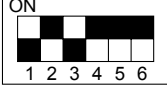
SW2 setting	Display detail	Explanation for display	Unit																
	Thermo-on time until error stops 0 – 999	0 – 999 (When it is 100 minutes or more, hundreds digit, tens digit and ones digit are displayed by turns.) (Example) When 415 minutes; 0.5 secs. 0.5secs. 2 secs. □4 → 15 → □□	Minute																
	LEV-B opening pulse 0 – 480	0 – 480 (When it is 100 pulse or more, hundreds digit, tens digit and ones digit are displayed by turns.) (Example) When 130 pulse; 0.5 secs. 0.5secs. 2 secs. □1 → 30 → □□	Pulse																
	LEV-C opening pulse 0 – 480	0 – 480 (When it is 100 pulse or more, hundreds digit, tens digit and ones digit are displayed by turns.) (Example) When 130 pulse; 0.5 secs. 0.5secs. 2 secs. □1 → 30 → □□	Pulse																
	Controlling status of compressor operating frequency	<p>The following code will be a help to know the operating status of unit.</p> <ul style="list-style-type: none"> <li>•The tens digit</li> </ul> <table border="1" data-bbox="754 1041 1225 1131"> <thead> <tr> <th>Display</th> <th>Compressor operating frequency control</th> </tr> </thead> <tbody> <tr> <td>1</td> <td>Primary current control</td> </tr> <tr> <td>2</td> <td>Secondary current control</td> </tr> </tbody> </table> <ul style="list-style-type: none"> <li>•The ones digit (In this digit, the total number of activated control is displayed.)</li> </ul> <table border="1" data-bbox="754 1209 1225 1451"> <thead> <tr> <th>Display</th> <th>Compressor operating frequency control</th> </tr> </thead> <tbody> <tr> <td>1</td> <td>Preventive control for excessive temperature rise of discharge temperature</td> </tr> <tr> <td>2</td> <td>Preventive control for excessive temperature rise of condensing temperature</td> </tr> <tr> <td>4</td> <td>Frosting preventing control</td> </tr> <tr> <td>8</td> <td>Preventive control for excessive temperature rise of heatsink</td> </tr> </tbody> </table> <p>(Example) The following controls are activated.</p> <ul style="list-style-type: none"> <li>• Primary current control</li> <li>• Preventive control for excessive temperature rise of condensing temperature</li> <li>• Preventive control for excessive temperature rise of heatsink</li> </ul> 	Display	Compressor operating frequency control	1	Primary current control	2	Secondary current control	Display	Compressor operating frequency control	1	Preventive control for excessive temperature rise of discharge temperature	2	Preventive control for excessive temperature rise of condensing temperature	4	Frosting preventing control	8	Preventive control for excessive temperature rise of heatsink	Code display
Display	Compressor operating frequency control																		
1	Primary current control																		
2	Secondary current control																		
Display	Compressor operating frequency control																		
1	Preventive control for excessive temperature rise of discharge temperature																		
2	Preventive control for excessive temperature rise of condensing temperature																		
4	Frosting preventing control																		
8	Preventive control for excessive temperature rise of heatsink																		
	FTC pipe temperature / liquid (TH2) -39 – 88	-39 – 88 (When the temperature is 0°C or less, “-” and temperature are displayed by turns.)	°C																
	Sub cool	0 – 130 (When the temperature is 100°C or more, hundreds digit, tens digit and ones digit are displayed by turns.)	°C																

11-1. UNIT FUNCTION SETTING BY THE REMOTE CONTROLLER

Each function can be set as necessary using the remote controller. The setting of function for each unit can only be done by the remote controller. Select function available from the table 1.

<Table 1> Function selections

(1) Functions available when setting the unit number to 00 (Select 00 referring to ④ setting the indoor unit number.)

Function	Settings	Mode No.	Setting No.	● : Initial setting (when sent from the factory)	Remarks
Power failure automatic recovery	OFF	01	1		The setting is applied to all the units in the same refrigerant system.
	ON		2	●	
Indoor temperature detecting *1	Average data from each indoor unit	02	1	●	
	Data from the indoor unit with remote controller		2		
	Data from main remote controller		3		
LOSSNAY connectivity	Not supported	03	1	●	
	Supported (Indoor unit does not intake outdoor air through LOSSNAY)		2		
	Supported (Indoor unit intakes outdoor air through LOSSNAY)		3		
Frost prevention temperature	2°C (Normal)	15	1	●	
	3°C		2		
Humidifier control	When the compressor operates, the humidifier also operates.	16	1	●	
	When the fan operates, the humidifier also operates.		2		
Change of defrosting control	Standard	17	1	●	
	For high humidity		2		

\*1 The functions above are available only when the wired remote controller is used. The functions are not available for floor standing models.

Meaning of "Function setting"

mode02:indoor temperature detecting

No.	Indoor temperature (ta)=	Diagram	Initial setting	ta=(A+B)/2	ta=(A+B)/2	ta=A	ta=A
No.1	Average data of the sensor on all the indoor units		Initial setting	ta=(A+B)/2	ta=(A+B)/2	ta=A	ta=A
No.2	The data of the sensor on the indoor unit that connected with remote controller			ta=A	ta=B	ta=A	ta=A
No.3	The data of the sensor on main remote controller.			ta=C	ta=C	ta=C	ta=C

(2) Functions available when setting the unit number to 01-03 or AL (07 in case of wireless remote controller)

- When setting functions for an indoor unit in an independent system, set the unit number to 01 referring to ④ setting the indoor unit number of Operating Procedure.
- When setting functions for a simultaneous- Twin Triple indoor unit system, set the unit number to 01 to 03 for each indoor unit in case of selecting different functions for each unit referring to ④ setting the indoor unit number of Operating Procedure.
- When setting the same functions for an entire simultaneous Twin Triple-indoor unit system, set refrigerant address to AL (07 in case of wireless remote controller) referring to ④ setting the indoor unit number of Operating Procedure.

Function	Settings	Mode No.	Setting No.	● : Initial setting (Factory setting) - : Not available					
				4-Way cassette	Ceiling suspended		Wall mounted		Floor standing
				PLA-BA	PCA-KAQ	PCA-HAQ	PKA-HAL	PKA-KAL	PSA-KA
Filter sign	100h	07	1			●	●	●	
	2500h		2	●					●
	No filter sign indicator		3						
Air flow (Fan speed)	Quiet	08	1			—	—		
	Standard		2	●	●	—	●	●	
	High ceiling		3			—	—		
No. of air outlets	4 directions	09	1	●	—	—	—	—	—
	3 directions		2		—	—	—	—	
	2 directions		3		—	—	—	—	
Optional high efficiency filter	Not supported	10	1	●	●	—	—	—	—
	Supported		2			—	—	—	
Vane setting	No vanes (Vane No.3 setting : PLA only)	11	1			—	—	—	—
	Vane No.1 setting		2		●	—	—	—	—
	Vane No.2 setting		3	●		—	—	—	—
Optional humidifier (PLA only)	Not supported	13	1	●	—	—	—	—	—
	Supported		2		—	—	—	—	
Vane differential setting in heating mode (cold wind prevention)	No.1 setting (TH5: 24-28°C)	14	1			—	—	—	—
	No.2 setting (Standard, TH5:28-32°C)		2	●	●	—	●	●	
	No.3 setting (TH5: 32-38°C)		3			—	—	—	
Swing	Not available	23	1		—	—	—	—	
	Available } Swing } PLA-BA Wave air flow }		2	●	●	—	●	●	
Set temperature in heating mode (4 deg up) *1	Available	24	1	●	●	●	●	●	
	Not available		2						
Fan speed during the heating thermo OFF	Extra low	25	1	●	●	●	●	●	
	Stop		2						
	Set fan speed		3						
Fan speed during the cooling thermo OFF	Set fan speed	27	1	●	●	●	●	●	
	Stop		2						
Detection of abnormality of the pipe temperature (P8)	Available	28	1	●	●	●	●	●	
	Not available		2						

\*1. PKA-HAL/KAL: 2 deg up

### PEAD-RP-JA(L)Q

Function	Settings	Mode No.	Setting No.	● : Initial setting (Factory setting)
Filter sign	100h	07	1	
	2500h		2	
	No filter sign indicator		3	●
External static pressure	35/50/70/100/150Pa	08	Refer to the right table	
External static pressure	35/50/70/100/150Pa	10	Refer to the right table	
Set temperature in heating mode (4 deg up)	Available	24	1	●
	Not available		2	
Fan speed during the heating thermo OFF	Extra low	25	1	●
	Stop		2	
	Set fan speed		3	
Fan speed during the cooling thermo OFF	Set fan speed	27	1	●
	Stop		2	
Detection of abnormality of the pipe	Available	28	1	●
	Not available		2	

External static pressure	Setting No.		Initial setting (Factory setting)
	Mode No. 08	Mode No. 10	
35Pa	2	1	
50Pa	3	1	●
70Pa	1	2	
100Pa	2	2	
150Pa	3	2	

### Mode No.11

Setting No.	Settings	PLA-BA	PCA-KAQ
1	Vane No.3 setting No Vanes	Less smudging ( Downward position than the standard )	No vane function
2	Vane No.1 setting	Standard	Standard
3	Vane No.2 setting	Less draft * (Upward position than the standard)	Less draft * (Upward position than the standard)

\* Be careful of the smudge on ceiling.





### 11-1-1. Selecting functions using the wired remote controller <PAR-31MAA>

#### <Service menu>

##### Maintenance password is required

① Select "Service" from the Main menu, and press the button.

\*At the main display, the menu button and select "Service" to make the maintenance setting.

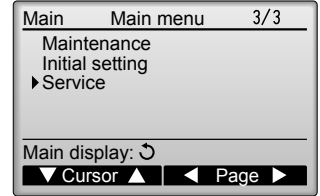

② When the Service menu is selected, a window will appear asking for the password.

To enter the current maintenance password (4 numerical digits), move the cursor to the digit you want to change with the **F1** or **F2** button.



Set each number (0 through 9) with the **F3** or **F4** button.



Then, press the button.

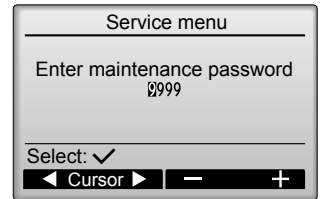

**Note: The initial maintenance password is "9999". Change the default password as necessary to prevent unauthorized access. Have the password available for those who need it.**

**: If you forget your maintenance password, you can initialize the password to the default password "9999" by pressing and holding the **F1** and **F2** buttons simultaneously for three seconds on the maintenance password setting screen.**

③ If the password matches, the Service menu will appear.

The type of menu that appears depends on the connected indoor units' type.

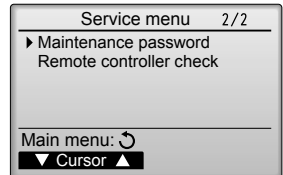
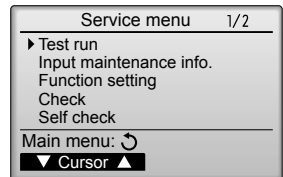

**Note: Air conditioning units may need to be stopped to make certain settings. There may be some settings that cannot be made when the system is centrally controlled.**



A screen will appear that indicates the setting has been saved.



**Navigating through the screens**

- To go back to the Main menu ..... button
- To return to the previous screen..... button

## <Function setting>

- ① Select "Service" from the Main menu, and press the  button.



Select "Function setting" with the **F1** or **F2** button, and press the  button.

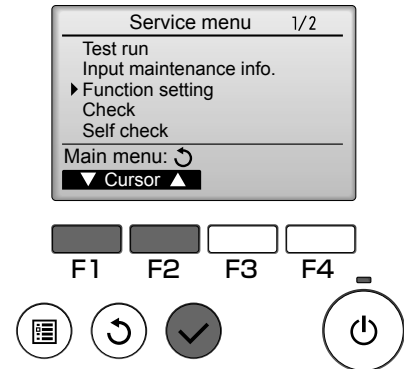

- ② Set the indoor unit refrigerant addresses and unit numbers with the **F1** through **F4** buttons, and then press the  button to confirm the current setting.

### <Checking the indoor unit No.>

When the  button is pressed, the target indoor unit will start fan operation. If the unit is common or when running all units, all indoor units for the selected refrigerant address will start fan operation.

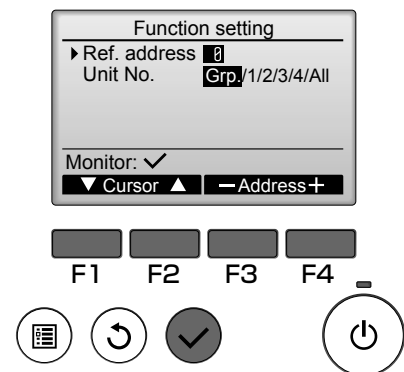

- ③ When data collection from the indoor units is completed, the current settings appears highlighted. Non-highlighted items indicate that no function settings are made. Screen appearance varies depending on the "Unit No." setting.

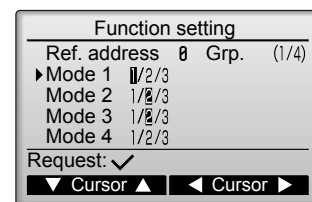

- ④ Use the **F1** or **F2** button to move the cursor to select the mode number, and change the setting number with the **F3** or **F4** button.

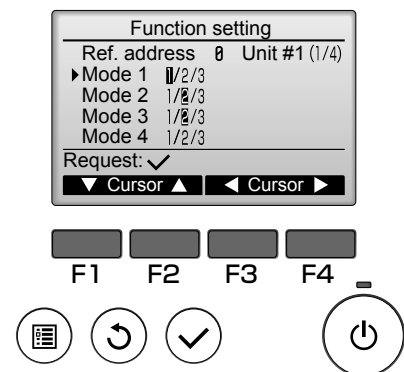

- ⑤ When the settings are completed, press the  button to send the setting data from the remote controller to the indoor units. When the transmission is successfully completed, the screen will return to the Function setting screen.

**Note:**

- Make the above settings only on Mr. Slim units as necessary.
- The above function settings are not available for the City Multi units.
- Table 1 summarizes the setting options for each mode number. Refer to the indoor unit Installation Manual for the detailed information about initial settings, mode numbers, and setting numbers for the indoor units.
- Be sure to write down the settings for all functions if any of the initial settings has been changed after the completion of installation work.

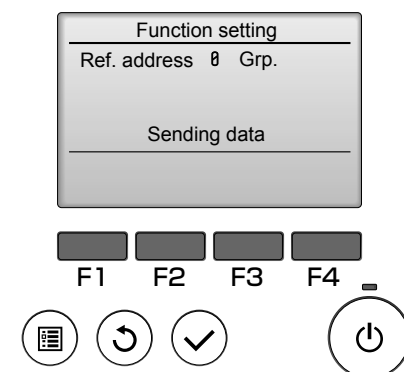

## 11-1-2. Selecting functions using the wired remote controller <PAR-21MAA>

First, try to familiarize yourself with the flow of the function selection procedure. In this section, an example of setting the room temperature detection position is given.

For actual operations, refer to steps ① to ⑩.

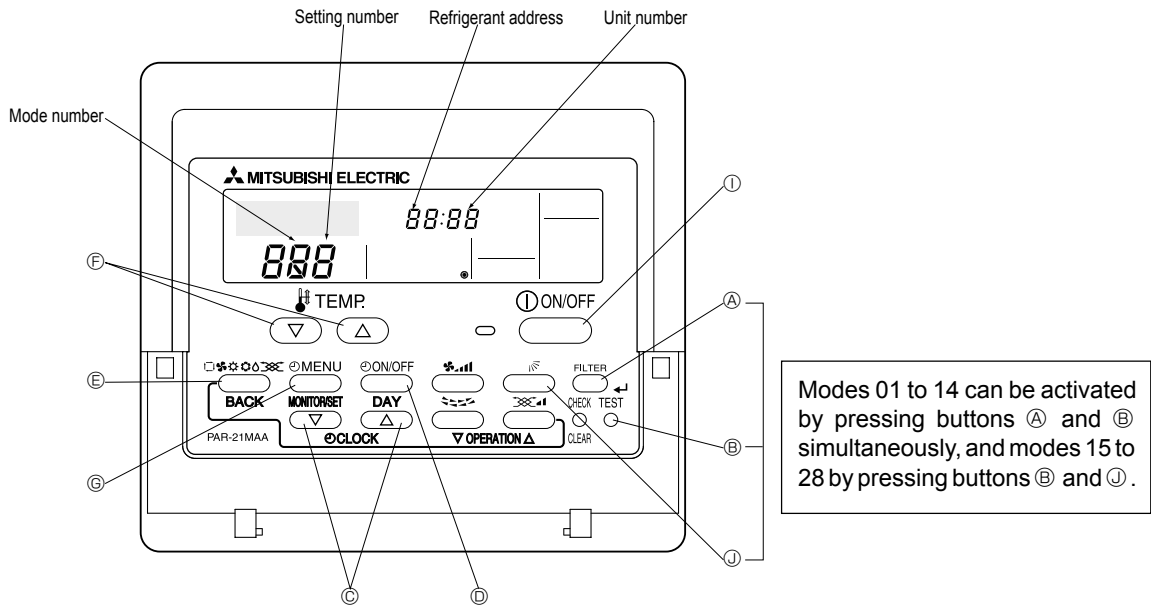

Selecting functions using the wired remote controller

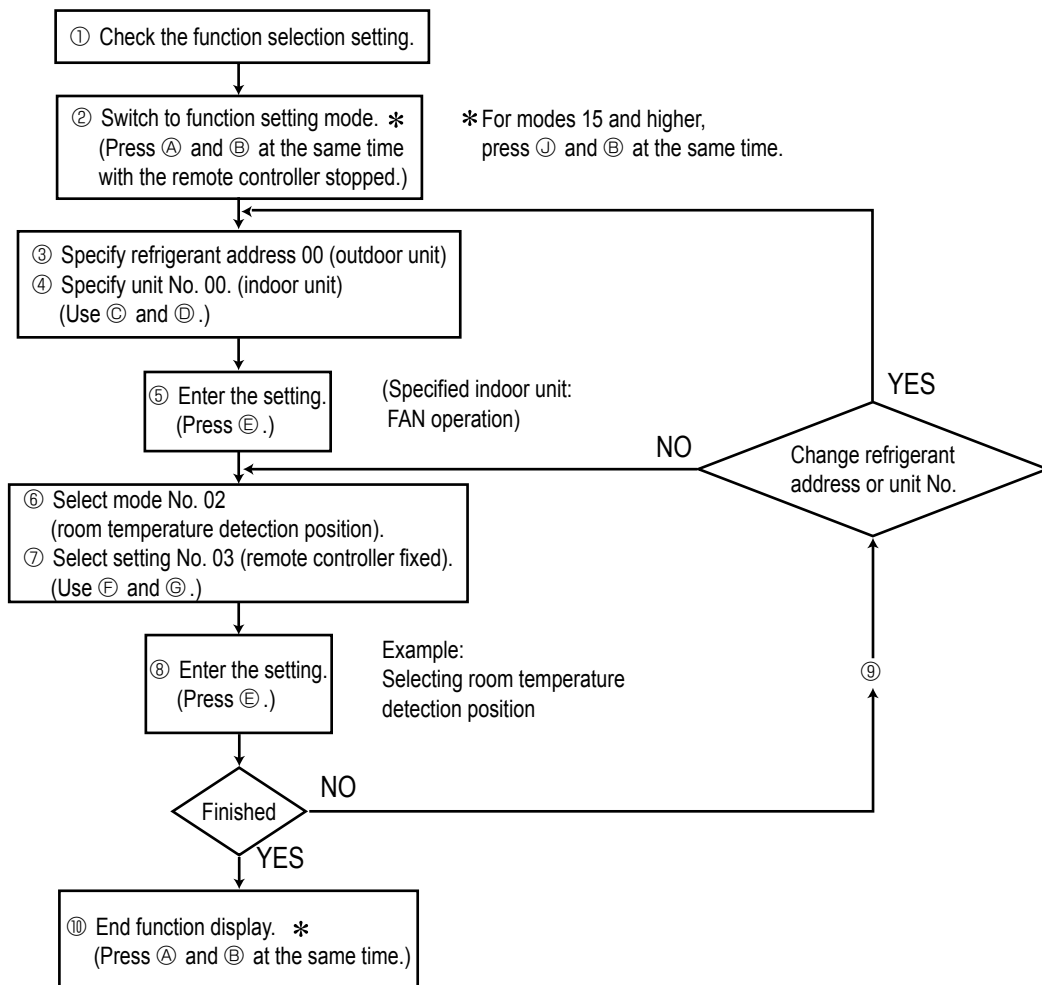

The above procedure must be carried out only if changes are necessary.

## [Operating Procedure]

① Check the setting items provided by function selection.

If settings for a mode are changed by function selection, the functions of that mode will be changed accordingly. Check all the current settings according to steps ② to ⑦, fill in the "Check" column in Table 1, and then change them as necessary. For factory settings, refer to the indoor unit's installation manual.

② Switch off the remote controller.

A Hold down the **FILTER** (mode is 15 to 28) and **TEST** buttons simultaneously for at least 2 seconds. **FUNCTION SELECTION** will start to flash, and then the remote controller's display content will change as shown below.



③ Set the outdoor unit's refrigerant address.

③ Press the [**⏪** CLOCK] buttons (**▽** and **△**) to select the desired refrigerant address. The refrigerant address changes from "00" to "15". (This operation is not possible for single refrigerant systems.)

\* If the unit stops after **FUNCTION SELECTION** flashed for 2 seconds or "88" flashes in the room temperature display area for 2 seconds, a transmission error may have occurred. Check to see if there are any sources of noise or interference near the transmission path.

### Note

If you have made operational mistakes during this procedure, exit function selection (see step ⑩), and then restart from step ②.

④ Set the indoor unit number.

④ Press the **ON/OFF** button so that "-" flashes in the unit number display area.



④ Press the [**⏪** CLOCK] buttons (**▽** and **△**) to select the unit number of the indoor unit for which you want to perform function selection. The unit number changes to "00", "01", "02", "03", "04" each time a button is pressed.

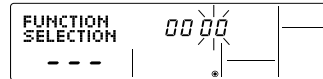

- \* To set modes 01 to 06 or 15 to 22 select unit number "00".
- \* To set modes 07 to 14 or 23 to 28 carry out as follows:
  - To set each indoor unit individually, select "01" to "04".
  - To set all the indoor units collectively, select "AL".

⑤ Confirm the refrigerant address and unit number.

⑤ Press the **MODE** button to confirm the refrigerant address and unit number. After a while, "-" will start to flash in the mode number display area.

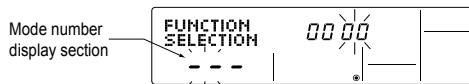

\* "88" will flash in the room temperature display area if the selected refrigerant address does not exist in the system. Furthermore, if "F" appears and flashes in the unit number display area and the refrigerant address display area also flashes, there are no units that correspond to the selected unit number. In this case, the refrigerant address and unit number may be incorrect, so repeat steps ② and ③ to set the correct ones.

⑤ When the refrigerant address and unit number are confirmed by pressing the **MODE** button, the corresponding indoor unit will start fan operation. This helps you find the location of the indoor unit for which you want to perform function selection. However, if "00" or "AL" is selected as the unit number, all the indoor units corresponding to the specified refrigerant address will start fan operation.

Example) When the refrigerant address is set to 00 and the unit number is 02.

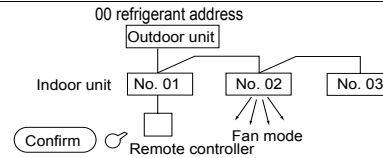

\* When grouping different refrigerant systems, if an indoor unit other than the one to which the refrigerant address has been set performs fan operation, there may be another refrigerant address that is the same as the specified one. In this case, check the DIP switch of the outdoor unit to see whether such a refrigerant address exists.

⑥ Select the mode number.

⑥ Press the [**TEMP**] buttons (**▽** and **△**) to set the desired mode number. (Only the selectable mode numbers can be selected.)



Mode number 02 = Indoor temperature detection

⑦ Select the setting content for the selected mode.

⑦ Press the **MENU** button. The currently selected setting number will flash, so check the currently set content.



Setting number display section      Setting number 1 = Indoor unit operating average

⑦ Press the [**TEMP**] buttons (**▽** and **△**) to select the desired setting number.



Setting number 3 = Remote controller built-in sensor

⑧ Register the settings you have made in steps ③ to ⑦.

⑧ Press the **MODE** button. The mode number and setting number will start to flash and registration starts.



The mode number and setting number will stop flashing and remain lit, indicating the end of registration.

\* If "-" is displayed for both the mode number and setting number and "88" flashes in the room temperature display area, a transmission error may have occurred. Check to see if there are any sources of noise or interference near the transmission path.

⑨ To make additional settings in the FUNCTION SELECTION screen, repeat the steps ③ through ⑧.

Note. After setting the modes 07 through 14, the modes 23 through 28 cannot be set continuously, or vice versa. In this case, after completing the settings for the modes 07 through 14 or 23 through 28, go to the step 10 to finish setting, and restart setting from the step 1. At this point, wait for 30 seconds or more before restarting setting. Otherwise, the temperature may indicate "88".

⑩ Complete function selection.

A Hold down the **FILTER** (mode is 15 to 28) and **TEST** buttons simultaneously for at least 2 seconds.

After a while, the function selection screen will disappear and the air conditioner OFF screen will reappear.



\* Do not operate the remote controller for at least 30 seconds after completing function selection. (No operations will be accepted even if they are made.)

### Note

If a function of an indoor unit is changed by function selection after installation is complete, make sure that a "O" mark, etc., is given in the "Check" column of Table 1 to indicate the change.

### 11-1-3. Selecting functions using the wireless remote controller (Type C)

Functions can be selected with the wireless remote controller. Function selection using wireless remote controller is available only for refrigerant system with wireless function. Refrigerant address cannot be specified by the wireless remote controller.

#### [Flow of function selection procedure]

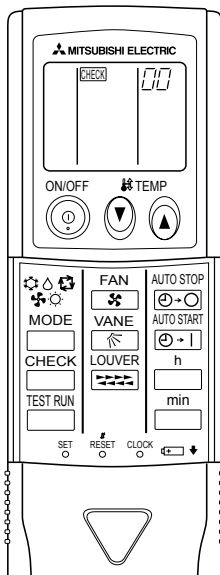

The flow of the function selection procedure is shown below. This example shows how to turn off the function that raises the set temperature by 4 degrees during HEAT operation. (Mode 24: 2)  
The procedure is given after the flow chart.

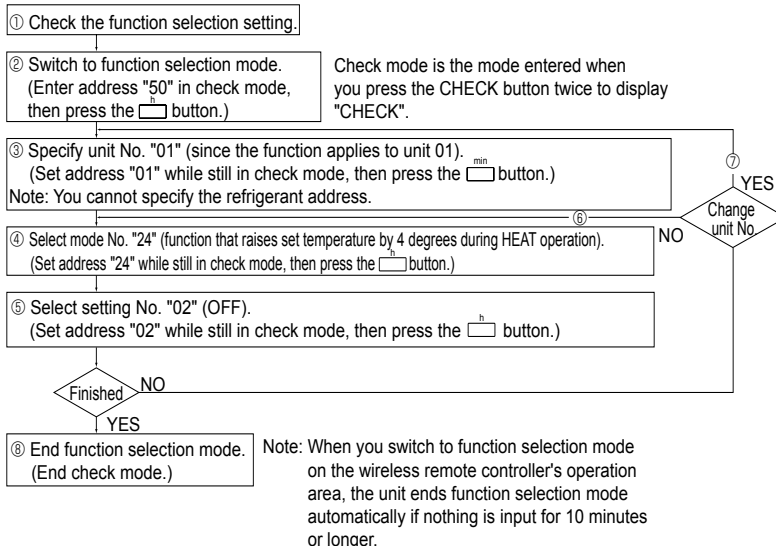

#### [Operating instructions]

- ① Check the function settings.
  - ② Press the **CHECK** button twice continuously. → **CHECK** is lit and "00" blinks.  
Press the temp **h** button once to set "50". Direct the wireless remote controller toward the receiver of the indoor unit and press the **h** button.
  - ③ Set the unit number.  
Press the temp **min** button to set the unit number. (Press "01" to specify the indoor unit whose unit number is 01.)  
Direct the wireless remote controller toward the receiver of the indoor unit and press the **min** button.  
(By setting unit number with the **min** button, specified indoor unit starts performing fan operation.  
Detect which unit is assigned to which number using this function. If unit number is set to AL, all the indoor units in same refrigerant system start performing fan operation simultaneously.)  
\* If a unit number that cannot be recognized by the unit is entered, 3 beeps of 0.4 seconds will be heard. Reenter the unit number setting.  
\* If the signal was not received by the sensor, you will not hear a beep or a "double beep" may be heard. Reenter the unit number setting.
  - ④ Select a mode.  
Press the temp **h** button to set a mode. Press "24" to turn on the function that raises the set temperature by 4 degree during heat operation. Direct the wireless remote controller toward the sensor of the indoor unit and press the **h** button.  
→ The sensor-operation indicator will flash and beeps will be heard to indicate the current setting number.  
Current setting number: 1 = 1 beep (1 second)  
2 = 2 beeps (1 second each)  
3 = 3 beeps (1 second each)  
\* If a mode number that cannot be recognized by the unit is entered, 3 beeps of 0.4 seconds will be heard. Reenter the mode number.  
\* If the signal was not received by the sensor, you will not hear a beep or a "double beep" may be heard. Reenter the mode number.
  - ⑤ Select the setting number.  
Press the temp **h** button to select the setting number. (02: Not available)  
Direct the wireless remote controller toward the receiver of the indoor unit and press the **h** button.  
→ The sensor-operation indicator will flash and beeps will be heard to indicate the setting number.  
Setting number: 1 = 2 beeps (0.4 seconds each)  
2 = 2 beeps (0.4 seconds each, repeated twice)  
3 = 2 beeps (0.4 seconds each, repeated 3 times)  
\* If a setting number that cannot be recognized by the unit is entered, the setting will turn back to the original setting.  
\* If the signal was not received by the sensor, you will not hear a beep or a "double beep" may be heard. Reenter the setting number.
  - ⑥ Repeat steps ④ and ⑤ to make an additional setting without changing unit number.
  - ⑦ Repeat steps ③ to ⑤ to change unit number and make function settings on it.
  - ⑧ Complete the function settings  
Press **p** button.
- \* Do not use the wireless remote controller for 30 seconds after completing the function setting.

## 11-2. FUNCTION SELECTION OF REMOTE CONTROLLER

### 11-2-1. PAR-31MAA

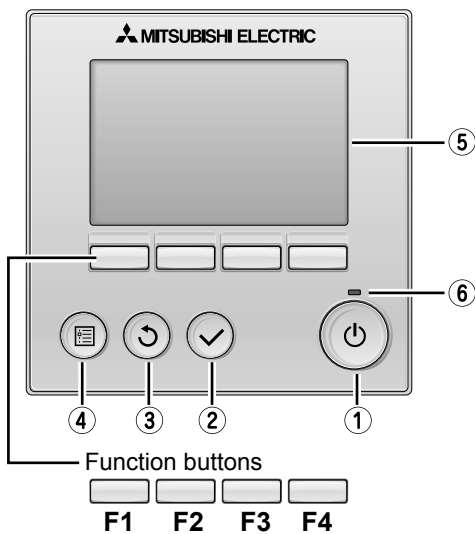

The functions of the function buttons change depending on the screen. Refer to the button function guide that appears at the bottom of the LCD for the functions they serve on a given screen.

When the system is centrally controlled, the button function guide that corresponds to the locked button will not appear.

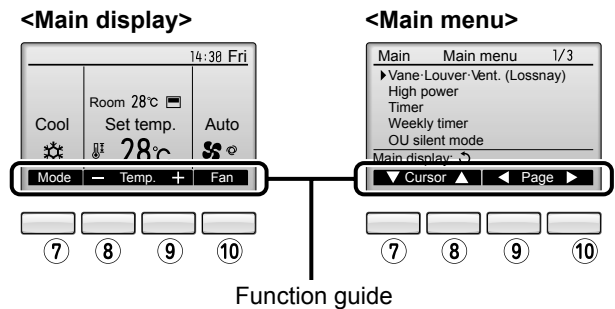

#### ① ON / OFF button

Press to turn ON/OFF the indoor unit.

#### ② SELECT button

Press to save the setting.

#### ③ RETURN button

Press to return to the previous screen.

#### ④ MENU button

Press to bring up the Main menu.

#### ⑤ Backlit LCD

Operation settings will appear.  
When the backlight is off, pressing any button turns the backlight on and it will stay lit for a certain period of time depending on the screen.

**When the backlight is off, pressing any button turns the backlight on and does not perform its function. (except for the (ON / OFF) button)**

#### ⑥ ON / OFF lamp

This lamp lights up in green while the unit is in operation. It blinks while the remote controller is starting up or when there is an error.

#### ⑦ Function button **F1**

Main display : Press to change the operation mode.

Main menu : Press to move the cursor down.

#### ⑧ Function button **F2**

Main display : Press to decrease temperature.

Main menu : Press to move the cursor up.

#### ⑨ Function button **F3**

Main display : Press to increase temperature.

Main menu : Press to go to the previous page.

#### ⑩ Function button **F4**

Main display : Press to change the fan speed.

Main menu : Press to go to the next page.

## <Menu structure of PAR-31MAA>

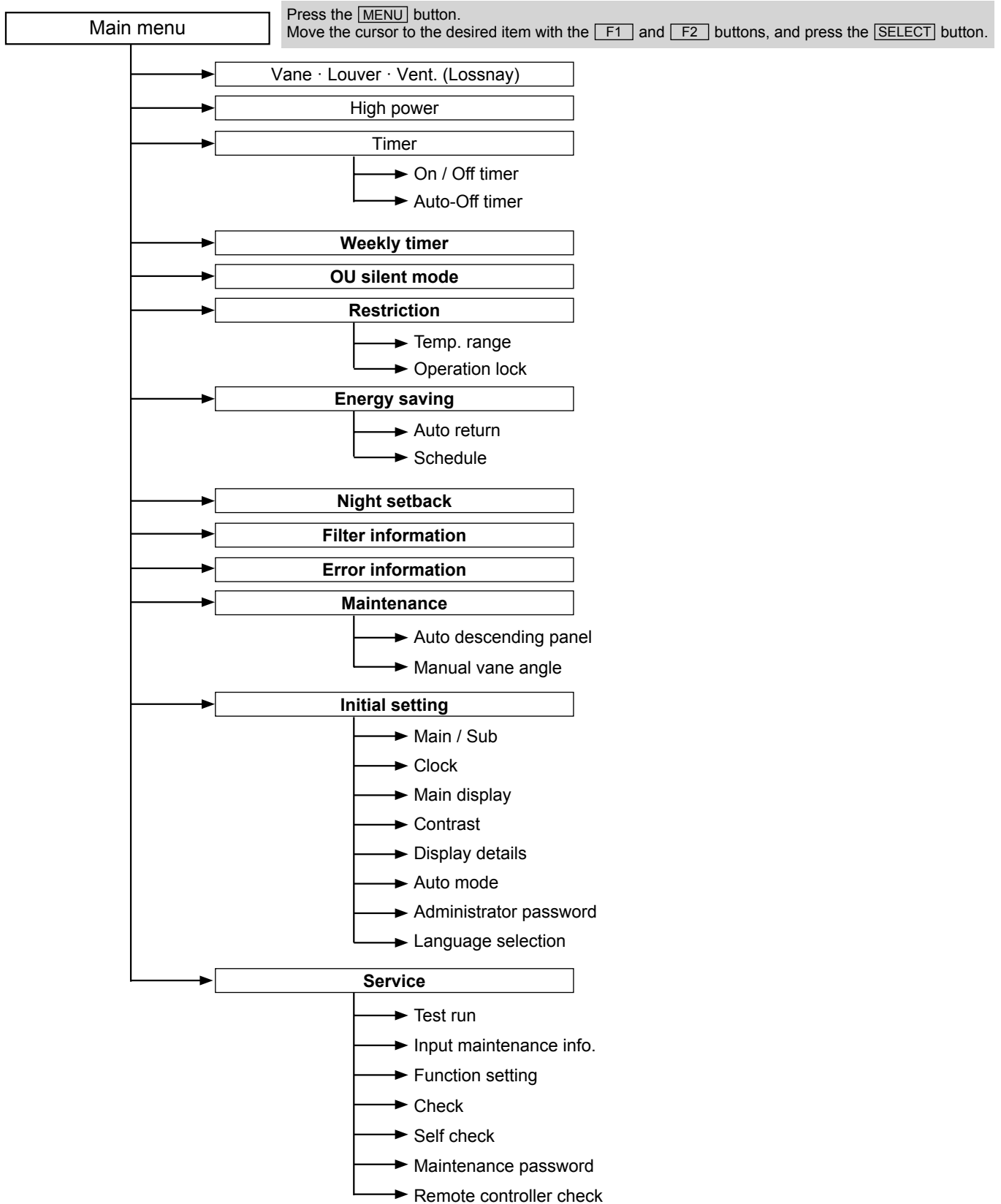

Not all functions are available on all models of indoor units.

## <Main menu list of PAR-31MAA>

Setting and display items		Setting details
Vane · Louver · Vent. (Lossnay)		Use to set the vane angle. <ul style="list-style-type: none"> <li>• Select a desired vane setting from five different settings.</li> </ul> Use to turn ON / OFF the louver. <ul style="list-style-type: none"> <li>• Select a desired setting from "ON" and "OFF."</li> </ul> Use to set the amount of ventilation. <ul style="list-style-type: none"> <li>• Select a desired setting from "Off" "Low" and "High".</li> </ul>
High power		Use to reach the comfortable room temperature quickly. <ul style="list-style-type: none"> <li>• Units can be operated in the High-power mode for up to 30 minutes.</li> </ul>
Timer	On/Off timer	Use to set the operation On/Off times. <ul style="list-style-type: none"> <li>• Time can be set in 5-minute increments.</li> <li>* Clock setting is required.</li> </ul>
	Auto-Off timer	Use to set the Auto-Off time. <ul style="list-style-type: none"> <li>• Time can be set to a value from 30 to 240 in 10-minute increments.</li> </ul>
Weekly timer		Use to set the weekly operation On / Off times. <ul style="list-style-type: none"> <li>• Up to eight operation patterns can be set for each day.</li> <li>* Clock setting is required.</li> <li>* Not valid when the On/Off timer is enabled.</li> </ul>
OU silent mode		Use to set the time periods in which priority is given to quiet operation of outdoor units over temperature control. Set the Start/Stop times for each day of the week. <ul style="list-style-type: none"> <li>• Select the desired silent level from "Normal", "Middle" and "Quiet".</li> <li>* Clock setting is required.</li> </ul>
Restriction	Temp. range	Use to restrict the preset temperature range. <ul style="list-style-type: none"> <li>• Different temperature ranges can be set for different operation modes.</li> </ul>
	Operation lock	Use to lock selected functions. <ul style="list-style-type: none"> <li>• The locked functions cannot be operated.</li> </ul>
Energy saving	Auto return	Use to get the units to operate at the preset temperature after performing energy-save operation for a specified time period. <ul style="list-style-type: none"> <li>• Time can be set to a value from 30 and 120 in 10-minute increments.</li> <li>* This function will not be valid when the preset temperature ranges are restricted.</li> </ul>
	Schedule	Set the start/stop times to operate the units in the energy-save mode for each day of the week, and set the energy-saving rate. <ul style="list-style-type: none"> <li>• Up to four energy-save operation patterns can be set for each day.</li> <li>• Time can be set in 5-minute increments.</li> <li>• Energy-saving rate can be set to a value from 0% and 50 to 90% in 10% increments.</li> <li>* Clock setting is required.</li> </ul>
Night setback		Use to make Night setback settings. <ul style="list-style-type: none"> <li>• Select "Yes" to enable the setting, and "No" to disable the setting. The temperature range and the start/stop times can be set.</li> <li>* Clock setting is required.</li> </ul>
Filter information		Use to check the filter status. <ul style="list-style-type: none"> <li>• The filter sign can be reset.</li> </ul>
Error information		Use to check error information when an error occurs. <ul style="list-style-type: none"> <li>• Error code, error source, refrigerant address, unit model, manufacturing number, contact information (dealer's phone number) can be displayed.</li> <li>* The unit model, manufacturing number, and contact information need to be registered in advance to be displayed.</li> </ul>
Maintenance	Auto descending panel	Auto descending panel (Optional parts) Up / Down you can do.
	Manual vane angle	Use to set the vane angle for each vane to a fixed position.
Initial setting	Main/Sub	When connecting two remote controllers, one of them needs to be designated as a sub controller.
	Clock	Use to set the current time.
	Main display	Use to switch between "Full" and "Basic" modes for the Main display. <ul style="list-style-type: none"> <li>• The default setting is "Full".</li> </ul>
	Contrast	Use to adjust screen contrast.





Setting and display items		Setting details
Initial setting	Display details	Make the settings for the remote controller related items as necessary. Clock: The factory settings are "Yes" and "24h" format. Temperature: Set either Celsius (°C) or Fahrenheit (°F). Room temp. : Set Show or Hide. Auto mode: Set the Auto mode display or Only Auto display.
	Auto mode	Whether or not to use the AUTO mode can be selected by using the button. This setting is valid only when indoor units with the AUTO mode function are connected.
	Administrator password	The administrator password is required to make the settings for the following items. • Timer setting • Energy-save setting • Weekly timer setting • Restriction setting • Outdoor unit silent mode setting • Night set back
	Language selection	Use to select the desired language.
Service	Test run	Select "Test run" from the Service menu to bring up the Test run menu. • Test run • Drain pump test run
	Input maintenance	Select "Input maintenance Info." from the Service menu to bring up the Maintenance information screen. The following settings can be made from the Maintenance Information screen. • Model name input • Serial No. input • Dealer information input
	Function setting	Make the settings for the indoor unit functions via the remote controller as necessary.
	Check	Error history: Display the error history and execute delete error history. Refrigerant leak check: Refrigerant leaks can be judged. Smooth maintenance: The indoor and outdoor maintenance data can be displayed. Request cord: Details of the operation data including each thermistor temperature and error history can be checked.
	Self check	Error history of each unit can be checked via the remote controller.
	Maintenance password	Take the following steps to change the maintenance password.
	Remote controller check	When the remote controller does not work properly, use the remote controller checking function to troubleshoot the problem.

## 11-2-2. PAR-21MAA

The setting of the following remote controller functions can be changed using the remote controller function selection mode.  
Change the setting when needed.

Item 1	Item 2	Item 3 (Setting content)
1.Change Language ("CHANGE LANGUAGE")	Language setting to display	• Display in multiple languages is possible.
2.Function limit ("FUNCTION SELECTION")	(1) Operation function limit setting (operation lock) ("LOCKING FUNCTION")	• Setting the range of operation limit (operation lock)
	(2) Use of automatic mode setting ("SELECT AUTO MODE")	• Setting the use or non-use of "automatic" operation mode
	(3) Temperature range limit setting ("LIMIT TEMP FUNCTION")	• Setting the temperature adjustable range (maximum, minimum)
3.Mode selection ("MODE SELECTION")	(1) Remote controller main/sub setting ("CONTROLLER MAIN/SUB")	• Selecting main or sub remote controller * When two remote controllers are connected to one group, one controller must be set to sub.
	(2) Use of clock setting ("CLOCK")	• Setting the use or non-use of clock function
	(3) Timer function setting ("WEEKLY TIMER")	• Setting the timer type
	(4) Contact number setting for error situation ("CALL.")	• Contact number display in case of error • Setting the telephone number
4.Display change ("DISP MODE SETTING")	(1) Temperature display °C/°F setting ("TEMP MODE °C/°F")	• Setting the temperature unit (°C or °F) to display
	(2) Room air temperature display setting ("ROOM TEMP DISP SELECT")	• Setting the use or non-use of the display of indoor (suction) air temperature
	(3) Automatic cooling/heating display setting ("AUTO MODE DISP C/H")	• Setting the use or non-use of the display of "Cooling" or "Heating" display during operation with automatic mode

[Function selection flowchart] Refer to next page.

[1] Stop the air conditioner to start remote controller function selection mode. → [2] Select from item1. → [3] Select from item2. → [4] Make the setting. (Details are specified in item3) → [5] Setting completed. → [6] Change the display to the normal one. (End)

[Detailed setting]

### [4] -1. CHANGE LANGUAGE setting

The language that appears on the dot display can be selected.

- Press the [⊖MENU] button to change the language.
- ① Japanese (JP), ② English (GB), ③ German (D), ④ Spanish (E),
- ⑤ Russian (RU), ⑥ Italian (I), ⑦ Chinese (CH), ⑧ French (F)

### [4] -2. Function limit

#### (1) Operation function limit setting (operation lock)

- To switch the setting, press the [⊖ON/OFF] button.
- ① no1 : All operation buttons except [⊖ON/OFF] button are locked.
- ② no2 : All buttons are locked.
- ③ OFF (Initial setting value) : Operation lock setting is not made
- \* To make the operation lock setting valid on the normal screen, it is necessary to press buttons (Press and hold down the [FILTER] and [⊖ON/OFF] buttons at the same time for 2 seconds.) on the normal screen after the above setting is made.

#### (2) Use of automatic mode setting

When the remote controller is connected to the unit that has automatic operation mode, the following settings can be made.

- To switch the setting, press the [⊖ON/OFF] button.
- ① ON (Initial setting value) : The automatic mode is displayed when the operation mode is selected.
- ② OFF : The automatic mode is not displayed when the operation mode is selected.

### (3) Temperature range limit setting

After this setting is made, the temperature can be changed within the set range.

- To switch the setting, press the [⊖ON/OFF] button.
- ① LIMIT TEMP COOL MODE :  
The temperature range can be changed on cooling/dry mode.
- ② LIMIT TEMP HEAT MODE :  
The temperature range can be changed on heating mode.
- ③ LIMIT TEMP AUTO MODE :  
The temperature range can be changed on automatic mode.
- ④ OFF (initial setting) : The temperature range limit is not active.
- \* When the setting, other than OFF, is made, the temperature range limit setting on cooling, heating and automatic mode is made at the same time. However the range cannot be limited when the set temperature range has not changed.
- To increase or decrease the temperature, press the [⬇️TEMP (▽)] or [⬆️] button.
- To switch the upper limit setting and the lower limit setting, press the [⚡,⬆️] button. The selected setting will flash and the temperature can be set.
- Settable range  
Cooling/Dry mode : Lower limit: 19 °C ~ 30 °C Upper limit: 30 °C ~ 19 °C  
Heating mode : Lower limit: 17 °C ~ 28 °C Upper limit: 28 °C ~ 17 °C  
Automatic mode : Lower limit: 19 °C ~ 28 °C Upper limit: 28 °C ~ 19 °C

### [4] -3. Mode selection setting

#### (1) Remote controller main/sub setting

- To switch the setting, press the [⊖ON/OFF] button.
- ① Main : The controller will be the main controller.
- ② Sub : The controller will be the sub controller.

#### (2) Use of clock setting

- To switch the setting, press the [⊖ON/OFF] button.
- ① ON : The clock function can be used.
- ② OFF : The clock function cannot be used.

#### (3) Timer function setting

- To switch the setting, press the [⊖ON/OFF] button (Choose one of the followings.).
- ① WEEKLY TIMER (initial setting):  
The weekly timer can be used.
- ② AUTO OFF TIMER: The auto off timer can be used.
- ③ SIMPLE TIMER: The simple timer can be used.
- ④ TIMER MODE OFF: The timer mode cannot be used.
- \* When the use of clock setting is OFF, the "WEEKLY TIMER" cannot be used.

#### (4) Contact number setting for error situation

- To switch the setting, press the [⊖ON/OFF] button.
- ① CALL OFF : The set contact numbers are not displayed in case of error.
- ② CALL \*\*\*\* \* : The set contact numbers are displayed in case of error.  
CALL\_ : The contact number can be set when the display is as shown on the left.

- Setting the contact numbers

To set the contact numbers, follow the following procedures.

Move the flashing cursor to set numbers. Press the [⬆️TEMP (▽)] and [⬆️] button to move the cursor to the right (left). Press the [⊖CLOCK (▽)] and [⬆️] button to set the numbers.

### [4] -4. Display change setting

#### (1) Temperature display °C/°F setting

- To switch the setting, press the [⊖ON/OFF] button.
- ① °C : The temperature unit °C is used.
- ② °F : The temperature unit °F is used.

#### (2) Room air temperature display setting

- To switch the setting, press the [⊖ON/OFF] button.
- ① ON : The room air temperature is displayed.
- ② OFF : The room air temperature is not displayed.

#### (3) Automatic cooling/heating display setting

- To switch the setting, press the [⊖ON/OFF] button.
- ① ON : One of "Automatic cooling" and "Automatic heating" is displayed under the automatic mode is running.
- ② OFF : Only "Automatic" is displayed under the automatic mode.

**[Function selection flowchart]**  
Setting language (English)

Normal display  
(Display when the air conditioner is not running)

Hold down the (E) button and press the (D) button for 2 seconds.

- (E) Press the operation mode button.
- (G) Press the TIMER MENU button.
- (D) Press the TIMER ON/OFF button.

Change Language

Function selection

Mode selection

Display mode setting

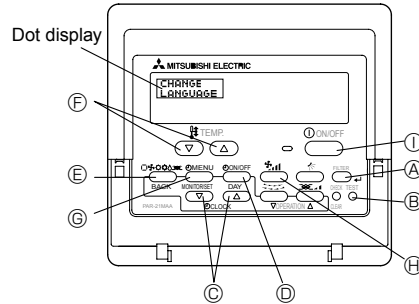
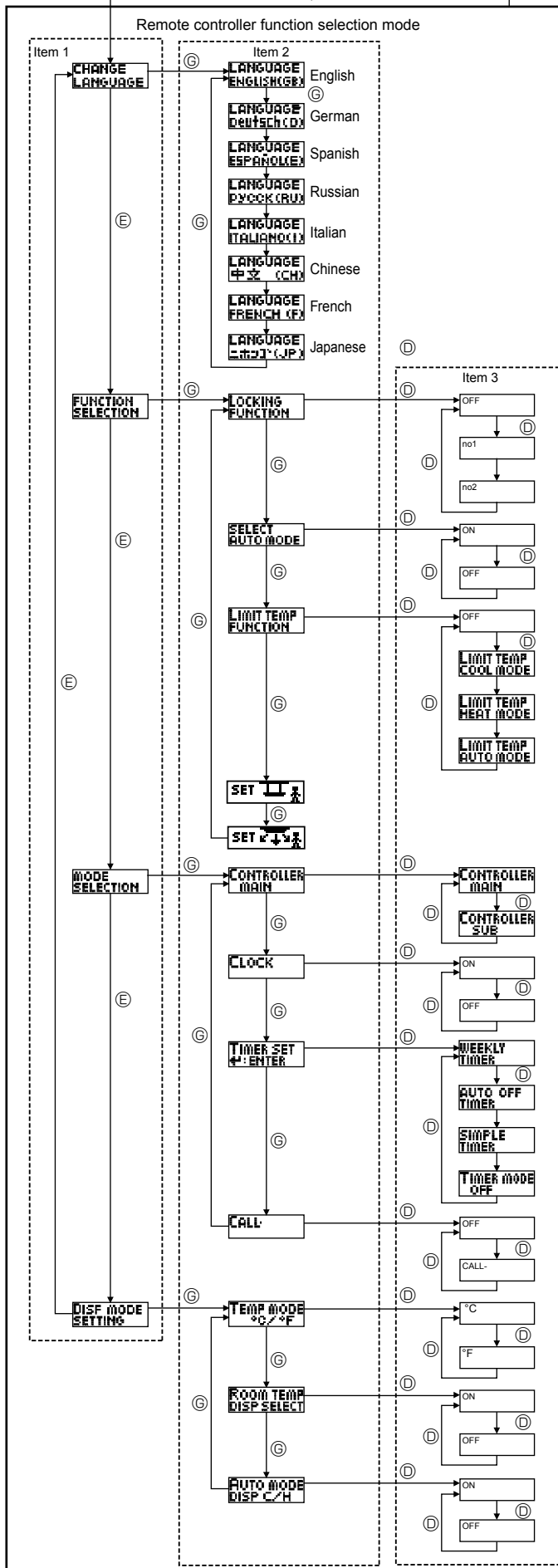

- Operation lock setting is not used. (Initial setting value)
- All buttons except On/Off button are locked.
- All buttons are locked.
- The automatic mode is displayed when the operation mode is selected. (Initial setting value)
- The automatic mode is not displayed when the operation mode is selected.
- The temperature range limit is not active. (Initial setting value)
- The temperature range can be changed on cooling/dry mode.
- The temperature range can be changed on heating mode.
- The temperature range can be changed on automatic mode.
- Automatic filter elevation panel up/down operation mode  
Not necessary to set this mode. Refer to OPERATION MANUAL of Optional Parts (Panel) for details on operation.
- Fixed air flow direction mode  
Not necessary to set this mode. Refer to OPERATION MANUAL of indoor unit for details on operation.
- The remote controller will be the main controller. (Initial setting value)
- The remote controller will be the sub controller.
- The clock function can be used. (Initial setting value)
- The clock function cannot be used.
- Weekly timer can be used. (Initial setting value)
- Auto off timer can be used.
- Simple timer can be used.
- Timer mode cannot be used.
- The set contact numbers are not displayed in case of error. (Initial setting value)
- The set contact numbers are displayed in case of error.
- The temperature unit °C is used. (Initial setting value)
- The temperature unit °F is used.
- Room air temperature is displayed. (Initial setting value)
- Room air temperature is not displayed.
- One of "Automatic cooling" and "Automatic heating" is displayed under the automatic mode is running. (Initial setting value)
- Only "Automatic" is displayed under the automatic mode.



# 12 MONITORING THE OPERATION DATA BY THE REMOTE CONTROLLER



## 12-1. HOW TO "MONITOR THE OPERATION DATA"

### 12-1-1. PAR-31MAA

Details on the operation data including each thermistor temperature and error history can be confirmed with the remote controller.

① Select "Service" from the Main menu, and press the  button.

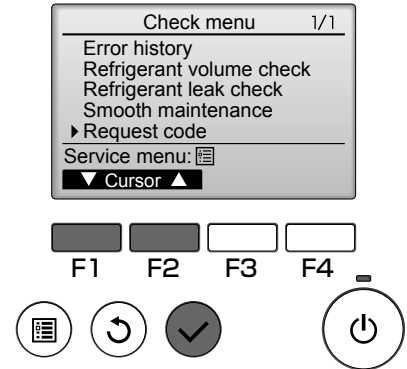

Select "Check" with the  or  button, and press the  button.

Select "Request code" with the  or  button, and press the  button.



② Set the Refrigerant address and Request code.

Select the item to be changed with the  or  button.

Select the required setting with the  or  button.

- <Ref.address>setting [ 0 ] – [ 15 ]
- <Request code>setting

Press the  button, Data will be collected and displayed.

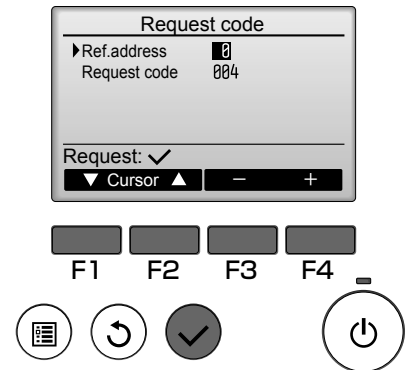

**Request code: 004**  
**Discharge temperature: 69°C**

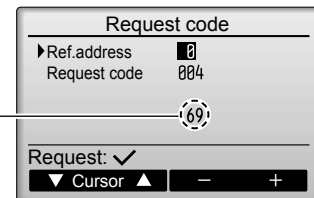

## 12-1-2. PAR-21MAA

- Turn on the [Monitoring the operation data]

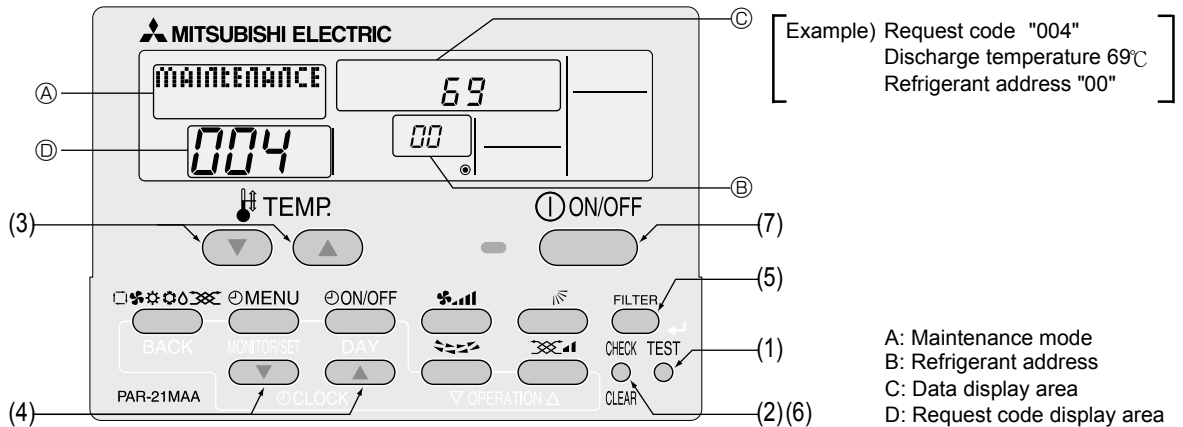

- (1) Press the **TEST** button for 3 seconds so that [ Maintenance mode] appears on the screen (at ①).
- (2) Press the **CHECK** button for 3 seconds to switch to [Maintenance monitor].  
Note) It is not possible to switch to [Maintenance monitor] during data request in maintenance mode (i.e., while " - - - " is blinking) since no buttons are operative.

- Operating the service inspection monitor

[ - - - ] appears on the screen (at ②) when [Maintenance monitor] is activated.

(The display (at ②) now allows you to set a request code No.)

- (3) Press the [TEMP] buttons (**▽** and **△**) to select the desired refrigerant address.

[Screen ②] → **00** ↔ **01** ↔ ..... ↔ **15** ←

- (4) Press the [CLOCK] buttons (**▽** and **△**) to set the desired request code No.
- (5) Press the **FILTER** button to perform data request.  
(The requested data will be displayed at ③ in the same way as in maintenance mode.)

Data collected during operation of the remote controller will be displayed.

The collected data such as temperature data will not be updated automatically even if the data changes.

To display the updated data, carry out step (4) again.

- Canceling the Monitoring the operation data

- (6) While [Maintenance monitor] is displayed, press the **CHECK** button for 3 seconds to return to maintenance mode.
- (7) To return to normal mode, press the **ON/OFF** button.

## 12-2. REQUEST CODE LIST

\* Certain indoor/outdoor combinations do not have the request code function; therefore, no request codes are displayed.

Request code	Request content	Description (Display range)	Unit	Remarks
0	Operation state	Refer to 12-2-1. Detail Contents in Request Code.	—	
1	Compressor-Operating current (rms)	0 – 50	A	
2	Compressor-Accumulated operating time	0 – 9999	10 hours	
3	Compressor-Number of operation times	0 – 9999	100 times	
4	Discharge temperature (TH4)	3 – 217	°C	
5	Outdoor unit - Liquid pipe 1 temperature (TH3)	-40 – 90	°C	
6	Outdoor unit - Liquid pipe 2 temperature	-40 – 90	°C	
7	Outdoor unit-2-phase pipe temperature (TH6)	-39 – 88	°C	
8				
9	Outdoor unit-Outside air temperature (TH7)	-39 – 88	°C	
10	Outdoor unit-Heatsink temperature (TH8)	-40 – 200	°C	
11				
12	Discharge superheat (SHd)	0 – 255	°C	
13	Sub-cool (SC)	0 – 130	°C	
14	Pressure saturation temperature (T <sub>63HS</sub> )	-39 – 88	°C	
15				
16	Compressor-Operating frequency	0 – 255	Hz	
17	Compressor-Target operating frequency	0 – 255	Hz	
18	Outdoor unit-Fan output step	0 – 10	Step	
19	Outdoor unit-Fan 1 speed (Only for air conditioners with DC fan motor)	0 – 9999	rpm	
20	Outdoor unit-Fan 2 speed (Only for air conditioners with DC fan motor)	0 – 9999	rpm	"0" is displayed if the air conditioner is a single-fan type.
21				
22	LEV (A) opening pulse	0 – 500	Pulses	
23	LEV (B) opening pulse	0 – 500	Pulses	
24	LEV (C) opening pulse	0 – 500	Pulses	
25	Primary current	0 – 50	A	
26	DC bus voltage	180 – 370	V	
27				
28				
29	Number of connected indoor units	0 – 4	Units	
30	Indoor unit-Setting temperature	17 – 30	°C	
31	Indoor unit-Intake air temperature <Measured by thermostat>	8 – 39	°C	
32	Indoor unit-Intake air temperature (Unit No. 1) <Heat mode-4-deg correction>	8 – 39	°C	"0" is displayed if the target unit is not present.
33	Indoor unit-Intake air temperature (Unit No. 2) <Heat mode-4-deg correction>	8 – 39	°C	↑
34	Indoor unit-Intake air temperature (Unit No. 3) <Heat mode-4-deg correction>	8 – 39	°C	↑
35	Indoor unit-Intake air temperature (Unit No. 4) <Heat mode-4-deg correction>	8 – 39	°C	↑
36				
37	Indoor unit - Liquid pipe temperature (Unit No. 1)	-39 – 88	°C	"0" is displayed if the target unit is not present.
38	Indoor unit - Liquid pipe temperature (Unit No. 2)	-39 – 88	°C	↑
39	Indoor unit - Liquid pipe temperature (Unit No. 3)	-39 – 88	°C	↑
40	Indoor unit - Liquid pipe temperature (Unit No. 4)	-39 – 88	°C	↑
41				
42	Indoor unit-Cond./Eva. pipe temperature (Unit No. 1)	-39 – 88	°C	"0" is displayed if the target unit is not present.
43	Indoor unit-Cond./Eva. pipe temperature (Unit No. 2)	-39 – 88	°C	↑
44	Indoor unit-Cond./Eva. pipe temperature (Unit No. 3)	-39 – 88	°C	↑
45	Indoor unit-Cond./Eva. pipe temperature (Unit No. 4)	-39 – 88	°C	↑
46				
47				
48	Thermo ON operating time	0 – 999	Minutes	
49	Test run elapsed time	0 – 120	Minutes	← Not possible to activate maintenance mode during the test run.



Request code	Request content	Description (Display range)	Unit	Remarks
50	Indoor unit-Control state	Refer to 12-2-1.Detail Contents in Request Code.	—	
51	Outdoor unit-Control state	Refer to 12-2-1.Detail Contents in Request Code.	—	
52	Compressor-Frequency control state	Refer to 12-2-1.Detail Contents in Request Code.	—	
53	Outdoor unit-Fan control state	Refer to 12-2-1.Detail Contents in Request Code.	—	
54	Actuator output state	Refer to 12-2-1.Detail Contents in Request Code.	—	
55	Error content (U9)	Refer to 12-2-1.Detail Contents in Request Code.	—	
56				
57				
58				
59				
60	Signal transmission demand capacity	0 – 255	%	
61	Contact demand capacity	Refer to 12-2-1.Detail Contents in Request Code.	—	
62	External input state (silent mode, etc.)	Refer to 12-2-1.Detail Contents in Request Code.	—	
63				
64				
65				
66				
67				
68				
69				
70	Outdoor unit-Capacity setting display	Refer to 12-2-1.Detail Contents in Request Code.	—	
71	Outdoor unit-Setting information	Refer to 12-2-1.Detail Contents in Request Code.	—	
72				
73	Outdoor unit-SW1 setting information	Refer to 12-2-1.Detail Contents in Request Code.	—	
74	Outdoor unit-SW2 setting information	Refer to 12-2-1.Detail Contents in Request Code.	—	
75				
76	Outdoor unit-SW4 setting information	Refer to 12-2-1.Detail Contents in Request Code.	—	
77	Outdoor unit-SW5 setting information	Refer to 12-2-1.Detail Contents in Request Code.	—	
78	Outdoor unit-SW6 setting information	Refer to 12-2-1.Detail Contents in Request Code.	—	
79	Outdoor unit-SW7 setting information	Refer to 12-2-1.Detail Contents in Request Code.	—	
80	Outdoor unit-SW8 setting information	Refer to 12-2-1.Detail Contents in Request Code.	—	
81	Outdoor unit-SW9 setting information	Refer to 12-2-1.Detail Contents in Request Code.	—	
82				
83				
84	M-NET adapter connection (presence/absence)	"0000": Not connected "0001": Connected	—	
85				
86				
87				
88				
89				
90	Outdoor unit-Microprocessor version information	Examples) Ver 5.01 → "0501"	Ver	
91	Outdoor unit-Microprocessor version information (sub No.)	Auxiliary information (displayed after version information) Examples) Ver 5.01 A000 → "A000"	—	
92				
93				
94				
95				
96				
97				
98				
99				
100	Outdoor unit - Error postponement history 1 (latest)	Displays postponement code. (" - - " is displayed if no postponement code is present)	Code	
101	Outdoor unit - Error postponement history 2 (previous)	Displays postponement code. (" - - " is displayed if no postponement code is present)	Code	
102	Outdoor unit - Error postponement history 3 (last but one)	Displays postponement code. (" - - " is displayed if no postponement code is present)	Code	



Request code	Request content	Description (Display range)	Unit	Remarks
103	Error history 1 (latest)	Displays error history. ("--" is displayed if no history is present.)	Code	
104	Error history 2 (second to last)	Displays error history. ("--" is displayed if no history is present.)	Code	
105	Error history 3 (third to last)	Displays error history. ("--" is displayed if no history is present.)	Code	
106	Abnormal thermistor display (TH3/TH6/TH7/TH8)	3 : TH3 6 : TH6 7 : TH7 8 : TH8 0 : No thermistor error	Sensor number	
107	Operation mode at time of error	Displayed in the same way as request code "0".	–	
108	Compressor-Operating current at time of error	0 – 50	A	
109	Compressor-Accumulated operating time at time of error	0 – 9999	10 hours	
110	Compressor-Number of operation times at time of error	0 – 9999	100 times	
111	Discharge temperature at time of error	3 – 217	°C	
112	Outdoor unit - Liquid pipe 1 temperature (TH3) at time of error	-40 – 90	°C	
113				
114	Outdoor unit-2-phase pipe temperature (TH6) at time of error	-39 – 88	°C	
115				
116	Outdoor unit-Outside air temperature (TH7) at time of error	-39 – 88	°C	
117	Outdoor unit-Heatsink temperature (TH8) at time of error	-40 – 200	°C	
118	Discharge superheat (SHd) at time of error	0 – 255	°C	
119	Sub-cool (SC) at time of error	0 – 130	°C	
120	Compressor-Operating frequency at time of error	0 – 255	Hz	
121	Outdoor unit at time of error • Fan output step	0 – 10	Step	
122	Outdoor unit at time of error • Fan 1 speed (Only for air conditioners with DC fan)	0 – 9999	rpm	
123	Outdoor unit at time of error • Fan 2 speed (Only for air conditioners with DC fan)	0 – 9999	rpm	"0" is displayed if the air conditioner is a single-fan type.
124				
125	LEV (A) opening pulse at time of error	0 – 500	Pulses	
126	LEV (B) opening pulse at time of error	0 – 500	Pulses	
127	LEV (C) opening pulse at time of error	0 – 500	Pulses	
128				
129	Pressure saturation temperature (T <sub>63HS</sub> ) at time of error	-39 – 88	°C	
130	Thermostat ON time until operation stops due to error	0 – 999	Minutes	
131				
132	Indoor - Liquid pipe temperature at time of error	-39 – 88	°C	Average value of all indoor units is displayed if the air conditioner consists of 2 or more indoor units (twin, triple, quad).
133	Indoor - Cond/Eva. pipe temperature at time of error	-39 – 88	°C	Average value of all indoor units is displayed if the air conditioner consists of 2 or more indoor units (twin, triple, quad).
134	Indoor at time of error • Intake air temperature <Thermostat judge temperature>	-39 – 88	°C	
135				
136				
137				
138				
139				
140				
~				
146				
147				
148				
149				
150	Indoor - Actual intake air temperature	-39 – 88	°C	
151	Indoor - Liquid pipe temperature	-39 – 88	°C	
152	Indoor - Cond/Eva. pipe temperature	-39 – 88	°C	





Request code	Request content	Description (Display range)	Unit	Remarks
153				
154	Indoor-Fan operating time (After filter is reset)	0 – 9999	1 hour	
155	Indoor-Total operating time (Fan motor ON time)	0 – 9999	10 hours	
156				
157	Indoor fan output value (Sj value)	0 – 255 Fan control data	–	For indoor fan phase control
158	Indoor fan output value (Pulsation ON/OFF)	"00 *** ****" indicates fan control data.	–	For indoor fan pulsation control
159	Indoor fan output value (duty value)	"00 *** ****" indicates fan control data.	–	For indoor DC brushless motor control
160				
161				
162	Indoor unit-Model setting information	Refer to 12-2-1. Detail Contents in Request Code.	–	
163	Indoor unit-Capacity setting information	Refer to 12-2-1. Detail Contents in Request Code.	–	
164	Indoor unit-SW3 information	Undefined	–	
165	Wireless pair No. (indoor control board side) setting	Refer to 12-2-1. Detail Contents in Request Code.	–	
166	Indoor unit-SW5 information	Undefined	–	
167				
~				
189				
190	Indoor unit-Microprocessor version information	Examples) Ver 5.01 → "0501"	Ver	
191	Indoor unit-Microprocessor version information (sub No.)	Auxiliary information (displayed after version information) Examples) Ver 5.01 A000 → "A000"	–	
192				
~				
764				
765	Stable operation (Heat mode)	This request code is not provided to collect data. It is used to fix the operation state.		
766	Stable operation (Cool mode)	This request code is not provided to collect data. It is used to fix the operation state.		
767	Stable operation cancellation	This request code is not provided to collect data. It is used to cancel the operation state that has been fixed by request codes "765" and "766".		

## 12-2-1. Detail Contents in Request Code

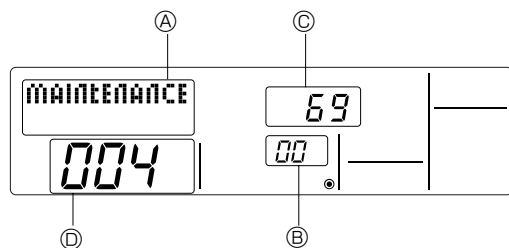

[ Example) Request code "004"  
Discharge temperature 69°C  
Refrigerant address "00" ]

A: Maintenance mode display  
B: Refrigerant address  
C: Data display area  
D: Request code display area

### [Operation state] (Request code : "0")

Data display

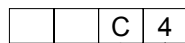

Relay output state

Operation mode

Operation mode

Display	Operation mode
0	STOP • FAN
C	COOL • DRY
H	HEAT
d	DEFROST

Relay output state

Display	Power currently supplied to compressor	Compressor	Four-way valve	Solenoid valve
0	—	—	—	—
1				ON
2			ON	
3			ON	ON
4		ON		
5		ON		ON
6		ON	ON	
7		ON	ON	ON
8	ON			
A	ON		ON	

### [Indoor unit – Control state] (Request code : "50")

Data display

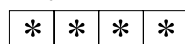

Unit No. 4 state

Unit No. 3 state

Unit No. 2 state

Unit No. 1 state

Display	State
0	Normal
1	Preparing for heat operation
2	—
3	—
4	Heater is ON.
5	Anti-freeze protection is ON.
6	Overheat protection is ON.
7	Requesting compressor to turn OFF
F	There are no corresponding units.

### [Outdoor unit – Control state] (Request code : "51")

Data display	State
0 0 0 0	Normal
0 0 0 1	Preparing for heat operation
0 0 0 2	Defrost

### [Compressor – Frequency control state] (Request code : "52")

Data display

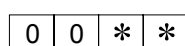

Frequency control state ②

Frequency control state ①

Frequency control state ①

Display	Current limit control
0	No current limit
1	Primary current limit control is ON.
2	Secondary current limit control is ON.

Frequency control state ②

Display	Discharge temperature overheat prevention	Condensation temperature overheat prevention	Anti-freeze protection control	Heatsink temperature overheat prevention
0				
1	Controlled			
2		Controlled		
3	Controlled	Controlled		
4			Controlled	
5	Controlled		Controlled	
6		Controlled	Controlled	
7	Controlled	Controlled	Controlled	
8				Controlled
9	Controlled			Controlled
A		Controlled		Controlled
b	Controlled	Controlled		Controlled
C			Controlled	Controlled
d	Controlled		Controlled	Controlled
E		Controlled	Controlled	Controlled
F	Controlled	Controlled	Controlled	Controlled

**[Fan control state] (Request code : "53")**

Data display 

0	0	*	*
---	---	---	---

Fan step correction value by heatsink temperature overhear prevention control

Fan step correction value by cool condensation temperature overhear prevention control

Display	Correction value
- (minus)	- 1
0	0
1	+1
2	+2

**[Actuator output state] (Request code : "54")**

Data display 

0	0	*	*
---	---	---	---

Actuator output state ①

Actuator output state ②

**Actuator output state ①**

Display	SV1	Four-way valve	Compressor	Compressor is warming up
0				
1	ON			
2		ON		
3	ON	ON		
4			ON	
5	ON		ON	
6		ON	ON	
7	ON	ON	ON	
8				ON
9	ON			ON
A		ON		ON
b	ON	ON		ON
C			ON	ON
d	ON		ON	ON
E		ON	ON	ON
F	ON	ON	ON	ON

**Actuator output state ②**

Display	52C	SV2	SS
0			
1	ON		
2		ON	
3	ON	ON	
4			ON
5	ON		ON
6		ON	ON
7	ON	ON	ON

**[Error content (U9)] (Request code : "55")**

Data display 

0	0	*	*
---	---	---	---

Error content ①

Error content ②

**Error content ①**

● : Detected

Display	Ovoltage error	Undervoltage error	L1-phase open error	Power synchronizing signal error
0				
1	●			
2		●		
3	●	●		
4			●	
5	●		●	
6		●	●	
7	●	●	●	
8				●
9	●			●
A		●		●
b	●	●		●
C			●	●
d	●		●	●
E		●	●	●
F	●	●	●	●

**Error content ②**

● : Detected

Display	Converter Fo error	PAM error
0		
1	●	
2		●
3	●	●

**[Contact demand capacity] (Request code : "61")**

Data display 

0	0	0	*
---	---	---	---

 Setting content

Setting content

Display	Setting value
0	0%
1	50%
2	75%
3	100%

**[External input state] (Request code : "62")**

Data display 

0	0	0	*
---	---	---	---

 Input state

Input state

● : Input present

Display	Contact demand input	Silent mode input	Spare 1 input	Spare 2 input
0				
1	●			
2		●		
3	●	●		
4			●	
5	●		●	
6		●	●	
7	●	●	●	
8				●
9	●			●
A		●		●
b	●	●		●
C			●	●
d	●		●	●
E		●	●	●
F	●	●	●	●

**[Outdoor unit – Capacity setting display] (Request code : "70")**

Data display	Capacity
9	35
10	50
11	60
14	71
20	100
25	125
28	140
40	200
50	250

**[Outdoor unit – Setting information] (Request code : "71")**

Data display 

0	0	*	*
---	---	---	---

 Setting information ①  
Setting information ②

Setting information ①

Display	Defrost mode
0	Standard
1	For high humidity

Setting information ②

Display	Single-/3-phase	Heat pump/cooling only
0	Single-phase	Heat pump
1		Cooling only
2	3-phase	Heat pump
3		Cooling only

**[Outdoor unit switch setting display (SW1 to SW10, except SW3)] Request codes: 73 to 82**

0: Switch OFF 1: Switch ON

SW1, SW2, SW6, SW7						Data display
1	2	3	4	5	6	
0	0	0	0	0	0	00 00
1	0	0	0	0	0	00 01
0	1	0	0	0	0	00 02
1	1	0	0	0	0	00 03
0	0	1	0	0	0	00 04
1	0	1	0	0	0	00 05
0	1	1	0	0	0	00 06
1	1	1	0	0	0	00 07
0	0	0	1	0	0	00 08
1	0	0	1	0	0	00 09
0	1	0	1	0	0	00 0A
1	1	0	1	0	0	00 0B
0	0	1	1	0	0	00 0C
1	0	1	1	0	0	00 0D
0	1	1	1	0	0	00 0E
1	1	1	1	0	0	00 0F
0	0	0	0	1	0	00 10
1	0	0	0	1	0	00 11
0	1	0	0	1	0	00 12
1	1	0	0	1	0	00 13
0	0	1	0	1	0	00 14
1	0	1	0	1	0	00 15
0	1	1	0	1	0	00 16
1	1	1	0	1	0	00 17
0	0	0	1	1	0	00 18
1	0	0	1	1	0	00 19
0	1	0	1	1	0	00 1A
1	1	0	1	1	0	00 1B
0	0	1	1	1	0	00 1C
1	0	1	1	1	0	00 1D
0	1	1	1	1	0	00 1E
1	1	1	1	1	0	00 1F
0	0	0	0	0	1	00 20
1	0	0	0	0	1	00 21
0	1	0	0	0	1	00 22
1	1	0	0	0	1	00 23
0	0	1	0	0	1	00 24
1	0	1	0	0	1	00 25
0	1	1	0	0	1	00 26
1	1	1	0	0	1	00 27
0	0	0	1	0	1	00 28
1	0	0	1	0	1	00 29
0	1	0	1	0	1	00 2A
1	1	0	1	0	1	00 2B
0	0	1	1	0	1	00 2C
1	0	1	1	0	1	00 2D
0	1	1	1	0	1	00 2E
1	1	1	1	0	1	00 2F
0	0	0	0	1	1	00 30
1	0	0	0	1	1	00 31
0	1	0	0	1	1	00 32
1	1	0	0	1	1	00 33
0	0	1	0	1	1	00 34
1	0	1	0	1	1	00 35
0	1	1	0	1	1	00 36
1	1	1	0	1	1	00 37
0	0	0	1	1	1	00 38
1	0	0	1	1	1	00 39
0	1	0	1	1	1	00 3A
1	1	0	1	1	1	00 3B
0	0	1	1	1	1	00 3C
1	0	1	1	1	1	00 3D
0	1	1	1	1	1	00 3E
1	1	1	1	1	1	00 3F

0: Switch OFF 1: Switch ON

SW5				Data display
1	2	3	4	
0	0	0	0	00 00
1	0	0	0	00 01
0	1	0	0	00 02
1	1	0	0	00 03
0	0	1	0	00 04
1	0	1	0	00 05
0	1	1	0	00 06
1	1	1	0	00 07
0	0	0	1	00 08
1	0	0	1	00 09
0	1	0	1	00 0A
1	1	0	1	00 0B
0	0	1	1	00 0C
1	0	1	1	00 0D
0	1	1	1	00 0E
1	1	1	1	00 0F

0: Switch OFF 1: Switch ON

SW8			Data display
1	2	3	
0	0	0	00 00
1	0	0	00 01
0	1	0	00 02
1	1	0	00 03
0	0	1	00 04
1	0	1	00 05
0	1	1	00 06
1	1	1	00 07

0: Switch OFF 1: Switch ON

SW4, SW9, SW10		Data display
1	2	
0	0	00 00
1	0	00 01
0	1	00 02
1	1	00 03

**[Indoor unit – Model setting information] (Request code : "162")**

Data display

0 0 \* \*

See the table on the right.

Display	Model setting state	Display	Model setting state
00	PSA-RP•GA, PSH-PGAH	20	
01		21	PKA-RP•FAL(2), PKH-P•FALH
02	PEAD-RP•EA(2)/GA, PEHD-P•EAH	22	PCA-RP•GA(2), PCH-P•GAH, PLA-RP•BA, PLA-RP71-100BA2
03	SEZ-KA•VA	23	
04		24	
05	SLZ-KA•VA(L)	25	
06	PCA-RP•HA	26	PCA-RP•KA
07		27	
08		28	
09	PEA-RP400/500GA	29	
0A		2A	
0b	PEA-RP200/250GA	2b	PKA-RP•GAL, PKH-P•GALH
0C		2C	
0d		2d	
0E		2E	
0F		2F	PLA-RP•AA
10		30	
11	PEA-RP•EA	31	PLH-P•AAH
12	MEXZ-GA•VA(L)	32	
13		33	PKA-RP•HAL/KAL
14		34	PEAD-RP•JA(L)
15		35	
16		36	PLA-RP•AA2
17		37	PLA-RP100BA3, 140BA2
18		38	
19		39	
1A		3A	
1b		3b	
1C		3C	
1d		3d	
1E		3E	
1F		3F	

**[Indoor unit – Capacity setting information] (Request code : "163")**

Data display

0 0 \* \*

See the table on the right.

Display	Capacity setting state	Display	Capacity setting state
00	12	10	112
01	16	11	125
02	22	12	140
03	25	13	160
04	28	14	200
05	32	15	224
06	35, 36	16	250
07	40	17	280
08	45	18	
09	50	19	
0A	56	1A	
0b	63	1b	
0C	71	1C	
0d	80	1d	
0E	90	1E	
0F	100	1F	

**[Wireless pair No. (indoor control board side) setting] (Request code : "165")**

Data display

0 0 \* \*

See the table on the right.

Display	Pair No. setting state
00	No. 0
01	No. 1 J41 disconnected
02	No. 2 J42 disconnected
03	No. 3 J41, J42 disconnected

13-1. SMOOTH MAINTENANCE

13-1-1. PAR-31MAA

Maintenance data, such as the indoor/outdoor unit's heat exchanger temperature and compressor operation current can be displayed with "Smooth maintenance".

\* This cannot be executed during test operation.

\* Depending on the combination with the outdoor unit, this may not be supported by some models.

Select "Service" from the Main menu, and press the  button.



Select "Check" with the **F1** or **F2** button, and press the  button.



Select "Smooth maintenance" with the **F1** or **F2** button, and press the  button.

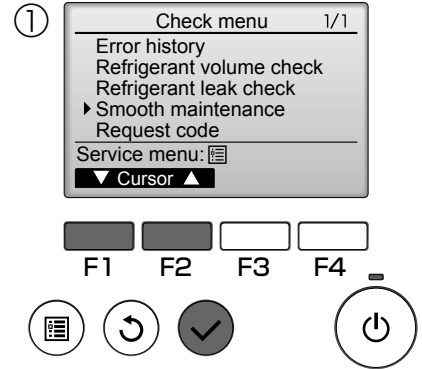

Set each item.

Select the item to be changed with the **F1** or **F2** button.

Select the required setting with the **F3** or **F4** button.

- <Ref.address>setting [ 0 ]~[ 15 ]
- <Stable mode>setting [ Cool ] / [ Heat ] / [ Normal ]

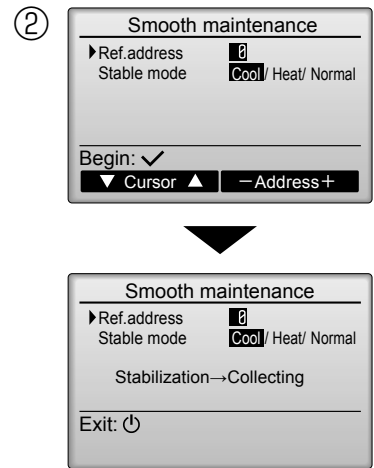

Press the  button, Fixed operation will start.



\* Stable mode will take approx. 20 minutes.

The operation data will appear.

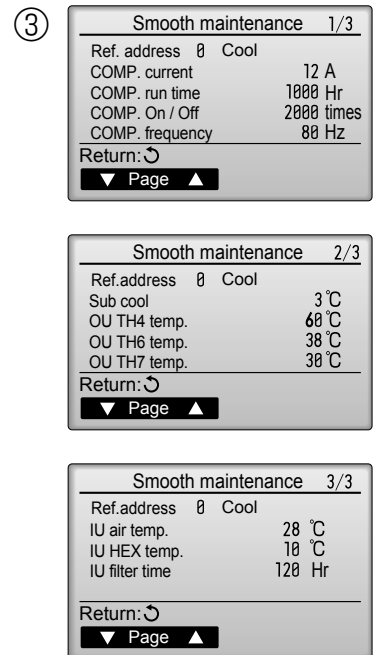
The Compressor-Accumulated operating (COMP. run) time is 10-hour unit, and the Compressor-Number of operation times (COMP. On / Off) is a 100-time unit (fractions discarded).



**Navigating through the screens**

- To go back to the Main menu .....  button
- To return to the previous screen .....  button

- Reduces maintenance work drastically.
  - Enables you to check operation data of the indoor and outdoor units by remote controller.
- Furthermore, use of maintenance stable-operation control that fixes the operating frequency, allows smooth inspection, even for inverter models.

Smooth Maintenance Function

**Discharge temperature 64°C**

• Conventional inspection work

Easy maintenance information (unit)

Compressor		Outdoor unit		Indoor unit	
①	Accumulated operating time (×10 hours)	④	Heat exchanger temperature (°C)	⑦	Intake air temperature (°C)
②	Number of ON/OFF times (×10 times)	⑤	Discharge temperature (°C)	⑧	Heat exchanger temperature (°C)
③	Operating current (A)	⑥	Outside air temperature (°C)	⑨	Filter operating time* (Hours)

\* The filter operating time is the time that has elapsed since the filter was reset.

## 13-2. MAINTENANCE MODE OPERATION METHOD

\* If you are going to use 13-3. "GUIDE FOR OPERATION CONDITION", set the airflow to "High" before activating maintenance mode.

### • Switching to maintenance mode

Maintenance mode can be activated either when the air conditioner is operated or stopped. It cannot be activated during test run.

\* Maintenance information can be viewed even if the air conditioner is stopped.

#### ■ Remote controller button information

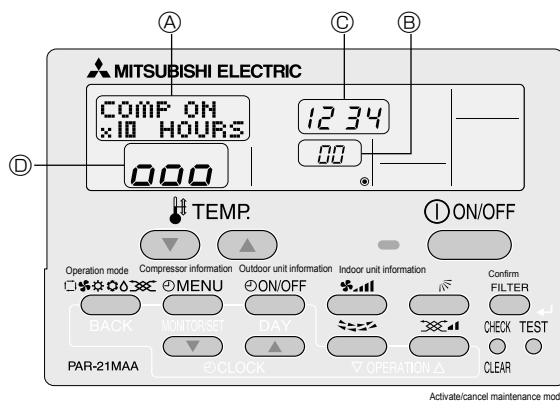

(1) Press the **TEST** button for 3 seconds to switch to maintenance mode.

[Display ①] MAINTENANCE

If stable operation is unnecessary or if you want to check the data with the air conditioner stopped, skip to step (4).

### • Fixed Hz operation

The operating frequency can be fixed to stabilize operation of inverter model. If the air conditioner is currently stopped, start it by this operation.

(2) Press the **MODE** button to select the desired operation mode.

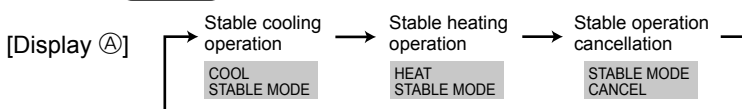

(3) Press the **FILTER** button to confirm the setting.

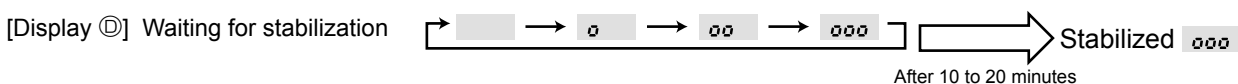



● **Data measurement**

When the operation is stabilized, measure operation data as explained below.

➤(4) Press the [TEMP] buttons ( and ) to select the desired refrigerant address.



➤(5) Select the type of data to be displayed.

After selecting, go to step (6).

**Compressor information**

MENU button

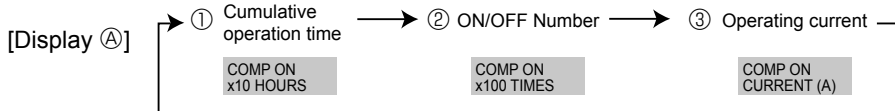

**Outdoor unit information**

ON/OFF button

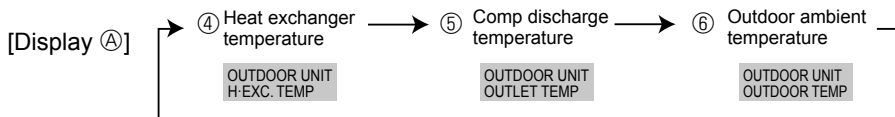

**Indoor unit information**

button

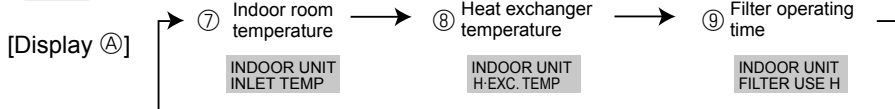

(6) Press the **[FILTER]** () button to confirm the setting.

[Display example for accumulated operating time]

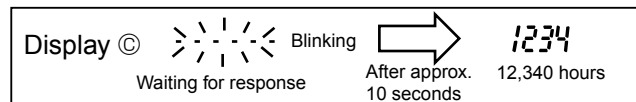

(7) Data is displayed on the display (at ⑤).

**To check the data for each item, repeat steps (5) to (7).**

(8) To cancel maintenance mode, press the **[TEST]** button for 3 seconds or press the **[ON/OFF]** button.

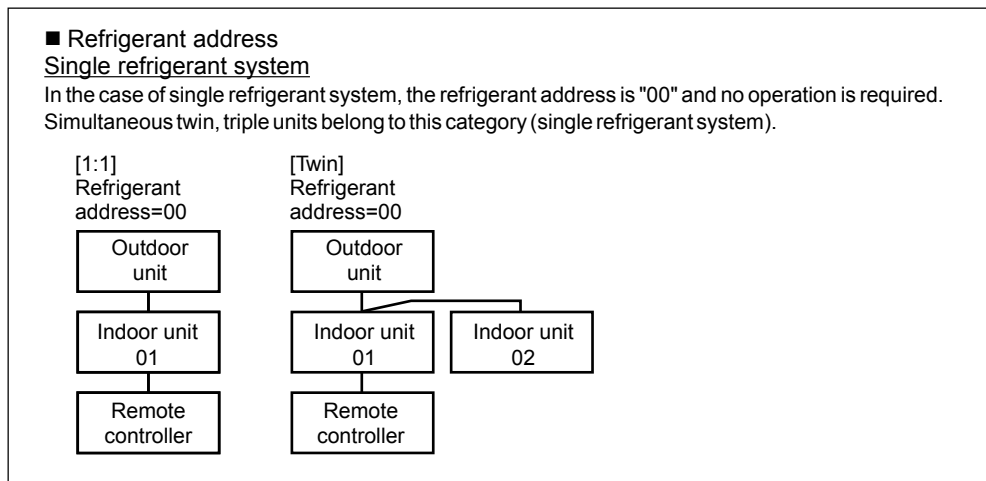

### 13-3. GUIDE FOR OPERATION CONDITION

Inspection item		Result			
Power supply	Loose connection	Breaker	Good	Retightened	
		Outdoor Unit	Good	Retightened	
		Indoor Unit	Good	Retightened	
Power supply	Terminal block	(Insulation resistance)		MΩ	
		(Voltage)		V	
Compressor	① Accumulated operating time			Time	
	② Number of ON/OFF times			Times	
	③ Current			A	
Outdoor Unit	Temperature	④ Refrigerant/heat exchanger temperature	COOL °C	HEAT °C	
		⑤ Refrigerant/discharge temperature	COOL °C	HEAT °C	
		⑥ Air/outside air temperature	COOL °C	HEAT °C	
		(Air/discharge temperature)	COOL °C	HEAT °C	
	Cleanliness	Appearance	Good	Cleaning required	
Indoor Unit	Temperature	⑦ Air/intake air temperature	COOL °C	HEAT °C	
		(Air/discharge temperature)	COOL °C	HEAT °C	
		⑧ Refrigerant/heat exchanger temperature	COOL °C	HEAT °C	
	Cleanliness	⑨ Filter operating time*			Time
		Decorative panel	Good	Cleaning required	
Filter		Good	Cleaning required		
Fan		Good	Cleaning required		
Indoor Unit	Cleanliness	Heat exchanger	Good	Cleaning required	
		Sound/vibration	None	Present	

\* The filter operating time is the time that has elapsed since the filter was reset.

### Check Points

Enter the temperature differences between ⑤, ④, ⑦ and ⑧ into the graph given below.

Operation state is determined according to the plotted areas on the graph.

For data measurements, set the fan speed to "Hi" before activating maintenance mode.

Classification	Item	Result	
Cool	Inspection	Is "D000" displayed stably on the remote controller?	
	Temperature difference	(⑤ Discharge temperature) – (④ Outdoor heat exchanger temperature) (⑦ Indoor intake air temperature) – (⑧ Indoor heat exchanger temperature)	
Heat	Inspection	Is "D000" displayed stably on the remote controller?	
	Temperature difference	(⑤ Discharge temperature) – (⑧ Indoor heat exchanger temperature) (⑧ Indoor heat exchanger temperature) – (⑦ Indoor intake air temperature)	

\* Fixed Hz operation may not be possible under the following temperature ranges.

A) In cool mode, outdoor intake air temperature is 40 °C or higher or indoor intake air temperature is 23 °C or lower.

B) In heat mode, outdoor intake air temperature is 20 °C or higher or indoor intake air temperature is 25 °C or lower.

\* If the air conditioner is operated at a temperature range other than the ones above but operation is not stabilized after 30 minutes or more have elapsed, carry out inspection.

\* In heat mode, the operation state may vary due to frost forming on the outdoor heat exchanger.

Area	Check item	Judgment	
		Cool	Heat
Normal	Normal operation state		
Filter inspection	Filter may be clogged. *1		
Inspection A	Performance has dropped. Detailed inspection is necessary.		
Inspection B	Refrigerant amount is dropping.		
Inspection C	Filter or indoor heat exchanger may be clogged.		

\* The above judgement is just guide based on Japanese standard conditions.

It may be changed depending on the indoor and outdoor temperature.

\*1 It may be judged as "Filter inspection" due to the outdoor and indoor temperature, even though it is not clogged.

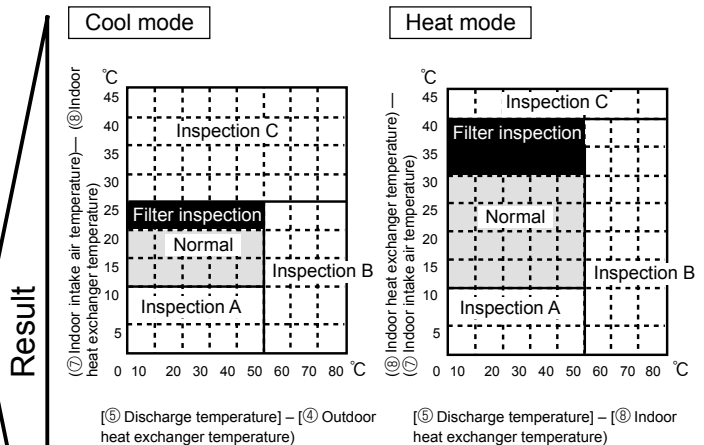

## PUHZ-FRP71VHA

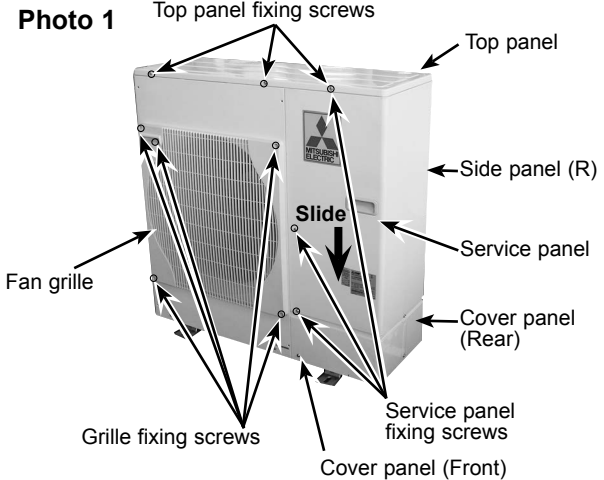
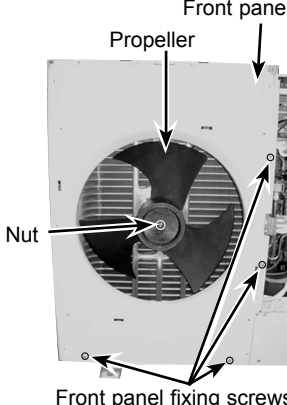
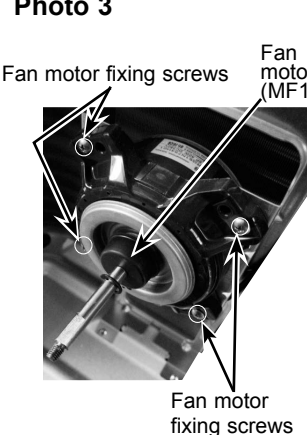
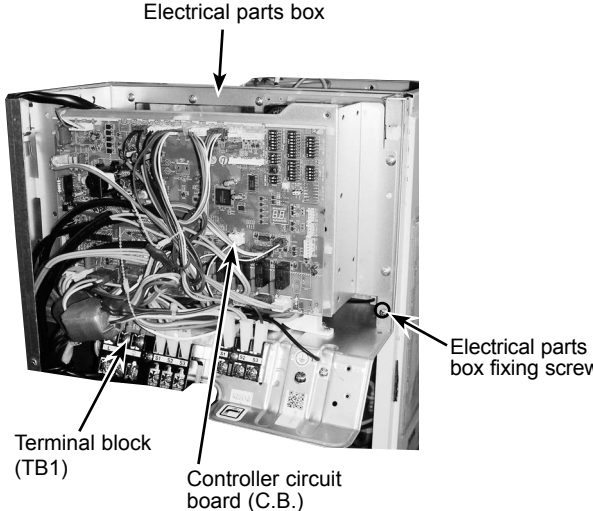
OPERATING PROCEDURE	PHOTOS & ILLUSTRATION
<p><b>1. Removing the service panel and top panel</b></p> <p>(1) Remove the service panel fixing screws (3 for front, 5 × 12) and slide the hook on the right downward to remove the service panel.</p> <p>(2) Remove the top panel fixing screws (3 for front, 3 for rear, 5 × 12) to detach the top panel.</p>	<p><b>Photo 1</b></p> 
<p><b>2. Removing the fan motor (MF1)</b></p> <p>(1) Remove the service panel. (See Photo 1)</p> <p>(2) Remove the top panel. (See Photo 1)</p> <p>(3) Remove the fan grille fixing screws (5 for front, 5 × 12) to detach the fan grille. (See Photo 1)</p> <p>(4) Remove a nut (for right handed screw of M6) to detach the propeller. (See Photo 2)</p> <p>(5) Disconnect the connector CNF1 on controller circuit board in electrical parts box.</p> <p>(6) Disconnect the lead wire from 2 clamps on the separator and electrical parts box (on the ceiling, front side).</p> <p>(7) Remove the fan motor fixing screws (4 for front, 5 × 25) to detach the fan motor. (See Photo 3)</p>	<p><b>Photo 2</b></p>  <p><b>Photo 3</b></p> 
<p><b>3. Removing the electrical parts box</b></p> <p>(1) Remove the service panel. (See Photo 1)</p> <p>(2) Remove the top panel. (See Photo 1)</p> <p>(3) Disconnect the indoor/outdoor connecting wire and power supply wire from the terminal block.</p> <p>(4) Disconnect the connector CNF1, LEV-A and LEV-B on the controller circuit board.</p> <p>&lt;Symbols on the board&gt;</p> <ul style="list-style-type: none"> <li>• CNF1: Fan motor</li> <li>• LEV-A, LEV-B: LEV</li> </ul> <p>(5) Disconnect the pipe-side connections of the following parts.</p> <ul style="list-style-type: none"> <li>• Thermistor &lt;Outdoor pipe&gt; (TH3)</li> <li>• Thermistor &lt;Discharge&gt; (TH4)</li> <li>• Thermistor &lt;Outdoor 2-phase pipe&gt; (TH6)</li> <li>• Thermistor &lt;Outdoor&gt; (TH7)</li> <li>• Thermistor &lt;Comp. surface&gt; (TH34)</li> <li>• Thermistor &lt;Heatsink&gt; (CN3)</li> <li>• High pressure switch (63H)</li> <li>• High pressure sensor (63HS)</li> <li>• Bypass valve coil (SV2)</li> <li>• 4-way valve coil (21S4)</li> </ul> <p>(6) Disconnect the lead wires from 2 clamps on the separator.</p> <p>(7) Remove the terminal cover and disconnect the compressor lead wire.</p> <p>(8) Remove the electrical parts box fixing screw (1 for front, 4 × 10) and detach the electrical parts box by pulling it upward.</p> <p>The electrical parts box is fixed with 2 hooks on the left and 1 hook on the right.</p>	<p><b>Photo 4</b></p> 

## OPERATING PROCEDURE

### 4. Removing the thermistor <Outdoor 2-phase pipe> (TH6)

- (1) Remove the service panel. (See Photo 1)
- (2) Remove the top panel. (See Photo 1)
- (3) Disconnect the connector TH7/6 (red) on the controller circuit board in the electrical parts box.
- (4) Disconnect the lead wires from the wire clip on the outdoor controller board in the electrical parts box.
- (5) Loosen the clamp for the lead wire in the rear of the electrical parts box.
- (6) Pull out the thermistor <Outdoor 2-phase pipe> (TH6) from the sensor holder.

**Note: When replacing thermistor <Outdoor 2-phase pipe> (TH6), replace it together with thermistor <Outdoor> (TH7), since they are combined together. Refer to procedure No.5 below to remove thermistor <Outdoor>.**

### 5. Removing the thermistor <Outdoor> (TH7)

- (1) Remove the service panel. (See Photo 1)
- (2) Remove the top panel. (See Photo 1)
- (3) Disconnect the connector TH7/6 (red) on the controller circuit board in the electrical parts box.
- (4) Disconnect the lead wires from the wire clip on the outdoor controller board in the electrical parts box.
- (5) Loosen the clamp for the lead wire in the rear of the electrical parts box. (See Photo 5)
- (6) Pull out the thermistor <Outdoor> (TH7) from the sensor holder.

**Note: When replacing thermistor <Outdoor> (TH7), replace it together with thermistor <Outdoor 2-phase pipe> (TH6), since they are combined together. Refer to procedure No.4 above to remove thermistor <Outdoor 2-phase pipe>.**

### 6. Removing the thermistor <Outdoor pipe> (TH3), thermistor <Discharge> (TH4) and thermistor <Comp. surface> (TH34)

- (1) Remove the service panel. (See Photo 1)
- (2) Disconnect the connectors, TH3 (white) and TH4 (white), TH34 (black) on the controller circuit board in the electrical parts box.
- (3) Disconnect the lead wires from the wire clip on the outdoor controller board in the electrical parts box.
- (4) Loosen the clamp for the lead wire in the rear of the electrical parts box. (See Photo 5)
- (5) Pull out the thermistor <Outdoor pipe> (TH3) and thermistor <Discharge> (TH4) from the sensor holder.

- [Removing the thermistor<Comp. surface> (TH34)]
- (6) Remove the compressor cover (upper) and pull out the thermistor <Comp. surface> (TH34) from the holder of the compressor surface. (TH3, TH34 : See Figure 1)

## PHOTOS

Photo 5

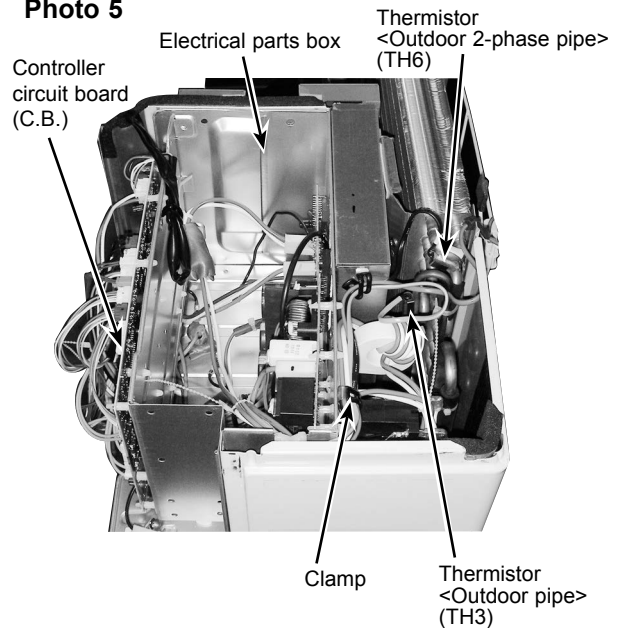

Photo 6

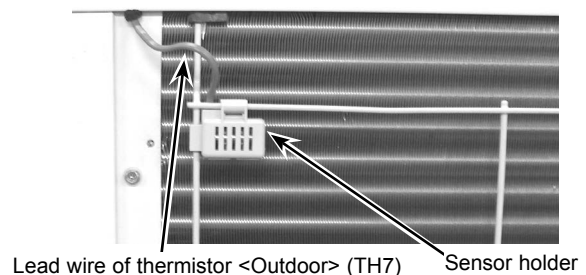
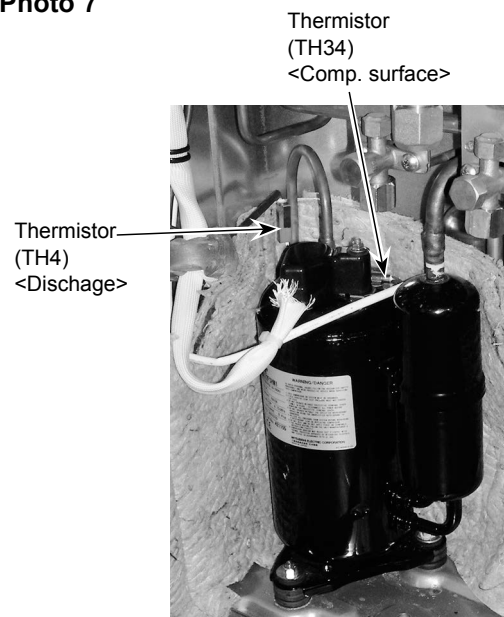

Photo 7



## OPERATING PROCEDURE

### 7. Removing the 4-way valve coil (21S4), LEV coil (LEV(A), LEV(B), LEV(C)) and solenoid valve coil (SV1, SV2, SV3)

- (1) Remove the service panel. (See Photo 1)
- (2) Remove the top panel. (See Photo 1)
- (3) Remove the electrical parts box. (See Photo 5)
- [Removing the 4-way valve coil]**
- (4) Remove 4-way valve coil fixing screw (M4 × 6).
- (5) Remove the 4-way valve coil by sliding the coil toward you.

#### **[Removing the LEV coil]**

- (4) Remove the LEV coil by sliding the coil upward.

#### **[Removing the solenoid valve coil]**

- (4) Remove the solenoid valve coil fixing screw.
- (5) Remove the solenoid valve coil by sliding the coil upward.

### 8. Removing the 4-way valve

- (1) Remove the service panel. (See Photo 1)
- (2) Remove the top panel. (See Photo 1)
- (3) Remove the electrical parts box. (See Photo 4)
- (4) Remove the valve bed. (See Photo 12)
- (5) Remove the side panel (R) fixing screws (3 for front, 5 × 12) in the rear of the unit and then remove the side panel (R).
- (6) Remove the 4-way valve coil. (See Photo 8)
- (7) Recover refrigerant.
- (8) Remove the welded part of 4-way valve.

**Note 1: Recover refrigerant without spreading it in the air.**

**Note 2: The welded part can be removed easily by removing the side panel (R).**

**Note 3: When installing the 4-way valve, cover it with a wet cloth to prevent it from heating (120°C or more), then braze the pipes so that the inside of pipes are not oxidized.**

### 9. Removing the LEV

- (1) Remove the service panel. (See Photo 1)
- (2) Remove the top panel. (See Photo 1)
- (3) Remove the electrical parts box. (See Photo 4)
- (4) Remove the valve bed. (See Photo 12)
- (5) Remove the side panel (R).
- (6) Remove the LEV coil.
- (7) Recover refrigerant.
- (8) Remove the welded part of LEV.

**Note 1: Recover refrigerant without spreading it in the air.**

**Note 2: The welded part can be removed easily by removing the side panel (R).**

**Note 3: When installing the LEV, cover it with a wet cloth to prevent it from heating (120°C or more), then braze the pipes so that the inside of pipes are not oxidized.**

### 10. Removing the SV

- (1) Remove the service panel. (See Photo 1)
- (2) Remove the top panel. (See Photo 1)
- (3) Remove the electrical parts box. (See Photo 4)
- (4) Remove the valve bed. (See Photo 12)
- (5) Remove the side panel (R).
- (6) Remove the SV coil.
- (7) Recover refrigerant.
- (8) Remove the welded part of SV.

**Note 1: Recover refrigerant without spreading it in the air.**

**Note 2: The welded part can be removed easily by removing the side panel (R).**

**Note 3: When installing the SV, cover it with a wet cloth to prevent it from heating (120°C or more), then braze the pipes so that the inside of pipes are not oxidized.**

## PHOTOS

Photo 8

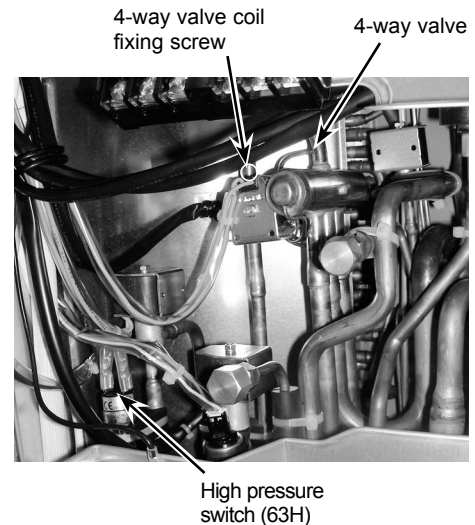

Photo 9

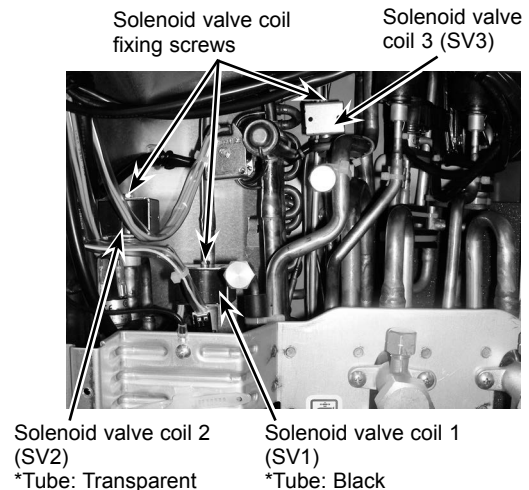
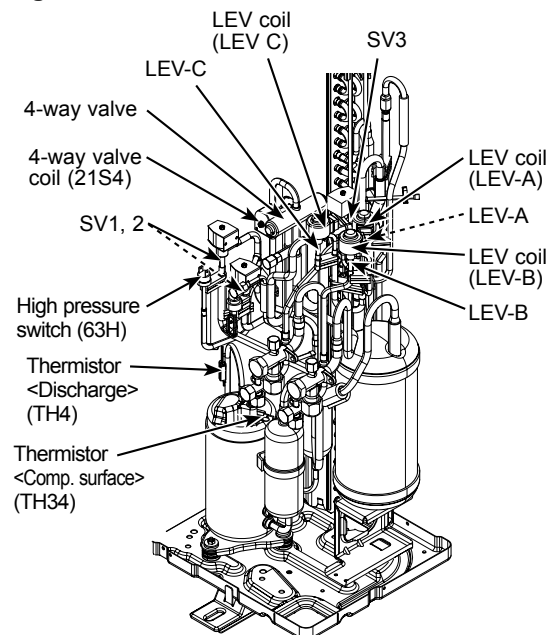

Figure 1



## OPERATING PROCEDURE

### 11. Removing the high pressure switch (63H)

- (1) Remove the service panel. (See Photo 1)
- (2) Remove the top panel. (See Photo 1)
- (3) Remove the electrical parts box. (See Photo 4)
- (4) Remove the side panel (R) fixing screws (3 for rear, 5 × 12) in the rear of the unit and remove the side panel (R).
- (5) Pull out the lead wire of high pressure switch.
- (6) Recover refrigerant.
- (7) Remove the welded part of high pressure switch.

**Note 1:** Recover refrigerant without spreading it in the air.

**Note 2:** The welded part can be removed easily by removing the side panel (R).

**Note 3:** When installing the high pressure switch, cover it with a wet cloth to prevent it from heating (100°C or more), then braze the pipes so that the inside of pipes are not oxidized.

### 12. Removing the high pressure sensor (63HS)

- (1) Remove the service panel. (See Photo 1)
- (2) Remove the top panel. (See Photo 1)
- (3) Remove the electrical parts box. (See Photo 4)
- (4) Remove the side panel (R) fixing screws (3 for rear, 5 × 12) in the rear of the unit and remove the side panel (R).
- (5) Pull out the lead wire of high pressure sensor.
- (6) Recover refrigerant.
- (7) Remove the welded part of high pressure sensor.

**Note 1:** Recover refrigerant without spreading it in the air.

**Note 2:** The welded part can be removed easily by removing the side panel (R).

**Note 3:** When installing the high pressure switch, cover it with a wet cloth to prevent it from heating (100°C or more), then braze the pipes so that the inside of pipes are not oxidized.

### 13. Removing the reactor (ACL)

- (1) Remove the service panel. (See Photo 1)
- (2) Remove the top panel. (See Photo 1)
- (3) Remove the electrical parts box. (See Photo 4)
- (4) Remove the reactor fixing screws (3 places, 4 × 16) and remove the reactor.

\* The reactor is attached to the rear of the electrical parts box.

## PHOTOS

Photo 10

Lead wire of high pressure switch      Lead wire of high pressure sensor

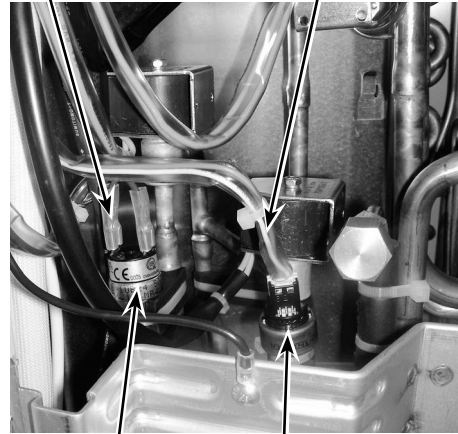

High pressure switch (63H)

High pressure sensor (63HS)

Photo 11

Reactor fixing screw

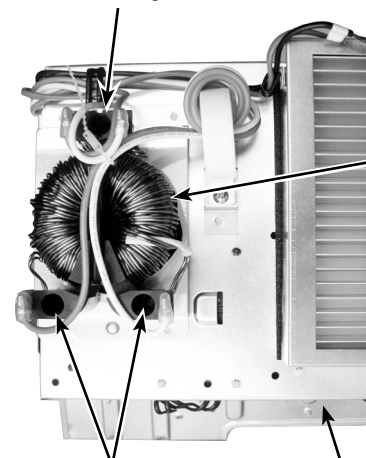

Reactor (ACL)

Reactor fixing screws

Electrical parts box

## OPERATING PROCEDURE

### 14. Removing the compressor (MC)

- (1) Remove the service panel. (See Photo 1)
- (2) Remove the top panel. (See Photo 1)
- (3) Remove the cover panel (front) fixing screws (2 for front, 5 × 12) and remove the cover panel (front). (See Photo 13)
- (4) Remove the cover panel (rear) fixing screws (2 for rear, 5 × 12) and remove the cover panel (rear). (See Photo 13)
- (5) Remove the electrical parts box. (See Photo 4)
- (6) Remove the valve bed fixing screws (3 for front, 4 × 10) and the ball valve and stop valve fixing screws (4 for front, 5 × 16) and then remove the valve bed.
- (7) Remove the side panel (R). (See Photo 1)
- (8) Remove the separator fixing screws (3 for front, 4 × 10) and remove the separator.
- (9) Recover refrigerant.
- (10) Remove the 3 points of the compressor fixing nut using a spanner or a adjustable wrench.
- (11) Remove the welded pipe of compressor inlet and outlet then remove the compressor.

**Note: Recover refrigerant without spreading it in the air.**

## PHOTOS

**Photo 12**

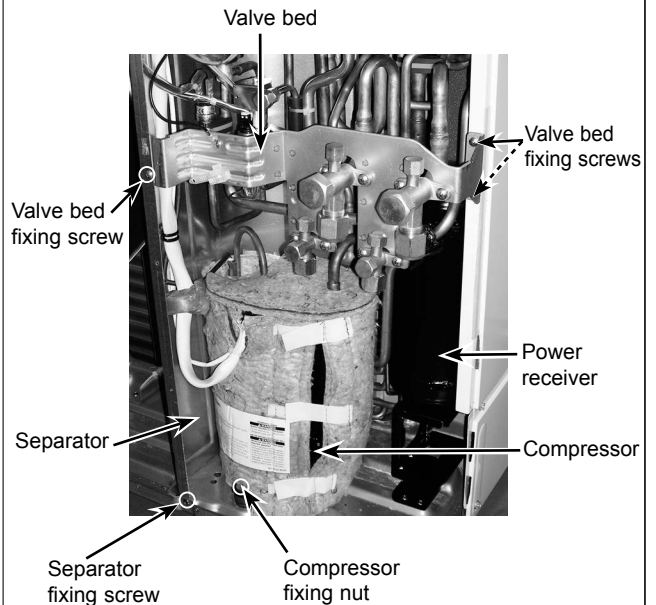

**Photo 13**

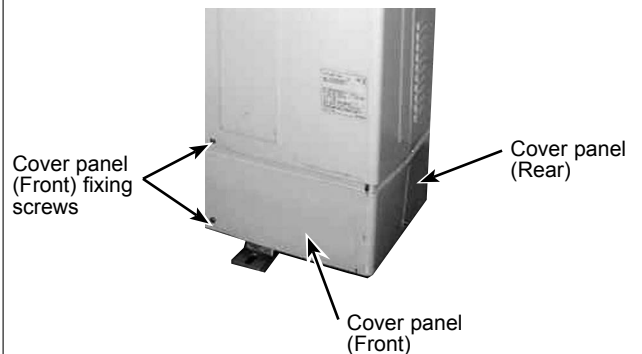

### 15. Removing the accumulator

- (1) Remove the service panel. (See Photo 1)
- (2) Remove the top panel. (See Photo 1)
- (3) Remove the cover panel (front). (See Photo 13)
- (4) Remove the cover panel (rear). (See Photo 13)
- (5) Remove the electrical parts box. (See Photo 4)
- (6) Remove the valve bed. (See Photo 12)
- (7) Remove the side panel (R). (See Photo 1)
- (8) Recover refrigerant.
- (9) Remove 4 welded pipes of accumulator inlet and outlet.
- (10) Remove the receiver leg fixing screws (2 for front, 4 × 10).

**Note: Recover refrigerant without spreading it in the air.**

**Photo 14**

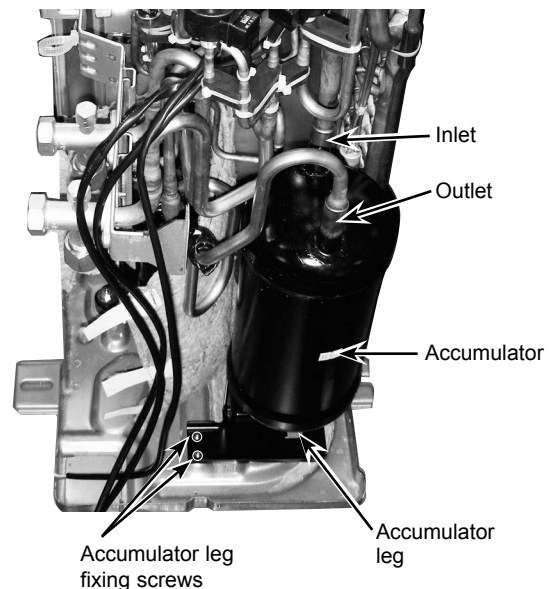

# **mitsubishi electric corporation**

HEAD OFFICE : TOKYO BLDG., 2-7-3, MARUNOUCHI, CHIYODA-KU, TOKYO 100-8310, JAPAN

---