



# CITY MULTI

## Air-Conditioners For Building Application INDOOR UNIT

# PKFY-P-VLM Series

OPERATION MANUAL

FOR USER

English

1. Safety Precautions .....	1	5. Emergency Operation for Wireless Remote-controller .....	10
2. Parts Names .....	2	6. Care and Cleaning .....	11
3. Operation .....	7	7. Troubleshooting .....	13
4. Timer .....	10	8. Specifications .....	15

**To dispose of this product, consult your dealer.**

Your MITSUBISHI ELECTRIC product is designed and manufactured with high quality materials and components which can be recycled and/or reused. This symbol means that electrical and electronic equipment, batteries and accumulators, at their end-of-life, should be disposed of separately from your household waste. If a chemical symbol is printed beneath the symbol (Fig. 1), this chemical symbol means that the battery or accumulator contains a heavy metal at a certain concentration.

This will be indicated as follows: Hg: mercury (0.0005%), Cd: cadmium (0.002%), Pb: lead (0.004%)  
Please, help us to conserve the environment we live in!

Compliance with the "India e-waste (Management) Rules, 2016"

This product complies with the "India e-waste (Management) Rules, 2016" and prohibits use of lead, mercury, hexavalent chromium, polybrominated biphenyls or polybrominated diphenyl ethers in concentrations exceeding 0.1% by weight and 0.01% by weight for cadmium, except for the exemption set in Schedule II of the Rule.

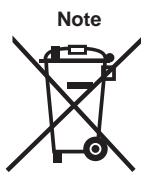

Note

Fig.1

**Note:**

The phrase "Wired remote controller" in this operation manual refers to the PAR-40MAA.

If you need any information for the other remote controller, please refer to the instruction book included in this box.

en

## 1. Safety Precautions

- ▶ Before installing the unit, make sure you read all the "Safety Precautions".
- ▶ The "Safety Precautions" provide very important points regarding safety. Make sure you follow them.
- ▶ Please report to or take consent by the supply authority before connection to the system.

### Symbols used in the text

**⚠ Warning:**

Describes precautions that should be observed to prevent danger of injury or death to the user.

**⚠ Caution:**

Describes precautions that should be observed to prevent damage to the unit.

### Symbols used in the illustrations

⚡: Indicates a part which must be grounded.

**⚠ Warning:**

- These appliances are not accessible to the general public.
- The unit must not be installed by the user. Ask the dealer or an authorized company to install the unit. If the unit is installed improperly, water leakage, electric shock or fire may result.
- Do not alter the unit. It may cause fire, electric shock, injury or water leakage.
- Do not stand on, or place any items on the unit.
- Do not splash water over the unit and do not touch the unit with wet hands. An electric shock may result.
- Do not spray combustible gas close to the unit. Fire may result.
- Do not place a gas heater or any other open-flame appliance where it will be exposed to the air discharged from the unit. Incomplete combustion may result.
- Do not remove the front panel or the fan guard from the outdoor unit when it is running.
- Never repair the unit or transfer it to another site by yourself.
- When you notice exceptionally abnormal noise or vibration, stop operation, turn off the power switch, and contact your dealer.
- Never insert fingers, sticks etc. into the air inlets or outlets.
- If you detect odd smells, stop using the unit, turn off the power switch and consult your dealer. Otherwise, a breakdown, electric shock or fire may result.
- This air conditioner is NOT intended for use by children or infirm persons without supervision.
- If the refrigeration gas blows out or leaks, stop the operation of the air conditioner, thoroughly ventilate the room, and contact your dealer.

- This appliance is intended to be used by expert or trained users in shops, in light industry and on farms, or for commercial use by lay persons.
- Children should be supervised to ensure that they do not play with the air conditioner.
- This appliance is not intended for use by persons (including children) with reduced physical, sensory or mental capabilities, or lack of experience and knowledge, unless they have been given supervision or instruction concerning use of the appliance by a person responsible for their safety.
- This appliance can be used by children aged from 8 years and above and persons with reduced physical, sensory or mental capabilities or lack of experience and knowledge if they have been given supervision or instruction concerning use of the appliance in a safe way and understand the hazards involved. Children shall not play with the appliance. Cleaning and user maintenance shall not be made by children without supervision.
- When installing or relocating, or servicing the air conditioner, use only the specified refrigerant (R410A) to charge the refrigerant lines. Do not mix it with any other refrigerant and do not allow air to remain in the lines.  
If air is mixed with the refrigerant, then it can be the cause of abnormal high pressure in the refrigerant line, and may result in an explosion and other hazards. The use of any refrigerant other than that specified for the system will cause mechanical failure or system malfunction or unit breakdown. In the worst case, this could lead to a serious impediment to securing product safety.

**⚠ Caution:**

- Do not use any sharp object to push the buttons, as this may damage the remote controller.
- Never block or cover the indoor or outdoor unit's air inlets or outlets.
- Never wipe the remote controller with benzene, thinner chemical rags, etc.

- Do not operate the unit for a long time in high humidity, e.g. leaving a door or window open. In the cool mode, if the unit is operated in a room with high humidity (80% RH or more) for a long time, water condensed in the air conditioner may drop and wet or damage furniture, etc.
- Do not touch the upper air outlet vane or the lower air outlet damper during operation. Otherwise, condensation may form and the unit may stop operating.

### Disposing of the unit

When you need to dispose of the unit, consult your dealer.

## 2. Parts Names

### ■ Indoor Unit

		PKFY-P-VLM
Fan speed		4 speed + Auto
Vane	Steps	5 steps
	Auto swing	○
Louver		Manual
Filter		Normal
Filter cleaning indication		100 hr
Enter the model setting number for the indoor unit you want to operate.*		065 (001)

\* For systems that are capable of simultaneous cooling and heating operation, use the setting indicated in parentheses ( ). For details on the setting procedure, refer to the Installation Manual.

### ■ PKFY-P-VLM

Wall Mounted

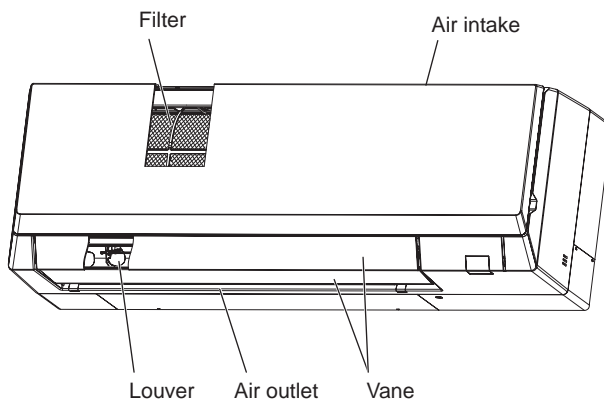

## 2. Parts Names

### ■ Wired Remote Controller

#### Controller interface

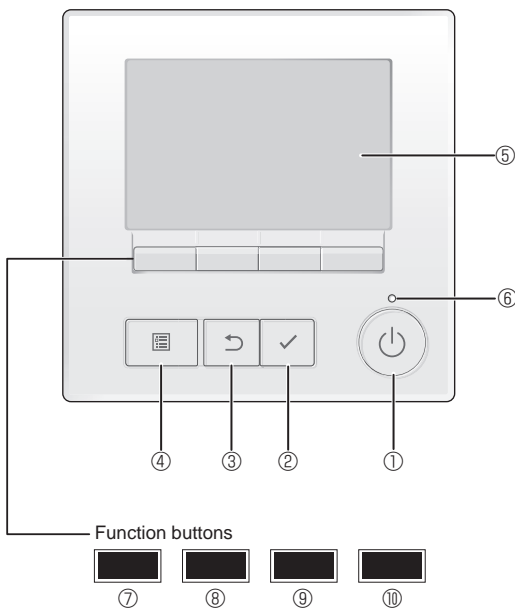

The functions of the function buttons change depending on the screen.

Refer to the button function guide that appears at the bottom of the LCD for the functions they serve on a given screen.

When the system is centrally controlled, the button function guide that corresponds to the locked button will not appear.

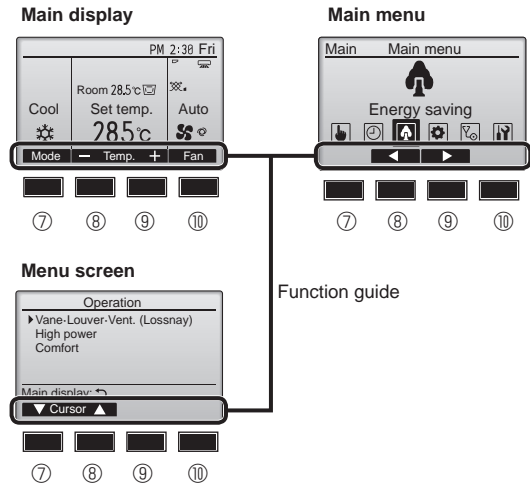

#### ① [ON/OFF] button

Press to turn ON/OFF the indoor unit.

#### ② [SELECT] button

Press to save the setting.

#### ③ [RETURN] button

Press to return to the previous screen.

#### ④ [MENU] button

Press to bring up the Main menu.

#### ⑤ Backlit LCD

Operation settings will appear.

When the backlight is off, pressing any button turns the backlight on and it will stay lit for a certain period of time depending on the screen.

When the backlight is off, pressing any button turns the backlight on and does not perform its function. (except for the [ON/OFF] button)

#### ⑥ ON/OFF lamp

This lamp lights up in green while the unit is in operation. It blinks while the remote controller is starting up or when there is an error.

#### ⑦ Function button [F1]

Main display: Press to change the operation mode.

Menu screen: The button function varies with the screen.

#### ⑧ Function button [F2]

Main display: Press to decrease temperature.

Main menu: Press to move the cursor left.

Menu screen: The button function varies with the screen.

#### ⑨ Function button [F3]

Main display: Press to increase temperature.

Main menu: Press to move the cursor right.

Menu screen: The button function varies with the screen.

#### ⑩ Function button [F4]

Main display: Press to change the fan speed.

Menu screen: The button function varies with the screen.

## 2. Parts Names

### Display

The main display can be displayed in two different modes: "Full" and "Basic". The factory setting is "Full". To switch to the "Basic" mode, change the setting on the Main display setting. (Refer to operation manual included with remote controller.)

<Full mode>

\* All icons are displayed for explanation.

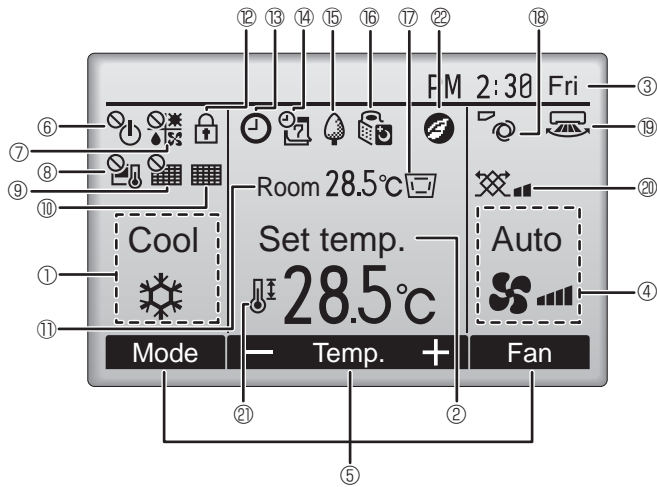

<Basic mode>

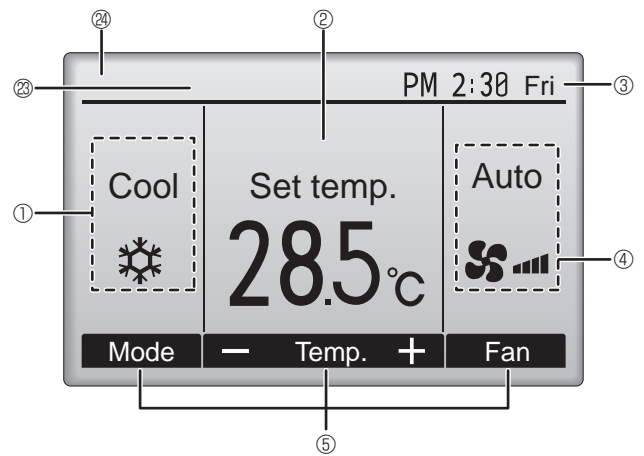

#### ① Operation mode

#### ② Preset temperature

#### ③ Clock

Current time appears here.

#### ④ Fan speed

#### ⑤ Button function guide

Functions of the corresponding buttons appear here.



Appears when the ON/OFF operation is centrally controlled.



Appears when the operation mode is centrally controlled.



Appears when the preset temperature is centrally controlled.



Appears when the filter reset function is centrally controlled.



Indicates when filter needs maintenance.

#### ⑪ Room temperature

Current room temperature appears here.



Appears when the buttons are locked.



Appears when the On/Off timer, Night setback, or Auto-off timer function is enabled.

⌚ appears when the timer is disabled by the centralized control system.



Appears when the Weekly timer is enabled.



Appears while the units are operated in the energy-save mode. (Will not appear on some models of indoor units)



Appears while the outdoor units are operated in the silent mode. (This indication is not available for CITY MULTI models.)



Appears when the built-in thermistor on the remote controller is activated to monitor the room temperature (⑪).

⌚ appears when the thermistor on the indoor unit is activated to monitor the room temperature.



Indicates the vane setting.



Indicates the louver setting.



Indicates the ventilation setting.



Appears when the preset temperature range is restricted.



Appears when an energy-saving operation is performed using a "3D i-See sensor" function. (not available)

#### ⑳ Centrally controlled

Appears for a certain period of time when a centrally-controlled item is operated.

#### ㉑ Preliminary error display

An error code appears during the preliminary error.

Most settings (except ON/OFF, mode, fan speed, temperature) can be made from the Main menu. (Refer to Page 8.)

## 2. Parts Names

### ■ Wireless Remote-Controller (Optional parts)

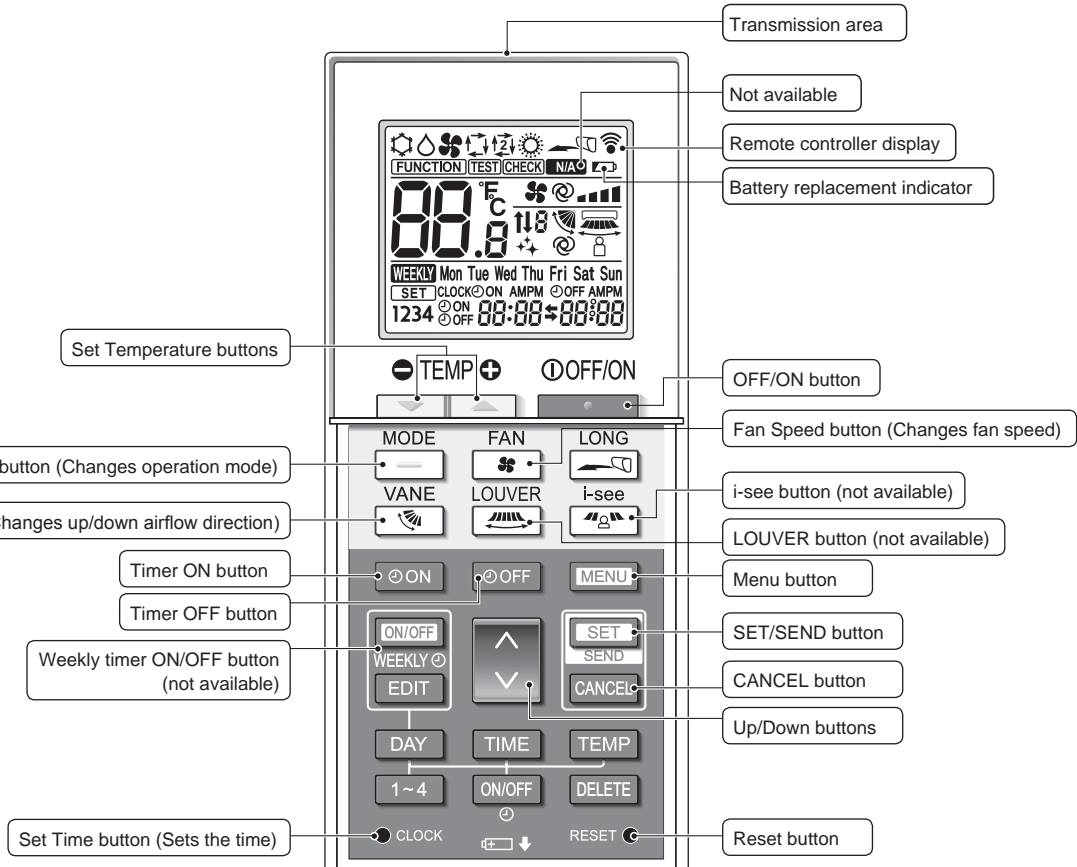

**Operation mode**

- Cool
- Dry
- Fan
- Auto (single set point)
- Heat
- Auto\* (dual set point)

\* The initial setting is necessary. Refer to Installation manual.

**Temperature setting**

The units of temperature can be changed. For details, refer to the Installation manual.

**Vane setting**

Step 1 Step 2 Step 3 Step 4 Step 5 Swing Auto

**Not available**  
Appears when a non-supported function is selected.

**Battery replacement indicator**  
Appears when the remaining battery power is low.

**Fan speed setting**

## 2. Parts Names

### Notes (Only for wireless remote controller):

- When using the wireless remote controller, point it towards the receiver on the indoor unit.
- If the remote controller is operated within approximately 2 minutes after power is supplied to the indoor unit, the indoor unit may beep twice as the unit is performing the initial automatic check.
- The indoor unit beeps to confirm that the signal transmitted from the remote controller has been received. Signals can be received up to approximately 7 meters in a direct line from the indoor unit in an area 45° to the left and right of the unit. However, illumination such as fluorescent lights and strong light can affect the ability of the indoor unit to receive signals.
- If the operation lamp near the receiver on the indoor unit is blinking, the unit needs to be inspected. Consult your dealer for service.
- Handle the remote controller carefully! Do not drop the remote controller or subject it to strong shocks. In addition, do not get the remote controller wet or leave it in a location with high humidity.
- To avoid misplacing the remote controller, install the holder included with the remote controller on a wall and be sure to always place the remote controller in the holder after use.
- If the indoor unit beeps 4 times when you are using the wireless remote controller, switch the auto mode setting to the AUTO (single set point) mode or AUTO (dual set point) mode. For details, refer to the included Notice (A5 sheet) or the Installation Manual.

### Battery installation/replacement

1. Remove the top cover, insert two LR6 AA batteries, and then install the top cover.

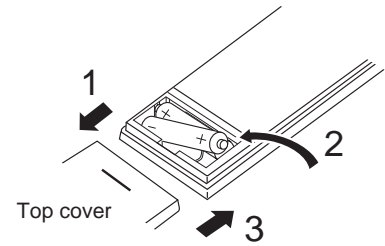

Two LR6 AA batteries  
Insert the negative (-) end of each battery first. Install the batteries in the correct directions (+, -)!

2. Press the Reset button.

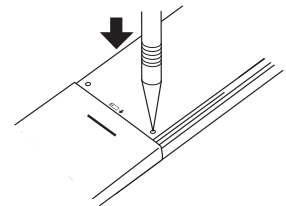

Press the Reset button with an object that has a narrow end.

After battery installation/replacement, please set the clock. For details on how to set the clock, refer to the operation manual included with the remote controller.

en

### 3. Operation

■ About the operation method, refer to the operation manual that comes with each remote controller.

#### 3.1. Turning ON/OFF

[ON]

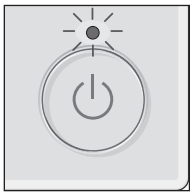

Press the [ON/OFF] button.  
The ON/OFF lamp will light up in green, and the operation will start.

[OFF]

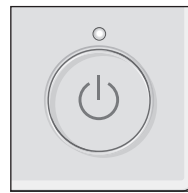

Press the [ON/OFF] button again.  
The ON/OFF lamp will come off, and the operation will stop.

**Note:**

Even if you press the ON/OFF button immediately after shutting down the operation is progress, the air conditioner will not start for about 3 minutes. This is to prevent the internal components from being damaged.

#### ■ Operation status memory

	Remote controller setting
Operation mode	Operation mode before the power was turned off
Preset temperature	Preset temperature before the power was turned off
Fan speed	Fan speed before the power was turned off

#### ■ Settable preset temperature range

Operation mode	Preset temperature range
Cool/Dry	19 ~ 30 °C
Heat	17 ~ 28 °C
Auto (Single set point)	19 ~ 28 °C
Auto (Dual set points)	[Cool] Preset temperature range for the Cool mode [Heat] Preset temperature range for the Heat mode
Fan/Ventilation	Not settable

The settable temperature range varies with the model of outdoor units and remote controller.

#### 3.2. Mode Selection

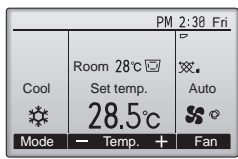

Each pressing of the [F1] button cycles through the following operation modes. Select the desired operation mode.

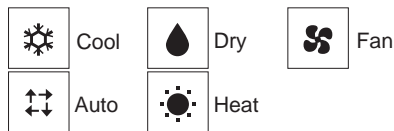

• Operation modes that are not available to the connected outdoor unit models will not appear on the display.

#### What the blinking mode icon means

The mode icon will blink when other indoor units in the same refrigerant system (connected to the same outdoor unit) are already operated in a different mode. In this case, the rest of the unit in the same group can only be operated in the same mode.

#### 3.3. Temperature setting

<Cool, Dry, Heat, and Auto (single set point)>

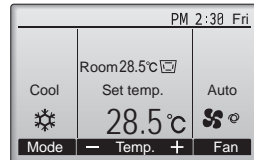
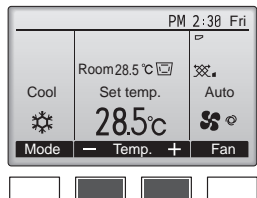

Example display  
(Centigrade in 0.5-degree increments)



Press the [F2] button to decrease the preset temperature, and press the [F3] button to increase.

- Refer to the table on this page for the settable temperature range for different operation modes.
- Preset temperature range cannot be set for Fan/Ventilation operation.
- Preset temperature will be displayed either in Centigrade in 0.5- or 1-degree increments, or in Fahrenheit, depending on the indoor unit model and the display mode setting on the remote controller.

#### Automatic operation (single set point)

- According to a set temperature, cooling operation starts if the room temperature is too hot and heating operation starts if the room temperature is too cold.
- During automatic operation, if the room temperature changes and remains 1.5 °C or more above the set temperature for 3 minutes, the air conditioner switches to cool mode. In the same way, if the room temperature remains 1.5 °C or more below the set temperature for 3 minutes, the air conditioner switches to heat mode.

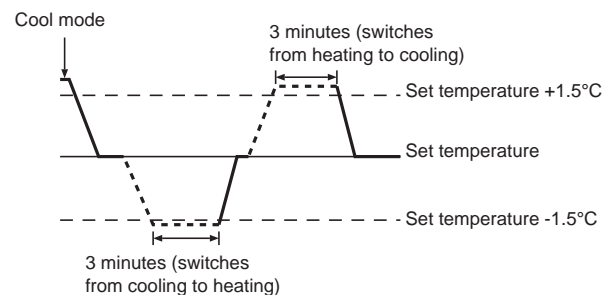

- Because the room temperature is automatically adjusted in order to maintain a fixed effective temperature, cooling operation is performed a few degrees warmer and heating operation is performed a few degrees cooler than the set room temperature once the temperature is reached (automatic energy-saving operation).



### 3. Operation

#### <Auto (dual set point) mode>

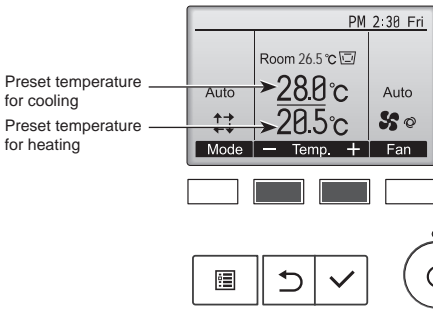

① The current preset temperatures will appear. Press the [F2] or [F3] button to display the Settings screen.

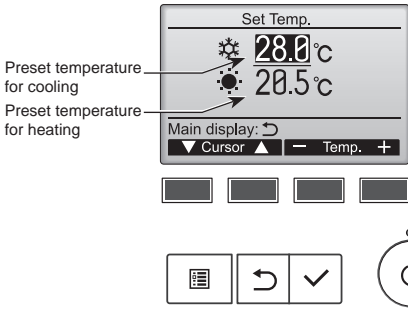

- ② Press the [F1] or [F2] button to move the cursor to the desired temperature setting (cooling or heating). Press the [F3] button to decrease the selected temperature, and [F4] to increase.
- Refer to the table on page 7 for the settable temperature range for different operation modes.
  - The preset temperature settings for cooling and heating in the Auto (dual set point) mode are also used by the Cool/Dry and Heat modes.
  - The preset temperatures for cooling and heating in the Auto (dual set point) mode must meet the conditions below:
    - Preset cooling temperature is higher than preset heating temperature.
    - The minimum temperature difference requirement between cooling and heating preset temperatures (varies with the models of indoor units connected) is met.
  - \* If preset temperatures are set in a way that does not meet the minimum temperature difference requirement, both preset temperatures will automatically be changed within the allowable setting ranges.

#### Navigating through the screens

- To return to the Main screen ..... [RETURN] button

#### <Auto operation (dual set point) mode>

When the operation mode is set to the Auto (dual set point) mode, two preset temperatures (one each for cooling and heating) can be set. Depending on the room temperature, indoor unit will automatically operate in either the Cool or Heat mode and keep the room temperature within the preset range.

The graph below shows the operation pattern of indoor unit operated in the Auto (dual set point) mode.

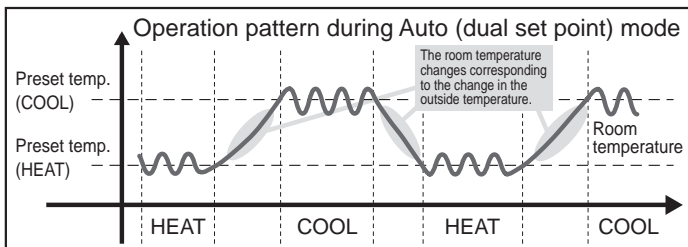

### 3.4. Fan speed setting

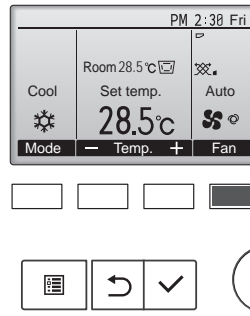

Each pressing of the [F4] button cycles through the following fan speeds.

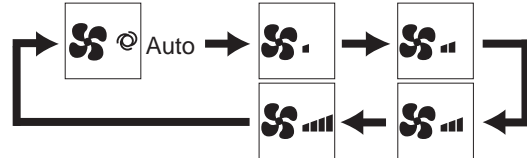

- The available fan speeds depend on the models of connected indoor units.

#### Note:

- The number of available fan speeds depends on the type of unit connected. Note also that some units do not provide an "Auto" setting.
- In the following cases, the actual fan speed generated by the unit will differ from the speed shown the remote controller display.
  - While the display is showing "STAND BY" or "DEFROST".
  - When the temperature of the heat exchanger is low in the heat mode. (e.g. immediately after heat operation starts)
  - In HEAT mode, when room temperature is higher than the temperature setting.
  - When the unit is in DRY mode.

### 3.5. Airflow direction setting

#### 3.5.1 Navigating through the Main menu

##### <Accessing the Main menu>

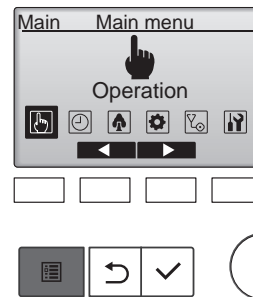

Press the [MENU] button on the Main display.  
The Main menu will appear.

##### <Item selection>

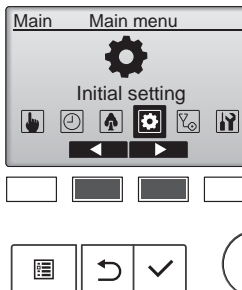

Press [F2] to move the cursor left.  
Press [F3] to move the cursor right.

en

### 3. Operation

#### <Navigating through the pages>

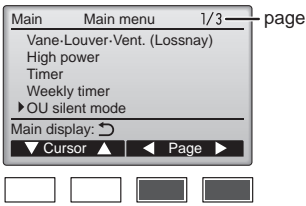

Press [F3] to go to the previous page.  
Press [F4] to go to the next page.



#### <Saving the settings>

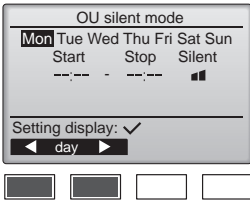

Select the desired item, and press the [SELECT] button.

The screen to set the selected item will appear.



#### <Exiting the Main menu screen>

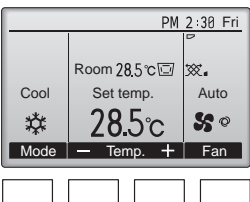

Press the [RETURN] button to exit the Main menu and return to the Main display.

If no buttons are touched for 10 minutes, the screen will automatically return to the Main display. Any settings that have not been saved will be lost.



#### <Display of unsupported functions>

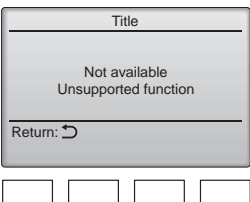

The message at left will appear if the user selects a function not supported by the corresponding indoor unit model.



### 3.5.2 Vane-Vent. (Lossnay)

#### <Accessing the menu>

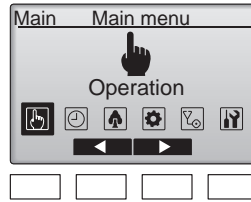

Select "Operation" from the Main menu (refer to page 8), and press the [SELECT] button.

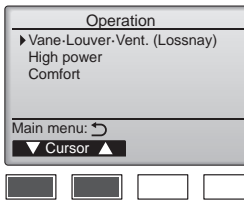

Select "Vane•Louver•Vent. (Lossnay)" from the Operation menu, and press the [SELECT] button.



#### <Vane setting>

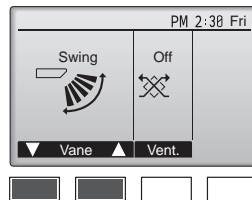

Press the [F1] or [F2] button to go through the vane setting options: "Auto", "Step 1", "Step 2", "Step 3", "Step 4", "Step 5" and "Swing".

Select the desired setting.

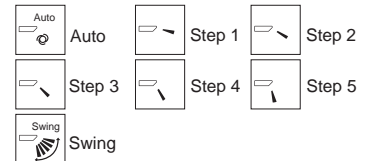

Select "Swing" to move the vanes up and down automatically. When set to "Step 1" through "Step 5", the vane will be fixed at the selected angle.

- **1h** under the vane setting icon  
This icon will appear when the vane is set to "Step 2" to "Step 5" and the fan operates at "Mid 1" to "Low" speed during cooling or dry operation (depends on the model).  
The icon will go off in an hour, and the vane setting will automatically change.

#### <Vent. setting>

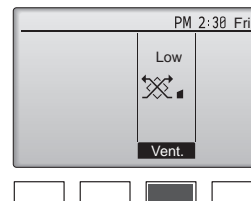

Press the [F3] button to go through the ventilation setting options in the order of "Off", "Low", and "High".

\* Settable only when LOSSNAY unit is connected.



- The fan on some models of indoor units may be interlocked with certain models of ventilation units.

### 3. Operation

#### <Returning to the Operation menu>

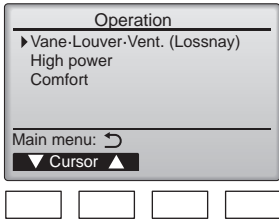

Press the [RETURN] button to go back to the Operation menu.



#### Note:

- During swing operation, the directional indication on the screen does not change in sync with the directional vanes on the unit.
- Available directions depend on the type of unit connected.
- In the following cases, the actual air direction will differ from the direction indicated on the remote controller display.
  1. While the display is in "STAND BY" or "DEFROST" states.
  2. Immediately after starting heat mode (while the system is waiting for the mode change to take effect).
  3. In heat mode, when room temperature is higher than the temperature setting.

#### <[Manual] To Change the Airflow's Left/Right Direction>

- \* The louver button cannot be used.
- Stop the unit operation, hold the lever of the louver, and adjust to the desired direction.
- \* Do not set to the inside direction when the unit is in the cooling or drying mode because there is a risk of condensation and water dripping.

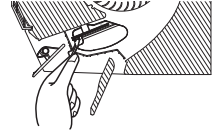

#### ⚠ Caution:

To prevent falls, maintain a stable footing when operating the unit.

### 3.6. Ventilation

For LOSSNAY combination

- The following 2 patterns of operation is available.
  - Run the ventilator together with indoor unit.
  - Run the ventilator independently.

#### Note: (for wireless remote controller)

- Running the ventilator independently is not available.
- No indication on the remote controller.

en

### 4. Timer

- Timer functions are different by each remote controller.
- For details on how to operate the remote controller, refer to the appropriate operation manual included with each remote controller.

### 5. Emergency Operation for Wireless Remote-controller

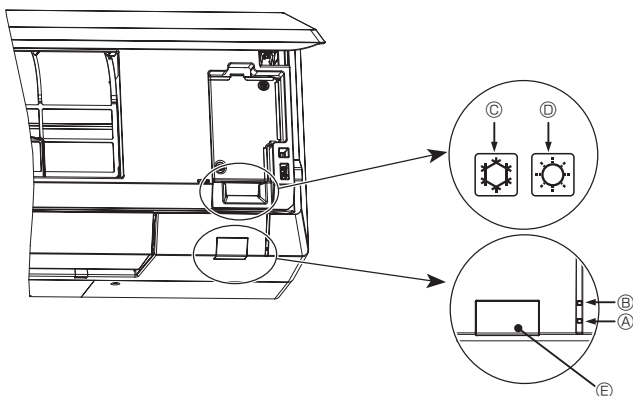

#### When the remote controller cannot be used

When the batteries of the remote controller run out or the remote controller malfunctions, the emergency operation can be done using the emergency buttons on the grille.

- Ⓐ STANDBY lamp
- Ⓑ OPERATING lamp
- Ⓒ Emergency operation cooling switch
- Ⓓ Emergency operation heating switch
- Ⓔ Receiver

#### Starting operation

- To operate the cooling mode, press the ❄ button Ⓒ for more than 2 seconds.
- To operate the heating mode, press the 🔥 button Ⓓ for more than 2 seconds.
- Lighting of the OPERATING lamp Ⓑ means the start of operation.

#### Note:

● Details of emergency mode are as shown below.  
Details of EMERGENCY MODE are as shown below.

Operation mode	COOL	HEAT
Set temperature	24°C	24°C
Fan speed	High	High
Airflow direction	Horizontal (Step 1)	Downward (Step 5)

#### Stopping operation

- To stop operation, press the ❄ button Ⓒ or the 🔥 button Ⓓ for more than 2 seconds.

## 6. Care and Cleaning

### ■ Filter information

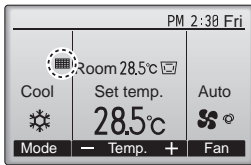

 will appear on the Main display in the Full mode when it is time to clean the filters.

**Wash, clean, or replace the filters when this sign appears. Refer to the indoor unit Instructions Manual for details.**

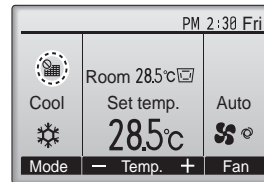

When the  is displayed on the Main display in the Full mode, the system is centrally controlled and the filter sign cannot be reset.

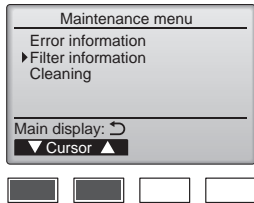

Select "Filter information" from the Maintenance menu, and press the [SELECT] button.

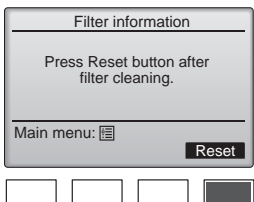

Press the [F4] button to reset filter sign. Refer to the indoor unit Instructions Manual for how to clean the filter.

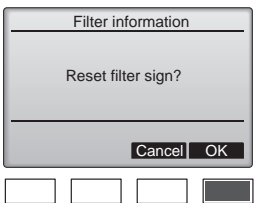

Select "OK" with the [F4] button.

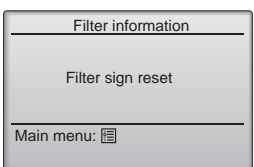

A confirmation screen will appear.

- Navigating through the screens
- To go back to the Main menu..... [MENU] button
  - To return to the previous screen ..... [RETURN] button

If two or more indoor units are connected, filter cleaning timing for each unit may be different, depending on the filter type.

The icon  will appear when the filter on the main unit is due for cleaning.

When the filter sign is reset, the cumulative operation time of all units will be reset.

The icon  is scheduled to appear after a certain duration of operation, based on the premise that the indoor units are installed in a space with ordinary air quality. Depending on the air quality, the filter may require more frequent cleaning.

The cumulative time at which filter needs cleaning depends on the model.

- This indication is not available for wireless remote controller.

### ► Cleaning the filters

- Clean the filters using a vacuum cleaner. If you do not have a vacuum cleaner, tap the filters against a solid object to knock off dirt and dust.
- If the filters are especially dirty, wash them in lukewarm water. Take care to rinse off any detergent thoroughly and allow the filters to dry completely before putting them back into the unit.

#### ⚠ Caution:

- Do not dry the filters in direct sunlight or by using a heat source, such as an electric heater: this may warp them.
- Do not wash the filters in hot water (above 50°C), as this may warp them.
- Make sure that the air filters are always installed. Operating the unit without air filters can cause malfunction.

#### ⚠ Caution:

- Before you start cleaning, stop operation and turn OFF the power supply.
- Indoor units are equipped with filters to remove the dust of sucked-in air. Clean the filters using the methods shown in the following sketches.

#### ⚠ Caution:

- In removing the filter, precautions must be taken to protect your eyes from dust. Also, if you have to climb up on a stool to do the job, be careful not to fall.
- When the filter is removed, do not touch the metallic parts inside the indoor unit, otherwise injury may result.

## 6. Care and Cleaning

### ■ PKFY-P-VLM

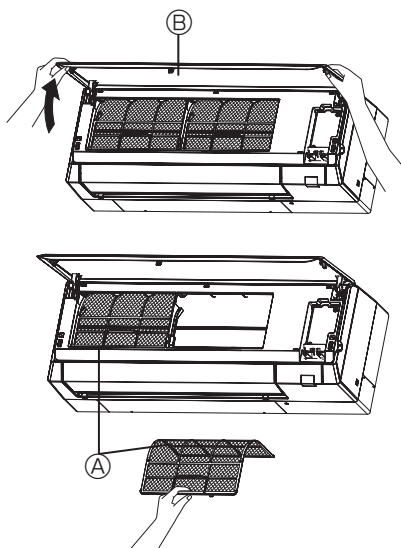

① Pull both the bottom corners of the grille to open the grille, then lift the filter.

Ⓐ Filter

Ⓑ Grille

### Cleaning the indoor unit

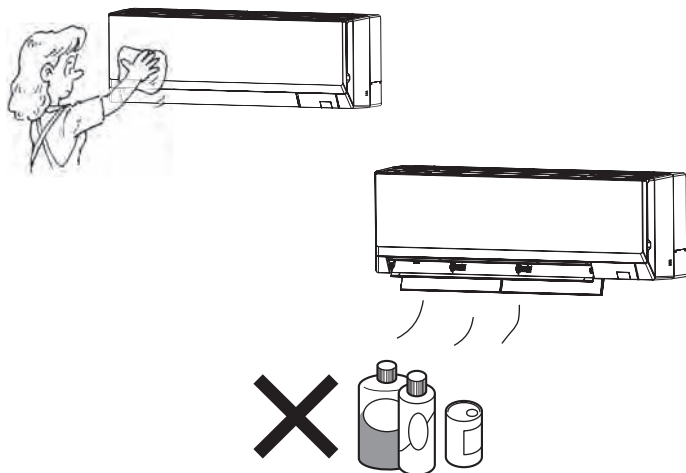







- Wipe the outside of the unit with a clean, dry, soft cloth.
- Clean off any oil stains or finger marks using a neutral household detergent (such as dishwashing liquid or laundry detergent).

#### ⚠ Caution:

Never use gasoline, benzene, thinner, scouring powder or any type of non-neutral detergent, as these substances may damage the unit's case.

## 7. Troubleshooting

Having trouble?	Here is the solution. (Unit is operating normally.)
Air conditioner does not heat or cool well.	<ul style="list-style-type: none"> <li>■ Clean the filter. (Airflow is reduced when the filter is dirty or clogged.)</li> <li>■ Check the temperature adjustment and adjust the set temperature.</li> <li>■ Make sure that there is plenty of space around the outdoor unit. Is the indoor unit air inlet or outlet blocked?</li> <li>■ Has a door or window been left open?</li> </ul>
When heating operation starts, warm air does not blow from the indoor unit soon.	<ul style="list-style-type: none"> <li>■ Warm air does not blow until the indoor unit has sufficiently warmed up.</li> </ul>
During heat mode, the air conditioner stops before the set room temperature is reached.	<ul style="list-style-type: none"> <li>■ When the outdoor temperature is low and the humidity is high, frost may form on the outdoor unit. If this occurs, the outdoor unit performs a defrosting operation. Normal operation should begin after approximately 10 minutes.</li> </ul>
Airflow up/down direction changes during operation or airflow up/down direction cannot be set.	<ul style="list-style-type: none"> <li>■ During cool mode, the vanes automatically move to the step 1 position after 1 hour when the vane is set to "Step 2" to "Step 5". This is to prevent water from forming and dripping from the vanes.</li> <li>■ During heat mode, the vanes automatically move to the step 1 position when the airflow temperature is low or during defrosting mode.</li> </ul>
When the airflow up/down direction is changed, the vanes always move up and down past the set position before finally stopping at the position.	<ul style="list-style-type: none"> <li>■ When the airflow up/down direction is changed, the vanes move to the set position after detecting the base position.</li> </ul>
A flowing water sound or occasional hissing sound is heard.	<ul style="list-style-type: none"> <li>■ These sounds can be heard when refrigerant is flowing in the air conditioner or when the refrigerant flow is changing.</li> </ul>
A cracking or creaking sound is heard.	<ul style="list-style-type: none"> <li>■ These sounds can be heard when parts rub against each other due to expansion and contraction from temperature changes.</li> </ul>
The room has an unpleasant odor.	<ul style="list-style-type: none"> <li>■ The indoor unit draws in air that contains gases produced from the walls, carpeting, and furniture as well as odors trapped in clothing, and then blows this air back into the room.</li> </ul>
A white mist or vapor is emitted from the indoor unit.	<ul style="list-style-type: none"> <li>■ If the indoor temperature and the humidity are high, this condition may occur when operation starts.</li> <li>■ During defrosting mode, cool airflow may blow down and appear like a mist.</li> </ul>
Water or vapor is emitted from the outdoor unit.	<ul style="list-style-type: none"> <li>■ During cool mode, water may form and drip from the cool pipes and joints.</li> <li>■ During heat mode, water may form and drip from the heat exchanger.</li> <li>■ During defrosting mode, water on the heat exchanger evaporates and water vapor may be emitted.</li> </ul>
The air conditioner does not operate even though the ON/OFF button is pressed. The operation mode display on the remote controller disappears.	<ul style="list-style-type: none"> <li>■ Is the power switch of the indoor unit turned off? Turn on the power switch.</li> </ul>
"  " appears in the remote controller display.	<ul style="list-style-type: none"> <li>■ During central control, " " appears in the remote controller display and air conditioner operation cannot be started or stopped using the remote controller.</li> </ul>
When restarting the air conditioner soon after stopping it, it does not operate even though the ON/OFF button is pressed.	<ul style="list-style-type: none"> <li>■ Wait approximately 3 minutes. (Operation has stopped to protect the air conditioner.)</li> </ul>
Air conditioner operates without the ON/OFF button being pressed.	<ul style="list-style-type: none"> <li>■ Is the on timer set? Press the ON/OFF button to stop operation.</li> <li>■ Is the air conditioner connected to a central remote controller? Consult the concerned people who control the air conditioner.</li> <li>■ Does " " appear in the remote controller display? Consult the concerned people who control the air conditioner.</li> <li>■ Has the auto recovery feature from power failures been set? Press the ON/OFF button to stop operation.</li> </ul>
Air conditioner stops without the ON/OFF button being pressed.	<ul style="list-style-type: none"> <li>■ Is the off timer set? Press the ON/OFF button to restart operation.</li> <li>■ Is the air conditioner connected to a central remote controller? Consult the concerned people who control the air conditioner.</li> <li>■ Does " " appear in the remote controller display? Consult the concerned people who control the air conditioner.</li> </ul>
Remote controller timer operation cannot be set.	<ul style="list-style-type: none"> <li>■ Are timer settings invalid? If the timer can be set,  or  appears in the remote controller display.</li> </ul>
"PLEASE WAIT" appears in the remote controller display.	<ul style="list-style-type: none"> <li>■ The initial settings are being performed. Wait approximately 3 minutes.</li> </ul>
An error code appears in the remote controller display.	<ul style="list-style-type: none"> <li>■ The protection devices have operated to protect the air conditioner.</li> <li>■ Do not attempt to repair this equipment by yourself. Turn off the power switch immediately and consult your dealer. Be sure to provide the dealer with the model name and information that appeared in the remote controller display.</li> </ul>
Draining water or motor rotation sound is heard.	<ul style="list-style-type: none"> <li>■ When cooling operation stops, the drain pump operates and then stops. Wait approximately 3 minutes.</li> </ul>

## 7. Troubleshooting

Having trouble?	Here is the solution. (Unit is operating normally.)												
Noise is louder than specifications.	<ul style="list-style-type: none"> <li>The indoor operation sound level is affected by the acoustics of the particular room as shown in the following table and will be higher than the noise specification, which was measured in an echo-free room.</li> </ul> <table border="1"> <thead> <tr> <th></th> <th>High sound-absorbing rooms</th> <th>Normal rooms</th> <th>Low sound-absorbing rooms</th> </tr> </thead> <tbody> <tr> <td>Location examples</td> <td>Broadcasting studio, music room, etc.</td> <td>Reception room, hotel lobby, etc.</td> <td>Office, hotel room</td> </tr> <tr> <td>Noise levels</td> <td>3 to 7 dB</td> <td>6 to 10 dB</td> <td>9 to 13 dB</td> </tr> </tbody> </table>		High sound-absorbing rooms	Normal rooms	Low sound-absorbing rooms	Location examples	Broadcasting studio, music room, etc.	Reception room, hotel lobby, etc.	Office, hotel room	Noise levels	3 to 7 dB	6 to 10 dB	9 to 13 dB
	High sound-absorbing rooms	Normal rooms	Low sound-absorbing rooms										
Location examples	Broadcasting studio, music room, etc.	Reception room, hotel lobby, etc.	Office, hotel room										
Noise levels	3 to 7 dB	6 to 10 dB	9 to 13 dB										
Nothing appears in the wireless remote controller display, the display is faint, or signals are not received by the indoor unit unless the remote controller is close.	<ul style="list-style-type: none"> <li>The batteries are low. Replace the batteries and press the Reset button.</li> <li>If nothing appears even after the batteries are replaced, make sure that the batteries are installed in the correct directions (+, -).</li> </ul>												
The operation lamp near the receiver for the wireless remote controller on the indoor unit is blinking.	<ul style="list-style-type: none"> <li>The self diagnosis function has operated to protect the air conditioner.</li> <li>Do not attempt to repair this equipment by yourself. Turn off the power switch immediately and consult your dealer. Be sure to provide the dealer with the model name.</li> </ul>												
Warm air blows from the indoor unit intermittently when heating mode is off or during fan mode.	<ul style="list-style-type: none"> <li>When another indoor unit is operating in heating mode, the control valve opens and closes occasionally to maintain stability in the air conditioning system. This operation will stop after a while. <ul style="list-style-type: none"> <li>* If this will cause an undesirable rise in the room temperature in small rooms, etc., stop the operation of the indoor unit temporarily.</li> </ul> </li> </ul>												
The wireless remote controller does not operate (the indoor unit beeps 4 times).	<ul style="list-style-type: none"> <li>Switch the auto mode setting to the AUTO (single set point) mode or AUTO (dual set point) mode. For details, refer to the included Notice (A5 sheet) or the Installation Manual.</li> </ul>												
Refrigerant noise is heard or warm air comes out from the suspended indoor unit.	<ul style="list-style-type: none"> <li>A small amount of refrigerant flows into the suspended indoor unit while other indoor units are in operation at HEAT mode.</li> </ul>												

### Warning:

If the air conditioner operates but does not cool or heat (depending on model) the room, consult your dealer since there may be a refrigerant leak. Be sure to ask the service representative whether there is refrigerant leakage or not when repairs are carried out. The refrigerant charged in the air conditioner is safe. Refrigerant normally does not leak. However, if refrigerant gas leaks indoors, and comes into contact with the fire of a fan heater, space heater, stove, etc., harmful substances will be generated.

## 8. Specifications

### Range of application

The range of working temperatures for both the indoor and outdoor units of the series Y, R2, Multi-S is as below.

#### ■ PKFY-P-VLM-E/ET

Model	P10*	P15	P20	P25	P32	P40	P50
Power source (Voltage/Frequency)	<V/Hz> ~/N 220-230-240/50, 220-230/60						
Capacity (Cooling/Heating)	<kW> 1.2/1.4	1.7/1.9	2.2/2.5	2.8/3.2	3.6/4.0	4.5/5.0	5.6/6.3
Dimension (Height)	<mm> 299					299	
Dimension (Width)	<mm> 773					898	
Dimension (Depth)	<mm> 237					237	
Net weight	<kg> 11					13	
Fan Airflow rate (Low-Middle2-Middle1-High)	<m <sup>3</sup> /min> 3.3-3.5-3.8-4.2	4.0-4.2-4.4-4.7	4.0-4.4-4.9-5.4	4.0-4.6-5.4-6.7	4.3-5.4-6.9-8.4	6.3-7.4-8.6-10.0	6.8-8.3-10.2-12.4
Noise level (Low-Middle2-Middle1-High)	<dB> 22-24-26-28	22-24-26-28	22-26-29-31	22-27-31-35	24-31-37-41	29-34-37-40	31-36-41-46

\* P10 model is for the specific region only

Model		P10	P15	P20	P25	P32	P40	P50
Cooling capacity	sensible P <sub>rated,c</sub>	<kW> 0.96	1.23	1.43	1.74	2.17	3.01	3.65
	latent P <sub>rated,c</sub>	<kW> 0.24	0.47	0.77	1.06	1.43	1.49	1.95
Heating capacity	P <sub>rated,h</sub>	<kW> 1.40	1.90	2.50	3.20	4.00	5.00	6.30
Total electric power input	P <sub>elec</sub>	<kW> 0.02	0.02	0.02	0.03	0.04	0.04	0.05
Sound power level (per speed setting, if applicable)	L <sub>WA</sub>	<dB> 43-45-47-49	44-45-47-49	45-48-50-52	46-49-52-56	48-53-58-62	52-56-58-61	54-58-62-65

(EU)2016/2281

#### ■ PKFY-P-VLM-DA

Model	P15	P20	P25	P32	P40	P50
Power source (Voltage/Frequency)	<V/Hz> ~/N 220-230-240/50, 220-230/60					
Capacity (Cooling/Heating)	<kW> 1.7/1.9	2.2/2.5	2.8/3.2	3.6/4.0	4.5/5.0	5.6/6.3
Dimension (Height)	<mm> 299				299	
Dimension (Width)	<mm> 773				898	
Dimension (Depth)	<mm> 237				237	
Net weight	<kg> 11				13	
Fan Airflow rate (Low-Middle2-Middle1-High)	<m <sup>3</sup> /min> 4.0-4.4-4.8-5.3	4.0-4.6-5.2-5.9	4.0-4.6-5.4-6.7	4.3-5.9-8.0-10.4	6.3-7.7-9.5-11.5	6.8-8.3-10.2-12.4
Noise level (Low-Middle2-Middle1-High)	<dB> 22-26-28-30	22-27-30-33	22-27-31-35	24-33-41-48	29-35-40-44	31-36-41-46

### Note

- Operation temperature of indoor unit.  
Cooling mode: 15 °CWB - 24 °CWB  
Heating mode: 15 °CDB - 27 °CDB
- Cooling/Heating capacity indicates the maximum value at operation under the following condition.  
Cooling: Indoor 27 °C DB/19 °C WB, Outdoor 35 °C DB  
Heating: Indoor 20 °C DB, Outdoor 7 °C DB/6 °C WB



EC DECLARATION OF CONFORMITY  
EG-KONFORMITÄTSERKLÄRUNG  
DECLARATION DE CONFORMITÉ CE  
EG-CONFORMITEITSVERKLARING  
DECLARACIÓN DE CONFORMIDAD CE  
DICHIARAZIONE DI CONFORMITÀ CE  
ΔΗΛΩΣΗ ΠΙΣΤΟΤΗΤΑΣ ΕΚ

DECLARAÇÃO DE CONFORMIDADE CE  
EU-OVERENSSTEMMELSESERKLÆRING  
EG-DEKLARATION OM ØVERENSSTÅMMEELSE  
EG UYGUNLUK BEYANI  
ДЕКЛАРАЦИЯ СООТВЕТСТВИЯ НОРМАМ ЕС  
ДЕКЛАРАЦІЯ ВІДПОВІДНОСТІ НОРМАМ ЄС  
ЕС ДЕКЛАРАЦІЯ ЗА СЪОТВЕТСТВИЕ

DEKLARACJA ZGODNOŚCI WE  
CE-ERKLÆRING OM SAMSVAR  
EY-VAATIMUSTENMUKAISUUSVAKUUTUS  
ES PROHLÁŠENÍ O SHODĚ  
VYHLÁŠENIE O ZHODE ES  
EK MEGFELELŐSÉGI NYILATKOZAT  
IZJAVA O SKLADNOSTI ES

DECLARAȚIE DE CONFORMITATE CE  
EU VASTAVUSDEKLARATSIOON  
EK ATBILSTĪBAS DEKLARĀCIJA  
EB ATITIKTĪES DEKLARĀCIJA  
EC IZJAVA O SKLADNOSTI  
EZ IZJAVA O USAGLAŠENOSTI

**MITSUBISHI ELECTRIC CONSUMER PRODUCTS (THAILAND) CO., LTD.**  
**AMATA NAKORN INDUSTRIAL ESTATE 700/406 MOO 7, TAMBON DON HUA ROH, AMPHUR MUANG, CHONBURI 20000, THAILAND**

hereby declares under its sole responsibility that the air conditioners and heat pumps described below for use in residential, commercial and light-industrial environments:  
erklärt hiermit auf seine alleinige Verantwortung, dass die Klimaanlage und Wärmepumpe für das häusliche, kommerzielle und leicht-industrielle Umfeld wie unten beschrieben:  
déclare par la présente et sous sa propre responsabilité que les climatiseurs et les pompes à chaleur décrits ci-dessous, destinés à un usage dans des environnements résidentiels, commerciaux et d'industrie légère :  
verklaart hierbij onder eigen verantwoordelijkheid dat de voor residentiële, commerciële en licht-industriële omgevingen bestemde airconditioners en warmtepompen zoals onderstaand beschreven:  
por la presente declara bajo su única responsabilidad que los acondicionadores de aire y bombas de calor descritas a continuación para su uso en entornos residenciales, comerciales y de industria ligera:  
confirma con la presente, sotto la sua esclusiva responsabilità, che i condizionatori d'aria e le pompe di calore descritti di seguito e destinati all'utilizzo in ambienti residenziali, commerciali e semi-industriali:  
με το παρόν πιστοποιεί με αποκλειστική της ευθύνη ότι οι τα κλιματιστικά και οι αντλίες θέρμανσης που περιγράφονται παρακάτω για χρήση σε οικιακά, επαγγελματικό και ελαφριάς βιομηχανίας περιβάλλοντα:  
através da presente declara sob sua única responsabilidade que os aparelhos de ar condicionado e bombas de calor abaixo descritos para uso residencial, comercial e de indústria ligeira:  
intygat härmed att luftkonditioneringarna och värmepumparna som beskrivs nedan för användning i bostäder, kommersiella miljöer och lätta industriella miljöer:  
ev, ticaret ve hafif sanayi ortamlarında kullanılmaya elverişli üretilen ve aşağıda açıklanan klima ve ısıtma pompalarıyla ilgili aşağıdaki hususları yalnızca kendi sorumluluğunda beyan eder:  
настоящим заявляет и берет на себя исключительную ответственность за то, что кондиционеры и тепловые насосы, описанные ниже и предназначенные для эксплуатации в жилых помещениях, торговых залах и на предприятиях легкой промышленности:  
цим заявляє, беручи на себе повну відповідальність за це, що кондиціонери й теплові насоси, описані нижче й призначені для використання в житлових приміщеннях, торговельних залах і на підприємствах легкої промисловості:  
декларира на своя собствена отговорност, че климатизите и термопомпите, описани по-долу, за употреба в жилищни, търговски и леки промишлени условия:  
niniejszym oświadczam na swoją wyłączną odpowiedzialność, że klimatyzatory i pompy ciepła opisane poniżej, są przeznaczone do zastosowań w środowisku mieszkalnym, handlowym i lekko przemysłowym:  
erklærer et fullstendig ansvar for undernevnte klimaanlegg og varmepumper ved bruk i boliger, samt kommersielle og lettindustrielle miljøer:  
vakuuttaa täten yksinomaista vastuullaan, että jäljempänä kuvattut asuinrakennuksiin, pientaloisuuskäyttöön ja kaupalliseen käyttöön tarkoitettu ilmastointilaitteet ja lämpöpumpat:  
tímto na vlastní odpovědnost prohlašuje, že níže popsané klimatizační jednotky a tepelná čerpadla pro použití v obytných prostředích, komerčních prostředích a prostředích lehkého průmyslu:  
týmto na svoju výlučnú zodpovednosť vyhlasuje, že nasledovné klimatizačné jednotky a tepelné čerpadlá určené na používanie v obytných a obchodných priestoroch a v prostredí ľahkého priemyslu:  
alulírott kizárólagos felelősségére nyilatkozik, hogy az alábbi lakossági, kereskedelmi és kisipari környezetben való használatra szánt klímaberendezések és hőszivattyúk:  
izjavlja pod izključno lastno odgovornostjo, da so spodaj navedene klimatske naprave in toplotne črpalke, namenjene uporabi v stanovanjskih, komercialnih in lahkoindustrijskih okoljih:  
declară, prin prezenta, pe proprie răspundere, faptul că aparatele de climatizare și pompele de căldură descrise mai jos și destinate utilizării în medii rezidențiale, comerciale și din industria ușoară:  
kinnitab käesolevaga oma ainuvastutusest, et allpool toodud kliimaseadmed ja soojuspumbad on mõeldud kasutamiseks elu-, äri- ja kergtööstuskeskkondades:  
ar šo, vienpersoniski uzņemoties atbildību, paziņo, ka tālāk aprakstītie gaisa kondicionētāji un siltumsūkņi ir paredzēti lietošanai dzīvojamajās, komercdarbības un vieglās rūpniecības telpās.  
šuo vien tik savo atsakomybe pareiškia, kad toliau apibūdinti oro kondicionieriai ir šilumos siurbiai skirti naudoti gyvenamosiose, komercinesė ir lengvosios pramonės aplinkose:  
ovime izjavljuje pod isključivom odgovornošću da su klimatizacijski uređaji i toplinske dizalice opisane u nastavku namijenjeni za upotrebu u stambenim i poslovnim okruženjima te okruženjima lake industrije:  
ovim izjavljuje na svoju isključivu odgovornost da su klima-uređaji i toplotne pumpe opisane u daljem tekstu za upotrebu u stambenim, komercijalnim okruženjima i okruženjima sa lakom industrijom:

**MITSUBISHI ELECTRIC, PKFY-P10VLM-E\*, PKFY-P15VLM-E\*, PKFY-P20VLM-E\*, PKFY-P25VLM-E\***  
**PKFY-P32VLM-E\*, PKFY-P40VLM-E\*, PKFY-P50VLM-E\***  
**PKFY-P10VLM-ET\*, PKFY-P15VLM-ET\*, PKFY-P20VLM-ET\*, PKFY-P25VLM-ET\***  
**PKFY-P32VLM-ET\*, PKFY-P40VLM-ET\*, PKFY-P50VLM-ET\***  
**PKFY-P15VLM-DA\*, PKFY-P20VLM-DA\*, PKFY-P25VLM-DA\***  
**PKFY-P32VLM-DA\*, PKFY-P40VLM-DA\*, PKFY-P50VLM-DA\***  
\* : , , 1, 2, 3, . . . , 9

Note: Its serial number is on the nameplate of the product.  
Hinweis: Die Seriennummer befindet sich auf dem Kennschild des Produkts.  
Remarque : Le numéro de série de l'appareil se trouve sur la plaque du produit.  
Opmerking: het serienummer staat op het naamplaatje van het product.  
Nota: El número de serie se encuentra en la placa que contiene el nombre del producto.  
Nota: Il numero di serie si trova sulla targhetta del prodotto.  
Σημείωση: Ο σειριακός του αριθμός βρίσκεται στην πινακίδα ονόματος του προϊόντος.  
Nota: o número de série encontra-se na placa que contém o nome do produto.  
Bemærk: Serienummeret står på produktets fabrikksskilt.  
Obs: Serienumret finns på produktens namnplåt.  
Not: Seri numarası ürünün isim plakasında yer alır.  
Примечание: серийный номер указан на паспортное табличке изделия.  
Примітка. Серійний номер вказано на паспортній табличці виробу.  
Забелешка: Серийният му номер е на табелката на продукта.

Uwaga: Numer seryjny znajduje się na tabliczce znamionowej produktu.  
Merk: Serienummeret befinnet seg på navneplaten til produktet.  
Huomautus: Sarjanumero on merkitty laitteen arvokilpeen.  
Poznámka: Příslušné sériové číslo se nachází na štítku produktu.  
Poznámka: Výrobné číslo sa nachádza na typovom štítku výrobku.  
Megjegyzés: A sorozatszám a termék adattábláján található.  
Opomba: serijska številka je zapisana na tipski ploščici enote.  
Notă: Numărul de serie este specificat pe plăcuța indicatoare a produsului.  
Márkus: Seerianumber asub toote andmesilidil.  
Piezīme: Sērijas numurs ir norādīts uz ierīces datu plāksnītes.  
Pastaba. Serijos numeris nurodytas gaminio vardinį duomenų lentelėje.  
Napomena: serijski broj nalazi se na natpisnoj pločici proizvoda.  
Napomena: Serijski broj nalazi se na nazivnoj pločici proizvoda.

Directives  
Richtlijnen  
Directives  
Richtlijnen  
Directivas  
Direttive  
Οδηγίες

Directivas  
Direktiver  
Direktiv  
Direktifler  
Директивы  
Директиви  
Директиви

Dyrektwy  
Direktiver  
Direktiivit  
Směrnice  
Smernice  
Írányelvek  
Direktive

Directive  
Direktiivid  
Direktīvas  
Direktivos  
Direktive  
Direktive

2014/35/EU: Low Voltage  
2006/42/EC: Machinery  
2014/30/EU: Electromagnetic Compatibility

Issued: 20 Apr. 2019  
THAILAND

Akira HIDAKA  
Manager, Quality Assurance Department

**<ENGLISH>**

English is original. The other languages versions are translation of the original.

**▲ CAUTION**

- Refrigerant leakage may cause suffocation. Provide ventilation in accordance with EN378-1.
- Be sure to wrap insulation around the piping. Direct contact with the bare piping may result in burns or frostbite.
- Never put batteries in your mouth for any reason to avoid accidental ingestion.
- Battery ingestion may cause choking and/or poisoning.
- Install the unit on a rigid structure to prevent excessive operation sound or vibration.
- Noise measurement is carried out in accordance with JIS C9612, JIS B8616, ISO 5151(T1), and ISO 13523(T1).

**<DEUTSCH>**

Das Original ist in Englisch. Die anderen Sprachversionen sind vom Original übersetzt.

**▲ VORSICHT**

- Das Auslaufen von Kältemittel kann zu Erstickung führen. Sorgen Sie für Belüftung gemäß der Bestimmung EN378-1.
- Sicherstellen, dass die Rohrführung isoliert ist. Direkter Kontakt mit der blanken Rohrführung kann zu Verbrennungen oder Erfrierung führen.
- Nehmen Sie unter keinen Umständen Batterien in den Mund, um versehentliches Verschlucken zu vermeiden.
- Das Verschlucken von Batterien kann zu Erstickung und/oder Vergiftung führen.
- Installieren Sie das Gerät an einer stabilen Struktur, um übermäßige Betriebsgeräusche oder Vibration zu vermeiden.
- Geräuschmessungen werden gemäß der Bestimmungen JIS C9612, JIS B8616, ISO 5151(T1), und ISO 13523(T1) ausgeführt.

**<FRANÇAIS>**

L'anglais est l'original. Les versions fournies dans d'autres langues sont des traductions de l'original.

**▲ PRECAUTION**

- Une fuite de réfrigérant peut entraîner une asphyxie. Fournissez une ventilation adéquate en accord avec la norme EN378-1.
- Assurez-vous que la tuyauterie est enveloppée d'isolant. Un contact direct avec la tuyauterie nue peut entraîner des brûlures ou des engelures.
- Ne mettez jamais des piles dans la bouche pour quelque raison que ce soit pour éviter de les avaler par accident.
- Le fait d'ingérer des piles peut entraîner un étouffement et/ou un empoisonnement.
- Installez l'unité sur une structure rigide pour prévenir un bruit de fonctionnement et une vibration excessifs.
- Les mesures de niveau sonore ont été effectuées en accord avec les normes JIS C9612, JIS B8616, ISO 5151(T1) et ISO 13523(T1).

**<NEDERLANDS>**

Het Engels is het origineel. De andere taalversies zijn vertalingen van het origineel.

**▲ VOORZICHTIG**

- Het lekken van koelvloeistof kan verstikking veroorzaken. Zorg voor ventilatie in overeenstemming met EN378-1.
- isoleer de leidingen met isolatiemateriaal. Direct contact met de onbedekte leidingen kan leiden tot brandwonden of bevriezing.
- Stop nooit batterijen in uw mond om inslikking te voorkomen.
- Het inslikken van batterijen kan verstikking of vergiftiging veroorzaken.
- Installeer het apparaat op een stabiele structuur om overmatig lawaai of trillingen te voorkomen.
- Geluidsmetingen worden uitgevoerd in overeenstemming met JIS C9612, JIS B8616, ISO 5151(T1), en ISO 13523(T1).

**<ESPAÑOL>**

El idioma original del documento es el inglés. Las versiones en los demás idiomas son traducciones del original.

**▲ CUIDADO**

- Las pérdidas de refrigerante pueden causar asfixia. Se debe proporcionar la ventilación determinada en EN378-1.
- Asegúrese de colocar el aislante alrededor de las tuberías. El contacto directo con la tubería puede ocasionar quemaduras o congelación.
- Para evitar una ingestión accidental, no coloque las pilas en su boca bajo ningún concepto.
- La ingestión de las pilas puede causar asfixia y/o envenenamiento.
- Coloque la unidad en una estructura rígida para evitar que se produzcan sonidos o vibraciones excesivos debidos a su funcionamiento.
- La medición de los ruidos se lleva a cabo de acuerdo con JIS C9612, JIS B8616, ISO 5151(T1) y ISO 13523(T1).

**<ITALIANO>**

Il testo originale è redatto in lingua Inglese. Le altre versioni linguistiche rappresentano traduzioni dell'originale.

**▲ ATTENZIONE**

- Perdite di refrigerante possono causare asfissia. Prevedere un ventilazione adeguata in conformità alla norma EN378-1.
- Accertarsi di applicare materiale isolante intorno alle tubature. Il contatto diretto con le tubature non schermate può provocare ustioni o congelamento.
- Non introdurre in nessun caso le batterie nella bocca onde evitare ingestioni accidentali.
- L'ingestione delle batterie può provocare soffocamento e/o avvelenamento.
- Installare l'unità su di una struttura rigida in modo da evitare rumore o vibrazioni eccessivi durante il funzionamento.
- La misurazione del rumore viene effettuata in conformità agli standard JIS C9612, JIS B8616, ISO 5151(T1) e ISO 13523(T1).

**<ΕΛΛΗΝΙΚΑ>**

Η γλώσσα του πρωτοτύπου είναι η αγγλική. Οι εκδόσεις άλλων γλωσσών είναι μεταφράσεις του πρωτοτύπου.

**▲ ΠΡΟΣΟΧΗ**

- Η διαρροή του ψυκτικού ενδέχεται να προκαλέσει ασφυξία. Φροντίστε για τον εξαερισμό σύμφωνα με το EN378-1.
- Βεβαιωθείτε ότι τυλίξατε με μονωτικό υλικό τη σωλήνωση. Η απευθείας επαφή με τη γυμνή σωλήνωση ενδέχεται να προκαλέσει εγκαύματα ή κρυοπαγήματα.
- Μην βάζετε ποτέ τις μπαταρίες στο στόμα σας για κανένα λόγο ώστε να αποφύγετε την κατά λάθος κατάποσή τους.
- Η κατάποση μπαταριών ενδέχεται να προκαλέσει πνιγμό και/ή δηλητηρίαση.
- Εγκαταστήστε τη μονάδα σε σταθερή κατασκευή ώστε να αποφύγετε τον έντονο ήχο λειτουργίας ή τους κραδασμούς.
- Η μέτρηση θορύβου πραγματοποιήθηκε σύμφωνα με τα JIS C9612, JIS B8616, ISO 5151(T1) και ISO 13523(T1).

**<PORTUGUÊS>**

O idioma original é o inglês. As versões em outros idiomas são traduções do idioma original.

**▲ CUIDADO**

- As fugas de refrigerante podem provocar asfixia. Proporcione ventilação de acordo com a EN378-1.
- Certifique-se de que coloca isolamento em redor da tubagem. O contacto directo com a tubagem pode resultar em queimaduras ou úlceras causadas pelo frio.
- Para evitar uma ingestão accidental, nunca coloque pilhas na boca.
- A ingestão das pilhas pode provocar asfixia e/ou envenenamento.
- Instale a unidade numa estrutura rígida para evitar vibrações ou ruídos excessivos durante o seu funcionamento.
- A medição dos ruídos é efectuada de acordo com a JIS C9612, JIS B8616, ISO 5151(T1), e ISO 13523(T1).

**<DANSK>**

Engelsk er originalen. De andre sprogversioner er oversættelser af originalen.

**▲ FORSIGTIG**

- Køllemiddellækage kan forårsage kvælning. Sørg for ventilation i henhold til EN378-1.
- Der skal altid vikles isolering omkring rørene. Direkte kontakt med blotlagte rør kan medføre forbrænding eller forfrysning.
- Put aldrig batterier i munden uanset årsag, du kan komme til at sluge dem.
- Hvis batterier sluges, kan det medføre kvælning og/eller forgiftning.
- Monter enheden på en fast struktur, så kraftig lyd og vibration undgås.
- Støjmåling udføres i henhold til JIS C9612, JIS B8616, ISO 5151(T1) og ISO 13523(T1).

**<SVENSKA>**

Engelska är originalspråket. De övriga språkversionerna är översättningar av originalet.

**▲ FÖRSIKTIGHET**

- Köldmedelsläckage kan leda till kvävning. Tillhandahåll ventilation i enlighet med EN378-1.
- Kom ihåg att linda isolering runt rören. Direktkontakt med bara rör kan leda till brännskador eller köldskador.
- Stoppa aldrig batterier i munnen, de kan sväljas av misstag.
- Om ett batteri sväljs kan det leda till kvävning och/eller förgiftning.
- Montera enheten på ett stadigt underlag för att förhindra höga driftljud och vibrationer.
- Ljudmätningar har utförts i enlighet med JIS C9612, JIS B8616, ISO 5151(T1) och ISO 13523(T1).

**<TÜRKÇE>**

Aslı İngilizce'dir. Diğer dillerdeki sürümler aslının çevirisidir.

**▲ DİKKAT**

- Soğutucu sızıntısı boğulma tehlikesine yol açabilir. EN378-1'e göre havalandırma sağlayın.
- Boruların etrafına izolasyon malzemesi kaplamayı unutmayın. Çıplak boruya doğrudan temas etmek yanmaya ve soğuk ısırmasına neden olabilir.
- Yanlışlıkla yutmamak için pilleri hiçbir nedenle asla ağzınıza sokmayın.
- Pili yutmak boğulmaya ve/veya zehirlenmeye neden olabilir.
- Aşırı çalışma sesinin veya titreşimin oluşmaması için üniteyi sert bir yarı üzerine kurun.
- Ses ölçümü JIS C9612, JIS B8616, ISO 5151(T1), ve ISO 13523(T1) standartlarına göre yapılır.

**<РУССКИЙ>**

Языком оригинала является английский. Версии на других языках являются переводом оригинала.

**▲ ОСТОРОЖНО**

- Утечка хладагента может стать причиной удущья. Обеспечьте вентиляцию в соответствии с EN378-1.
- Обязательно оберните трубы изоляционной обмоткой. Непосредственный контакт с неизолированным трубопроводом может привести к ожогам или обморожению.
- Запрещается класть элементы питания в рот по каким бы то ни было причинам во избежание случайного проглатывания.
- Попадание элемента питания в пищеварительную систему может стать причиной удущья и/или отравления.
- Устанавливайте устройство на жесткую структуру во избежание чрезмерного шума или чрезмерной вибрации во время работы.
- Измерение шума выполняется в соответствии с JIS C9612, JIS B8616, ISO 5151(T1) и ISO 13523(T1).

**<УКРАЇНСЬКА>**

Переклад оригіналу. Текст іншими мовами є перекладом оригіналу.

**▲ ОБЕРЕЖНО**

- Виток холодоагенту може призвести до удущення. Необхідно забезпечити вентиляцію відповідно до стандарту EN 378-1.
- Труби необхідно обмотати ізоляційним матеріалом. Прямий контакт із непокритою трубою може призвести до опіку або обмороження.
- Забороняється класти елементи живлення в рот із будь-яких причин, оскільки є ризик випадково їх проковтнути.
- Попадання елемента живлення в травну систему може стати причиною задуху та/або отруєння.
- Встановлюйте блок на міцній конструкції, щоб уникнути надмірного рівня звуку роботи або вібрації.
- Вимірювання рівня шуму проводилося згідно з JIS C9612, JIS B8616, ISO 5151(T1), і ISO 13523(T1).

**<БЪЛГАРСКИ>**

Оригиналът е текстът на английски език. Версиите на други езици са преводи на оригинала.

**▲ ВНИМАНИЕ**

- Изтичането на хладилни агент може да причини задущаване. Осигурете вентилация съобразно с EN378-1.
- Не забравяйте да увиете изолация около тръбите. Директният контакт с оголени тръби може да причини изгаряне или измръзване.
- При никакви обстоятелства не поставяйте батериите в устата си, за да не ги погълнете по невнимание.
- Това може да доведе до задущаване и/или натравяне.
- Монтирайте тялото върху твърда конструкция, за да предотвратите прекомерен шум или вибрации по време на работа.
- Измерването на шума е извършено съгласно JIS C9612, JIS B8616, ISO 5151(T1) и ISO 13523(T1).



This product is designed and intended for use in the residential, commercial and light-industrial environment.

**Importer:**

Mitsubishi Electric Europe B.V.  
Capronilaan 46, 1119 NS, Schiphol Rijk, The Netherlands

French Branch  
25, Boulevard des Bouvets, 92741 Nanterre Cedex, France

German Branch  
Mitsubishi-Electric-Platz 1, 40882 Ratingen, Germany

Belgian Branch  
Autobaan 2, 8210 Loppem, Belgium

Irish Branch  
Westgate Business Park, Ballymount, Dublin 24, Ireland

Italian Branch  
Centro Direzionale Colleoni, Palazzo Sirio-Ingresso 1 Viale Colleoni 7, 20864 Agrate Brianza (MB), Italy

Norwegian Branch  
Gneisveien 2D, 1914 Ytre Enebakk, Norway

Portuguese Branch  
Avda. do Forte, 10, 2799-514, Carnaxide, Lisbon, Portugal

Spanish Branch  
Carretera de Rubi 76-80 - Apdo. 420 08173 Sant Cugat del Valles (Barcelona), Spain

Scandinavian Branch  
Hammarbacken 14, P.O. Box 750 SE-19127, Sollentuna, Sweden

UK Branch  
Travellers Lane, Hatfield, Herts., AL10 8XB, England, U.K.

Polish Branch  
Krakowska 50, PL-32-083 Balice, Poland

MITSUBISHI ELECTRIC TURKEY ELEKTRİK ÜRÜNLERİ A.Ş.  
Şerifali Mah. Kale Sok. No: 41 34775 Ümraniye, İstanbul / Turkey

MITSUBISHI ELECTRIC (RUSSIA) LLC  
115114, Russia, Moscow, Letnikovskaya street 2, bld.1, 5th floor

Please be sure to put the contact address/telephone number on this manual before handing it to the customer.



**MITSUBISHI ELECTRIC CORPORATION**

HEAD OFFICE: TOKYO BUILDING, 2-7-3, MARUNOUCHI, CHIYODA-KU, TOKYO 100-8310, JAPAN