

Air-Conditioners
INDOOR UNIT



PEFY-WP15,20,25,32,40,50 VMS1-E

INSTALLATION MANUAL

For safe and correct use, please read this installation manual thoroughly before installing the air-conditioner unit.

INSTALLATIONSHANDBUCH

Zum sicheren und ordnungsgemäßen Gebrauch der Klimageräte das Installationshandbuch gründlich durchlesen.

MANUEL D'INSTALLATION

Veuillez lire le manuel d'installation en entier avant d'installer ce climatiseur pour éviter tout accident et vous assurer d'une utilisation correcte.

MANUAL DE INSTALACIÓN

Para un uso seguro y correcto, lea detalladamente este manual de instalación antes de montar la unidad de aire acondicionado.

MANUALE DI INSTALLAZIONE

Per un uso sicuro e corretto, leggere attentamente questo manuale di installazione prima di installare il condizionatore d'aria.

INSTALLATIEHANDLEIDING

Voor een veilig en juist gebruik moet u deze installatiehandleiding grondig doorlezen voordat u de airconditioner installeert.

MANUAL DE INSTALAÇÃO

Para segurança e utilização correctas, leia atentamente este manual de instalação antes de instalar a unidade de ar condicionado.

ΕΓΧΕΙΡΙΔΙΟ ΟΔΗΓΙΩΝ ΕΓΚΑΤΑΣΤΑΣΗΣ

Για ασφάλεια και σωστή χρήση, παρακαλείστε διαβάσετε προσεκτικά αυτό το εγχειρίδιο εγκατάστασης πριν αρχίσετε την εγκατάσταση της μονάδας κλιματισμού.

РУКОВОДСТВО ПО УСТАНОВКЕ

Для осторожного и правильного использования прибора необходимо тщательно ознакомиться с данным руководством по установке до выполнения установки кондиционера.

MONTAJ ELKİTABI

Emniyetli ve doğru biçimde nasıl kullanılacağını öğrenmek için lütfen klima cihazını monte etmeden önce bu elkitabını dikkatle okuyunuz.

PŘÍRUČKA K INSTALACI

V zájmu bezpečného a správného používání si před instalací klimatizační jednotky důkladně pročtěte tuto příručku k instalaci.

NÁVOD NA INŠTALÁCIU

Pre bezpečné a správne použitie si pred inštalovaním klimatizačnej jednotky, prosím, starostlivo prečítajte tento návod na inštaláciu.

TELEPÍTÉSI KÉZIKÖNYV

A biztonságos és helyes használatához, kérjük, olvassa el alaposan ezt a telepítési kézikönyvet, mielőtt telepítené a légkondicionáló egységet.

PODRĘCZNIK INSTALACJI

W celu bezpiecznego i poprawnego korzystania należy przed zainstalowaniem klimatyzatora dokładnie zapoznać się z niniejszym podręcznikiem instalacji.

PRIROČNIK ZA NAMESTITEV

Za varno in pravilno uporabo pred namestitvijo klimatske naprave skrbno preberite priročnik za namestitev.

INSTALLATIONSHANDBOK

Läs den här installationshandboken noga innan luftkonditioneringsenheten installeras, för säker och korrekt användning.

PRIRUČNIK ZA UGRADNJU

Radi sigurne i ispravne uporabe, temeljito pročítajte ovaj priručnik prije ugradnje klimatizacijskog uređaja.

РЪКОВОДСТВО ЗА МОНТАЖ

За безопасна и правилна употреба, моля, прочетете внимателно това ръководство преди монтажа на климатизатора.

MANUAL CU INSTRUCȚIUNI DE INSTALARE

Pentru o utilizare corectă și sigură, vă rugăm să citiți cu atenție acest manual înainte de a instala unitatea de aer condiționat.

GB**D****F****E****I****NL****P****GR****RU****TR****CZ****SV****HG****PO****SL****SW****HR****BG****RO**

1 **1.4**

[Fig. 1-4-1]

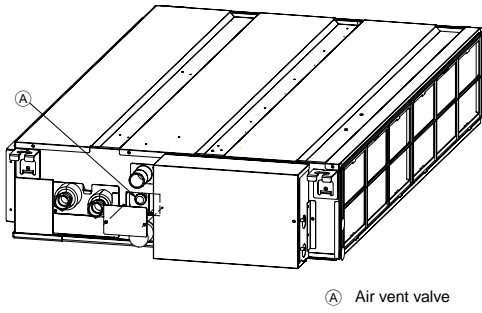

(A) Air vent valve

[Fig. 3-1-1]

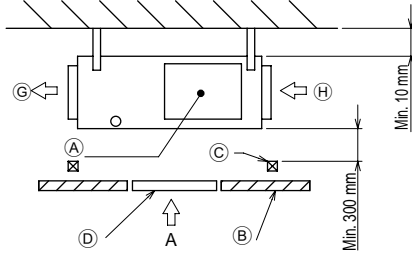

[Fig. 3-1-3]

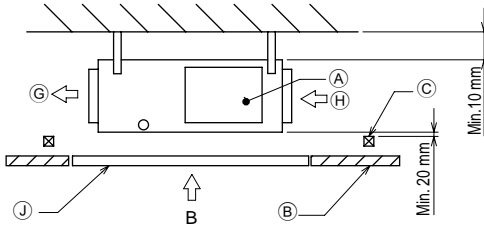

[Fig. 3-1-5]

(Viewed from the direction of the arrow B)

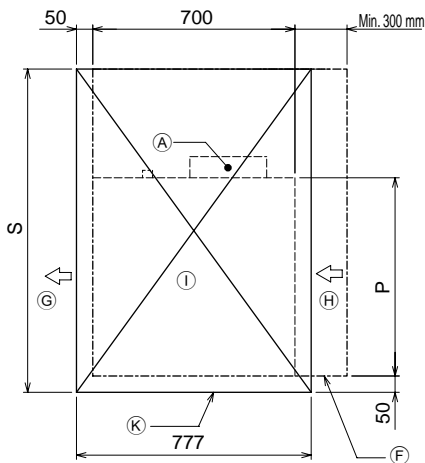

3 **3.1**

[Fig. 3-1-2]

(Unit: mm)

(Viewed from the direction of the arrow A)

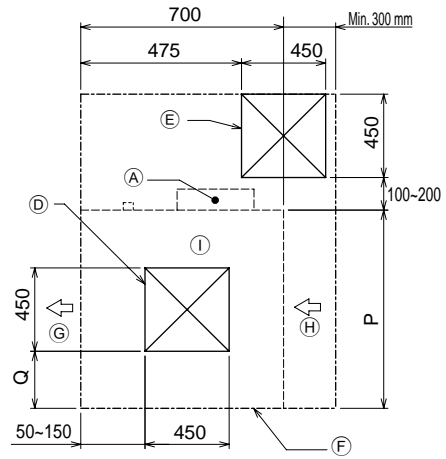

[Fig. 3-1-4]

(Viewed from the direction of the arrow B)

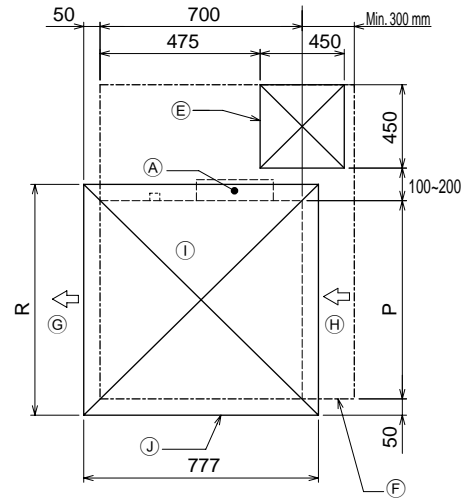

- (A) Electric box
- (B) Ceiling
- (C) Ceiling beam
- (D) Access door 2 (450 mm x 450 mm)
- (E) Access door 1 (450 mm x 450 mm)
- (F) Maintenance access space
- (G) Supply air
- (H) Intake air
- (I) Bottom of indoor unit
- (J) Access door 3
- (K) Access door 4

(mm)

Model	P	Q	R	S
PEFY-WP15,20,25VMS1-E	700	50~150	800	1300
PEFY-WP32,40VMS1-E	900	150~250	1000	1500
PEFY-WP50VMS1-E	1100	250~350	1200	1700

4 **4.1**

[Fig. 4.1.1]

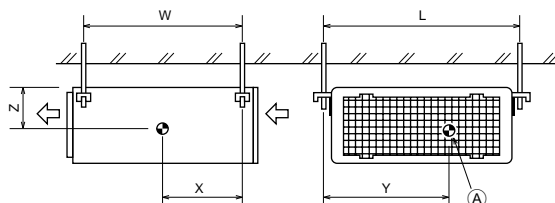

(A) Center of gravity

5

5.1

[Fig. 5.1.1]

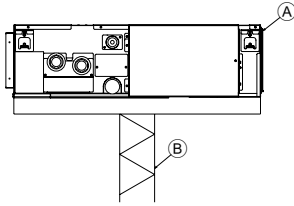

- (A) Unit body
- (B) Lifting machine

[Fig. 5.1.2]

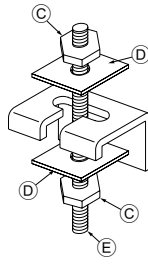

- (C) Nuts (field supply)
- (D) Washers (accessory)
- (E) M10 hanging bolt (field supply)

5.2

[Fig. 5.2.1]

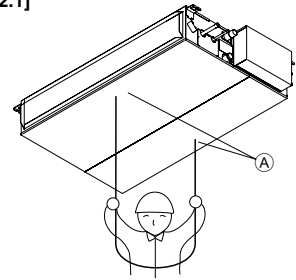

- (A) Indoor unit's bottom surface

6

6.2

[Fig. 6.2.1]

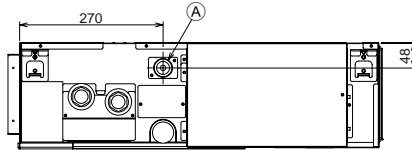

- (A) Drain pipe (O.D. ø32)

6.3

[Fig. 6.3.1]

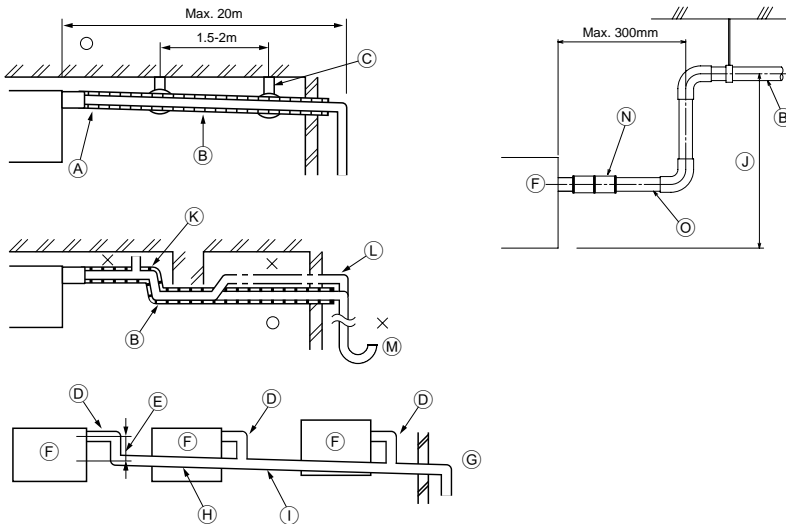

- Correct piping
 - × Wrong piping
 - (A) Insulation (9 mm or more)
 - (B) Downward slope (1/100 or more)
 - (C) Support metal
 - (K) Air bleeder
 - (L) Raised
 - (M) Odor trap
- Grouped piping
- (D) O. D. ø32 PVC TUBE
 - (E) Make it as large as possible. About 10 cm.
 - (F) Indoor unit
 - (G) Make the piping size large for grouped piping.
 - (H) Downward slope (1/100 or more)
 - (I) O. D. ø38 PVC TUBE for grouped piping. (9 mm or more insulation)
 - (J) Up to 550 mm
 - (N) Drain hose (accessory)
 - (O) Horizontal or slightly upgradient

[Fig. 6.3.2]

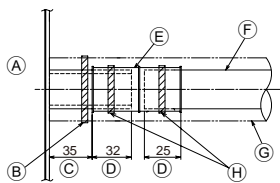

- (A) Indoor unit
- (B) Tie band (accessory)
- (C) Visible part
- (D) Insertion margin
- (E) Drain hose (accessory)
- (F) Drain pipe (O.D. ø32 PVC TUBE, field supply)
- (G) Insulating material (field supply)
- (H) Tie band (accessory)

6.4

[Fig. 6.4.1]

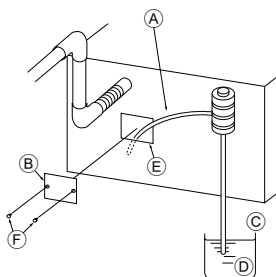

- (A) Insert pump's end 2 to 4 cm.
- (B) Remove the water supply port.
- (C) About 2000 cc
- (D) Water
- (E) Filling port
- (F) Screw

[Fig. 6.4.2]

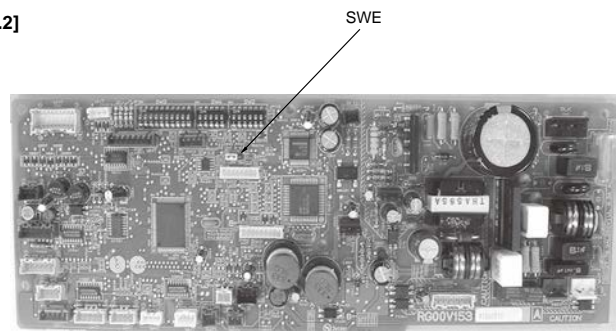

<Indoor controller board>

[Fig. 7.2.1]

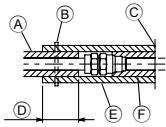

- (A) Locally procured insulating material for pipes
- (B) Bind here using band or tape.
- (C) Do not leave any opening.
- (D) Lap margin: more than 40 mm
- (E) Insulating material (field supply)
- (F) Unit side insulating material

[Fig. 7.2.2]

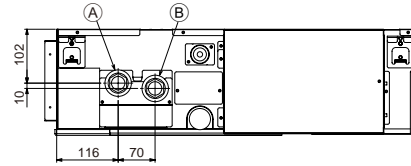

- (A) Water pipe: To HBC unit
- (B) Water pipe: From HBC unit

[Fig. 7.2.3]

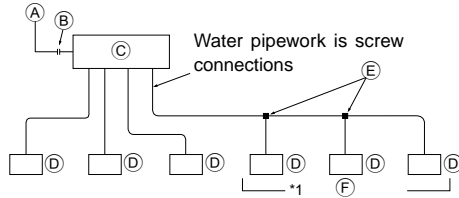

Water pipework is screw connections

- (A) To outdoor unit
- (B) End connection (brazing)
- (C) HBC controller
- (D) Indoor unit
- (E) Twinning pipe (field supply)
- (F) Up to three units for 1 branch hole; total capacity: below 80 (but in same mode, cooling/heating)

Note:

***1. Connection of multiple indoor units with one connection (or joint pipe)**

- Total capacity of connectable indoor units: Less than 80
- Number of connectable indoor units: Maximum 3 Sets
- Selection of water piping
Select the size according to the total capacity of indoor units to be installed downstream.
- Please group units that operate on 1 branch.

[Fig. 7.2.4]

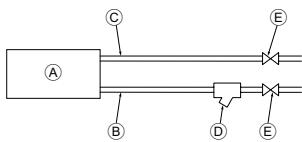

- (A) Indoor unit
- (B) Water pipe: From HBC unit
- (C) Water pipe: To HBC unit
- (D) Strainer (40 mesh or more) (field supply)
- (E) Shut off valve (field supply)

[Fig. 8.0.1]

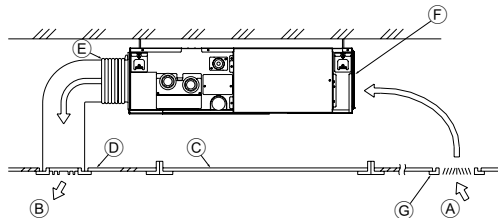

- (A) Air inlet
- (B) Air outlet
- (C) Access door
- (D) Ceiling surface
- (E) Canvas duct
- (F) Air filter
- (G) Inlet grille

[Fig. 9.1.1]

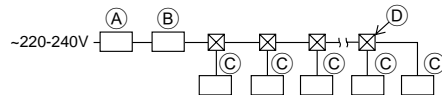

- (A) Ground-fault interrupter
- (B) Local switch/Wiring breaker
- (C) Indoor unit
- (D) Pull box

[Fig. 9.2.1]

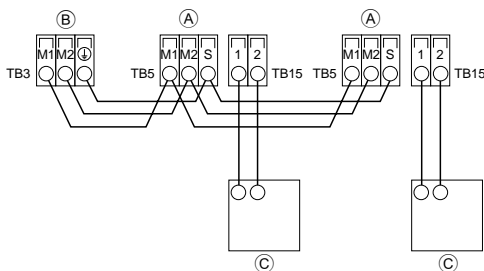

[Fig. 9.2.2]

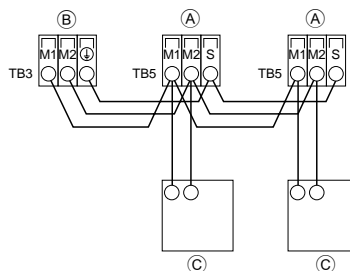

- (A) Terminal block for indoor transmission cable
- (B) Terminal block for outdoor transmission cable
- (C) Remote controller

9.2

[Fig. 9.2.3]

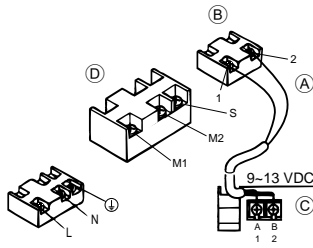

[Fig. 9.2.4]

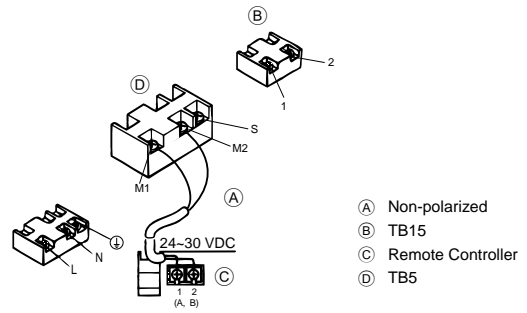

- (A) Non-polarized
- (B) TB15
- (C) Remote Controller
- (D) TB5

9.3

[Fig. 9.3.1]

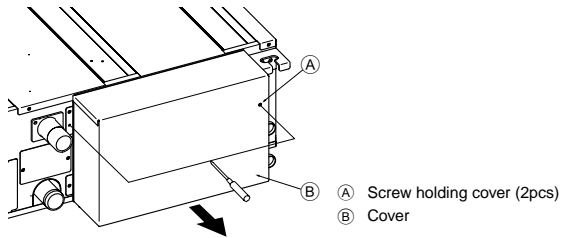

- (A) Screw holding cover (2pcs)
- (B) Cover

[Fig. 9.3.2]

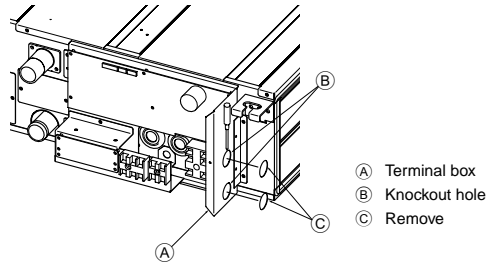

- (A) Terminal box
- (B) Knockout hole
- (C) Remove

[Fig. 9.3.3]

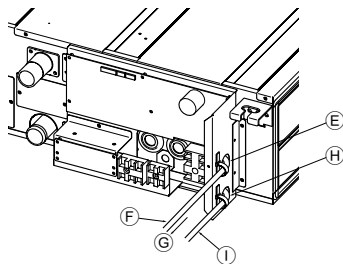

- (E) Use PG bushing to keep the weight of the cable and external force from being applied to the power supply terminal connector. Use a cable tie to secure the cable.
- (F) Power source wiring
- (G) Tensile force
- (H) Use ordinary bushing
- (I) Transmission wiring

[Fig. 9.3.4]

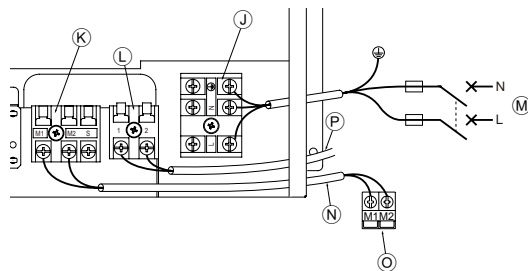

- (J) Power source terminal block
- (K) Terminal block for indoor transmission
- (L) Terminal block for remote controller
- (M) To 1-phase power source
- (N) Transmission line 30 VDC
- (O) Terminal block for outdoor transmission line (TB3)
- (P) Transmission line to the remote controller, terminal block for indoor unit and BC controller

[Fig. 9.3.5]

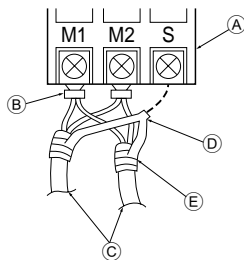

- (A) Terminal block
- (B) Round terminal
- (C) Shield wire
- (D) The earth wire from two cables are connected together to the S terminal. (Dead-end connection)
- (E) Insulation tape (To keep the earth wire of the shielded cable from coming in contact with the transmission terminal)

9.5

[Fig. 9.5.1]

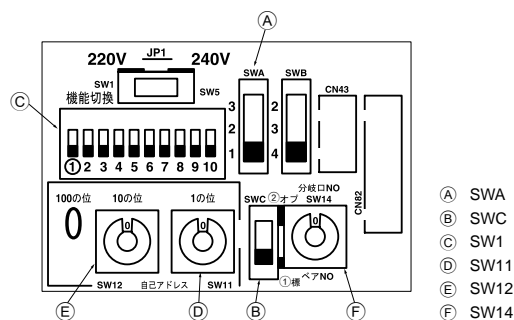

<Address board>

- (A) SWA
- (B) SWC
- (C) SW1
- (D) SW11
- (E) SW12
- (F) SW14

Contents

1. Safety precautions.....	6	6.3. Drain piping work.....	8
1.1. Before installation and electric work	6	6.4. Confirming drain discharge.....	9
1.2. Before getting installed	6	7. Connecting water pipes.....	9
1.3. Before getting installed (moved) - electrical work	7	7.1. Important notes on water pipework installation.....	9
1.4. Before starting the test run	7	7.2. Water pipe insulation	9
2. Indoor unit accessories	7	7.3. Water treatment and quality control	10
3. Selecting an installation site.....	7	8. Duct work	10
3.1. Install the indoor unit on a ceiling strong enough to sustain its weight.....	7	9. Electrical wiring	11
3.2. Securing installation and service space.....	8	9.1. Power supply wiring	11
3.3. Combining indoor units with outdoor units	8	9.2. Connecting remote controller, indoor and outdoor transmission cables	12
4. Fixing hanging bolts	8	9.3. Connecting electrical connections	12
4.1. Fixing hanging bolts	8	9.4. External I/O specifications	12
5. Installing the unit	8	9.5. Selecting the external static pressure	12
5.1. Hanging the unit body	8	9.6. Setting addresses	13
5.2. Confirming the unit's position and fixing hanging bolts	8	9.7. Sensing room temperature with the built-in sensor in a remote controller.....	13
6. Connecting drain pipe	8	9.8. Electrical characteristics	13
6.1. Drain pipe specifications.....	8		
6.2. Drain pipe.....	8		

1. Safety precautions

1.1. Before installation and electric work

- ▶ Before installing the unit, make sure you read all the “Safety precautions”.
- ▶ The “Safety precautions” provide very important points regarding safety. Make sure you follow them.

Symbols used in the text





Warning:

Describes precautions that should be observed to prevent danger of injury or death to the user.

Caution:

Describes precautions that should be observed to prevent damage to the unit.

Symbols used in the illustrations

-  : Indicates an action that must be avoided.
-  : Indicates that important instructions must be followed.
-  : Indicates a part which must be grounded.
-  : Indicates that caution should be taken with rotating parts. (This symbol is displayed on the main unit label.) <Color: Yellow>
-  : Beware of electric shock (This symbol is displayed on the main unit label.) <Color: Yellow>

Warning:

Carefully read the labels affixed to the main unit.

Warning:

- Ask the dealer or an authorized technician to install the air conditioner.
 - Improper installation by the user may result in water leakage, electric shock, or fire.
- This appliance is not intended for use by persons (including children) with reduced physical, sensory or mental capabilities, or lack of experience and knowledge, unless they have been given supervision or instruction concerning use of the appliance by a person responsible for their safety.
- Install the air unit at a place that can withstand its weight.
 - Inadequate strength may cause the unit to fall down, resulting in injuries.
- Use the specified cables for wiring. Make the connections securely so that the outside force of the cable is not applied to the terminals.
 - Inadequate connection and fastening may generate heat and cause a fire.
- Prepare for typhoons and other strong winds and earthquakes and install the unit at the specified place.
 - Improper installation may cause the unit to topple and result in injury.
- Always use an air cleaner, humidifier, electric heater, and other accessories specified by Mitsubishi Electric.
 - Ask an authorized technician to install the accessories. Improper installation by the user may result in water leakage, electric shock, or fire.
- Never repair the unit. If the air conditioner must be repaired, consult the dealer.
 - If the unit is repaired improperly, water leakage, electric shock, or fire may result.

- If the supply cord is damaged, it must be replaced by the manufacturer, its service agent or similarly qualified persons in order to avoid a hazard.
- Do not touch the heat exchanger fins.
 - Improper handling may result in injury.
- When handling this product, always wear protective equipment.
EG: Gloves, full arm protection namely boiler suit, and safety glasses.
 - Improper handling may result in injury.
- Install the air conditioner according to this Installation Manual.
 - If the unit is installed improperly, water leakage, electric shock, or fire may result.
- Have all electric work done by a licensed electrician according to “Electric Facility Engineering Standard” and “Interior Wire Regulations” and the instructions given in this manual and always use a special circuit.
 - If the power source capacity is inadequate or electric work is performed improperly, electric shock and fire may result.
- Keep the electric parts away from water (washing water etc.).
 - It might result in electric shock, catching fire or smoke.
- Securely install the outdoor unit terminal cover (panel).
 - If the terminal cover (panel) is not installed properly, dust or water may enter the outdoor unit and fire or electric shock may result.
- When moving and reinstalling the air conditioner, consult the dealer or an authorized technician.
 - If the air conditioner is installed improperly, water leakage, electric shock, or fire may result.
- Do not reconstruct or change the settings of the protection devices.
 - If the pressure switch, thermal switch, or other protection device is shorted and operated forcibly, or parts other than those specified by Mitsubishi Electric are used, fire or explosion may result.
- To dispose of this product, consult your dealer.
- Do not use a leak detection additive.

1.2. Before getting installed

Caution:

- Do not use the air conditioner where food, pets, plants, precision instruments, or artwork are kept.
 - The quality of the food, etc. may deteriorate.
- Do not use the air conditioner in special environments.
 - Oil, steam, sulfuric smoke, etc. can significantly reduce the performance of the air conditioner or damage its parts.
- When installing the unit in a hospital, communication station, or similar place, provide sufficient protection against noise.
 - The inverter equipment, private power generator, high-frequency medical equipment, or radio communication equipment may cause the air conditioner to operate erroneously, or fail to operate. On the other hand, the air conditioner may affect such equipment by creating noise that disturbs medical treatment or image broadcasting.
- Do not install the unit on a structure that may cause leakage.
 - When the room humidity exceeds 80 % or when the drain pipe is clogged, condensation may drip from the indoor unit. Perform collective drainage work together with the outdoor unit, as required.
- The indoor models should be installed the ceiling over than 2.5 m from floor.

1.3. Before getting installed (moved) - electrical work

⚠ Caution:

- **Ground the unit.**
 - Do not connect the ground wire to gas or water pipes, lightning rods, or telephone ground lines. Improper grounding may result in electric shock.
- **Install the power cable so that tension is not applied to the cable.**
 - Tension may cause the cable to break and generate heat and cause a fire.
- **Install an leak circuit breaker, as required.**
 - If an leak circuit breaker is not installed, electric shock may result.
- **Use power line cables of sufficient current carrying capacity and rating.**
 - Cables that are too small may leak, generate heat, and cause a fire.
- **Use only a circuit breaker and fuse of the specified capacity.**
 - A fuse or circuit breaker of a larger capacity or a steel or copper wire may result in a general unit failure or fire.
- **Do not wash the air conditioner units.**
 - Washing them may cause an electric shock.
- **Be careful that the installation base is not damaged by long use.**
 - If the damage is left uncorrected, the unit may fall and cause personal injury or property damage.
- **Install the drain piping according to this Installation Manual to ensure proper drainage. Wrap thermal insulation around the pipes to prevent condensation.**
 - Improper drain piping may cause water leakage and damage to furniture and other possessions.
- **Be very careful about product transportation.**
 - Only one person should not carry the product if it weighs more than 20 kg.
 - Some products use PP bands for packaging. Do not use any PP bands for a means of transportation. It is dangerous.
 - Do not touch the heat exchanger fins. Doing so may cut your fingers.
 - When transporting the outdoor unit, suspend it at the specified positions on the unit base. Also support the outdoor unit at four points so that it cannot slip sideways.

- **Safely dispose of the packing materials.**
 - Packing materials, such as nails and other metal or wooden parts, may cause stabs or other injuries.
 - Tear apart and throw away plastic packaging bags so that children will not play with them. If children play with a plastic bag which was not torn apart, they face the risk of suffocation.

1.4. Before starting the test run

⚠ Caution:

- **Turn on the power at least 12 hours before starting operation.**
 - Starting operation immediately after turning on the main power switch can result in severe damage to internal parts. Keep the power switch turned on during the operational season.
- **Do not touch the switches with wet fingers.**
 - Touching a switch with wet fingers can cause electric shock.
- **Do not operate the air conditioner with the panels and guards removed.**
 - Rotating, hot, or high-voltage parts can cause injuries.
- **Do not turn off the power immediately after stopping operation.**
 - Always wait at least five minutes before turning off the power. Otherwise, water leakage and trouble may occur.
- **When water has been supplied to the water pipework, purge the system of air. The details of air purging can be found separately in the water circuit maintenance manual.**
 - Details are described in section [9] "Instructions for debris removal operation" under chapter IX Troubleshooting in the Service Handbook for the HBC.
 - Refer to Fig. 1-4-1 for the position of the air vent valve on the indoor unit.

2. Indoor unit accessories

The unit is provided with the following accessories:

Part No.	Accessories	Qty
1	Tie band	4
2	Drain hose	1
3	Washer	8

3. Selecting an installation site

- Select a site with sturdy fixed surface sufficiently durable against the weight of unit.
- Before installing unit, the routing to carry in unit to the installation site should be determined.
- Select a site where the unit is not affected by entering air.
- Select a site where the flow of supply and return air is not blocked.
- Select a site where water piping can easily be led to the outside.
- Select a site which allows the supply air to be distributed fully in room.
- Do not install unit at a site with oil splashing or steam in much quantity.
- Do not install unit at a site where combustible gas may generate, flow in, stagnate or leak.
- Do not install unit at a site where equipment generating high frequency waves (a high frequency wave welder for example) is provided.
- Do not install unit at a site where fire detector is located at the supply air side. (Fire detector may operate erroneously due to the heated air supplied during heating operation.)
- When special chemical product may scatter around such as site chemical plants and hospitals, full investigation is required before installing unit. (The plastic components may be damaged depending on the chemical product applied.)
- If the unit is run for long hours when the air above the ceiling is at high temperature/high humidity (due point above 26 °C), due condensation may be produced in the indoor unit. When operating the units in this condition, add insulation material (10-20 mm) to the entire surface of the indoor unit to avoid due condensation.

- (1) When a space of 300 mm or more is available below the unit between the unit and the ceiling (Fig. 3-1-1)
 - Create access door 1 and 2 (450 x 450 mm each) as shown in Fig. 3-1-2. (Access door 2 is not required if enough space is available below the unit for a maintenance worker to work in.)
- (2) When a space of less than 300 mm is available below the unit between the unit and the ceiling (At least 20 mm of space should be left below the unit as shown in Fig. 3-1-3.)
 - Create access door 1 diagonally below the electric box and access door 3 below the unit as shown in Fig. 3-1-4.
 - or
 - Create access door 4 below the electric box and the unit as shown in Fig. 3-1-5.

[Fig. 3-1-1] (P.2)

[Fig. 3-1-2] (Viewed from the direction of the arrow A) (P.2)

[Fig. 3-1-3] (P.2)

[Fig. 3-1-4] (Viewed from the direction of the arrow B) (P.2)

[Fig. 3-1-5] (Viewed from the direction of the arrow B) (P.2)

- | | |
|-------------------------------------|-------------------------------------|
| (A) Electric box | (B) Ceiling |
| (C) Ceiling beam | (D) Access door 2 (450 mm x 450 mm) |
| (E) Access door 1 (450 mm x 450 mm) | (F) Maintenance access space |
| (G) Supply air | (H) Intake air |
| (I) Bottom of indoor unit | (J) Access door 3 |
| (K) Access door 4 | |

⚠ Warning:

The unit must be securely installed on a structure that can sustain its weight. If the unit is mounted on an unstable structure, it may fall down causing injuries.

3.1. Install the indoor unit on a ceiling strong enough to sustain its weight

Secure enough access space to allow for the maintenance, inspection, and replacement of the motor, fan, drain pump, heat exchanger, and electric box in one of the following ways.

Select an installation site for the indoor unit so that its maintenance access space will not be obstructed by beams or other objects.

3.2. Securing installation and service space

- Select the optimum direction of supply airflow according to the configuration of the room and the installation position.
- As the piping and wiring are connected at the bottom and side surfaces, and the maintenance is made at the same surfaces, allow a proper space properly. For the efficient suspension work and safety, provide a space as much as possible.

3.3. Combining indoor units with outdoor units

For combining indoor units with outdoor units, refer to the outdoor unit installation manual.

4. Fixing hanging bolts

4.1. Fixing hanging bolts

[Fig. 4.1.1] (P.2)

- (A) Center of gravity

(Give site of suspension strong structure.)

Center of gravity and Product Weight

Model name	W	L	X	Y	Z	Product Weight (kg)
PEFY-WP15VMS1-E	625	752	263	338	105	19
PEFY-WP20VMS1-E	625	752	263	338	105	20
PEFY-WP25VMS1-E	625	752	263	338	105	20
PEFY-WP32VMS1-E	625	952	280	422	104	25
PEFY-WP40VMS1-E	625	952	280	422	104	25
PEFY-WP50VMS1-E	625	1152	285	511	104	27

Hanging structure

- Ceiling: The ceiling structure varies from building to one another. For detailed information, consult your construction company.
- If necessary, reinforce the hanging bolts with anti-quake supporting members as countermeasures against earthquakes.
* Use M10 for hanging bolts and anti-quake supporting members (field supply).

5. Installing the unit

5.1. Hanging the unit body

- ▶ Bring the indoor unit to an installation site as it is packed.
- ▶ To hang the indoor unit, use a lifting machine to lift and pass through the hanging bolts.

[Fig. 5.1.1] (P.3)

- (A) Unit body
(B) Lifting machine

[Fig. 5.1.2] (P.3)

- (C) Nuts (field supply)
(D) Washers (accessory)
(E) M10 hanging bolt (field supply)

5.2. Confirming the unit's position and fixing hanging bolts

- ▶ Use the gage supplied with the panel to confirm that the unit body and hanging bolts are positioned in place. If they are not positioned in place, it may result in dew drops due to wind leak. Be sure to check the positional relationship.
- ▶ Use a level to check that the surface indicated by (A) is at level. Ensure that the hanging bolt nuts are tightened to fix the hanging bolts.
- ▶ To ensure that drain is discharged, be sure to hang the unit at level using a level.

[Fig. 5.2.1] (P.3)

- (A) Indoor unit's bottom surface



Caution:

Install the unit in horizontal position. If the side with drain port is installed higher, water leakage may be caused.

6. Connecting drain pipe

To avoid dew drops, provide sufficient antisweating and insulating work to the drain pipes.

6.1. Drain pipe specifications

Item	Model	PFFY-WP-VMS1-E
		15 · 20 · 25 · 32 · 40 · 50
Drain pipe		O. D. ø 20

6.2. Drain pipe

[Fig. 6.2.1] (P.3)

- (A) Drain pipe (O.D. ø32)

6.3. Drain piping work

- Ensure that the drain piping is downward (pitch of more than 1/100) to the outdoor (discharge) side. Do not provide any trap or irregularity on the way.
- Ensure that any cross-wise drain piping is less than 20 m (excluding the difference of elevation). If the drain piping is long, provide metal braces to prevent it from waving. Never provide any air vent pipe. Otherwise drain may be ejected.
- Use a hard vinyl chloride pipe VP-25 (with an external diameter of 32 mm) for drain piping.
- Ensure that collected pipes are 10 cm lower than the unit body's drain port.
- Do not provide any odor trap at the drain discharge port.
- Put the end of the drain piping in a position where no odor is generated.
- Do not put the end of the drain piping in any drain where ionic gases are generated.

[Fig. 6.3.1] (P.3)

- Correct piping
- × Wrong piping
- (A) Insulation (9 mm or more)
- (B) Downward slope (1/100 or more)
- (C) Support metal
- (K) Air bleeder
- (L) Raised
- (M) Odor trap

Grouped piping

- (D) O. D. ø32 PVC TUBE
- (E) Make it as large as possible. About 10 cm.
- (F) Indoor unit
- (G) Make the piping size large for grouped piping.
- (H) Downward slope (1/100 or more)
- (I) O. D. ø38 PVC TUBE for grouped piping. (9 mm or more insulation)
- (J) Up to 550 mm
- (N) Drain hose (accessory)
- (O) Horizontal or slightly upgradient

1. Insert the drain hose (accessory) into the drain port (insertion margin: 25 mm).
(The drain hose must not be bent more than 45° to prevent the hose from breaking or clogging.)
(Attach the hose with glue, and fix it with the band (small, accessory).)
2. Attach the drain pipe (O.D. ø32 PVC TUBE, field supply).
(Attach the pipe with glue for the hard vinyl chloride pipe, and fix it with the band (small, accessory).)

3. Perform insulation work on the drain pipe (O.D. $\varnothing 32$ PVC TUBE) and on the socket (including elbow).
4. Check the drainage. (Refer to [Fig. 6.4.1])
5. Attach the insulating material (accessory), and fix it with the band (large, accessory) to insulate the drain port.

[Fig. 6.3.2] (P.3)

- (A) Indoor unit
- (B) Tie band (accessory)
- (C) Visible part
- (D) Insertion margin
- (E) Drain hose (accessory)
- (F) Drain pipe (O.D. $\varnothing 32$ PVC TUBE, field supply)
- (G) Insulating material (field supply)
- (H) Tie band (accessory)

6.4. Confirming drain discharge

► Make sure that the drain-up mechanism operates normally for discharge and that there is no water leakage from the connections.

- Be sure to confirm the above in a period of heating operation.
 - Be sure to confirm the above before ceiling work is done in the case of a new construction.
1. Remove the water supply port cover on the same side as the indoor unit piping.
 2. Fill water into the feed water pump using a feed water tank. In filling, be sure to put the end of the pump or tank in a drain pan. (If the insertion is incomplete, water may flow over the machine.)

3. Perform the test run in cooling mode, or connect the connector to the ON side of SWE on the Indoor controller board. (The drain pump and the fan are forced to operate without any remote controller operation.) Make sure using a transparent hose that drain is discharged.

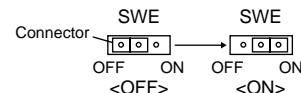

4. After confirmation, cancel the test run mode, and turn off the main power. If the connector is connected to the ON side of SWE, disconnect it and connect it to the OFF side, and attach the water supply port cover into its original position.

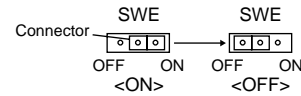

[Fig. 6.4.1] (P.3)

- (A) Insert pump's end 2 to 4 cm.
- (B) Remove the water supply port.
- (C) About 2000 cc
- (D) Water
- (E) Filling port
- (F) Screw

[Fig. 6.4.2] (P.3)

<Indoor controller board>

7. Connecting water pipes

Please observe the following precautions during installation.

7.1. Important notes on water pipework installation

- The water pressure resistance of the water pipes in the heat source unit is 1.0 MPa [145 psi].
- Please connect the water pipework of each indoor unit to the connect port on the HBC. Failure to do so will result in incorrect running.
- Please list the indoor units on the naming plate in the HBC unit with addresses and end connection numbers.
- If the number of indoor units are less than the number of ports on the HBC, the unused ports can be capped. Without a cap, water will leak.
- Use the reverse-return method to insure proper pipe resistance to each unit.
- Provide some joints and bulbs around inlet/outlet of each unit for easy maintenance, checkup, and replacement.
- Install a suitable air vent on the water pipe. After flowing water through the pipe, vent any excess air.
- Secure the pipes with metal fitting, positioning them in locations to protect pipes against breakage and bending.
- Do not confuse the water intake and outlet piping. Error code 5102 will appear on the remote controller if a test run is performed with the pipe-work installed incorrectly (inlet connected to outlet and vice versa).
- This unit doesn't include a heater to prevent freezing within tubes. If the water flow is stopped on low ambient, drain the water out.
- The unused knockout holes should be closed and the refrigerant pipes, water pipes, power source and transmission wires access holes should be filled with putty.
- Install water pipe so that the water flow rate will be maintained.
- Wrap sealing tape as follows.
 - ① Wrap the joint with sealing tape following the direction of the threads (clockwise), do not wrap the tape over the edge.
 - ② Overlap the sealing tape by two-thirds to three-fourths of its width on each turn. Press the tape with your fingers so that it is tight against each thread.
 - ③ Do not wrap the 1.5th through 2nd farthest threads away from the pipe end.
- Hold the pipe on the unit side in place with a spanner when installing the pipes or strainer. Tighten screws to a torque of 40 N·m.
- If there is a risk of freezing, carry out a procedure to prevent it.
- When connecting heat source unit water piping and on site water piping, apply liquid sealing material for water piping over the sealing tape before connection.
- Do not use steel pipes as water pipes.
 - Copper pipes are recommended.
- Install a strainer (40 mesh or more) on the pipe next to the valve to remove the foreign matters.
- Be sure to provide anti-dew condensation treatment on the inlet and outlet of the water pipes and on the valve. Provide an appropriate treatment on the end surface of the dew proofing material to keep condensation out.

- When water has been supplied to the water pipework, purge the system of air. The details of air purging can be found separately in the water circuit maintenance manual.

7.2. Water pipe insulation

1. Connect the water pipes of each indoor unit to the same (correct) end connection numbers as indicated on the indoor unit connection section of each HBC controller. If connected to wrong end connection numbers, there will be no normal operation.
2. List indoor unit model names in the name plate on the HBC controller control box (for identification purposes), and HBC controller end connection numbers and address numbers in the name plate on the indoor unit side. Seal unused end connections using cover caps (sold separately). Not replacing on end cap will lead to water leakage.
3. Be sure to add insulation work to water piping by covering water pipework separately with enough thickness heat-resistant polyethylene, so that no gap is observed in the joint between indoor unit and insulating material, and insulating materials themselves. When insulation work is insufficient, there is a possibility of condensation, etc. Pay special attention to insulation work in the ceiling plenum.

[Fig. 7.2.1] (P.4)

- (A) Locally procured insulating material for pipes
- (B) Bind here using band or tape.
- (C) Do not leave any opening.
- (D) Lap margin: more than 40 mm
- (E) Insulating material (field supply)
- (F) Unit side insulating material

[Fig. 7.2.2] (P.4)

- (A) Water pipe: To HBC unit
- (B) Water pipe: From HBC unit

- Insulation materials for the pipes to be added on site must meet the following specifications:

HBC controller	20 mm or more
-indoor unit	

- This specification is based on copper for water piping. When using plastic pipework, choose a thickness based on the plastic pipe performance.
 - Installation of pipes in a high-temperature high-humidity environment, such as the top floor of a building, may require the use of insulation materials thicker than the ones specified in the chart above.
 - When certain specifications presented by the client must be met, ensure that they also meet the specifications on the chart above.
4. Expansion tank

Install an expansion tank to accommodate expanded water. (circuit protection valve set pressure: 600 kPa)

Expansion tank selection criteria:

 - The water containment volume of the HBC.
 - The maximum water temperature is 60°C.
 - The minimum water temperature is 5°C.
 - The circuit protection valve set pressure is 370-490 kPa.
 - The circulation pump head pressure is 0.24 MPa.

5. Leakproof the water pipework, valves and drain pipework. Leakproof all the way to, and include pipe ends so that condensation cannot enter the insulated pipework.
6. Apply caulking around the ends of the insulation to prevent condensation getting between the pipework and insulation.
7. Add a drain valve so that the unit and pipework can be drained.
8. Ensure there are no gaps in the pipework insulation. Insulate the pipework right up to the unit.
9. Ensure that the gradient of the drain pan pipework is such that discharge can only blow out.

10. HBC water pipe connection sizes

Unit model	Connection size		Pipe size		Water volume (l)
	Water inlet	Water outlet	Water out	Water return	
PEFY-WP15VMS1-E	Rc 3/4 screw	Rc 3/4 screw	Inner diameter ≥ 20 mm	Inner diameter ≥ 20 mm	0.7
PEFY-WP20VMS1-E					0.9
PEFY-WP25VMS1-E					0.9
PEFY-WP32VMS1-E					1.0
PEFY-WP40VMS1-E					1.0
PEFY-WP50VMS1-E					1.7

[Fig. 7.2.3] (P.4)

- (A) To outdoor unit
- (B) End connection (brazing)
- (C) HBC controller
- (D) Indoor unit
- (E) Twinning pipe (field supply)
- (F) Up to three units for 1 branch hole; total capacity: below 80 (but in same mode, cooling/heating)

Note:

***1. Connection of multiple indoor units with one connection (or joint pipe)**

- Total capacity of connectable indoor units: Less than 80
- Number of connectable indoor units: Maximum 3 Sets
- Selection of water piping
Select the size according to the total capacity of indoor units to be installed downstream.
- Please group units that operate on 1 branch.

11. Please refer to the [Fig. 7.2.4] when connecting the water supply.

[Fig. 7.2.4] (P.4)

- (A) Indoor unit
- (B) Water pipe: From HBC unit
- (C) Water pipe: To HBC unit
- (D) Strainer (40 mesh or more) (field supply)
- (E) Shut off valve (field supply)

12. Install a shut off valve and strainer in a place that is easy to operate and makes maintenance work easy.
13. Apply insulation to the indoor unit pipework, strainer, shut off valve, and pressure reducing valve.
14. Please do not use a corrosion inhibitor in the water system.

7.3. Water treatment and quality control

To preserve water quality, use the closed type of water circuit. When the circulating water quality is poor, the water heat exchanger can develop scales, leading to a reduction in heat-exchange power and possible corrosion. Pay careful attention to water processing and water quality control when installing the water circulation system.

- Removing of foreign objects or impurities within the pipes
During installation, make sure that foreign objects, such as welding fragments, sealant particles, or rust, do not enter the pipes.
- Water Quality Processing
 - ① Depending on the quality of the cold-temperature water used in the air-conditioner, the copper piping of the heat exchanger may corrode.
Regular water quality processing is recommended.
If a water supply tank is installed, keep air contact to a minimum, and keep the level of dissolved oxygen in the water no higher than 1 mg/l.

② Water quality standard

Items		Low to mid-range temperature water system		Tendency	
		Recirculating water [20<T<60°C] [68<T<140°F]	Make-up water	Corrosive	Scale-forming
Standard items	pH (25°C) [77°F]	7.0 ~ 8.0	7.0 ~ 8.0	○	○
	Electric conductivity (mS/m) (25°C) [77°F]	30 or less	30 or less	○	○
	(μs/cm) (25°C) [77°F]	[300 or less]	[300 or less]		
	Chloride ion (mg Cl ⁻ /l)	50 or less	50 or less	○	
	Sulfate ion (mg SO ₄ ²⁻ /l)	50 or less	50 or less	○	
	Acid consumption (pH4.8) (mg CaCO ₃ /l)	50 or less	50 or less		○
	Total hardness (mg CaCO ₃ /l)	70 or less	70 or less		○
	Calcium hardness (mg CaCO ₃ /l)	50 or less	50 or less		○
Reference items	Ionic silica (mg SiO ₂ /l)	30 or less	30 or less		○
	Iron (mg Fe/l)	1.0 or less	0.3 or less	○	○
	Copper (mg Cu/l)	1.0 or less	0.1 or less	○	
	Sulfide ion (mg S ²⁻ /l)	not to be detected	not to be detected	○	
	Ammonium ion (mg NH ₄ ⁺ /l)	0.3 or less	0.1 or less	○	
	Residual chlorine (mg Cl/l)	0.25 or less	0.3 or less	○	
	Free carbon dioxide (mg CO ₂ /l)	0.4 or less	4.0 or less	○	
Ryzner stability inde	6.0 ~ 7.0	-	○	○	

Reference: Guideline of Water Quality for Refrigeration and Air Conditioning Equipment. (JRA GL02E-1994)

- ③ Consult with a specialist about water quality control methods and calculations before using anti-corrosive solutions.
- ④ When replacing a previously installed air conditioning device (even when only the heat exchanger is being replaced), first conduct a water quality analysis and check for possible corrosion.
Corrosion can occur in cold-water systems even if there has been no prior signs of corrosion.
If the water quality level has dropped, adjust water quality before replacing the unit.

8. Duct work

- When connecting ducts, insert a canvas duct between the main body and the duct.
- Use non-combustible duct components.
- Install sufficient thermal insulation to prevent condensation forming on outlet duct flanges and outlet ducts.

⚠ Caution:

- **Keep the distance between the inlet grille and the fan over 850 mm. If it is less than 850 mm, install a safety guard not to touch the fan.**

[Fig. 8.0.1] (P.4)

- (A) Air inlet
- (B) Air outlet
- (C) Access door
- (D) Ceiling surface
- (E) Canvas duct
- (F) Air filter
- (G) Inlet grille

9. Electrical wiring

Precautions on electrical wiring

⚠ Warning:

Electrical work should be done by qualified electrical engineers in accordance with "Engineering Standards For Electrical Installation" and supplied installation manuals. Special circuits should also be used. If the power circuit lacks capacity or has an installation failure, it may cause a risk of electric shock or fire.

1. Be sure to install an earth leakage breaker to the power.
2. Install the unit to prevent that any of the control circuit cables (remote controller, transmission cables) is brought in direct contact with the power cable outside the unit.
3. Ensure that there is no slack on all wire connections.
4. Some cables (power, remote controller, transmission cables) above the ceiling may be bitten by mice. Use as many metal pipes as possible to insert the cables into them for protection.

5. Never connect the power cable to leads for the transmission cables. Otherwise the cables would be broken.
6. Be sure to connect control cables to the indoor unit, remote controller, and the outdoor unit.
7. Put the unit to the ground on the outdoor unit side.
8. Select control cables from the conditions given in page 11.

⚠ Caution:

- Be sure to put the unit to the ground on the outdoor unit side. Do not connect the earth cable to any gas pipe, water pipe, lightning rod, or telephone earth cable. Incomplete grounding may cause a risk of electric shock.
- If the supply cord is damaged, it must be replaced by the manufacturer, its service agent or similarly qualified persons in order to avoid a hazard.

Transmission cable specifications

	Transmission cables	ME Remote controller cables	MA Remote controller cables
Type of cable	Shielding wire (2-core) CVVS, CPEVS or MVVS	Sheathed 2-core cable (unshielded) CVV	
Cable diameter	More than 1.25 mm ²	0.3 ~ 1.25 mm ² (0.75 ~ 1.25 mm ²) ^{*1}	0.3 ~ 1.25 mm ² (0.75 ~ 1.25 mm ²) ^{*1}
Remarks	Max length: 200 m Maximum length of transmission lines for centralized control and indoor/outdoor transmission lines (Maximum length via indoor units): 500 m MAX The maximum length of the wiring between power supply unit for transmission lines (on the transmission lines for centralized control) and each outdoor unit and system controller is 200 m.	When 10 m is exceeded, use cables with the same specification as transmission cables.	Max length: 200 m

*1 Connected with simple remote controller.

CVVS, MVVS: PVC insulated PVC jacketed shielded control cable
CPEVS: PE insulated PVC jacketed shielded communication cable
CVV: PVC insulated PVC sheathed control cable

9.1. Power supply wiring

- Use dedicated power supplies for the indoor unit.
- Bear in mind ambient conditions (ambient temperature, direct sunlight, rain water, etc.) when proceeding with the wiring and connections.
- The wire size is the minimum value for metal conduit wiring. If the voltage drops, use a wire that is one rank thicker in diameter. Make sure the power-supply voltage does not drop more than 10%.
- Specific wiring requirements should adhere to the wiring regulations of the region.
- Power supply cords of appliances shall not be lighter than design 60245 IEC 57, 60227 IEC 57, 60245 IEC 53 or 60227 IEC 53.
- A switch with at least 3 mm contact separation in each pole shall be provided by the Air conditioner installation.

[Fig. 9.1.1] (P.4)

- (A) Ground-fault interrupter
- (B) Local switch/Wiring breaker
- (C) Indoor unit
- (D) Pull box

Total operating current of the Indoor unit	Minimum wire thickness (mm ²)			Ground-fault interrupter *1	Local switch (A)		Breaker for wiring (A) (Non-fuse breaker)
	Main cable	Branch	Ground		Capacity	Fuse	
F0 = 16 A or less *2	1.5	1.5	1.5	20 A current sensitivity *3	16	16	20
F0 = 25 A or less *2	2.5	2.5	2.5	30 A current sensitivity *3	25	25	30
F0 = 32 A or less *2	4.0	4.0	4.0	40 A current sensitivity *3	32	32	40

Apply to IEC61000-3-3 about Max. Permissive System Impedance.

*1 The Ground-fault interrupter should support Inverter circuit.

The Ground-fault interrupter should combine using of local switch or wiring breaker.

*2 Please take the larger of F1 or F2 as the value for F0.

F1 = Total operating maximum current of the indoor units × 1.2

F2 = (V1 × (Quantity of Type1)/C) + (V1 × (Quantity of Type2)/C)

Indoor unit	V1	V2
Type1 PEFY-VMS, PFFY-VLRMM	18.6	2.4
Type2 PEFY-VMA	38	1.6

C : Multiple of tripping current at tripping time 0.01s

Please pick up "C" from the tripping characteristic of the breaker.

<Example of "F2" calculation>

*Condition PEFY-VMS × 4 + PEFY-VMA × 1, C = 8 (refer to right sample chart)

F2 = 18.6 × 4/8 + 38 × 1/8

= 14.05

→ 16 A breaker (Tripping current = 8 × 16 A at 0.01s)

*3 Current sensitivity is calculated using the following formula.

G1 = (V2 × Quantity of Type1) + (V3 × Wire length [km])

G1	Current sensitivity
30 or less	30 mA 0.1 sec or less
100 or less	100 mA 0.1 sec or less

Wire thickness	V3
1.5 mm ²	48
2.5 mm ²	56
4.0 mm ²	66

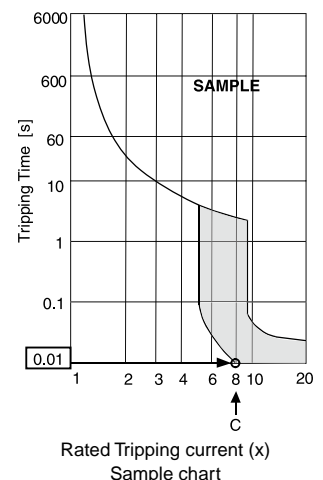

Warning:

- Be sure to use specified wires for connections and ensure no external force is imparted to terminal connections. If connections are not fixed firmly, heating or fire may result.
- Be sure to use the appropriate type of overcurrent protection switch. Note that generated overcurrent may include some amount of direct current.

Caution:

- Some installation sites may require attachment of an earth leakage breaker for the inverter. If no earth leakage breaker is installed, there is a danger of electric shock.
- Do not use anything other than the correct capacity breaker and fuse. Using fuse, wire or copper wire with too large capacity may cause a risk of malfunction or fire.

Note:

- This device is intended for the connection to a power supply system with a maximum permissible system impedance (Refer to IEC61000-3-3.) at the interface point (power service box) of the user's supply.
- The user must ensure that this device is connected only to a power supply system which fulfils the requirement above. If necessary, the user can ask the public power supply company for the system impedance at the interface point.

9.2. Connecting remote controller, indoor and outdoor transmission cables

- Connect indoor unit TB5 and outdoor unit TB3. (Non-polarized 2-wire)
The "S" on indoor unit TB5 is a shielding wire connection. For specifications about the connecting cables, refer to the outdoor unit installation manual.
- Install a remote controller following the manual supplied with the remote controller.
- Connect the "1" and "2" on indoor unit TB15 to a MA remote controller. (Non-polarized 2-wire)
- Connect the "M1" and "M2" on indoor unit TB5 to a M-NET remote controller. (Non-polarized 2-wire)
- Connect the remote controller's transmission cable within 10 m using a 0.75 mm² core cable. If the distance is more than 10 m, use a 1.25 mm² junction cable.

[Fig. 9.2.1] (P.4) MA Remote controller

[Fig. 9.2.2] (P.4) M-NET Remote controller

- (A) Terminal block for indoor transmission cable
- (B) Terminal block for outdoor transmission cable
- (C) Remote controller

- 9 to 13 VDC between 1 and 2 (MA remote controller)
- 24 to 30 VDC between M1 and M2 (M-NET remote controller)

[Fig. 9.2.3] (P.5) MA Remote controller

[Fig. 9.2.4] (P.5) M-NET Remote controller

- (A) Non-polarized
- (B) TB15
- (C) Remote Controller
- (D) TB5

- The MA remote controller and the M-NET remote controller cannot be used at the same time or interchangeably.

Caution:

Install wiring so that it is not tight and under tension. Wiring under tension may break, or overheat and burn.

9.3. Connecting electrical connections

Please identify the model name of the operation manual attached on the terminal box cover with that shown on the rating name plate.

1. Remove the screw (2pcs) holding the cover to dismount the cover.

[Fig. 9.3.1] (P.5)

- (A) Screw holding cover (2pcs)
- (B) Cover

2. Open knockout holes.
(Recommend to use a screwdriver or the like for this work.)

[Fig. 9.3.2] (P.5)

- (A) Terminal box
- (B) Knockout hole
- (C) Remove

3. Fix power source wiring to terminal box by using buffer bushing for tensile force. (PG connection or the like.) Connect transmission wiring to transmission terminal block through the knockout hole of terminal box using ordinary bushing.

[Fig. 9.3.3] (P.5)

- (E) Use PG bushing to keep the weight of the cable and external force from being applied to the power supply terminal connector. Use a cable tie to secure the cable.
- (F) Power source wiring
- (G) Tensile force
- (H) Use ordinary bushing
- (I) Transmission wiring

4. Connect the power source, Earth, transmission and remote controller wiring. The dismounting of the terminal box is not needed.

[Fig. 9.3.4] (P.5)

- (J) Power source terminal block
- (K) Terminal block for indoor transmission
- (L) Terminal block for remote controller
- (M) To 1-phase power source

- (N) Transmission line 30 VDC
- (O) Terminal block for outdoor transmission line (TB3)
- (P) Transmission line to the remote controller, terminal block for indoor unit and BC controller

[Shield wire connection]

[Fig. 9.3.5] (P.5)

- (A) Terminal block
- (B) Round terminal
- (C) Shield wire
- (D) The earth wire from two cables are connected together to the S terminal. (Dead-end connection)
- (E) Insulation tape (To keep the earth wire of the shielded cable from coming in contact with the transmission terminal)

5. After wiring is complete, make sure again that there is no slack on the connections, and attach the cover onto the terminal box in the reverse order of removal.

Notes:

- Do not pinch the cables or wires when attaching the terminal box cover. Doing so may cause a risk of disconnection.
- When accommodating the terminal box, make sure that the connectors on the box side are not removed. If removed, it cannot operate normally.

9.4. External I/O specifications

Caution:

1. Wiring should be covered by insulation tube with supplementary insulation.
2. Use relays or switches with IEC or equivalent standard.
3. The electric strength between accessible parts and control circuit should have 2750 V or more.

9.5. Selecting the external static pressure

As the factory setting is for use under an external static pressure of 15 Pa, no switch operation is needed when using under the standard condition.

External static pressure	Switch operation	
5 Pa	SWA 3 □ 2 □ 1 ■	SWC ② オブ ① 標
15 Pa	SWA 3 □ 2 □ 1 ■	SWC ② オブ ① 標
35 Pa	SWA 3 ■ 2 □ 1 □	SWC ② オブ ① 標
50 Pa	SWA 3 ■ 2 □ 1 □	SWC ② オブ ① 標

[Fig. 9.5.1] (P.5)

<Address board>

- (A) SWA
- (B) SWC
- (C) SW1
- (D) SW11
- (E) SW12
- (F) SW14

9.6. Setting addresses

(Be sure to operate with the main power turned OFF.)

- There are two types of rotary switch setting available: setting addresses 1 to 9 and over 10, and setting branch numbers.
 - ① How to set addresses
Example: If Address is "3", remain SW12 (for over 10) at "0", and match SW11 (for 1 to 9) with "3".
 - ② How to set branch numbers SW14 (Series R2 only)
The branch number assigned to each indoor unit is the port number of the BC controller to which the indoor unit is connected.
Leave it to "0" on the non-R2 series of units.
- The rotary switches are all set to "0" when shipped from the factory. These switches can be used to set unit addresses and branch numbers at will.
- The determination of indoor unit addresses varies with the system at site. Set them referring to the Data Book.

9.8. Electrical characteristics

Symbols : MCA : Max. Circuit Amps (= 1.25 × FLA) FLA : Full Load Amps
IFM : Indoor Fan Motor Output : Fan motor rated output

PEFY-WP-VMS1-E	Power supply			IFM	
	Volts / Hz	Range +-10%	MCA (A) (50 / 60 Hz)	Output (kW)	FLA (A) (50 / 60 Hz)
PEFY-WP15VMS1-E	220-240 V/50 Hz 220-240 V/60 Hz	Max.: 264 V Min.: 198 V	0.63 / 0.63	0.096	0.50 / 0.50
PEFY-WP20VMS1-E			0.70 / 0.70	0.096	0.56 / 0.56
PEFY-WP25VMS1-E			0.75 / 0.75	0.096	0.60 / 0.60
PEFY-WP32VMS1-E			0.83 / 0.82	0.096	0.66 / 0.65
PEFY-WP40VMS1-E			1.02 / 1.00	0.096	0.81 / 0.80
PEFY-WP50VMS1-E			1.08 / 1.07	0.096	0.86 / 0.85

Refer to Data Book for other models.

9.7. Sensing room temperature with the built-in sensor in a remote controller

If you want to sense room temperature with the built-in sensor in a remote controller, set SW1-1 on the control board to "ON". The setting of SW1-7 and SW1-8 as necessary also makes it possible to adjust the air flow at a time when the heating thermometer is OFF.

Note:

- To perform the auto cooling/heating operation, use the built-in sensor in a remote controller or the optional remote sensor.

This product is designed and intended for use in the residential,
commercial and light-industrial environment.

The product at hand is
based on the following
EU regulations:

- Low Voltage Directive 2006/95/EC
- Electromagnetic Compatibility Directive
2004/108/EC

Please be sure to put the contact address/telephone number on
this manual before handing it to the customer.

mitsubishi **ELECTRIC CORPORATION**

HEAD OFFICE: TOKYO BLDG., 2-7-3, MARUNOUCHI, CHIYODA-KU, TOKYO 100-8310, JAPAN
Authorized representative in EU: MITSUBISHI ELECTRIC EUROPE B.V.

HARMAN HOUSE, 1 GEORGE STREET, UXBRIDGE, MIDDLESEX UB8 1QQ, U.K.