



<ORIGINAL>

# CITY MULTI

Air-Conditioners  
INDOOR UNIT



## PEFY-P40,50,63,71,80,100,125,140VMHS-E

### INSTALLATION MANUAL

For safe and correct use, please read this installation manual thoroughly before installing the air-conditioner unit.

GB

[Fig. 3.1.1]

(Unit: mm)

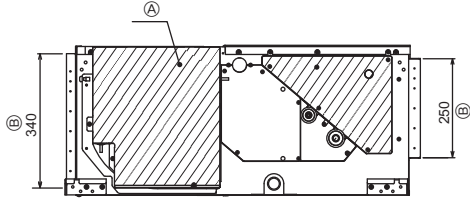

[Fig. 3.1.2]

(Unit: mm)

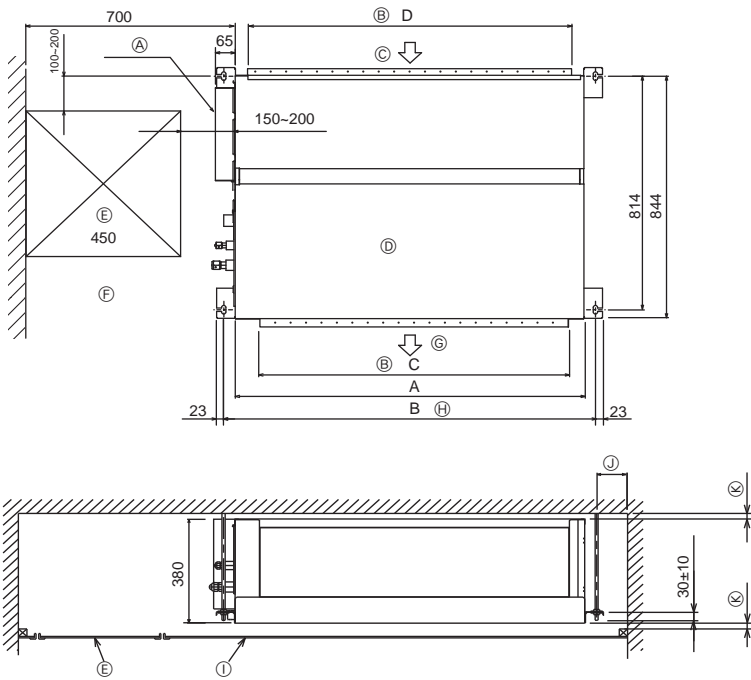

(Unit:mm)

Type	A	B	C	D
PEFY-P40-50-63VMHS-E	680	754	550	600
PEFY-P71-80VMHS-E	965	1039	835	885
PEFY-P100-125-140VMHS-E	1130	1204	1000	1050

- (A) Electrical components case
- (B) Duct dimension
- (C) Air inlet
- (D) Top of unit
- (E) Access door
- (F) Servicing space
- (G) Air outlet
- (H) Hanging bolt spacing
- (I) Ceiling
- (J) More than 100
- (K) More than 20

4

4.1

[Fig. 4.1.1]

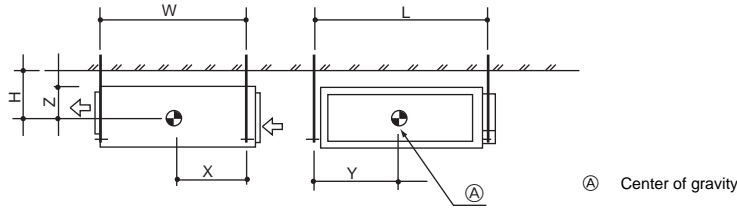

5

5.1

[Fig. 5.1.1]

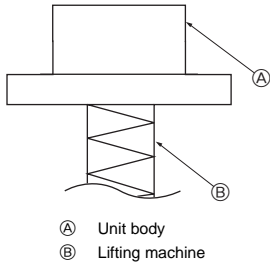

[Fig. 5.1.2]

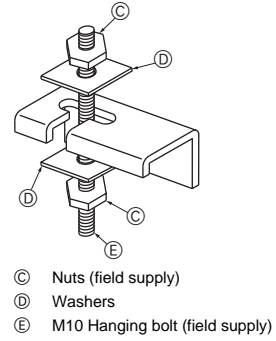

6

6.2

[Fig. 6.2.1]

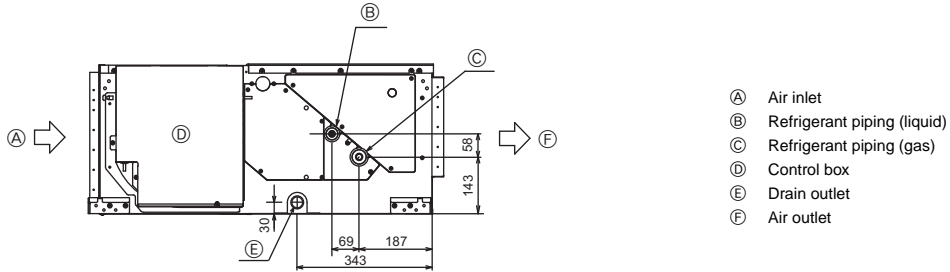

7

7.1

[Fig. 7.1.1]

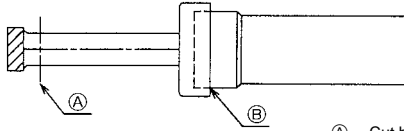

- (A) Cut here
- (B) Remove brazed cap

[Fig. 7.1.2]

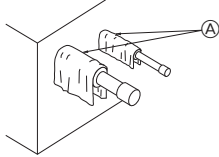

- (A) Cool by a wet cloth

[Fig. 7.1.3]

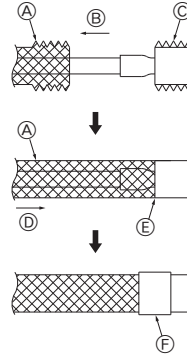

- (A) Thermal insulation
- (B) Pull out insulation
- (C) Wrap with damp cloth
- (D) Return to original position
- (E) Ensure that there is no gap here
- (F) Wrap with insulating tape

7.2

[Fig. 7.2.1]

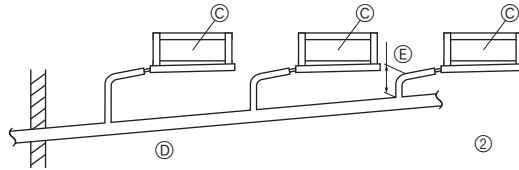
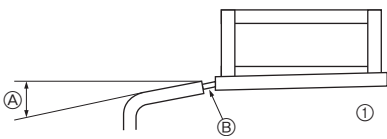

- (A) Downward slope 1/100 or more
- (B) Drain hose (Accessory)
- (C) Indoor unit
- (D) Collective piping
- (E) Maximize this length to approx. 10 cm

8

[Fig. 8.0.1]

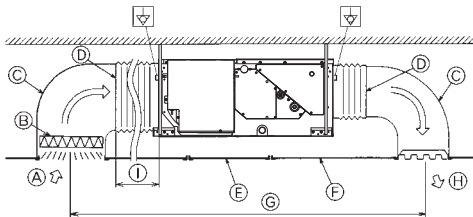

- (A) Air inlet
- (B) Air filter (supplied at site)
- (C) Duct
- (D) Canvas duct
- (E) Access door
- (F) Ceiling
- (G) Ensure sufficient length to prevent short cycling
- (H) Air outlet
- (I) Keep duct-work length 850 mm or more

9

9.1

[Fig. 9.1.1]

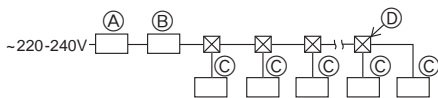

- (A) Ground-fault interrupter
- (B) Local switch/Wiring breaker
- (C) Indoor unit
- (D) Pull box

## 9.2

[Fig. 9.2.1]

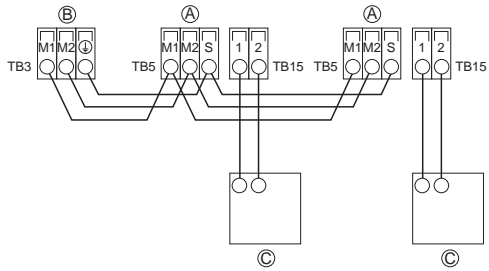

[Fig. 9.2.2]

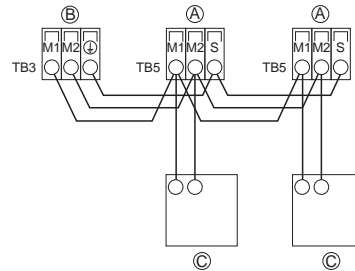

- (A) Terminal block for indoor transmission cable
- (B) Terminal block for outdoor transmission cable
- (C) Remote controller

[Fig. 9.2.3]

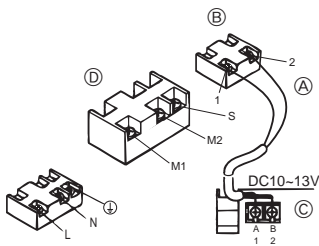

[Fig. 9.2.4]

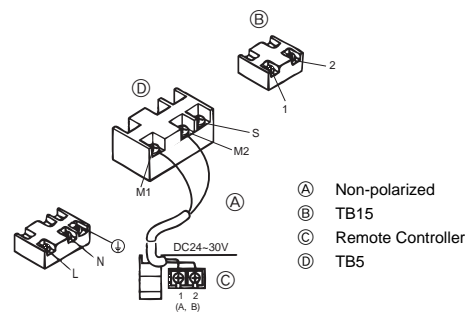

## 9.3

[Fig. 9.3.1]

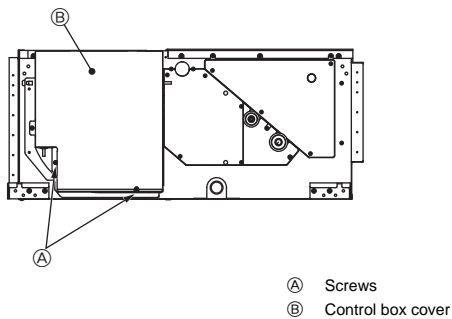

- (A) Screws
- (B) Control box cover

[Fig. 9.3.2]

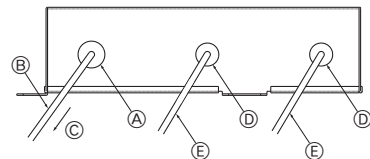

- (A) To prevent external tensile force from applying to the wiring connection section of power source terminal block use buffer bushing like PG connection or the like.
- (B) Power source wiring
- (C) Tensile force
- (D) Use ordinary bushing
- (E) Transmission wiring

[Fig. 9.3.3]

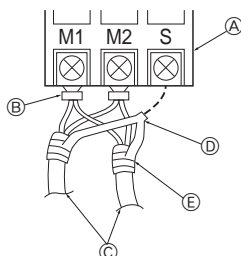

- (A) Terminal block
- (B) Round terminal
- (C) Shield wire
- (D) The earth wire from two cables are connected together to the S terminal. (Dead-end connection)
- (E) Insulation tape (To keep the earth wire of the shielded cable from coming in contact with the transmission terminal)



# Contents

1. Safety precautions .....	15	7. Connecting refrigerant pipes and drain pipes .....	18
1.1. Before installation and electric work .....	15	7.1. Refrigerant piping work .....	18
1.2. Precautions for devices that use R410A refrigerant .....	15	7.2. Drain piping work .....	18
1.3. Before getting installed .....	16	8. Duct work .....	19
1.4. Before getting installed (moved) - electrical work .....	16	9. Electrical wiring .....	19
1.5. Before starting the test run .....	16	9.1. Power supply wiring .....	19
2. Indoor unit accessories .....	16	9.2. Connecting remote controller, indoor and outdoor transmission cables .....	20
3. Selecting an installation site .....	16	9.3. Connecting electrical connections .....	20
3.1. Securing installation and service space .....	17	9.4. External I/O specifications .....	21
3.2. Combining indoor units with outdoor units .....	17	9.5. Selecting the external static pressure .....	21
4. Fixing hanging bolts .....	17	9.6. Setting addresses .....	21
4.1. Fixing hanging bolts .....	17	9.7. Sensing room temperature with the built-in sensor in a remote controller .....	21
5. Installing the unit .....	17	9.8. Electrical characteristics .....	21
5.1. Hanging the unit body .....	17		
5.2. Confirming the unit's position and fixing hanging bolts .....	17		
6. Refrigerant pipe and drain pipe specifications .....	18		
6.1. Refrigerant pipe and drain pipe specifications .....	18		
6.2. Refrigerant pipe, drain pipe .....	18		

## 1. Safety precautions

### 1.1. Before installation and electric work





- ▶ Before installing the unit, make sure you read all the "Safety precautions".
- ▶ The "Safety precautions" provide very important points regarding safety. Make sure you follow them.

#### Symbols used in the text

 **Warning:**  
Describes precautions that should be observed to prevent danger of injury or death to the user.

 **Caution:**  
Describes precautions that should be observed to prevent damage to the unit.

#### Symbols used in the illustrations

-  : Indicates an action that must be avoided.
-  : Indicates that important instructions must be followed.
-  : Indicates a part which must be grounded.
-  : Indicates that caution should be taken with rotating parts. (This symbol is displayed on the main unit label.) <Color: yellow>
-  : Beware of electric shock (This symbol is displayed on the main unit label.) <Color: yellow>

 **Warning:**  
Carefully read the labels affixed to the main unit.

-  **Warning:**
  - **Ask the dealer or an authorized technician to install the air conditioner.**
    - Improper installation by the user may result in water leakage, electric shock, or fire.
  - **Install the air unit at a place that can withstand its weight.**
    - Inadequate strength may cause the unit to fall down, resulting in injuries.
  - **Use the specified cables for wiring. Make the connections securely so that the outside force of the cable is not applied to the terminals.**
    - Inadequate connection and fastening may generate heat and cause a fire.
  - **Prepare for typhoons and other strong winds and earthquakes and install the unit at the specified place.**
    - Improper installation may cause the unit to topple and result in injury.
  - **Always use an air cleaner, humidifier, electric heater, and other accessories specified by Mitsubishi Electric.**
    - Ask an authorized technician to install the accessories. Improper installation by the user may result in water leakage, electric shock, or fire.
  - **Never repair the unit. If the air conditioner must be repaired, consult the dealer.**
    - If the unit is repaired improperly, water leakage, electric shock, or fire may result.
  - **Do not touch the heat exchanger fins.**
    - Improper handling may result in injury.
  - **When handling this product, always wear protective equipment.**  
**EG: Gloves, full arm protection namely boiler suit, and safety glasses.**
    - Improper handling may result in injury.
  - **If refrigerant gas leaks during installation work, ventilate the room.**
    - If the refrigerant gas comes into contact with a flame, poisonous gases will be released.
  - **Install the air conditioner according to this Installation Manual.**
    - If the unit is installed improperly, water leakage, electric shock, or fire may result.

- **Have all electric work done by a licensed electrician according to "Electric Facility Engineering Standard" and "Interior Wire Regulations" and the instructions given in this manual and always use a special circuit.**
  - If the power source capacity is inadequate or electric work is performed improperly, electric shock and fire may result.
- **Keep the electric parts away from water (washing water etc.).**
  - It might result in electric shock, catching fire or smoke.
- **Securely install the outdoor unit terminal cover (panel).**
  - If the terminal cover (panel) is not installed properly, dust or water may enter the outdoor unit and fire or electric shock may result.
- **Do not use refrigerant other than the type indicated in the manuals provided with the unit and on the nameplate.**
  - Doing so may cause the unit or pipes to burst, or result in explosion or fire during use, during repair, or at the time of disposal of the unit.
  - It may also be in violation of applicable laws.
  - MITSUBISHI ELECTRIC CORPORATION cannot be held responsible for malfunctions or accidents resulting from the use of the wrong type of refrigerant.
- **If the air conditioner is installed in a small room, measures must be taken to prevent the refrigerant concentration from exceeding the safety limit even if the refrigerant should leak.**
  - Consult the dealer regarding the appropriate measures to prevent the safety limit from being exceeded. Should the refrigerant leak and cause the safety limit to be exceeded, hazards due to lack of oxygen in the room could result.
- **When moving and reinstalling the air conditioner, consult the dealer or an authorized technician.**
  - If the air conditioner is installed improperly, water leakage, electric shock, or fire may result.
- **After completing installation work, make sure that refrigerant gas is not leaking.**
  - If the refrigerant gas leaks and is exposed to a fan heater, stove, oven, or other heat source, it may generate noxious gases.
- **Do not reconstruct or change the settings of the protection devices.**
  - If the pressure switch, thermal switch, or other protection device is shorted and operated forcibly, or parts other than those specified by Mitsubishi Electric are used, fire or explosion may result.
- **To dispose of this product, consult your dealer.**
- **Do not use a leak detection additive.**
- **If the supply cord is damaged, it must be replaced by the manufacturer, its service agent or similarly qualified persons in order to avoid a hazard.**
- **This appliance is not intended for use by persons (including children) with reduced physical, sensory or mental capabilities, or lack of experience and knowledge, unless they have been given supervision or instruction concerning use of the appliance by a person responsible for their safety.**
- **Children should be supervised to ensure that they do not play with the appliance.**
- **The installer and system specialist shall secure safety against leakage according to local regulation or standards.**
  - The instructions in this manual may be applicable if local regulation are not available.
- **Pay a special attention to the place, such as a basement, etc. where refrigeration gas can stay, since refrigeration is heavier than the air.**
- **This appliance is intended to be used by expert or trained users in shops, in light industry and on farms, or for commercial use by lay persons.**

### 1.2. Precautions for devices that use R410A refrigerant

-  **Caution:**
  - **Do not use the existing refrigerant piping.**
    - The old refrigerant and refrigerant oil in the existing piping contains a large amount of chlorine which may cause the refrigerant oil of the new unit to deteriorate.

- Use refrigerant piping made of C1220 (Cu-DHP) phosphorus deoxidized copper as specified in the JIS H3300 "Copper and copper alloy seamless pipes and tubes". In addition, be sure that the inner and outer surfaces of the pipes are clean and free of hazardous sulphur, oxides, dust/dirt, shaving particles, oils, moisture, or any other contaminant.
  - Contaminants on the inside of the refrigerant piping may cause the refrigerant residual oil to deteriorate.
- Store the piping to be used during installation indoors and keep both ends of the piping sealed until just before brazing. (Store elbows and other joints in a plastic bag.)
  - If dust, dirt, or water enters the refrigerant cycle, deterioration of the oil and compressor trouble may result.
- Use liquid refrigerant to fill the system.
  - If gas refrigerant is used to seal the system, the composition of the refrigerant in the cylinder will change and performance may drop.
- Do not use a refrigerant other than R410A.
  - If another refrigerant (R22, etc.) is used, the chlorine in the refrigerant may cause the refrigerator oil to deteriorate.
- Use a vacuum pump with a reverse flow check valve.
  - The vacuum pump oil may flow back into the refrigerant cycle and cause the refrigerator oil to deteriorate.
- Do not use the following tools that are used with conventional refrigerants. (Gauge manifold, charge hose, gas leak detector, reverse flow check valve, refrigerant charge base, vacuum gauge, refrigerant recovery equipment)
  - If the conventional refrigerant and refrigerator oil are mixed in the R410A, the refrigerant may deteriorate.
  - If water is mixed in the R410A, the refrigerator oil may deteriorate.
  - Since R410A does not contain any chlorine, gas leak detectors for conventional refrigerants will not react to it.
- Do not use a charging cylinder.
  - Using a charging cylinder may cause the refrigerant to deteriorate.
- Be especially careful when managing the tools.
  - If dust, dirt, or water gets in the refrigerant cycle, the refrigerant may deteriorate.

### 1.3. Before getting installed

#### ⚠ Caution:

- Do not install the unit where combustible gas may leak.
  - If the gas leaks and accumulates around the unit, an explosion may result.
- Do not use the air conditioner where food, pets, plants, precision instruments, or artwork are kept.
  - The quality of the food, etc. may deteriorate.
- Do not use the air conditioner in special environments.
  - Oil, steam, sulfuric smoke, etc. can significantly reduce the performance of the air conditioner or damage its parts.
- When installing the unit in a hospital, communication station, or similar place, provide sufficient protection against noise.
  - The inverter equipment, private power generator, high-frequency medical equipment, or radio communication equipment may cause the air conditioner to operate erroneously, or fail to operate. On the other hand, the air conditioner may affect such equipment by creating noise that disturbs medical treatment or image broadcasting.
- Do not install the unit on a structure that may cause leakage.
  - When the room humidity exceeds 80% or when the drain pipe is clogged, condensation may drip from the indoor unit. Perform collective drainage work together with the outdoor unit, as required.
- The indoor models should be installed the ceiling over than 2.5 m from floor.

## 2. Indoor unit accessories

The unit is provided with the following accessories:

Part No.	Accessories	Qty
1	Insulation pipe (small)	1
2	Insulation pipe (medium)	1
3	Insulation pipe (large)	1
4	Washer	8

## 1.4. Before getting installed (moved) - electrical work

#### ⚠ Caution:

- Ground the unit.
  - Do not connect the ground wire to gas or water pipes, lightning rods, or telephone ground lines. Improper grounding may result in electric shock.
- Install the power cable so that tension is not applied to the cable.
  - Tension may cause the cable to break and generate heat and cause a fire.
- Install an leak circuit breaker, as required.
  - If an leak circuit breaker is not installed, electric shock may result.
- Use power line cables of sufficient current carrying capacity and rating.
  - Cables that are too small may leak, generate heat, and cause a fire.
- Use only a circuit breaker and fuse of the specified capacity.
  - A fuse or circuit breaker of a larger capacity or a steel or copper wire may result in a general unit failure or fire.
- Do not wash the air conditioner units.
  - Washing them may cause an electric shock.
- Be careful that the installation base is not damaged by long use.
  - If the damage is left uncorrected, the unit may fall and cause personal injury or property damage.
- Install the drain piping according to this Installation Manual to ensure proper drainage. Wrap thermal insulation around the pipes to prevent condensation.
  - Improper drain piping may cause water leakage and damage to furniture and other possessions.
- Be very careful about product transportation.
  - Only one person should not carry the product if it weighs more than 20 kg.
  - Some products use PP bands for packaging. Do not use any PP bands for a means of transportation. It is dangerous.
  - Do not touch the heat exchanger fins. Doing so may cut your fingers.
  - When transporting the outdoor unit, suspend it at the specified positions on the unit base. Also support the outdoor unit at four points so that it cannot slip sideways.
- Safely dispose of the packing materials.
  - Packing materials, such as nails and other metal or wooden parts, may cause stabs or other injuries.
  - Tear apart and throw away plastic packaging bags so that children will not play with them. If children play with a plastic bag which was not torn apart, they face the risk of suffocation.

## 1.5. Before starting the test run

#### ⚠ Caution:

- Turn on the power at least 12 hours before starting operation.
  - Starting operation immediately after turning on the main power switch can result in severe damage to internal parts. Keep the power switch turned on during the operational season.
- Do not touch the switches with wet fingers.
  - Touching a switch with wet fingers can cause electric shock.
- Do not touch the refrigerant pipes during and immediately after operation.
  - During and immediately after operation, the refrigerant pipes are may be hot and may be cold, depending on the condition of the refrigerant flowing through the refrigerant piping, compressor, and other refrigerant cycle parts. Your hands may suffer burns or frostbite if you touch the refrigerant pipes.
- Do not operate the air conditioner with the panels and guards removed.
  - Rotating, hot, or high-voltage parts can cause injuries.
- Do not turn off the power immediately after stopping operation.
  - Always wait at least five minutes before turning off the power. Otherwise, water leakage and trouble may occur.

Part No.	Accessories	Qty
5	Drain hose	1
6	Tie band	7

## 3. Selecting an installation site

- Select a site with sturdy fixed surface sufficiently durable against the weight of unit.
- Before installing unit, the routing to carry in unit to the installation site should be determined.
- Select a site where the unit is not affected by entering air.
- Select a site where the flow of supply and return air is not blocked.
- Select a site where refrigerant piping can easily be led to the outside.
- Select a site which allows the supply air to be distributed fully in room.
- Do not install unit at a site with oil splashing or steam in much quantity.
- Do not install unit at a site where combustible gas may generate, flow in, stagnate or leak.
- Do not install unit at a site where equipment generating high frequency waves (a high frequency wave welder for example) is provided.



- Do not install unit at a site where fire detector is located at the supply air side. (Fire detector may operate erroneously due to the heated air supplied during heating operation.)
- When special chemical product may scatter around such as site chemical plants and hospitals, full investigation is required before installing unit. (The plastic components may be damaged depending on the chemical product applied.)
- If the unit is run for long hours when the air above the ceiling is at high temperature/ high humidity (dew point above 26 °C), due condensation may be produced in the indoor unit. When operating the units in this condition, add insulation material (10-20 mm) to the entire surface of the indoor unit to avoid due condensation.

**Warning:**  
The unit must be securely installed on a structure that can sustain its weight. If the unit is mounted on an unstable structure, it may fall down causing injuries.

### 3.1. Securing installation and service space

Refrigerant piping, drain piping, wiring, and other components should be installed outside the  areas, and free of the access doors to ensure that they do not hinder fan maintenance.

## 4. Fixing hanging bolts

### 4.1. Fixing hanging bolts

(Give site of suspension strong structure.)

#### Hanging structure

- Ceiling: The ceiling structure varies from building to one another. For detailed information, consult your construction company.
  - If necessary, reinforce the hanging bolts with anti-quake supporting members as countermeasures against earthquakes.
    - \* Use M10 for hanging bolts and anti-quake supporting members (field supply).
- ① Reinforcing the ceiling with additional members (edge beam, etc.) must be required to keep the ceiling at level and to prevent the ceiling from vibrations.
  - ② Cut and remove the ceiling members.
  - ③ Reinforce the ceiling members, and add other members for fixing the ceiling boards.

## 5. Installing the unit

### 5.1. Hanging the unit body

- ▶ Bring the indoor unit to an installation site as it is packed.
- ▶ To hang the indoor unit, use a lifting machine to lift and pass through the hanging bolts.

[Fig. 5.1.1] (P.3)

- Ⓐ Unit body
- Ⓑ Lifting machine

[Fig. 5.1.2] (P.3)

- Ⓒ Nuts (field supply)
- Ⓓ Washers
- Ⓔ M10 hanging bolt (field supply)

[Fig. 3.1.1] (P.2)

- Ⓐ Electrical components case
- Ⓑ Duct dimension

Note:

Always install access doors in the specified positions for service maintenance.

**Warning:**

Install the unit on a ceiling strong enough to support its weight.

- If the unit is mounted on a structure of insufficient strength it may fall causing injury.

[Fig. 3.1.2] (P.2)

- Ⓑ Duct dimension
- Ⓒ Air inlet
- Ⓓ Top of unit
- Ⓔ Access door
- Ⓕ Servicing space
- Ⓖ Air outlet
- Ⓖ Hanging bolt spacing
- Ⓗ Ceiling
- Ⓙ More than 100
- Ⓚ More than 20

### 3.2. Combining indoor units with outdoor units

For combining indoor units with outdoor units, refer to the outdoor unit installation manual.

[Fig. 4.1.1] (P.3)

- Ⓐ Center of gravity

#### Center of gravity and Product Weight

Model name	W (mm)	L (mm)	H (mm)	X (mm)	Y (mm)	Z (mm)	Product Weight (kg)
PEFY-P40VMHS-E	814	754	210	374	440	190	35
PEFY-P50VMHS-E	814	754	210	374	440	190	35
PEFY-P63VMHS-E	814	754	210	374	440	190	35
PEFY-P71VMHS-E	814	1039	210	364	548	190	45
PEFY-P80VMHS-E	814	1039	210	364	548	190	45
PEFY-P100VMHS-E	814	1204	210	364	649	190	51
PEFY-P125VMHS-E	814	1204	210	364	649	190	51
PEFY-P140VMHS-E	814	1204	210	364	649	190	53

### 5.2. Confirming the unit's position and fixing hanging bolts

- ▶ Ensure that the hanging bolt nuts are tightened to fix the hanging bolts.
- ▶ To ensure that drain is discharged, be sure to hang the unit at level using a level.

**Caution:**

Install the unit in horizontal position. If the side with drain port is installed higher, water leakage may be caused.

## 6. Refrigerant pipe and drain pipe specifications

To avoid dew drops, provide sufficient antisweating and insulating work to the refrigerant and drain pipes.

When using commercially available refrigerant pipes, be sure to wind commercially available insulating material (with a heat-resisting temperature of more than 100 °C and thickness given below) onto both liquid and gas pipes.

Insulate all indoor pipes with form polyethylene insulation with a minimum density of 0.03 and a thickness as specified in the table below.

- ① Select the thickness of insulating material by pipe size.

Pipe size	Insulating material's thickness
6.4 mm to 25.4 mm	More than 10 mm
28.6 mm to 38.1 mm	More than 15 mm

- ② If the unit is used on the highest story of a building and under conditions of high temperature and humidity, it is necessary to use pipe size and insulating material's thickness more than those given in the table above.  
 ③ If there are customer's specifications, simply follow them.

### 6.1. Refrigerant pipe and drain pipe specifications

Item \ Model		PEFY-P-VMHS-E	
		40-50	63-71-80-100-125-140
Refrigerant pipe (Braze connection)	Liquid pipe	ø 6.35	ø 9.52
	Gas pipe	ø 12.7	ø 15.88
Drain pipe		O.D. ø 32	

### 6.2. Refrigerant pipe, drain pipe

[Fig. 6.2.1] (P.3)

- Ⓐ Air inlet
- Ⓑ Refrigerant piping (liquid)
- Ⓒ Refrigerant piping (gas)
- Ⓓ Control box
- Ⓔ Drain outlet
- Ⓕ Air outlet

## 7. Connecting refrigerant pipes and drain pipes

### 7.1. Refrigerant piping work

This piping work must be done in accordance with the installation manuals for both outdoor unit and BC controller (simultaneous cooling and heating series R2).

- Series R2 is designed to operate in a system that the refrigerant pipe from an outdoor unit is received by BC controller and branches at the BC controller to connect between indoor units.
- For constraints on pipe length and allowable difference of elevation, refer to the outdoor unit manual.
- The method of pipe connection is brazing connection.

#### ⚠ Caution:

- **Install the refrigerant piping for the indoor unit in accordance with the following.**

1. Cut the tip of the indoor unit piping, remove the gas, and then remove the brazed cap.

[Fig. 7.1.1] (P.4)

- Ⓐ Cut here
- Ⓑ Remove brazed cap

2. Pull out the thermal insulation on the site refrigerant piping, braze the unit piping, and replace the insulation in its original position.  
Wrap the piping with insulating tape.

#### Note:

- **When blazing the refrigerant pipes, be sure to blaze, after covering a wet cloth to the pipes of the units in order to prevent it from burning and shrinking by heat.**

[Fig. 7.1.2] (P.4)

- Ⓐ Cool by a wet cloth

- **Pay strict attention when wrapping the copper piping since wrapping the piping may cause condensation instead of preventing it.**

[Fig. 7.1.3] (P.4)

- Ⓐ Thermal insulation
- Ⓑ Pull out insulation
- Ⓒ Wrap with damp cloth
- Ⓓ Return to original position
- Ⓔ Ensure that there is no gap here
- Ⓕ Wrap with insulating tape

### Cautions On Refrigerant Piping

- ▶ **Be sure to use non-oxidative brazing for brazing to ensure that no foreign matter or moisture enter into the pipe.**
- ▶ **Be sure to apply refrigerating machine oil over the flare connection seating surface and tighten the connection using a double spanner.**
- ▶ **Provide a metal brace to support the refrigerant pipe so that no load is imparted to the indoor unit end pipe. This metal brace should be provided 50 cm away from the indoor unit's flare connection.**

#### ⚠ Warning:

**Do not use refrigerant other than the type indicated in the manuals provided with the unit and on the nameplate.**

- Doing so may cause the unit or pipes to burst, or result in explosion or fire during use, during repair, or at the time of disposal of the unit.
- It may also be in violation of applicable laws.
- MITSUBISHI ELECTRIC CORPORATION cannot be held responsible for malfunctions or accidents resulting from the use of the wrong type of refrigerant.

#### ⚠ Caution:

- **Use refrigerant piping made of C1220 (Cu-DHP) phosphorus deoxidized copper as specified in the JIS H3300 "Copper and copper alloy seamless pipes and tubes". In addition, be sure that the inner and outer surfaces of the pipes are clean and free of hazardous sulphur, oxides, dust/dirt, shaving particles, oils, moisture, or any other contaminant.**
- **Never use existing refrigerant piping.**
  - The large amount of chlorine in conventional refrigerant and refrigerator oil in the existing piping will cause the new refrigerant to deteriorate.
- **Store the piping to be used during installation indoors and keep both ends of the piping sealed until just before brazing.**
  - If dust, dirt, or water gets into the refrigerant cycle, the oil will deteriorate and the compressor may fail.
- **Use Suniso 4GS or 3GS (small amount) refrigerator oil to coat the flare and flange connection part. (For models using R22)**
- **Use ester oil, ether oil or alkylbenzene (small amount) as the refrigerator oil to coat flares and flange connections. (For models using R410A or R407C)**
  - The refrigerant used in the unit is highly hygroscopic and mixes with water and will degrade the refrigerator oil.

### 7.2. Drain piping work

- Ensure that the drain piping is downward (pitch of more than 1/100) to the outdoor (discharge) side. Do not provide any trap or irregularity on the way. (①)
- Ensure that any cross-wise drain piping is less than 20 m (excluding the difference of elevation). If the drain piping is long, provide metal braces to prevent it from waving. Never provide any air vent pipe. Otherwise drain may be ejected.
- Use a hard vinyl chloride pipe VP-25 (with an external diameter of 32 mm) for drain piping.
- Ensure that collected pipes are 10 cm lower than the unit body's drain port as shown in ②.
- Do not provide any odor trap at the drain discharge port.
- Put the end of the drain piping in a position where no odor is generated.
- Do not put the end of the drain piping in any drain where ionic gases are generated.

[Fig. 7.2.1] (P.4)

- Ⓐ Downward slope 1/100 or more
- Ⓑ Drain hose (Accessory)
- Ⓒ Indoor unit
- Ⓓ Collective piping
- Ⓔ Maximize this length to approx. 10 cm

## 8. Duct work

- When connecting ducts, insert a canvas duct between the main body and the duct.
- Use non-combustible duct components.
- Install sufficient thermal insulation to prevent condensation forming on air inlet and air outlet duct flanges, and air outlet ducts.

[Fig. 8.0.1] (P.4)

- Ⓐ Air inlet
- Ⓑ Air filter (supplied at site)
- Ⓒ Duct
- Ⓓ Canvas duct
- Ⓔ Access door
- Ⓕ Ceiling
- Ⓖ Ensure sufficient length to prevent short cycling
- Ⓗ Air outlet
- Ⓘ Keep duct-work length 850 mm or more

**⚠ Caution:**  
**Inlet duct is 850 mm or more necessary to construct.**  
**Always install horizontal.**

## 9. Electrical wiring

### Precautions on electrical wiring

**⚠ Warning:**

Electrical work should be done by qualified electrical engineers in accordance with "Engineering Standards For Electrical Installation" and supplied installation manuals. Special circuits should also be used. If the power circuit lacks capacity or has an installation failure, it may cause a risk of electric shock or fire.

1. Be sure to install an earth leakage breaker to the power.
2. Install the unit to prevent that any of the control circuit cables (remote controller, transmission cables) is brought in direct contact with the power cable outside the unit.
3. Ensure that there is no slack on all wire connections.
4. Some cables (power, remote controller, transmission cables) above the ceiling may be bitten by mouses. Use as many metal pipes as possible to insert the cables into them for protection.

5. Never connect the power cable to leads for the transmission cables. Otherwise the cables would be broken.
6. Be sure to connect control cables to the indoor unit, remote controller, and the outdoor unit.
7. Put the unit to the ground on the outdoor unit side.
8. Select control cables from the conditions given in page 19.

**⚠ Caution:**

- Be sure to put the unit to the ground on the outdoor unit side. Do not connect the earth cable to any gas pipe, water pipe, lightning rod, or telephone earth cable. Incomplete grounding may cause a risk of electric shock.
- If the supply cord is damaged, it must be replaced by the manufacturer, its service agent or similarly qualified persons in order to avoid a hazard.

### Transmission cable specifications

	Transmission cables	ME Remote controller cables	MA Remote controller cables
Type of cable	Shielding wire (2-core) CVVS, CPEVS or MVVS	Sheathed 2-core cable (unshielded) CVV	
Cable diameter	More than 1.25 mm <sup>2</sup>	0.3 ~ 1.25 mm <sup>2</sup> (0.75 ~ 1.25 mm <sup>2</sup> )*1	0.3 ~ 1.25 mm <sup>2</sup> (0.75 ~ 1.25 mm <sup>2</sup> )*1
Remarks	Max length: 200 m Maximum length of transmission lines for centralized control and indoor/outdoor transmission lines (Maximum length via indoor units): 500 m MAX The maximum length of the wiring between power supply unit for transmission lines (on the transmission lines for centralized control) and each outdoor unit and system controller is 200 m.	When 10 m is exceeded, use cables with the same specification as transmission cables.	Max length: 200 m

\*1 Connected with simple remote controller.

CVVS, MVVS: PVC insulated PVC jacketed shielded control cable  
 CPEVS: PE insulated PVC jacketed shielded communication cable  
 CVV: PVC insulated PVC sheathed control cable

### 9.1. Power supply wiring

- Use dedicated power supplies for the outdoor unit and indoor unit.
- Bear in mind ambient conditions (ambient temperature, direct sunlight, rain water, etc.) when proceeding with the wiring and connections.
- The wire size is the minimum value for metal conduit wiring. If the voltage drops, use a wire that is one rank thicker in diameter. Make sure the power-supply voltage does not drop more than 10%.
- Specific wiring requirements should adhere to the wiring regulations of the region.
- Power supply cords of appliances shall not be lighter than design 245 IEC 57, 227 IEC 57, 245 IEC 53 or 227 IEC 53.
- A switch with at least 3 mm contact separation in each pole shall be provided by the Air conditioner installation.

[Fig. 9.1.1] (P.4)

- Ⓐ Ground-fault interrupter
- Ⓑ Local switch/Wiring breaker
- Ⓒ Indoor unit
- Ⓓ Pull box

Total operating current of the Indoor unit	Minimum wire thickness (mm <sup>2</sup> )			Ground-fault interrupter *1	Local switch (A)		Breaker for wiring (A) (Non-fuse breaker)
	Main cable	Branch	Ground		Capacity	Fuse	
F0 = 16 A or less *2	1.5	1.5	1.5	20 A current sensitivity *3	16	16	20
F0 = 25 A or less *2	2.5	2.5	2.5	30 A current sensitivity *3	25	25	30
F0 = 32 A or less *2	4.0	4.0	4.0	40 A current sensitivity *3	32	32	40

Apply to IEC61000-3-3 about Max. Permissive System Impedance.

\*1 The Ground-fault interrupter should support inverter circuit.  
The Ground-fault interrupter should combine using of local switch or wiring breaker.

\*2 Please take the larger of F1 or F2 as the value for F0.

F1 = Total operating maximum current of the indoor units × 1.2

F2 = {V1 × (Quantity of Type1)/C} + {V1 × (Quantity of Type2)/C} + {V1 × (Quantity of Type3)/C} + {V1 × (Quantity of Others)/C}

Indoor unit		V1	V2
Type1	PLFY-VBM, PMFY-VBM, PEFY-VMS, PCFY-VKM, PKFY-VHM, PKFY-VKM, PFFY-VKM, PFFY-VLRMM	18.6	2.4
Type2	PEFY-VMA	38	1.6
Type3	PEFY-P200-250VMHS	13.8	4.8
Type4	PEFY-P40-140VMHS-E	26.8	1.6
Others	Other indoor unit	0	0

C : Multiple of tripping current at tripping time 0.01s  
Please pick up "C" from the tripping characteristic of the breaker.

<Example of "F2" calculation>

\*Condition PEFY-VMA × 3, C = 8 (refer to right sample chart)

F2 = 38 × 3/8

= 14.25

→ 16 A breaker (Tripping current = 8 × 16 A at 0.01s)

\*3 Current sensitivity is calculated using the following formula.

G1 = (V2 × Quantity of Type1) + (V3 × Wire length [km])

G1	Current sensitivity
30 or less	30 mA 0.1 sec or less
100 or less	100 mA 0.1 sec or less

Wire thickness	V3
1.5 mm <sup>2</sup>	48
2.5 mm <sup>2</sup>	56
4.0 mm <sup>2</sup>	66

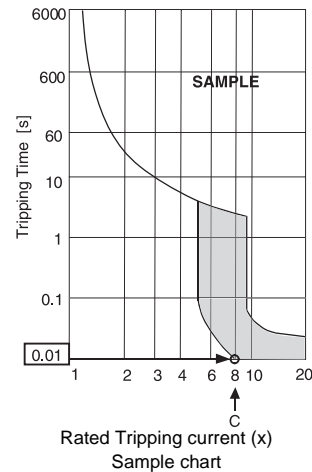

### Warning:

- Be sure to use specified wires for connections and ensure no external force is imparted to terminal connections. If connections are not fixed firmly, heating or fire may result.
- Be sure to use the appropriate type of overcurrent protection switch. Note that generated overcurrent may include some amount of direct current.

### Caution:

- Some installation sites may require attachment of an earth leakage breaker for the inverter. If no earth leakage breaker is installed, there is a danger of electric shock.
- Do not use anything other than the correct capacity breaker and fuse. Using fuse, wire or copper wire with too large capacity may cause a risk of malfunction or fire.

### Notes:

- This device is intended for the connection to a power supply system with a maximum permissible system impedance (Refer to IEC61000-3-3.) at the interface point (power service box) of the user's supply.
- The user must ensure that this device is connected only to a power supply system which fulfils the requirement above. If necessary, the user can ask the public power supply company for the system impedance at the interface point.

## 9.2. Connecting remote controller, indoor and outdoor transmission cables

- Connect indoor unit TB5 and outdoor unit TB3. (Non-polarized 2-wire)  
The "S" on indoor unit TB5 is a shielding wire connection. For specifications about the connecting cables, refer to the outdoor unit installation manual.
- Install a remote controller following the manual supplied with the remote controller.
- Connect the "1" and "2" on indoor unit TB15 to a MA remote controller. (Non-polarized 2-wire)
- Connect the "M1" and "M2" on indoor unit TB5 to a M-NET remote controller. (Non-polarized 2-wire)
- Connect the remote controller's transmission cable within 10 m using a 0.75 mm<sup>2</sup> core cable. If the distance is more than 10 m, use a 1.25 mm<sup>2</sup> junction cable.

[Fig. 9.2.1] (P.5) MA Remote controller

[Fig. 9.2.2] (P.5) M-NET Remote controller

- Ⓐ Terminal block for indoor transmission cable
- Ⓑ Terminal block for outdoor transmission cable
- Ⓒ Remote controller

- DC 9 to 13 V between 1 and 2 (MA remote controller)
- DC 24 to 30 V between M1 and M2 (M-NET remote controller)

[Fig. 9.2.3] (P.5) MA Remote controller

[Fig. 9.2.4] (P.5) M-NET Remote controller

- Ⓐ Non-polarized
- Ⓑ TB15
- Ⓒ Remote Controller
- Ⓓ TB5

- The MA remote controller and the M-NET remote controller cannot be used at the same time or interchangeably.

### Caution:

Install wiring so that it is not tight and under tension. Wiring under tension may break, or overheat and burn.

## 9.3. Connecting electrical connections

Please identify the model name of the operation manual attached on the terminal box cover with that shown on the rating name plate.

- Remove the screws holding the cover to dismount the cover.

[Fig. 9.3.1] (P.5)

- Ⓐ Screws
- Ⓑ Control box cover

- Open knockout holes  
(Recommend to use a screwdriver or the like for this work.)
- Fix power source wiring to terminal box by using buffer bushing for tensile force. (PG connection or the like.) Connect transmission wiring to transmission terminal block through the knockout hole of terminal box using ordinary bushing.
- Connect the power source, Earth, transmission and remote controller wiring. The dismounting of the terminal box is not needed.

[Fig. 9.3.2] (P.5)

- Ⓐ To prevent external tensile force from applying to the wiring connection section of power source terminal block use buffer bushing like PG connection or the like.
- Ⓑ Power source wiring
- Ⓒ Tensile force
- Ⓓ Use ordinary bushing
- Ⓔ Transmission wiring

[Shield wire connection]

[Fig. 9.3.3] (P.5)

- Ⓐ Terminal block
- Ⓑ Round terminal
- Ⓒ Shield wire
- Ⓓ The earth wire from two cables are connected together to the S terminal. (Dead-end connection)
- Ⓔ Insulation tape (To keep the earth wire of the shielded cable from coming in contact with the transmission terminal)

- After wiring is complete, make sure again that there is no slack on the connections, and attach the cover onto the terminal box in the reverse order of removal.

### Notes:

- Do not pinch the cables or wires when attaching the terminal box cover. Doing so may cause a risk of disconnection.
- When accommodating the terminal box, make sure that the connectors on the box side are not removed. If removed, it cannot operate normally.

## 9.4. External I/O specifications

### ⚠ Caution:

1. Wiring should be covered by insulation tube with supplementary insulation.
2. Use relays or switches with IEC or equivalent standard.
3. The electric strength between accessible parts and control circuit should have 2750 V or more.

## 9.5. Selecting the external static pressure

Four levels of external static pressure (50 Pa/100 Pa/150 Pa/200 Pa) are available for selection.

Set the setting either by using the switches on the control board (SW21-1, SW21-2, and SW21-5) or from the function selection screen on the remote controller.

### Notes:

- When the static pressure setting was set from the remote controller, the actual setting and the switch setting on the control board may not match because the latest setting from the remote controller overrides the previous setting. To check the latest static pressure setting, check it on the remote controller, not on the switch.
- If the static pressure setting for the duct is lower than that for the unit, the fan of the unit may repeat start/stop, and the outdoor unit may remain in a stopped state. Match the static pressure settings for the unit to that for the duct.

#### ▶ To set the external static pressure with the switches on the control board

External static pressure	SW21-1	SW21-2	SW21-5
50 Pa	OFF	OFF	OFF
100 Pa	ON	OFF	OFF
150 Pa	OFF	ON	OFF
200 Pa	OFF	OFF	ON

Set the switches on the control board (SW21-1, SW21-2, and SW21-5) as shown in the table at left.

#### ▶ To set the external static pressure from the function selection screen on the remote controller (Only PAR-30MAA)

Follow the instructions below and the instructions detailed in the remote controller manual for how to set the switches.

1. Set the function setting No. 32 (Switch setting/Function selection) to "2".
2. Set the function setting No. 8 and No. 10 to appropriate values, according to the external static pressure.

Selection	Function setting No.	Initial Setting	Current setting
	No. 32		
Switch setting	1	○	
Function selection	2		

External static pressure setting	Function setting No.		Initial setting	Current setting
	No. 8	No. 10		
50 Pa	2	1	○	
100 Pa	3	1		
150 Pa	1	1		
200 Pa	2	2		

### [Important]

Be sure to write down the settings for all functions in the "Current setting" row if any of the initial settings has been changed.

## 9.6. Setting addresses

(Be sure to operate with the main power turned OFF.)

### [Fig. 9.5.1] (P.6)

<Indoor controller board>

- There are two types of rotary switch setting available: setting addresses 1 to 9 and over 10, and setting branch numbers.
  - ① How to set addresses  
Example: If Address is "3", remain SW12 (for over 10) at "0", and match SW11 (for 1 to 9) with "3".
  - ② How to set branch numbers SW14 (Series R2 only)  
The branch number assigned to each indoor unit is the port number of the BC controller to which the indoor unit is connected.  
Leave it to "0" on the non-R2 series of units.
- The rotary switches are all set to "0" when shipped from the factory. These switches can be used to set unit addresses and branch numbers at will.
- The determination of indoor unit addresses varies with the system at site. Set them referring to the Data Book.

## 9.7. Sensing room temperature with the built-in sensor in a remote controller

If you want to sense room temperature with the built-in sensor in a remote controller, set SW1-1 on the control board to "ON". The setting of SW1-7 and SW1-8 as necessary also makes it possible to adjust the air flow at a time when the heating thermometer is OFF.

### Note:

To perform the auto cooling/heating operation, use the built-in sensor in a remote controller or the optional remote sensor.

## 9.8. Electrical characteristics

Symbols: MCA: Max. Circuit Amps (= 1.25 x FLA) FLA: Full Load Amps  
IFM: Indoor Fan Motor Output: Fan motor rated output

Model	Power supply			IFM	
	Volts / Hz	Range +-10%	MCA (A)	Output (kW)	FLA(A)
PEFY-P40VMHS-E	220-240V / 50 Hz 220-240V / 60 Hz	Max.: 264 V Min.: 198 V	1.78	0.121	1.42
PEFY-P50VMHS-E			1.78	0.121	1.42
PEFY-P63VMHS-E			1.97	0.121	1.57
PEFY-P71VMHS-E			2.38	0.244	1.90
PEFY-P80VMHS-E			2.45	0.244	1.96
PEFY-P100VMHS-E			3.85	0.375	3.08
PEFY-P125VMHS-E			3.85	0.375	3.08
PEFY-P140VMHS-E			3.93	0.375	3.14

Refer to Data Book for other models.



AIR CONDITIONER INDOOR UNIT

MODEL \_\_\_\_\_

SERVICE REF. \_\_\_\_\_



OPERATE		COOLING			HEATING		
RATED VOLTAGE	~ V	220	230	240	220	230	240
FREQUENCY	Hz	50/60	50/60	50/60	50/60	50/60	50/60
CAPACITY	kW						
RATED INPUT	kW						
RATED CURRENT	A						

ALLOWABLE VOLTAGE  $\pm 10\%$   
CONTROL RATING DC30V  
FAN MOTOR \_\_\_\_\_  
REFRIGERANT R410A

IP CODE IP20  
WEIGHT \_\_\_\_\_  
ALLOWABLE PRESSURE 4.15MPa  
YEAR OF MANUFACTURE \_\_\_\_\_

**MITSUBISHI ELECTRIC CORPORATION**  
MITSUBISHI ELECTRIC CONSUMER PRODUCTS (THAILAND) CO., LTD.  
700/406 MOO 7, TAMBON DON HUA ROH, AMPHUR MUANG, CHONBURI 20000, THAILAND  
MADE IN THAILAND

SERIAL No. \_\_\_\_\_

2SP

---

This product is designed and intended for use in the residential, commercial and light-industrial environment.

The product at hand is based on the following EU regulations:

- Low Voltage Directive 2014/35/EU
- Electromagnetic Compatibility Directive 2014/30/EU
- Machinery Directive 2006/42/EC

Please be sure to put the contact address/telephone number on this manual before handing it to the customer.

**MITSUBISHI ELECTRIC CORPORATION**

HEAD OFFICE: TOKYO BLDG., 2-7-3, MARUNOUCHI, CHIYODA-KU, TOKYO 100-8310, JAPAN