

**mitsubishi electric**

**Air-Conditioners  
INDOOR UNIT**



**PEA-RP200, 250, 400, 500 GAQ**

**FOR INSTALLER**

**INSTALLATION MANUAL**

For safe and correct use, please read this installation manual thoroughly before installing the air-conditioner unit.

GB

2

[Fig. 2.0.1]

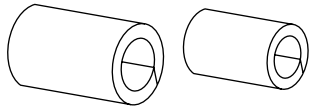

① Pipe cover (For field piping connection)

3

3.2

[Fig. 3.2.1]

\* In case of PEA-200, 250

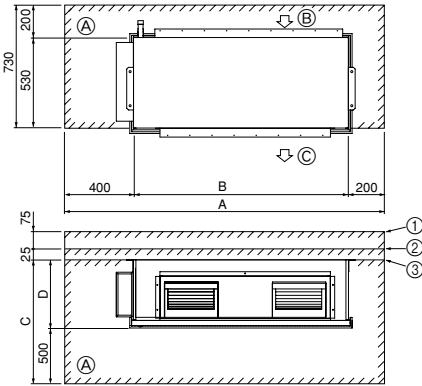

Model	A	B	C	D
PEA-200	1860	1260	900	400
PEA-250	2060	1460	900	400

\* In case of PEA-400, 500

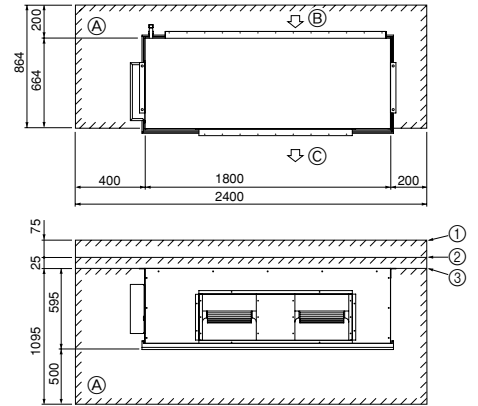

- ① When connecting air inlet
- ② When installing the suspension fixtures prior to installation of the indoor unit without inlet duct
- ③ When hanging the indoor unit directly without inlet duct
- Ⓐ Service space
- Ⓑ Air inlet
- Ⓒ Air outlet

[Fig. 3.2.2]

\* In case of PEA-200, 250

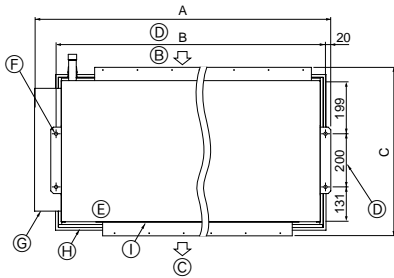

Model	A	B	C
PEA-200	1400	1300	634
PEA-250	1600	1500	634

\* In case of PEA-400, 500

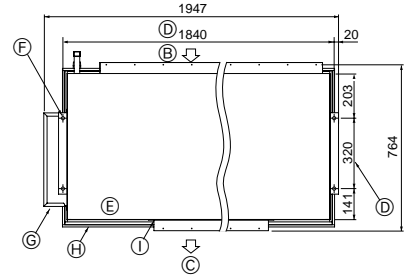

- Ⓓ Suspension bolt pitch
- Ⓔ Top of the unit
- Ⓕ Suspension bolt holes  
(PEA-200, 250 : 4-φ12 holes)  
(PEA-400, 500 : 4-φ15 holes)
- Ⓖ Control box
- Ⓗ Drain pan
- Ⓘ Main body

4

4.1

[Fig. 4.1.1]

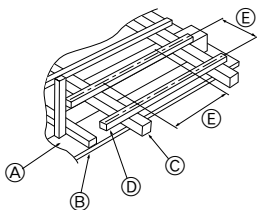

- Ⓐ Ceiling board
- Ⓑ Edge beam
- Ⓒ Tie beam
- Ⓓ Square timber for hanging the air conditioner
- Ⓔ Pitch

[Fig. 4.1.2]

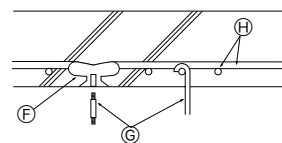

- Ⓕ Insert: 100 to 150 kg (1 piece) (field supply)
- Ⓖ Hanging bolt (field supply)  
PEA-200, 250 : M10  
PEA-400, 500 : M12
- Ⓗ Reinforcement

# 5

# 5.1

[Fig. 5.1.1]

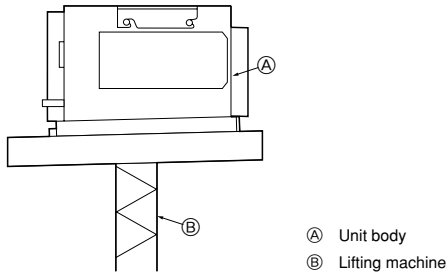

[Fig. 5.1.2]

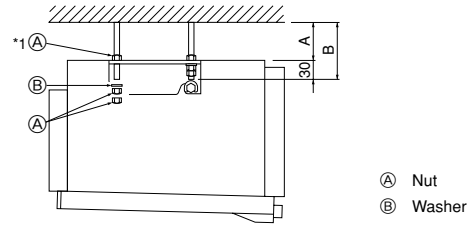

[Fig. 5.1.3]

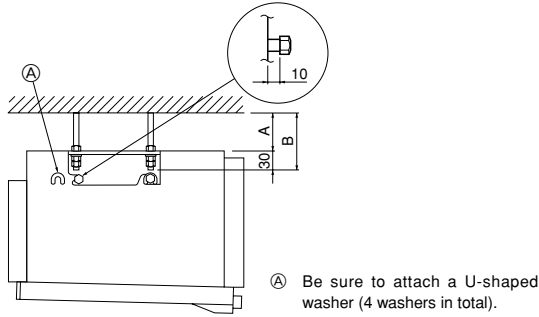

# 5.2

[Fig. 5.2.1]

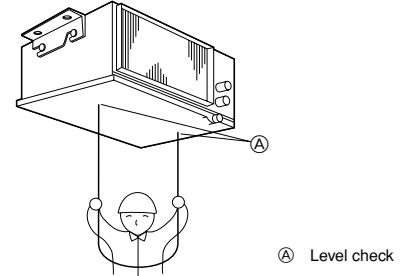

# 6

# 6.2

[Fig. 6.2.1]

\* In case of PEA-200, 250

\* In case of PEA-400, 500

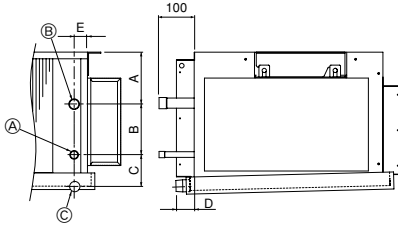

Model	A	B	C	D	E
PEA-200, 250	144	145	89	52	42

- A Refrigerant pipe (liquid pipe)
- B Refrigerant pipe (gas pipe)
- C Drain pipe

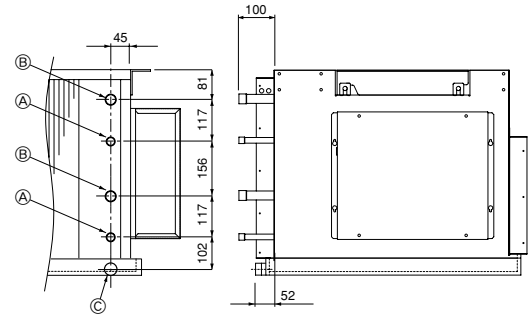

# 7

# 7.1

[Fig. 7.1.1]

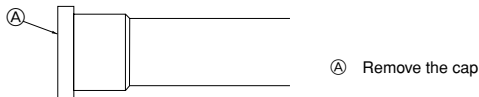

[Fig. 7.1.2]

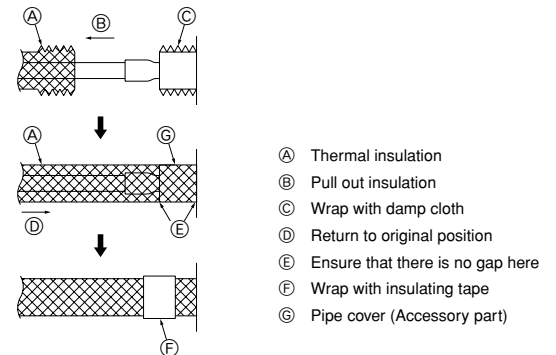

[Fig. 7.1.3]

\* In case of PEA-200, 250

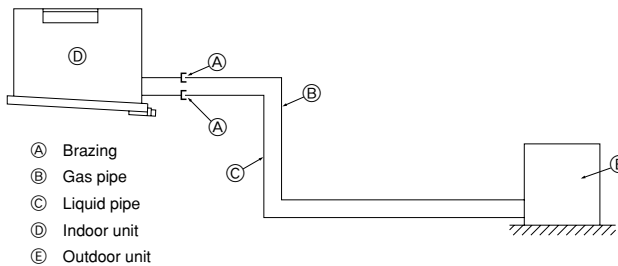

\* Refer to the Outdoor Installation Manual for connecting to the outdoor unit.

\* In case of PEA-400, 500

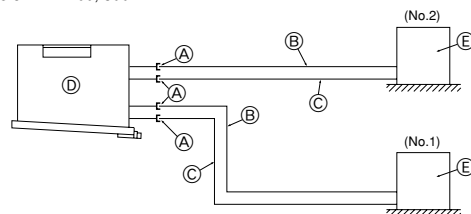

[Fig.7.2.1]

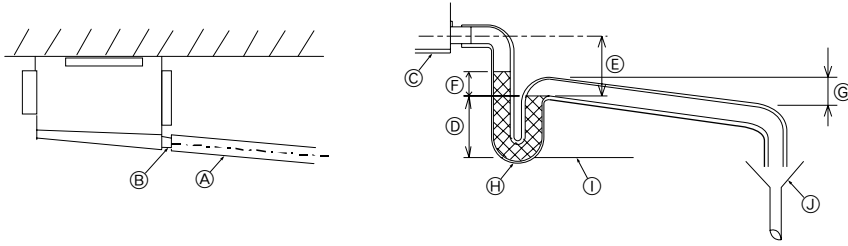

- Ⓐ Insulator
- Ⓑ Drain pipe R1
- Ⓒ Drain pan
- Ⓓ ≥ 70 mm
- Ⓔ ≥ 2 × Ⓕ ≥ 70 mm
- Ⓖ ≥ 35 mm
- Ⓗ Downward slope 20 mm/m or more
- Ⓙ Drain trap
- Ⓚ The drain pipe should extend below this level.
- Ⓛ Open drain

[Fig.8.0.1]

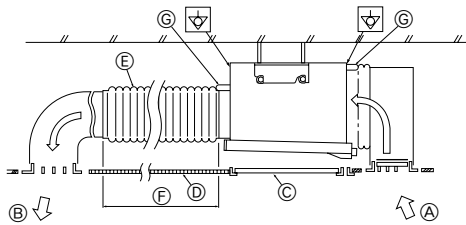

- Ⓐ Air inlet
- Ⓑ Air outlet
- Ⓒ Access door
- Ⓓ Ceiling surface
- Ⓔ Canvas duct
- Ⓕ Keep duct-work length 850 or more
- Ⓖ Connect common reference potential wire between duct-work to air conditioner

[Fig.8.0.2] \* In case of PEA-200, 250

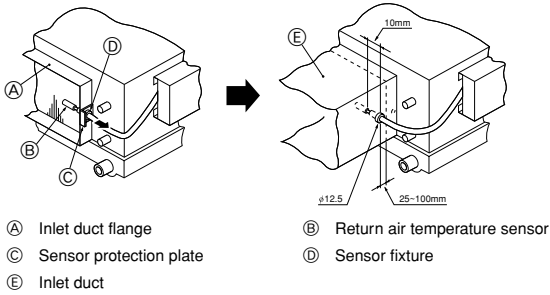

\* In case of PEA-400, 500

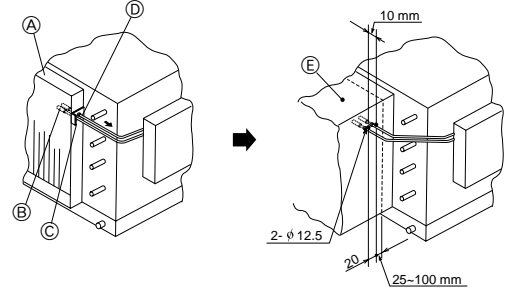

[Fig.8.0.3] \* In case of PEA-200, 250

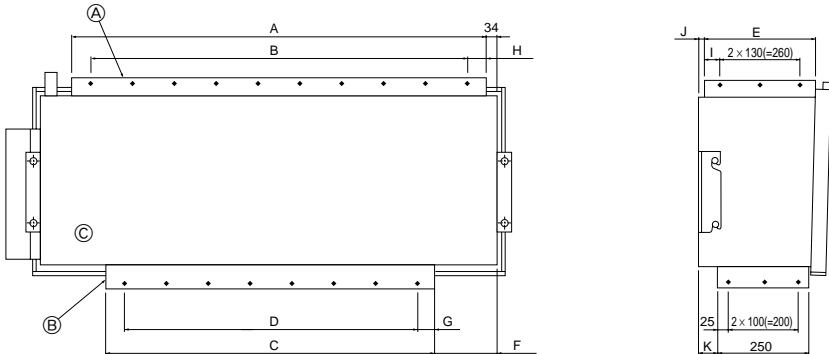

Model	A	B	C	D	E	F	G	H	I	J	K
PEA-200	1102	8 × 130 (=1040)	1000	7 × 130 (=910)	330	105 205	45	31 66	35	22	95
PEA-250	1302	9 × 130 (=1170)									

\* In case of PEA-400, 500

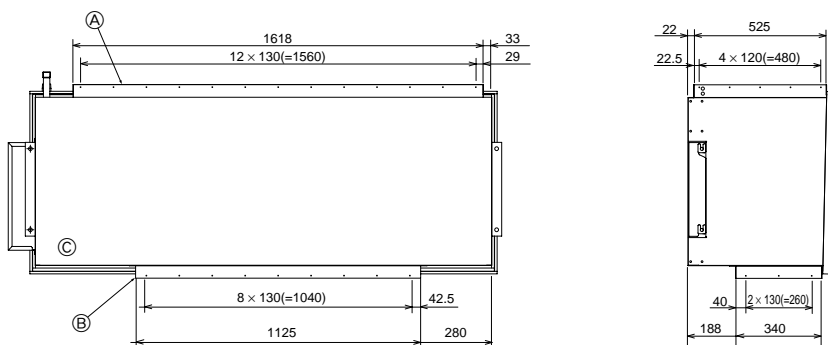

- Ⓐ Inlet duct flange
- Ⓑ Outlet duct flange
- Ⓒ Top of the unit

[Fig.9.0.1]

\* In case of PEA-200, 250

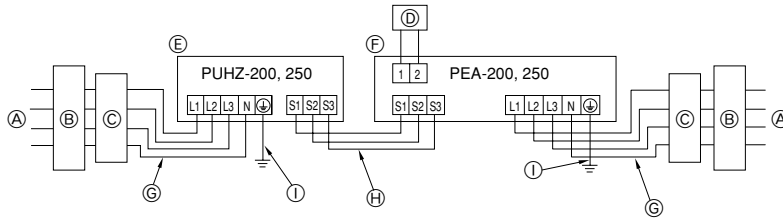

\* In case of PEA-400, 500

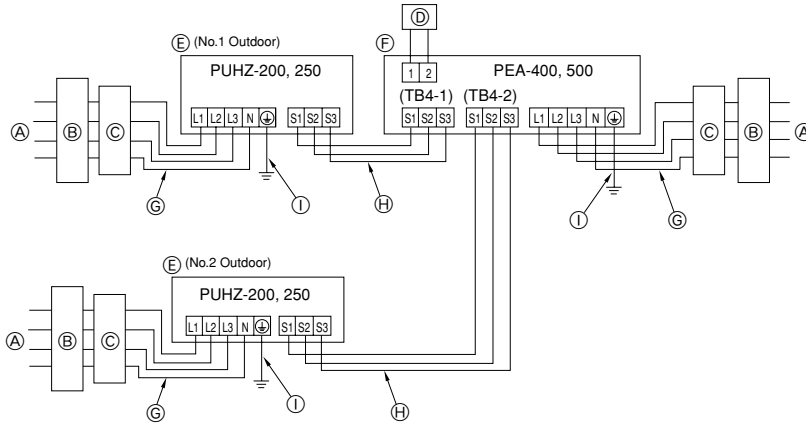

- Ⓐ Power supply
- Ⓑ Earth leakage breaker
- Ⓒ Circuit breaker or local switch
- Ⓓ LCD remote controller (option)
- Ⓔ Outdoor unit
- Ⓕ Indoor unit
- Ⓖ Power cable wiring
- Ⓗ Indoor/Outdoor connection wiring
- Ⓘ Grounding

[Fig.9.0.2]

\* In case of PEA-200, 250

\* In case of PEA-400, 500

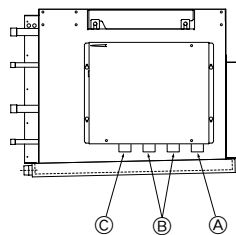
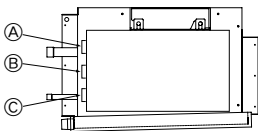

- Ⓐ For remote controller cables
- Ⓑ For outdoor unit connection cables
- Ⓒ For power supply cables

# 10

# 10.1

[Fig.10.1.1]

\* In case of PEA-200, 250

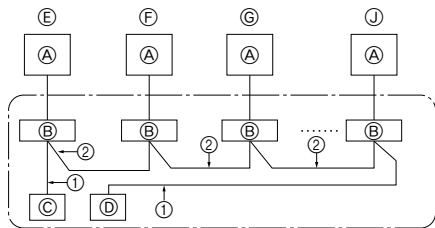

\* In case of PEA-400, 500

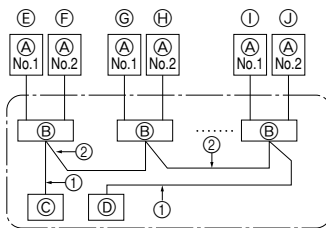

- Ⓐ Outdoor unit
- Ⓑ Indoor unit
- Ⓒ Main remote controller
- Ⓓ Subordinate remote controller
- Ⓔ Standard (Refrigerant address = 00)
- Ⓕ Refrigerant address = 01
- Ⓖ Refrigerant address = 02
- Ⓗ Refrigerant address = 03
- Ⓘ Refrigerant address = 14
- Ⓙ Refrigerant address = 15

# 11

# 11.1

[Fig.11.1.1]

(1)

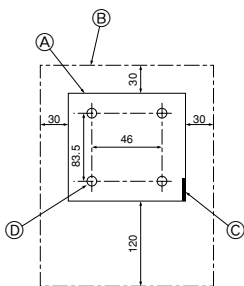

- Ⓐ Remote controller profile
- Ⓑ Required clearances surrounding the remote controller
- Ⓒ Temperature sensor
- Ⓓ Installation pitch

(2)

<A> For installation in the switch box:

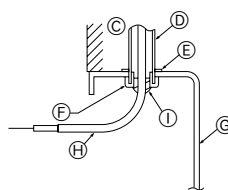

<B> For direct installation on the wall select one of the following:

B-1.

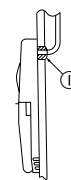

B-2.

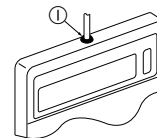

- Ⓒ Wall
- Ⓓ Conduit
- Ⓔ Lock nut
- Ⓕ Bushing
- Ⓖ Switch box
- Ⓗ Remote controller cord
- Ⓘ Seal with putty

(3)

<A> For installation in the switch box

<B> For direct installation on the wall

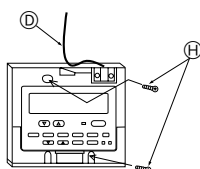
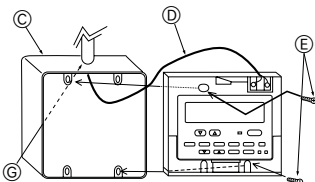

- Ⓒ Switch box for two pieces
- Ⓓ Remote controller cord
- Ⓔ Cross-recessed, pan-head screw
- Ⓕ Seal the remote controller cord service entrance with putty
- Ⓗ Wood screw

# 11.2

[Fig.11.2.1]

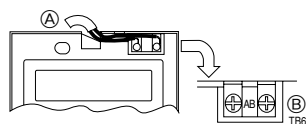

- Ⓐ To TB5 on the indoor unit
  - Ⓑ Terminal block TB6 in remote controller
- No polarity

# 11.3

[Fig.11.3.1]

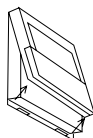
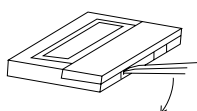

[Fig.11.3.2]

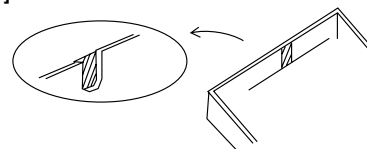

# Contents

1. Safety precautions .....	7	9. Electrical wiring .....	11
1.1. Before installation .....	8	10. System control .....	12
1.2. Before installation (relocation) .....	8	10.1 Grouping by using LCD remote controller .....	12
1.3. Before electrical work .....	8	10.2 Examples of refrigerant system address setting .....	12
1.4. Before starting the test run .....	8	11. LCD remote controller .....	13
2. Indoor unit accessories .....	8	11.1. Installing procedures .....	13
3. Selecting an installation site .....	8	11.2. Connecting procedures .....	13
3.1. Install the indoor unit on a ceiling strong enough to sustain its weight .....	8	11.3. Fitting the upper case .....	13
3.2. Securing installation and service space .....	8	11.4. Function selection .....	13
3.3. Combining indoor units with outdoor units .....	9	12. Test run .....	17
4. Fixing hanging bolts .....	9	12.1. Before test run .....	17
4.1. Fixing hanging bolts .....	9	12.2. Test run procedures .....	17
5. Installing the unit .....	9	12.3. Self-check .....	18
5.1. Hanging the unit body .....	9	12.4. Remote controller check .....	18
5.2. Confirming the unit's position and fixing hanging bolts .....	9	13. Troubleshooting .....	19
6. Refrigerant pipe and drain pipe specifications .....	10	13.1. How to handle problems with the test run .....	19
6.1. Refrigerant pipe and drain pipe specifications .....	10	13.2. The following occurrences are not problems or errors .....	20
6.2. Refrigerant pipe, drain pipe and filling port .....	10		
7. Connecting refrigerant pipes and drain pipes .....	10		
7.1. Refrigerant piping work .....	10		
7.2. Drain piping work .....	10		
8. Duct work .....	11		

**Note:**  
The phrase "Wired remote controller" in this installation manual refers only to the PAR-21MAA. If you need any information for THE PAR-30MAA, please refer to either the installation manual or initial setting manual which are included in PAR-30MAA box.

GB

## 1. Safety precautions

- ▶ **Before installing the unit, make sure you read all the "Safety precautions".**
- ▶ **The "Safety precautions" provide very important points regarding safety. Make sure you follow them.**

### Symbols used in the text

#### **Warning:**





Describes precautions that should be observed to prevent danger of injury or death to the user.

#### **Caution:**

Describes precautions that should be observed to prevent damage to the unit.

After installation work has been completed, explain the "Safety Precautions", use, and maintenance of the unit to the customer according to the information in the Operation Manual and perform the test run to ensure normal operation. Both the Installation Manual and Operation Manual must be given to the user for keeping. These manuals must be passed on to subsequent users.

### Symbols put on the unit

-  : Indicates an action that must be avoided.
-  : Indicates that important instructions must be followed.
-  : Indicates a part which must be grounded.
-  : Beware of electric shock. (This symbol is displayed on the main unit label.)  
<Color: yellow>

 **Warning:**  
**Carefully read the labels affixed to the main unit.**

#### **Warning:**

- **Ask the dealer or an authorized technician to install the air conditioner.**
  - Improper installation by the user may result in water leakage, electric shock, or fire.
- **This appliance is not intended for use by persons (including children) with reduced physical, sensory or mental capabilities, or lack of experience and knowledge, unless they have been given supervision or instruction concerning use of the appliance by a person responsible for their safety.**
- **Install the unit at a place that can withstand its weight.**
  - Inadequate strength may cause the unit to fall down, resulting in injuries.
- **Use the specified cables for wiring. Make the connections securely so that the outside force of the cable is not applied to the terminals.**
  - Inadequate connection and fastening may generate heat and cause a fire.
- **Prepare for strong winds and earthquakes and install the unit at the specified place.**
  - Improper installation may cause the unit to topple and result in injury.
- **Always use an filter and other accessories specified by Mitsubishi Electric.**
  - Ask an authorized technician to install the accessories. Improper installation by the user may result in water leakage, electric shock, or fire.

- **Never repair the unit. If the air conditioner must be repaired, consult the dealer.**
  - If the unit is repaired improperly, water leakage, electric shock, or fire may result.
- **If the supply cord is damaged, it must be replaced by the manufacturer, its service agent or similarly qualified persons in order to avoid a hazard.**
- **Do not touch the heat exchanger fins.**
  - Improper handling may result in injury.
- **When handling this product, always wear protective equipment.**  
**EG: Gloves, full arm protection namely boiler suit, and safety glasses.**
  - Improper handling may result in injury.
- **If refrigerant gas leaks during installation work, ventilate the room.**
  - If the refrigerant gas comes into contact with a flame, poisonous gases will be released.
- **Install the air conditioner according to this Installation Manual.**
  - If the unit is installed improperly, water leakage, electric shock, or fire may result.
- **Have all electric work done by a licensed electrician according to "local regulations" and the instructions given in this manual.**
  - If the power source capacity is inadequate or electric work is performed improperly, electric shock and fire may result.
- **Securely install the outdoor unit terminal cover (panel).**
  - If the terminal cover (panel) is not installed properly, dust or water may enter the outdoor unit and fire or electric shock may result.
- **When installing or relocating the unit, make sure that no substance other than the specified refrigerant (R410A) enters the refrigerant circuit.**
  - Any presence of foreign substance such as air can cause abnormal pressure rise or explosion.
- **If the air conditioner is installed in a small room, measures must be taken to prevent the refrigerant concentration in the room from exceeding the safety limit in the event of the refrigerant leakage.**
  - Consult the dealer regarding the appropriate measures to prevent the safety limit from being exceeded. Should the refrigerant leak and cause the safety limit to be exceeded, hazards due to lack of oxygen in the room could result.
- **When moving and reinstalling the air conditioner, consult the dealer or an authorized technician.**
  - If the air conditioner is installed improperly, water leakage, electric shock, or fire may result.
- **After completing installation work, make sure that refrigerant gas is not leaking.**
  - If the refrigerant gas leaks and is exposed to a fan heater, stove, oven, or other heat source, it may generate noxious gases.
- **Do not reconstruct or change the settings of the protection devices.**
  - If the pressure switch, thermal switch, or other protection device is shorted and operated forcibly, or parts other than those specified by Mitsubishi Electric are used, fire or explosion may result.
- **To dispose of this product, consult your dealer.**
- **The installer and system specialist shall secure safety against leakage according to local regulation or standards.**
  - Following standards may be applicable if local regulation are not available.
- **Pay a special attention to the place, such as a basement, etc. where refrigeration gas can stay, since refrigeration is heavier than the air.**
- **Children should be supervised to ensure that they do not play with the appliance.**

## 1.1. Before installation

### ⚠ Caution:

- **Do not install the unit where combustible gas may leak.**
  - If the gas leaks and accumulates around the unit, an explosion may result.
- **Do not use the air conditioner where food, pets, plants, precision instruments, or artwork are kept.**
  - The quality of the food, etc. may deteriorate.
- **Do not use the air conditioner in special environments.**
  - Oil, steam, sulfuric smoke, etc. can significantly reduce the performance of the air conditioner or damage its parts.
- **When installing the unit in a hospital, communication station, or similar place, provide sufficient protection against noise.**
  - The inverter equipment, private power generator, high-frequency medical equipment, or radio communication equipment may cause the air conditioner to operate erroneously, or fail to operate. On the other hand, the air conditioner may affect such equipment by creating noise that disturbs medical treatment or image broadcasting.
- **Do not install the unit on a structure that may cause leakage.**
  - When the room humidity exceeds 80 % or when the drain pipe is clogged, condensation may drip from the indoor unit. Perform collective drainage work together with the outdoor unit, as required.

## 1.2. Before installation (relocation)

- **Do not wash the air conditioner units.**
  - Washing them may cause an electric shock.
- **Be careful that the installation base is not damaged by long use.**
  - If the damage is left uncorrected, the unit may fall and cause personal injury or property damage.
- **Install the drain piping according to this Installation Manual to ensure proper drainage. Wrap thermal insulation around the pipes to prevent condensation.**
  - Improper drain piping may cause water leakage and damage to furniture and other possessions.
- **Be very careful about product transportation.**
  - Only one person should not carry the product if it weighs more than 20 kg.
  - Some products use PP bands for packaging. Do not use any PP bands for a means of transportation. It is dangerous.
  - Do not touch the heat exchanger fins. Doing so may cut your fingers.
- **Safely dispose of the packing materials.**
  - Packing materials, such as nails and other metal or wooden parts, may cause stabs or other injuries.
  - Tear apart and throw away plastic packaging bags so that children will not play with them. If children play with a plastic bag which was not torn apart, they face the risk of suffocation.

## 2. Indoor unit accessories

The unit is provided with the following accessories:

[Fig. 2.0.1] (P.2)

	Accessory name	Model (Qty*)	
		PEA-200, 250	PEA-400, 500
①	Pipe cover (For field piping connection) <ul style="list-style-type: none"><li>• Small diameter</li><li>• Large diameter</li></ul>	1 1	2 2

## 3. Selecting an installation site

- Select a site with sturdy fixed surface sufficiently durable against the weight of unit.
- Before installing unit, the routing to carry in unit to the installation site should be determined.
- Select a site where the unit is not affected by entering air.
- Select a site where the flow of supply and return air is not blocked.
- Select a site where refrigerant piping can easily be led to the outside.
- Select a site which allows the supply air to be distributed fully in room.
- Do not install unit at a site with oil splashing or steam in much quantity.
- Do not install unit at a site where combustible gas may generate, flow in, stagnate or leak.
- Do not install unit at a site where equipment generating high frequency waves (a high frequency wave welder for example) is provided.
- Do not install unit at a site where fire detector is located at the supply air side. (Fire detector may operate erroneously due to the heated air supplied during heating operation.)
- When special chemical product may scatter around such as site chemical plants and hospitals, full investigation is required before installing unit. (The plastic components may be damaged depending on the chemical product applied.)

## 1.3. Before electrical work

### ⚠ Caution:

- **Ground the unit.**
  - Do not connect the ground wire to gas or water pipes, lightning rods, or telephone ground lines. Improper grounding may result in electric shock.
- **Install the power cable so that tension is not applied to the cable.**
  - Tension may cause the cable to break and generate heat and cause a fire.
- **Install an earth leakage circuit breaker, as required.**
  - If an earth leakage circuit breaker is not installed, electric shock may result.
- **Use power line cables of sufficient current carrying capacity and rating.**
  - Cables that are too small may leak, generate heat, and cause a fire.
- **Use only a circuit breaker and fuse of the specified capacity.**
  - A fuse or circuit breaker of a larger capacity or a steel or copper wire may result in a general unit failure or fire.

## 1.4. Before starting the test run

### ⚠ Caution:

- **Turn on the power at least 12 hours before starting operation.**
  - Starting operation immediately after turning on the main power switch can result in severe damage to internal parts. Keep the power switch turned on during the operational season.
- **Do not touch the switches with wet fingers.**
  - Touching a switch with wet fingers can cause electric shock.
- **Do not touch the refrigerant pipes during and immediately after operation.**
  - During and immediately after operation, the refrigerant pipes are may be hot and may be cold, depending on the condition of the refrigerant flowing through the refrigerant piping, compressor, and other refrigerant cycle parts. Your hands may suffer burns or frostbite if you touch the refrigerant pipes.
- **Do not operate the air conditioner with the panels and guards removed.**
  - Rotating, hot, or high-voltage parts can cause injuries.
- **Do not turn off the power immediately after stopping operation.**
  - Always wait at least five minutes before turning off the power. Otherwise, water leakage and trouble may occur.

- If the indoor unit is run in a place subject to high temperatures and humidity (the dew-point temperature is 26 °C or more inside the ceiling) for a long time, dew condensation may occur on the indoor unit. When operated under such condition, add more insulating material (10-20 mm) on the surface of the indoor unit to prevent dew condensation.

### 3.1. Install the indoor unit on a ceiling strong enough to sustain its weight

#### ⚠ Warning:

The unit must be securely installed on a structure that can sustain its weight. If the unit is mounted on an unstable structure, it may fall down causing injuries.

### 3.2. Securing installation and service space

- Select the optimum direction of supply airflow according to the configuration of the room and the installation position.
- As the piping and wiring are connected at the bottom and side surfaces, and the maintenance is made at the same surfaces, allow a proper space properly. For the efficient suspension work and safety, provide a space as much as possible.



## Service space

### [Fig. 3.2.1] (P.2)

- ① When connecting air inlet
- ② When installing the suspension fixtures prior to installation of the indoor unit without inlet duct
- ③ When hanging the indoor unit directly without inlet duct
- Ⓐ Service space                      Ⓑ Air inlet
- Ⓒ Air outlet

## Suspension bolt pitch

### [Fig. 3.2.2] (P.2)

- Ⓓ Suspension bolt pitch                      Ⓔ Top of the unit
- Ⓕ Suspension bolt holes  
(PEA-200, 250 : 4-φ12 holes)  
(PEA-400, 500 : 4-φ15 holes)
- Ⓖ Control box                                  Ⓗ Drain pan
- Ⓙ Main body

## 3.3. Combining indoor units with outdoor units

For combining indoor units with outdoor units, refer to the outdoor unit installation manual.

## 4. Fixing hanging bolts

### 4.1. Fixing hanging bolts

#### Hanging structure

• Ceiling: The ceiling structure varies from building to one another. For detailed information, consult your construction company.

- ① Reinforcing the ceiling with additional members (edge beam, etc.) must be required to keep the ceiling at level and to prevent the ceiling from vibrations.
- ② Cut and remove the ceiling members.
- ③ Reinforce the ceiling members, and add other members for fixing the ceiling boards.

#### For wooden construction

- Use the tie beam (for one story building) or second-floor beam (for two story building) as strength members.
- To hang the air-conditioner, use a hard square timber of more than 6 cm if the distance between beams is less than 90 cm and a hard square timber of more than 9 cm if the distance between beams is less than 180 cm.

### [Fig. 4.1.1] (P.2)

- Ⓐ Ceiling board                      Ⓑ Edge beam                      Ⓒ Tie beam
- Ⓓ Square timber for hanging the air conditioner                      Ⓔ Pitch

#### For reinforced concrete construction

- As shown in the figure below, fix the hanging bolts, or use square timbers to fix the hanging bolts.

### [Fig. 4.1.2] (P.2)

- Ⓕ Insert: 100 to 150 kg (1 piece) (field supply)
- Ⓖ Hanging bolt (field supply)  
PEA-200, 250 : M10  
PEA-400, 500 : M12
- Ⓗ Reinforcement

#### Product Weight (kg)

PEA-200	70 kg
PEA-250	77 kg
PEA-400	130 kg
PEA-500	133 kg

## 5. Installing the unit

### 5.1. Hanging the unit body

- ▶ Bring the indoor unit to an installation site as it is packed.
- ▶ To hang the indoor unit, use a lifting machine to lift and pass through the hanging bolts.
- ▶ Install the indoor unit before ceiling work.

#### [Fig. 5.1.1] (P.3)

- Ⓐ Unit body                                  Ⓑ Lifting machine

\* Two installation methods are available  
<When hanging the indoor unit directly>

1. Attach a washer and nut(s) to each suspension bolt. (The washers and nuts are to be supplied locally.)
2. Fit the indoor unit to each suspension bolt.
3. Make sure that the unit is positioned level, then tighten each nut.

#### [Fig. 5.1.2] (P.3)

- Ⓐ Nut    Ⓑ Washer

	A	B
When using inlet duct	100 or more	130 or more
When not using inlet duct	0 or more	30 or more

Nut (\*1) is not required if distance A is 0.

<When installing the suspension fixture prior to installation of the indoor unit>

1. Loosen each suspension fixture bolt slightly, and remove the fixture and U-shaped washers.
2. Adjust each suspension fixture bolt.

3. Attach a washer, nut and suspension fixture to each suspension bolt. (The washers and nuts are to be supplied locally.)
4. Hook the indoor unit to the suspension fixtures.
5. Make sure that the unit is positioned level, then tighten each nut.

#### [Fig. 5.1.3] (P.3)

- Ⓐ Be sure to attach a U-shaped washer (4 washers in total).

	A	B
When using inlet duct	100 or more	130 or more
When not using inlet duct	25 or more	55 or more

### 5.2. Confirming the unit's position and fixing hanging bolts

#### [Fig. 5.2.1] (P.3)

- Ⓐ Level check

- ▶ Use the gage supplied with the panel to confirm that the unit body and hanging bolts are positioned in place. If they are not positioned in place, it may result in dew drops due to wind leak. Be sure to check the positional relationship.
- ▶ Use a level to check that the surface indicated by Ⓐ is at level. Ensure that the hanging bolt nuts are tightened to fix the hanging bolts.
- ▶ To ensure that drain is discharged, be sure to hang the unit at level using a level.

#### ⚠ Caution:

Be sure to install the unit body at level.

## 6. Refrigerant pipe and drain pipe specifications

To avoid dew drops, provide sufficient antisweating and insulating work to the refrigerant and drain pipes.

When using commercially available refrigerant pipes, be sure to wind commercially available insulating material (with a heat-resisting temperature of more than 100 °C and thickness given below) onto both liquid and gas pipes.

Be also sure to wind commercially available insulating material (with a form polyethylene's specific gravity of 0.03 and thickness given below) onto all pipes which pass through rooms.

- ① Select the thickness of insulating material by pipe size.

Pipe size	Insulating material's thickness
6.4 mm to 25.4 mm	More than 10 mm
28.6 mm to 38.1 mm	More than 15 mm

- ② If the unit is used on the highest story of a building and under conditions of high temperature and humidity, it is necessary to use pipe size and insulating material's thickness more than those given in the table above.
- ③ If there are customer's specifications, simply follow them.

### 6.1. Refrigerant pipe and drain pipe specifications

Item	Model	PEA-200	PEA-250	PEA-400	PEA-500
Refrigerant pipe	Liquid pipe	ø9.52	ø12.7	ø9.52	ø12.7
	Gas pipe	ø25.4			
Drain pipe		R1 (Male screw)			

### 6.2. Refrigerant pipe, drain pipe and filling port

[Fig. 6.2.1] (P.3)

- Ⓐ Refrigerant pipe (liquid pipe)      Ⓑ Refrigerant pipe (gas pipe)  
 Ⓒ Drain pipe

## 7. Connecting refrigerant pipes and drain pipes

### 7.1. Refrigerant piping work

This piping work must be done in accordance with the installation manuals for outdoor unit.

- The method of pipe connection is brazing connection.

#### Cautions on refrigerant piping

- ▶ **Be sure to use non-oxidative brazing for brazing to ensure that no foreign matter or moisture enter into the pipe.**
- ▶ **Provide a metal brace to support the refrigerant pipe so that no load is imparted to the indoor unit end pipe. This metal brace should be provided 50 cm away from the indoor unit's brazing connection.**

#### ⚠ Warning:

**When installing or relocating the unit, make sure that no substance other than the specified refrigerant (R410A) enters the refrigerant circuit.**

- Any presence of foreign substance such as air can cause abnormal pressure rise or explosion.

#### ⚠ Caution:

- **Install the refrigerant piping for the indoor unit in accordance with the following.**

- Remove the cap.

[Fig. 7.1.1] (P.3)

- Ⓐ Remove the cap

- Pull out the thermal insulation on the site refrigerant piping, braze the unit piping, and replace the insulation in its original position. Wrap the piping with insulating tape.

[Fig. 7.1.2] (P.3)

- Ⓐ Thermal insulation      Ⓑ Pull out insulation  
 Ⓒ Wrap with damp cloth      Ⓓ Return to original position  
 Ⓔ Ensure that there is no gap here      Ⓕ Wrap with insulating tape  
 Ⓖ Pipe cover (Accessory part)

#### Note:

- **Pay strict attention when wrapping the copper piping since wrapping the piping may cause condensation instead of preventing it.**
- \* Before brazing the refrigerant piping, **always wrap the piping on the main body, and the thermal insulation piping, with damp cloths to prevent heat shrinkage and burning the thermal insulation tubing.** Take care to ensure that the flame does not come into contact with the main body itself.

#### ⚠ Caution:

- **Use refrigerant piping made of C1220 (CU-DHP) phosphorus deoxidized copper as specified in the JIS H3300 "Copper and copper alloy seamless pipes and tubes". In addition, be sure that the inner and outer surfaces of the pipes are clean and free of hazardous sulphur, oxides, dust/dirt, shaving particles, oils, moisture, or any other contaminant.**
- **Never use existing refrigerant piping.**
  - The large amount of chlorine in conventional refrigerant and refrigerator oil in the existing piping will cause the new refrigerant to deteriorate.
- **Store the piping to be used during installation indoors and keep both ends of the piping sealed until just before brazing.**
  - If dust, dirt, or water gets into the refrigerant cycle, the oil will deteriorate and the compressor may fail.
- **Do not use a leak detection additive.**

### Additional refrigerant charge

- Take care not to allow dirt or cutting chips to enter the refrigerant pipes.
- The refrigerant pipes must be kept warm, so take particular care to insulate between refrigerant pipes and the gas pipe located inside the indoor unit, since the gas pipe causes condensation during cooling operation.
- When connecting the refrigerant pipes, make sure that the stop valve of the outdoor unit is fully closed (as it was when shipped from the factory). After connecting all the refrigerant pipes between the indoor and outdoor units, purge air from the stop valve service port of the outdoor unit and service port of each connecting pipe. Check that there is no air leakage from any pipe connection, then fully open the stop valve of the outdoor unit. This will connect the refrigerant circuit between the indoor and outdoor units.
- The refrigerant pipes must be as short as possible.
- The indoor and outdoor units must be connected with the refrigerant pipes.

[Fig. 7.1.3] (P.3)

- Ⓐ Brazing      Ⓑ Gas pipe  
 Ⓒ Liquid pipe      Ⓓ Indoor unit  
 Ⓔ Outdoor unit

### 7.2. Drain piping work

[Fig. 7.2.1] (P.4)

- Ⓐ Insulator      Ⓑ Drain pipe R1  
 Ⓒ Drain pan      Ⓓ  $\geq 70$  mm  
 Ⓔ  $\geq 2 \times \text{Ⓔ} \geq 70$  mm      Ⓕ  $\geq 35$  mm  
 Ⓖ Downward slope 20 mm/m or more      Ⓖ Drain trap  
 Ⓗ The drain pipe should extend below this level.  
 Ⓙ Open drain

1. Ensure that a drain trap is installed. If this is neglected, condensation may occur inside the indoor unit leading to water leakage/equipment breakdown, etc.
2. Ensure that the drain piping is downward (pitch of more than 20 mm/m) to the outdoor (discharge) side.
3. Ensure that any cross-wise drain piping is less than 20 m (excluding the difference of elevation). If the drain piping is long, provide metal braces to prevent it

4. Use a hard vinyl chloride pipe VP-25 (with an external diameter of 32 mm) for drain piping.
5. Ensure that collected pipes are 10 cm lower than the unit body's drain port.
6. Put the end of the drain piping in a position where no odor is generated.
7. Do not put the end of the drain piping in any drain where ionic gases are generated.

## 8. Duct work

- In connecting duct, insert canvas duct between unit and duct.
- Use incombustible material for duct parts.
- Provide full insulation to inlet duct flange, outlet duct flange and outlet duct to prevent condensation.
- Be sure to apply the air filter near the air inlet grille.
- Before connecting an inlet duct, remove the air filter, then install that filter in the inlet grille.

### [Fig. 8.0.1] (P.4)

- |  |                                     |
|--|-------------------------------------|
| Ⓐ Air inlet  | Ⓑ Air outlet                        |
| Ⓒ Access door  | Ⓓ Ceiling surface                   |
| Ⓔ Canvas duct  | Ⓕ Keep duct-work length 850 or more |
| Ⓖ Connect common reference potential wire between duct-work to air conditioner |                                     |

### ⚠ Caution:

- **Outlet duct is 850 mm or more necessary to construct.**
- **To connect the air conditioner main body and the duct for potential equalization.**
- Return air temperature sensor when an inlet duct is installed. A return air temperature sensor is installed on the inlet duct flange. Before connecting an inlet duct, this sensor must be removed and installed in the specified position.

### [Fig. 8.0.2] (P.4)

- |                           |                                 |
|---------------------------|---------------------------------|
| Ⓐ Inlet duct flange       | Ⓑ Return air temperature sensor |
| Ⓒ Sensor protection plate | Ⓓ Sensor fixture                |
| Ⓔ Inlet duct              |                                 |

- ① Pull out the sensor, and remove the sensor fixture and protection plate. (The protection plate must be discarded.)
  - ② Connect the inlet duct.
  - ③ Drill a sensor hole (ø12.5 dia.) on the side on the duct.
  - ④ Assemble the sensor and fixture.
- When pulling out the sensor, do not pull it by the lead wire. Doing so may result in wire breakage.
  - Before connecting the inlet duct, make sure that the sensor, its fixture and protection plate are removed.
  - The sensor removed in step ① must be re-installed in the position specified in the drawing. Installation of the sensor in an incorrect position may result in malfunction.

## Mount holes for outlet duct flange and inlet duct.

### [Fig. 8.0.3] (P.4)

- |                      |
|----------------------|
| Ⓐ Inlet duct flange  |
| Ⓑ Outlet duct flange |
| Ⓒ Top of the unit    |

## 9. Electrical wiring

### Precautions on electrical wiring

#### ⚠ Warning:

Electrical work should be done by qualified electrical engineers in accordance with "local regulations" and supplied installation manuals. Special circuits should also be used. If the power circuit lacks capacity or has an installation failure, it may cause a risk of electric shock or fire.

1. Be sure to take power from the special branch circuit.
2. Be sure to install an earth leakage breaker to the power.
3. Install the unit to prevent that any of the control circuit cables (remote controller, transmission cables) is brought in direct contact with the power cable outside the unit.
4. Ensure that there is no slack on all wire connections.
5. Some cables (power, remote controller, transmission cables) above the ceiling may be bitten by mice. Use as many metal pipes as possible to insert the cables into them for protection.
6. Never connect the power cable to leads for the transmission cables. Otherwise the cables would be broken.
7. Be sure to connect control cables to the indoor unit, remote controller, and the outdoor unit.
8. Put the unit to the ground on the outdoor unit side.
9. Be sure to connect between the control cable terminal block of the outdoor unit and that of the indoor unit. (Cables have polarity, so make sure that they are connected according to the terminal numbers.)
10. Fix power source wiring to control box by using buffer bushing for tensile force (PG connection or the like). Connect control wiring to control terminal bed through the knockout hole of control box using ordinary bushing.
11. Do not connect the unit in the reverse phase sequence. If connected in the reverse phase sequence, the indoor unit will not be able to provide sufficient cooling air.

In case of A-control wiring there is high voltage potential on the S3 terminal caused by electrical circuit design that has no electrical insulation between power line and communication signal line. Therefore, please turn off the main power supply when servicing. And do not touch the S1, S2, S3 terminals when the power is energized. If isolator should be used between indoor unit and outdoor unit, please use 3-poles type.

#### ⚠ Caution:

Be sure to put the unit to the ground on the outdoor unit side. Do not connect the earth cable to any gas pipe, water pipe, lightning rod, or telephone earth cable. Incomplete grounding may cause a risk of electric shock.

### [Fig. 9.0.1] (P.5)

- |                                    |
|------------------------------------|
| Ⓐ Power supply                     |
| Ⓑ Earth leakage breaker            |
| Ⓒ Circuit breaker or local switch  |
| Ⓓ LCD remote controller (option)   |
| Ⓔ Outdoor unit                     |
| Ⓕ Indoor unit                      |
| Ⓖ Power cable wiring               |
| Ⓗ Indoor/Outdoor connection wiring |
| Ⓘ Grounding                        |

#### ⚠ Caution:

For PEA-400, 500, make sure that refrigerant pipes and wirings be connected from Outdoor unit No.1 to Indoor unit No.1 and Outdoor unit No.2 to Indoor unit No.2 respectively.

Wiring from Outdoor unit No.1 must be connected to terminal bed TB4-1, and wiring from Outdoor unit No.2 must be connected to TB4-2 in Indoor unit control box.

Any mistakes on those connections may cause an abnormal refrigerant pipe temperature and etc.

**[Wiring example]** (For metal piping)

Earth leakage breaker *1, *2	Local switch		Circuit breaker	Power cable *4	Earth cable	Indoor and outdoor connection wiring *5	Remote controller wiring
	Switch capacity <A>	Overcurrent protector *3 <A>					
15 A 30 mA 0.1s. or less	16	16	15	1.5 mm <sup>2</sup> or more	1.5 mm <sup>2</sup> or more	1.5 mm <sup>2</sup> or more	0.3 - 1.25 mm <sup>2</sup> (max. DC 12V)

**Notes:**

- \*1: Connect an earth leakage breaker to the power supply.
- \*2: Use earth leakage breakers designed exclusively for ground fault protection only in combination with a local switch or a circuit breaker.
- \*3: The overcurrent protector using a Class-B fuse is shown.
- \*4: Power supply cords shall not be lighter than polychloroprene sheathed flexible cord. (Design 245 IEC 53 or 227 IEC 53)
- \*5: Indoor unit/outdoor unit connecting cords shall not be lighter than polychloroprene sheathed flexible cord (Design 245 IEC 57).
- \*6: A switch with at least 3 mm contact separation in each pole shall be provided by the Air conditioner installation.
- \*7: The connection wiring between the outdoor and indoor units can be extended up to a maximum of 50 m.

**⚠ Caution:**

Do not use anything other than the correct capacity breaker and fuse. Using fuse, wire or copper wire with too large capacity may cause a risk of malfunction or fire.

**Location of cable holes**

[Fig. 9.0.2] (P.5)

- Ⓐ For remote controller cables
- Ⓑ For outdoor unit connection cables
- Ⓒ For power supply cables

## 10. System control

### 10.1 Grouping by using LCD remote controller (option)

Combination of indoor/outdoor unit can be controlled up to a maximum of 16 refrigerant systems.

[Fig. 10.1.1] (P.6)

- Ⓐ Outdoor unit
- Ⓑ Indoor unit
- Ⓒ Main remote controller
- Ⓓ Subordinate remote controller
- Ⓔ Standard (Refrigerant address = 00)
- Ⓕ Refrigerant address = 01
- Ⓖ Refrigerant address = 02
- Ⓖ Refrigerant address = 03
- Ⓗ Refrigerant address = 14
- Ⓙ Refrigerant address = 15

\* Set the refrigerant address using the DIP switch of the outdoor unit.

\* **Refer to the outdoor unit installation manual for setting method of SW1 DIP switch.**

① Wiring from the Remote Control

This wire is connected to TB5 (terminal board for remote controller) of the indoor unit (non-polar).

② When a Different Refrigerant System Grouping is Used

Up to 16 refrigerant systems can be controlled as one group using the LCD remote controller.

**Notes:**

1. In single refrigerant system, there is no need of wiring ②.
2. LCD remote controller can be installed up to a maximum of 2 units for one group.

SW1  
Function table

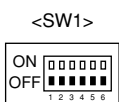

	Function	Operation according to switch setting	
		ON	OFF
SW1 function settings	1 Compulsory de-frosting	Start	Normal
	2 Error history clear	Clear	Normal
	3 Refrigerant system address setting	Settings for outdoor unit addresses 0 to 15	
	4		
	5		
	6		

### 10.2 Examples of refrigerant system address setting

Ex.	Indoor unit	Outdoor unit	Outdoor unit refrigerant system address	Remote controller power supply unit
1	PEA-200, 250	—	00	○
2	PEA-400, 500	No.1	00	○
		No.2	01~15	×

\* Set the refrigerant system address of one outdoor unit to 00 for the power supply to the remote controller.

(The refrigerant system address is set to 00 when shipped from the factory.)  
Do not duplicate the refrigerant system address settings within the same system.

# 11. LCD remote controller (option)

## 11.1. Installing procedures

(1) Select an installing position for the remote controller (switch box).  
Be sure to observe the following precautions.

[Fig.11.1.1] (P.6)

- Ⓐ Remote controller profile
- Ⓑ Required clearances surrounding the remote controller
- Ⓒ Temperature sensor
- Ⓓ Installation pitch

- ① The temperature sensors are located on both remote controller and indoor unit. To use the temperature sensor on the remote controller, mainly use the remote controller for temperature setting or room temperature detection. Install the remote controller in such an area that can detect average room temperatures, free of direct sunlight, airflow from the air conditioner, and other such heating source.
- ② In either case when the remote controller is installed in the switch box or on the wall, provide the clearances indicated in the diagram.

**Note:**

**Check that there is no electric wire left close to the remote controller sensor. If any electric wire is near the sensor, the remote controller may fail to detect a correct room temperature.**

- ③ Procure the following parts locally:  
Switch box for two pieces  
Thin copper conduit tube  
Lock nuts and bushings

(2) Seal the service entrance for the remote controller cord with putty to prevent possible invasion of dew drops, water, cockroaches or worms.

<A> For installation in the switch box:

- When the remote controller is installed in the switch box, seal the junction between the switch box and the conduit tube with putty.

<B> For direct installation on the wall select one of the following:

**B-1. To lead the remote controller cord from the back of the controller:**

- Prepare a hole through the wall to pass the remote controller cord (in order to run the remote controller cord from the back), then seal the hole with putty.

**B-2. To run the remote controller cord through the upper portion:**

- Run the remote controller cord through the cut-out upper case, then seal the cut-out notch with putty similarly as above.

[Fig. 11.1.1] (P.6)

- Ⓒ Wall
- Ⓓ Conduit
- Ⓔ Lock nut
- Ⓕ Bushing
- Ⓖ Switch box
- Ⓗ Remote controller cord
- Ⓘ Seal with putty

(3) Install the lower case in the switch box or on the wall.

[Fig. 11.1.1] (P.6)

<A> For installation in the switch box

- Ⓒ Switch box for two pieces
- Ⓓ Remote controller cord
- Ⓔ Cross-recessed, pan-head screw
- Ⓕ Seal the remote controller cord service entrance with putty

## 11.4. Function selection

<Wired remote controller type>

(1) Function selection of remote controller

The setting of the following remote controller functions can be changed using the remote controller function selection mode. Change the setting when needed.

Item 1	Item 2	Item 3 (Setting content)
1. Change Language ("CHANGE LANGUAGE")	Language setting to display	• Display in multiple languages is possible.
2. Function limit ("FUNCTION SELECTION")	(1) Operation function limit setting (operation lock) ("LOCKING FUNCTION")	• Setting the range of operation limit (operation lock)
	(2) Use of automatic mode setting ("SELECT AUTO MODE")	• Setting the use or non-use of "automatic" operation mode
	(3) Temperature range limit setting ("LIMIT TEMP FUNCTION")	• Setting the temperature adjustable range (maximum, minimum)
	* (4) Use of automatic filter elevation panel up/down operation mode setting	• Setting the use or non-use of the automatic filter elevation panel up/down operation mode
	* (5) Use of fixed airflow direction mode setting	• Setting the use or non-use of the fixed airflow direction mode
3. Mode selection ("MODE SELECTION")	(1) Remote controller main/sub setting ("CONTROLLER MAIN/SUB")	• Selecting main or sub remote controller * When two remote controllers are connected to one group, one controller must be set to sub.
	(2) Use of clock setting ("CLOCK")	• Setting the use or non-use of clock function
	(3) Timer function setting ("WEEKLY TIMER")	• Setting the timer type
	(4) Contact number setting for error situation ("CALL")	• Contact number display in case of error • Setting the telephone number
4. Display change ("DISP MODE SETTING")	(1) Temperature display °C/°F setting ("TEMP MODE °C/°F")	• Setting the temperature unit (°C or °F) to display
	(2) Suction air temperature display setting ("ROOM TEMP DISP SELECT")	• Setting the use or non-use of the display of indoor (suction) air temperature
	(3) Automatic cooling/heating display setting ("AUTO MODE DISP C/H")	• Setting the use or non-use of the display of "Cooling" or "Heating" display during operation with automatic mode

\* This model is not equipped with this function. The setting is invalid.

<B> For direct installation on the wall

- Ⓗ Wood screw

**⚠ Caution:**

Do not over-tighten the screws to possible deformed or broken lower case.

**Note:**

- Select a flat place for installation.
- Be sure to use two or more locations for securing of the remote controller in the switch box or on the wall.

## 11.2. Connecting procedures

- The remote controller cord can be extended up to a maximum of 200 m. Use electric wires or (two-core) cables of 0.3 mm<sup>2</sup> to 1.25 mm<sup>2</sup> for making connection of remote controller. Do not use multi-conductor cables to prevent possible malfunction of the unit.

[Fig. 11.2.1] (P.6)

(1) Connect the remote controller cord to the terminal block at lower case.

- Ⓐ To TB5 on the indoor unit
- Ⓑ Terminal block TB6 in remote controller
- No polarity

**⚠ Caution:**

- Do not use crimp-style terminals for connection to the remote controller terminal block to eliminate contact with the boards and resultant trouble.
- Prevent remote cord chips from getting into the remote controller. Electric shock or malfunction may result.

## 11.3. Fitting the upper case

[Fig. 11.3.1] (P.6)

(1) To remove the upper case, put a slotted screwdriver tip in the latches as shown in the diagram then move the screwdriver in the direction of arrow.

(2) To install the upper case, put the upper latches (at two locations) first, then fit the upper case into the lower case as illustrated.

[Fig. 11.3.2] (P.6)

**Note:**

**Wiring hole for installing directly on the wall (or open wiring)**

- Cut off the shaded area from the upper case using a knife, nippers, etc.
- Take out the remote control cord connected to the terminal block via this portion.

**⚠ Caution:**

- Do not move the screwdriver while inserting the tip far into the latches to prevent broken latches.
- Be sure to put the upper case securely in the latches by pressing it until a snap sounds. Loosely inserted, the upper case may fall down.

**Note:**

**The operating section is covered with a protective sheet. Before using the unit, remember to remove the protective sheet.**

[Function selection flowchart]

[1] Stop the air conditioner to start remote controller function selection mode. → [2] Select from item1. → [3] Select from item2. → [4] Make the setting. (Details are specified in item3) → [5] Setting completed. → [6] Change the display to the normal one. (End)

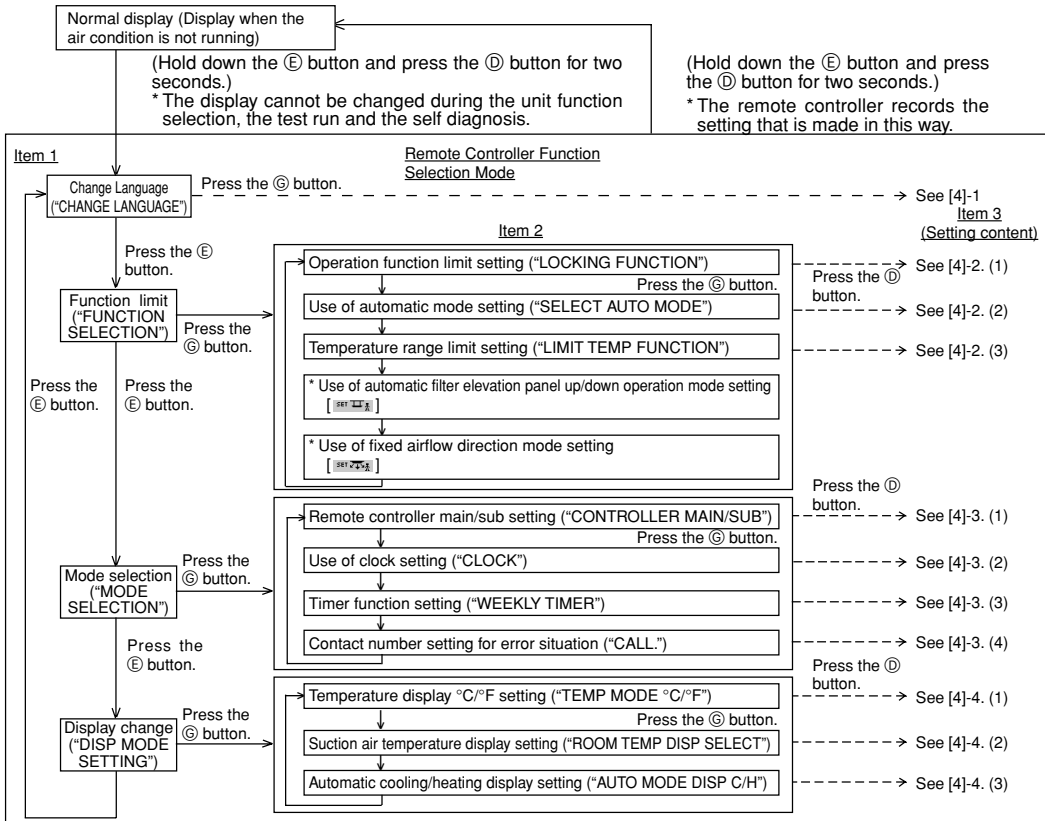

NOTE  
Timer operation stops when the display for remote controller function selection is changed to the normal one.

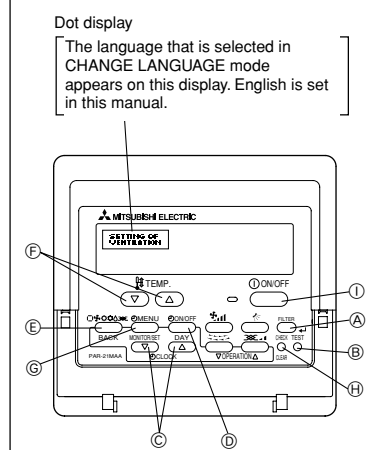

\* This model is not equipped with this function. The setting is invalid.

[Detailed setting]

[4]-1. CHANGE LANGUAGE setting

The language that appears on the dot display can be selected.

- Press the [MENU] button to change the language.
- ① Japanese (JP), ② English (GB), ③ German (D), ④ Spanish (E), ⑤ Russian (RU), ⑥ Italian (I), ⑦ Chinese (CH), ⑧ French (F)

[4]-2. Function limit

(1) Operation function limit setting (operation lock)

- To switch the setting, press the [ON/OFF] button.
- ① no1: Operation lock setting is made on all buttons other than the [ON/OFF] button.
- ② no2: Operation lock setting is made on all buttons.
- ③ OFF (Initial setting value): Operation lock setting is not made.

\* To make the operation lock setting valid on the normal screen, it is necessary to press buttons (Press and hold down the [FILTER] and [ON/OFF] buttons at the same time for two seconds.) on the normal screen after the above setting is made.

(2) Use of automatic mode setting

When the remote controller is connected to the unit that has automatic operation mode, the following settings can be made.

- To switch the setting, press the [ON/OFF] button.
- ① ON (Initial setting value): The automatic mode is displayed when the operation mode is selected.
- ② OFF: The automatic mode is not displayed when the operation mode is selected.

(3) Temperature range limit setting

After this setting is made, the temperature can be changed within the set range.

- To switch the setting, press the [ON/OFF] button.
  - ① LIMIT TEMP COOL MODE: The temperature range can be changed on cooling/dry mode.
  - ② LIMIT TEMP HEAT MODE: The temperature range can be changed on heating mode.
  - ③ LIMIT TEMP AUTO MODE: The temperature range can be changed on automatic mode.
  - ④ OFF (initial setting): The temperature range limit is not active.
- \* When the setting, other than OFF, is made, the temperature range limit setting on cooling, heating and automatic mode is made at the same time. However, the range cannot be limited when the set temperature range has not changed.
- To increase or decrease the temperature, press the [TEMP] (▽) or (△) button.
  - To switch the upper limit setting and the lower limit setting, press the [CALL] button. The selected setting will flash and the temperature can be set.
  - Settable range  
Cooling/Dry mode: Lower limit: 19°C ~ 30°C Upper limit: 30°C ~ 19°C  
Heating mode: Lower limit: 17°C ~ 28°C Upper limit: 28°C ~ 17°C  
Automatic mode: Lower limit: 19°C ~ 28°C Upper limit: 28°C ~ 19°C

\* The settable range varies depending on the unit to connect (Mr. Slim units, Free-plan units, and intermediate temperature units).

[4]-3. Mode selection setting

(1) Remote controller main/sub setting

- To switch the setting, press the [ON/OFF] button.
- ① Main: The controller will be the main controller.
- ② Sub: The controller will be the sub controller.

(2) Use of clock setting

- To switch the setting, press the [ON/OFF] button.
- ① ON: The clock function can be used.
- ② OFF: The clock function cannot be used.

(3) Timer function setting

- To switch the setting, press the [ON/OFF] button (Choose one of the followings).
  - ① WEEKLY TIMER (Initial setting value): The weekly timer can be used.
  - ② AUTO OFF TIMER: The auto off timer can be used.
  - ③ SIMPLE TIMER: The simple timer can be used.
  - ④ TIMER MODE OFF: The timer mode cannot be used.
- \* When the use of clock setting is OFF, the "WEEKLY TIMER" cannot be used.

(4) Contact number setting for error situation

- To switch the setting, press the [ON/OFF] button.
- ① CALL OFF: The set contact numbers are not displayed in case of error.
- ② CALL \*\*\*\* \* : The set contact numbers are displayed in case of error.  
CALL\_: The contact number can be set when the display is as shown on the left.

• Setting the contact numbers  
To set the contact numbers, follow the following procedures.  
Move the flashing cursor to set numbers. Press the [TEMP] (▽) and (△) button to move the cursor to the right (left). Press the [CLOCK] (▽) and (△) button to set the numbers.

[4]-4. Display change setting

(1) Temperature display °C/°F setting

- To switch the setting, press the [ON/OFF] button.
- ① °C: The temperature unit °C is used.
- ② °F: The temperature unit °F is used.

(2) Suction air temperature display setting

- To switch the setting, press the [ON/OFF] button.
- ① ON: The suction air temperature is displayed.
- ② OFF: The suction air temperature is not displayed.

(3) Automatic cooling/heating display setting

- To switch the setting, press the [ON/OFF] button.
- ① ON: One of "Automatic cooling" and "Automatic heating" is displayed under the automatic mode is running.
- ② OFF: Only "Automatic" is displayed under the automatic mode.

## (2) Unit Function Selection

Set the functions of each indoor unit from the remote controller, as required. The functions of each indoor unit can be selected only from the remote controller. Set the functions by selecting the necessary items from Table 1 and Table 2. (Default settings are also shown below)

Table 1. Itemized functions of the entire refrigerant system (select unit number 00 to 15)

Function	Settings	Mode no.	Setting no.	Check	Default settings	Remarks
Power failure automatic recovery	Not available	01	1		○	Approx. 4-minute wait-period after power is restored.
	Available		2			
Indoor temperature detection	Unit operating average	02	1		○	
	Set by unit's remote controller		2			
	Remote controller's internal sensor		3			
LOSSNAY connectivity	Not Supported	03	1		○	
	Supported (unit is not equipped with outdoor-air intake)		2			
	Supported (unit is equipped with outdoor-air intake)		3			
Power voltage	240 V	04	1		○	
	220 V, 230 V		2			

Table 2. Itemized functions of the indoor unit (select unit numbers 01 to 04 or AL)

Function	Settings	Mode no.	Setting no.	Check	Default settings	Remarks
Filter sign	100 Hr	07	1			
	2500 Hr		2			
	No filter sign indicator		3		○	
Fan operation during thermo off in heating operation	Operation (Last set fan speed)	25	3		○ (PEA-400/500)	When selecting fan operation "Stop", set setting no. of Mode no. "02" in Table 1 to "3". Be sure to place the remote controller inside the room to be air-conditioned so that it can monitor the room temperature.
	Stop		2			
	Operation (Low speed)		1		○ (PEA-200/250)	
Fan operation during thermo off in cooling operation	Operation (Last set fan speed)	27	1		○	
	Stop		2			

**Note:**  
When the indoor unit functions were changed using the function selection after installation is complete, always indicate the set contents by entering ○ or other mark in the appropriate check field of Table 1 and Table 2.

### [Function selection flow]

First grasp the function selection flow. The following describes setting of "Power voltage" of Table 1 as an example. (For the actual setting procedure, see [Setting procedure] ① to ⑩.)

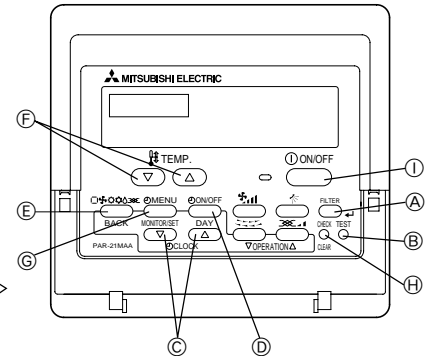
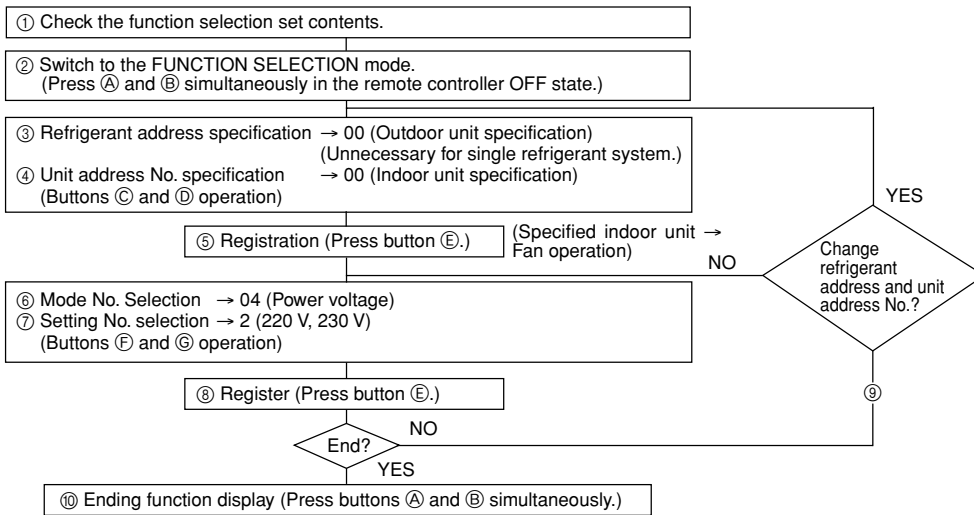

### [Procedure] (Set only when change is necessary.)

- Check the set contents of each mode. When the set contents of a mode were changed by function selection, the functions of that mode also change. Check the set contents as described in steps ② to ⑦ and change the setting based on the entries in the Table 1 and Table 2. (Refer default settings, when change the setting)
- Set the remote controller to Off. Press and hold down the A [FILTER] and B [TEST] buttons at the same time for two seconds or longer. "FUNCTION SELECTION" blinks for a while, then the remote controller display changes to the display shown below.
- Set the outdoor unit refrigerant address No. When the C [CLOCK (▽)] and D [CLOCK (△)] buttons are pressed, the refrigerant address No. decreases and increases between 00 and 15. Set it to the refrigerant address No. whose function you want to select. (This step is unnecessary for single refrigerant system.)

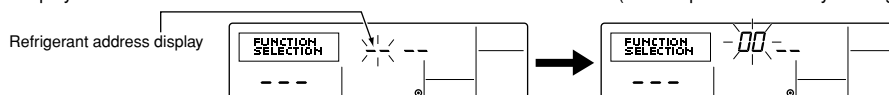

\* If the remote controller enters the OFF state after the "FUNCTION SELECTION" and room temperature displays "BB" have flashes for two seconds, communication is probably abnormal. Make sure there are no noise sources near the transmission line.

**Note:**  
If you make a mistake during operation, end function selection by step ⑩ and repeat selection from step ②.

- ④ Set the indoor unit address No.  
Press the [ON/OFF] button. The unit address No. display “--” flashes.

When the [CLOCK (▽)] and [△] buttons are pressed, the unit address No. changes in 00 → 01 → 02 → 03 → 04 → AL order. Set it to the unit address No. of the indoor unit whose functions you want to set.

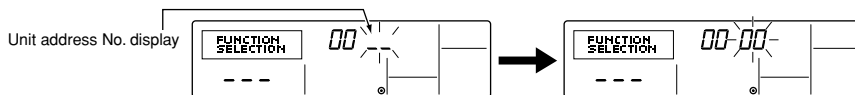

- \* When setting mode 01 to 04, set the unit address No. to “00”.
- \* When setting modes 07, 25, 27:
  - When setting for each indoor unit, set the unit address No. to “01-04”.
  - When batch setting for all indoor units, set the unit address No. to “AL”.

- ⑤ Refrigerant address and unit address No. registration  
Press the [REFRIGERANT ADDRESS] button. The refrigerant address and unit address No. are registered.  
After a while, the mode No. display “--” flashes.



- \* When “BB” flashes at the room temperature display, the selected refrigerant address is not in the system.
- When “F” is displayed at the unit address No. display, and when it flashes together with the refrigerant address display, the selected unit address No. does not exist. Correctly set the refrigerant address and unit address No. by repeating steps ② and ③.

- ⑥ When registered using the [REFRIGERANT ADDRESS] button, the registered indoor unit begins fan operation. When you want to know the location of the indoor units of the unit address No. whose functions were selected, check here. When the unit address No. is 00 or AL, all the indoor units of the selected refrigerant address perform the fan operation.

Ex) When refrigerant address 00, unit address No. = 01 registered

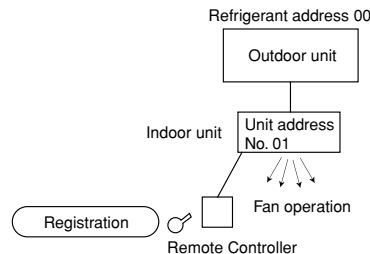

- \* When grouping by different refrigerant systems and an indoor unit other than the specified refrigerant address performs the fan operation, the refrigerant address set here is probably duplicated.  
Recheck the refrigerant address at the outdoor unit DIP switches.

- ⑥ Mode No. selection  
Select the mode No. you want to set with the [TEMP. (▽)] and [△] buttons. (Only the settable mode numbers can be selected.)

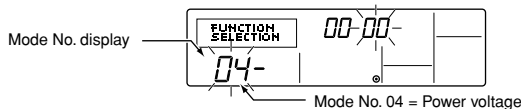

- ⑦ Select the setting contents of the selected mode.  
When the [MENU] button is pressed, the current setting No. flashes.  
Use this to check the currently set contents.

Select the setting No. using the [TEMP. (▽)] and [△] buttons.

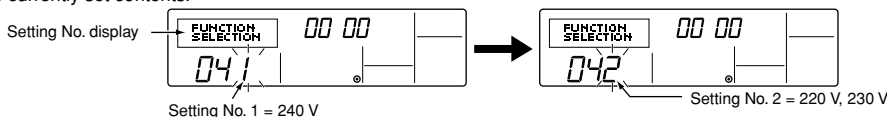

- ⑧ The contents set at steps ③ to ⑦ are registered.  
When the [REFRIGERANT ADDRESS] button is pressed, the mode No. and setting No. flash and registration begins. The flashing mode No. and setting No. change to a steady light and setting ends.

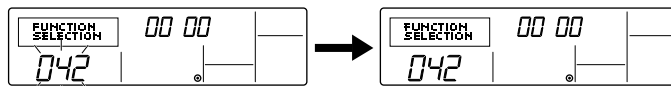

- \* When “--” appears at the mode No. and setting No. displays and “BB” flashes at the room temperature display, communication is probably abnormal.  
Make sure there are no noise sources near the transmission line.

- ⑨ To select more functions, repeat steps ③ to ⑧.

- ⑩ End function selection.  
Press and hold down the [FILTER] and [TEST] buttons at the same time for two seconds or longer.  
After a while, the function selection display disappears and the remote controller returns to the air conditioner off display.

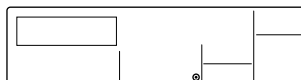

- \* Do not operate the air conditioner from the remote controller for 30 seconds after the end of function selection.

**Note:**  
When the functions of an indoor unit were changed by function selection after the end of installation, always indicate the set contents by entering a ○ or other mark in the appropriate check field of Table 1 and Table 2.



# 12. Test run

## 12.1. Before test run

The test run can be carried out either from the outdoor unit or the indoor unit. For the test run from outdoor unit, please check the outdoor unit installation manual.

### 1. Checklist

- After the installation, piping setup, and wiring of the indoor and outdoor units is complete, check that refrigerant is not leaking, the power and control wires are not loose, and the poles are not reversed.
- Use a 500 V insulation resistance tester to make sure that the resistance between the power terminal and the ground is 1.0 MΩ or more. If it is less than 1.0 MΩ, do not operate the unit. \* Absolutely do not touch the tester to indoor/outdoor connection terminals S1, S2, and S3. An accident could occur.
- Before turning the power ON, make sure that test run switch (SW4) of outdoor controller board is OFF.
- Check the electrical power phase. If the phase is reversed, the fan may rotate in the wrong direction or stop, or unusual sounds may be produced. (PEA-200, 250, 400, 500)
- Starting at least 12 hours before the test run, send current through the crankcase heater. (If the current is running for a shorter period of time, damage to the compressor could result.)
- For specific models requiring changing of settings for higher ceilings or selection of power supply ON/OFF capability, make proper changes referring to the description for Selection of Functions through Remote Controller.

After the above checks are complete, carry out the test run as indicated in the following outline.

## 12.2. Test run procedures

### ① Turn on the main power supply

While the display on the remote controller indicates "CENTRALLY CONTROLLED", the remote controller is disabled. Turn off the "CENTRALLY CONTROLLED" indicator before using the remote controller.

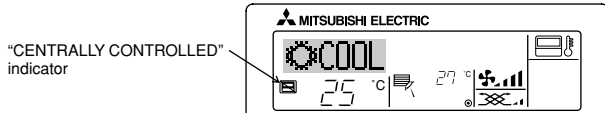

### ② Press the [TEST] button twice successively within three seconds. Test run starts.

"TEST RUN" and "OPERATION MODE" are displayed alternately.

### ③ Press [FUNCTION] button

Cooling/drying mode: Cool air should start to blow.

Heating mode: Warm air should start to blow (after a while).

### ④ Check the outdoor unit fan for correct running

The outdoor unit features automatic capacity control to provide optimum fan speeds. The fan keeps running at a low speed to meet the current outside air condition unless it exceeds its available maximum power. Then, in actuality, the fan may stop or run in the reverse direction depending on the outside air, which does not mean malfunction.

### ⑤ Press the [ON/OFF] button to reset the test run in progress

- The test run will be automatically shut down after two hours in response to the AUTO STOP setting of two hours on the timer.
- During the test run, the room temperature display shows the indoor unit tubing temperatures.
- In the case of the test run, the OFF timer will activate, and the test run will automatically stop after two hours.
- The room temperature display section shows the control temperature for the indoor units during the test run.
- Check that all the indoor units are running properly for simultaneous twin and triple operation. Malfunctions may not be displayed even if the wiring is incorrect.

### ⑥ Register a telephone number

The telephone number of the repair shop, sales office, etc., to contact if an error occurs can be registered in the remote controller. The telephone number will be displayed when an error occurs.

For registration procedures, refer to 11.4 Function selection of remote controller.

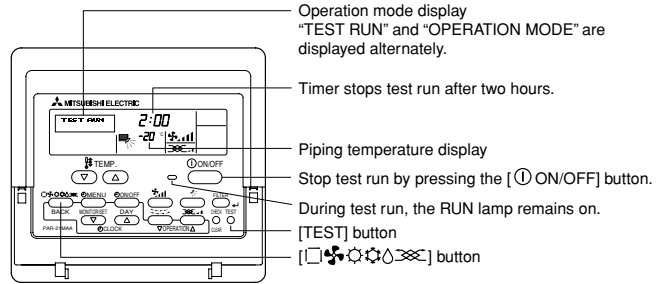

(\*1)

After turning ON the power, the system will go into startup mode, and the remote controller operation lamp (green) and the display section's "PLEASE WAIT" will flash. Also, in the case of the indoor substrate LEDs, LED 1 and LED 2 light up (when address is 0) or become dim (when address is not 0), and LED 3 flashes. In the case of the outdoor substrate LED display, [ ] and [ ] are displayed alternately at 1-second intervals.

- If one of the above operations does not function correctly, the following causes should be considered, and if applicable, dealt with. (The following symptoms have been determined under test run mode. Note that "startup" in the chart means the \*1 display above.)

Symptoms		Cause
Remote Controller Display	Outdoor Substrate LED Display	
Remote controller is displaying "PLEASE WAIT", and operation is not possible.	After "startup" display, "00" is displayed (correct operation).	• After power is turned ON, system startup lasts for about 2 mins., and "PLEASE WAIT" is displayed (correct operation).
After power is turned ON, "PLEASE WAIT" is displayed for 3 mins., then error code is displayed.	After "startup" display, error code is displayed.	• Outdoor unit's safeguard installation connector is open.
	After "startup" display, "F1" (negative phase) is displayed.	• Negative phase and open phase of outdoor unit's power terminal board (Single phase: L, N, ⊕ / triple phase: L1, L2, L3, N, ⊕)
Power is turned ON, and "EE" or "EF" are displayed after "PLEASE WAIT" is displayed.	After "startup" display, "00" or "EE" is displayed ("EE" is displayed when a test run is made).	• Incorrect connection of outdoor terminal board (Single phase: L, N, ⊕ / triple phase: L1, L2, L3, N, ⊕ grounding and S1, S2, S3)
Display messages do not appear even when remote controller operation switch is turned ON (operation lamp does not light up).	After "startup" display, "EA" (error for number of units) or "Eb" (unit number error) is displayed.	• Outdoor unit and indoor unit construction differ.
	After "startup" display, "00" is displayed (correct operation).	• Wiring for the indoor and outdoor unit is not connected correctly. (Polarity is wrong for S1, S2, S3)
	After "startup" display, "00" is displayed (correct operation).	• Remote controller transmission wire short
	After "startup" display, "00" is displayed (correct operation).	• There is no outdoor unit for address 0 (address is something other than 0).
	After "startup" display, "00" is displayed (correct operation).	• Remote controller transmission wire burnout
Operation display appears but soon disappears even when remote controller operations are executed.	After "startup" display, "00" is displayed (correct operation).	• After cancellation of function selection, operation is not possible for about 30 secs. (correct operation).

\* Press the remote controller's "CHECK" button twice consecutively to be able to run a self-check. See the chart below for content of error code displays.

LCD	Nonconformity Content	LCD	Nonconformity Content	LCD	Nonconformity Content
P1	Return air temperature sensor error	P8	Pipe temperature error/Outdoor unit error	E6 ~ EF	Signal error between indoor and outdoor units
P2	Pipe (TH2) sensor error	P9	Open/short in condenser/evaporator temp thermistor	- - - -	No error history
P4	Drain sensor error/Float switch connector open	U0 ~ UP	Outdoor unit nonconformity	FFFF	No relevant unit
P5	Drain pump error	F1 ~ FA	Outdoor unit nonconformity		
P6	Freezing/overheating safeguard operation	E0 ~ E5	Signal error between remote controller and indoor unit		

See the chart below for details of the LED displays (LED 1, 2, 3) on the indoor substrate.

LED 1 (microcomputer power supply)	Displays the ON/OFF of power for control. Check that this is lit during normal use.
LED 2 (remote controller feed)	Displays the ON/OFF of feed to wired remote controller. Is only lit for indoor unit linked to outdoor unit with address "00".
LED 3 (indoor and outdoor signals)	Displays signal between indoor and outdoor units. Check that this is flashing during normal use.

## 12.3. Self-check

Retrieve the error history of each unit using the remote controller.

① Switch to the self check mode.

When the [CHECK] button is pressed twice successively within three seconds, the display shown below appears.

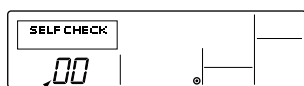

Self check address or self check refrigerant address

② Set the address or refrigerant address No. you want to self check.

When the [TEMP. (▽)] and [TEMP. (△)] buttons are pressed, the address decreases and increases between 01 and 50 or 00 and 15. Set it to the address No. or refrigerant address No. you want to self check.

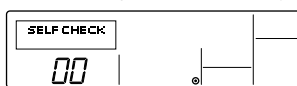

Approximately three seconds after the change operation, the self check refrigerant address changes from flashing to a steady light and self check begins.

③ Self check result display <Error history> (For the contents of the error code, refer to 13. Troubleshooting, error code list.)

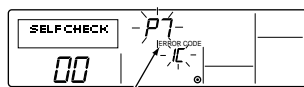

Error code 4 digits or error code 2 digits

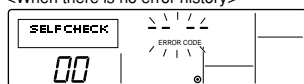

<When there is no error history>

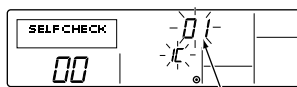

Address 3 digits or unit address No. 2 digits



<When opposite side does not exist>

④ Error history reset

The error history is displayed in ③ Self check results display.

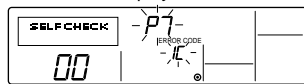

When the [MENU] button is pressed twice successively within three seconds, the self check address or refrigerant address flashes.

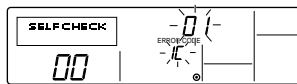
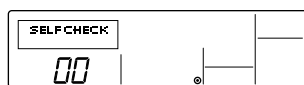

When the error history was reset, the display shown below appears. When error history reset failed, the error contents are displayed again.

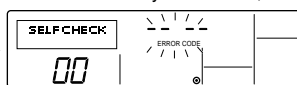

⑤ Self check reset

There are the following two ways of resetting self check.

Press the [CHECK] button twice successively within three seconds → Resets self check and returns to the state before self check.

Press the [ON/OFF] button → Self check resets and indoor units stop.

(When operation is prohibited, this operation is ineffective.)

## 12.4. Remote controller check

If operation cannot be carried out from the remote controller, use this function to diagnose the remote controller.

① First check the power mark.

When normal voltage (DC12 V) is not applied to the remote controller, the power mark goes off.

When the power mark is off, check the remote controller wiring and the indoor unit.

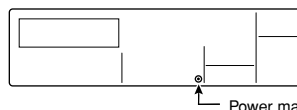

② Switch to the remote controller check mode.

When the [CHECK] button is held down for five seconds or longer, the display shown below appears.

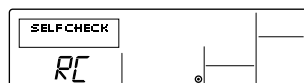

When the [FILTER] button is pressed, remote controller check begins.



### ③ Remote controller check result

When remote controller is normal

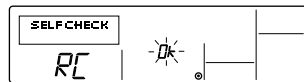

Since there is no problem at the remote controller, check for other causes.

When the problem is other than the checked remote controller

(Error code 2) "E3" "6833" "6832" flash → Cannot send

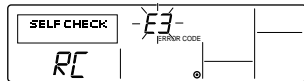

There is noise on the transmission line, or the indoor unit or another remote controller is faulty. Check the transmission line and the other remote controllers.

When remote controller is faulty

(Error display 1) "NG" flashes → Remote controller send/receive circuit abnormal

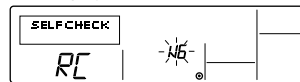

Remote controller switching is necessary.

(Error display 3) "ERC" and data error count are displayed → Data error generation

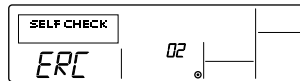

"Data error count" is the difference between the number of bits of remote controller send data and the number of bits actually sent to the transmission line. In this case, the send data was disturbed by the noise, etc. Check the transmission line.

When data error count is 02

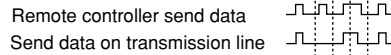

### ④ Remote controller check reset

When the [CHECK] button is held down for five seconds or longer, remote controller check resets and the "PLEASE WAIT" and RUN lamp flash. Approximately 30 seconds later, the remote controller returns to the state before remote controller check.

## 13. Troubleshooting

### 13.1. How to handle problems with the test run

#### Error code list: details

Remote controller display	MELANS display	Error details	Problem location
E0	6831,6834	Remote controller communication – reception error	Remote Controller
E1, E2	6201,6202	Remote controller board error	Remote Controller
E3	6832,6833	Remote controller communication – transmission error	Remote Controller
E4	6831,6834	Remote controller communication – reception error	Indoor unit
E5	6832,6833	Remote controller communication – transmission error	Indoor unit
E6	6740,6843	Communication between indoor and outdoor units – reception error	Indoor unit
E7	6841,6842	Communication between indoor and outdoor units – transmission error	Indoor unit
E8	6840,6843	Communication between indoor and outdoor units – reception error	Outdoor unit
E9	6841,6842	Communication between indoor and outdoor units – transmission error	Outdoor unit
EA	6844	Indoor/outdoor connection wiring error, indoor unit overload (5 units or more)	Outdoor unit
EB	6845	Indoor/outdoor connection wiring error (interference, loose)	Outdoor unit
EC	6846	Excessive time in use	Outdoor unit
ED	0403	Serial communication error	Outdoor unit
EE	0403	Serial communication error	M-NET board
F1	4103	Reverse phase, out of phase verification	Outdoor unit
F8	4115	Faulty input circuit	Outdoor unit
A0	6600	Duplicated M-NET address setting	M-NET board
A2	6602	M-NET error in PH/W transmission	M-NET board
A3	6603	M-NET bus busy	M-NET board
A6	6606	M-NET communication error with P transmission	M-NET board
A7	6607	M-NET error – no ACK	M-NET board
A8	6608	M-NET error- no response	M-NET board
EF	undefined	Undefined error code	–
U2	1102	Outlet temperature error	Outdoor unit
U2	1108	CN23 Short-circuit Connector Unplugged	Outdoor unit
U3	5104	Open/short in discharge temp thermistor	Outdoor unit
U4	5105	Open/short in liquid temp thermistor	Outdoor unit
U6	4101	Compressor overcurrent interruption (51C operation)	Outdoor unit
UE	1302	High pressure error (63H1 operation)	Outdoor unit
UL	1300	Low pressure error (63L operation)	Outdoor unit
F8	4115	Power synchronous idle circuit error	Outdoor unit
P1	5101	Return air temperature sensor error	Indoor unit
P2	5102	Pipe (TH2) sensor error	Indoor unit
P4	2503	Drain sensor error/Float switch connector open	Indoor unit
P5	2502	Drain pump error	Indoor unit
P5	2500	Water leak error (PDH only)	Indoor unit
P6	1503	Freeze prevention operation	Indoor unit
P6	1504	Surge prevention operation	Indoor unit
P8	1110	Pipe temperature error/Outdoor unit error	Indoor unit
P9	5103	Open/short in condenser/evaporator temp thermistor	Indoor unit

### 13.2. The following occurrences are not problems or errors

Problem	Remote controller display	Cause
The fan setting changes during heating. (PEA-200, 250)	Ordinary display	During thermostat OFF mode, low speed air operation will take place. During thermostat ON mode, low speed air will switch automatically to set notch (fan speed) on the basis of time or piping temperature.
The fan stops during heating.	Defrosting display	During defrosting, the fan will stop.
When the switch is turned ON, the fan does not begin to operate. (PEA-200, 250)	Heating preparations underway	After the switch is turned ON, low speed air will take place, for 7 minutes (or after pipe temperature reaches 35°C, 2 minutes) before automatically switch to set notch (fan speed). (Hot adjustment)
The outdoor unit fan turns in reverse or stops, and an unusual sound is heard.	Ordinary display	There is a risk of the power to the outdoor unit being connected in reverse phase. Be sure to check that the phase is correct.

**Note:**  
**If the fan in the indoor unit does not operate, check the over-current relay on the fan motor to determine whether it has been tripped.**  
**If the over-current relay has been tripped, reset it after eliminating the cause of the problem (e.g. motor lock).**  
**To reset the over-current relay, open the control box and press the green claw on bottom-right of the relay until a click is heard. Release the claw and check that it returns to its original position.**  
**Note that if it is pressed too hard it will not return to its original position.**

---

This product is designed and intended for use in the residential, commercial and light-industrial environment.

The product at hand is based on the following EU regulations:

- Low Voltage Directive 2006/95/EC
- Electromagnetic Compatibility Directive 2004/108/EC

Please be sure to put the contact address/telephone number on this manual before handing it to the customer.

 **MITSUBISHI ELECTRIC CORPORATION**

HEAD OFFICE: TOKYO BLDG., 2-7-3, MARUNOUCHI, CHIYODA-KU, TOKYO 100-8310, JAPAN

Authorized representative in EU: MITSUBISHI ELECTRIC EUROPE B.V.

HARMAN HOUSE, 1 GEORGE STREET, UXBRIDGE, MIDDLESEX UB8 1QQ, U.K.