

CITY MULTI Control System
and Mitsubishi Mr. SLIM Air Conditioners

Simple MA Remote Controller PAC-YT52CRA

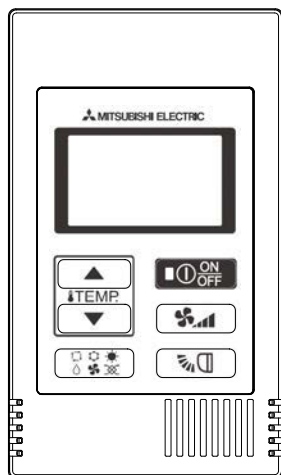

Instruction Book



Safety precautions.....	2
Names and functions of controller components	4
Controller interface	4
Display.....	5
Basic operations	6
Operation mode.....	6
Preset temperature.....	7
Fan speed.....	8
Vane	8
Controller operation - Function settings	9
Temperature range restriction	9
Operation lock setting.....	10
Mode skip setting.....	10
Backlight brightness setting.....	11
Specifications	12

Icon explanations

The square icons used in this manual indicate as follows.



-  Indicates settings that can be changed only while the units are in operation.
-  Indicates settings that can be changed only while the units are stopped.
-  Indicates functions that are not available when the buttons are locked or the system is centrally controlled.

Prior to use, thoroughly read the instructions in this manual to use the product correctly.
Retain for future reference.

Make sure that this manual and Installation Manual are passed on to any future users.
To ensure safety and proper operation of the remote controller, the remote controller should only be installed by qualified personnel.

Safety precautions

- Read the following safety precautions before using the controller.
- Observe these precautions carefully to ensure safety.

 WARNING	Indicates a risk of death or serious injury if you misuse the PAC-YT52CRA.
 CAUTION	Indicates a risk of serious injury or structural damage if you misuse the PAC-YT52CRA.

- After reading this manual, provide this manual to end user for future reference.
- Keep this manual for future reference and refer to it as necessary. This manual should be made available to those who repair or relocate the controller. Make sure that the manual is forwarded to future end users.

CB

General precautions

WARNING

Do not install the unit in a place where large amounts of oil, steam, organic solvents, or corrosive gases, such as sulfuric gas, are present or where acidic/alkaline solutions or sprays are used frequently. These substances can compromise the performance of the unit or cause certain components of the unit to corrode, which can result in electric shock, malfunctions, smoke, or fire.

To reduce the risk of injury or electric shock, stop the operation and switch off the power supply before cleaning, maintaining, or inspecting the controller.

To reduce the risk of injury or electric shock, before spraying a chemical around the controller, stop the operation and cover the controller.

To reduce the risk of shorting, current leakage, electric shock, malfunctions, smoke, or fire, do not wash the controller with water or any other liquid.

If any abnormality (e.g., burning smell) is noticed, stop the operation, turn off the power switch, and consult your dealer. Continuing the operation may result in electric shock, malfunctions, or fire.

To reduce the risk of electric shock, malfunctions, smoke or fire, do not operate the switches/buttons or touch other electrical parts with wet hands.

Properly install all required covers to keep moisture and dust out of the controller. Dust accumulation and water can cause electric shock, smoke, or fire.

When alcohol sterilization is performed, ventilate the air to remove the gas.

CAUTION

To reduce the risk of damage to the controller, do not directly spray insecticide or other flammable sprays on the controller.

To reduce the risk of injury and electric shock, avoid contact with sharp edges of certain parts.

To reduce the risk of electric shock or malfunctions, do not touch the touch panel, switches, or buttons with a pointy or sharp object.

To reduce the risk of injury, wear protective gear when working on the controller.

Consult your dealer for the proper disposal of the controller.

Precautions for moving or repairing the controller

WARNING

The controller should be repaired or moved only by qualified personnel.
Do not disassemble or modify the controller.
Improper installation or repair may cause injury, electric shock, or fire.

 **CAUTION**

To reduce the risk of shorting, electric shock, fire, or malfunction, do not touch the circuit board with tools or with your hands, and do not allow dust to accumulate on the circuit board.

Additional precautions

To avoid damage to the unit, use appropriate tools to install, inspect, or repair the unit.

To avoid discoloration, do not use benzene, thinner, or chemical rag to clean the controller.
To clean the controller, wipe with a soft cloth soaked in water with mild detergent, wipe off the detergent with a wet cloth, and wipe off water with a dry cloth.

Names and functions of controller components

Controller interface

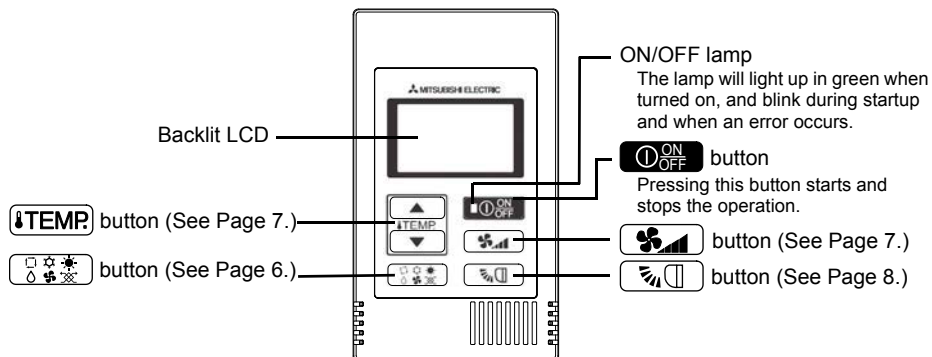

* To set the functions that are not available on this controller (PAC-YT52CRA) such as Louver, use MA remote controller or the centralized controller.

Display

* All icons are displayed for explanation.

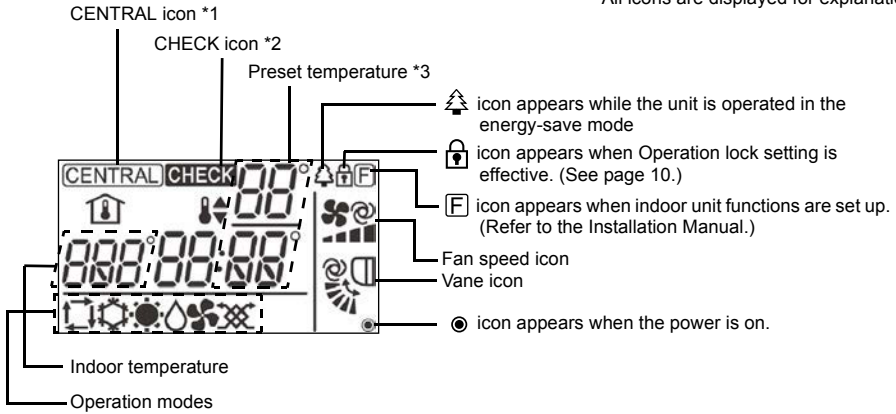

*1 **CENTRAL** icon

Appears when one of the following local operations is prohibited: ON/OFF; operation mode; preset temperature; fan speed; vane.

*2 **CHECK** icon

For Mr. SLIM, when an error occurs, power indicator will blink, and refrigerant address (two digits), error code (two digits), and unit No. will blink.

For City Multi, when an error occurs, power indicator will blink, and unit address (three digits) and error code (four digits) will blink.

Check the error status, stop the operation, and consult your dealer.

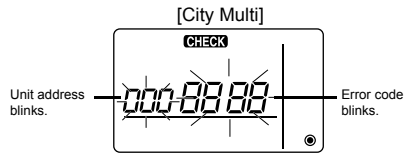
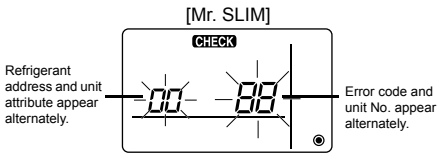

When only error code blinks, air conditioning units stay in operation, but an error may have occurred. Check the error code, and consult your dealer.

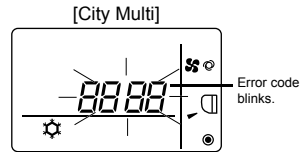
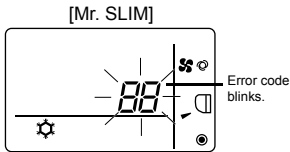

*3 Preset temperature

* Centigrade or Fahrenheit is selectable. Refer to the Installation Manual for details.

In COOL, DRYING, HEAT, or AUTO (single set point) modes

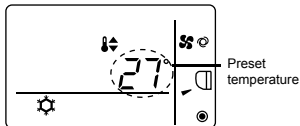

In AUTO (dual set point) mode

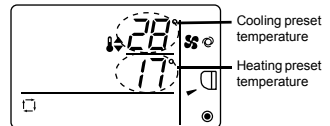

Basic operations

Operation mode



Pressing the  button will change the operation mode in the following order.

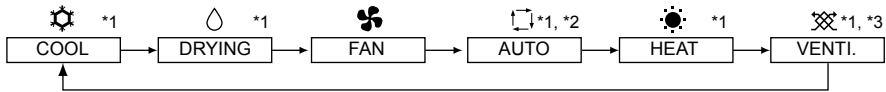

*1: Not all functions are available on all models of indoor units. Functions that are not available will not appear on the display.

*2: The preset temperature for AUTO (either single or dual set point) mode will appear depending on the indoor unit model.

*3: Available only on the Mr. SLIM unit interlocked with LOSSNAY unit.

"VENTI." will light up when LOSSNAY unit operates while the unit is in operation.

AUTO (dual set point) mode:

In AUTO (dual set point) mode, the preset temperatures can be set for cooling and heating, and operation can be switched automatically between cooling and heating depending on the room temperature.

The preset temperatures for cooling and heating set in AUTO (dual set point) mode will be reflected to the temperature setting for COOL/DRYING and HEAT modes.

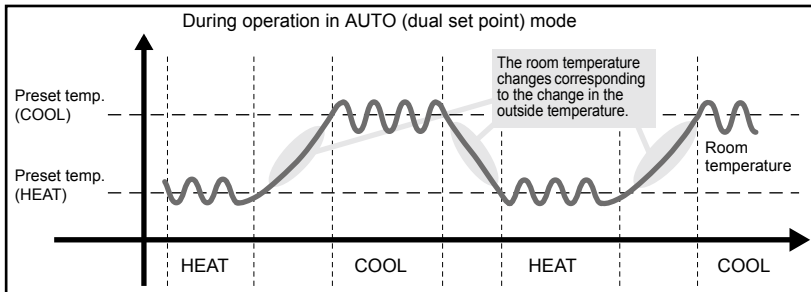

Preset temperature



In COOL, DRYING, HEAT, and AUTO (single set point) modes

Pressing the **TEMP ▲** button increases the preset temperature.

Pressing the **TEMP ▼** button decreases the preset temperature.

In AUTO (dual set point) mode

Cooling preset temperature

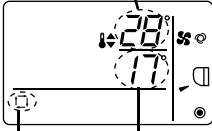

Heating preset temperature

Current operation mode

Current preset temperature (cooling/heating) appears.

When the **TEMP ▲** or **TEMP ▼** button is pressed, the preset temperature (cooling/heating) display blinks.

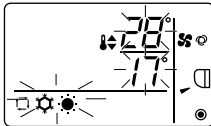

While the preset temperature (cooling/heating) display blinks, pressing the **TEMP ▲** button increases the preset temperatures for both cooling and heating, and pressing the **TEMP ▼** button decreases the preset temperatures for both cooling and heating.

When the **MODE** button is pressed, only the cooling preset temperature display blinks.

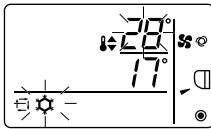

While the cooling preset temperature display blinks, pressing the **TEMP ▲** button increases the cooling preset temperature, and pressing the **TEMP ▼** button decreases the cooling preset temperature.

When the **MODE** button is pressed, only the heating preset temperature display blinks.

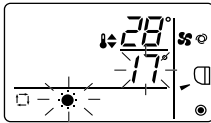

While the heating preset temperature display blinks, pressing the **TEMP ▲** button increases the heating preset temperature, and pressing the **TEMP ▼** button decreases the heating preset temperature.

Pressing the **MODE** button completes the preset temperature setting.

* During the preset temperature setting, the setting will automatically turn off if the **TEMP ▲** or **TEMP ▼** button is left untouched for a certain period of time.

Preset temperature range is as follows.

Operation mode	Preset temperature range
COOL/DRYING	19 - 30°C/67 - 87°F *1
HEAT	17 - 28°C/63 - 83°F *1
AUTO (single set point)	19 - 28°C/67 - 83°F *1
AUTO (dual set point)	[COOL] Preset temperature range for COOL mode. [HEAT] Preset temperature range for HEAT mode. *2, *3
FAN, VENTI.	Unsettable

*1 Preset temperature range varies depending on the indoor unit model to be connected. Refer to the Indoor unit Instruction Book for details.

*2 The preset temperatures for cooling and heating for AUTO (dual set point) mode will be used for those for COOL/DRYING and HEAT mode.

*3 The preset temperatures for cooling and heating can be set under the following conditions.

- The cooling preset temperature is greater than the heating preset temperature.
- The difference between the cooling and heating preset temperatures is equal or greater than the minimum temperature difference that varies depending on the indoor unit model to be connected.

Fan speed



Pressing the  button will change the fan speed in the following order.

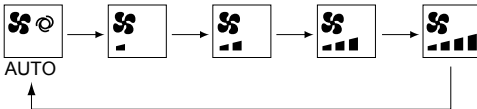

* The settable fan speed varies depending on the indoor unit model to be connected.

* If the unit has no fan setting function, the fan speed cannot be set.

In this case, the fan icon blinks when the  button is pressed.

Vane



Pressing the  button will switch the vane directions.

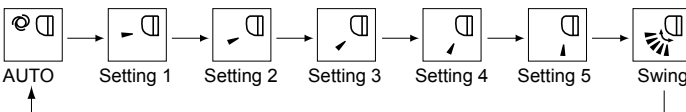

* The settable vane direction varies depending on the indoor unit model to be connected.

* If the unit has no vane function, the vane direction cannot be set.

In this case, the vane icon blinks when the  button is pressed.

Controller operation - Function settings

Temperature range restriction



The preset temperature range for each operation mode can be restricted.

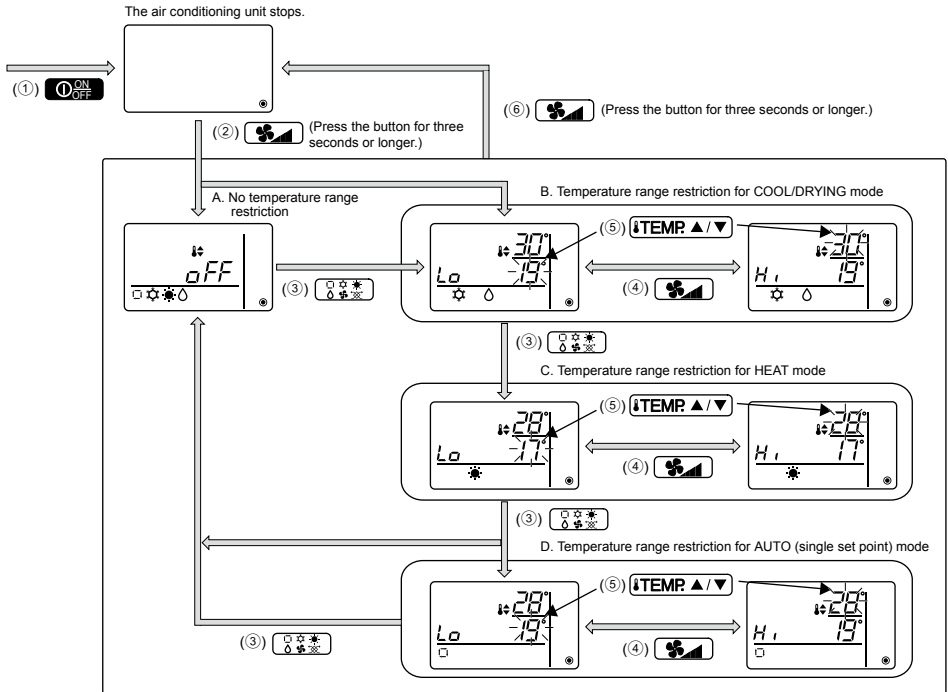

- ① Press the button to stop the air conditioning unit.
- ② Press and hold the button for three seconds or longer to bring up the temperature range restriction setting display. (A or B appears.)

- ③ Press the button to select from A through D.

* When the AUTO (single set point) mode is not available on the indoor unit, or when the AUTO mode is set to OFF in the Mode skip setting, D will not be displayed.

A. No temperature range restriction:

The temperature range restriction will not be executed for all modes.

B. Temperature range restriction for COOL/DRYING mode:

The preset temperature range for COOL/DRYING and AUTO (dual set point) modes can be changed.

C. Temperature range restriction for HEAT mode:

The preset temperature range for HEAT and AUTO (dual set point) modes can be changed.

D. Temperature range restriction for AUTO (single set point) mode:

The preset temperature range for AUTO (single set point) mode can be changed.

- ④ Press the button to switch between the upper limit (Hi) and lower limit (Lo) settings.

- ⑤ Press the **TEMP ▲** or **TEMP ▼** button to set upper/lower limit value.
- Pressing the **TEMP ▲** and **TEMP ▼** buttons simultaneously can bring up the previous temperature range of COOL/DRYING, HEAT, and AUTO modes.
 - The temperature can be adjusted within the preset temperature range of the indoor unit. Refer to the Indoor unit Instruction Book for details.
- ⑥ Press and hold the **LOCK** button for three seconds or longer to complete the setting.
- If this action is taken while A is displayed, the temperature range restriction will not be executed.
 - If this action is taken while one of B through D is displayed, all temperature range restrictions for COOL/ DRYING, HEAT, and AUTO modes set in B through D will be executed. If the preset temperature range has not been changed, the restriction will not be executed.
 - After the temperature range restriction is executed, if the user tries to select a temperature outside of the range, the preset temperature display will blink.
- * The temperature range on this controller (PAC-YT52CRA) connected to the indoor units that have the temperature range restriction function can be restricted also from the centralized controller that has the same function.

Operation lock setting

This function can lock all buttons.

A. Operation lock is enabled.

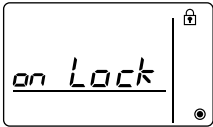

B. While the operation lock is enabled.

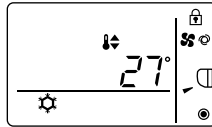

C. Operation lock is disabled.



Locking the operations

While the operation lock is disabled (lock icon is unlit.), press and hold the **LOCK** button for three seconds or longer to enable the Operation lock. (A)

* While the operation lock is enabled, lock icon is lit. (B)

* If any button is pressed while the operation lock is enabled, lock icon will blink.

Unlocking the operations

While the operation lock is enabled (lock icon is lit.), press and hold the **LOCK** button for three seconds or longer to disable the Operation lock. (C)







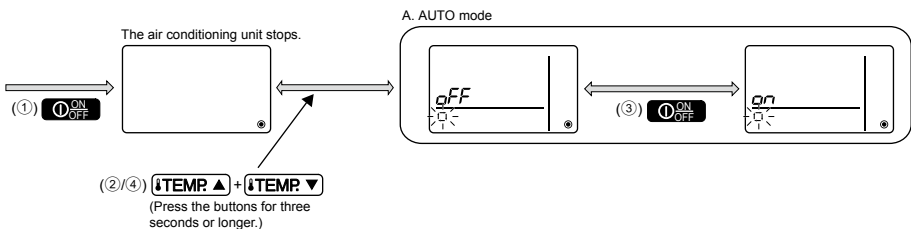

Mode skip setting



The usability of AUTO mode can be set.



This setting is effective only when the controller is connected to the indoor units that have AUTO mode.

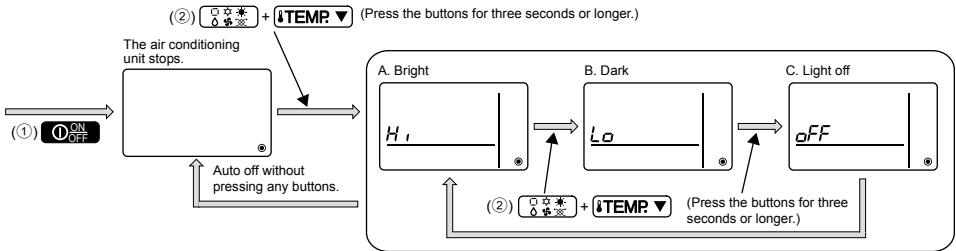

- ① Press the  button to stop the air conditioning unit.
- ② Press the  and  buttons simultaneously for three seconds or longer to bring up the Mode skip settings display. (The current setting will appear.)
- ③ Press the  button to select ON or OFF.
 ON: AUTO mode can be selected by pressing the  button during operation.
 OFF: AUTO mode cannot be selected by pressing the  button during operation.
- ④ Press the  and  buttons simultaneously for three seconds or longer to complete the setting.

Backlight brightness setting



- ① Press the  button to stop the air conditioning unit.
 - ② Press the  and  buttons simultaneously for three seconds or longer to change the backlight brightness. (The factory setting is "bright.")
- * Repeat step ② above to switch the settings A, B, and C.
 * The setting will automatically turn off if step ② is not performed for a certain period of time.

Specifications

Controller specifications

	Specifications
Product size	70 (W) × 120 (H) × 14.5 (D) mm (2-3/4 × 4-3/4 × 9/16 [in]) (not including the protruding part)
Net weight	0.1 kg (1/4 lb.)
Rated power supply voltage	12 VDC (supplied from indoor units)
Power consumption	0.3 W
Usage environment	Temperature 0 ~ 40°C (32 ~ 104°F) Humidity 30 ~ 90%RH (with no dew condensation)
Material	PC + ABS

This product is designed and intended for use in the residential, commercial, and light-industrial environment.

The product at hand is based on the following EU regulations:

- **Low Voltage Directive 2006/95/EC**
- **Electromagnetic Compatibility Directive 2004/108/EC**

MITSUBISHI ELECTRIC CORPORATION

HEAD OFFICE: TOKYO BLDG. 2-7-3, MARUNOUCHI, CHIYODA-KU, TOKYO 100-8310, JAPAN
Authorized representative in EU: MITSUBISHI ELECTRIC EUROPE B.V.

HARMAN HOUSE, 1 GEORGE STREET, UXBRIDGE, MIDDLESEX UB8 1QQ, U.K.

WT06591X01