

INSTALLATION MANUAL FOR A-M CONVERTER

For models in which this component is used, see the separate sheet.

SAFETY PRECAUTIONS

- Before starting installation, read the "Safety Precautions" described below.
- The following precautions must be observed as it describes the serious matters for safety.
- The safety precautions are described with the degree of danger.

⚠ WARNING When you handle wrong, it can lead to death or serious injury.

⚠ CAUTION When you handle wrong, it can lead to injury or damage to building and furniture.

- After installation, make test operation and confirm that it works properly, and explain the safety precautions, operation method, and maintenance to your customers.
- Tell your customers to keep this installation manual together with operation manual with them, and when they give or sell this machine to other person put this installation manual and operation manual with it.

⚠ WARNING

The installation must be done by dealer or qualified person.

- If the customers do the installation by themselves and it is not perfectly installed it can cause water leak, electric shock, or fire.

The installation must be done in accordance with this manual.

- If the installation is not perfectly done, it can cause water leak, electric shock, or fire.

Never try any modification.

- For repair, ask your dealer.
- If the machine is not modified or repaired completely, it can cause water leak, electric shock, or fire.

Never move or reinstall the machine by the customers.

- If the installation is not perfectly done, it can cause water leak, electric shock, or fire. Ask your dealer or qualified person.

The wiring must be securely done by using proper cable. The wires should be connected to the terminals not to have external force of the cable.

- Faulty connections can cause heat or fire.

The terminal cover (panel) of the unit must be installed securely.

- Faulty installation can cause fire or electric shock by dust or water.

The electric installation must be done by qualified person in accordance with this installation manual. Use the separate circuit only for this machine and use rated voltage and circuit breaker.

- If the electric circuit power is not sufficient or the wiring is not properly done, it can cause electric shock or fire.

Before electric wiring

⚠ CAUTION

Install a circuit breaker depending upon the location.

- Without a circuit breaker, it can cause electric shock.

Use standard wires which meet current capacity.

- Otherwise, it can cause short-circuit, heat, or fire.

Put ground wire.

- Never ground to gas pipe, water pipe, lightning conductor, or telephone ground wire.
- Faulty ground can cause electric shock.

Wires must not have tension.

- It can cause snapping, heat, or fire.

Before test operation

⚠ CAUTION

Turn the power on 12 hours or more before operation.

- If you start operation as soon as the power on, it can cause failure.
- Never turn the power off during season.

Never operate the machine without panel or guard off.

- It can cause serious injury being caught by rotating part or burn or electric shock by high voltage part.

Never operate the machine without air filter off.

- It can cause failure by dust.

Never operate the switches with your hand wet.

- It can cause electric shock.

Never touch refrigerant pipes while the machine running.

- The refrigerant pipes becomes high and low temperature while the machine running. If you touch the pipes by hand, it can cause chilblain or burn.

Never turn the power off as soon as the machine stops.

- Wait for 5 minutes or more. It can cause water leak or failure.

Attention for M-NET connection

Pay attention to the next points for wiring of shielded wires.

(1) Ground wire connection

⚠ CAUTION

The shielded wires of M-NET transmission should be connected with the ground wire at any only one place of the unit to be connected.

- It can cause the transmission error due to noise. Outdoor unit digital LED display reads "Ed" "A7" error. Centralized controller reads "0403" "6607" error.

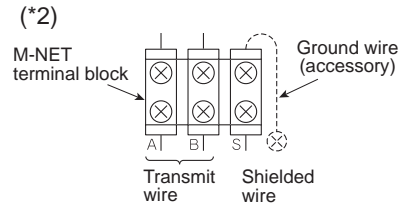
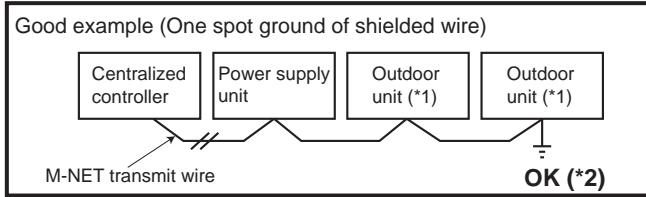
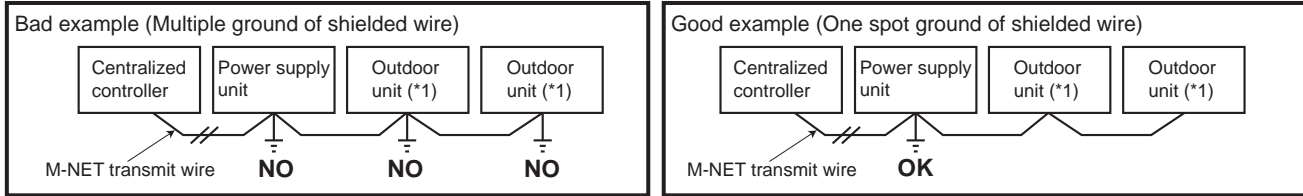

(*1) Refer to the appendix List of Models to check the applicable models.

(*2) In case that the outdoor unit is grounded, connect the ground wire supplied as accessory to the S terminal (secondary) of M-NET terminal block and M-NET ground terminal inside of electric box with using screws supplied.

Note: If the shield and earth are grounded in two or more locations, electrical circuit is generated through them, and a potential difference is created because of the impedance difference between or among the ground locations. This may cause noise in the shield. Ground at only one point, then no circuit is created and no noise gets in.

(2) Length of M-NET transmission line

⚠ CAUTION

The shielded wires of M-NET transmission should be used below the maximum line length.

- It can cause the transmission error. Outdoor unit digital LED display reads "Ed" "A7" error. Centralized controller reads "0403" "6607" error.

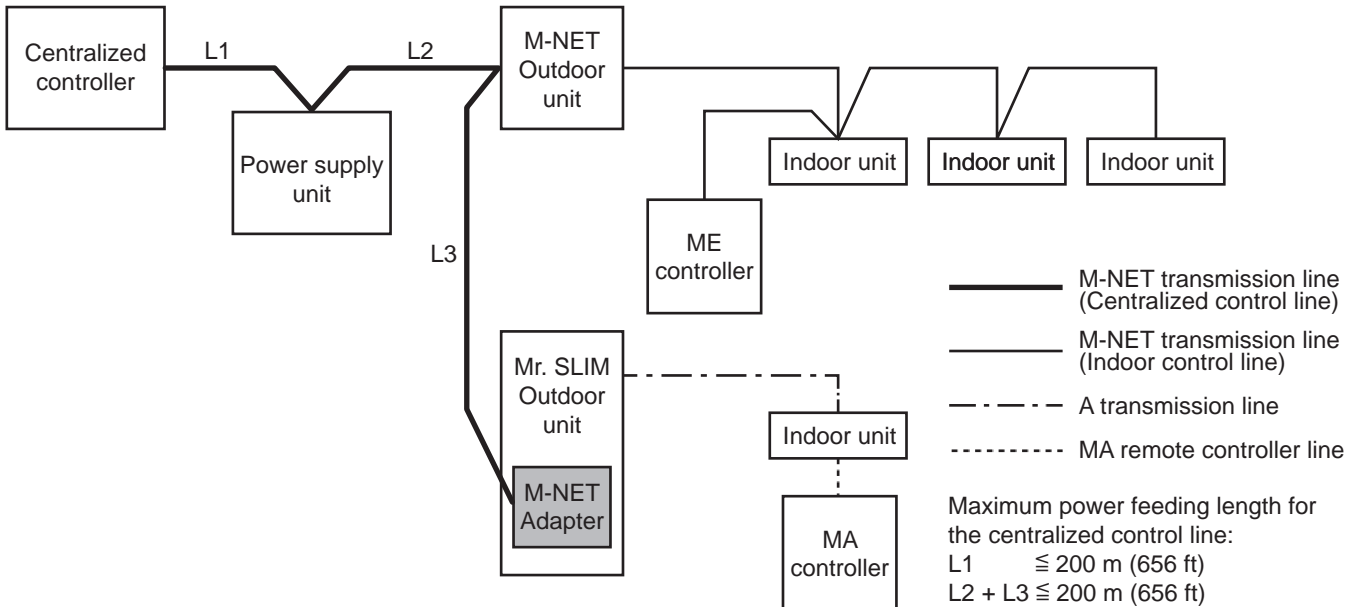







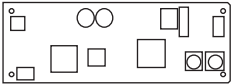
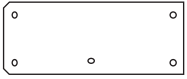
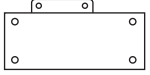

(3) Using dual set point

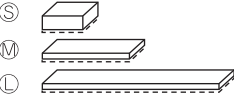
1. To activate dual set point, make sure that all units and controllers in one group have dual set point function.
2. To change the temperature display setting of existing group from single to dual set point, make sure to restart the whole system related.
3. When ME remote controller is included in same group in the case of 2, make sure to initialize* ME remote controller before use.

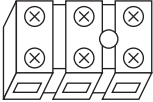
(*Refer to the ME remote controller installation manual. <Service Menu.>)

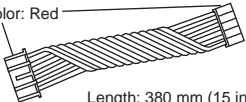
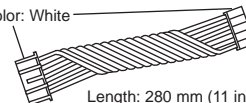
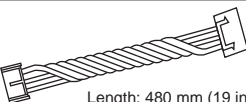
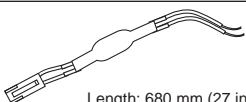
1.Parts List

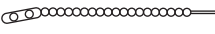
No.	Description	Figure	Q'ty	Applicable models							Note
				A	B	C	D	E	F	G	
①	M-NET board (with insulation sheets and supports)		1	<input type="radio"/>	<input type="radio"/>	<input type="radio"/>	<input type="radio"/>	<input type="radio"/>	<input type="radio"/>	<input type="radio"/>	
②	Plate1 (For mounting M-NET board)		1	<input type="radio"/>							
③	Plate2 (For mounting M-NET board)		1			<input type="radio"/>					
④	Plate3 (For mounting M-NET board)		1						<input type="radio"/>		
⑤	Insulation sheets S, M, L		S	1	<input type="radio"/>						
			M	1	<input type="radio"/>						
			L	1	<input type="radio"/>	<input type="radio"/>					
⑥	Screw (M4×8)		2	<input type="radio"/> (1)		<input type="radio"/> (2)			<input type="radio"/> (2)		
⑦	Terminal block (M-NET)		1	<input type="radio"/>	<input type="radio"/>	<input type="radio"/>	<input type="radio"/>	<input type="radio"/>	<input type="radio"/>	<input type="radio"/>	
⑧	Terminal screw (M3×20)		1	<input type="radio"/>	<input type="radio"/>	<input type="radio"/>	<input type="radio"/>	<input type="radio"/>	<input type="radio"/>	<input type="radio"/>	
⑨	Label		1	<input type="radio"/>	<input type="radio"/>	<input type="radio"/>	<input type="radio"/>	<input type="radio"/>	<input type="radio"/>	<input type="radio"/>	
⑩	Lead wire-A (5 wires)	Color: Red  Length: 380 mm (15 inch)	1	<input type="radio"/>	<input type="radio"/>	<input type="radio"/>		<input type="radio"/>	<input type="radio"/>	<input type="radio"/>	Wire Marking : INV type Always make sure that the markings and the applicable model match. If used incorrectly, parts could be damaged.
⑪	Lead wire-B (5 wires)	Color: White  Length: 280 mm (11 inch)	1				<input type="radio"/>				Wire Marking : NON-INV Always make sure that the markings and the applicable model match. If used incorrectly, parts could be damaged.
⑫	Lead wire-C (3 wires)	 Length: 480 mm (19 inch)	1	<input type="radio"/>	<input type="radio"/>	<input type="radio"/>	<input type="radio"/>	<input type="radio"/>	<input type="radio"/>	<input type="radio"/>	
⑬	Lead wire-D (2 wires)	 Length: 680 mm (27 inch)	1	<input type="radio"/>	<input type="radio"/>	<input type="radio"/>	<input type="radio"/>	<input type="radio"/>	<input type="radio"/>	<input type="radio"/>	
⑭	Ground wire and screw (M4×8)		1 each	<input type="radio"/>	<input type="radio"/>	<input type="radio"/>	<input type="radio"/>	<input type="radio"/>	<input type="radio"/>	<input type="radio"/>	
⑮	Fastener		2	<input type="radio"/>	<input type="radio"/>	<input type="radio"/>	<input type="radio"/>	<input type="radio"/>	<input type="radio"/>	<input type="radio"/>	

2.Switch setting

Before installation

Set switch on M-NET board in advance before installing on the electrical parts box.

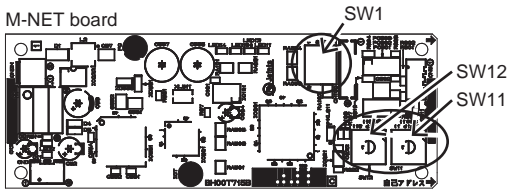

(1) M-NET address setting

The setting should be done by rotary switches SW11 and SW12 on M-NET board. (Factory settings are all Zero)

Make sure to set M-NET address within the range of 01 to 50.

When installing two or more outdoor units, do not use the same number more than once for M-NET address.

<Example>

M-NET address No.	1	2	50
Switch setting	SW 11 (Ones digit)		
	SW 12 (Tens digit)		

(2) Switch 1-8 setting

SW1-8 Selection	Function	Function details	Initial setting	Effective timing
	<p>Turn the switch ON when MA remote controller or wireless remote controller is connected to indoor unit.</p> <p>MA: MA remote controller RC: Wireless remote controller</p>	<p><FUNCTION> Set the connection of MA-remote controller or wireless remote controller to the indoor unit. ON : exist (initial setting) OFF : not exist</p>	ON	When power supply ON
	<p>Turn the switch OFF when MA remote controller or wireless remote controller is NOT connected to indoor unit.</p>	<p><NOTE> In case of switch is ON, transmission error between M-NET board and centralized controllers does not be detected, and M-NET board operates continuously.</p>	ON	When power supply ON

Note: SW1-3 is always ON

3. Installation procedure [Applicable model : Group A]

- To protect the wires connected to M-NET board from the edges of sheet-metal component, paste the insulation on the edge surface of panel sheet-metal before proceeding with the following work.

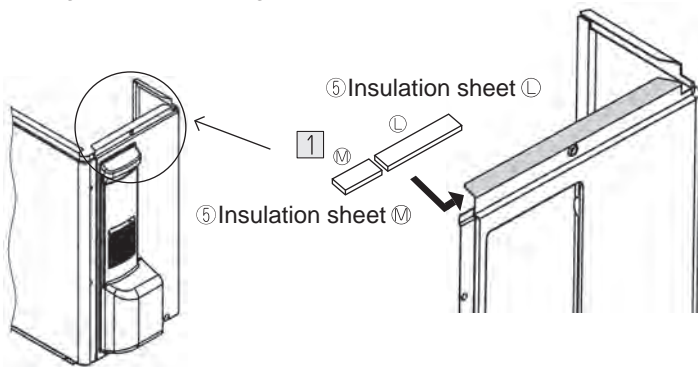

(Top view of Electrical parts box)

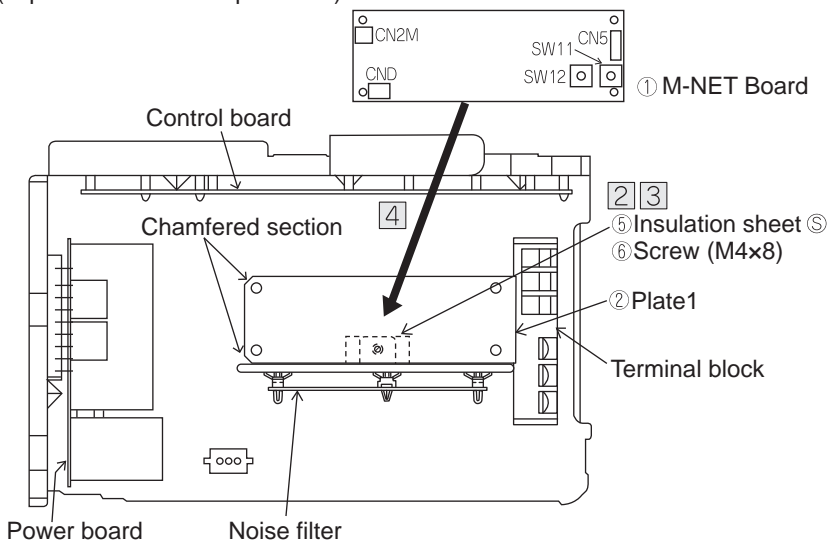

(When viewed from the side of Electrical parts box)

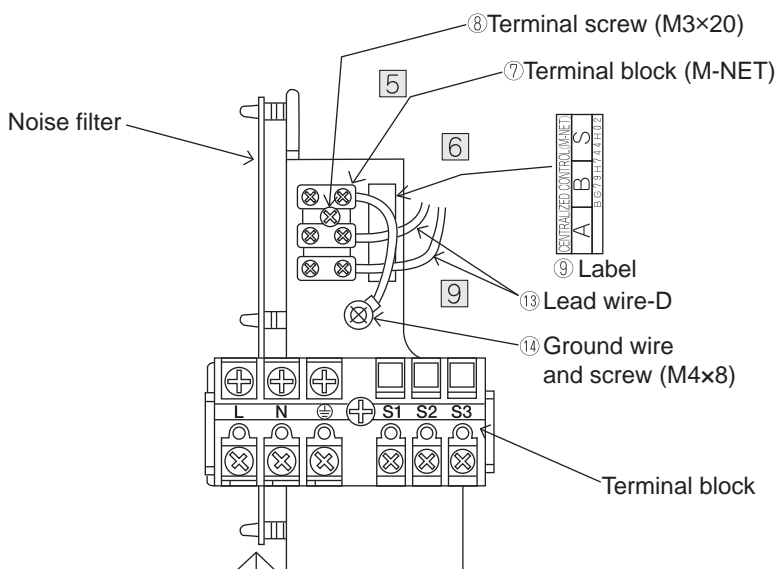

- Paste insulation sheets (M) and (L) (5) to the backside of the flange surface on the top of the side panel.
- Starting from the bottom, mount insulation sheet (5) to the "L" bend section on the back of the noise filter mounting panel.
- Position the chamfered section of plate1 (2) so that it faces the fan side (the left side of the drawing) and mount it using screw (6).
- Install M-NET board (1) (with insulation sheets and supports) on the four corners of plate1 (2) so that the rotary switches (SW11, SW12) are on the terminal block side and then mount.
Note: Push it firmly until you hear it "click".
- Use terminal screw (8) to secure terminal block (7).
Note:
Terminal block (7) has a round boss for positioning: Fit the round boss into the positioning hole in steel-plate.
- Paste label (9)
- Use lead wire-A (10) to connect CN5 of M-NET board (1) connection and CNMNT of outdoor control board.
• Caution
Wire Marking: INV type,
Connector color: Red
Always make sure that the markings and the applicable model match. If used incorrectly, parts could be damaged.
- Use lead wire-C (12) to connect CND of M-NET board (1) connection and CNVMNT of outdoor control board.
- Use lead wire-D (13) to connect CN2M of M-NET board (1) connection and terminals A and B of terminal block (7) Polarity is not a concern.
Note:
Connect the wire firmly making sure that the screws on terminal block are not loose.
- The lead wires should be tied together with the other lead wires with the fastener (15) not to loose.
Wiring length is adjusted according to apparatus.
Note1:
Use ground wire and screw (14) as required to connect the shield of M-NET transmission line to the unit.
(See the attention on page 2)
Note2:
Take great care that no lead wire is caught on anything when installing panels.

3. Installation procedure [Applicable model : Group B]

- To protect the wires connected to M-NET board from the edges of sheet-metal component, paste the insulation on the edge surface of panel sheet-metal before proceeding with the following work.

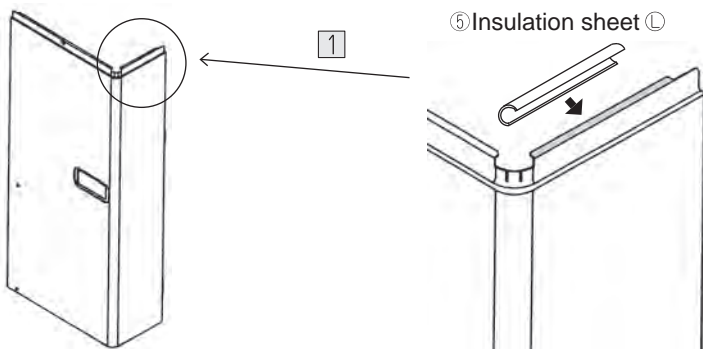

(When viewed from the side of Electrical parts box)

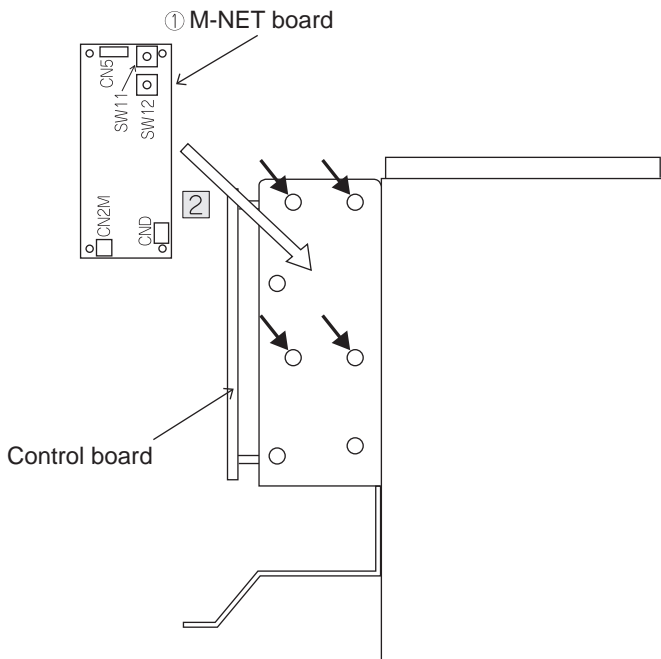

(When viewed from the side of Electrical parts box)

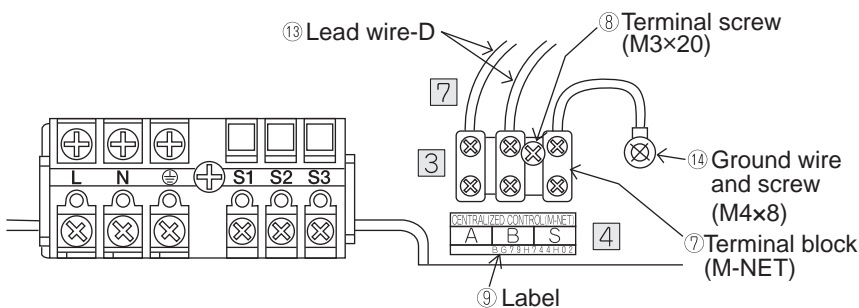

- Paste insulation sheet ⑤ on sheet-metal so that it completely envelops the edge surface of sheet-metal.

- Install M-NET board ① (with insulation sheets and supports) on the side of electrical parts box so that the rotary switches (SW11, SW12) faces up (at the four points indicated by arrows).
Note: Push it firmly until you hear it "click".

- Use terminal screw ⑧ to secure terminal block ⑦.

Note:

Terminal block ⑦ has a round boss for positioning: Fit the round boss into the positioning hole in steel-plate.

- Paste label ⑨ under terminal block ⑦.

- Use lead wire-A ⑩ to connect CN5 of M-NET board ① connection and CNMNT of outdoor control board.

• Caution

Wire Marking: INV type,

Connector color: Red

Always make sure that the markings and the applicable model match. If used incorrectly, parts could be damaged.

- Use lead wire-C ⑫ to connect CND of M-NET board ① connection and CNVMNT of outdoor control board.

- Use lead wire-D ⑬ to connect CN2M of M-NET board ① connection and terminals A and B of terminal block ⑦. Polarity is not a concern.

Note:

Connect the wire firmly making sure that the screws on terminal block are not loose.

- The lead wires should be tied together with the other lead wires with the fastener ⑮ not to loose. Wiring length is adjusted according to apparatus.

Note1:

Use ground wire and screw ⑭ as required to connect the shield of M-NET transmission line to the unit.

(See the attention on page 2)

Note2:

Take great care that no lead wire is caught on anything when installing panels.

3. Installation procedure [Applicable model : Group C]

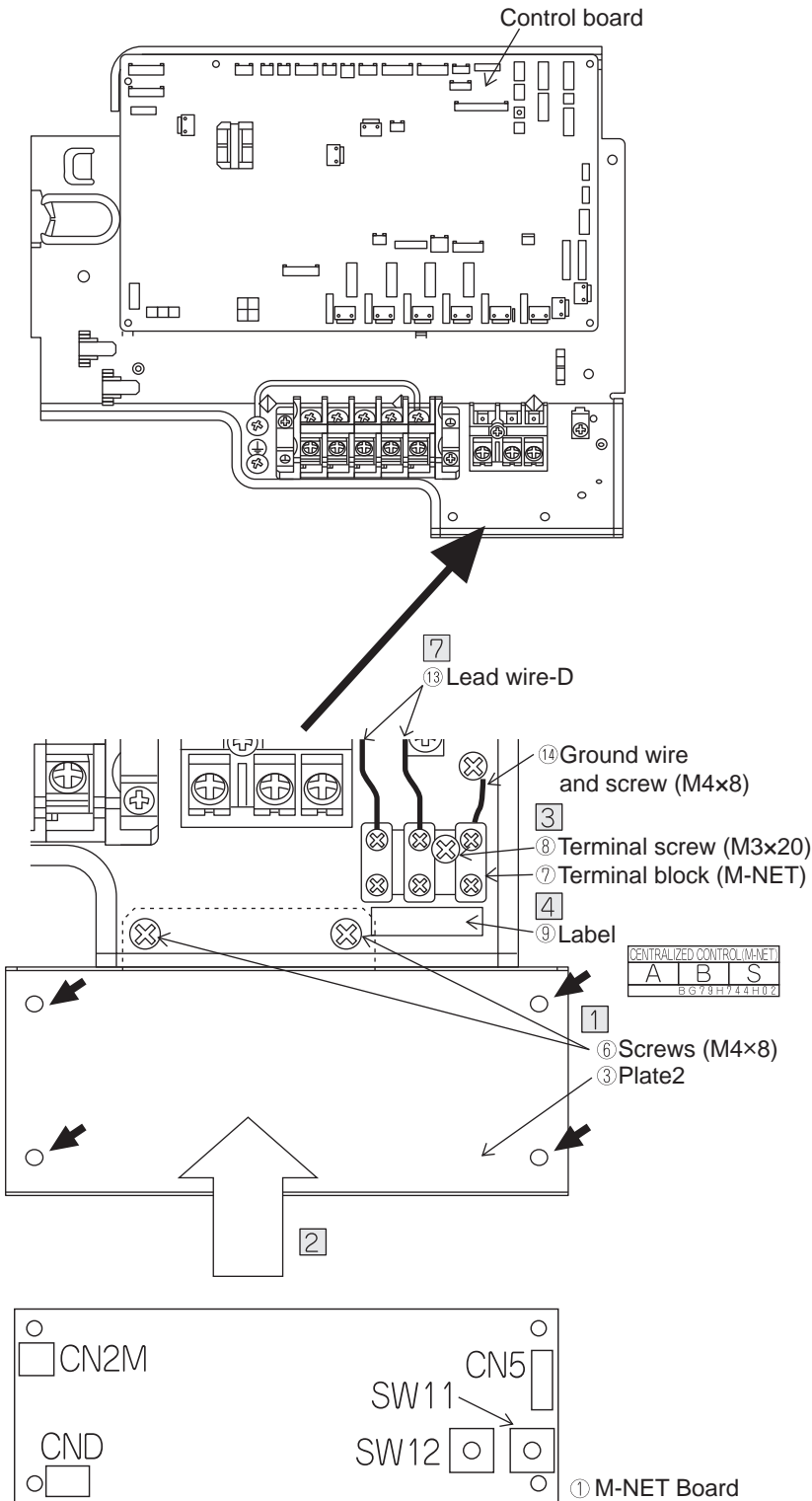

- 1 Attach the plate2 ③, using two screws ⑥.
- 2 Install M-NET board ① (with insulation sheets and supports) on the plate2 ③ so that the rotary switches (SW11, SW12) right side (at the four points indicated by arrows).
Note: Push it firmly until you hear it "click".
- 3 Use terminal screw ⑧ to secure terminal block ⑦.
Note:
Terminal block ⑦ has a round boss for positioning: Fit the round boss into the positioning hole in steel-plate.
- 4 Paste label ⑨ under terminal block ⑦.
- 5 Use lead wire-A ⑩ to connect CN5 of M-NET board ① connection and CNMNT of outdoor control board.
• Caution
Wire Marking: INV type,
Connector color: Red
Always make sure that the markings and the applicable model match. If used incorrectly, parts could be damaged.
- 6 Use lead wire-C ⑫ to connect CND of M-NET board ① connection and CNVMNT of outdoor control board.
- 7 Use lead wire-D ⑬ to connect CN2M of M-NET board ① connection and terminals A and B of terminal block ⑦ Polarity is not a concern.
Note:
Connect the wire firmly making sure that the screws on terminal block are not loose.
- 8 The lead wires should be tied together with the other lead wires with the fastener ⑮ not to loose.
Wiring length is adjusted according to apparatus.

Note1:
Use ground wire and screw ⑭ as required to connect the shield of M-NET transmission line to the unit.
(See the attention on page 2)

Note2:
Take great care that no lead wire is caught on anything when installing panels.

3. Installation procedure [Applicable model : Group D]

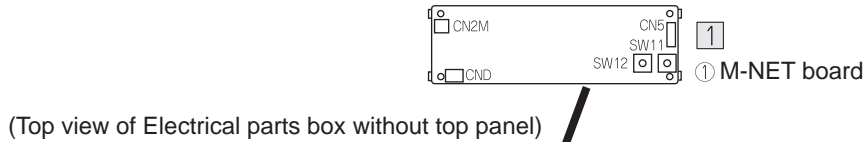

- 1 Install M-NET board ① (with insulation sheets and supports) on the bottom of electrical parts box so that the rotary switches (SW11, SW12) come front.
Note: Push it firmly until you hear it “click”.

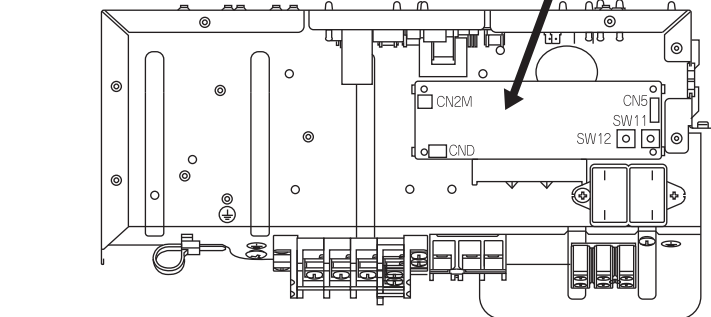

- 2 Use terminal screw ⑧ to secure terminal block ⑦.
Note:
Terminal block ⑦ has a round boss for positioning: Fit the round boss into the positioning hole in steel-plate.

- 3 Paste label ⑨ under terminal block ⑦.

- 4 Use lead wire-B ⑪ to connect CN5 of M-NET board ① connection and CNMNT of outdoor control board.

• Caution

Wire Marking: NON-INV,
Connector color: White

Always make sure that the markings and the applicable model match. If used incorrectly, parts could be damaged.

- 5 Use lead wire-C ⑫ to connect CND of M-NET board ① connection and CNVMNT of outdoor control board.

- 6 Use lead wire-D ⑬ to connect CN2M of M-NET board ① connection and terminals A and B of terminal block ⑦. Polarity is not a concern.

Note:

Connect the wire firmly making sure that the screws on terminal block are not loose.

- 7 The lead wires should be tied together with the other lead wires with the fastener ⑮ not to loose.
Wiring length is adjusted according to apparatus.

Note1:

Use ground wire and screw ⑭ as required to connect the shield of M-NET transmission line to the unit.

(See the attention on page 2)

Note2:

Take great care that no lead wire is caught on anything when installing panels.

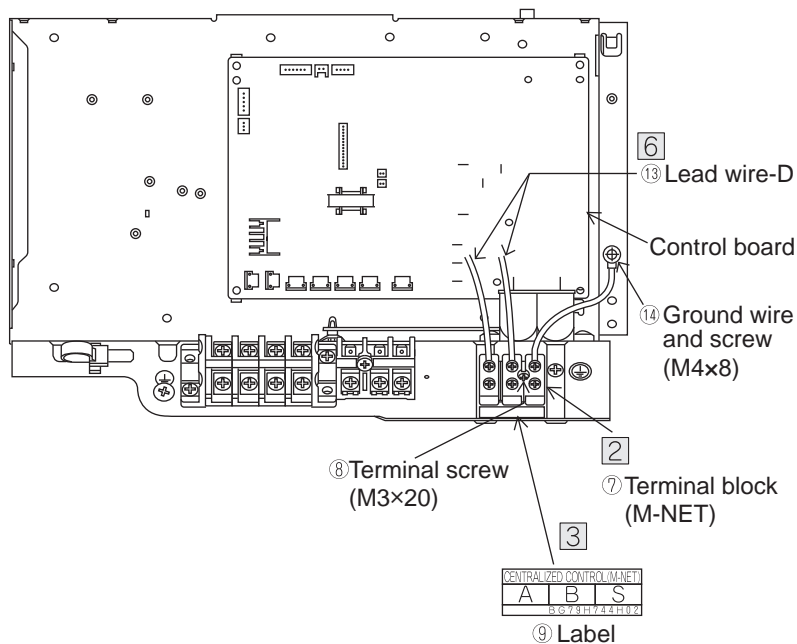

3. Installation procedure [Applicable model : Group E]

■ Single phase model

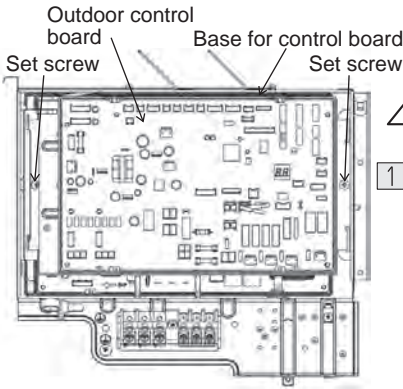

■ 3 phase model

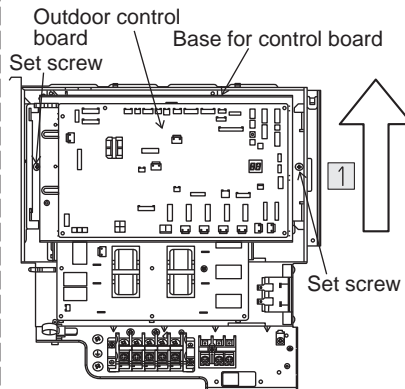

(Back of base for control board)

① M-NET Board

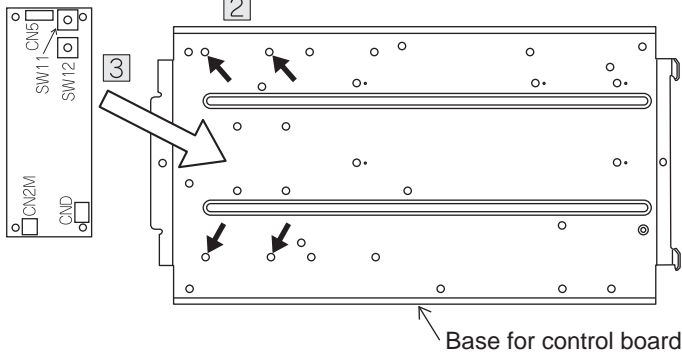

(Viewed from the front of terminal block)

■ Single phase model

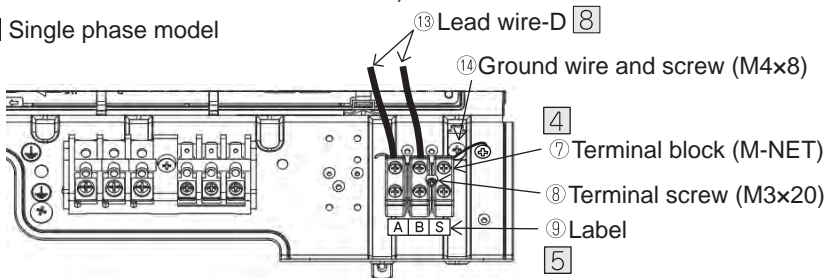

■ 3 phase model

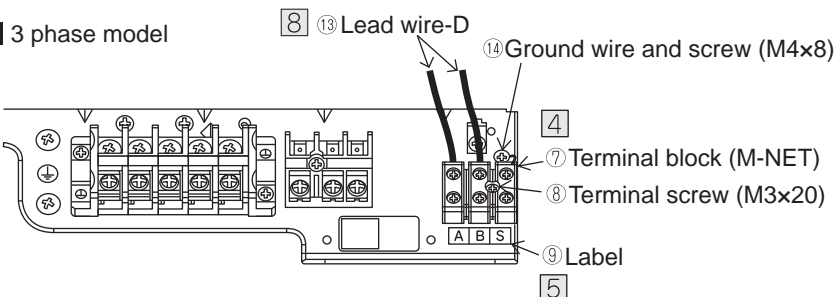

1 Remove the two screws that secure the control board base of electrical parts box, and then slide the base in the direction of the arrow to remove it from the electrical parts box.

2 Check for the four M-NET board ① attachment holes (arrows) in the back of control board base (the control board is attached to the surface).

3 Install the M-NET board ① (with insulation sheets and supports) so that the rotary switches (SW11, SW12) faces up (at the four points indicated by arrows).

4 Use terminal screw ⑧ to secure terminal block ⑦.

Note:

Terminal block ⑦ has a round boss for positioning: Fit the round boss into the positioning hole in steel-plate.

5 Paste label ⑨ under terminal block ⑦.

6 Use lead wire-A ⑩ to connect CN5 of M-NET board ① connection and CNMNT of outdoor control board.

• Caution

Wire Marking: INV type,

Connector color: Red

Always make sure that the markings and the applicable model match. If used incorrectly, parts could be damaged.

7 Use lead wire-C ⑫ to connect CND of M-NET board ① connection and CNVMNT of outdoor control board.

8 Use lead wire-D ⑬ to connect CN2M of M-NET board ① connection and terminals A and B of terminal block ⑦ Polarity is not a concern.

Note:

Connect the wire firmly making sure that the screws on terminal block are not loose.

9 The lead wires should be tied together with the other lead wires with the fastener ⑮ not to loose. Wiring length is adjusted according to apparatus.

Note1:

Use ground wire and screw ⑭ as required to connect the shield of M-NET transmission line to the unit.

(See the attention on page 2)

Note2:

Take great care that no lead wire is caught on anything when installing panels.

3. Installation procedure [Applicable model : Group F]

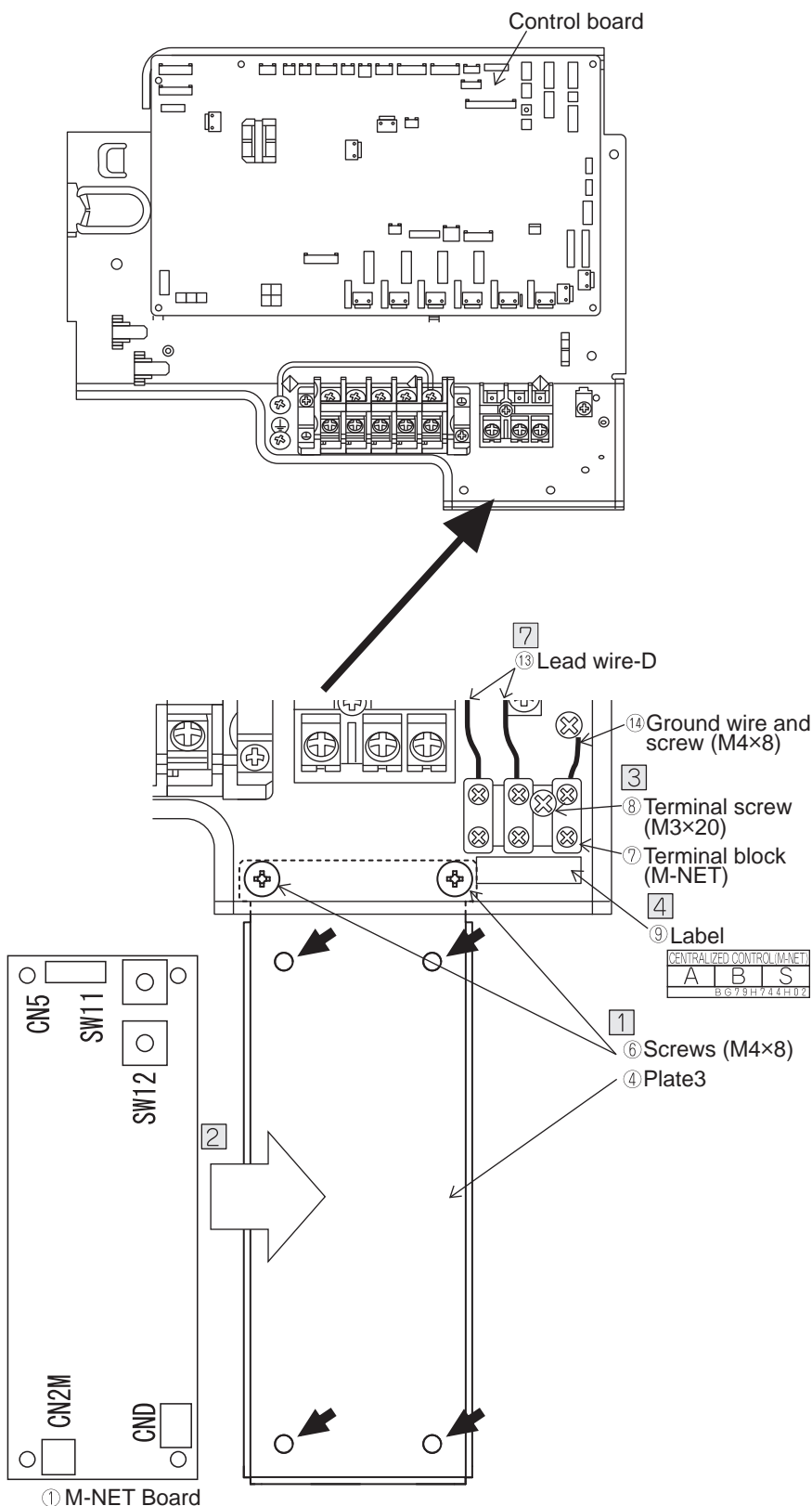

- 1 Attach the plate3 ④, using two screws ⑥.
- 2 Install M-NET board ① (with insulation sheets and supports) on the plate3 ④ so that the rotary switches (SW11, SW12) faces up (at the four points indicated by arrows).
Note: Push it firmly until you hear it "click".
- 3 Use terminal screw ⑧ to secure terminal block ⑦.
Note:
Terminal block ⑦ has a round boss for positioning: Fit the round boss into the positioning hole in steel-plate.
- 4 Paste label ⑨ under terminal block ⑦.
- 5 Use lead wire-A ⑩ to connect CN5 of M-NET board ① connection and CNMNT of outdoor control board.
• Caution
Wire Marking: INV type,
Connector color: Red
Always make sure that the markings and the applicable model match. If used incorrectly, parts could be damaged.
- 6 Use lead wire-C ⑫ to connect CND of M-NET board ① connection and CNVMNT of outdoor control board.
- 7 Use lead wire-D ⑬ to connect CN2M of M-NET board ① connection and terminals A and B of terminal block ⑦ Polarity is not a concern.
Note:
Connect the wire firmly making sure that the screws on terminal block are not loose.
- 8 The lead wires should be tied together with the other lead wires with the fastener ⑮ not to loose.
Wiring length is adjusted according to apparatus.

Note1:
Use ground wire and screw ⑭ as required to connect the shield of M-NET transmission line to the unit.
(See the attention on page 2)

Note2:
Take great care that no lead wire is caught on anything when installing panels.

3. Installation procedure [Applicable model : Group G]

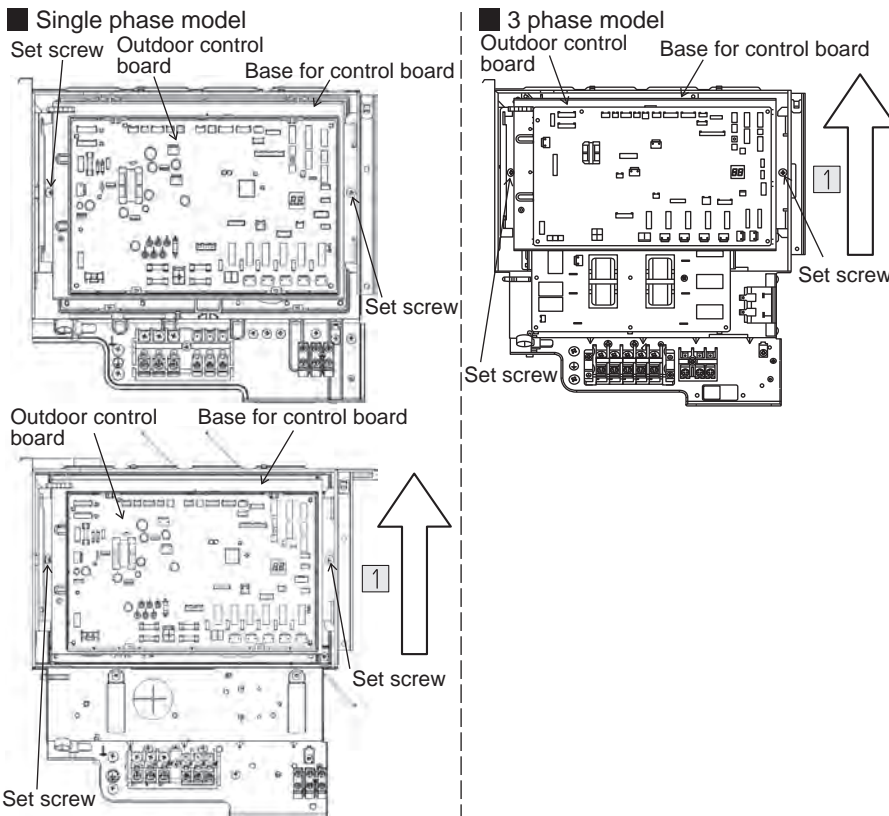

(Back of base for control board)

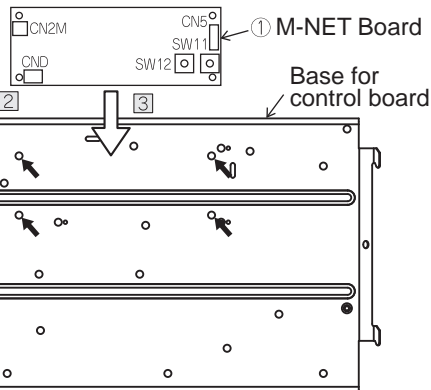

(Viewed from the front of terminal block)

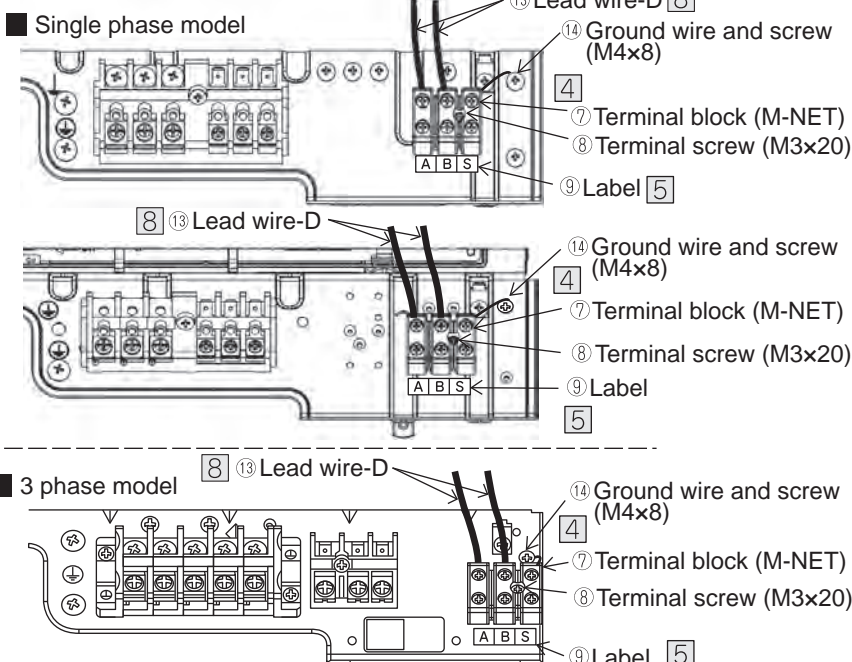

- 1 Remove the two screws that secure the control board base of electrical parts box, and then slide the base in the direction of the arrow to remove it from the electrical parts box.
 - 2 Check for the four M-NET board ① attachment holes (arrows) in the back of control board base (the control board is attached to the surface).
 - 3 Install M-NET board ① (with insulation sheets and supports) so that the rotary switches (SW11, SW12) faces up (at the four points indicated by arrows).
 - 4 Use terminal screw ⑧ to secure terminal block ⑦.
Note:
Terminal block ⑦ has a round boss for positioning: Fit the round boss into the positioning hole in steel-plate.
 - 5 Paste label ⑨ under terminal block ⑦.
 - 6 Use lead wire-A ⑩ to connect CN5 of M-NET board ① connection and CNMNT of outdoor control board.
• Caution
Wire Marking: INV type,
Connector color: Red
Always make sure that the markings and the applicable model match. If used incorrectly, parts could be damaged.
 - 7 Use lead wire-C ⑫ to connect CND of M-NET board ① connection and CNVMNT of outdoor control board.
 - 8 Use lead wire-D ⑬ to connect CN2M of M-NET board ① connection and terminals A and B of terminal block ⑦. Polarity is not a concern.
Note:
Connect the wire firmly making sure that the screws on terminal block are not loose.
 - 9 The lead wires should be tied together with the other lead wires with the fastener ⑮ not to loose.
Wiring length is adjusted according to apparatus.
- Note1:
Use ground wire and screw ⑭ as required to connect the shield of M-NET transmission line to the unit.
(See the attention on page 2)
- Note2:
Take great care that no lead wire is caught on anything when installing panels.

