

Revision B:

- INDOOR UNITS COMBINATION SHEETS for MXZ-3D54VA, MXZ-3D68VA, MXZ-4D72VA, MXZ-4D83VA and MXZ-5D102VA have been added.
- 11-4. TROUBLESHOOTING CHECK TABLE (MXZ-2D) has been modified.

Please void OBH626 REVISED EDITION-A.

OUTDOOR UNIT SERVICE MANUAL



**No. OBH626
REVISED EDITION-B**

Models

MXZ-2D33VA - E1
MXZ-2D40VA - E1
MXZ-2D53VA - E1
MXZ-2D53VAH - E1
MXZ-3D54VA - E1
MXZ-3D68VA - E1
MXZ-4D72VA - E1

MXZ-4D83VA - E1
MXZ-5D102VA - E1

Indoor unit service manual
 MSZ-EF•VE Series (OBH589)
 MSZ-SF•VA Series (OBH555)
 MSZ-SF•VE Series (OBH600)
 MSZ-FH•VE Series (OBH623)
 MFZ-KA•VA Series (OB409)
 MLZ-KA•VA Series (OBH483)
 SLZ-KA•VA Series (OC320)
 SEZ-KD•VA Series (HWE07110)
 PLA-RP•BA Series (OCH412)
 PCA-RP•KA Series (OCH454)
 PEAD-RP•JA Series (HWE08130)

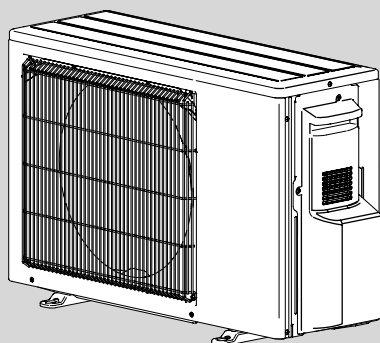

MXZ-2D33VA
 MXZ-2D40VA
 MXZ-2D53VA MXZ-2D53VAH

CONTENTS

1. TECHNICAL CHANGES	3...
2. PART NAMES AND FUNCTIONS	4
3. SPECIFICATION	5.....
4. NOISE CRITERIA CURVES	13
5. OUTLINES AND DIMENSIONS	16
6. WIRING DIAGRAM	20...
7. REFRIGERANT SYSTEM DIAGRAM	27
8. PERFORMANCE CURVES	34
9. ACTUATOR CONTROL	62..
10. SERVICE FUNCTIONS	63..
11. TROUBLESHOOTING	67..
12. DISASSEMBLY INSTRUCTIONS	97

INDOOR UNITS COMBINATION SHEETS

NOTE:

RoHS compliant products have <G> mark on the spec name plate.

PARTS CATALOG (OBB626)



Use the specified refrigerant only

Never use any refrigerant other than that specified.

Doing so may cause a burst, an explosion, or fire when the unit is being used, serviced, or disposed of.

Correct refrigerant is specified in the manuals and on the spec labels provided with our products.

We will not be held responsible for mechanical failure, system malfunction, unit breakdown or accidents caused by failure to follow the instructions.

<Preparation before the repair service>

- Prepare the proper tools.
- Prepare the proper protectors.
- Provide adequate ventilation.
- After stopping the operation of the air conditioner, turn off the power-supply breaker and remove the power plug.
- Discharge the capacitor before the work involving the electric parts.

<Precautions during the repair service>

- Do not perform the work involving the electric parts with wet hands.
- Do not pour water into the electric parts.
- Do not touch the refrigerant.
- Do not touch the hot or cold areas in the refrigeration cycle.
- When the repair or the inspection of the circuit needs to be done without turning off the power, exercise great caution not to touch the live parts.

Revision A:

- MXZ-3D54VA- [E1], MXZ-3D68VA- [E1], MXZ-4D72VA- [E1], MXZ-4D83VA- [E1] and MXZ-5D102VA- [E1] have been added.

Revision B:

- INDOOR UNITS COMBINATION SHEETS for MXZ-3D54VA, MXZ-3D68VA, MXZ-4D72VA, MXZ-4D83VA and MXZ-5D102VA have been added.
- 11-4. TROUBLESHOOTING CHECK TABLE (MXZ-2D) has been modified.

MXZ-2C30VA -[E1] → MXZ-2D33VA -[E1]

1. Grill has been changed.
2. Ice guard has been added.
3. Electrical parts have been changed.
4. Fan motor has been changed.
5. Indoor units combinations have been added.
6. Compressor has been changed. (KNB073FGDHC → KNB073FFDHC)

MXZ-2C40VA -[E1] → MXZ-2D40VA -[E1]**MXZ-2C52VA -[E1] → MXZ-2D53VA -[E1]**

1. Grill has been changed.
2. Ice guard has been added.
3. Electrical parts have been changed.
4. Fan motor has been changed.
5. Indoor units combinations have been added.

MXZ-2C52VA -[E1] → MXZ-2D53VAH -[E1]

1. Grill has been changed.
2. Ice guard has been added.
3. Electrical parts have been changed.
4. Fan motor has been changed.
5. Indoor units combinations have been added.
6. Base heater has been added.
7. Drain socket has been removed.

MXZ-3C54VA -[E1] → MXZ-3D54VA -[E1]**MXZ-3C68VA -[E1] → MXZ-3D68VA -[E1]****MXZ-4C71VA -[E1] → MXZ-4D72VA -[E1]**

1. Grill has been changed.
2. Ice guard has been added.
3. Power board has been changed.
4. Electrical control P.C. board has been changed.
5. Noise filter P.C. board has been changed.
6. Fan motor has been changed.
7. Indoor units combinations have been added (MSZ-FH Series).

MXZ-4C80VA2 -[E1] → MXZ-4D83VA -[E1]**MXZ-5C100VA2 -[E1] → MXZ-5D102VA -[E1]**

1. Indoor units combinations have been added (MSZ-FH Series).

2

PART NAMES AND FUNCTIONS

**MXZ-2D33VA
MXZ-2D40VA
MXZ-2D53VA
MXZ-2D53VAH**

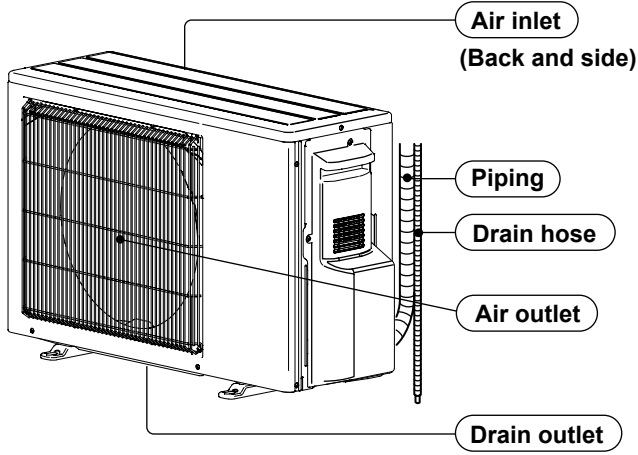

**MXZ-3D54VA
MXZ-3D68VA
MXZ-4D72VA**

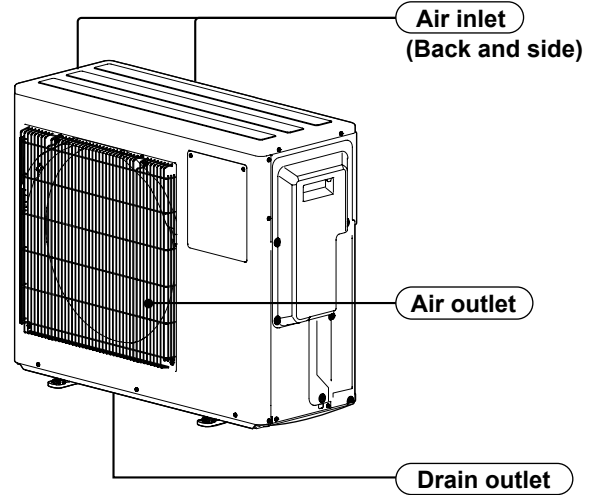

**MXZ-4D83VA
MXZ-5D102VA**

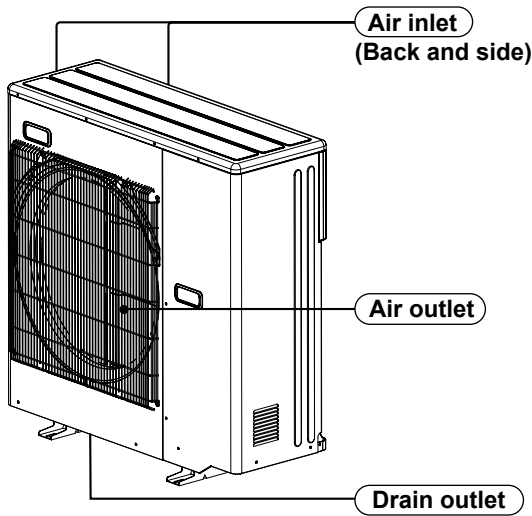

ACCESSORIES

Model	MXZ-2D33VA MXZ-2D40VA MXZ-2D53VA MXZ-4D83VA MXZ-5D102VA	MXZ-3D54VA MXZ-3D68VA MXZ-4D72VA
① Drain socket	1	1
② Drain cap		2

3

SPECIFICATION

Outdoor model			MXZ-2D33VA	
Outdoor unit power supply			Single phase 230 V, 50 Hz	
System	Indoor units number		1 to 2	
	Piping total length	m	Max. 20	
	Connecting pipe length	m	Max. 15	
	Height difference (Indoor ~ Outdoor)	m	Refer to 7 REFRIGERANT SYSTEM DIAGRAM.	
	Height difference (Indoor ~ Indoor)	m	Refer to 7 REFRIGERANT SYSTEM DIAGRAM.	
Function			Cooling	Heating
Capacity Rated frequency (Min.-Max.) *2		kW	3.3 (1.1 - 3.8)	4.0 (1.0 - 4.1)
Breaker capacity		A	15	
Electrical data	Power input (Total) *1, *2	W	900	960
	Running current (Total) *1, *2	A	4.3	4.6
	Power factor (Total) *1, *2	%	90	
	Starting current (Total) *1, *2	A	4.6	
Coeff icient of performance (C.O.P) (Total) *1, *2			3.67	4.17
Compressor	Model		KNB073FFDHC	
	Output	W	800	
	Current *1, *2	A	4.0	4.2
	Refrigeration oil (Model)	L	0.32 (NEO22)	
Fan motor	Model		RC0J50-FA	
	Current *1, *2	A	0.35	
Dimensions W x H x D		mm	800 x 550 x 285	
Weight		kg	32	
Special remarks	Air f ow (Rated)	m ³ /h	1,974	2,022
	Sound level (Rated)	dB(A)	49	50
	Fan speed (Rated)	rpm	860	880
	Refrigerant f lling capacity (R410A)	kg	1.15	

*1 Measured under rated operating frequency.

*2 When connected with below indoor units.

MSZ-SF15VA + MSZ-EF18VE

NOTE: Test conditions are based on ISO 5151. (Refrigerant piping length (one way): 5 m)

COOLING INDOOR Dry-bulb temperature 27.0 °C Wet-bulb temperature 19.0 °C

OUTDOOR Dry-bulb temperature 35.0 °C Wet-bulb temperature 24.0 °C

HEATING INDOOR Dry-bulb temperature 20.0 °C

OUTDOOR Dry-bulb temperature 7.0 °C Wet-bulb temperature 6.0 °C

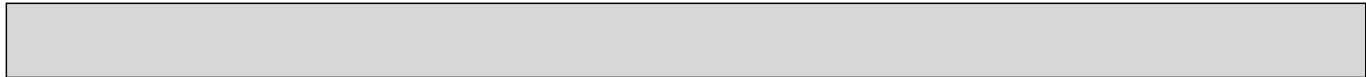

Outdoor model			MXZ-2D40VA	
Outdoor unit power supply			Single phase 230 V, 50 Hz	
System	Indoor units number		1 to 2	
	Piping total length	m	Max. 30	
	Connecting pipe length	m	Max. 20	
	Height difference (Indoor ~ Outdoor)	m	Refer to 7 REFRIGERANT SYSTEM DIAGRAM.	
	Height difference (Indoor ~ Indoor)	m	Refer to 7 REFRIGERANT SYSTEM DIAGRAM.	
Function			Cooling	Heating
Capacity Rated frequency (Min.-Max.) *2		kW	4.0 (1.1 - 4.3)	4.5 (1.0 - 4.8)
Breaker capacity		A	15	
Electrical data	Power input (Total) *1, *2		W	
	Running current (Total) *1, *2		A	
	Power factor (Total) *1, *2		%	
	Starting current (Total) *1, *2		A	
Coefficient of performance (C.O.P) (Total) *1, *2			4.12	4.64
Compressor	Model		KNB092FFDHC	
	Output	W	1,100	
	Current *1, *2	A	4.4	4.2
	Refrigeration oil (Model)	L	0.32 (NEO22)	
Fan motor	Model		RC0J50-FA	
	Current *1, *2	A	0.35	
Dimensions W x H x D		mm	800 x 550 x 285	
Weight		kg	34	
Special remarks	Air flow (Rated)	m ³ /h	1,752	1,662
	Sound level (Rated)	dB(A)	49	50
	Fan speed (Rated)	rpm	840	800
	Refrigerant filling capacity (R410A)	kg	1.3	

*1 Measured under rated operating frequency.

*2 When connected with below indoor units.

MSZ-EF18VE + MSZ-EF22VE

NOTE: Test conditions are based on ISO 5151. (Refrigerant piping length (one way): 5 m)

COOLING INDOOR Dry-bulb temperature 27.0 °C Wet-bulb temperature 19.0 °C

OUTDOOR Dry-bulb temperature 35.0 °C Wet-bulb temperature 24.0 °C

HEATING INDOOR Dry-bulb temperature 20.0 °C

OUTDOOR Dry-bulb temperature 7.0 °C Wet-bulb temperature 6.0 °C



Outdoor model			MXZ-2D53VA MXZ-2D53VAH		
Outdoor unit power supply			Single phase 230 V, 50 Hz		
System	Indoor units number		1 to 2		
	Piping total length	m	Max. 30		
	Connecting pipe length	m	Max. 20		
	Height difference (Indoor ~ Outdoor)	m	Refer to 7 REFRIGERANT SYSTEM DIAGRAM.		
	Height difference (Indoor ~ Indoor)	m	Refer to 7 REFRIGERANT SYSTEM DIAGRAM.		
Function			Cooling	Heating	
Capacity Rated frequency (Min.-Max.) *2		kW	5.3 (1.1 - 5.6)	6.4 (1.0 - 7.0)	
Breaker capacity		A	15		
Electrical data	Power input (Total) *1, *2		W	1,540	1,700
	Running current (Total) *1, *2		A	6.9	7.6
	Power factor (Total) *1, *2		%	97	
	Starting current (Total) *1, *2		A	7.6	
Coeff icient of performance (C.O.P) (Total) *1, *2			3.44	3.76	
Compressor	Model		SNB130FGBHT		
	Output	W	1,400		
	Current *1, *2	A	6.6	7.2	
	Refrigeration oil (Model)	L	0.45 (NEO22)		
Fan motor	Model		RC0J50-FA		
	Current *1, *2	A	0.35		
Dimensions W x H x D		mm	800 x 550 x 285		
Weight		kg	MXZ-2D53VA: 37 MXZ-2D53VAH: 38		
Special remarks	Air f ow (Rated)	m ³ /h	1,974	1,998	
	Sound level (Rated)	dB(A)	50	53	
	Fan speed (Rated)	rpm	900	910	
	Refrigerant f lling capacity (R410A)	kg	1.3		

*1 Measured under rated operating frequency.

*2 When connected with below indoor units.

MSZ-EF18VE + MSZ-EF35VE

NOTE: Test conditions are based on ISO 5151. (Refrigerant piping length (one way): 5 m)

COOLING INDOOR Dry-bulb temperature 27.0 °C Wet-bulb temperature 19.0 °C

OUTDOOR Dry-bulb temperature 35.0 °C Wet-bulb temperature 24.0 °C

HEATING INDOOR Dry-bulb temperature 20.0 °C

OUTDOOR Dry-bulb temperature 7.0 °C Wet-bulb temperature 6.0 °C



Outdoor model			MXZ-3D54VA	
Outdoor unit power supply			Single phase 230 V, 50 Hz	
System	Indoor units number		1 to 3	
	Piping total length	m	Max. 50	
	Connecting pipe length	m	Max. 25	
	Height difference (Indoor ~ Outdoor)	m	Refer to 7 REFRIGERANT SYSTEM DIAGRAM.	
	Height difference (Indoor ~ Indoor)	m	Refer to 7 REFRIGERANT SYSTEM DIAGRAM.	
Function			Cooling	Heating
Capacity Rated frequency (Min.-Max.) *2		kW	5.4 (2.9 - 6.8)	7.0 (2.6 - 9.0)
Breaker capacity		A	25	
Electrical data	Power input (Total) *1, *2	W	1,390	1,590
	Running current (Total) *1, *2	A	6.1	7.0
	Power factor (Total) *1, *2	%	99	
	Starting current (Total) *1, *2	A	7.0	
Coefficient of performance (C.O.P) (Total) *1, *2			3.88	4.40
Compressor	Model		SNB130FGBH1T	
	Output	W	1,400	
	Current *1, *2	A	5.72	6.62
	Refrigeration oil (Model)	L	0.7 (NEO22)	
Fan motor	Model		SIC-71FW-F764-1	
	Current *1, *2	A	0.2	
Dimensions W x H x D		mm	840 x 710 x 330	
Weight		kg	57	
Special remarks	Air flow (Rated)	m ³ /h	2,334	2,376
	Sound level (Rated)	dB(A)	50	53
	Fan speed (Rated)	rpm	650	660
	Refrigerant filling capacity (R410A)	kg	2.7	

*1 Measured under rated operating frequency.

*2 When connected with below indoor units.

MSZ-EF18VE + MSZ-EF18VE + MSZ-EF18VE

NOTE: Test conditions are based on ISO 5151. (Refrigerant piping length (one way): 5 m)

COOLING INDOOR Dry-bulb temperature 27.0 °C Wet-bulb temperature 19.0 °C

OUTDOOR Dry-bulb temperature 35.0 °C Wet-bulb temperature 24.0 °C

HEATING INDOOR Dry-bulb temperature 20.0 °C

OUTDOOR Dry-bulb temperature 7.0 °C Wet-bulb temperature 6.0 °C



Outdoor model			MXZ-3D68VA	
Outdoor unit power supply			Single phase 230 V, 50 Hz	
System	Indoor units number		1 to 3	
	Piping total length	m	Max. 60	
	Connecting pipe length	m	Max. 25	
	Height difference (Indoor ~ Outdoor)	m	Refer to 7 REFRIGERANT SYSTEM DIAGRAM.	
	Height difference (Indoor ~ Indoor)	m	Refer to 7 REFRIGERANT SYSTEM DIAGRAM.	
Function			Cooling	Heating
Capacity Rated frequency (Min.-Max.) *2		kW	6.8 (2.9 - 8.4)	8.6 (2.6 - 10.6)
Breaker capacity		A	25	
Electrical data	Power input (Total) *1, *2	W	2,190	2,380
	Running current (Total) *1, *2	A	9.6	10.5
	Power factor (Total) *1, *2	%	99	
	Starting current (Total) *1, *2	A	10.5	
Coeff icient of performance (C.O.P) (Total) *1, *2			3.11	3.61
Compressor	Model		SNB172FEGH1T	
	Output	W	1,800	
	Current *1, *2	A	9.22	10.12
	Refrigeration oil (Model)	L	0.7 (NEO22)	
Fan motor	Model		SIC-71FW-F764-1	
	Current *1, *2	A	0.2	
Dimensions W x H x D		mm	840 x 710 x 330	
Weight		kg	57	
Special remarks	Air f ow (Rated)	m ³ /h	2,334	2,376
	Sound level (Rated)	dB(A)	50	53
	Fan speed (Rated)	rpm	650	660
	Refrigerant f lling capacity (R410A)	kg	2.7	

*1 Measured under rated operating frequency.

*2 When connected with below indoor units.

MSZ-EF18VE + MSZ-EF25VE + MSZ-EF25VE

NOTE: Test conditions are based on ISO 5151. (Refrigerant piping length (one way): 5 m)

COOLING INDOOR Dry-bulb temperature 27.0 °C Wet-bulb temperature 19.0 °C

OUTDOOR Dry-bulb temperature 35.0 °C Wet-bulb temperature 24.0 °C

HEATING INDOOR Dry-bulb temperature 20.0 °C

OUTDOOR Dry-bulb temperature 7.0 °C Wet-bulb temperature 6.0 °C



Outdoor model			MXZ-4D72VA	
Outdoor unit power supply			Single phase 230 V, 50 Hz	
System	Indoor units number		1 to 4	
	Piping total length	m	Max. 60	
	Connecting pipe length	m	Max. 25	
	Height difference (Indoor ~ Outdoor)	m	Refer to 7 REFRIGERANT SYSTEM DIAGRAM.	
	Height difference (Indoor ~ Indoor)	m	Refer to 7 REFRIGERANT SYSTEM DIAGRAM.	
Function			Cooling	Heating
Capacity Rated frequency (Min.-Max.) *2		kW	7.2 (3.7 - 8.8)	8.6 (3.4 - 10.7)
Breaker capacity		A	25	
Electrical data	Power input (Total) *1, *2	W	2,250	2,280
	Running current (Total) *1, *2	A	9.9	10.0
	Power factor (Total) *1, *2	%	99	
	Starting current (Total) *1, *2	A	10.0	
Coefficient of performance (C.O.P) (Total) *1, *2			3.20	3.77
Compressor	Model		SNB172FEGH1T	
	Output	W	2,000	
	Current *1, *2	A	9.46	9.56
	Refrigeration oil (Model)	L	0.7 (NEO22)	
Fan motor	Model		SIC-71FW-F764-1	
	Current *1, *2	A	0.2	
Dimensions W x H x D		mm	840 x 710 x 330	
Weight		kg	58	
Special remarks	Air flow (Rated)	m ³ /h	2,334	2,376
	Sound level (Rated)	dB(A)	50	53
	Fan speed (Rated)	rpm	650	660
	Refrigerant filling capacity (R410A)	kg	2.7	

*1 Measured under rated operating frequency.

*2 When connected with below indoor units.

MSZ-EF18VE + MSZ-EF18VE + MSZ-EF18VE + MSZ-EF18VE

NOTE: Test conditions are based on ISO 5151. (Refrigerant piping length (one way): 5 m)

COOLING INDOOR Dry-bulb temperature 27.0 °C Wet-bulb temperature 19.0 °C

OUTDOOR Dry-bulb temperature 35.0 °C Wet-bulb temperature 24.0 °C

HEATING INDOOR Dry-bulb temperature 20.0 °C

OUTDOOR Dry-bulb temperature 7.0 °C Wet-bulb temperature 6.0 °C



Outdoor model			MXZ-4D83VA	
Outdoor unit power supply			Single phase 230 V, 50 Hz	
System	Indoor units number		1 to 4	
	Piping total length	m	Max. 70	
	Connecting pipe length	m	Max. 25	
	Height difference (Indoor ~ Outdoor)	m	Refer to 7 REFRIGERANT SYSTEM DIAGRAM.	
	Height difference (Indoor ~ Indoor)	m	Refer to 7 REFRIGERANT SYSTEM DIAGRAM.	
Function			Cooling	Heating
Capacity Rated frequency (Min.-Max.) *2		kW	8.3 (3.7 - 9.2)	9.0 (3.4 - 11.6)
Breaker capacity		A	25	
Electrical data	Power input (Total) *1, *2	W	2,830	2,420
	Running current (Total) *1, *2	A	12.4	10.6
	Power factor (Total) *1, *2	%	99	
	Starting current (Total) *1, *2	A	12.4	
Coeff icient of performance (C.O.P) (Total) *1, *2			2.93	3.72
Compressor	Model		TNB220FMCH	
	Output	W	2,100	
	Current *1, *2	A	11.76	9.96
	Refrigeration oil (Model)	L	0.87 (NEO22)	
Fan motor	Model		RC0J60-CC	
	Current *1, *2	A	0.4	
Dimensions W x H x D		mm	900 x 915 x 320	
Weight		kg	69	
Special remarks	Air f ow (Rated)	m ³ /h	2,526	2,628
	Sound level (Rated)	dB(A)	49	50
	Fan speed (Rated)	rpm	600	620
	Refrigerant f lling capacity (R410A)	kg	3.5	

*1 Measured under rated operating frequency.

*2 When connected with below indoor units.

MSZ-EF18VE + MSZ-EF18VE + MSZ-EF22VE + MSZ-EF25VE

NOTE: Test conditions are based on ISO 5151. (Refrigerant piping length (one way): 5 m)

COOLING INDOOR Dry-bulb temperature 27.0 °C Wet-bulb temperature 19.0 °C

OUTDOOR Dry-bulb temperature 35.0 °C Wet-bulb temperature 24.0 °C

HEATING INDOOR Dry-bulb temperature 20.0 °C

OUTDOOR Dry-bulb temperature 7.0 °C Wet-bulb temperature 6.0 °C



Outdoor model			MXZ-5D102VA		
Outdoor unit power supply			Single phase 230 V, 50 Hz		
System	Indoor units number		1 to 5		
	Piping total length	m	Max. 80		
	Connecting pipe length	m	Max. 25		
	Height difference (Indoor ~ Outdoor)	m	Refer to 7 REFRIGERANT SYSTEM DIAGRAM.		
	Height difference (Indoor ~ Indoor)	m	Refer to 7 REFRIGERANT SYSTEM DIAGRAM.		
Function			Cooling	Heating	
Capacity Rated frequency (Min.-Max.) *2		kW	10.2 (3.9 - 11.0)	10.5 (4.1 - 14.0)	
Breaker capacity		A	25		
Electrical data	Power input (Total) *1, *2		W	3,910	2,900
	Running current (Total) *1, *2		A	17.2	12.7
	Power factor (Total) *1, *2		%	99	
	Starting current (Total) *1, *2		A	17.2	
Coeff icient of performance (C.O.P) (Total) *1, *2			2.61	3.62	
Compressor	Model		TNB220FMCH		
	Output	W	2,700		
	Current *1, *2	A	16.5	12.0	
	Refrigeration oil (Model)	L	0.87 (NEO22)		
Fan motor	Model		RC0J60-CC		
	Current *1, *2	A	0.4		
Dimensions W x H x D		mm	900 x 915 x 320		
Weight		kg	70		
Special remarks	Air f ow (Rated)	m ³ /h	3,396	3,558	
	Sound level (Rated)	dB(A)	53	55	
	Fan speed (Rated)	rpm	780	810	
	Refrigerant f lling capacity (R410A)	kg	4.0		

*1 Measured under rated operating frequency.

*2 When connected with below indoor units.

MSZ-EF18VE + MSZ-EF18VE + MSZ-EF22VE + MSZ-EF22VE + MSZ-EF22VE

NOTE: Test conditions are based on ISO 5151. (Refrigerant piping length (one way): 5 m)

COOLING INDOOR Dry-bulb temperature 27.0 °C Wet-bulb temperature 19.0 °C

OUTDOOR Dry-bulb temperature 35.0 °C Wet-bulb temperature 24.0 °C

HEATING INDOOR Dry-bulb temperature 20.0 °C

OUTDOOR Dry-bulb temperature 7.0 °C Wet-bulb temperature 6.0 °C

4

NOISE CRITERIA CURVES

MXZ-2D33VA

FAN SPEED	FUNCTION	SPL(dB(A))	LINE
High	Cooling	49	●—●
High	Heating	50	○—○

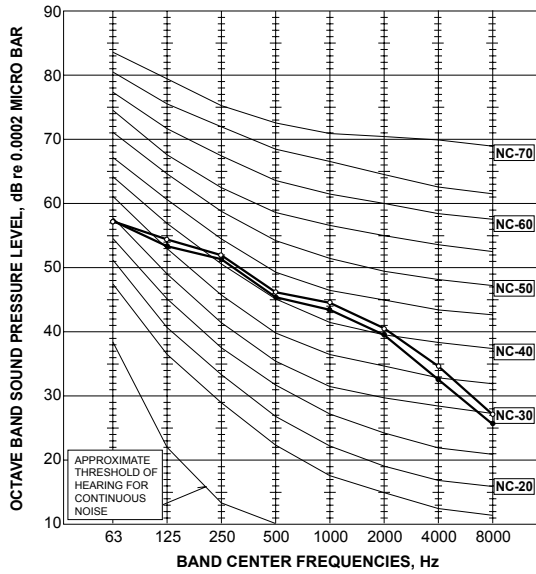

MXZ-2D40VA

FAN SPEED	FUNCTION	SPL(dB(A))	LINE
High	Cooling	49	●—●
High	Heating	50	○—○

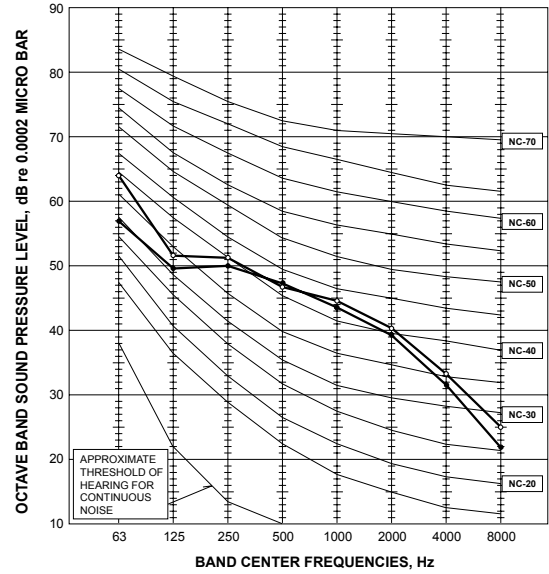

MXZ-2D53VA

FAN SPEED	FUNCTION	SPL(dB(A))	LINE
High	Cooling	50	●—●
High	Heating	53	○—○

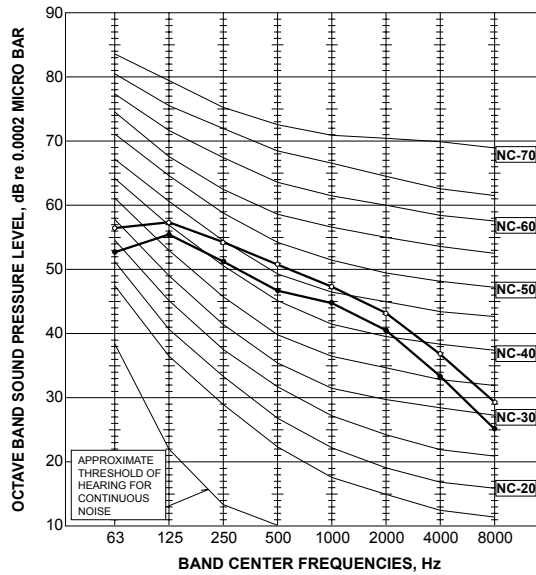

MXZ-2D53VAH

FAN SPEED	FUNCTION	SPL(dB(A))	LINE
High	Cooling	50	●—●
High	Heating	53	○—○

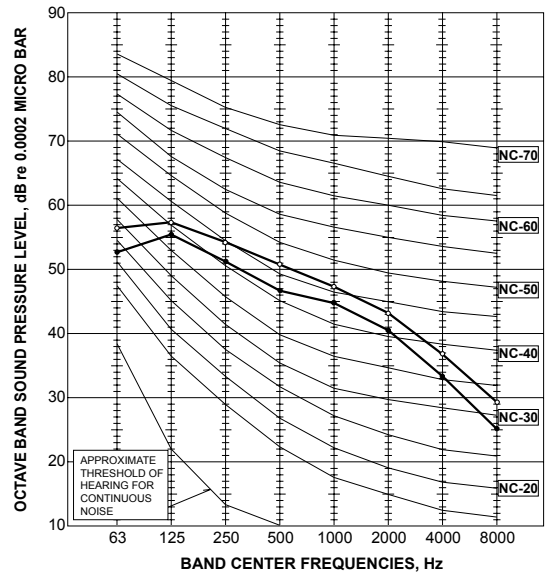

MXZ-3D54VA

FAN SPEED	FUNCTION	SPL(dB(A))	LINE
High	Cooling	50	●—●
High	Heating	53	○—○

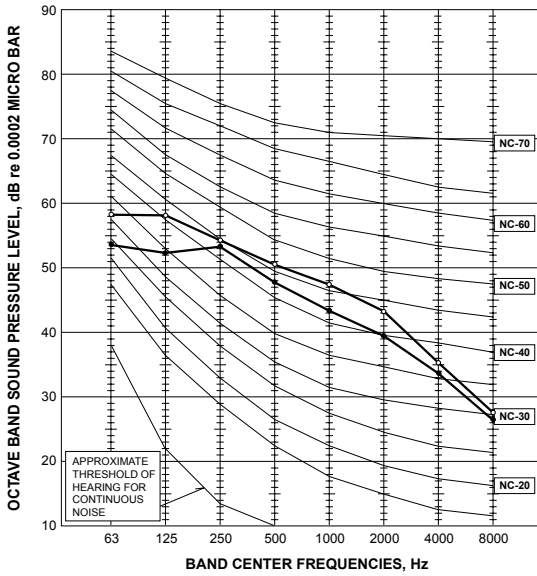

MXZ-3D68VA

FAN SPEED	FUNCTION	SPL(dB(A))	LINE
High	Cooling	50	●—●
High	Heating	53	○—○

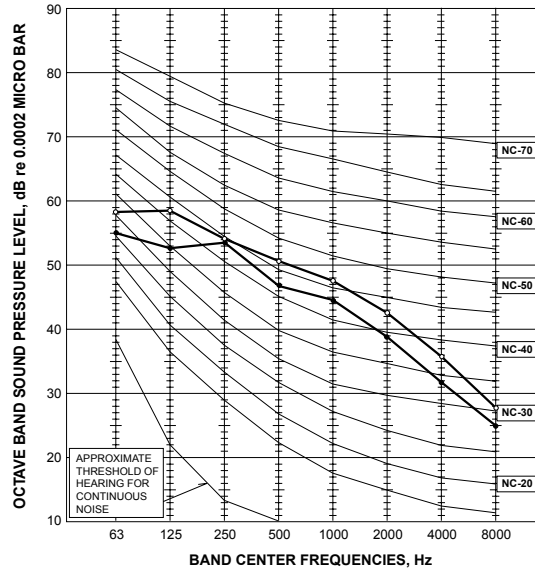

MXZ-4D72VA

FAN SPEED	FUNCTION	SPL(dB(A))	LINE
High	Cooling	50	●—●
High	Heating	53	○—○

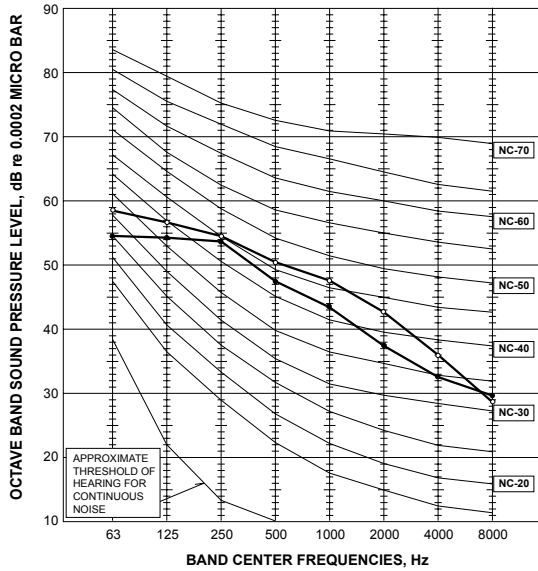

MXZ-4D83VA

FAN SPEED	FUNCTION	SPL(dB(A))	LINE
High	Cooling	48	●—●
High	Heating	51	○—○

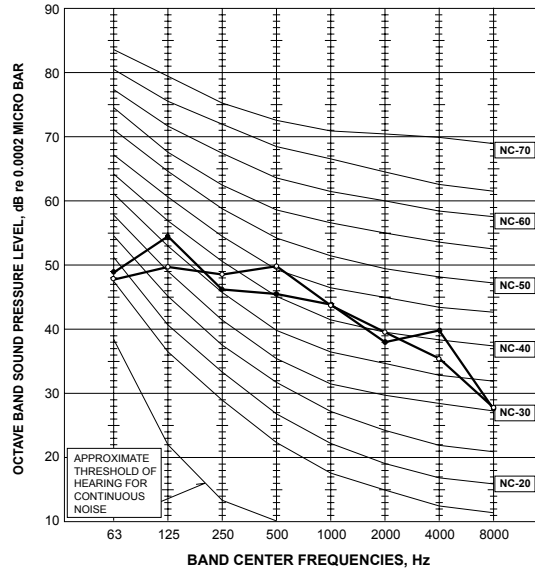

MXZ-5D102VA

FAN SPEED	FUNCTION	SPL(dB(A))	LINE
High	Cooling	48	●—●
High	Heating	51	○—○

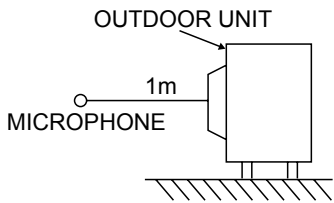
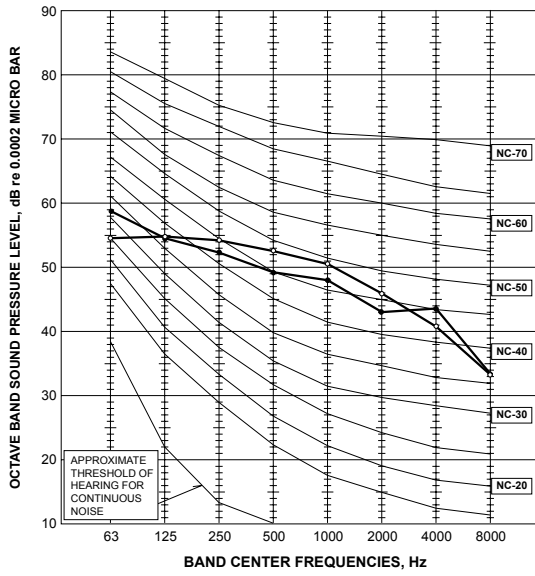

Test conditions

Cooling :Dry-bulb temperature 35°C Wet-bulb temperature 24°C
 Heating :Dry-bulb temperature 7°C Wet-bulb temperature 6°C

OUTLINES AND DIMENSIONS

MXZ-2D33VA MXZ-2D40VA MXZ-2D53VA MXZ-2D53VAH

Unit: mm

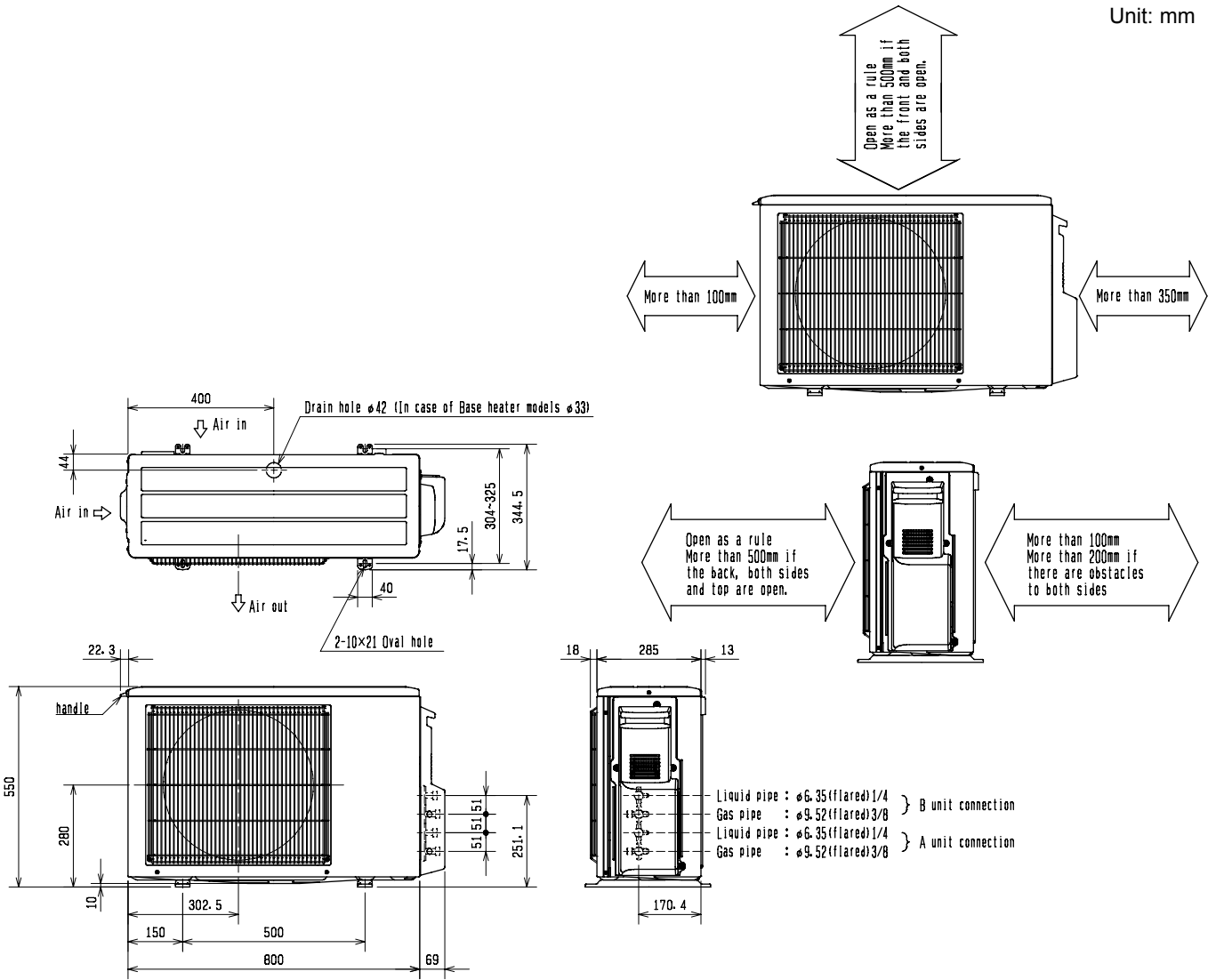

MXZ-3D54VA MXZ-3D68VA

Unit: mm

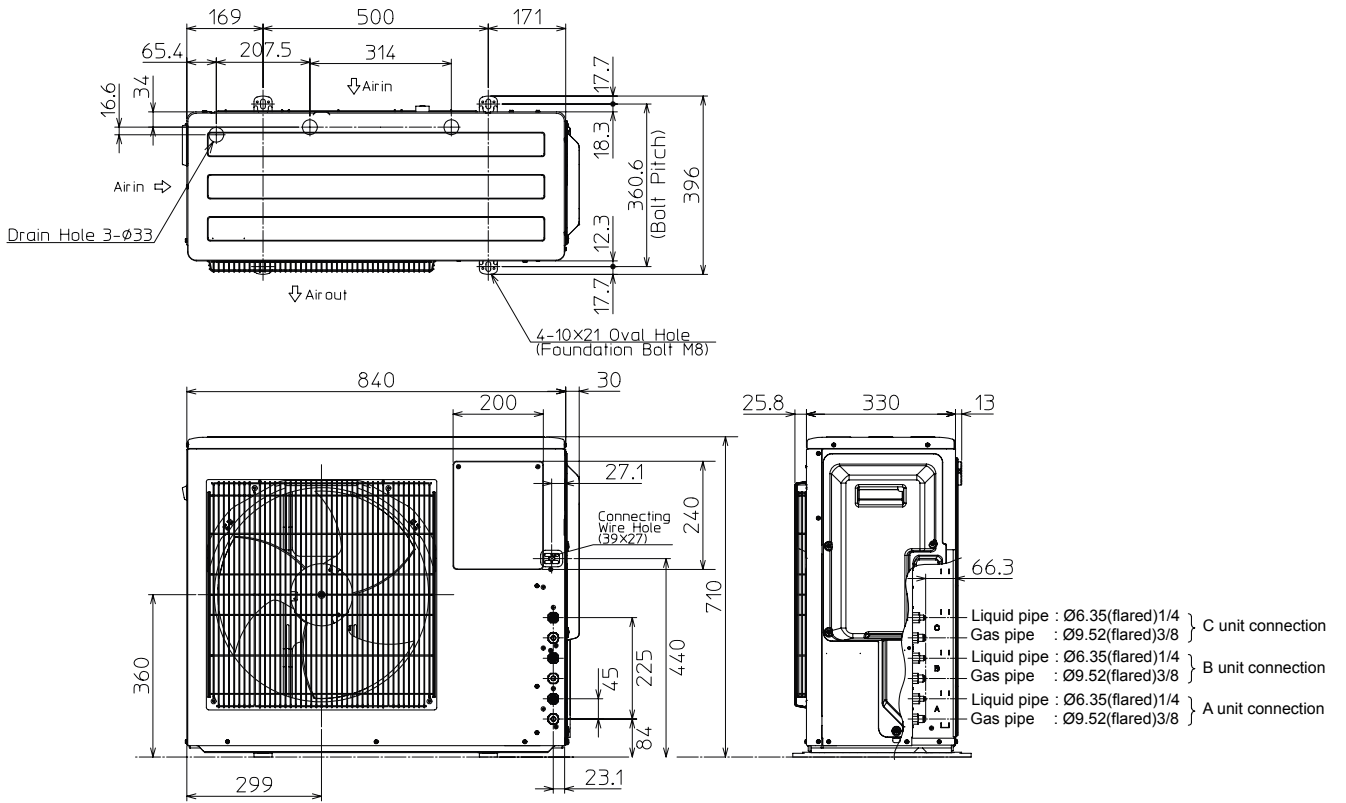

1. Installation space

Note : Leave front and both sides free of obstruction.

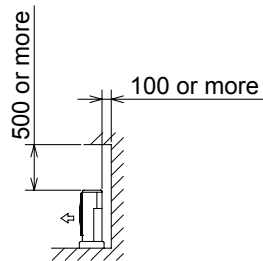

Note : Leave front and overhead free of obstruction.

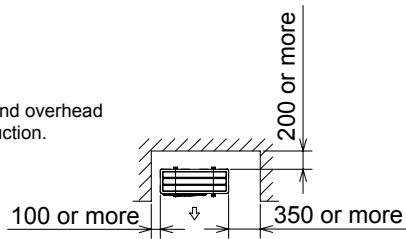

Note : Leave rear, overhead and both sides free of obstruction.

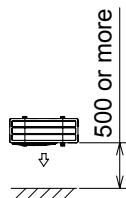

2. Service space

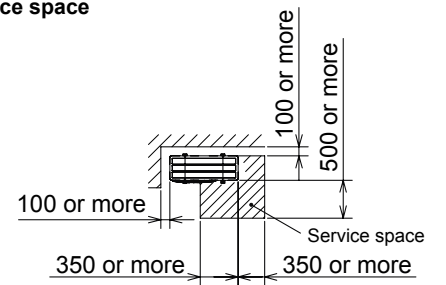

MXZ-4D72VA

Unit: mm

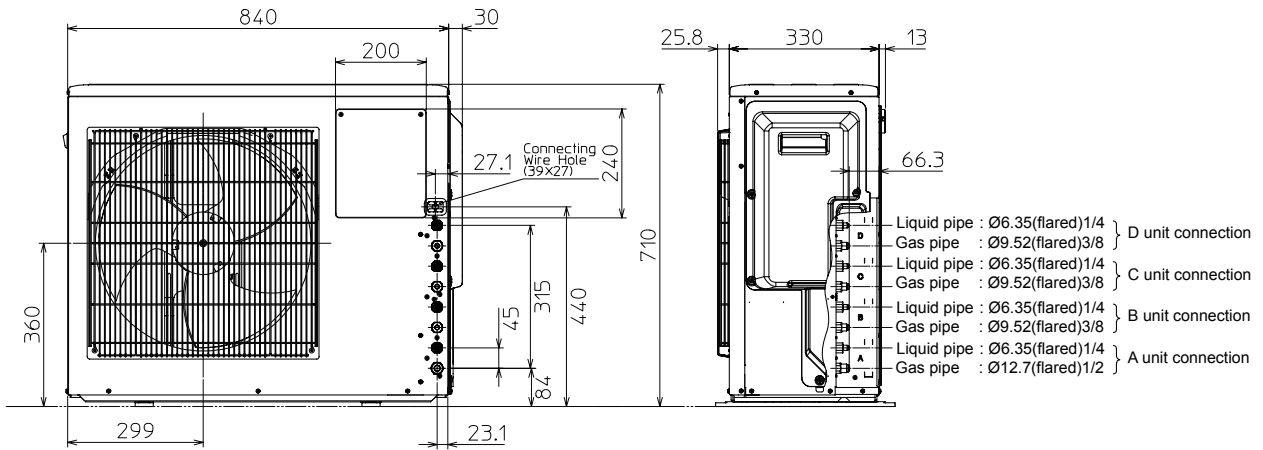
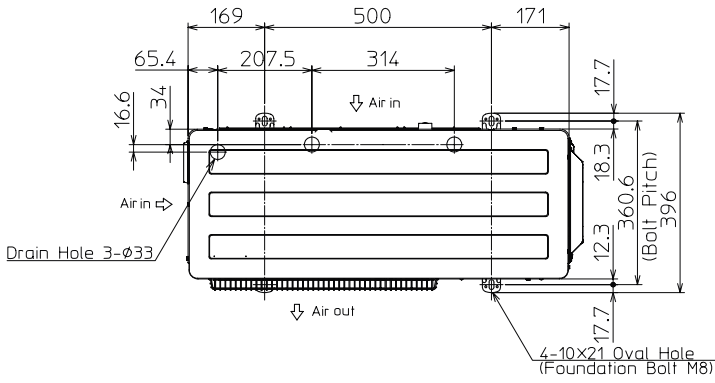

1. Installation space

Note : Leave front and both sides free of obstruction.

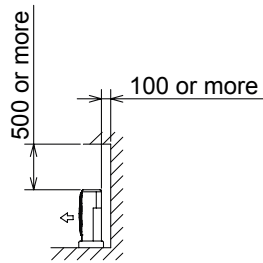

Note : Leave front and overhead free of obstruction.

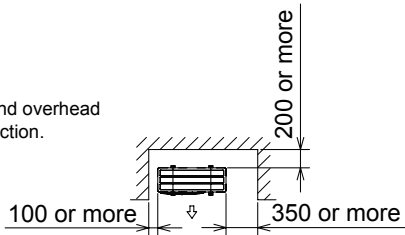

Note : Leave rear, overhead and both sides free of obstruction.

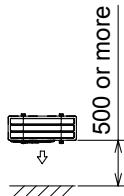

2. Service space

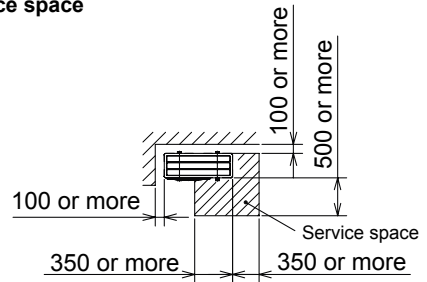

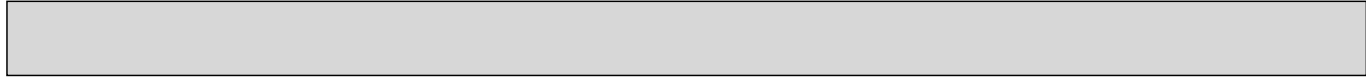

MXZ-4D83VA MXZ-5D102VA

Unit: mm

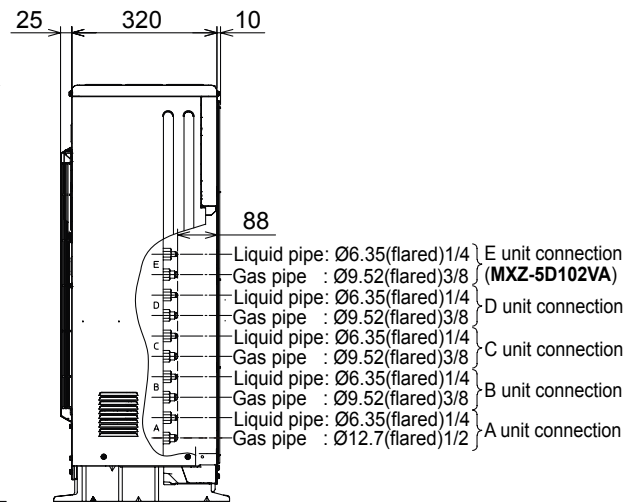
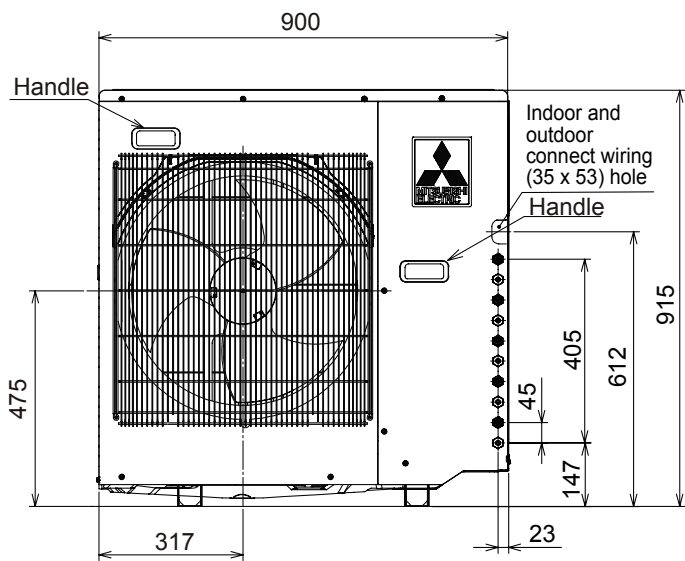
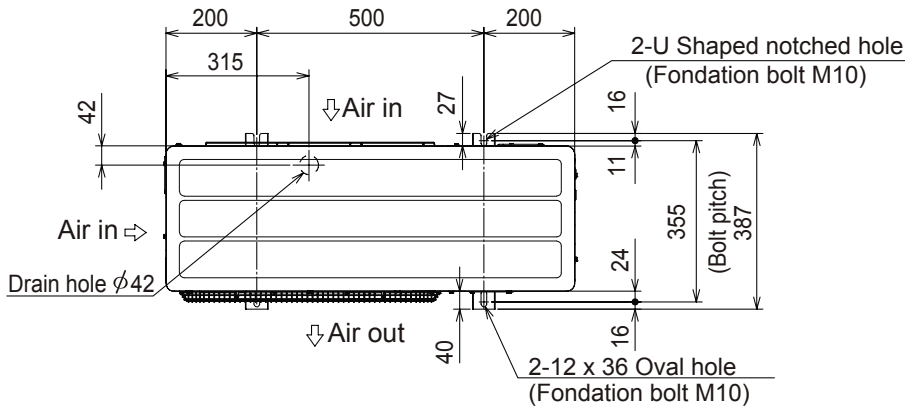

1. Installation space

Note : Leave front and both sides free of obstruction.

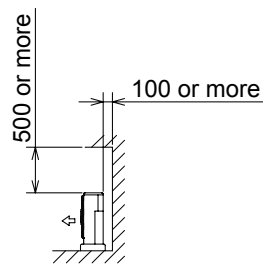

Note : Leave front and overhead free of obstruction.

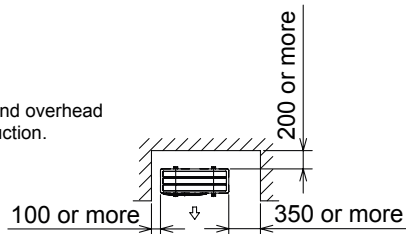

Note : Leave rear, overhead and both sides free of obstruction.

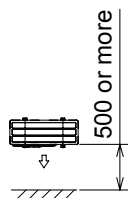

2. Service space

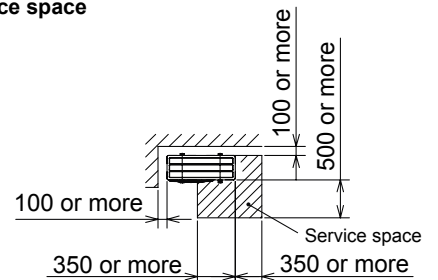

MXZ-2D33VA MXZ-2D40VA MXZ-2D53VA

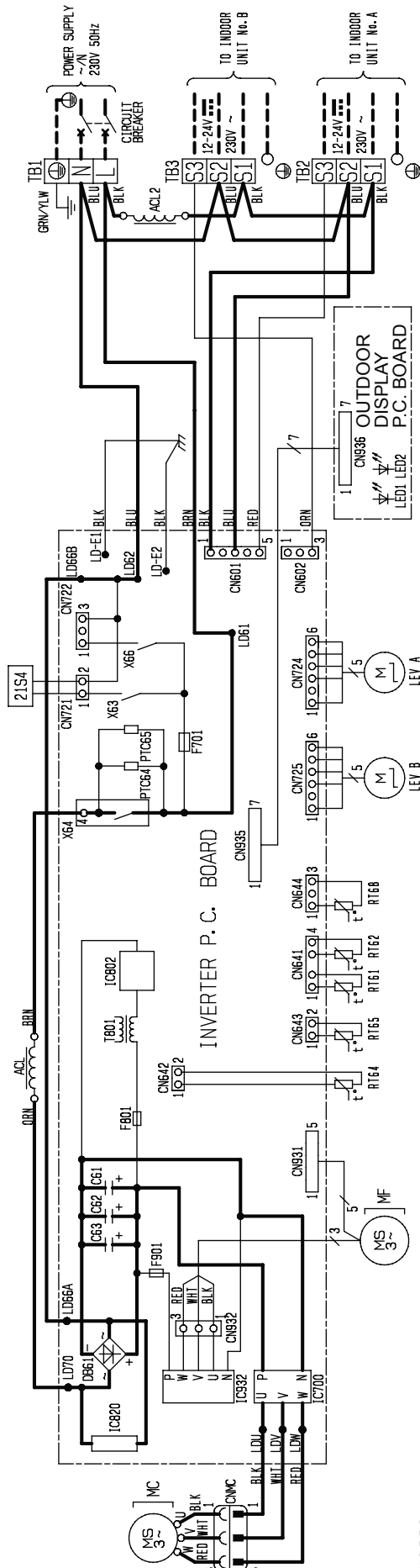

NOTES:

1. About the indoor side electric wiring refer to the indoor unit electric wiring diagram for servicing.
2. Use copper conductors only. (For field wiring).
3. Symbols below indicate.
□: Terminal block
□: Connector

SYMBOL	NAME	SYMBOL	NAME	SYMBOL	NAME
ACL,ACL2	REACTOR	LEV A, LEV B	EXPANSION VALVE COIL	RT65	AMBIENT TEMP. THERMISTOR
C61,C62,C63	SMOOTHING CAPACITOR	MC	COMPRESSOR	RT68	OUTDOOR HEAT EXCHANGER TEMP. THERMISTOR
DB61	DIODE MODULE	MF	FAN MOTOR	TB1, TB2, TB3	TERMINAL BLOCK
F701,F801,F901	FUSE (T3, 15A(250V))	PTC64, PTC65	CIRCUIT PROTECTOR	T801	SWITCHING TRANS RELAY
IC700,IC820,IC932	POWER MODULE	RT61	DEFROST THERMISTOR	X63, X64	REVERSING VALVE COIL
IC802	POWER DEVICE	RT62	DISCHARGE TEMP. THERMISTOR		
LED1, LED2	LED	RT64	FIN TEMP. THERMISTOR	21S4	

MXZ-2D53VAH

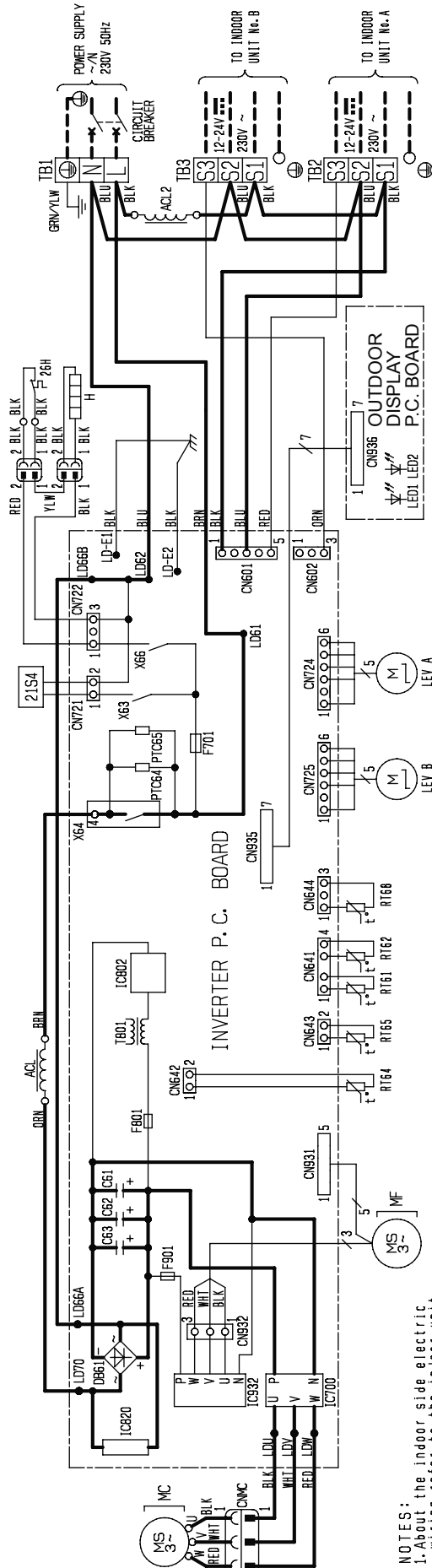

- NOTES:**
- About the indoor side electric wiring refer to the indoor unit electric wiring diagram for servicing.
 - Use copper conductors only. (For field wiring).
 - Symbols below indicate.
 - : Terminal block
 - : Connector

SYMBOL	NAME	SYMBOL	NAME	SYMBOL	NAME
ACL,ACL2	REACTOR	LEV A,LEV B	EXPANSION VALVE COIL	RT68	OUTDOOR HEAT EXCHANGER TEMP. THERMISTOR
C61,C62,C63	SMOOTHING CAPACITOR	MC	COMPRESSOR	TB1, TB2, TB3	TERMINAL BLOCK
D861	DIODE MODULE	MF	FAN MOTOR	T801	SWITCHING TRANS RELAY
F701,F801,F901	FUSE (T3, 15AL,250V)	PTC64,PTC65	CIRCUIT PROTECTOR	21S4	REVERSING VALVE COIL HEATER PROTECTOR
IC820	DEFROST HEATER	RT61	DEFROST THERMISTOR		
IC932	POWER MODULE	RT62	DISCHARGE TEMP. THERMISTOR		
IC802	POWER DEVICE	RT64	FAN TEMP. THERMISTOR		
LED1,LED2	LED	RT65	AMBIENT TEMP. THERMISTOR		

MXZ-4D83VA

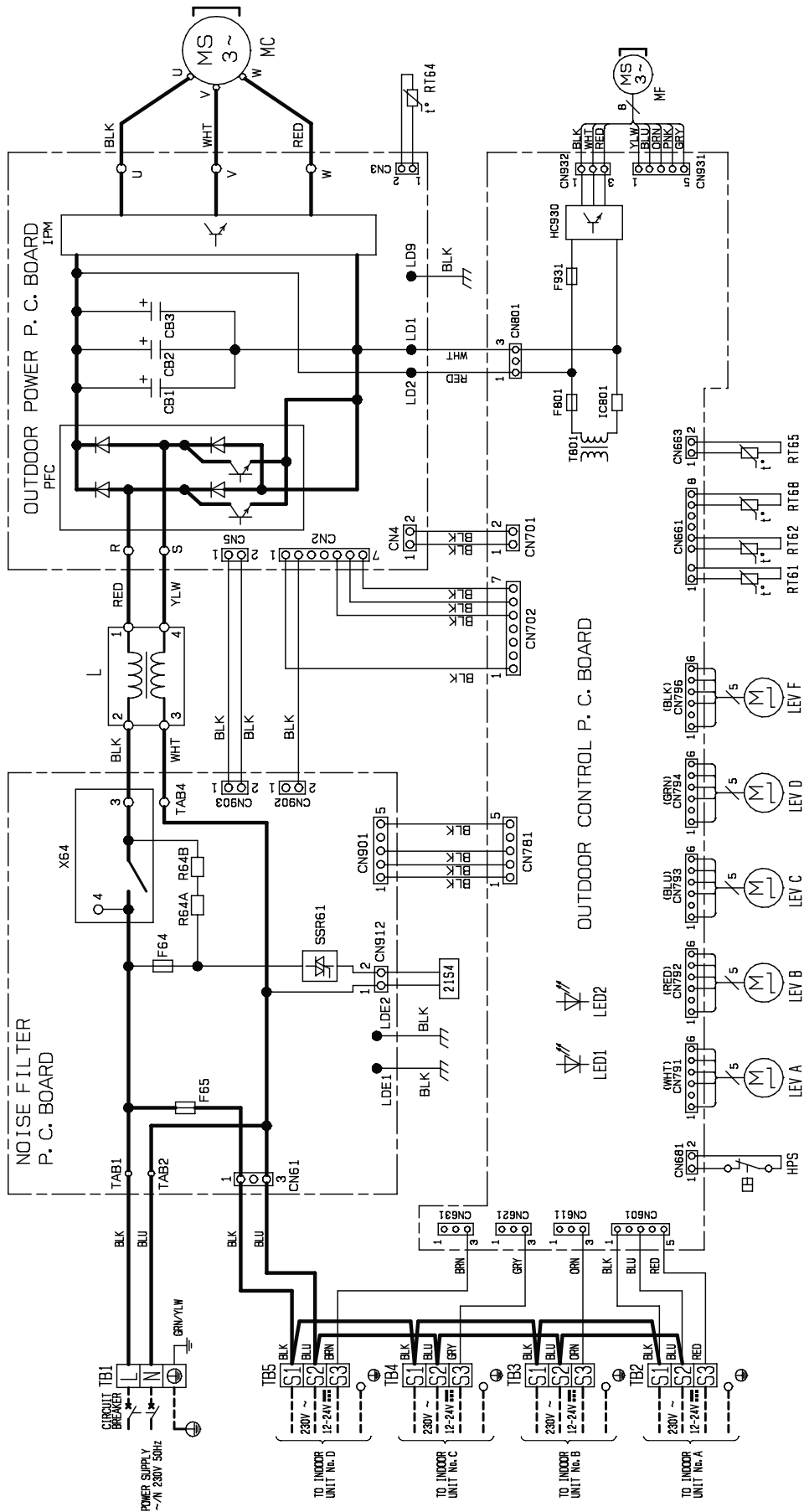

- NOTES:**
- About the indoor side electric wiring refer to the indoor unit electric wiring diagram for servicing.
 - Use copper conductors only (For field wiring).
 - Symbols below indicate.
 - □ □ □ : terminal block
 - ○ ○ ○ : connector

SYMBOL	NAME	SYMBOL	NAME	SYMBOL	NAME	SYMBOL	NAME
CB1~3	SMOOTHING CAPACITOR	HPS	HIGH PRESSURE SWITCH	RT61	DEFROST THERMISTOR	T801	DISCHARGE TEMP. THERMISTOR
F64	FUSE (12A/250V)	MC	POWER DEVICE	RT62	EXPANSION VALVE COMPRESSOR	T81~5	TERMINAL BLOCK
F65	FUSE (16.3A/250V)	MF	POWER MODULE	RT65	FAN MOTOR	X64	REVERSE VALVE SOLENOID COIL RELAY
F801	FUSE (13.15A/250V)	L	REACTOR	PFC	POWER FACTOR CONTROLLER	21S4	REVERSE VALVE SOLENOID COIL
F931	FUSE (13.15A/250V)	LED 1.2	LED	R64A, B	RESISTOR		
HC930	POWER MODULE	LEV A~D	EXPANSION VALVE	RT61	DEFROST THERMISTOR	SSR61	SOLENOID COIL RELAY

MXZ-5D102VA

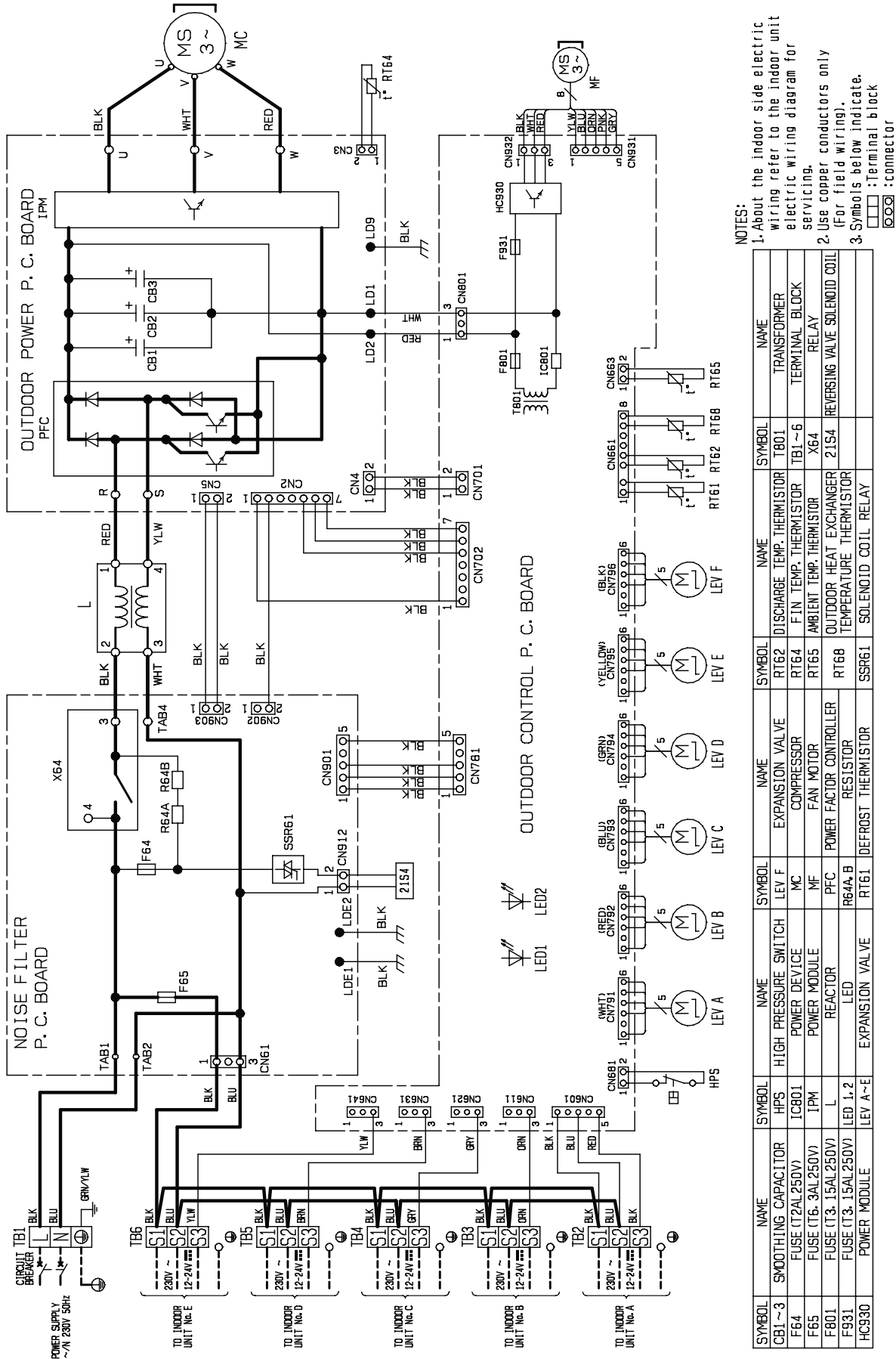

- NOTES:
- About the indoor side electric wiring refer to the indoor unit electric wiring diagram for servicing.
 - Use copper conductors only (For field wiring).
 - Symbols below indicate.
 - □ □ □ : Terminal block
 - ○ ○ ○ : connector

MXZ-2D33VA

UNIT: mm

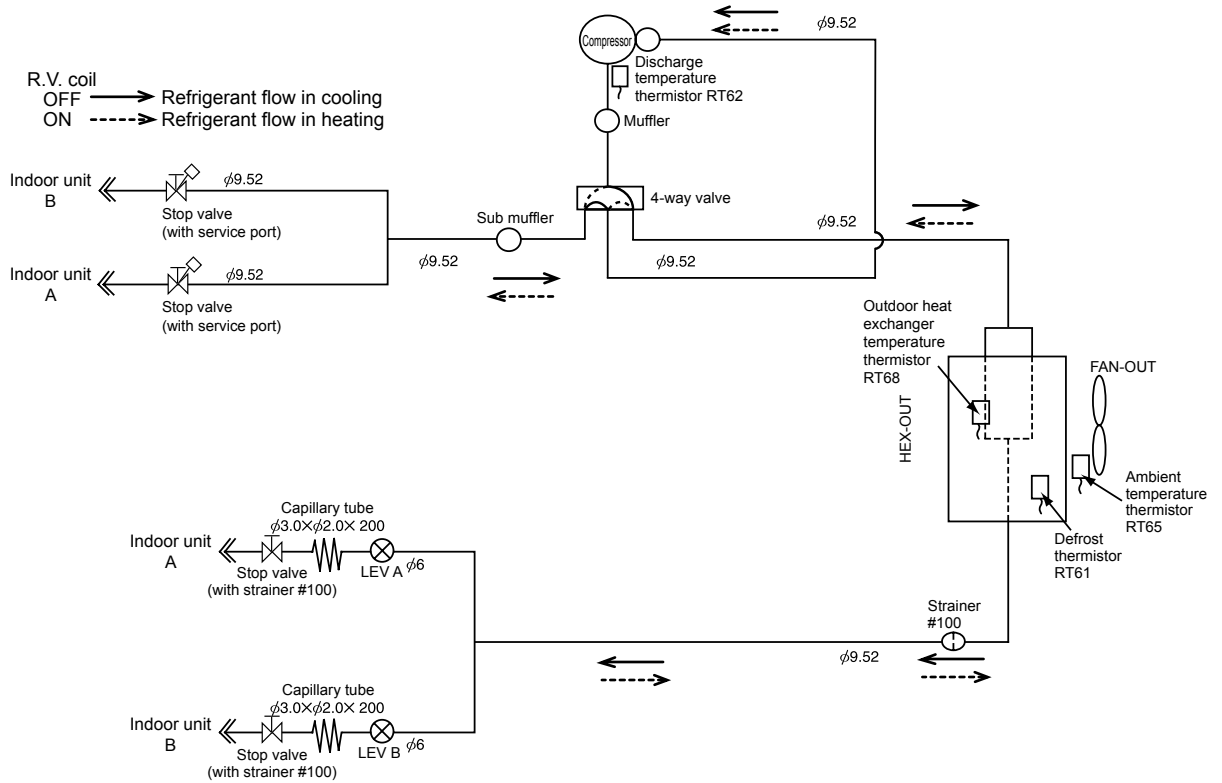

MAX REFRIGERANT PIPING LENGTH

Piping length each indoor unit (a, b)	15 m
Total piping length (a+b)	20 m
Bending point for each unit	15
Total bending point	20

*It is irrelevant which unit is higher.

ADDITIONAL REFRIGERANT CHARGE

Outdoor unit precharged (g)	Refrigerant piping length (one way, 2 unit total)	
		20m
1,150	0	

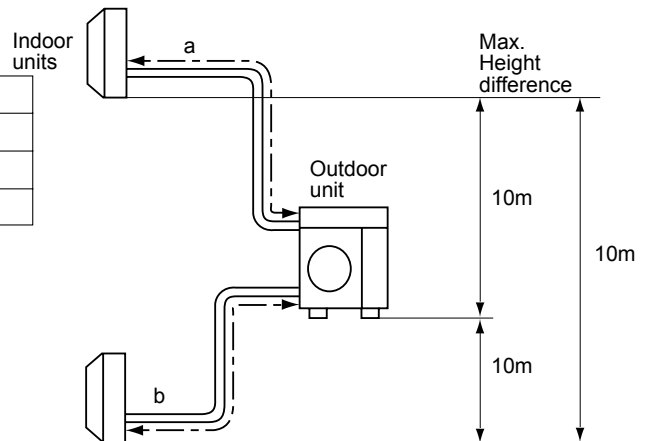

● Refrigerant pipe diameter is different according to indoor unit to be connected. When using extension pipes, refer to the tables below.

UNIT: mm (inch)

Outdoor unit union diameter		
For		
Indoor unit A	Liquid	6.35(1/4)
	Gas	9.52(3/8)
Indoor unit B	Liquid	6.35(1/4)
	Gas	9.52(3/8)

MXZ-2D40VA

UNIT: mm

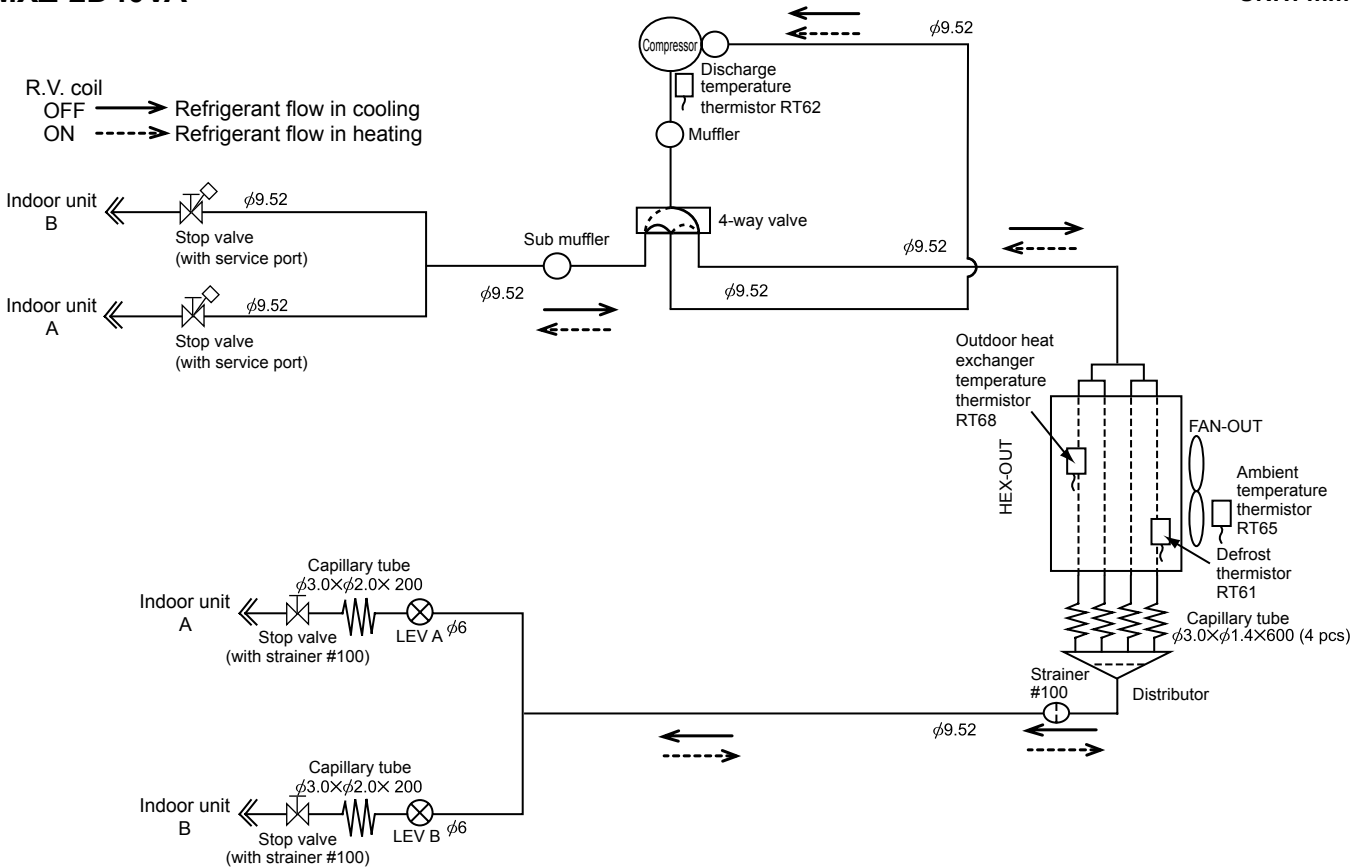

MAX REFRIGERANT PIPING LENGTH

Piping length each indoor unit (a, b)	20 m
Total piping length (a+b)	30 m
Bending point for each unit	20
Total bending point	30

*It is irrelevant which unit is higher.

ADDITIONAL REFRIGERANT CHARGE

Outdoor unit precharged (g)	Refrigerant piping length (one way, 2 unit total)	
	20m	30m
1,300	0	200

Calculation : $Xg = 20 \text{ g/m} \times (\text{Refrigerant piping length (m)} - 20)$

- Refrigerant pipe diameter is different according to indoor unit to be connected. When using extension pipes, refer to the tables below.

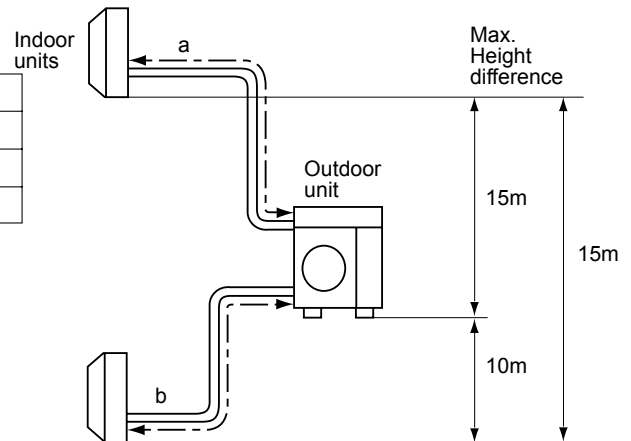

UNIT: mm (inch)

Outdoor unit union diameter		
For		
Indoor unit A	Liquid	6.35(1/4)
	Gas	9.52(3/8)
Indoor unit B	Liquid	6.35(1/4)
	Gas	9.52(3/8)

MXZ-2D53VA MXZ-2D53VAH

UNIT: mm

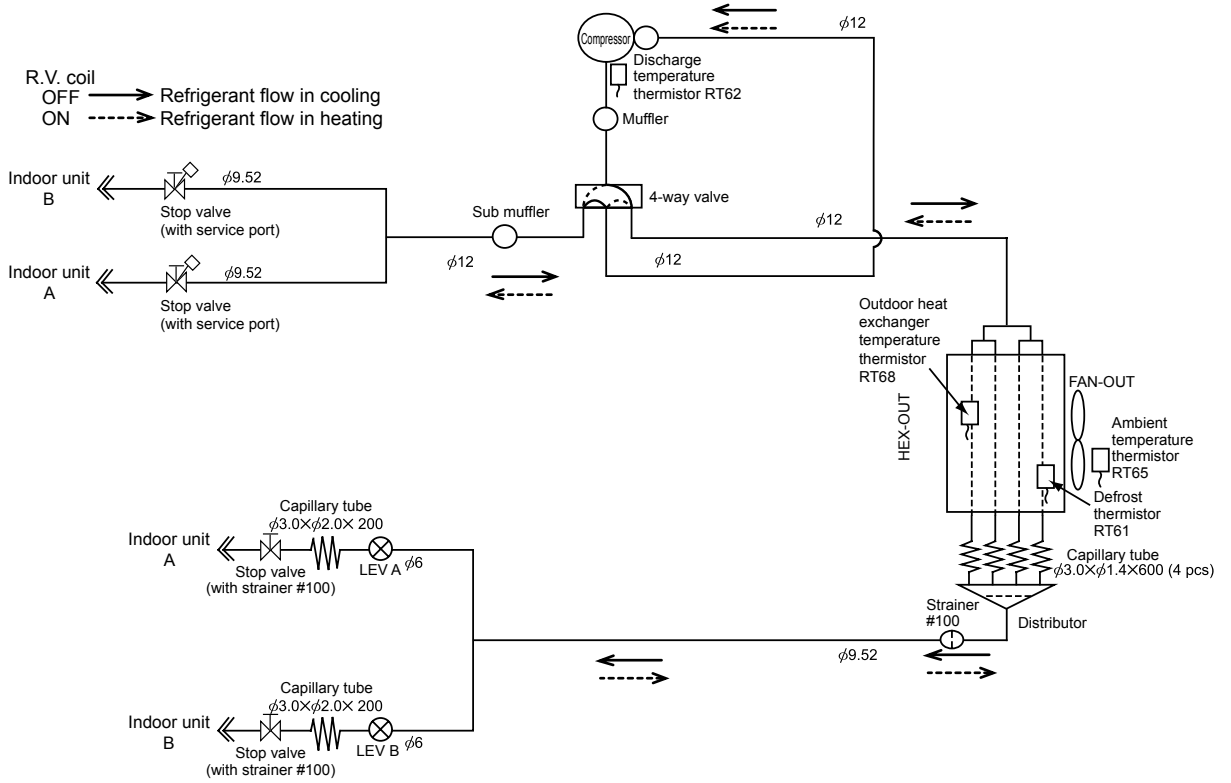

MAX REFRIGERANT PIPING LENGTH

Piping length each indoor unit (a, b)	20 m
Total piping length (a+b)	30 m
Bending point for each unit	20
Total bending point	30

*It is irrelevant which unit is higher.

ADDITIONAL REFRIGERANT CHARGE

Outdoor unit precharged (g)	Refrigerant piping length (one way, 2 unit total)	
	20m	30m
1,300	0	200

Calculation : $X_g = 20 \text{ g/m} \times (\text{Refrigerant piping length(m)} - 20)$

- Refrigerant pipe diameter is different according to indoor unit to be connected. When using extension pipes, refer to the tables below.

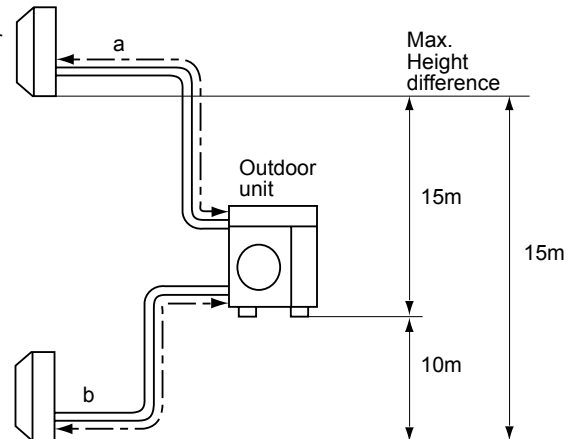

UNIT: mm (inch)

Outdoor unit union diameter		
For		
Indoor unit A	Liquid	6.35(1/4)
	Gas	9.52(3/8)
Indoor unit B	Liquid	6.35(1/4)
	Gas	9.52(3/8)

MXZ-3D54VA MXZ-3D68VA

UNIT: mm

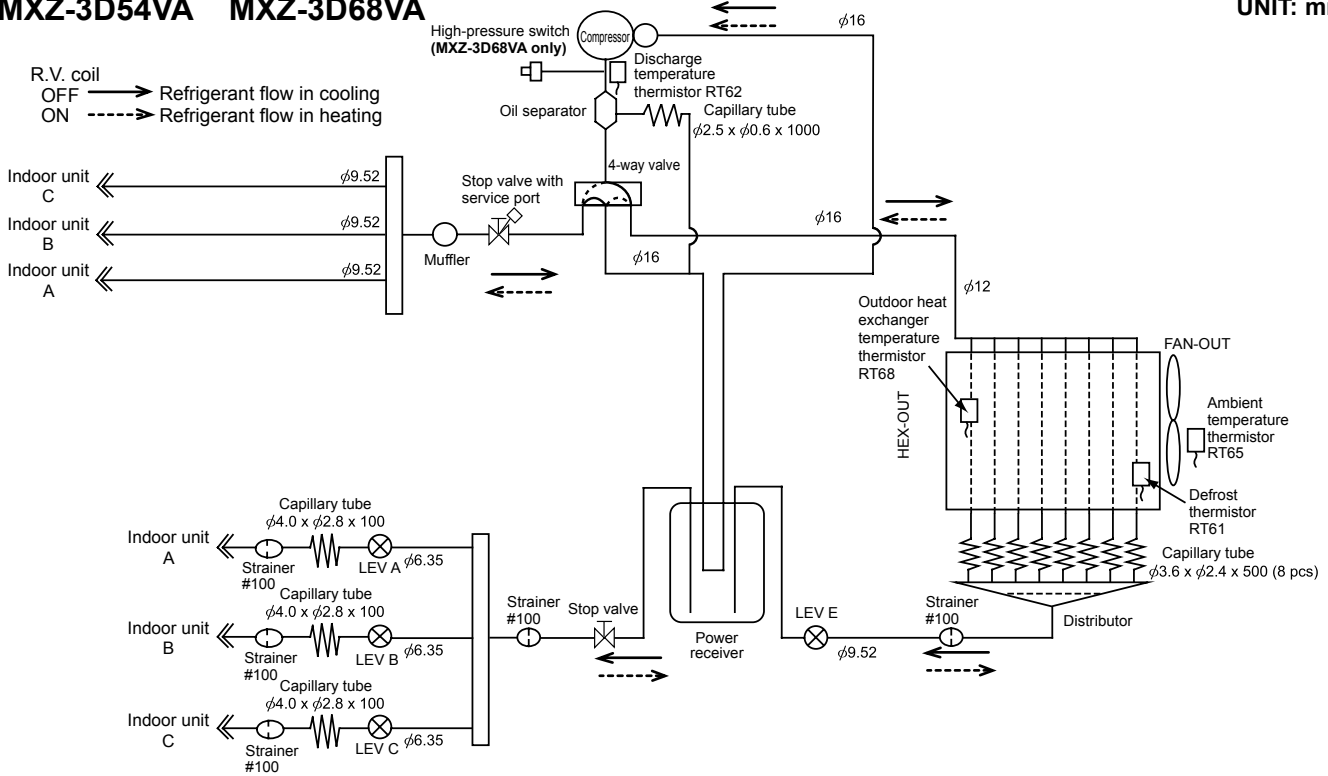

MAX REFRIGERANT PIPING LENGTH

	3D54	3D68
Piping length each indoor unit (a, b, c)	25m	25m
Total piping length (a+b+c)	50m	60m
Bending point for each unit	25	25
Total bending point	50	60

*It is irrelevant which unit is higher.

ADDITIONAL REFRIGERANT CHARGE

Outdoor unit precharged (g)	Refrigerant piping length (one way, 3 unit total)		
	40m	50m	60m
2,700	0	200	400

Calculation : $Xg = 20 \text{ g/m} \times (\text{Refrigerant piping length (m)} - 40)$

- Refrigerant pipe diameter is different according to indoor unit to be connected. When using extension pipes, refer to the tables below.
- When diameter of refrigerant pipe is different from that of outdoor unit union, use optional Different-diameter pipe. For further information on Different-diameter pipe, refer to "PARTS CATALOG".

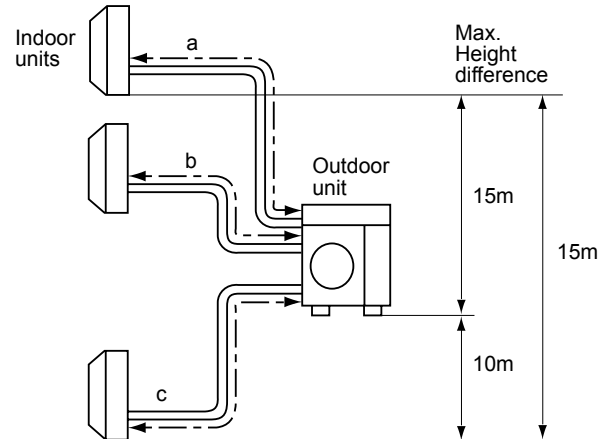

UNIT: mm (inch)

Outdoor unit union diameter		
For		
Indoor unit A	Liquid	6.35(1/4)
	Gas	9.52(3/8)
Indoor unit B	Liquid	6.35(1/4)
	Gas	9.52(3/8)
Indoor unit C	Liquid	6.35(1/4)
	Gas	9.52(3/8)

MXZ-4D72VA

UNIT: mm

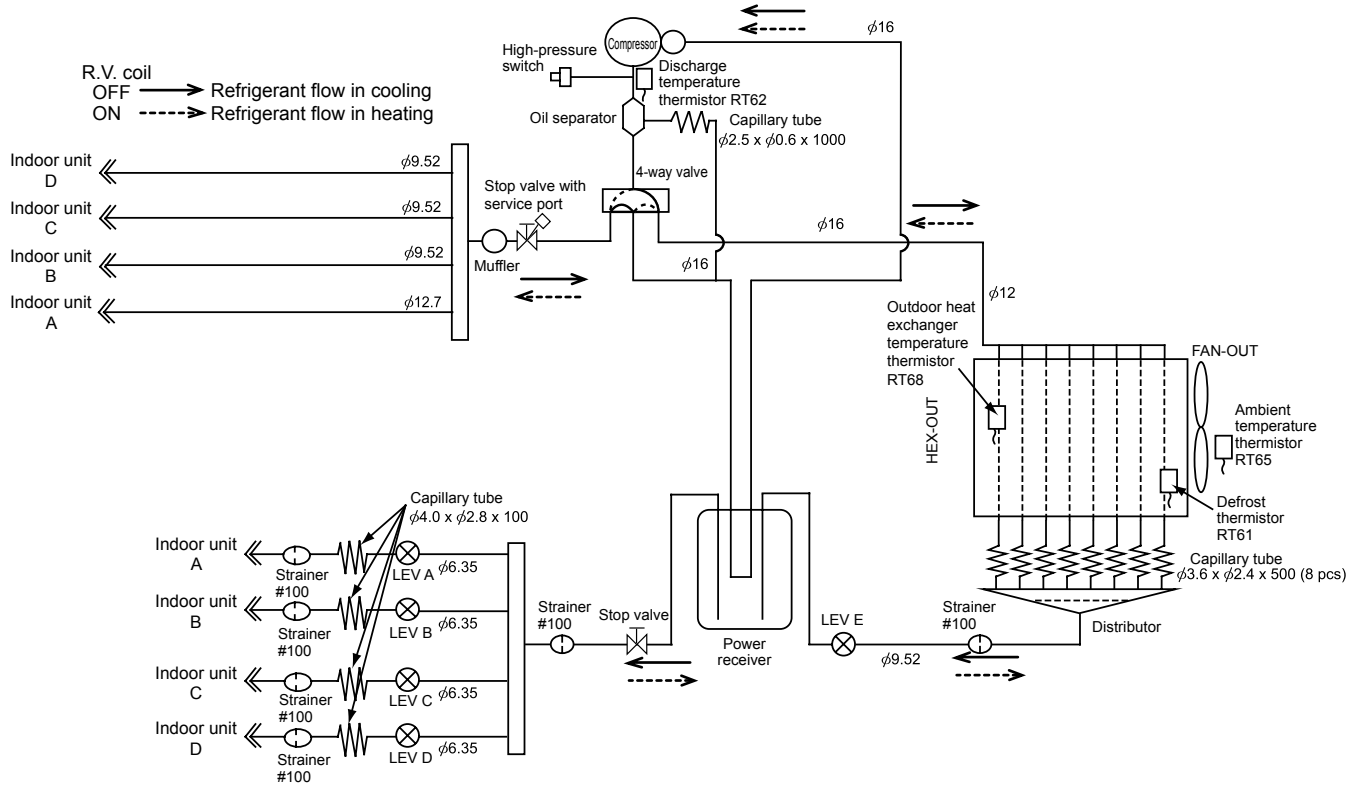

MAX REFRIGERANT PIPING LENGTH

Piping length each indoor unit (a, b, c, d)	25m
Total piping length (a+b+c+d)	60m
Bending point for each unit	25
Total bending point	60

*It is irrelevant which unit is higher.

ADDITIONAL REFRIGERANT CHARGE

Outdoor unit precharged (g)	Refrigerant piping length (one way, 4 unit total)		
	40m	50m	60m
2,700	0	200	400

Calculation : $Xg = 20 \text{ g/m} \times (\text{Refrigerant piping length (m)} - 40)$

- Refrigerant pipe diameter is different according to indoor unit to be connected. When using extension pipes, refer to the tables below.
- When diameter of refrigerant pipe is different from that of outdoor unit union, use optional Different-diameter pipe. For further information on Different-diameter pipe, refer to "PARTS CATALOG".

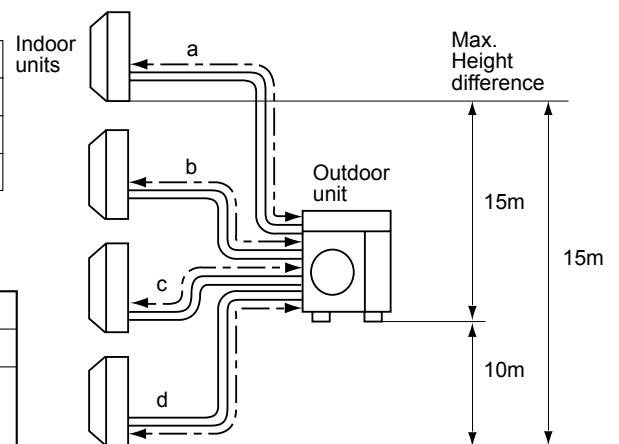

UNIT: mm (inch)

Outdoor unit union diameter		
For		
Indoor unit A	Liquid	6.35(1/4)
	Gas	12.7(1/2)
Indoor unit B	Liquid	6.35(1/4)
	Gas	9.52(3/8)
Indoor unit C	Liquid	6.35(1/4)
	Gas	9.52(3/8)
Indoor unit D	Liquid	6.35(1/4)
	Gas	9.52(3/8)

MXZ-4D83VA

UNIT: mm

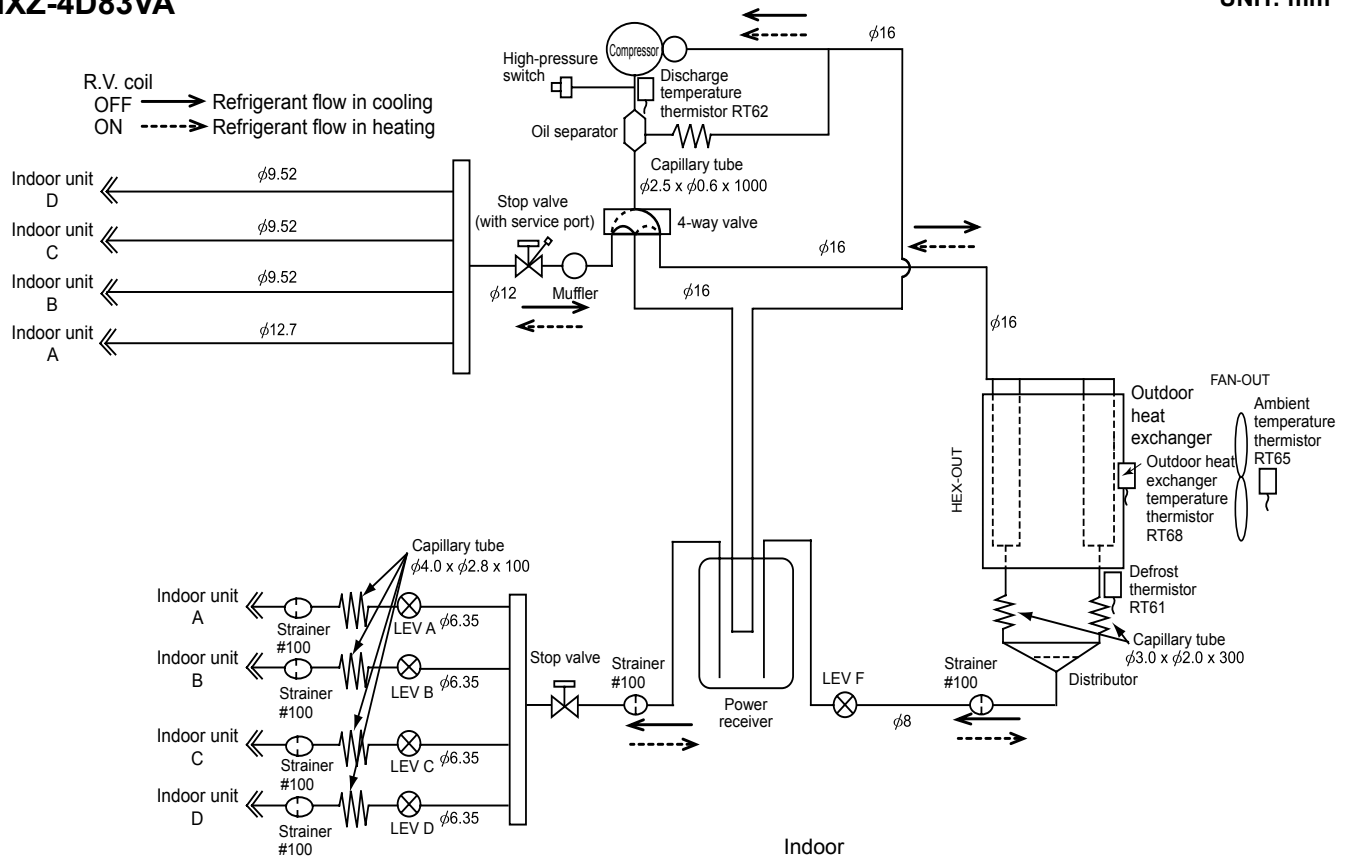

MAX REFRIGERANT PIPING LENGTH

Piping length each indoor unit (a, b, c, d)	25m
Total piping length (a+b+c+d)	70m
Bending point for each unit	25
Total bending point	70

*It is irrelevant which unit is higher.

ADDITIONAL REFRIGERANT CHARGE

Outdoor unit precharged (g)	Refrigerant piping length (one way, 4 unit total)			
	40m	50m	60m	70m
3,500	0	200	400	600

Calculation : $Xg = 20 \text{ g/m} \times (\text{Refrigerant piping length (m)} - 40)$

- Refrigerant pipe diameter is different according to indoor unit to be connected. When using extension pipes, refer to the tables below.
- When diameter of refrigerant pipe is different from that of outdoor unit union, use optional Different-diameter pipe. For further information on Different-diameter pipe, refer to "PARTS CATALOG".

UNIT: mm (inch)

Outdoor unit union diameter		
For		
Indoor unit A	Liquid	6.35(1/4)
	Gas	12.7(1/2)
Indoor unit B	Liquid	6.35(1/4)
	Gas	9.52(3/8)
Indoor unit C	Liquid	6.35(1/4)
	Gas	9.52(3/8)
Indoor unit D	Liquid	6.35(1/4)
	Gas	9.52(3/8)

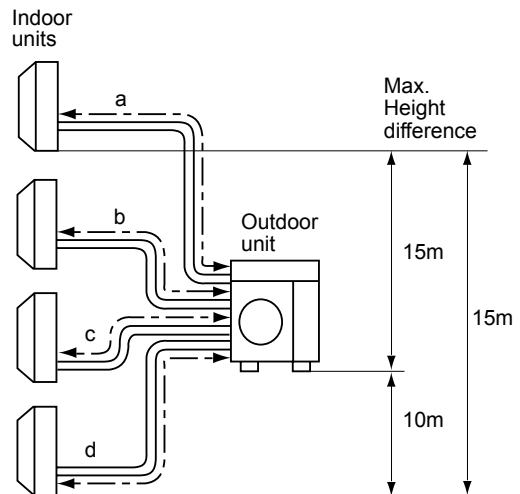

MXZ-5D102VA

UNIT: mm

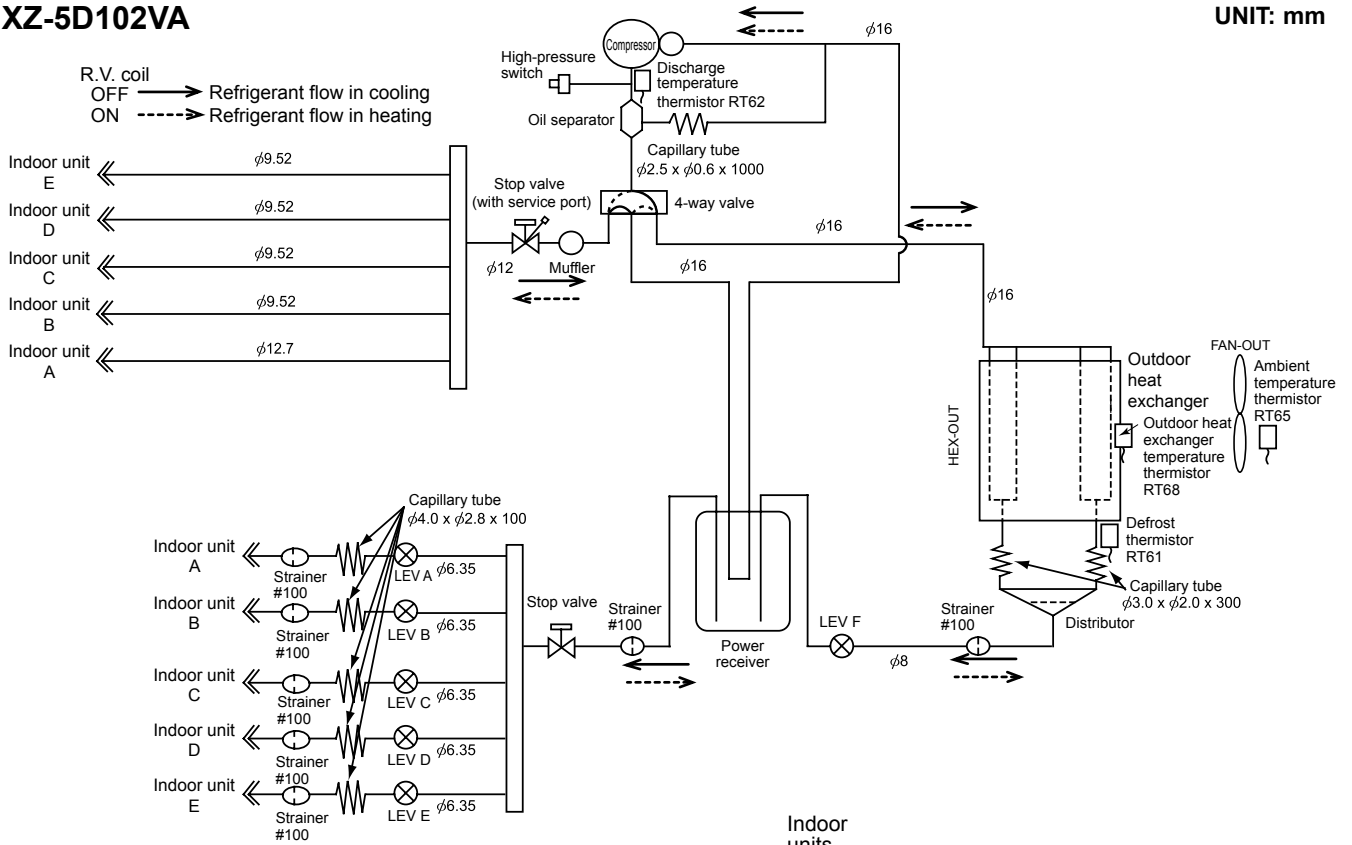

MAX REFRIGERANT PIPING LENGTH

Piping length each indoor unit (a, b, c, d, e)	25m
Total piping length (a+b+c+d+e)	80m
Bending point for each unit	25
Total bending point	80

*It is irrelevant which unit is higher.

ADDITIONAL REFRIGERANT CHARGE

Outdoor unit precharged (g)	Refrigerant piping length (one way, 5 unit total)				
	40m	50m	60m	70m	80m
4,000	0	200	400	600	800

Calculation : $X_g = 20 \text{ g/m} \times (\text{Refrigerant piping length (m)} - 40)$

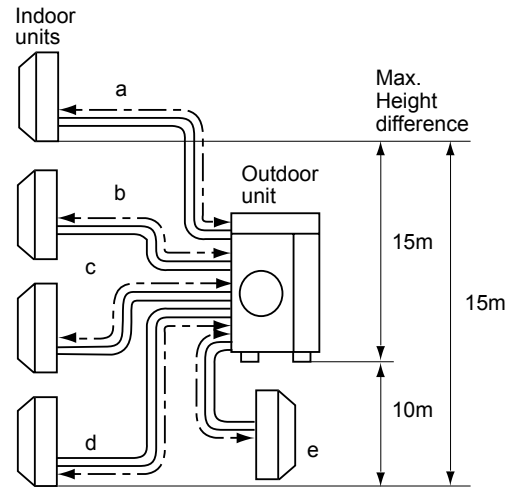

- Refrigerant pipe diameter is different according to indoor unit to be connected. When using extension pipes, refer to the tables below.
- When diameter of refrigerant pipe is different from that of outdoor unit union, use optional Different-diameter pipe. For further information on Different-diameter pipe, refer to "PARTS CATALOG".

UNIT: mm (inch)

Outdoor unit union diameter		
For		
Indoor unit A	Liquid	6.35(1/4)
	Gas	12.7(1/2)
Indoor unit B	Liquid	6.35(1/4)
	Gas	9.52(3/8)
Indoor unit C	Liquid	6.35(1/4)
	Gas	9.52(3/8)
Indoor unit D	Liquid	6.35(1/4)
	Gas	9.52(3/8)
Indoor unit E	Liquid	6.35(1/4)
	Gas	9.52(3/8)

MXZ-2D33VA MXZ-2D40VA MXZ-2D53VA MXZ-2D53VAH
MXZ-3D54VA MXZ-3D68VA MXZ-4D72VA MXZ-4D83VA MXZ-5D102VA

The standard specifications apply only to the operation of the air conditioner under normal conditions.

Since operating conditions vary according to the areas where these units are installed, the following information has been provided to clarify the operating characteristics of the air conditioner under the conditions indicated by the performance curve.

(1) GUARANTEED VOLTAGE

198 - 264 V 50 Hz

(2) AIR FLOW

Air flow should be set at MAX.

(3) MAIN READINGS

(1) Indoor intake air wet-bulb temperature :	°CWB	} Cooling
(2) Indoor outlet air wet-bulb temperature :	°CWB	
(3) Outdoor intake air dry-bulb temperature :	°CDB	
(4) Total input:	W	} Heating
(5) Indoor intake air dry-bulb temperature :	°CDB	
(6) Outdoor intake air wet-bulb temperature :	°CWB	
(7) Total input :	W	

Indoor air wet and dry bulb temperature difference on the left side of the following chart shows the difference between the indoor intake air wet and dry bulb temperature and the indoor outlet air wet and dry bulb temperature for your reference at service.

How to measure the indoor air wet and dry bulb temperature difference

1. Attach at least 2 sets of wet and dry bulb thermometers to the indoor air intake as shown in the figure, and at least 2 sets of wet and dry bulb thermometers to the indoor air outlet. The thermometers must be attached to the position where air speed is high.
2. Attach at least 2 sets of wet and dry bulb thermometers to the outdoor air intake. Cover the thermometers to prevent direct rays of the sun.
3. Check that the air filter is cleaned.
4. Open windows and doors of room.
5. Press the EMERGENCY OPERATION switch once (twice) to start the EMERGENCY COOL (HEAT) MODE.
6. When system stabilizes after more than 15 minutes, measure temperature and take an average temperature.
7. 10 minutes later, measure temperature again and check that the temperature does not change.

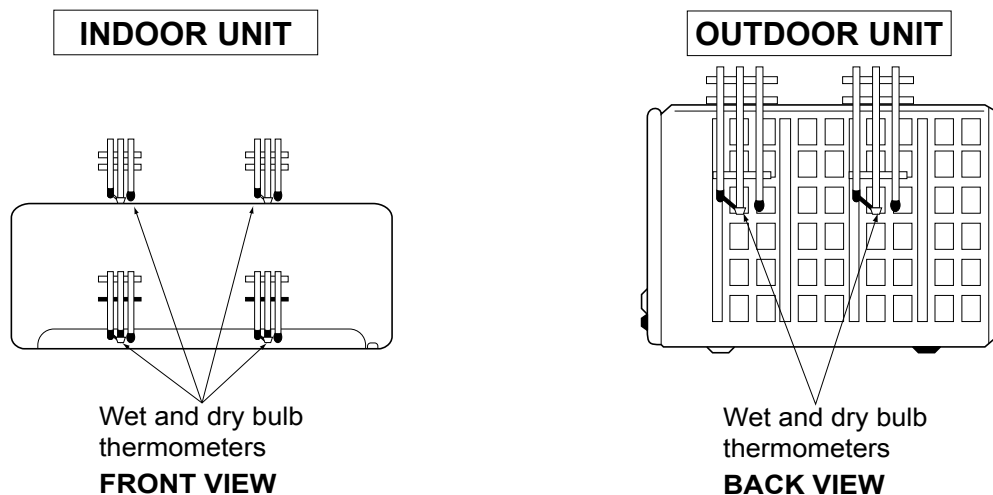

8-1. CAPACITY AND THE INPUT CURVES

MXZ-2D33VA MXZ-2D40VA MXZ-2D53VA MXZ-2D53VAH

5.8	4.1	7.4	5.2	6.0	8.8	10.9	11.2
5.4	3.8	6.8	4.8	5.5	8.0	10.0	10.2
4.9	3.5	6.2	4.4	5.0	7.3	9.1	9.3
4.5	3.2	5.7	4.0	4.6	6.6	8.2	8.4
4.0	2.9	5.1	3.6	4.1	6.0	7.3	7.5
3.6	2.6	4.5	3.2	3.7	5.3	6.5	6.7
15 class	18 class	20 class	22 class	25 class	35 class (MXZ-2D40/53)	42 class (MXZ-2D53)	50 class (MXZ-2D53)

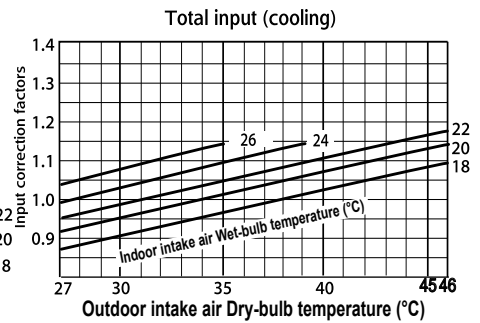
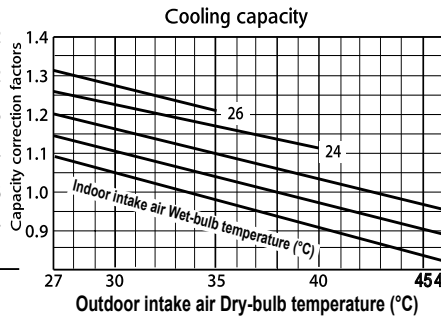

17.2	19.0	20.9	19.0	21.0	21.9	26.5	26.6
15.8	17.6	19.1	17.6	19.2	20.2	24.5	24.5
14.4	16.1	17.5	16.1	17.6	18.3	22.2	22.3
13.1	14.5	15.9	14.5	16.0	16.6	20.2	20.2
11.7	13.0	14.2	13.0	14.2	14.8	18.0	18.0
10.3	11.6	12.6	11.6	12.6	13.2	16.0	16.0
9.0	10.0	11.0	10.0	11.1	11.5	13.8	13.8
7.7	8.6	9.3	8.6	9.4	9.8	11.8	11.9
15 class	18 class	20 class	22 class	25 class	35 class (MXZ-2D40/53)	42 class (MXZ-2D53)	50 class (MXZ-2D53)

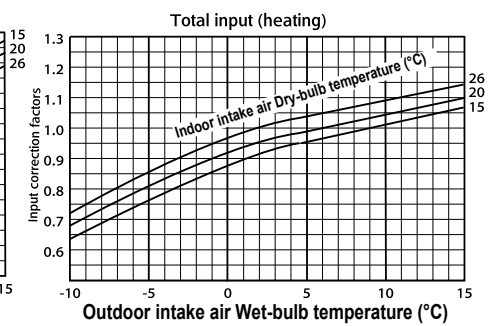
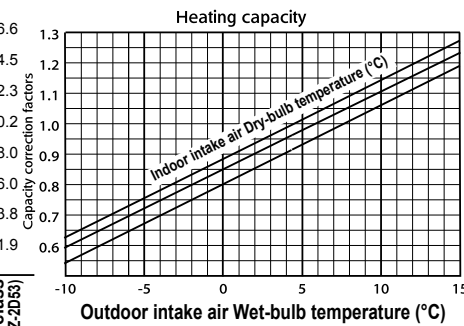

MXZ-3D54VA MXZ-3D68VA MXZ-4D72VA

6.3	4.1	8.0	8.5	9.3	10.6	9.5	13.1	13.7
5.8	3.8	7.3	7.8	8.5	9.7	8.7	11.9	12.4
5.3	3.5	6.7	7.1	7.8	8.8	8.0	10.8	11.3
4.8	3.2	6.0	6.4	7.0	7.9	7.2	9.7	10.1
4.3	2.9	5.4	5.8	6.3	7.1	6.5	8.7	9.0
3.9	2.6	4.8	5.1	5.6	6.3	5.7	7.7	8.0
15 class	18 class	20 class	22 class	25 class	35 class	42 class	50 class	60 class

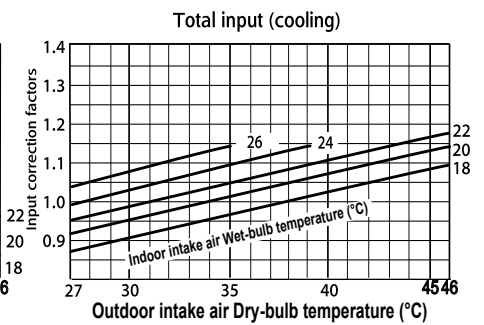
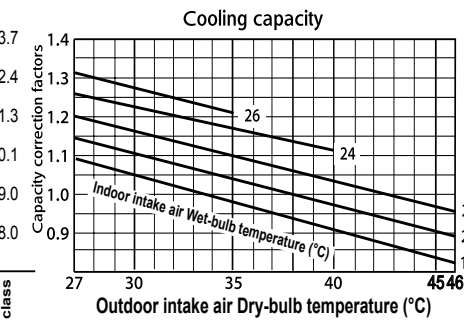

17.1	19.0	19.7	25.4	24.0	25.9	27.0	31.4	31.9
15.8	17.6	18.2	23.4	22.2	23.9	24.9	29.0	29.4
14.5	16.1	16.7	21.5	20.3	21.9	22.8	26.6	27.0
13.2	14.5	15.2	19.5	18.5	19.9	20.7	24.1	24.5
11.8	13.0	13.6	17.6	16.6	17.9	18.7	21.7	22.1
10.5	11.6	12.1	15.6	14.8	15.9	16.6	19.3	19.6
9.2	10.0	10.6	13.7	12.9	13.9	14.5	16.9	17.2
7.9	8.6	9.1	11.7	11.1	12.0	12.4	14.5	14.7
15 class	18 class	20 class	22 class	25 class	35 class	42 class	50 class	60 class

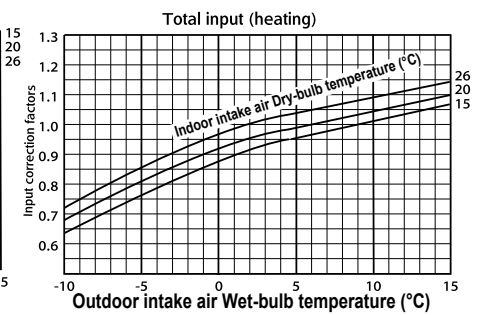
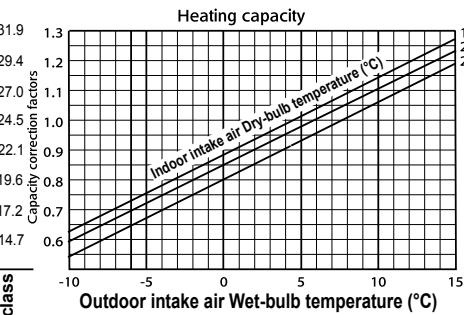

MXZ-4D83VA MXZ-5D102VA

Indoor air Wet-bulb temperature difference (°C)	6.3	4.1	8.0	8.5	9.3	10.6	9.5	13.1	13.7	17.0
	5.8	3.8	7.3	7.8	8.5	9.7	8.7	11.9	12.4	15.4
	5.3	3.5	6.7	7.1	7.8	8.8	8.0	10.8	11.3	13.9
	4.8	3.2	6.0	6.4	7.0	7.9	7.2	9.7	10.1	12.5
	4.3	2.9	5.4	5.8	6.3	7.1	6.5	8.7	9.0	11.1
	3.9	2.6	4.8	5.1	5.6	6.3	5.7	7.7	8.0	9.7
	15 class	18 class	20 class	22 class	25 class	35 class	42 class	50 class	60 class	71 class

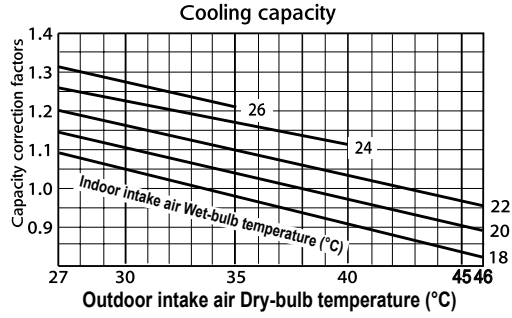

Indoor air Wet-bulb temperature difference (°C)	6.3	4.1	8.0	8.5	9.3	10.6	9.5	13.1	13.7	17.0
	5.8	3.8	7.3	7.8	8.5	9.7	8.7	11.9	12.4	15.4
	5.3	3.5	6.7	7.1	7.8	8.8	8.0	10.8	11.3	13.9
	4.8	3.2	6.0	6.4	7.0	7.9	7.2	9.7	10.1	12.5
	4.3	2.9	5.4	5.8	6.3	7.1	6.5	8.7	9.0	11.1
	3.9	2.6	4.8	5.1	5.6	6.3	5.7	7.7	8.0	9.7
	15 class	18 class	20 class	22 class	25 class	35 class	42 class	50 class	60 class	71 class

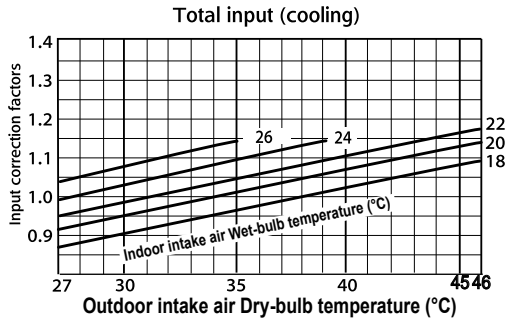

Indoor air Dry-bulb temperature difference (°C)	17.1	19.0	19.7	25.4	24.0	25.9	27.0	31.4	31.9	35.1
	15.8	17.6	18.2	23.4	22.2	23.9	24.9	29.0	29.4	32.4
	14.5	16.1	16.7	21.5	20.3	21.9	22.8	26.6	27.0	29.7
	13.2	14.5	15.2	19.5	18.5	19.9	20.7	24.1	24.5	27.0
	11.8	13.0	13.6	17.6	16.6	17.9	18.7	21.7	22.1	24.3
	10.5	11.6	12.1	15.6	14.8	15.9	16.6	19.3	19.6	21.6
	9.2	10.0	10.6	13.7	12.9	13.9	14.5	16.9	17.2	18.9
	7.9	8.6	9.1	11.7	11.1	12.0	12.4	14.5	14.7	16.2
	15 class	18 class	20 class	22 class	25 class	35 class	42 class	50 class	60 class	71 class

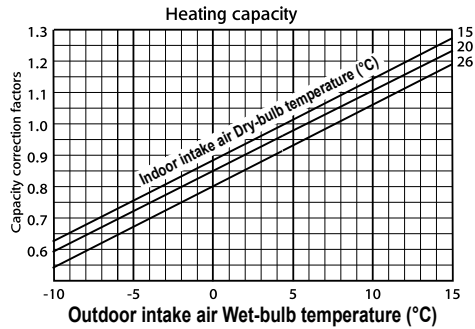

Indoor air Dry-bulb temperature difference (°C)	17.1	19.0	19.7	25.4	24.0	25.9	27.0	31.4	31.9	35.1
	15.8	17.6	18.2	23.4	22.2	23.9	24.9	29.0	29.4	32.4
	14.5	16.1	16.7	21.5	20.3	21.9	22.8	26.6	27.0	29.7
	13.2	14.5	15.2	19.5	18.5	19.9	20.7	24.1	24.5	27.0
	11.8	13.0	13.6	17.6	16.6	17.9	18.7	21.7	22.1	24.3
	10.5	11.6	12.1	15.6	14.8	15.9	16.6	19.3	19.6	21.6
	9.2	10.0	10.6	13.7	12.9	13.9	14.5	16.9	17.2	18.9
	7.9	8.6	9.1	11.7	11.1	12.0	12.4	14.5	14.7	16.2
	15 class	18 class	20 class	22 class	25 class	35 class	42 class	50 class	60 class	71 class

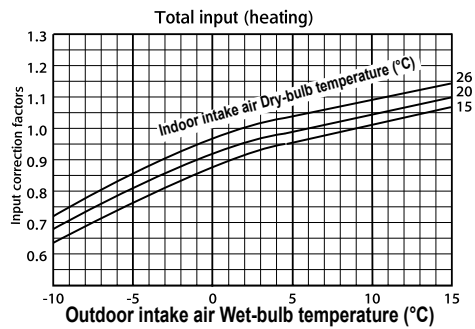

8-2. CAPACITY AND INPUT CORRECTION BY INVERTER OUTPUT FREQUENCY (single operation) MXZ-2D33VA

15-class unit

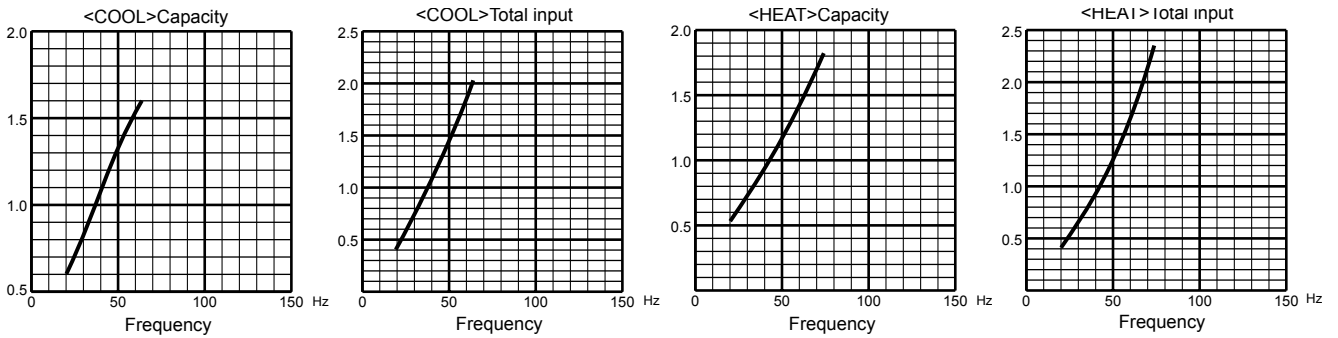

18-class unit

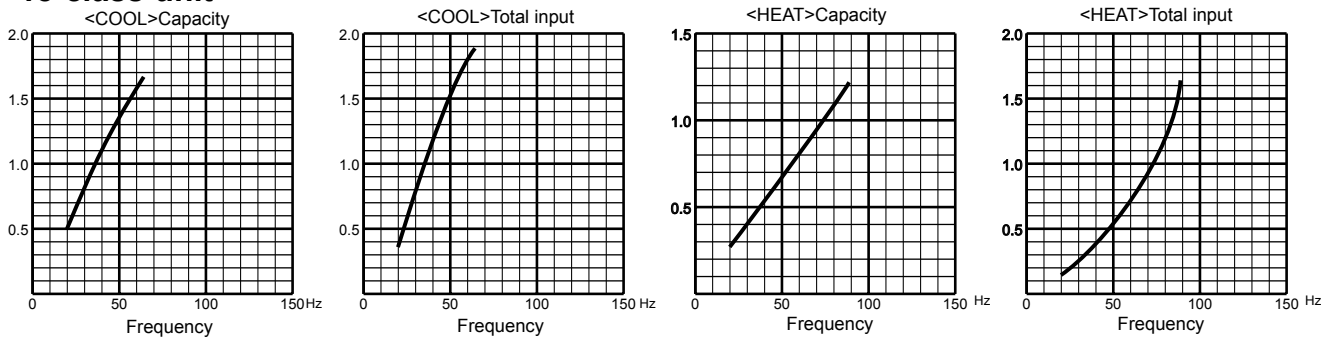

20-class unit

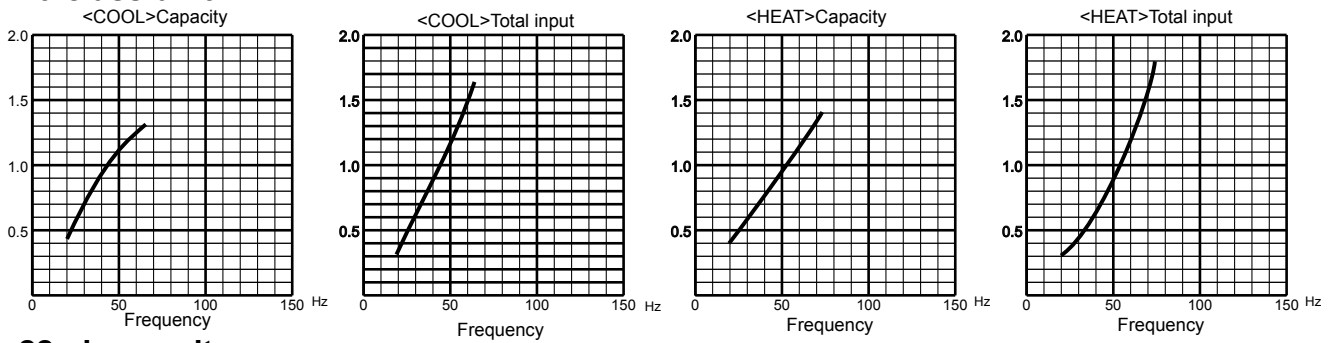

22-class unit

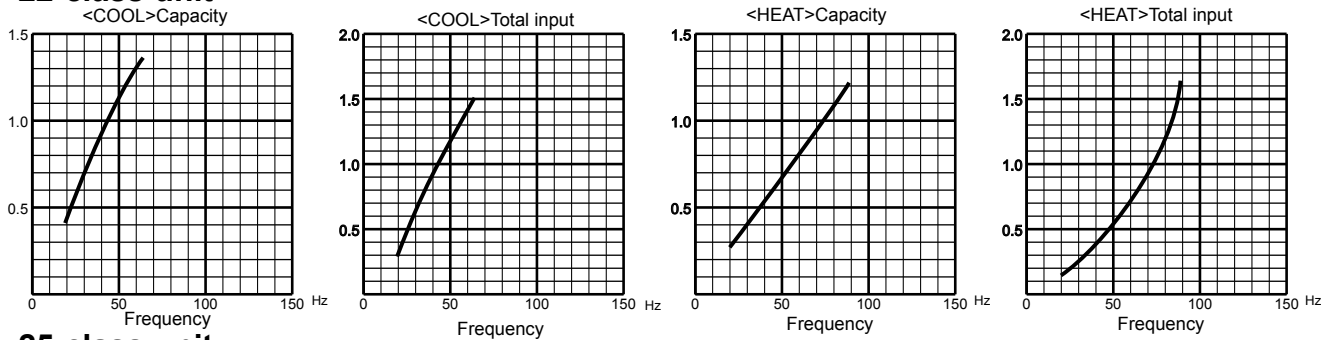

25-class unit

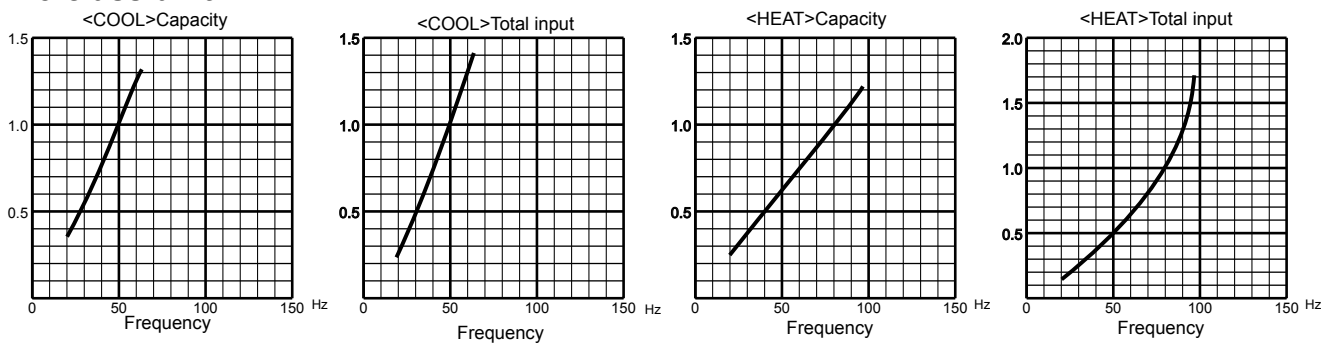

MXZ-2D40VA
15-class unit

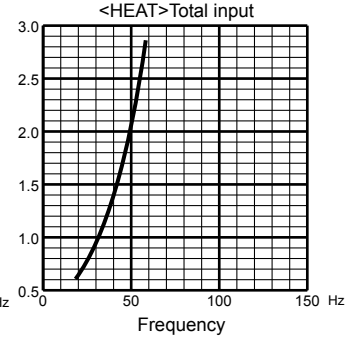
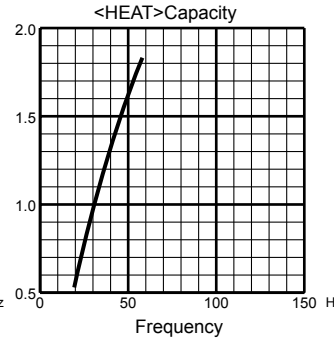
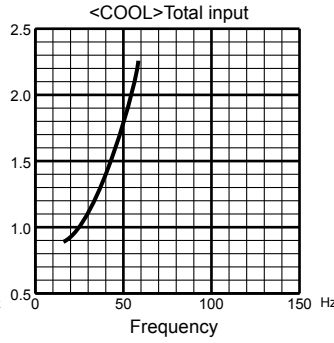
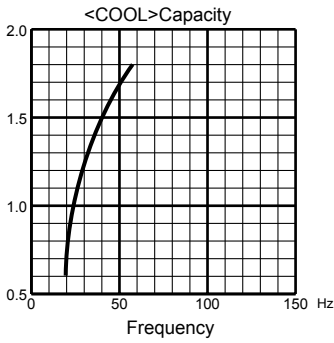

18-class unit

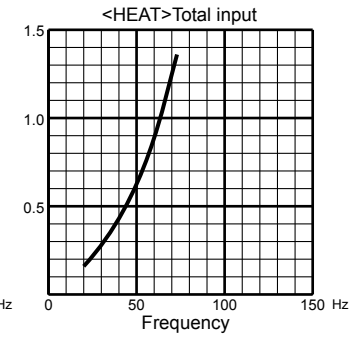
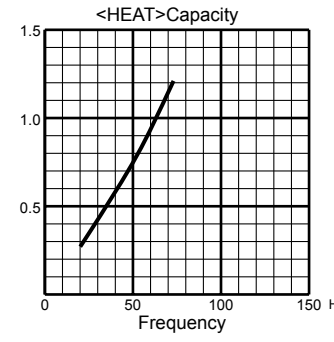
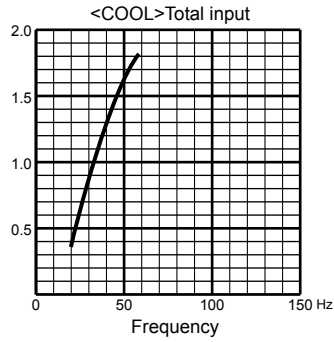
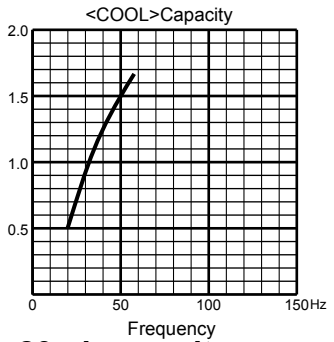

20-class unit

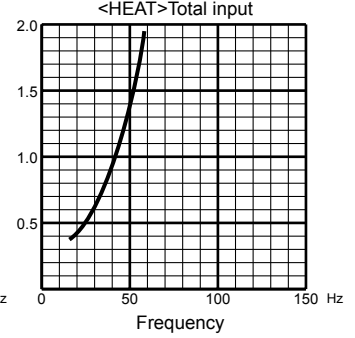
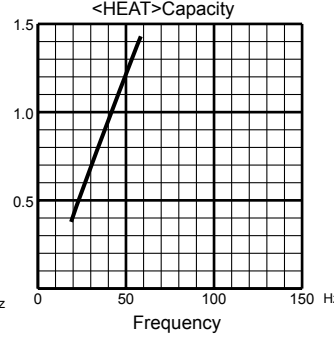
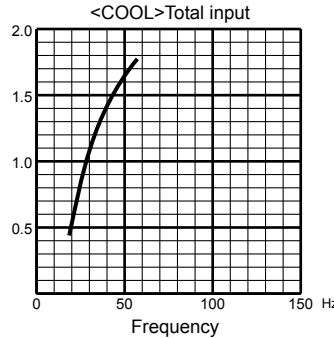
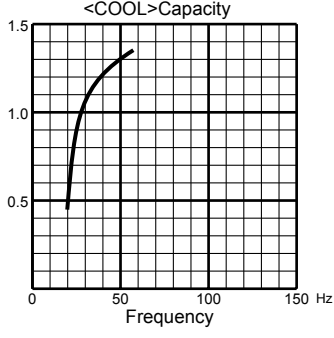

22-class unit

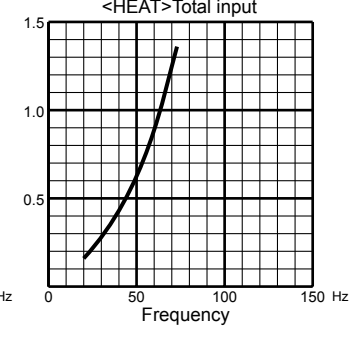
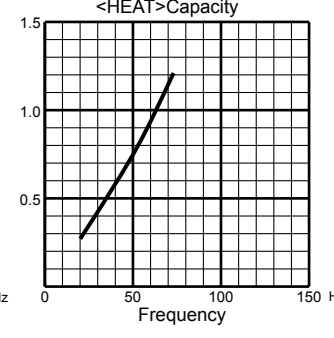
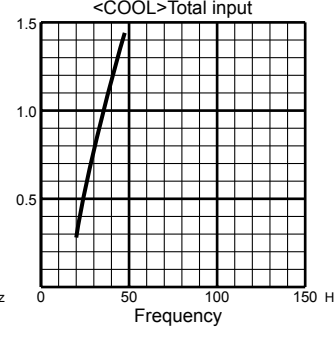
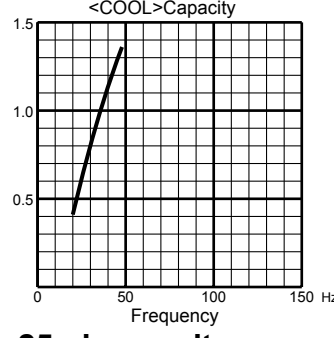

25-class unit

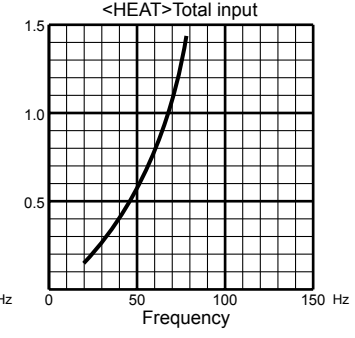
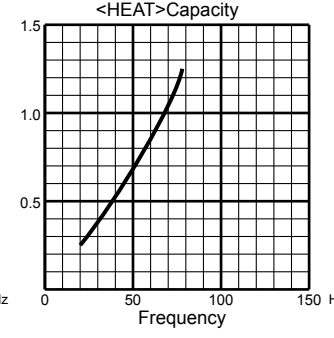
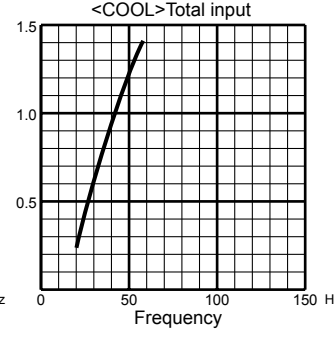
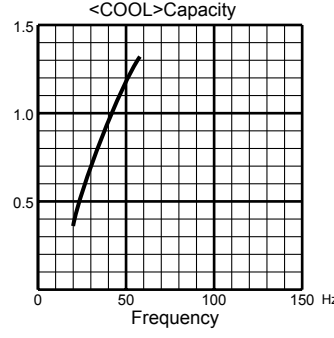

MXZ-2D40VA

35-class unit

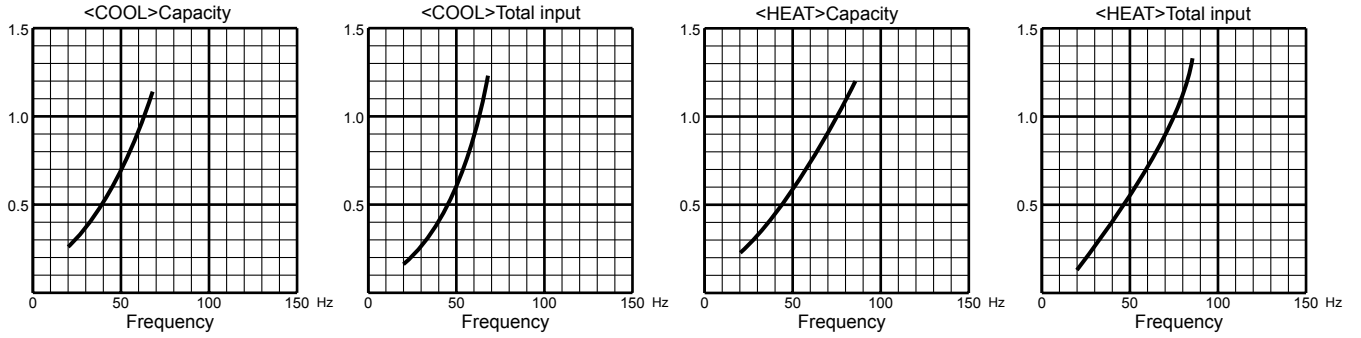

MXZ-2D53VA MXZ-2D53VAH

15-class unit

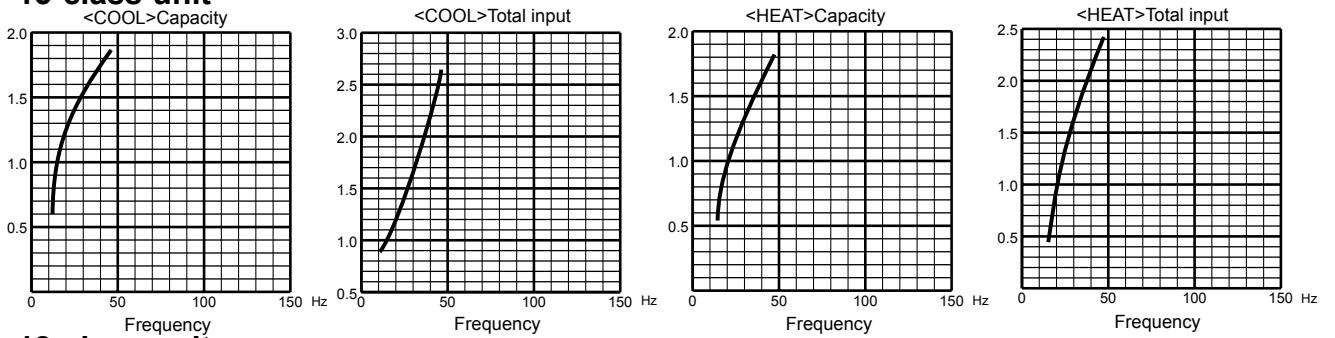

18-class unit

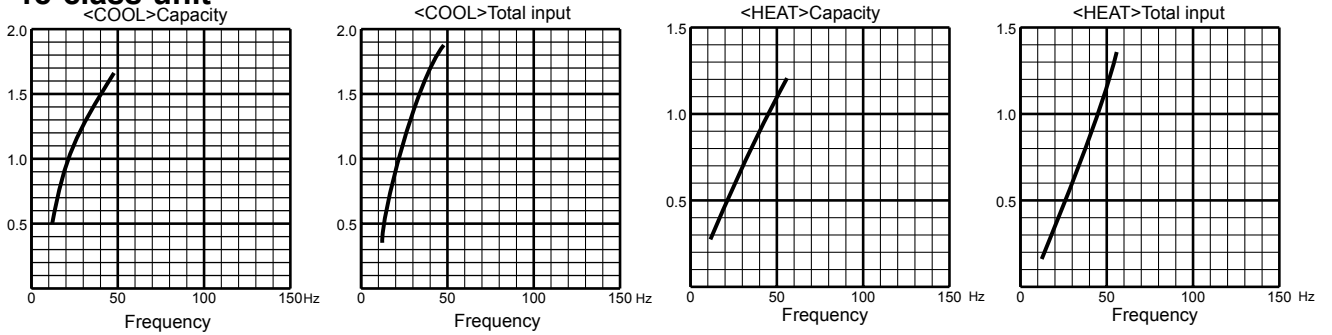

20-class unit

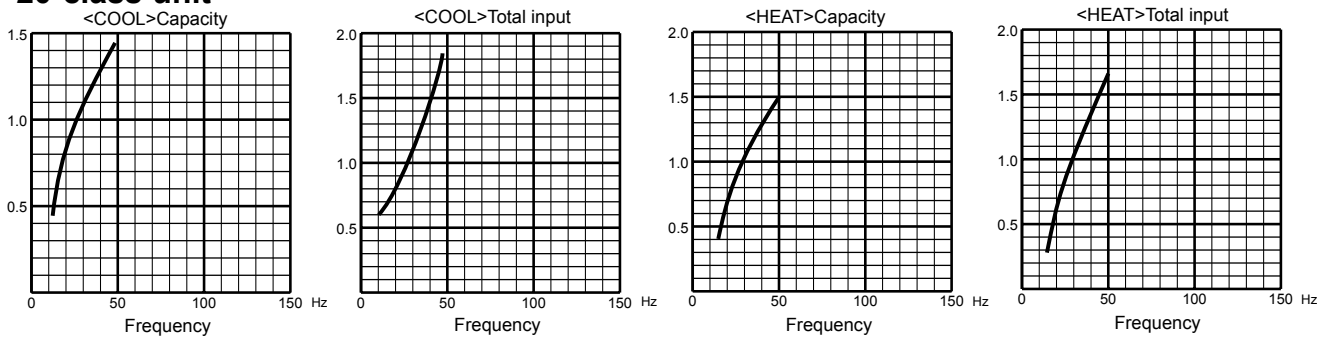

22-class unit

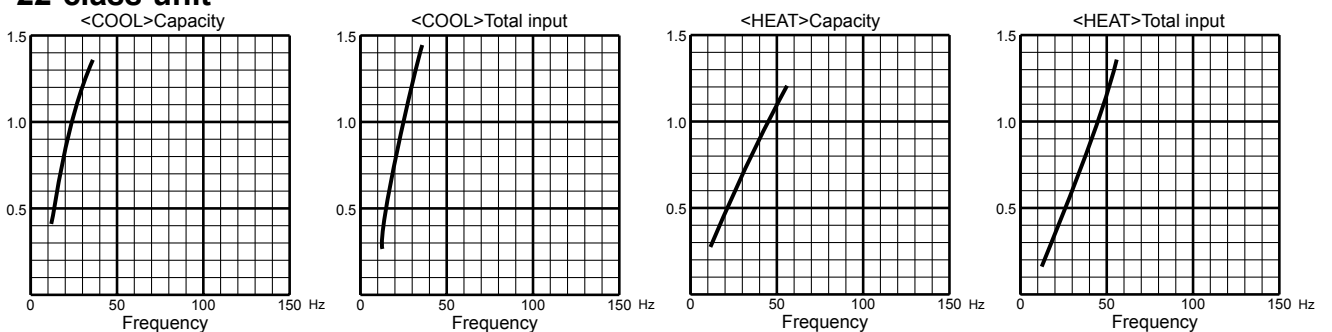

MXZ-2D53VA MXZ-2D53VAH

25-class unit

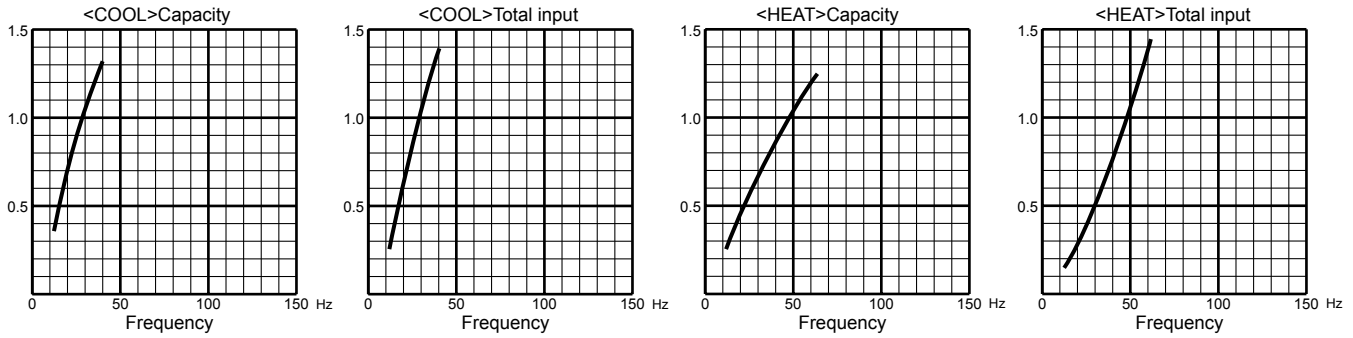

35-class unit

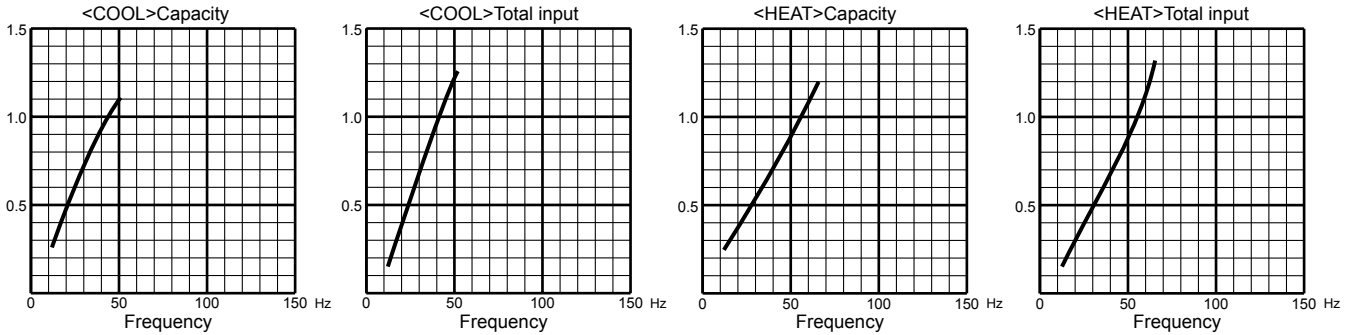

42-class unit

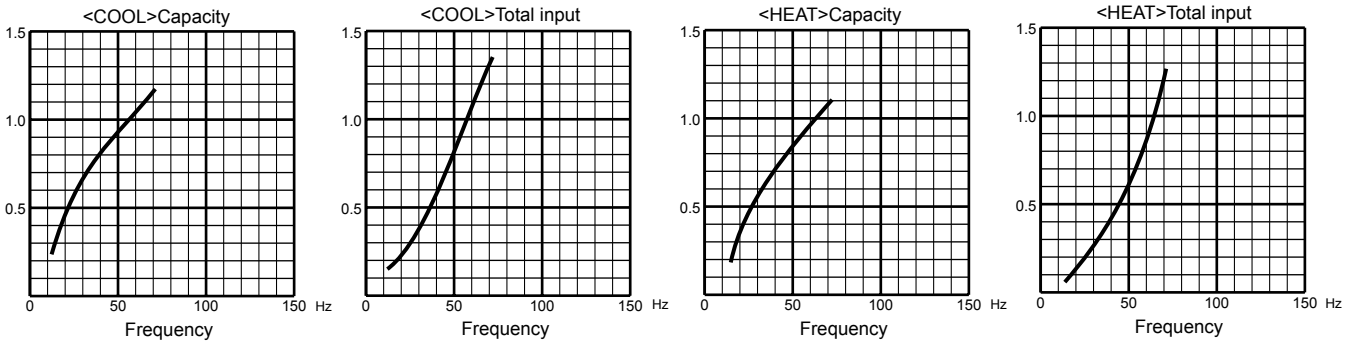

50-class unit

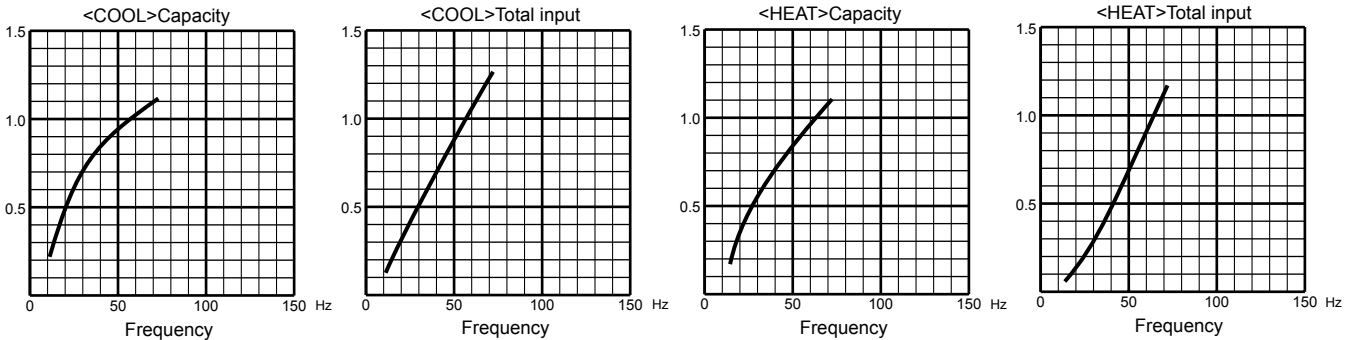

MXZ-3D54VA
15-class unit

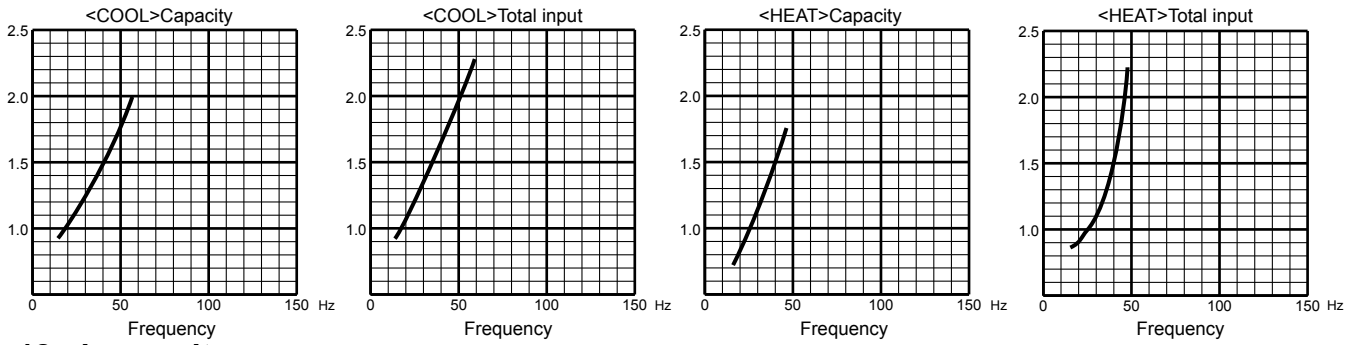

18-class unit

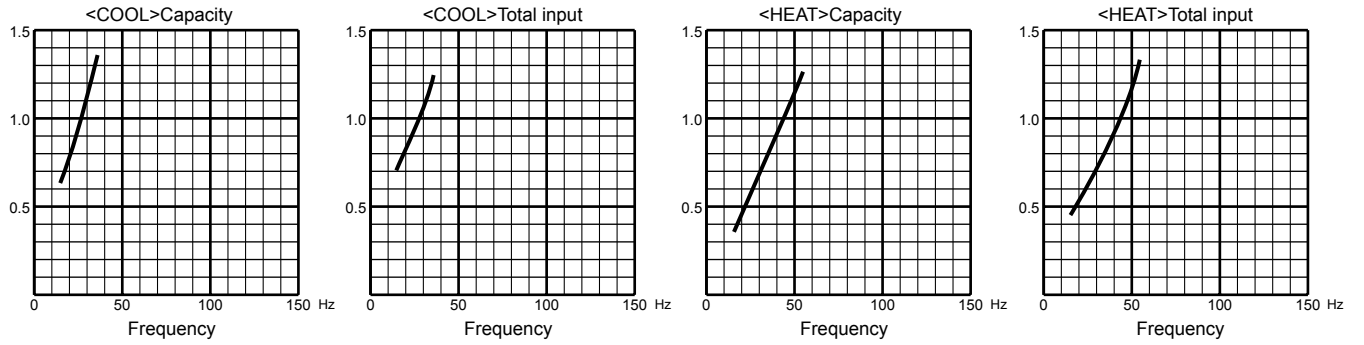

20-class unit

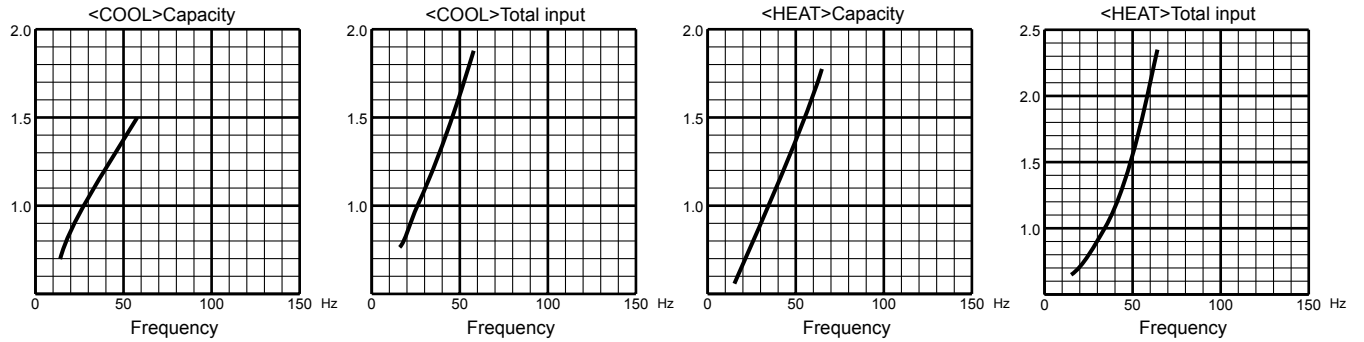

22-class unit

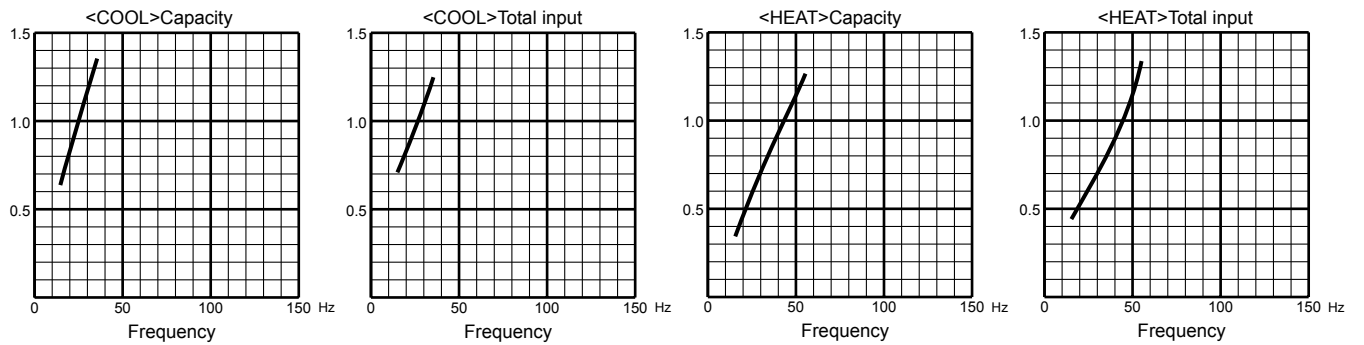

MXZ-3D54VA

25-class unit

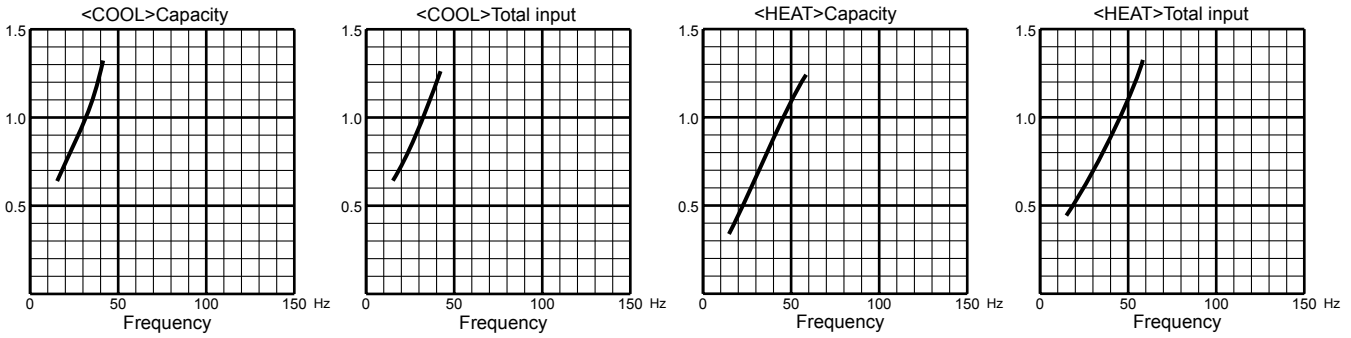

35-class unit

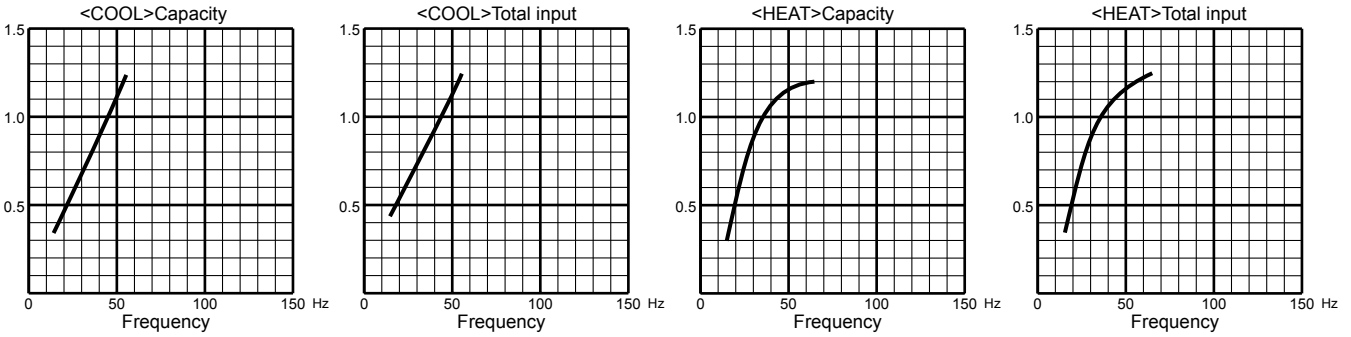

42-class unit

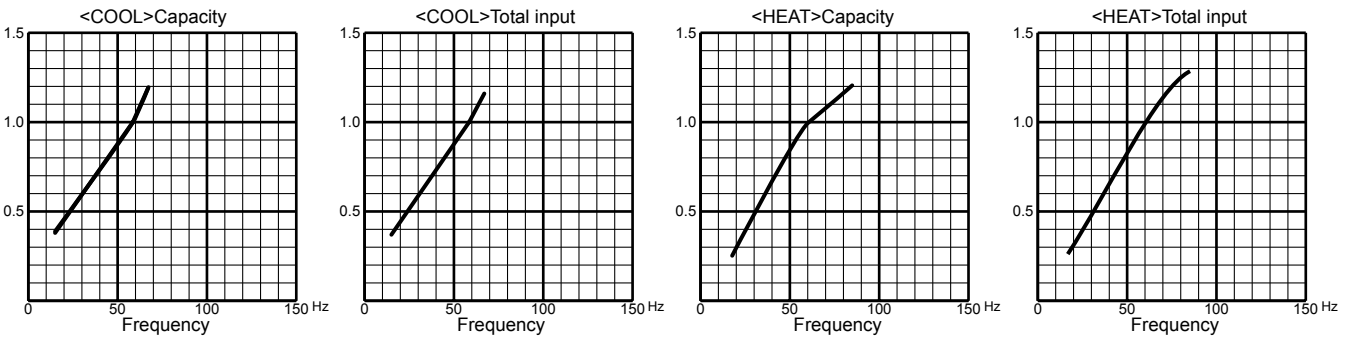

50-class unit

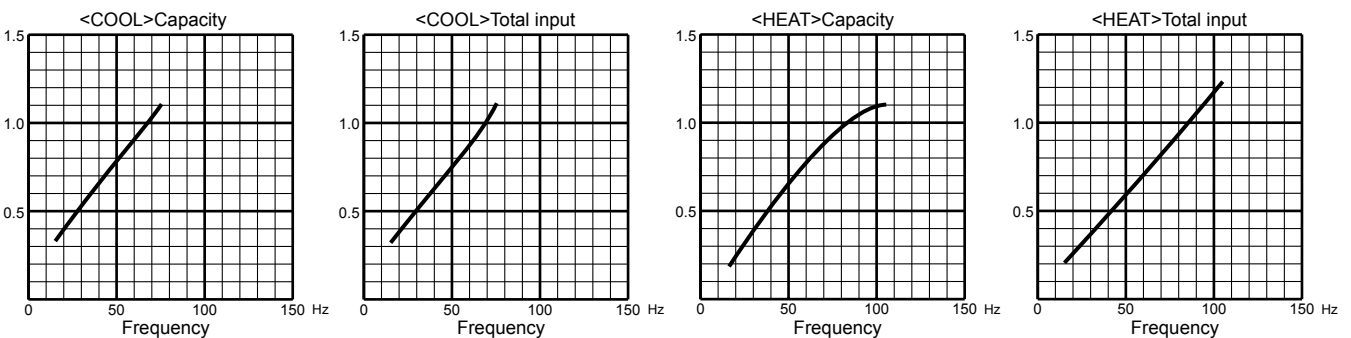

MXZ-3D68VA
15-class unit

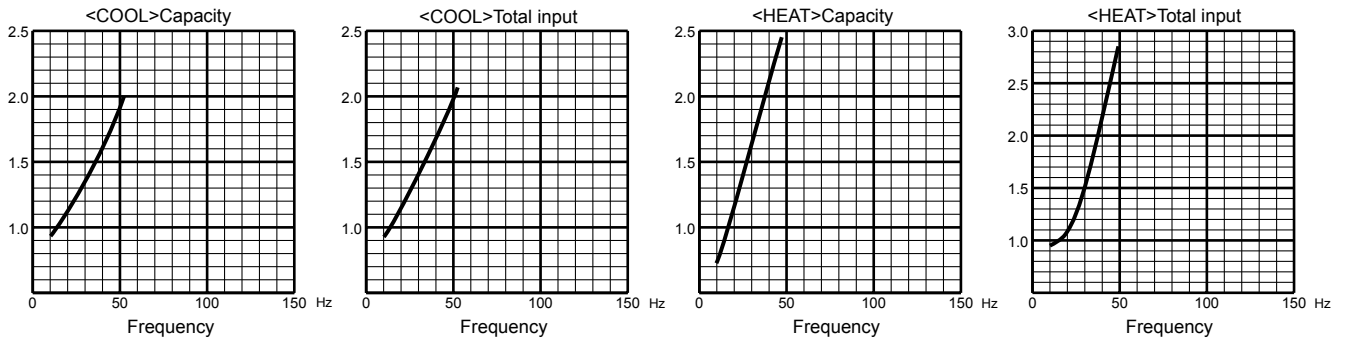

18-class unit

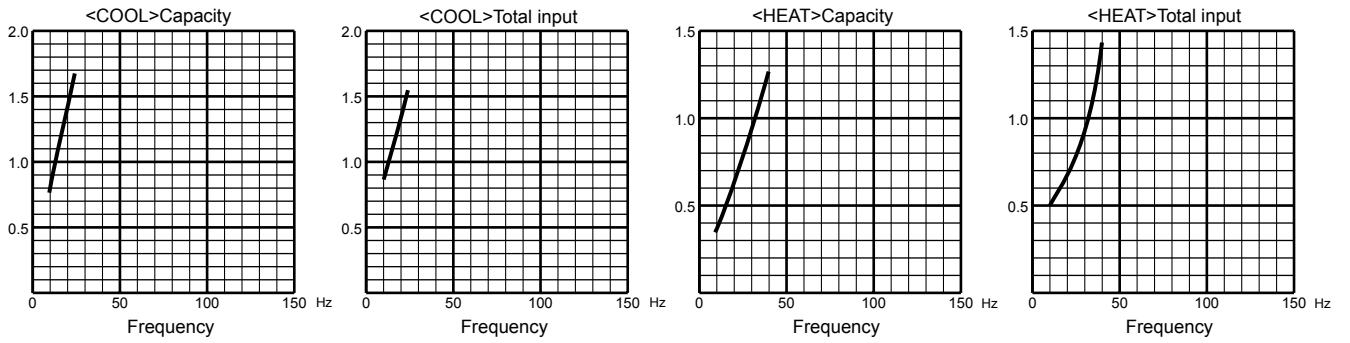

20-class unit

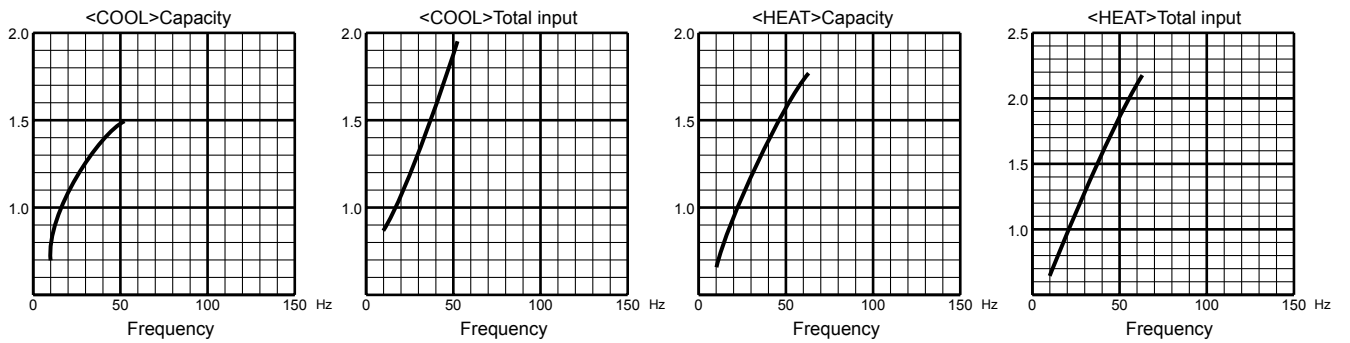

22-class unit

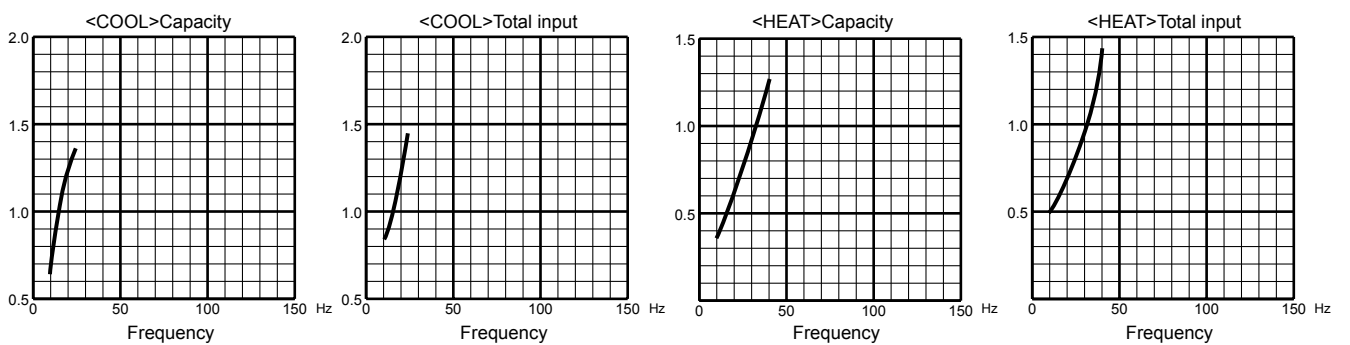

25-class unit

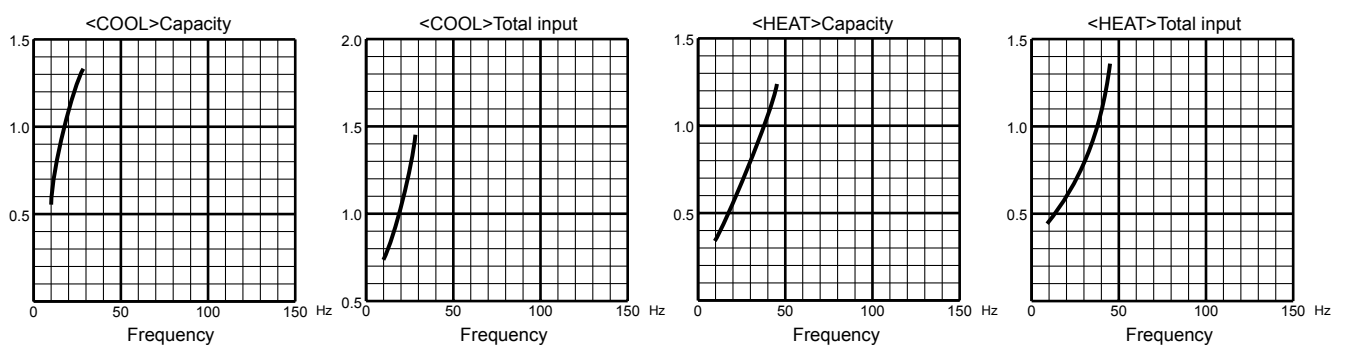

MXZ-3D68VA
35-class unit

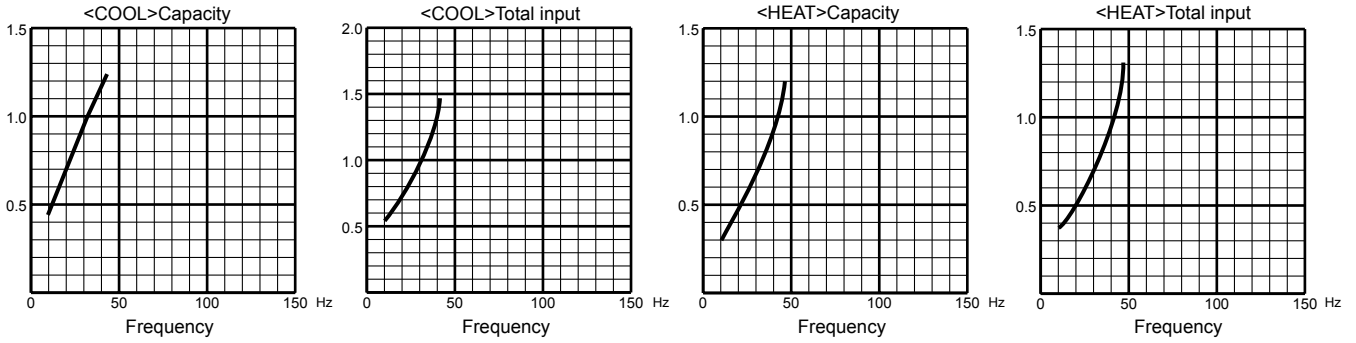

42-class unit

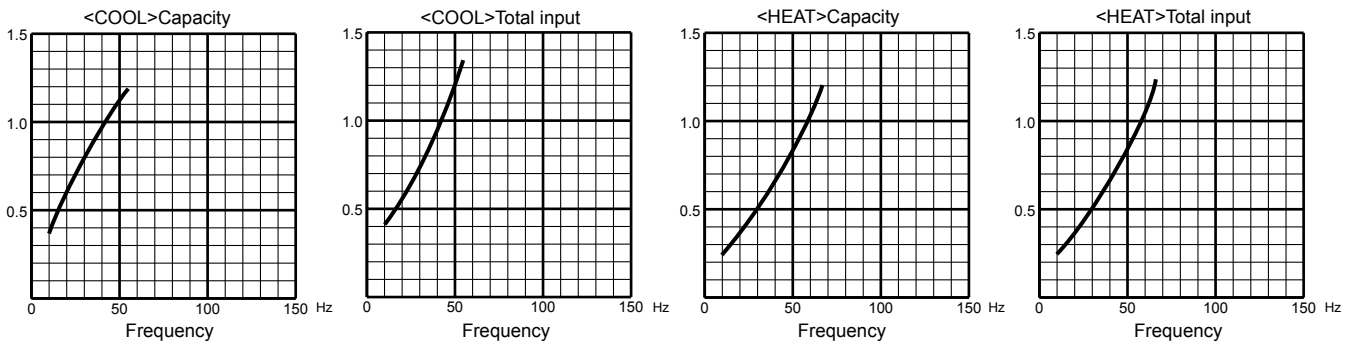

50-class unit

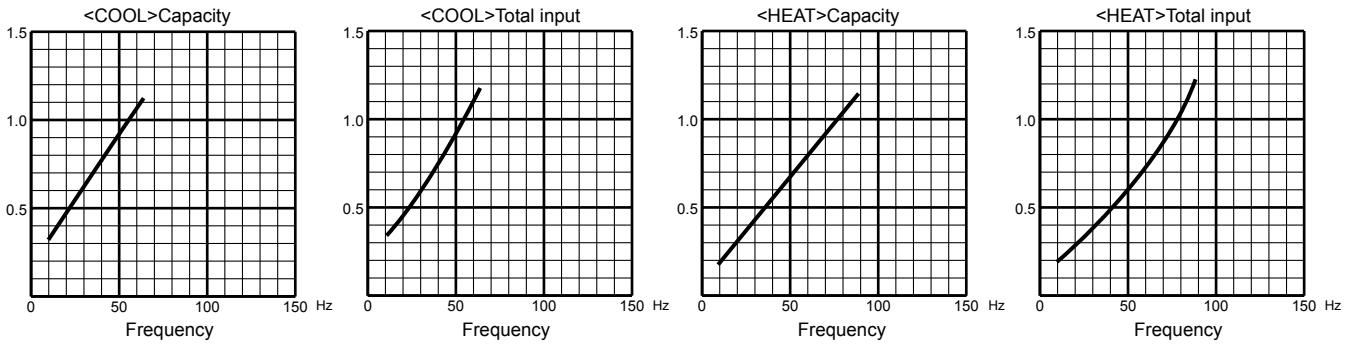

60-class unit

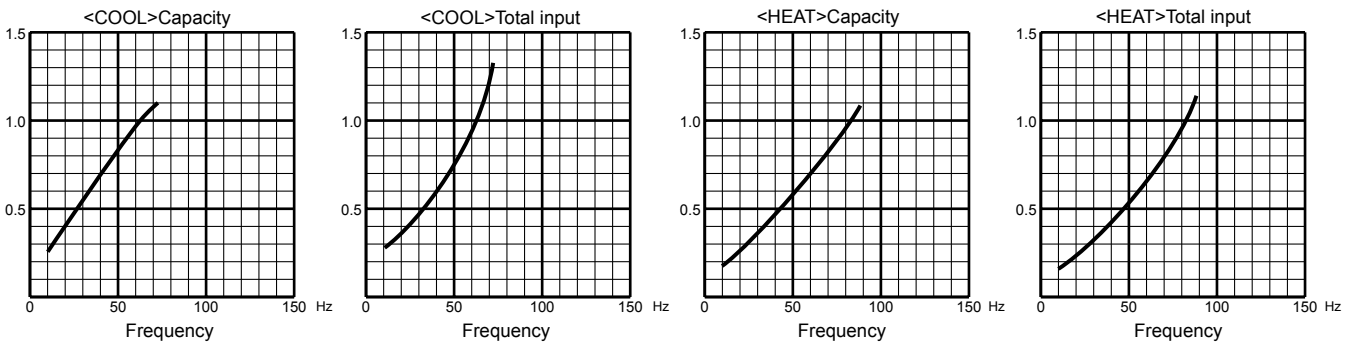

MXZ-4D72VA

15-class unit

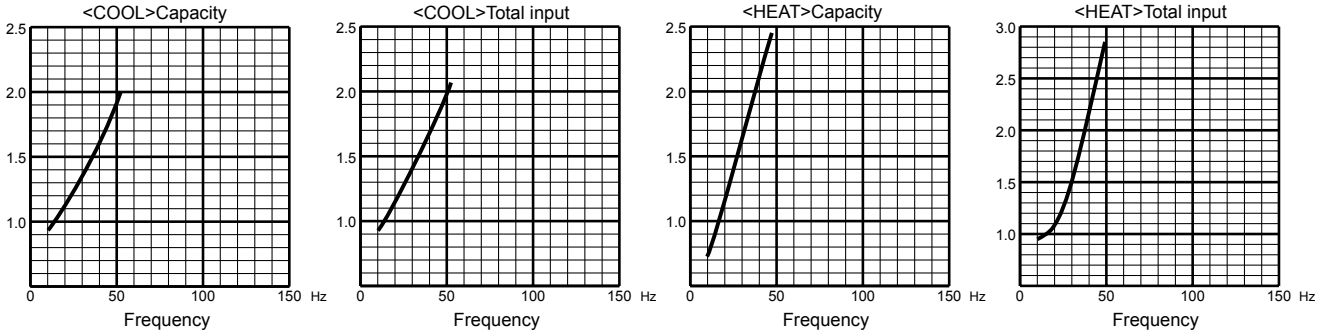

18-class unit

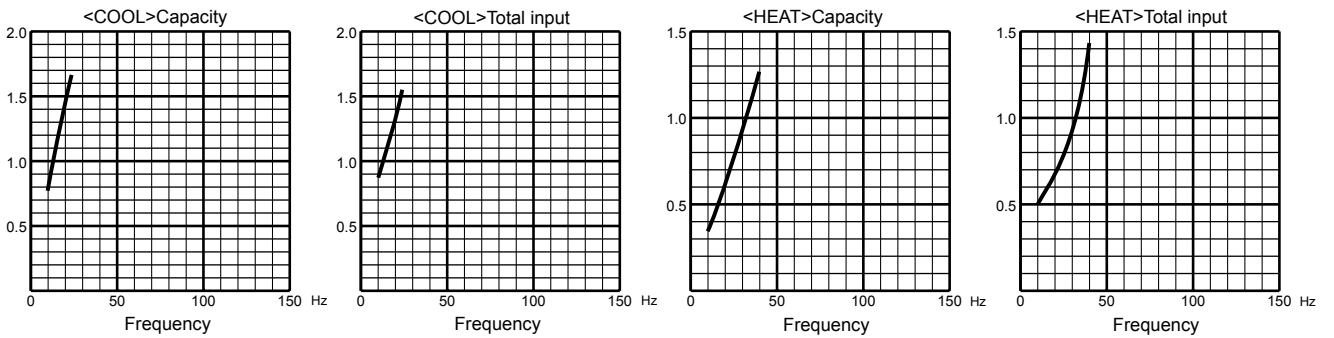

20-class unit

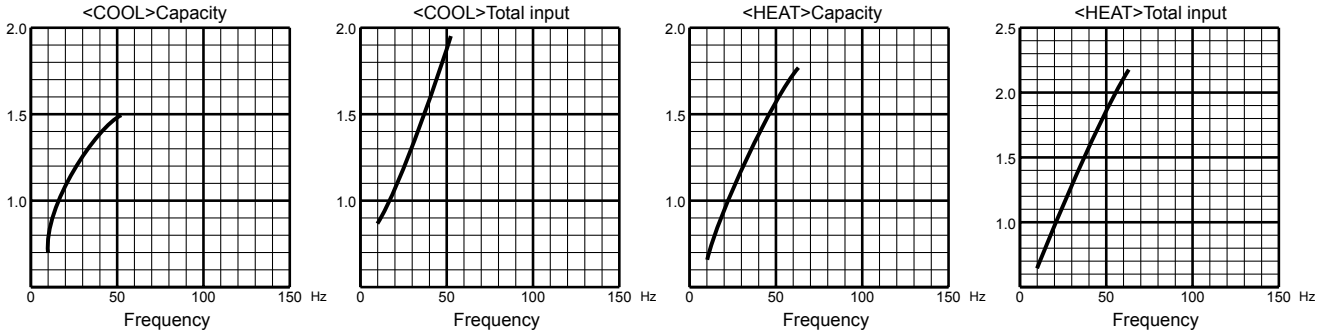

22-class unit

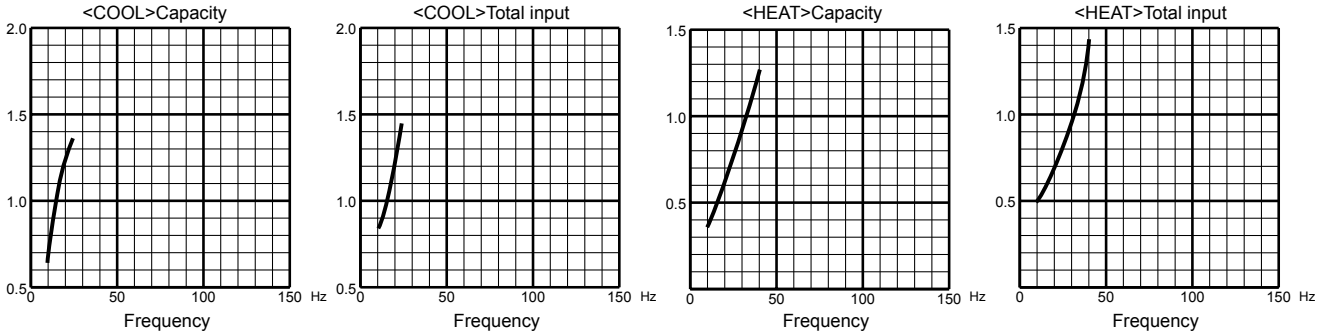

25-class unit

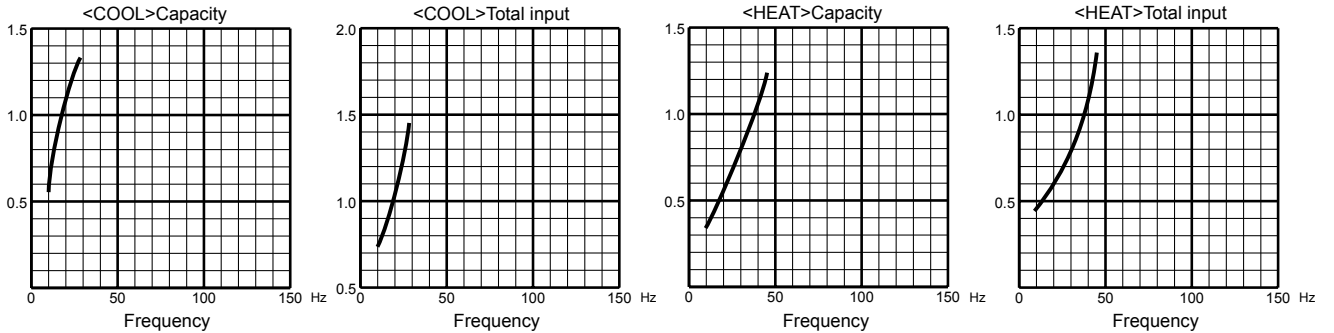

MXZ-4D72VA
35-class unit

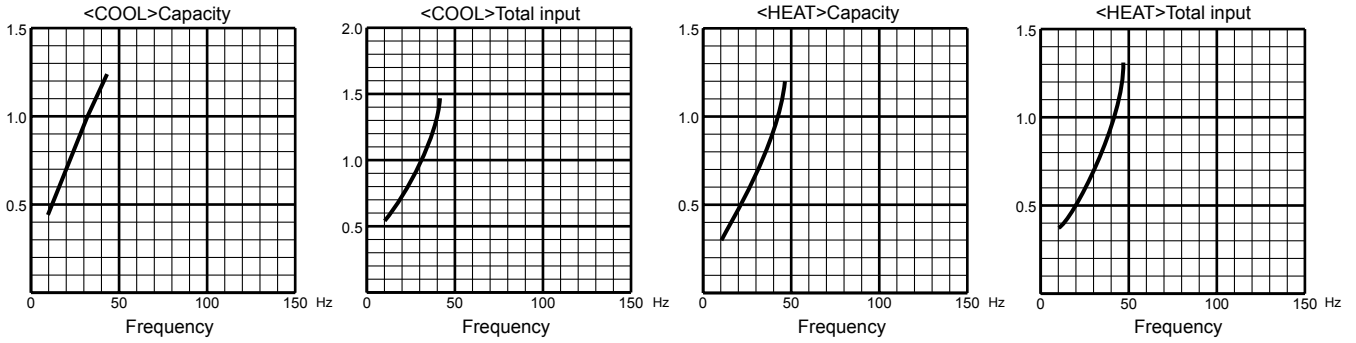

42-class unit

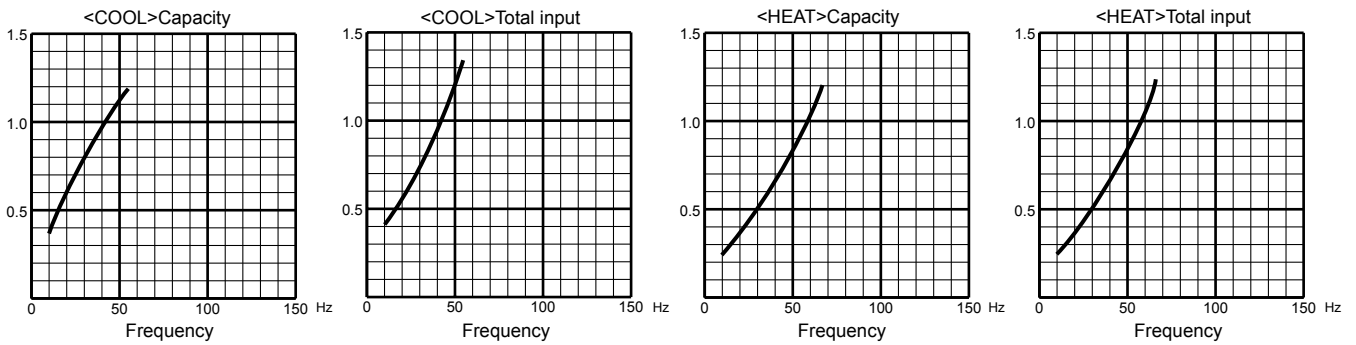

50-class unit

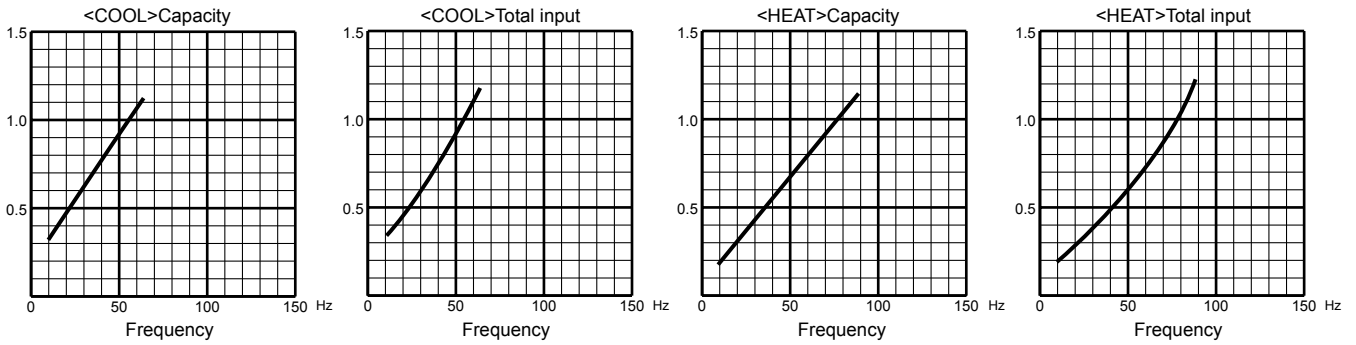

60-class unit

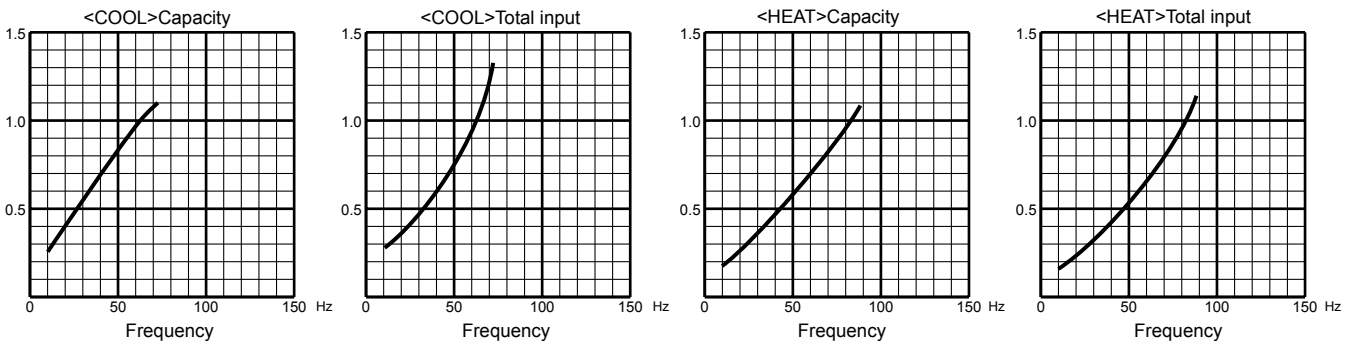

MXZ-4D83VA

15-class unit

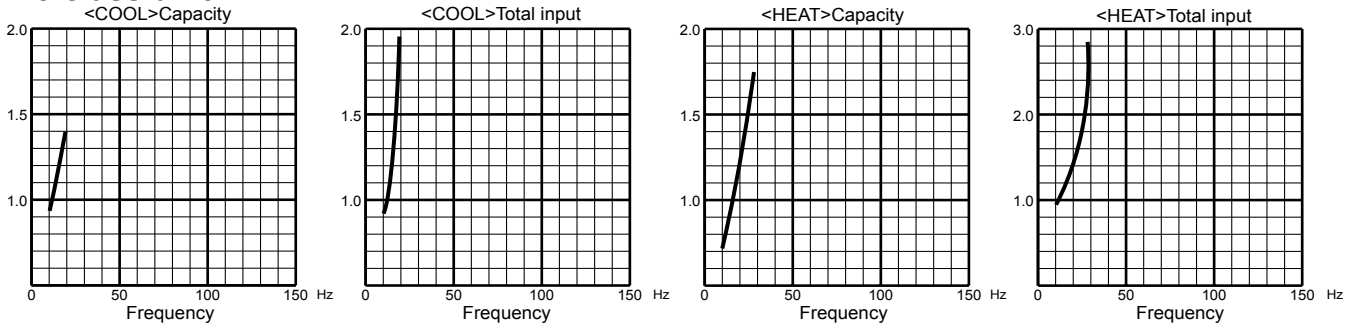

18-class unit

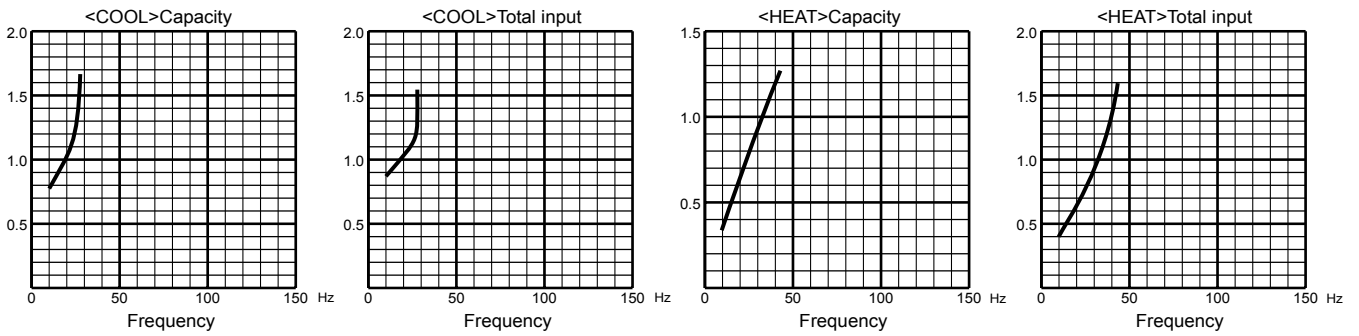

20-class unit

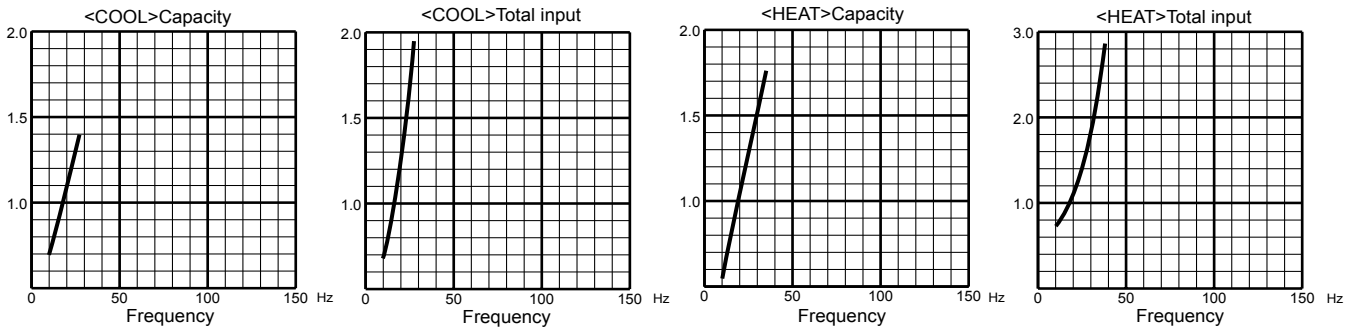

22-class unit

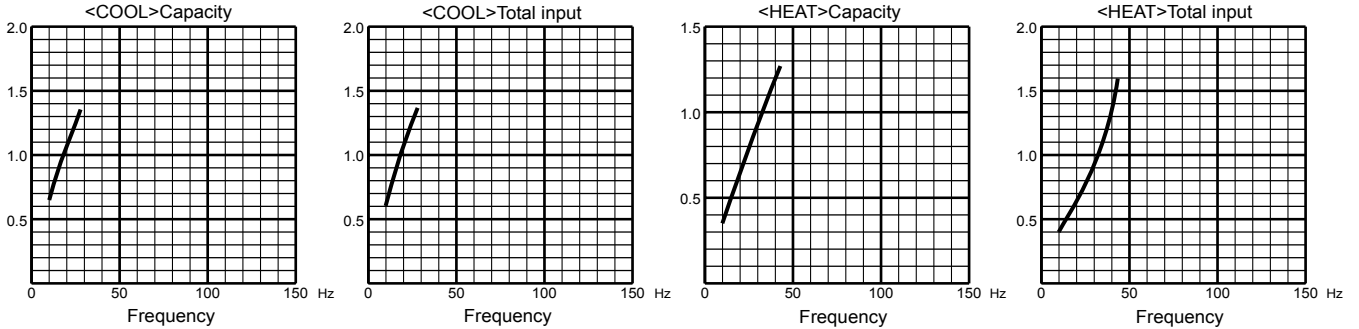

25-class unit

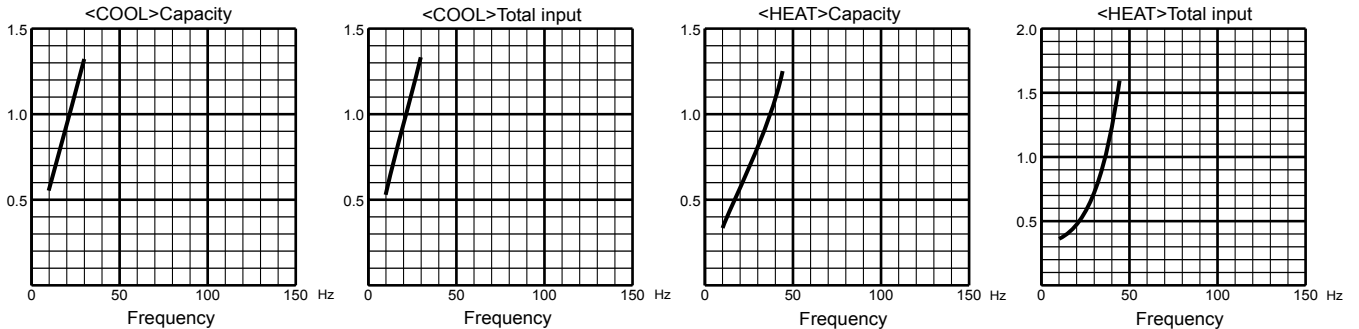

MXZ-4D83VA

35-class unit

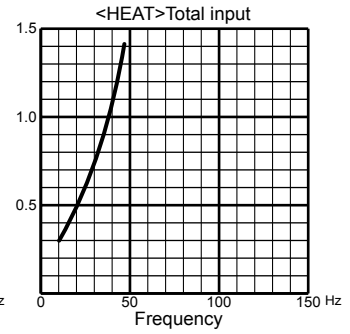
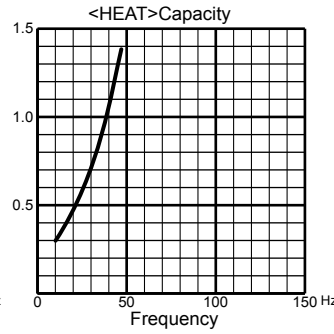
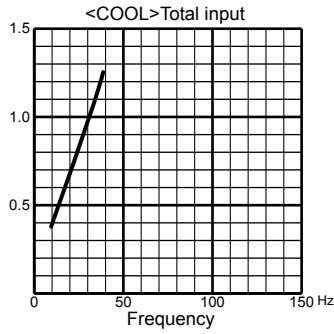
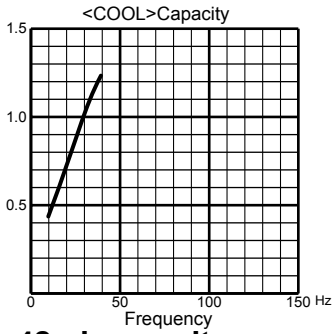

42-class unit

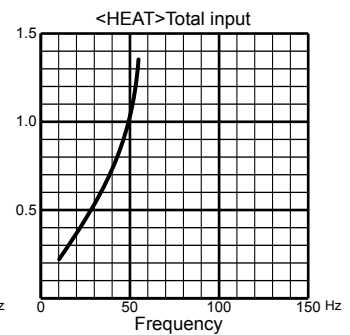
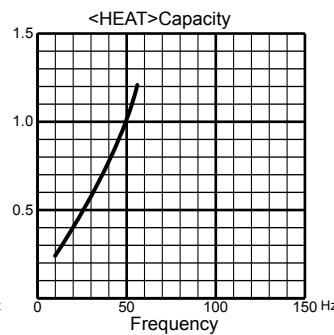
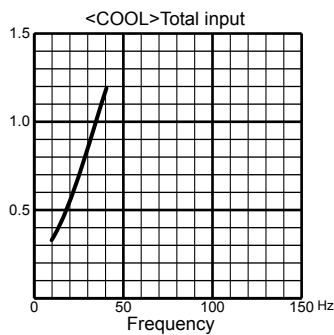
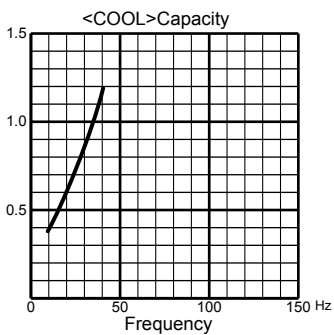

50-class unit

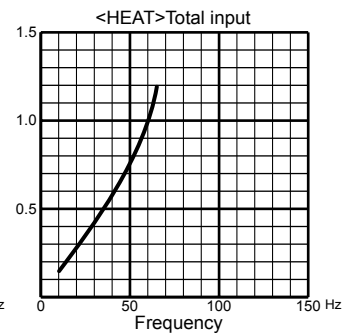
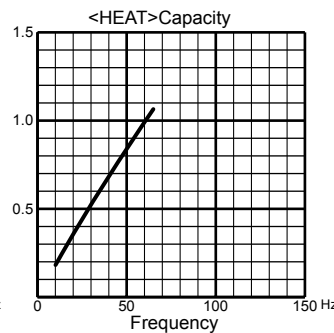
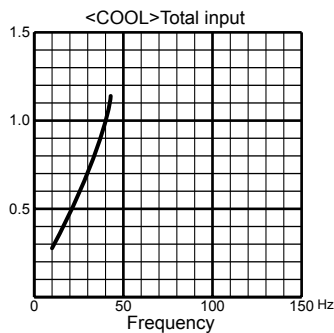
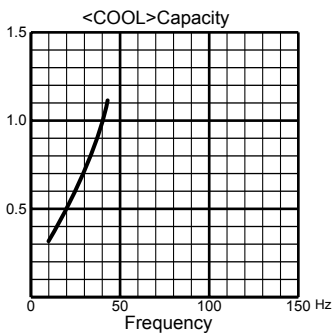

60-class unit

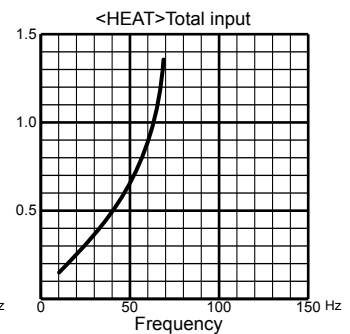
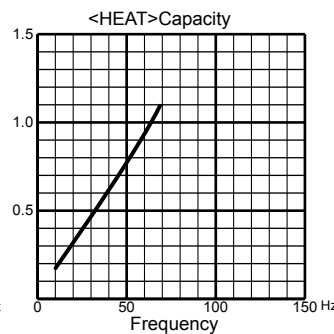
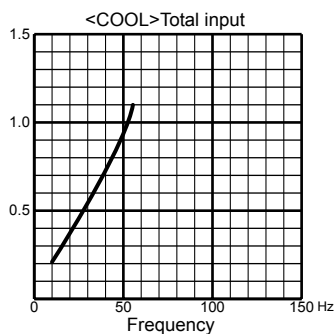
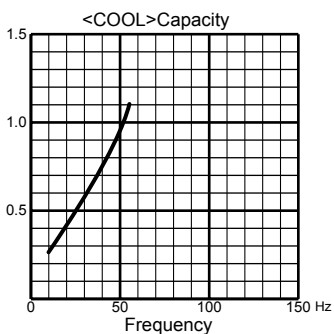

71-class unit

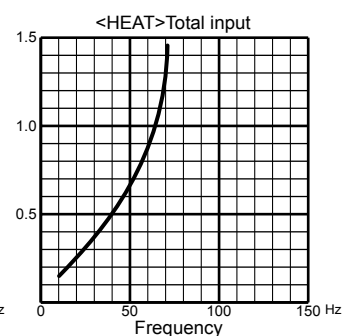
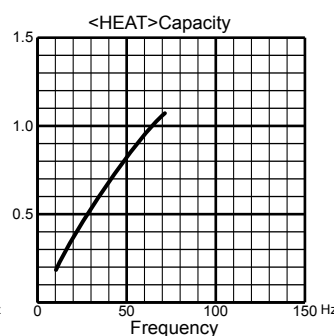
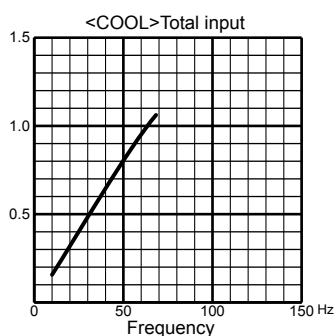
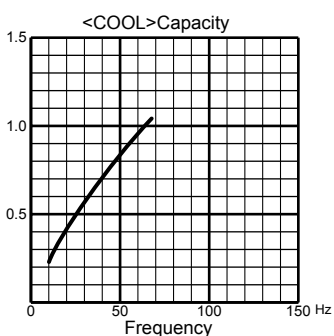

MXZ-5D102VA

15-class unit

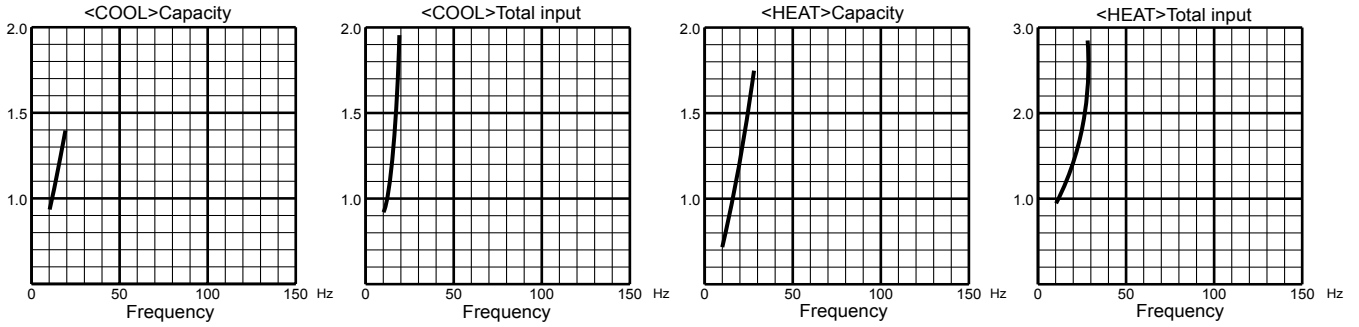

18-class unit

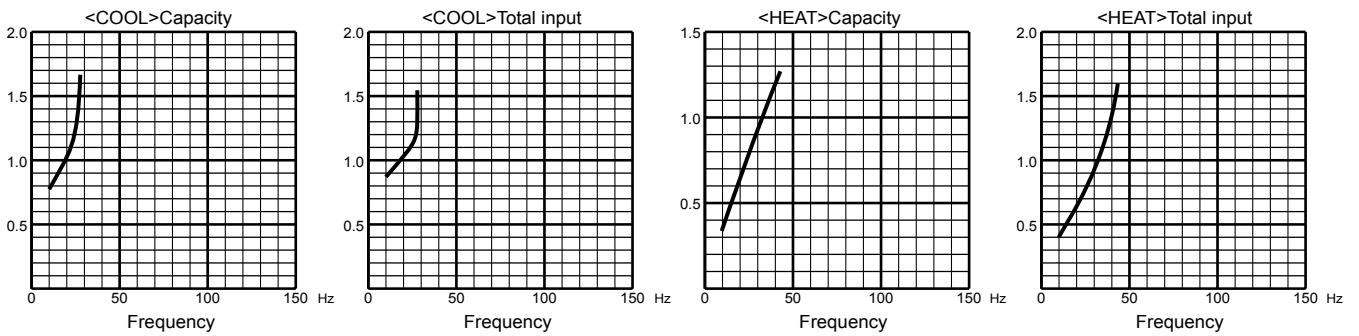

20-class unit

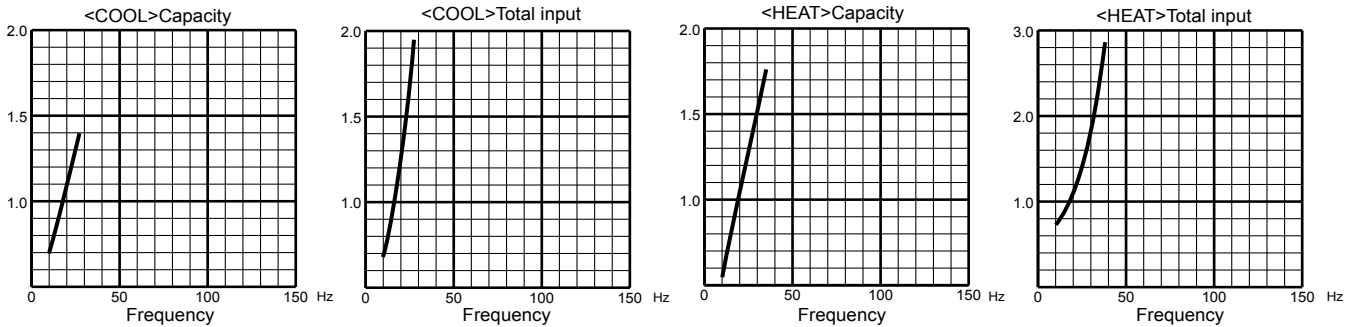

22-class unit

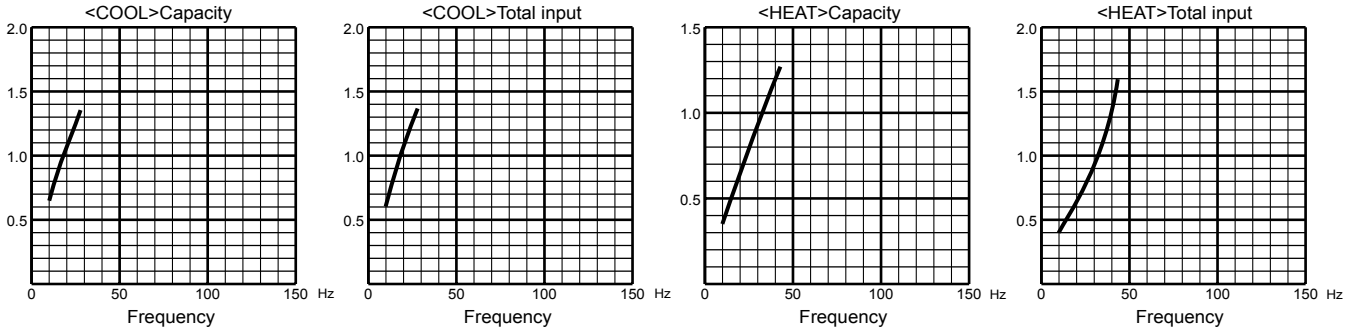

25-class unit

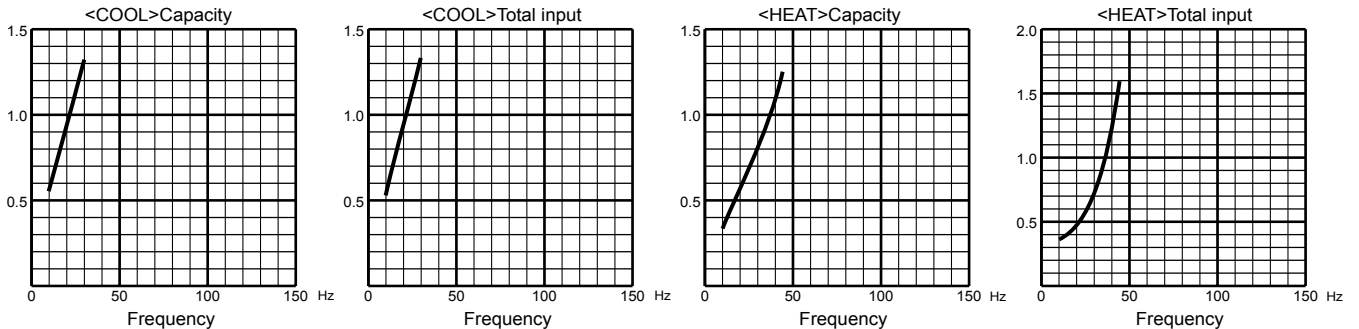

MXZ-5D102VA
35-class unit

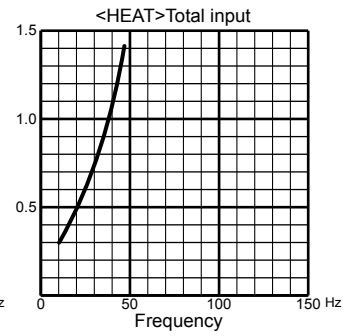
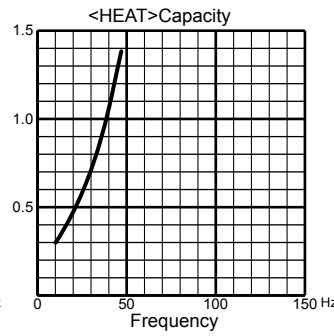
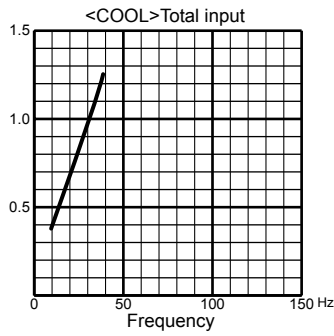
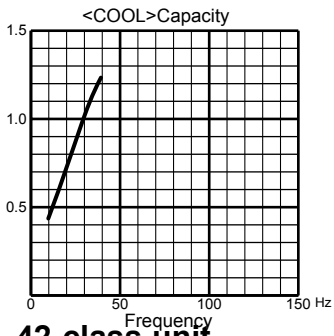

42-class unit

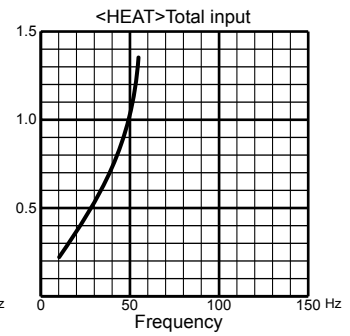
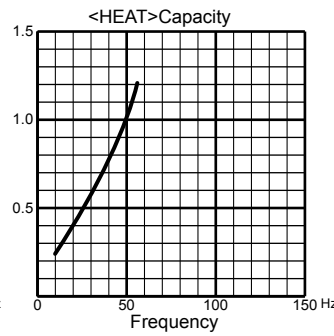
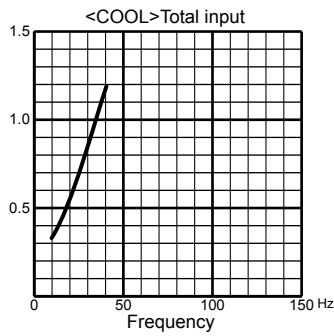
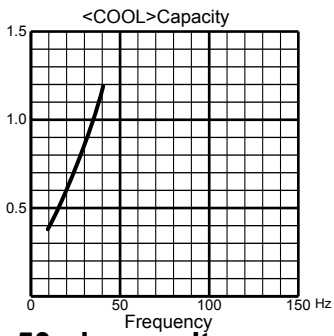

50-class unit

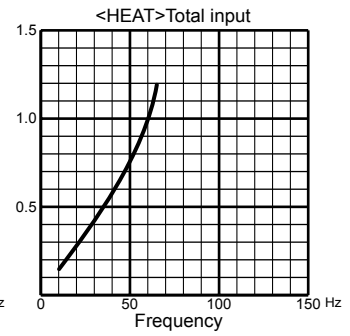
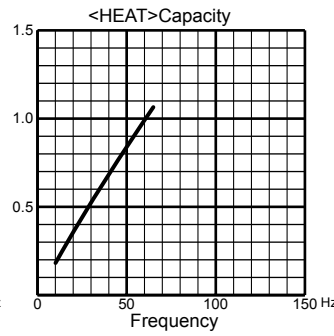
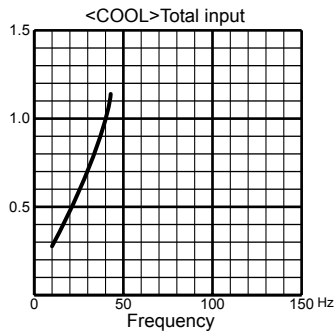
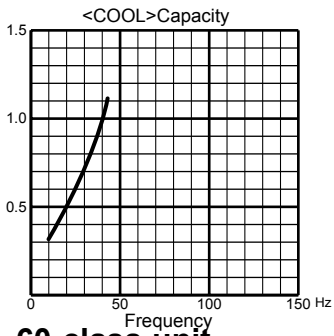

60-class unit

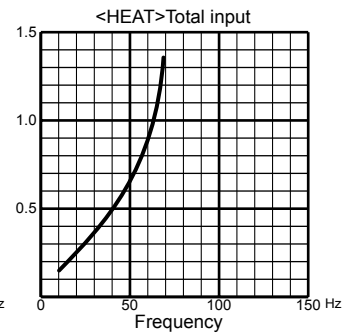
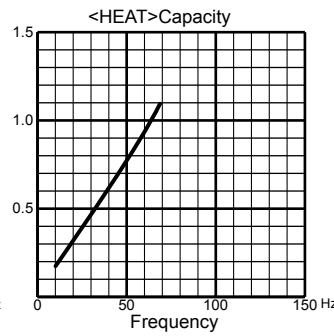
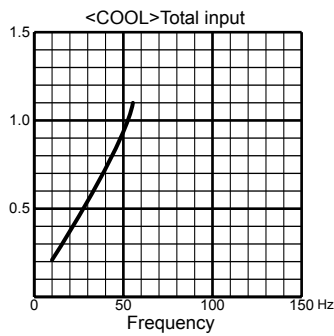
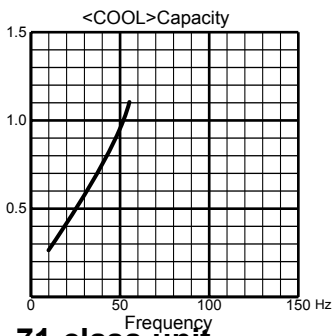

71-class unit

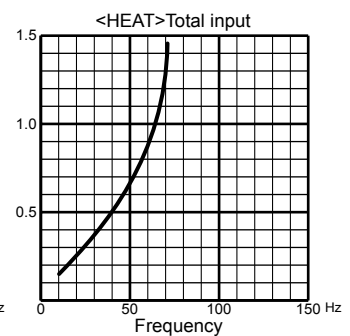
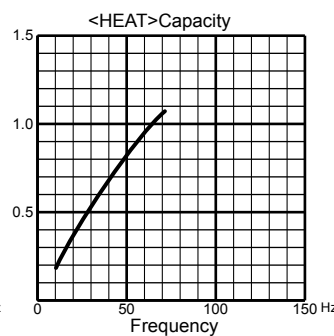
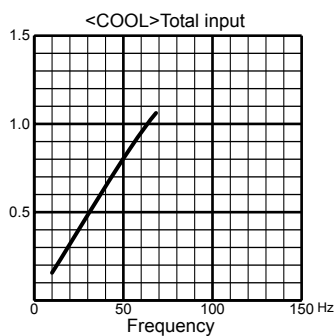
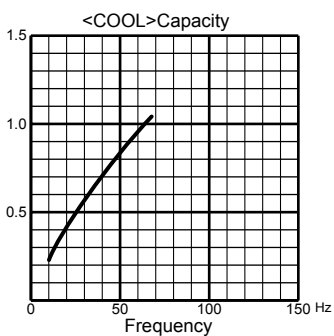

8-3. HOW TO OPERATE FIXED-FREQUENCY OPERATION <Test run operation>

1. Press EMERGENCY OPERATION switch to COOL or HEAT mode (COOL : Press once, HEAT : Press twice).
2. Test run operation starts and continues to operate for 30 minutes.
3. Compressor operates at rated frequency.
4. Indoor fan operates at High speed.
5. After 30 minutes, test run operation finishes and EMERGENCY OPERATION starts (Operation frequency of compressor varies).
6. To cancel test run operation (EMERGENCY OPERATION), press EMERGENCY OPERATION switch or any button on remote controller.

8-4. OUTDOOR LOW PRESSURE AND OUTDOOR UNIT CURRENT CURVE (single operation)

NOTE: The unit of pressure has been changed to MPa on the international system of units (SI unit system).
The conversion factor is : **1 (MPa [Gauge]) = 10.2 (kgf/cm² [Gauge])**

(1) COOL operation

- ① Both indoor and outdoor units are under the same temperature/humidity condition.
- ② Operation : TEST RUN OPERATION (Refer to 8-3.)

Dry-bulb temperature (°C)	Relative humidity (%)
20	50
25	60
30	70

MXZ-2D33VA

15-class unit

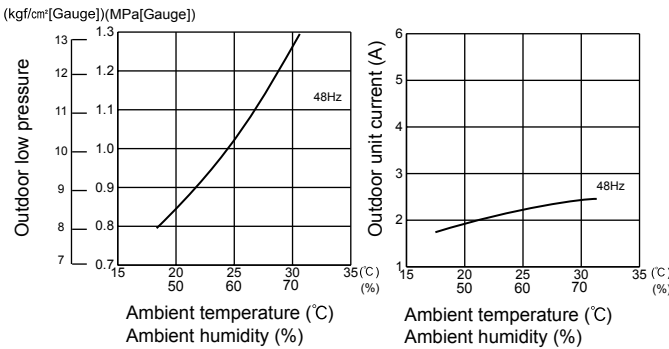

18-class unit

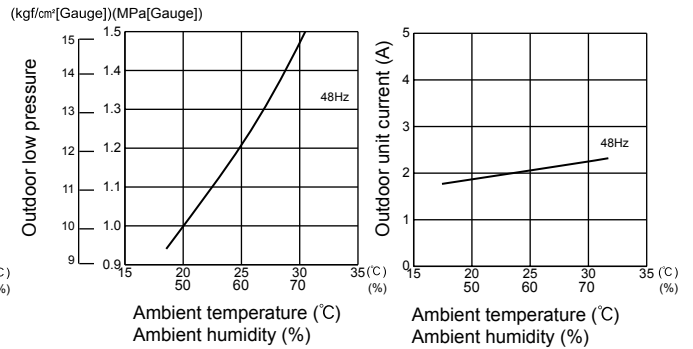

20-class unit

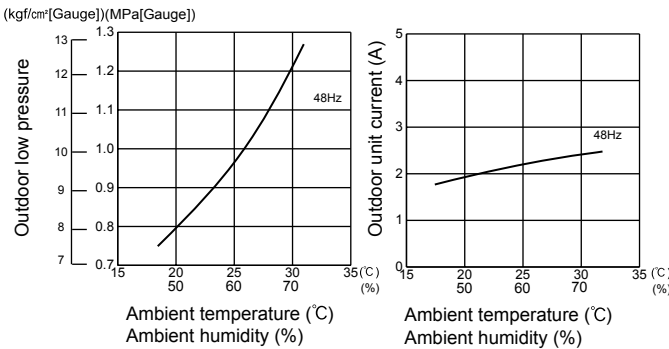

22-class unit

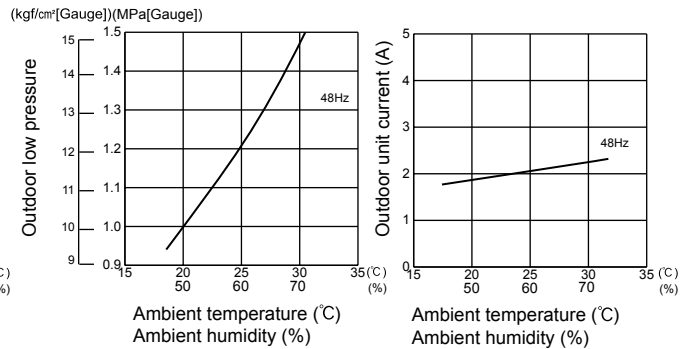

25-class unit

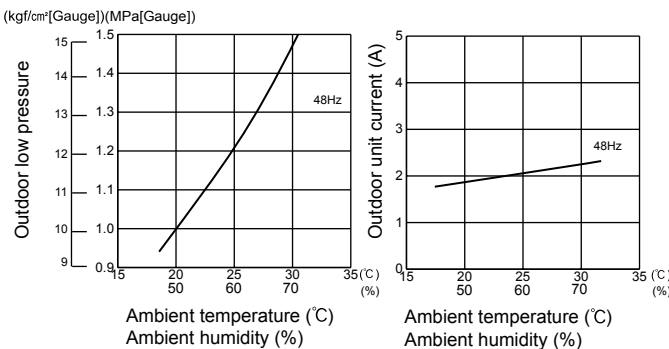

MXZ-2D40VA

15-class unit

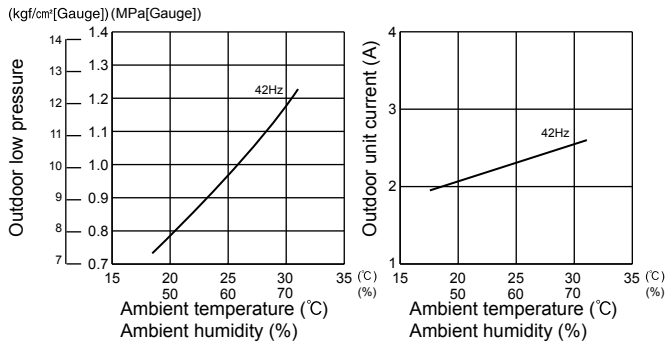

18-class unit

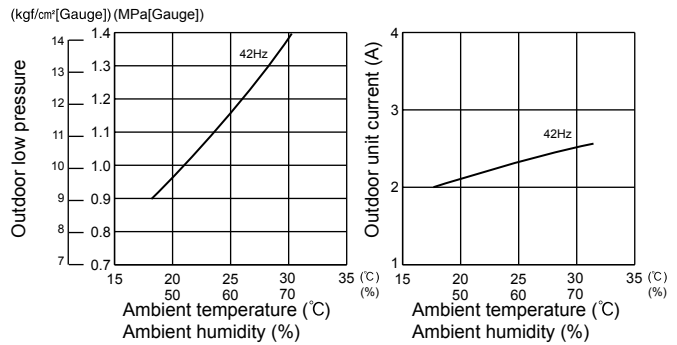

20-class unit

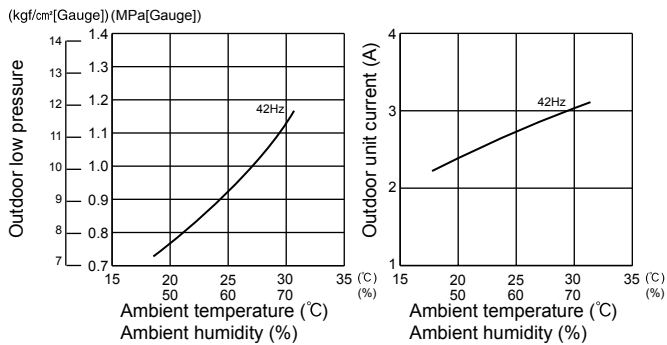

22-class unit

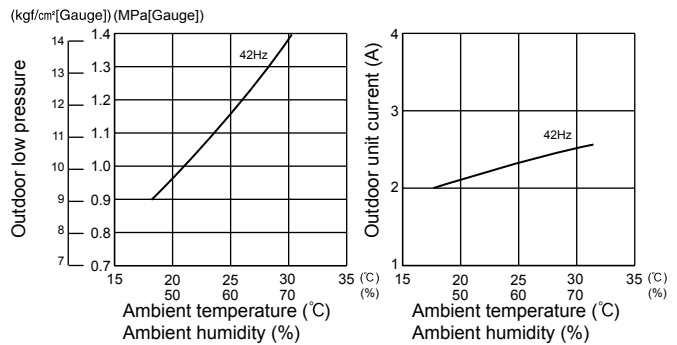

25-class unit

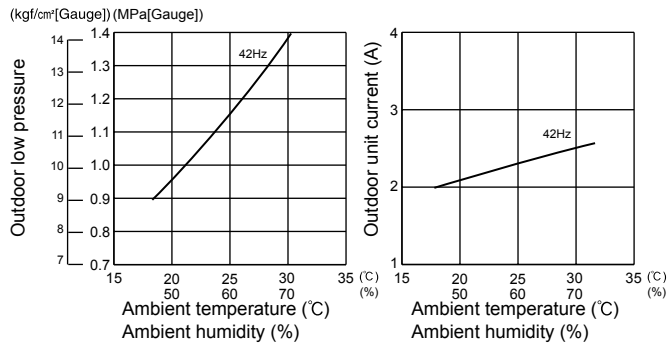

35-class unit

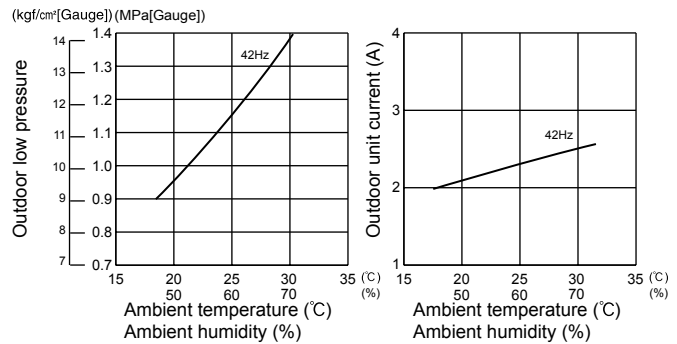

MXZ-2D53VA MXZ-2D53VAH

15-class unit

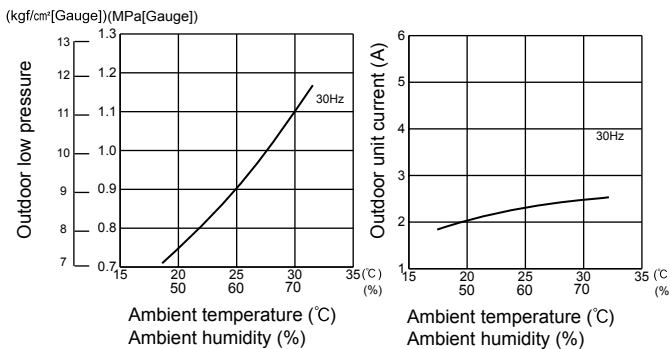

18-class unit

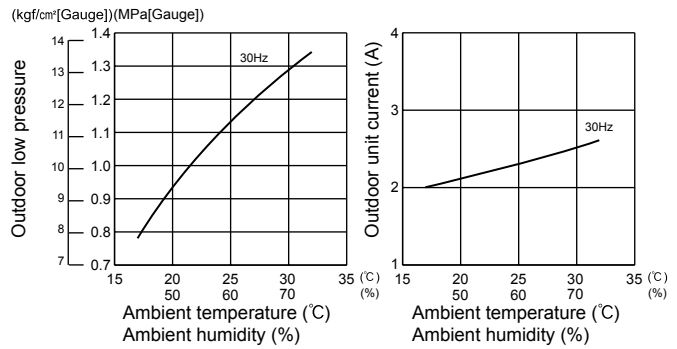

MXZ-2D53VA MXZ-2D53VAH

20-class unit

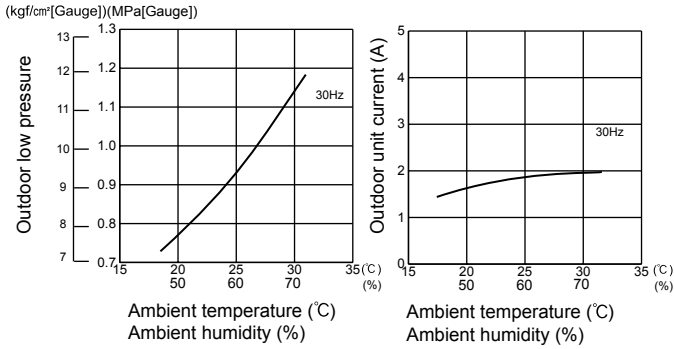

22-class unit

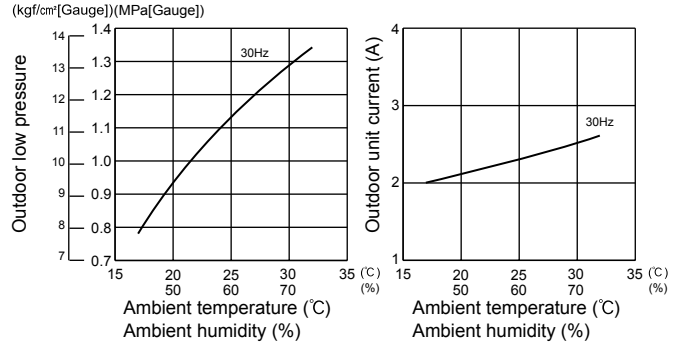

25-class unit

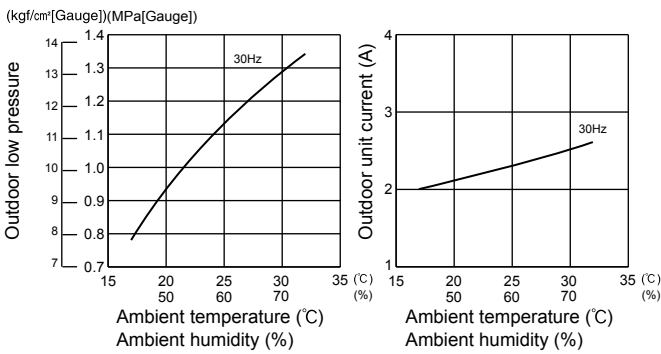

35-class unit

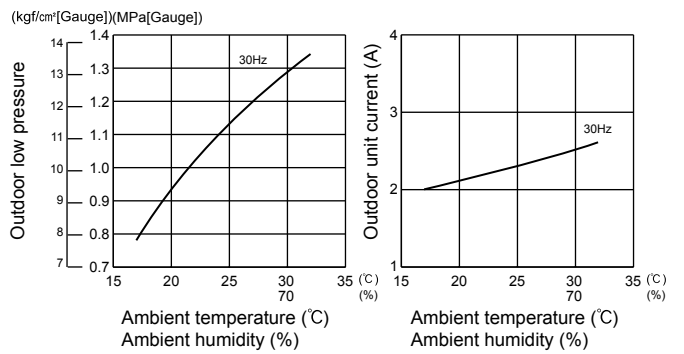

42-class unit

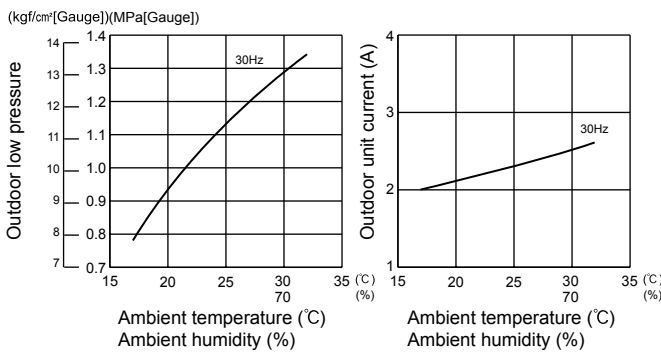

50-class unit

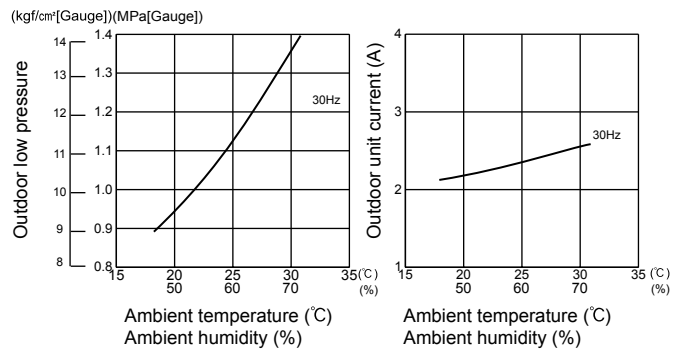

MXZ-3D54VA

15-class unit

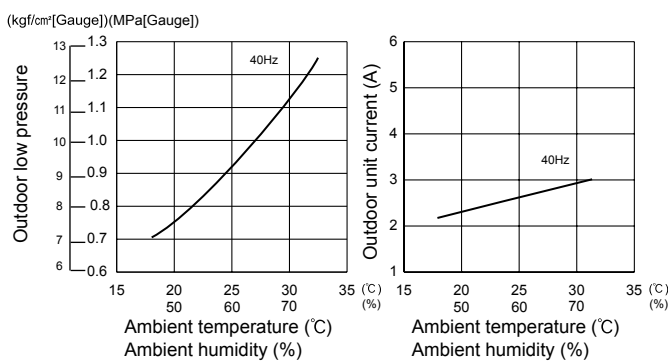

18-class unit

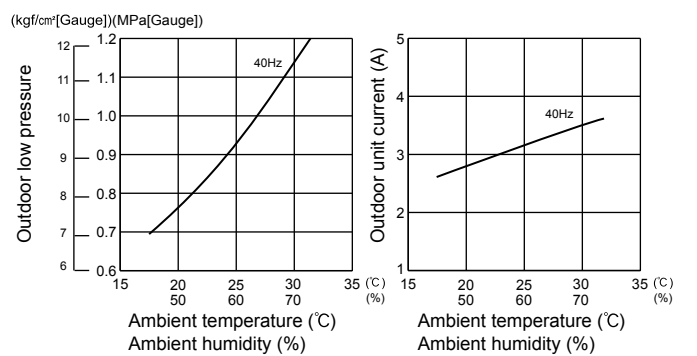

MXZ-3D54VA

20-class unit

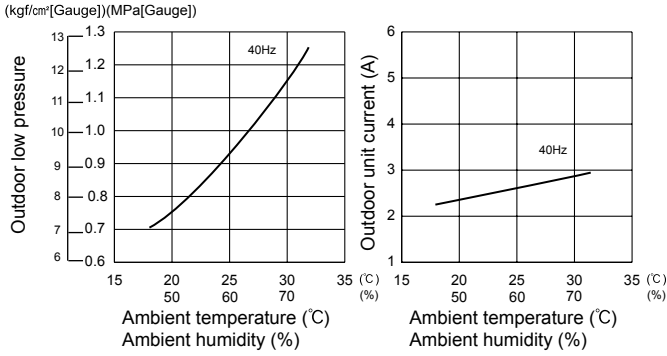

22-class unit

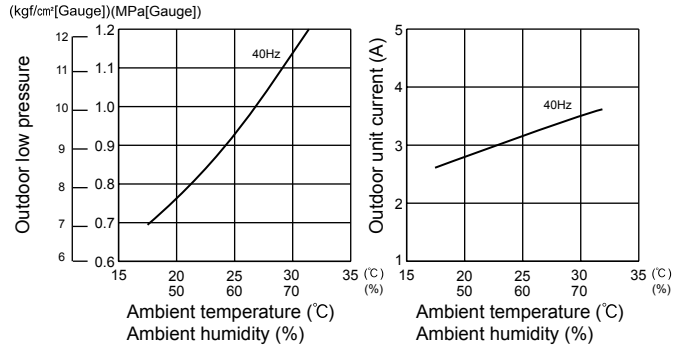

25-class unit

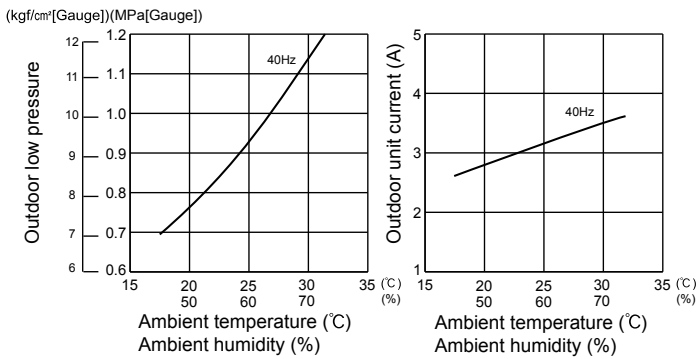

35-class unit

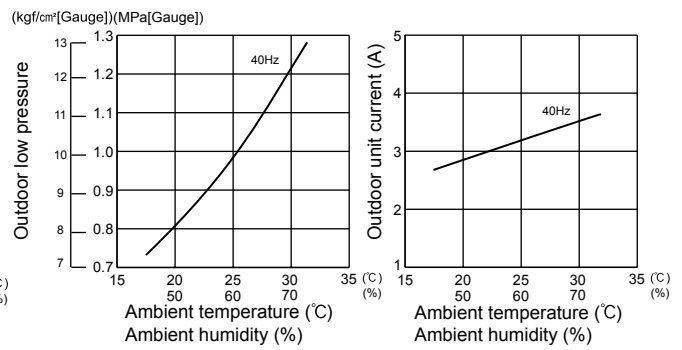

42-class unit

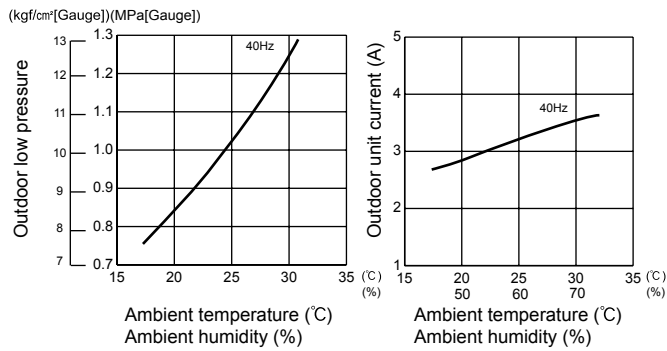

50-class unit

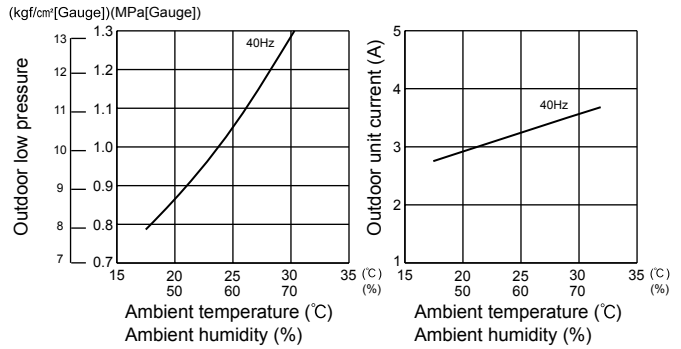

MXZ-3D68VA MXZ-4D72VA

15-class unit

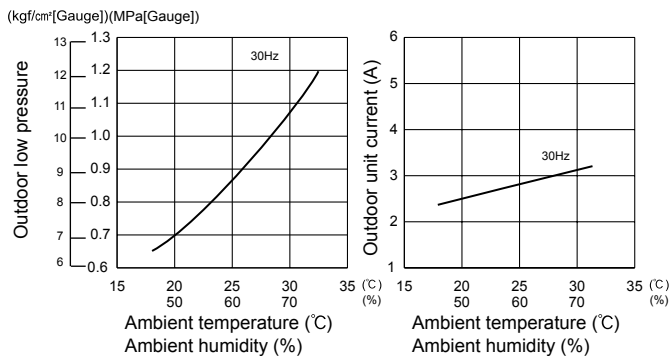

18-class unit

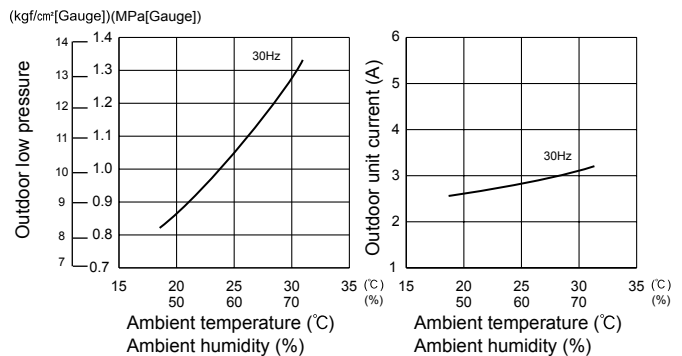

MXZ-3D68VA MXZ-4D72VA
20-class unit

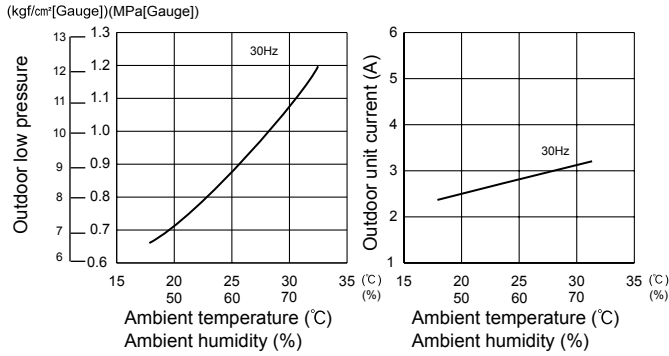

22-class unit

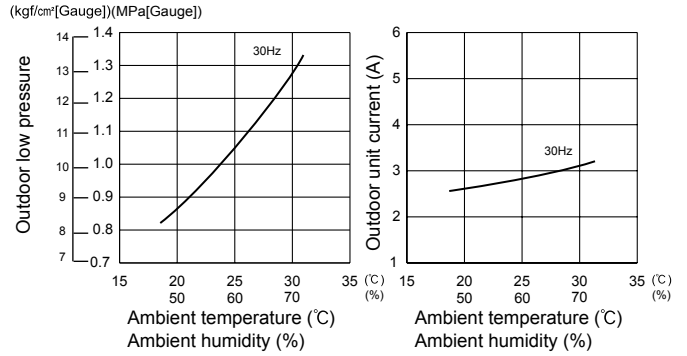

25-class unit

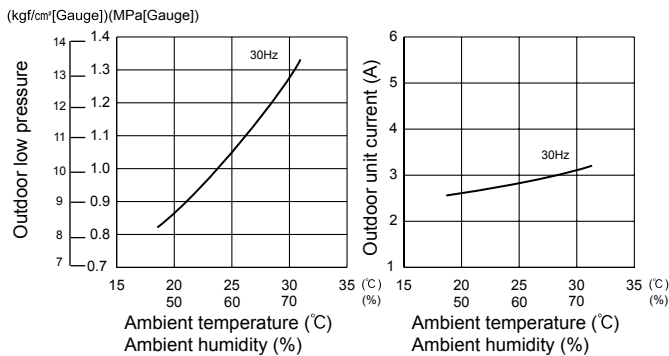

35-class unit

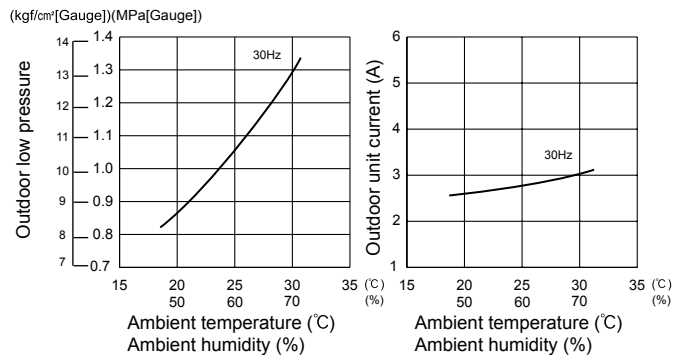

42-class unit

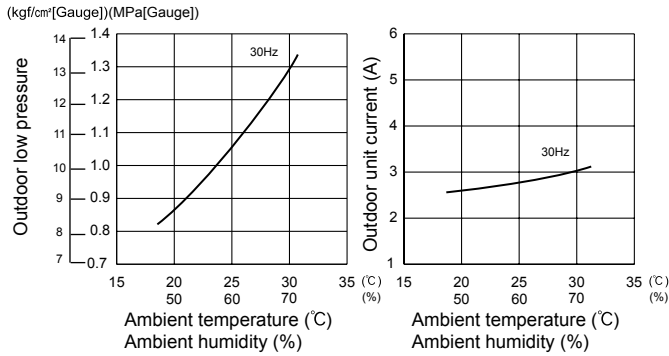

50-class unit

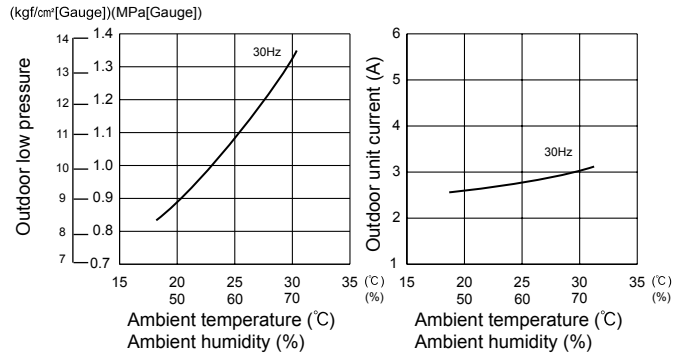

MXZ-4D83VA

60-class unit

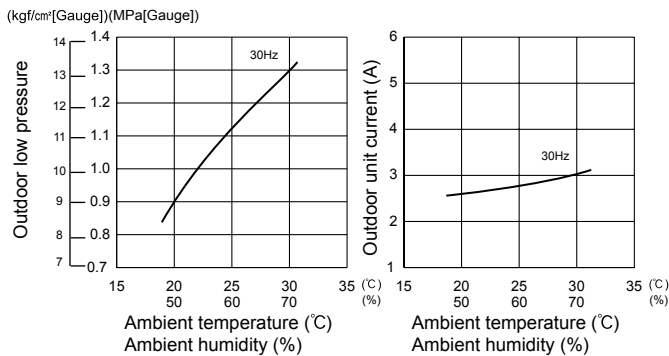

15-class unit

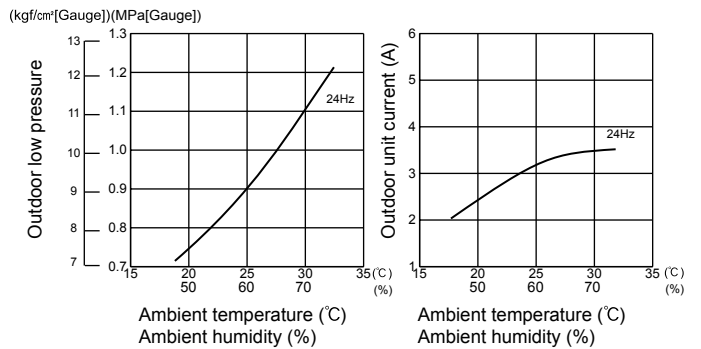

MXZ-4D83VA

18-class unit

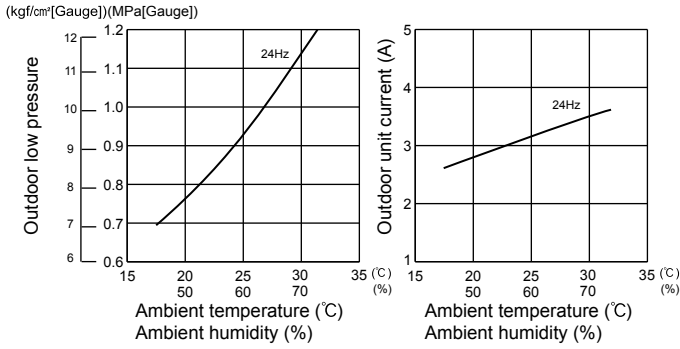

20-class unit

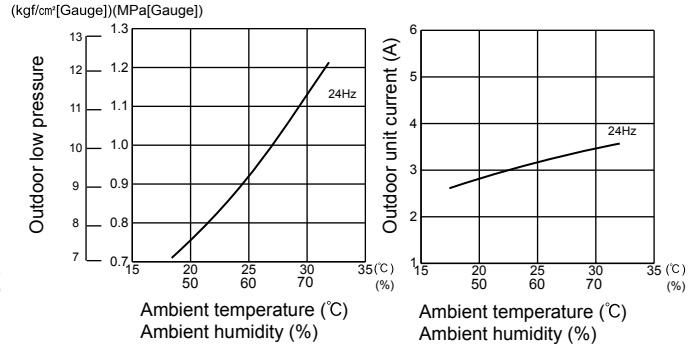

22-class unit

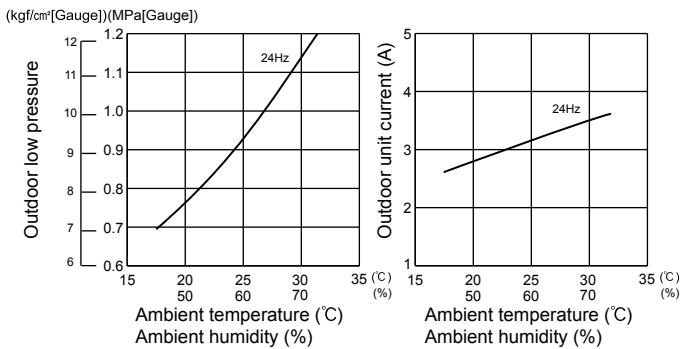

25-class unit

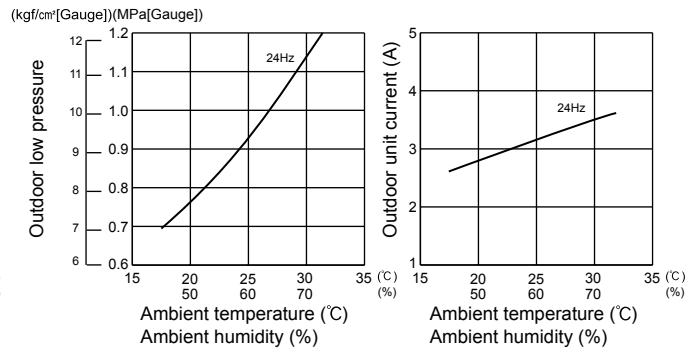

35-class unit

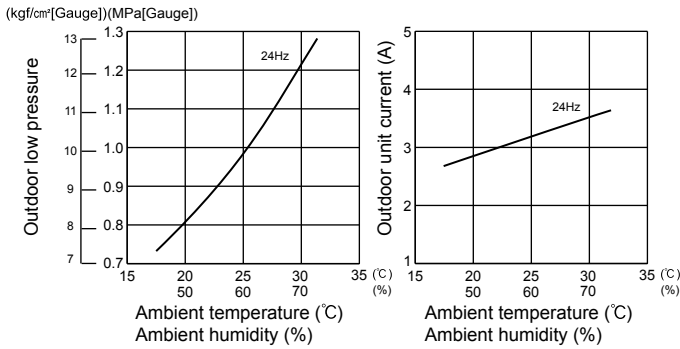

42-class unit

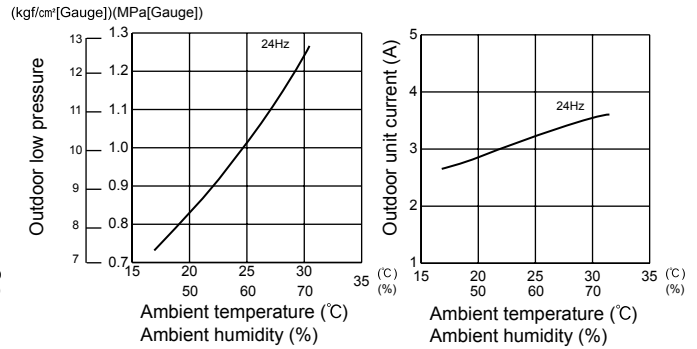

50-class unit

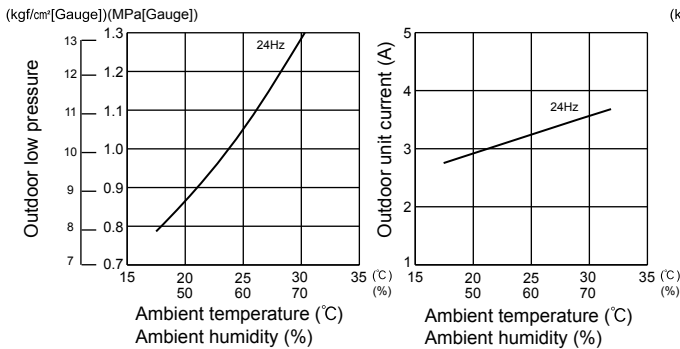

60-class unit

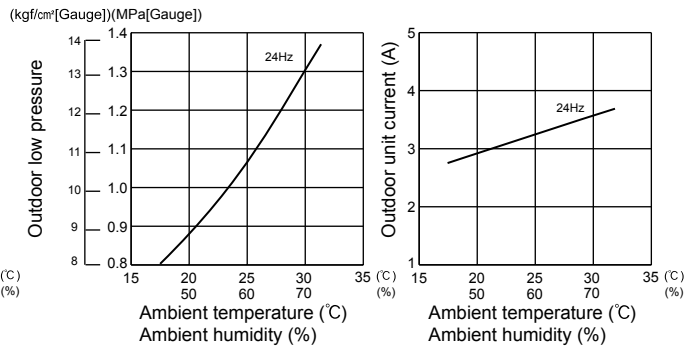

MXZ-5D102VA

71-class unit

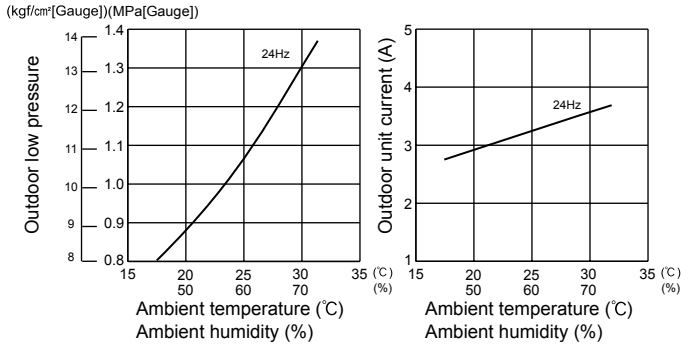

15-class unit

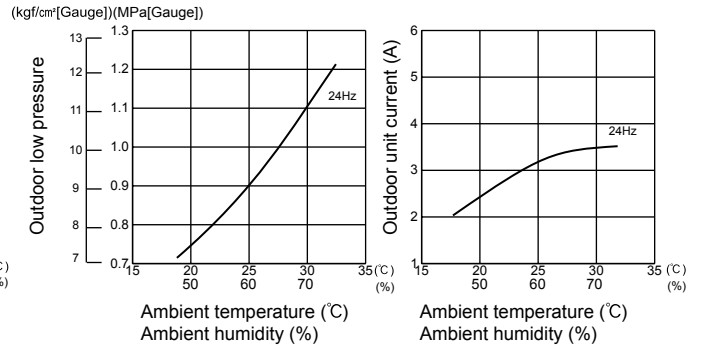

18-class unit

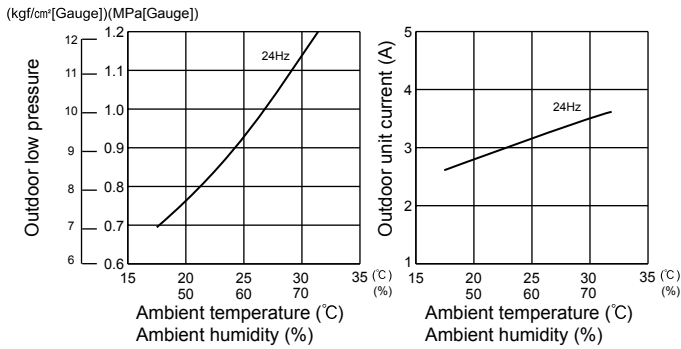

20-class unit

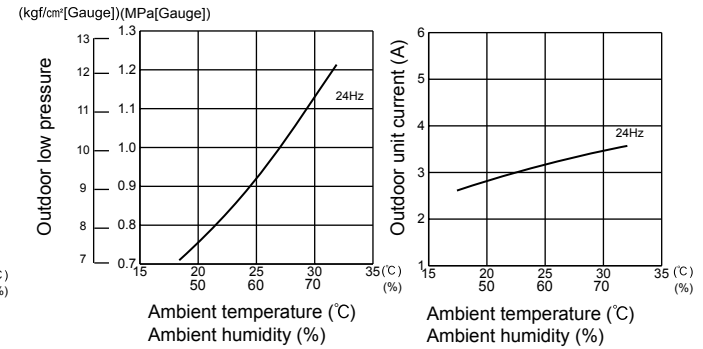

22-class unit

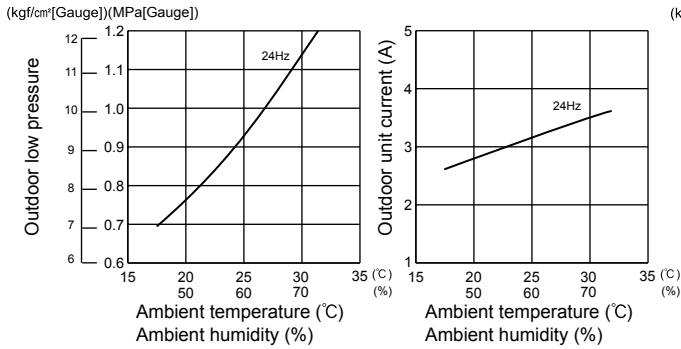

25-class unit

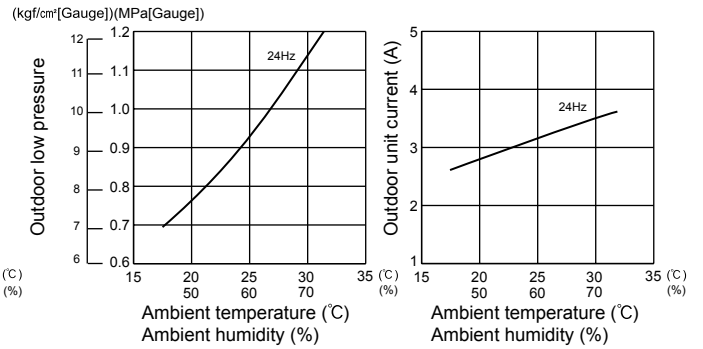

35-class unit

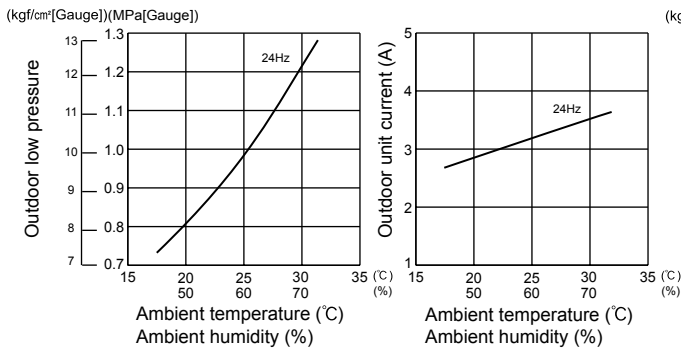

42-class unit

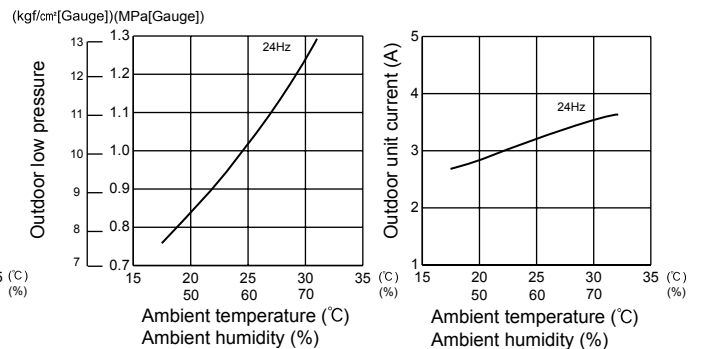

MXZ-5D102VA

50-class unit

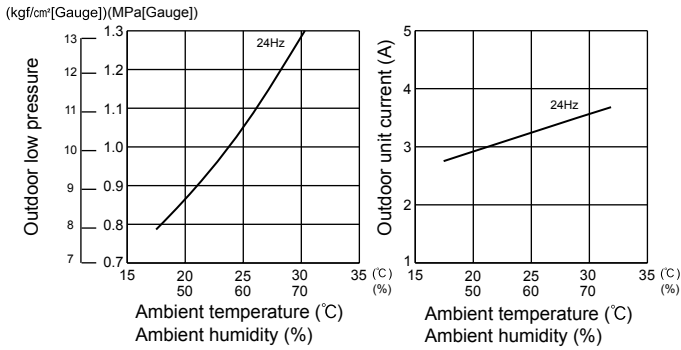

60-class unit

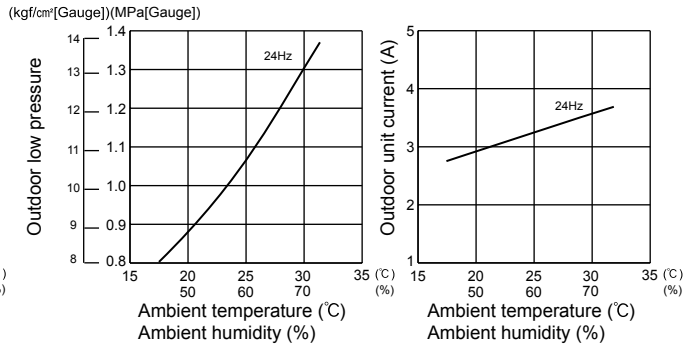

71-class unit

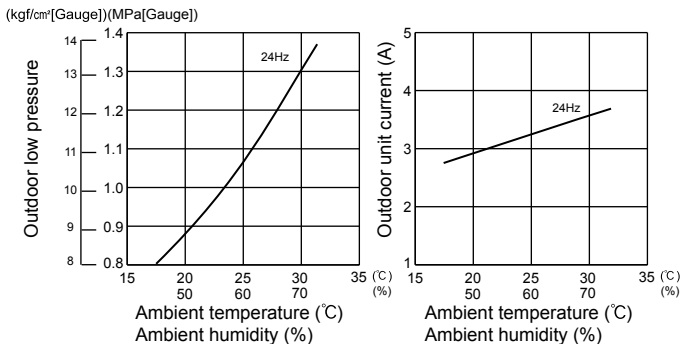

(2) HEAT operation

① Condition :

	Indoor	Outdoor			
Dry bulb temperature (°C)	20.0	2	7	15	20.0
Wet bulb temperature (°C)	14.5	1	6	12	14.5

② Operation : TEST RUN OPERATION (Refer to 8-3.)

MXZ-2D33VA

15-class unit

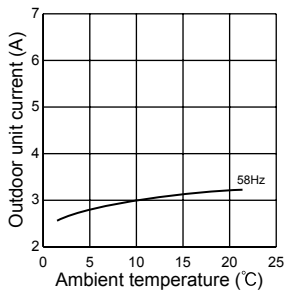

18-class unit

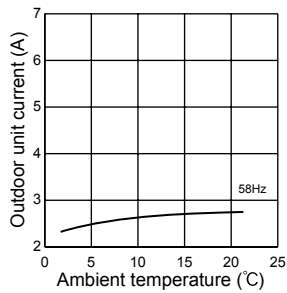

20-class unit

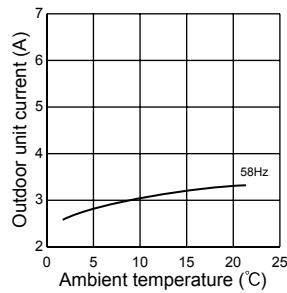

22-class unit

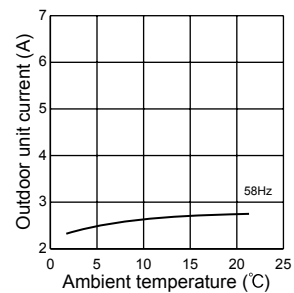

25-class unit

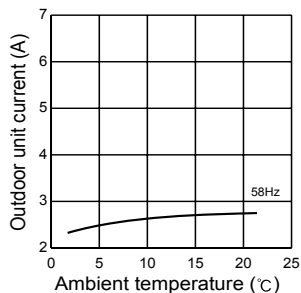

MXZ-2D40VA

15-class unit

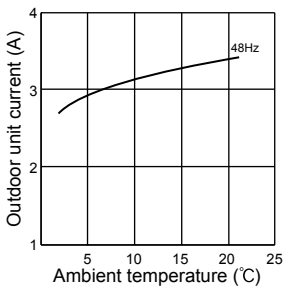

18-class unit

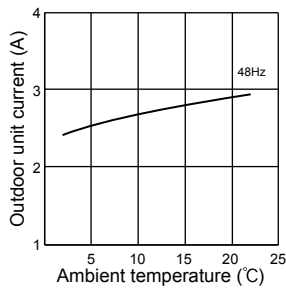

20-class unit

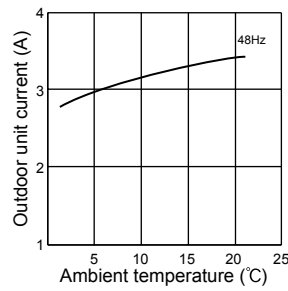

22-class unit

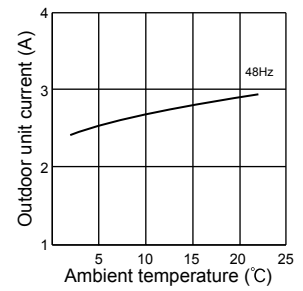

25-class unit

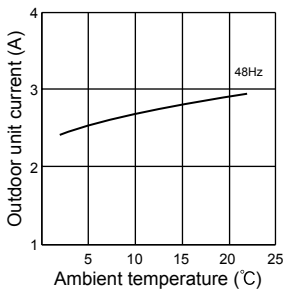

35-class unit

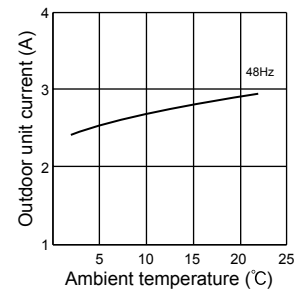

MXZ-2D53VA MXZ-2D53VAH

15-class unit

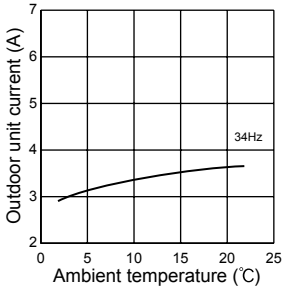

18-class unit

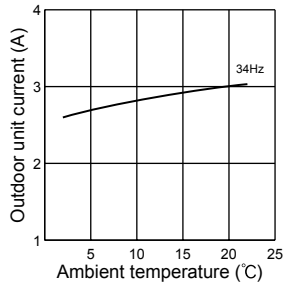

20-class unit

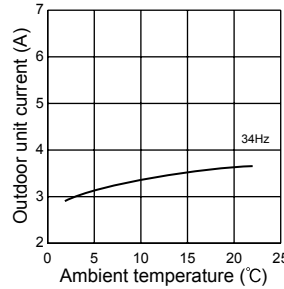

22-class unit

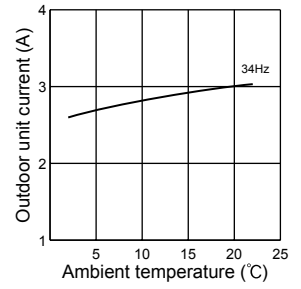

25-class unit

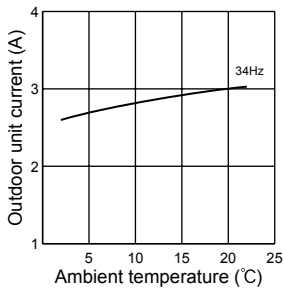

35-class unit

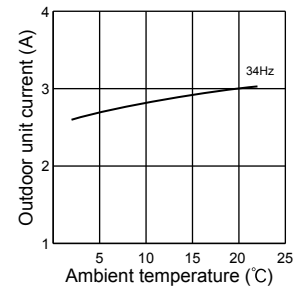

42-class unit

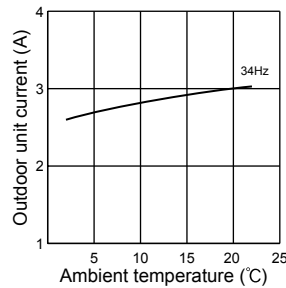

50-class unit

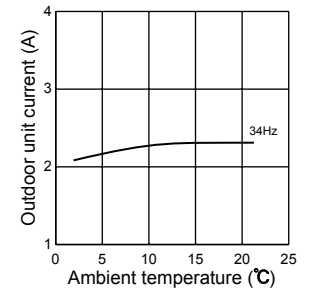

MXZ-3D54VA

15-class unit

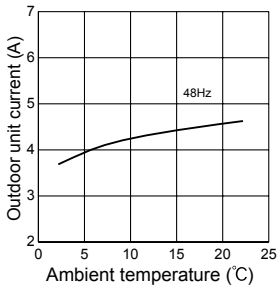

18-class unit

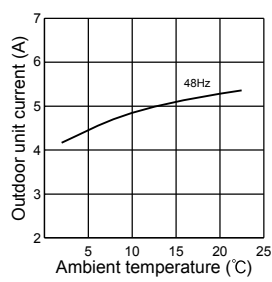

20-class unit

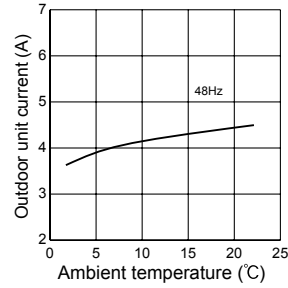

22-class unit

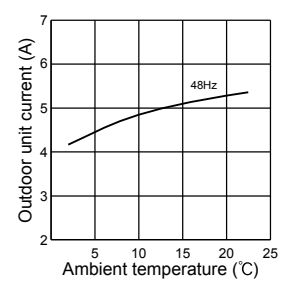

25-class unit

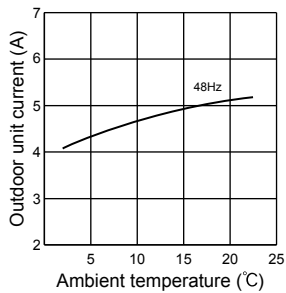

35-class unit

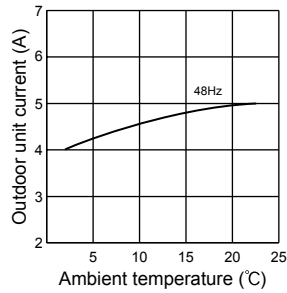

42-class unit

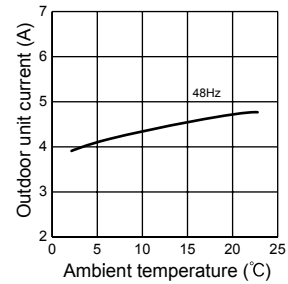

50-class unit

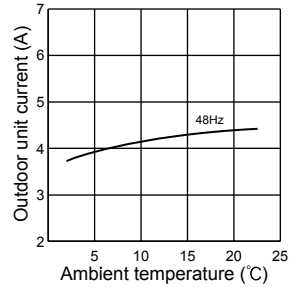

MXZ-3D68VA MXZ-4D72VA

15-class unit

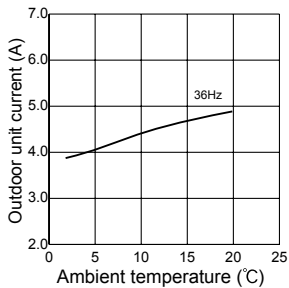

18-class unit

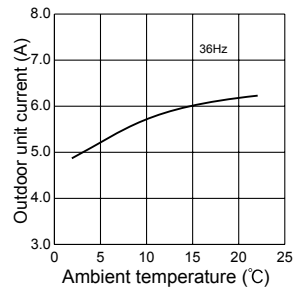

20-class unit

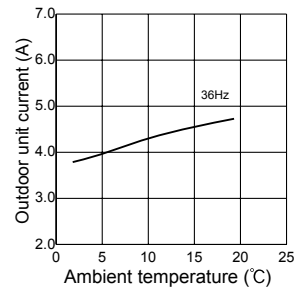

22-class unit

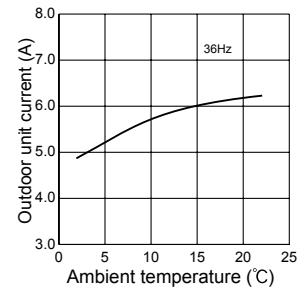

25-class unit

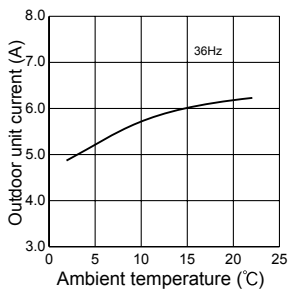

35-class unit

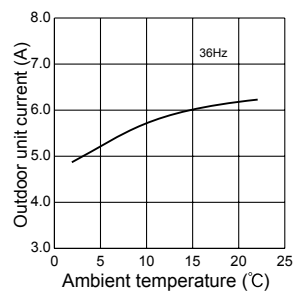

42-class unit

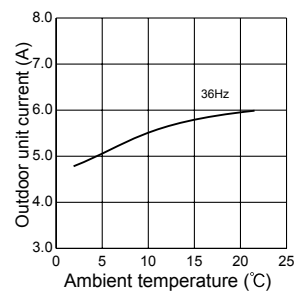

50-class unit

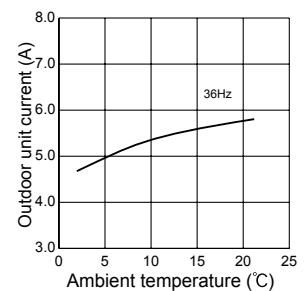

60-class unit

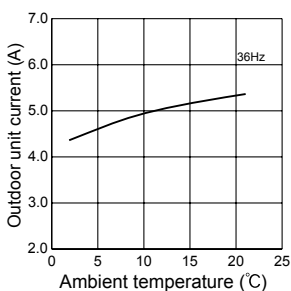

MXZ-4D83VA

15-class unit

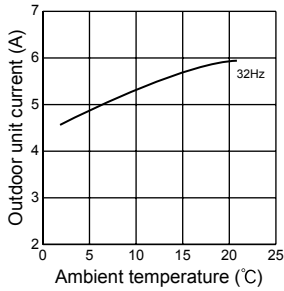

18-class unit

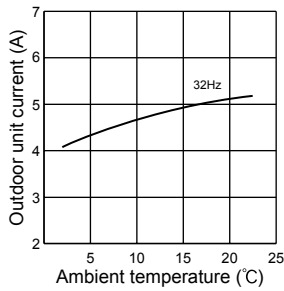

20-class unit

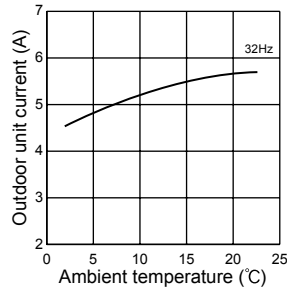

22-class unit

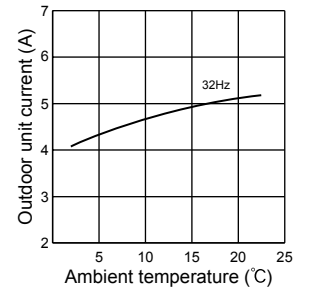

25-class unit

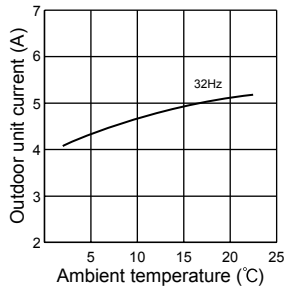

35-class unit

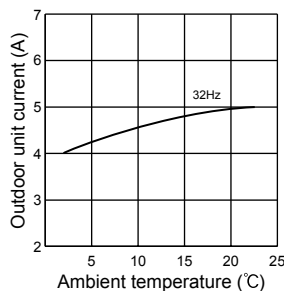

42-class unit

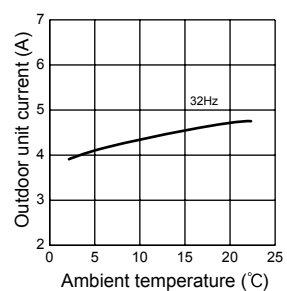

50-class unit

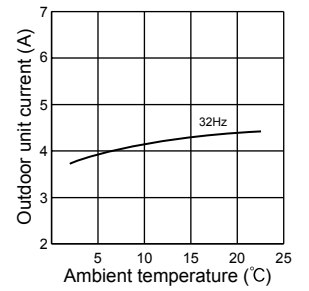

MXZ-5D102VA

60-class unit

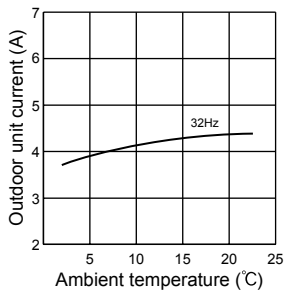

71-class unit

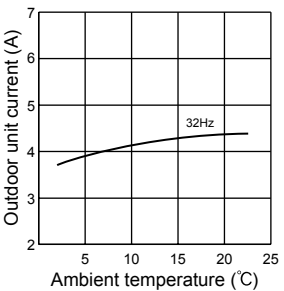

15-class unit

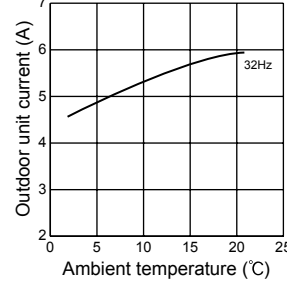

18-class unit

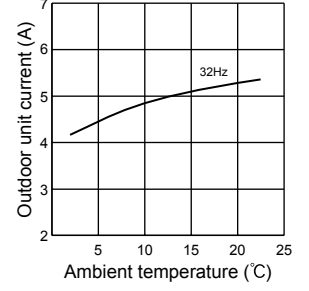

20-class unit

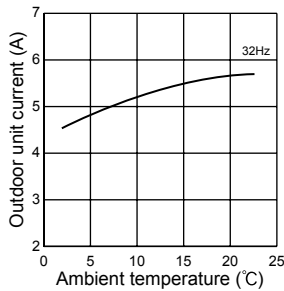

22-class unit

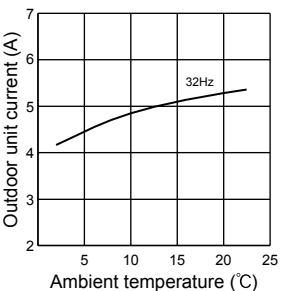

25-class unit

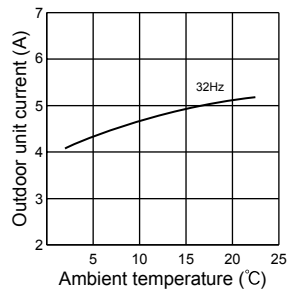

35-class unit

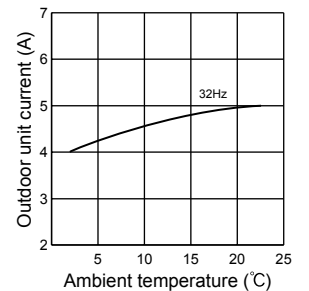

42-class unit

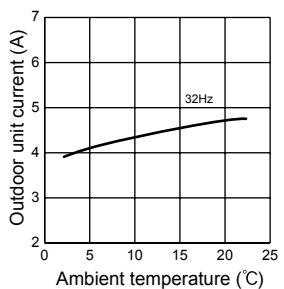

50-class unit

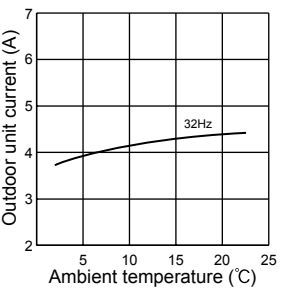

60-class unit

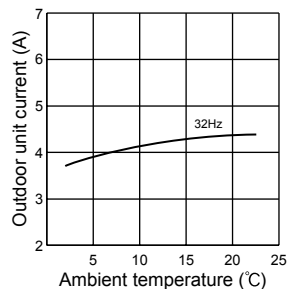

71-class unit

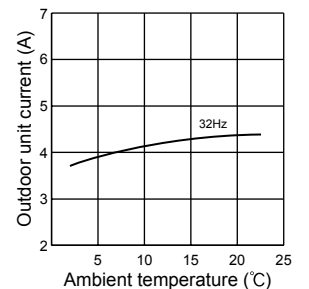

MXZ-2D33VA MXZ-2D40VA MXZ-2D53VA MXZ-2D53VAH
MXZ-3D54VA MXZ-3D68VA MXZ-4D72VA MXZ-4D83VA MXZ-5D102VA

Relation between main sensor and actuator

Sensor	Purpose	Actuator				
		Compressor	LEV	Outdoor fan motor	R.V. coil	Defrost heater *1
Discharge temperature thermistor	Protection	○	○			
Indoor coil temperature thermistor	Cooling: Coil frost prevention	○				
	Heating: High pressure protection	○	○			
Defrost thermistor	Heating: Defrosting	○	○	○	○	
Fin temperature thermistor	Protection	○		○		
Ambient temperature thermistor	Control/Protection	○	○	○		
	Heating: Defrosting (Heater)					○
Outdoor heat exchanger temperature thermistor	Cooling: Control/Protection	○	○	○		
Capacity code	Control	○	○			

*1 **MXZ-2D53VAH** only.

**MXZ-2D33VA MXZ-2D40VA MXZ-2D53VA MXZ-2D53VAH
MXZ-3D54VA MXZ-3D68VA MXZ-4D72VA MXZ-4D83VA MXZ-5D102VA**

10-1. THE POSITION OF SWITCH

MXZ-2D33VA MXZ-2D40VA MXZ-2D53VA MXZ-2D53VAH

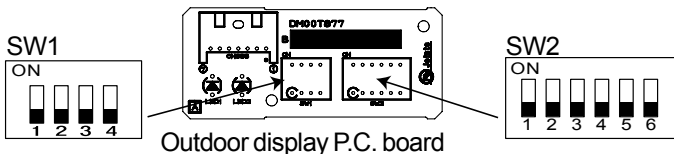

MXZ-3D54/3D68/4D72VA

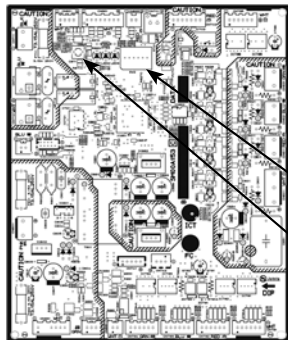

Outdoor control P.C. board

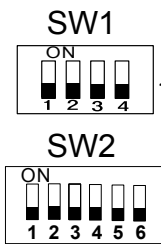

MXZ-4D83/5D102VA

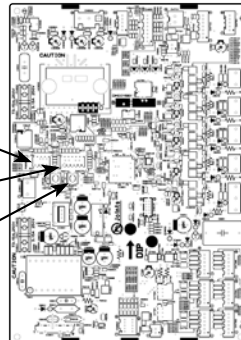

Outdoor control P.C. board

10-2. LOCKING THE OPERATION MODE OF THE AIR CONDITIONER (COOL, DRY, HEAT)

With this function, you can lock the operation mode of the outdoor unit.

Once the operation mode is locked to either COOL/DRY mode or HEAT mode, the air conditioner operates in that mode only.

Default setting is required to activate this function.

Please explain this function to your customers and ask them whether they want to use it.

[How to lock the operation mode]

- (1) Turn OFF the breaker and make sure that the LED goes off.
- (2) Set SW1 or SW2 as shown in the figure below.
- (3) Turn ON the breaker.

**MXZ-2D33VA/2D40VA/2D53VA/2D53VAH
SW1 on the outdoor display P.C. board
MXZ-4D83VA/5D102VA
SW1 on the outdoor control P.C. board**

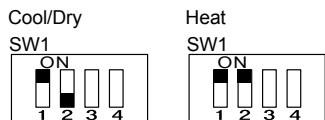

**MXZ-3D54VA/3D68VA/4D72VA
SW2 on the outdoor control P.C. board**

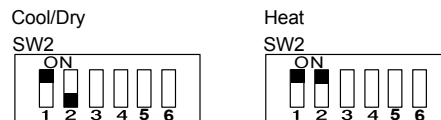

10-3. LOWERING THE OPERATING NOISE OF THE OUTDOOR UNIT

With this function, you can lower the operating noise of the outdoor unit when the operation load is small, for example, during night time in COOL mode.

However, note that the cooling and heating capacity can also be lowered if this function is activated. Default setting is required to activate this function.

Please explain this function to your customers and ask them whether they want to use it.

[How to lower the operating noise]

- (1) Turn OFF the breaker and make sure that the LED goes off.
- (2) Set the "3" Switch of SW1 to ON to enable this function. (MXZ-2D33VA/2D40VA/2D53VA/2D53VAH/4D83VA/5D102VA)
Set the "3" Switch of SW2 to ON to enable this function. (MXZ-3D54VA/3D68VA/4D72VA)
- (3) Turn ON the breaker.

MXZ-2D33VA/2D40VA/2D53VA/2D53VAH
SW1 on the outdoor display P.C. board
MXZ-4D83VA/5D102VA
SW1 on the outdoor control P.C. board

MXZ-3D54VA/3D68VA/4D72VA
SW2 on the outdoor control P.C. board

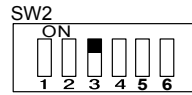

10-4. AUTOMATIC LINE CORRECTING

This outdoor unit has an automatic line correcting function which automatically detects and corrects improper wiring or piping.

<MXZ-2D33VA/2D40VA/2D53VA/2D53VAH>

Improper wiring or piping can be automatically detected when one indoor unit is operated in COOL mode for 30 minutes. When improper wiring or piping is detected, wiring lines are corrected (A to B/ B to A) with the software.

NOTE: This function may not work due to the condition or environment of the unit, such as the following:

- gas leak, closed stop valve
- unit failure such as defective LEV
- indoor/outdoor temperature

NOTE: This function does not work when the "2" of SW2 on the outdoor display P.C. board is turned OFF.

<Correct>

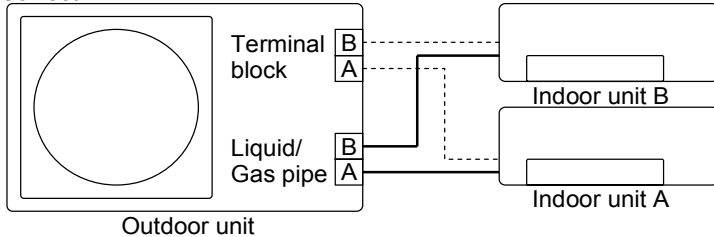

MXZ-2D33VA/2D40VA/2D53VA/2D53VAH
SW2 on the outdoor display P.C. board

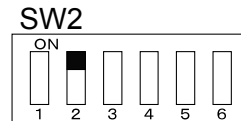

<Incorrect wiring>

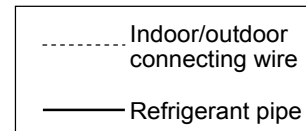
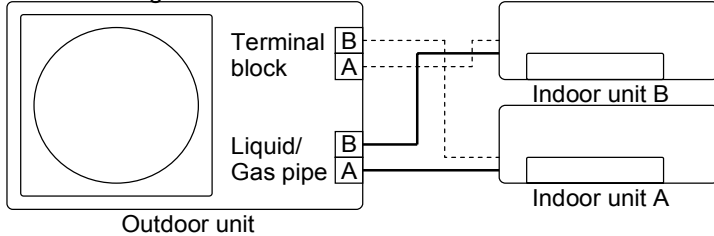

<Incorrect piping>

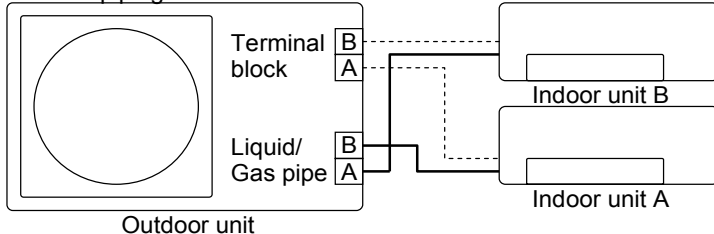

The record of automatic line correcting can be checked in the following way:

- (1) Turn OFF the breaker and make sure that the LED goes off.
- (2) Turn ON the "3" of SW2 on the outdoor display P.C. board.
- (3) Turn ON the breaker.
- (4) Check the correction state with the LED lamps on the outdoor display P.C. board.
- (5) Turn OFF the breaker and make sure that the LED goes off.
- (6) Turn OFF the "3" of SW2 on the outdoor display P.C. board.
- (7) Turn ON the breaker.

Number of blinks		Wiring line
LED1 (Red)	LED2 (Yellow)	
Once	Once	Not corrected
3 times	3 times	Corrected

**MXZ-2D33VA/2D40VA/2D53VA/2D53VAH
SW2 on the outdoor display P.C. board**

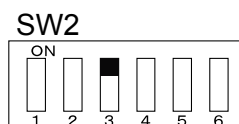

<MXZ-3D54VA/3D68VA/4D72VA/4D83VA/5D102VA>

Improper wiring or piping can be automatically detected by pressing the piping/wiring correction switch (SW871) on the outdoor control P.C. board.

When improper wiring or piping is detected, wiring lines are corrected.

This will be completed in about 10 to 20 minutes.

[How to activate this function]

1. Check that outside temperature is above 0°C.
(This function does not work when outside temperature is not above 0°C.)
2. Check that the stop valves of the liquid pipe and gas pipe are open.
3. Check that the wiring between indoor and outdoor unit is correct.
(If the wiring is not correct, this function does not work.)
4. Turn ON the breaker and wait at least 1 minute.
5. Press the piping/wiring correction switch (SW871) on the outdoor P.C. board.
Do not touch energized parts.

LED indication during detection:

LED1 (Red)	LED2 (Yellow)	LED3 (Green)
Lighted	Lighted	Once

LED indication after detection:

LED1 (Red)	LED2 (Yellow)	LED3 (Green)	Indication
Lighted	Not lighted	Lighted	Completed (Problem corrected/Normal)
Once	Once	Once	Not completed (Detection failed)
Other indications			Refer to "SAFETY PRECAUTIONS WHEN LED FLASHES" located behind the service panel.

Make sure that the valves are open and the pipes are not collapsed or clogged.

6. Press the switch to cancel.

LED indication after cancel:

LED1 (Red)	LED2 (Yellow)	LED3 (Green)
Lighted	Lighted	Not lighted

NOTE: Indoor unit cannot be operated while this function is activated.

When this function is activated while indoor unit is operating, the operation will be stopped.

Operate indoor unit after the automatic line correcting is finished.

Pressing the switch during detection cancels this function.

The record of automatic line correcting can be checked in the following way:

Press the switch for more than 5 seconds

LED will show the record of automatic correcting for about 30 seconds as shown in the table below:

Number of blinks			Wiring line
LED1 (Red)	LED2 (Yellow)	LED3 (Green)	
Once	Once	Lighted	Not corrected
3 times	3 times	Lighted	Corrected

NOTE: Activate this function to check the correct wiring after replacing the outdoor P.C. board.

(Previous records are deleted when the outdoor control P.C. board is replaced.)

The record cannot be shown if automatic line correcting is not cancelled (Refer to "How to activate this function").

10-5. PRE-HEAT CONTROL

If moisture gets into the refrigerant cycle, or when refrigerant is liquefied and collected in the compressor, it may interfere the start-up of the compressor. To improve start-up condition, the compressor is energized even while it is not operating to generate heat at the winding.

The compressor uses about 50 W when pre-heat control is turned ON. Pre-heat control is OFF(**MXZ-2D33VA/2D40VA/2D53VA/2D53VAH**) / ON (**MXZ-3D54VA/3D68VA/4D72VA/4D83VA/5D102VA**) at the default setting.

[How to activate pre-heat control]

- (1) Turn OFF the breaker and make sure that the LED goes off.
- (2) Set the "4" of SW2 as shown figure below to ON to activate pre-heat control function.
- (3) Turn ON the breaker.

MXZ-2D33VA/2D40VA/2D53VA/2D53VAH
SW2 on the outdoor display P.C. board

MXZ-3D54VA/3D68VA/4D72VA
MXZ-4D83VA/5D102VA
SW2 on the outdoor control P.C. board

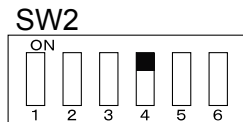

NOTE: Pre-heat control will be turned OFF when the breaker is turned OFF.

10-6. CHANGING THE AMPERE LIMIT

With this function, you can change the current that flows in the outdoor unit.

NOTE: Use this function only when the amount of current exceeds the allowed value.

[How to change the ampere limit]

- (1) Turn OFF the breaker and make sure that the LED goes off.
- (2) Set SW2 as shown in the table below.
- (3) Turn ON the breaker.

MXZ-4D83VA/5D102VA
SW2 on the outdoor control P.C. board

SW2	MXZ-4D83VA/5D102VA
<p>ON</p> <p>1 2 3 4 5 6</p>	10.5 A
<p>ON</p> <p>1 2 3 4 5 6</p>	15.5 A
<p>ON</p> <p>1 2 3 4 5 6</p>	Default setting Full

MXZ-2D33VA MXZ-2D40VA MXZ-2D53VA MXZ-2D53VAH
MXZ-3D54VA MXZ-3D68VA MXZ-4D72VA MXZ-4D83VA MXZ-5D102VA

11-1. CAUTIONS ON TROUBLESHOOTING

1. Before troubleshooting, check the following:

- 1) Check the power supply voltage.
- 2) Check the indoor/outdoor connecting wire for miswiring.

2. Take care of the following during servicing

- 1) Before servicing the air conditioner, be sure to turn OFF the unit first with the remote controller, and after confirming the horizontal vane is closed, turn OFF the breaker and/or disconnect the power plug.
- 2) Be sure to turn OFF the power supply before removing the front panel, the cabinet, the top panel, and the P.C. board.
- 3) When removing the electrical parts, be careful of the residual voltage of smoothing capacitor.
- 4) When removing the P.C. board, hold the edge of the board with care NOT to apply stress on the components.
- 5) When connecting or disconnecting the connectors, hold the housing of the connector. DO NOT pull the lead wires.

<Incorrect>

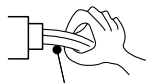

Lead wiring

<Correct>

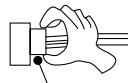

Housing point

3. Troubleshooting procedure

- 1) Check if the OPERATION INDICATOR lamp on the indoor unit is flashing on and off to indicate an abnormality. To make sure, check how many times the OPERATION INDICATOR lamp is flashing on and off before starting service work.
- 2) Before servicing, check that the connector and terminal are connected properly.
- 3) When the P.C. board seems to be defective, check the copper foil pattern for disconnection and the components for bursting and discoloration.
- 4) Refer to 11-2, 11-3 and 11-4.

11-2. FAILURE MODE RECALL FUNCTION

This air conditioner can memorize the abnormal condition which has occurred once.

Even though LED indication listed on the troubleshooting check table (11-4.) disappears, the memorized failure details can be recalled.

1. Flow chart of failure mode recall function for the indoor/outdoor unit

Refer to the service manual of indoor unit.

2. Flow chart of the detailed outdoor unit failure mode recall function

Operational procedure

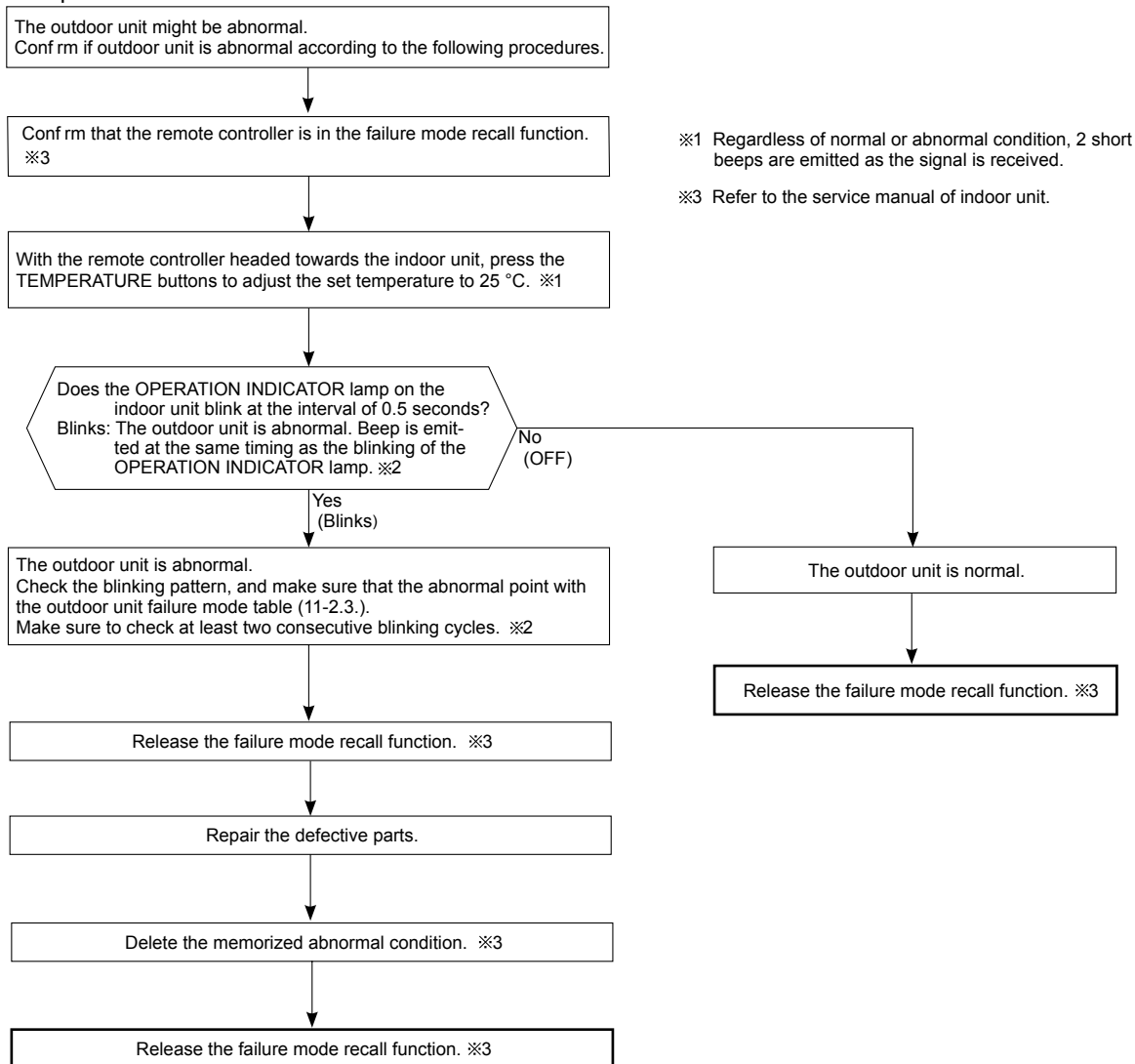

NOTE: 1. Make sure to release the failure mode recall function once it is set up, otherwise the unit cannot operate properly.
2. If the abnormal condition is not deleted from the memory, the last abnormal condition is kept memorized.

※2. Blinking pattern when outdoor unit is abnormal:

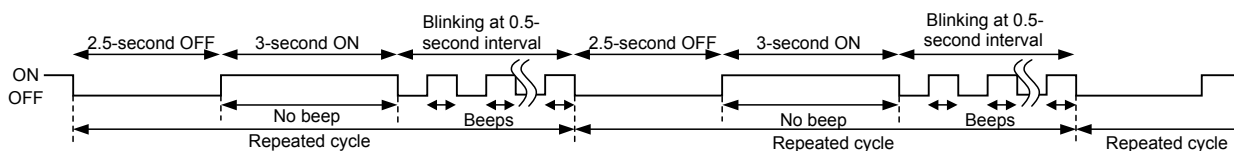

3. Outdoor unit failure mode table

MXZ-2D

Upper or left lamp of OPERATION INDICATOR lamp (Indoor unit)	Abnormal point (Failure mode/protection)	LED indication (Outdoor P.C. board)		Condition	Remedy	Indoor/outdoor unit failure mode recall function	
		LED 1	LED 2				
OFF	None (Normal)	Not lighted	Not lighted	—	—	—	
2-time f ash	Outdoor power system	Lighted	Lighted	Overcurrent protection cut-out operates 3 consecutive times within 1 minute after the compressor gets started. Compressor protection cut-out operates 24 consecutive times within 10 seconds after the compressor gets started.	<ul style="list-style-type: none"> • Check the compressor connecting wire. • Refer to 11-6. ③ "Check of inverter/compressor". • Check the stop valve. 	○	
3-time f ash	Discharge temperature thermistor	Lighted	Once	Thermistor shorts or opens during compressor running.	<ul style="list-style-type: none"> • Refer to 11-6. ③ "Check of outdoor thermistors". 	○	
	Defrost thermistor	Lighted	Once			○	
	Ambient temperature thermistor	Lighted	Twice			○	
	Fin temperature thermistor	Lighted	3 times			○	
	P.C. board temperature thermistor	Lighted	4 times			<ul style="list-style-type: none"> • Replace the inverter P.C. board. 	○
	Outdoor heat exchanger temperature thermistor	Lighted	9 times			<ul style="list-style-type: none"> • Refer to 11-6. ③ "Check of outdoor thermistors". 	○
4-time f ash	Overcurrent	Once	Not lighted	The overcurrent fows into intelligent power module.	<ul style="list-style-type: none"> • Check the compressor connecting wire. • Refer to 11-6. ③ "Check of inverter/compressor". • Check the stop valve. 	—	
	Compressor	Twice	Not lighted	The overcurrent fows into intelligent power module within 10 seconds after the compressor gets started. (The compressor gets restarted in 15 seconds.)	<ul style="list-style-type: none"> • Check the compressor connecting wire. • Refer to 11-6. ③ "Check of inverter/compressor". 	—	
		9 times	Not lighted	Waveform of compressor current is distorted.		—	
5-time f ash	Discharge temperature	Lighted	Lighted	Discharge temperature exceeds 116 °C during operation.	<ul style="list-style-type: none"> • Check refrigerant circuit and refrigerant amount. • Refer to 11-6. ③ "Check of LEV". 	—	
6-time f ash	High pressure	Lighted	Lighted	The outdoor heat exchanger temperature exceeds 70 °C during cooling or the indoor gas pipe temperature exceeds 70 °C during heating.	<ul style="list-style-type: none"> • Check refrigerant circuit and refrigerant amount. • Check the stop valve. 	—	
7-time f ash	Fin temperature	3 times	Not lighted	The f n temperature exceeds 90 °C during operation.	<ul style="list-style-type: none"> • Check around outdoor unit. • Check outdoor unit air passage. 	—	
	P.C. board temperature	4 times	Not lighted	The P.C. board temperature exceeds 80 °C during operation.	<ul style="list-style-type: none"> • Refer to 11-6. ③ "Check of outdoor fan motor". 	—	
8-time f ash	Outdoor fan motor	Lighted	Lighted	Failure occurs 3 consecutive times within 30 seconds after the fan gets started.	<ul style="list-style-type: none"> • Refer to 11-6. ③ "Check of outdoor fan motor". 	—	
9-time f ash	Nonvolatile memory data	Lighted	5 times	Nonvolatile memory data cannot be read properly.	<ul style="list-style-type: none"> • Replace the inverter P.C. board. 	○	
	Power module	7 times	Not lighted	The output of the power module that drove the compressor was shorted or the winding of the compressor was shorted.	<ul style="list-style-type: none"> • Refer to 11-6. ③ "Check of inverter/compressor". 	○	
10-time f ash	Discharge temperature	Lighted	Lighted	The discharge temperature is kept under 50 °C (COOL mode)/40 °C (HEAT mode) for more than 40 minutes.	<ul style="list-style-type: none"> • Check refrigerant circuit and refrigerant amount. • Refer to 11-6. ③ "Check of LEV". 	—	
11-time f ash	Current sensor	8 times	Not lighted	The sensor circuit of current of compressor shorts or opens during compressor operate.	<ul style="list-style-type: none"> • Replace the inverter P.C. board. 	○	
	Bus-bar voltage	6 times	Not lighted	The bus-bar voltage exceeds 430 V or falls to 50 V or below during compressor operating.	<ul style="list-style-type: none"> • Check the power supply. • Replace the inverter P.C. board. 	○	
14-time f ash	Stop valve	Lighted	12 times	The current of compressor is power module is out of order.	<ul style="list-style-type: none"> • Check the stop valve. • Check refrigerant circuit and refrigerant amount. 	○	

NOTE: Blinking patterns of this mode differ from the ones of Troubleshooting check table (11-4).

MXZ-3D/4D/5D

Upper or left lamp of OPERATION INDICATOR lamp (Indoor unit)	Abnormal point (Failure mode/protection)	LED indication (Outdoor P.C. board)		Condition	Remedy	Indoor/outdoor unit failure mode recall function
		LED 1	LED 2			
OFF	None (Normal)	Lighted	Lighted	—	—	—
2-time flash	Outdoor power system	Lighted	Lighted	Overcurrent protection cut-out operates 3 consecutive times within 1 minute after the compressor gets started, or converter protection or bus-bar voltage protection cut-out operates 3 consecutive times within 3 minutes after start-up.	<ul style="list-style-type: none"> Check the connection of the compressor connecting wire. Refer to 11-6. ㉔ "How to check inverter/compressor". Check the stop valve. 	○
3-time flash	Discharge temperature thermistor	Lighted	Once	Thermistor shorts or opens during compressor running.	Refer to 11-6. ㉔ "Check of outdoor thermistors".	○
	Defrost thermistor	Lighted	Once			
	Ambient temperature thermistor	Lighted	Twice			
	Fin temperature thermistor	Lighted	3 times			
	P.C. board temperature thermistor	Lighted	4 times			
Outdoor heat exchanger temperature thermistor	Lighted	9 times	Replace the outdoor control P.C. board.	Refer to 11-6. ㉔ "Check of outdoor thermistors".		
4-time flash	Overcurrent	Once	Not lighted	28 A current flows into intelligent power module.	<ul style="list-style-type: none"> Reconnect compressor connector. Refer to 11-6. ㉔ "How to check inverter/compressor". Check the stop valve. 	—
5-time flash	Discharge temperature	Lighted	Lighted	Discharge temperature exceeds 116°C during operation. Compressor can restart if discharge temperature thermistor reads 100°C or less 3 minutes later.	<ul style="list-style-type: none"> Check refrigerant circuit and refrigerant amount. Refer to 11-6. ㉔ "Check of LEV". 	—
6-time flash	High pressure	Lighted	Lighted	High-pressure is detected with the high-pressure switch (HPS) during operation. (MXZ-3D68/4D72/4D83/5D102VA)	<ul style="list-style-type: none"> Check refrigerant circuit and refrigerant amount. Check the stop valve. 	—
				The outdoor heat exchanger temperature exceeds 70°C during cooling or the indoor gas pipe temperature exceeds 70°C during heating.		
7-time flash	Fin temperature	3 times	Not lighted	The fin temperature exceeds 89°C during operation.	<ul style="list-style-type: none"> Check around outdoor unit. Check outdoor unit air passage. Refer to 11-6. ㉔ "Check of outdoor fan motor". 	—
	P.C. board temperature	4 times	Not lighted	The P.C. board temperature exceeds 73°C (MXZ-3D54/3D68/4D72VA)/ 87°C (MXZ-4D83/5D102VA) during operation.		
8-time flash	Outdoor fan motor	Lighted	Lighted	Failure occurs 3 consecutive times within 30 seconds after the fan gets started.	Refer to 11-6. ㉔ "Check of outdoor fan motor".	—
9-time flash	Nonvolatile memory data	Lighted	5 times	Nonvolatile memory data cannot be read properly.	Replace the outdoor control P.C. board.	○
10-time flash	Discharge temperature	Lighted	Lighted	The frequency of the compressor is kept 80Hz or more and the discharge temperature is kept under 50°C (cooling)/40°C (heating) for more than 40 minutes.	<ul style="list-style-type: none"> Check refrigerant circuit and refrigerant amount. Refer to 11-6. ㉔ "Check of LEV". 	—

NOTE: Blinking patterns of this mode differ from the ones of Troubleshooting check table (11-4).

Upper or left lamp of OPERATION INDICATOR lamp (Indoor unit)	Abnormal point (Failure mode/protection)	LED indication (Outdoor P.C. board)		Condition	Remedy	Indoor/outdoor unit failure mode recall function
		LED 1	LED 2			
11-time flash	Communication error between P.C. boards	Lighted	6 times	Communication error occurs between the electronic control P.C. board and power board for more than 10 seconds.	• Check the connecting wire between the outdoor control P.C. board and the power P.C. board.	—
				The communication between boards protection cut-out operates 2 consecutive times.		○
	Current sensor	Lighted	7 times	A short or open circuit is detected in the current sensor during compressor operating.	• Replace the power P.C. board.	—
				Current sensor protection cut-out operates 2 consecutive times.		○
	Zero cross detecting circuit	5 times	Not lighted	Zero cross signal cannot be detected while the compressor is operating.	• Check the connecting wire between the control P.C. board, the noise filter P.C. board and the power P.C. board.	—
				The protection cut-out of the zero cross detecting circuit operates 10 consecutive times.		○
	Converter	5 times	Not lighted	A failure is detected in the operation of the converter during operation.	• Check the voltage of the power supply. • Replace the power P.C. board.	—
Bus-bar voltage (1)	5 times	Not lighted	The bus-bar voltage exceeds 400 V or falls to 200 V or below during compressor operating.			
Bus-bar voltage (2) ※ Even if this protection stop is performed continuously three times, it does not mean the abnormality in outdoor power system.	6 times	Not lighted	The bus-bar voltage exceeds 400 V (MXZ-3D54/3D68/4D72VA) 430 V (MXZ-4D83/5D102VA) or falls to 50V or below during compressor operating.	• Check the voltage of the power supply. • Replace the outdoor control P.C. board.	—	
15-time flash	LEV and drain pump	Lighted	Lighted	The indoor unit detects an abnormality in the LEV and drain pump.	• Refer to 11-6. ④"Check of LEV". • Check the drain pump of the indoor unit.	—

NOTE: Blinking patterns of this mode differ from the ones of "Troubleshooting check table" (11-4).

11-3. INSTRUCTION OF TROUBLESHOOTING

- Check the indoor unit by referring to the indoor unit service manual, and confirm whether there is any problem in the indoor unit.
- Then, check the outdoor unit by referring to this page.

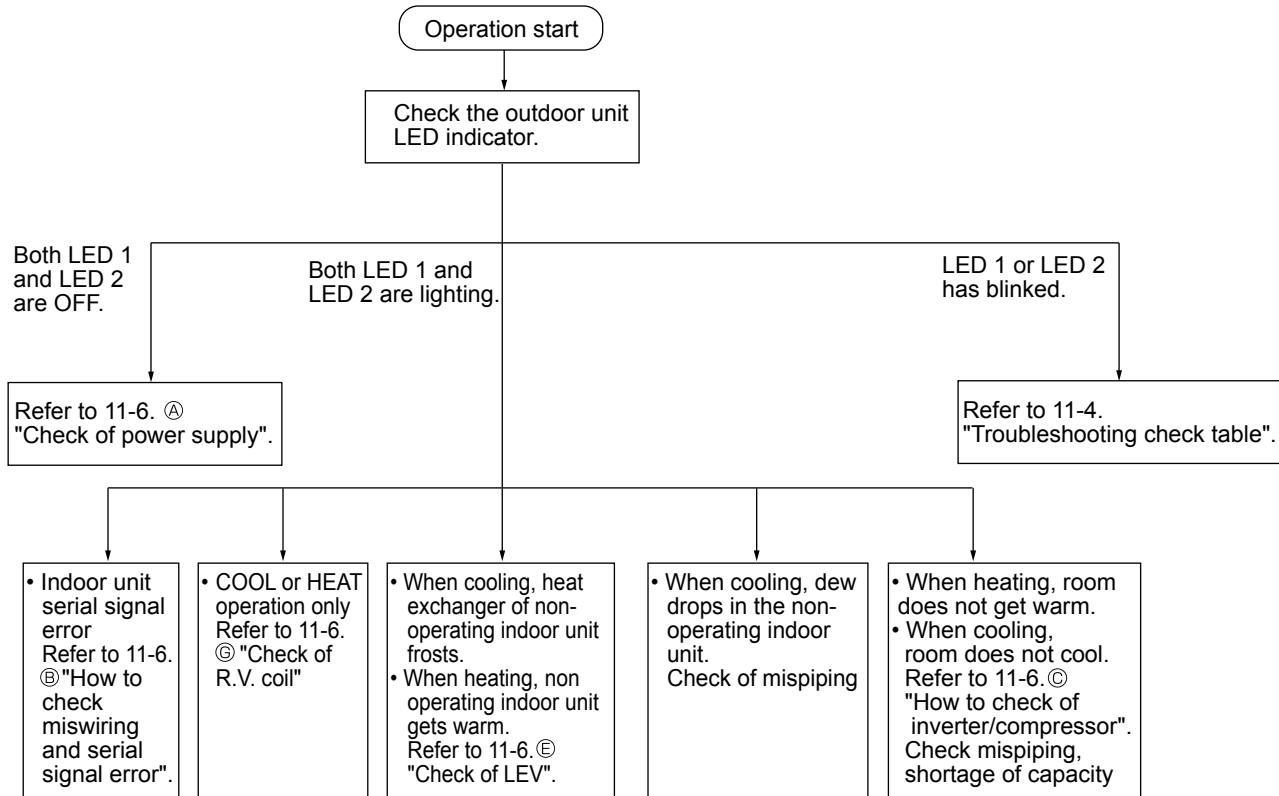

11-4. TROUBLESHOOTING CHECK TABLE

MXZ-2D

No.	Symptom	Indication		Abnormal point / Condition	Condition	Remedy
		LED1(Red)	LED2(Yellow)			
1	Outdoor unit does not operate.	Lighted	Once	LEV and drain pump	The indoor unit detects an abnormality in the LEV and drain pump.	<ul style="list-style-type: none"> Refer to 11-6. ㊦ "Check of LEV". Check the drain pump of the indoor unit.
2		Lighted	Twice	Outdoor power system	Overcurrent protection cut-out operates 3 consecutive times within 1 minute after the compressor gets started.	<ul style="list-style-type: none"> Check the connection of the compressor connecting wire. Refer to 11-6. ㊦ "How to check inverter/compressor". Check the stop valve.
3		Lighted	3 times	Discharge temperature thermistor	A short circuit is detected in the thermistor during operation, or when an open circuit is detected in the thermistor after 10 minutes of compressor start-up.	Refer to 11-6. ㊦ "Check of outdoor thermistors".
4		Lighted	4 times	Fin temperature thermistor P.C. board temperature thermistor	A short or open circuit is detected in the thermistor during operation.	<ul style="list-style-type: none"> Refer to 11-6. ㊦ "Check of outdoor thermistors". Replace the inverter P.C. board.
5		Lighted	5 times	Ambient temperature thermistor	A short or open circuit is detected in the thermistor during operation.	Refer to 11-6. ㊦ "Check of outdoor thermistors".
				Outdoor heat exchanger temperature thermistor	A short circuit is detected in the thermistor during operation, or when an open circuit is detected in the thermistor after 5 minutes (in cooling) and 10 minutes (in heating) of compressor start-up.	
				Defrost thermistor	A short circuit is detected in the thermistor during operation, or when an open circuit is detected in the thermistor after 5 minutes of compressor start-up.	
6	Lighted	7 times	Nonvolatile memory data	The nonvolatile memory data cannot be read properly.	Replace the inverter P.C. board.	
7	Lighted	11 times	Stop valve Closed valve	Closed valve is detected by compressor current. (MXZ-2D33VA, MXZ-2D40VA)	Check the stop valve.	
8	Outdoor unit stops and restarts 3 minutes later' is repeated.	Twice	Not lighted	Overcurrent	14 A (MXZ-2D33VA)/18 A (MXZ-2D40VA, MXZ-2D53VA/H) current flows into intelligent power module.	<ul style="list-style-type: none"> Reconnect compressor connector. Refer to 11-6. ㊦ "How to check inverter/compressor". Check the stop valve.
9		3 times	Not lighted	Discharge temperature protection	Discharge temperature exceeds 116°C during operation. Compressor can restart if discharge temperature thermistor reads 100°C or less 3 minutes later.	<ul style="list-style-type: none"> Check the amount of gas and refrigerant circuit. Refer to 11-6. ㊦ "Check of LEV".
10		4 times	Not lighted	Fin temperature protection	The fin temperature exceeds 90°C during operation.	<ul style="list-style-type: none"> Check refrigerant circuit and refrigerant amount. Refer to 11-6. ㊦ "Check of outdoor fan motor".
				P.C. board temperature protection	The P.C. board temperature exceeds 78°C during operation.	
11		5 times	Not lighted	High-pressure protection	The outdoor heat exchanger temperature exceeds 70°C during cooling or indoor gas pipe temperature exceeds 70°C during heating.	<ul style="list-style-type: none"> Check the amount of gas and the refrigerant circuit. Check the stop valve.
12		9 times	Not lighted	Bus-bar voltage protection	The bus-bar voltage exceeds 430 V or falls to 50 V or below during compressor operating.	Replace the inverter P.C. board.
13		13 times	Not lighted	Outdoor fan motor	Failure occurs 3 consecutive times within 30 seconds after the fan gets started.	Refer to 11-6. ㊦ "Check of outdoor fan motor".
14		8 times	Not lighted	Current sensor protection	A short or open circuit is detected in the current sensor during compressor operating.	Replace the inverter P.C. board.
15		10 times	Not lighted	Compressor	The compressor does not synchronize with the operating power.	<ul style="list-style-type: none"> Reconnect compressor connector. Refer to 11-6. ㊦ "How to check inverter/compressor". Check the stop valve.
16		Once	Lighted	Primary current protection	The input current exceeds 8 A (MXZ-2D33VA)/ 10 A (MXZ-2D40VA, MXZ-2D53VA/H).	<ul style="list-style-type: none"> These symptoms do not mean any abnormality of the product, but check the following points. Check if indoor filters are clogged. Check if refrigerant is short. Check if indoor/outdoor unit air circulation is short cycled.
	Secondary current protection			The current of the compressor exceeds 17 A.		
17	Twice	Lighted	High-pressure protection	The indoor gas pipe temperature exceeds 45°C during heating.	<ul style="list-style-type: none"> Check if indoor filters are clogged. Check if refrigerant is short. Check if indoor/outdoor unit air circulation is short cycled. 	
			Defrosting in cooling	The indoor gas pipe temperature falls 3°C or below during cooling.		
18	3 times	Lighted	Discharge temperature protection	The discharge temperature exceeds 100°C during operation.	<ul style="list-style-type: none"> Check refrigerant circuit and refrigerant amount. Refer to 11-6. ㊦ "Check of LEV". Refer to 11-6. ㊦ "Check of outdoor thermistors". 	
19	4 times	Lighted	Low discharge temperature protection	The frequency of the compressor is kept 68 Hz (MXZ-2D33VA, MXZ-2D40VA)/80 Hz (MXZ-2D53VA/H) or more and the discharge temperature is kept under 50°C (COOL mode)/40°C (HEAT mode) for more than 40 minutes.	<ul style="list-style-type: none"> Refer to 11-6. ㊦ "Check of LEV". Check refrigerant circuit and refrigerant amount. 	



No.	Symptom	Indication		Abnormal point / Condition	Condition	Remedy
		LED1(Red)	LED2(Yellow)			
20	Outdoor unit operates.	5 times	Lighted	Cooling high-pressure protection	The outdoor heat exchanger temperature exceeds 58°C during operation.	This symptom does not mean any abnormality of the product, but check the following points. <ul style="list-style-type: none"> • Check if indoor filters are clogged. • Check if refrigerant is short. • Check if indoor/outdoor unit air circulation is short cycled.
21		8 times	Lighted	Converter protection	A failure is detected in the operation of the converter during operation.	<ul style="list-style-type: none"> • Check the voltage of power supply. • Replace the inverter P.C. board.
22	Outdoor unit operates normally.	9 times	Lighted	Inverter check mode	The connector of compressor is disconnected. Inverter check mode starts.	—
23		Lighted	Lighted	Normal	—	—

NOTE 1. The location of LED is illustrated at the right figure. Refer to 11-7.6.
 2. LED is lighted during normal operation.

Outdoor display P.C. board (Parts side)

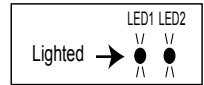

The flashing frequency shows the number of times the LED blinks after every 2.5-second OFF.
 (Example) The flashing frequency is "2".

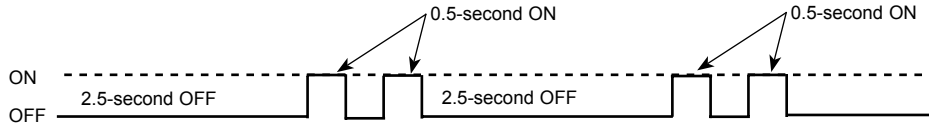

MXZ-3D/4D/5D

No.	Symptom	Indication		Abnormal point / Condition	Condition	Remedy	
		LED1(Red)	LED2(Yellow)				
1	Outdoor unit does not operate.	Lighted	Once	LEV and drain pump	The indoor unit detects an abnormality in the LEV and drain pump.	<ul style="list-style-type: none"> Refer to 11-6. ⑤ "Check of LEV". Check the drain pump of the indoor unit. 	
2		Lighted	Twice	Outdoor power system	Overcurrent protection cut-out operates 3 consecutive times within 1 minute after the compressor gets started, or converter protection or bus-bar voltage protection cut-out operates 3 consecutive times within 3 minutes after start-up.	<ul style="list-style-type: none"> Check the connection of the compressor connecting wire. Refer to 11-6. ⑤ "How to check inverter/compressor". Check the stop valve. 	
3		Lighted	3 times	Discharge temperature thermistor	A short circuit is detected in the thermistor during operation, or an open circuit is detected in the thermistor 10 minutes after compressor start-up.	Refer to 11-6. ⑤ "Check of outdoor thermistors".	
4		Lighted	4 times	Fin temperature thermistor P.C board temperature thermistor	A short or open circuit is detected in the thermistor during operation.	Refer to 11-6. ⑤ "Check of outdoor thermistors".	
						Replace the outdoor control P.C. board.	
5		Lighted	5 times	Ambient temperature thermistor Outdoor heat exchanger temperature thermistor Defrost thermistor	A short or open circuit is detected in the thermistor during operation. A short circuit is detected in the thermistor during operation, or an open circuit is detected in the thermistor 5 minutes (in cooling) and 10 minutes (in heating) after compressor start-up. A short circuit is detected in the thermistor during operation, or an open circuit is detected in the thermistor 5 minutes after compressor start-up.	Refer to 11-6. ⑤ "Check of outdoor thermistors".	
6		Lighted	7 times	Nonvolatile memory data	The nonvolatile memory data cannot be read properly.	Replace the outdoor control P.C. board.	
7		Lighted	8 times	Current sensor	Current sensor protection cut-out operates 2 consecutive times.	Replace the power P.C. board.	
8		Lighted	11 times	Communication error between P.C. boards	Communication error occurs twice between the outdoor control P.C. board and the power P.C. board for more than 10 seconds.	Check the connecting wire between the outdoor control P.C. board and the power P.C. board.	
9		Lighted	12 times	Zero cross detecting circuit	The protection cut-out of the zero cross detecting circuit operates 10 consecutive times.	Check the connecting wire between the outdoor control P.C. board, the noise filter P.C. board and the power P.C. board.	
10		'Outdoor unit stops and restarts 3 minutes later' is repeated.	Twice	Not lighted	IPM protection	Overcurrent is detected 30 seconds after compressor start-up.	<ul style="list-style-type: none"> Reconnect compressor connector. Refer to 11-6. ⑤ "How to check inverter/compressor".
					Lock protection	Overcurrent is detected within 30 seconds after compressor start-up.	Check the stop valve. Check the power module (PAM module).
11			3 times	Not lighted	Discharge temperature protection	Discharge temperature exceeds 116°C during operation. Compressor can restart if discharge temperature thermistor reads 100°C or less 3 minutes later.	Check the amount of gas and refrigerant circuit. Refer to 11-6. ⑤ "Check of LEV".
12	4 times		Not lighted	Fin temperature protection	The fin temperature exceeds 89°C during operation.	Check refrigerant circuit and refrigerant amount.	
				P.C. board temperature protection	The P.C. board temperature exceeds 73°C (MXZ-3D54/3D68/4D72VA)/ 87°C (MXZ-4D83/5D102VA) during operation.	Refer to 11-6. ⑤ "Check of outdoor fan motor".	
13	5 times		Not lighted	High-pressure protection	High-pressure is detected with the high-pressure switch (HPS) during operation. (MXZ-3D68/4D72/4D83/5D102VA)	Check the amount of gas and the refrigerant circuit. Check the stop valve.	
					The outdoor heat exchanger temperature exceeds 70°C during cooling or indoor gas pipe temperature exceeds 70°C during heating.		
	6 times		Not lighted	Pre-heat protection	A failure is detected in the operation of pre-heat. (MXZ-3D54/3D68/4D72VA)	Replace the power P.C. board.	
14	8 times		Not lighted	Converter protection	A failure is detected in the operation of the converter during operation.	Replace the power P.C. board.	
15	9 times		Not lighted	Bus-bar voltage protection (1)	The bus-bar voltage falls to 200 V or below during compressor operating.	Check the voltage of power supply.	
				Bus-bar voltage protection (2)	The bus-bar voltage exceeds 400 V (MXZ-3D54/3D68/4D72VA)/ 430 V (MXZ-4D83/5D102VA) or falls to 50 V or below while the compressor is operating.	Replace the power P.C. board or the outdoor control P.C. board. Refer to 11-6. ① "Check of bus-bar voltage".	
16	13 times		Not lighted	Outdoor fan motor	Failure occurs 3 consecutive times within 30 seconds after the fan gets started.	Refer to 11-6. ⑤ "Check of outdoor fan motor".	
17	Lighted		8 times	Current sensor protection	A short or open circuit is detected in the current sensor while the compressor is operating.	Replace the power P.C. board.	
18	Lighted	11 times	Communication protection between P.C. boards	Communication error occurs between the outdoor control P.C. board and the power P.C. board for more than 10 seconds.	Check the connecting wire between the outdoor control P.C. board and the power P.C. board.		
19	Lighted	12 times	Zero cross detecting circuit protection	Zero cross signal cannot be detected while the compressor is operating.	Check the connecting wire between the outdoor control P.C. board, the noise filter P.C. board and the power P.C. board.		

No.	Symptom	Indication		Abnormal point / Condition	Condition	Remedy
		LED1(Red)	LED2(Yellow)			
20	Outdoor unit operates.	Once	Lighted	Primary current protection	The primary current exceeds 15 A (MXZ-3D54/3D68/4D72VA)/17 A (MXZ-4D83VA)/18 A (MXZ-5D102VA).	<ul style="list-style-type: none"> • These symptoms do not mean any abnormality of the product, but check the following points. • Check indoor filters are not clogged. • Check there is sufficient refrigerant. • Check indoor/outdoor unit air circulation is not short cycling.
				Secondary current protection	The current of the compressor exceeds 12 A (MXZ-3D54VA) /12.5A (MXZ-3D68/4D72VA) /10 A (MXZ-4D83/5D102VA).	
		Twice	Lighted	High-pressure protection	The indoor gas pipe temperature exceeds 45°C during heating.	
				Defrosting in cooling	The indoor gas pipe temperature falls 3°C or below during cooling.	
		3 times	Lighted	Discharge temperature protection	The discharge temperature exceeds 100°C during operation.	
21	Twice	Lighted	Low discharge temperature protection	The frequency of the compressor is kept 80 Hz or more and the discharge temperature is kept under 50°C (cooling) /40°C (heating) for more than 40 minutes.	<ul style="list-style-type: none"> • Refer to 11-6. Ⓔ "Check of LEV". • Check refrigerant circuit and refrigerant amount. 	
22			3 times	Lighted	Cooling high-pressure protection	The outdoor heat exchanger temperature exceeds 58°C during operation.
23	4 times	Lighted	Inverter check mode	The unit is operated with emergency operation switch.	—	
24	5 times	Lighted	Normal	—	—	
25	Outdoor unit operates normally.	9 times	Lighted	Normal	—	—
26	Lighted	Lighted	Normal	—	—	—

NOTE 1. The location of LED is illustrated at the right figure. Refer to 11-7.2.
 2. LED is lighted during normal operation.

Outdoor control P.C. board(Parts side)

The flashing frequency shows the number of times the LED blinks after every 2.5-second OFF.
 (Example) When the flashing frequency is "2".

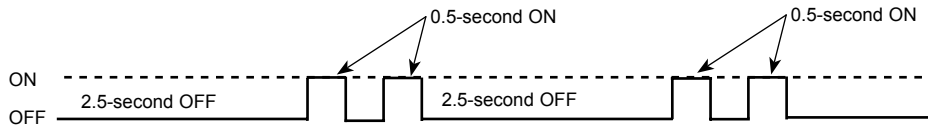

MXZ-3D54/3D68/4D72VA

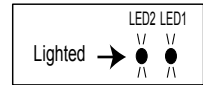

MXZ-4D83/5D102VA



11-5. TROUBLE CRITERION OF MAIN PARTS

MXZ-2D33VA MXZ-2D40VA MXZ-2D53VA MXZ-2D53VAH

MXZ-3D54VA MXZ-3D68VA MXZ-4D72VA MXZ-4D83VA MXZ-5D102VA

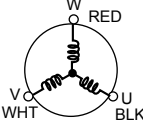
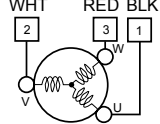
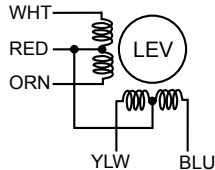
Part name	Check method and criterion												
Defrost thermistor (RT61)	Measure the resistance with a tester.												
Fin temperature thermistor (RT64)	Refer to 11-7. "TEST POINT DIAGRAM AND VOLTAGE" 1. "Inverter P.C. board", 2. "Outdoor control P.C. board " or 3. "Outdoor power P.C. board" for the chart of thermistor.												
Ambient temperature thermistor (RT65)													
Outdoor heat exchanger temperature thermistor (RT68)													
Discharge temperature thermistor (RT62)	Measure the resistance with a tester. Before measurement, hold the thermistor with your hands to warm it up. Refer to 11-7. "TEST POINT DIAGRAM AND VOLTAGE" 1. "Inverter P.C. board", 2. "Outdoor control P.C. board ", for the chart of thermistor.												
Compressor	Measure the resistance between terminals with a tester. (Winding temperature : -10 °C ~ 40 °C)												
	<table border="1"> <thead> <tr> <th colspan="4">Normal (Each phase)</th> </tr> </thead> <tbody> <tr> <td>MXZ-2D33VA MXZ-2D40VA</td> <td>MXZ-2D53VA MXZ-2D53VAH MXZ-3D54VA</td> <td>MXZ-3D68VA MXZ-4D72VA</td> <td>MXZ-4D83VA MXZ-5D102VA</td> </tr> <tr> <td>1.49 Ω ~ 1.84 Ω</td> <td>0.86 Ω ~ 1.06 Ω</td> <td>0.63 Ω ~ 0.78 Ω</td> <td>1.29 Ω ~ 1.49 Ω</td> </tr> </tbody> </table>	Normal (Each phase)				MXZ-2D33VA MXZ-2D40VA	MXZ-2D53VA MXZ-2D53VAH MXZ-3D54VA	MXZ-3D68VA MXZ-4D72VA	MXZ-4D83VA MXZ-5D102VA	1.49 Ω ~ 1.84 Ω	0.86 Ω ~ 1.06 Ω	0.63 Ω ~ 0.78 Ω	1.29 Ω ~ 1.49 Ω
	Normal (Each phase)												
MXZ-2D33VA MXZ-2D40VA	MXZ-2D53VA MXZ-2D53VAH MXZ-3D54VA	MXZ-3D68VA MXZ-4D72VA	MXZ-4D83VA MXZ-5D102VA										
1.49 Ω ~ 1.84 Ω	0.86 Ω ~ 1.06 Ω	0.63 Ω ~ 0.78 Ω	1.29 Ω ~ 1.49 Ω										
Outdoor fan motor	Measure the resistance between lead wires with a tester. (Part temperature : -10 °C ~ 40 °C)												
 <p>MXZ-2D33VA/40VA/53VA MXZ-2D53VAH MXZ-4D83VA/5D102VA</p>	<table border="1"> <thead> <tr> <th colspan="2">Normal (Each phase)</th> </tr> </thead> <tbody> <tr> <td>MXZ-2D</td> <td>MXZ-4D83VA MXZ-5D102VA</td> </tr> <tr> <td>12 Ω ~ 16 Ω</td> <td>13.4 Ω ~ 16.4 Ω</td> </tr> </tbody> </table>	Normal (Each phase)		MXZ-2D	MXZ-4D83VA MXZ-5D102VA	12 Ω ~ 16 Ω	13.4 Ω ~ 16.4 Ω						
Normal (Each phase)													
MXZ-2D	MXZ-4D83VA MXZ-5D102VA												
12 Ω ~ 16 Ω	13.4 Ω ~ 16.4 Ω												
Outdoor fan motor MXZ-3D54VA/3D68VA/4D72VA	Refer to 11-6. ㊦.												
R.V. coil	Measure the resistance with a tester. (Part temperature : -10 °C ~ 40 °C)												
	<table border="1"> <thead> <tr> <th colspan="2">Normal</th> </tr> </thead> <tbody> <tr> <td>MXZ-2D33VA MXZ-2D40VA MXZ-2D53VA MXZ-2D53VAH MXZ-4D83VA MXZ-5D102VA</td> <td>MXZ-3D54VA MXZ-3D68VA MXZ-4D72VA</td> </tr> <tr> <td>1.2 kΩ ~ 1.56 kΩ</td> <td>1.26 kΩ ~ 1.62 kΩ</td> </tr> </tbody> </table>	Normal		MXZ-2D33VA MXZ-2D40VA MXZ-2D53VA MXZ-2D53VAH MXZ-4D83VA MXZ-5D102VA	MXZ-3D54VA MXZ-3D68VA MXZ-4D72VA	1.2 kΩ ~ 1.56 kΩ	1.26 kΩ ~ 1.62 kΩ						
Normal													
MXZ-2D33VA MXZ-2D40VA MXZ-2D53VA MXZ-2D53VAH MXZ-4D83VA MXZ-5D102VA	MXZ-3D54VA MXZ-3D68VA MXZ-4D72VA												
1.2 kΩ ~ 1.56 kΩ	1.26 kΩ ~ 1.62 kΩ												
Linear expansion valve	Measure the resistance with a tester. (Part temperature : -10 °C ~ 40 °C)												
	<table border="1"> <thead> <tr> <th>Color of lead wire</th> <th>Normal</th> </tr> </thead> <tbody> <tr> <td>WHT - RED</td> <td rowspan="4">37.4 Ω ~ 53.9 Ω</td> </tr> <tr> <td>RED - ORN</td> </tr> <tr> <td>YLW - RED</td> </tr> <tr> <td>RED - BLU</td> </tr> </tbody> </table>	Color of lead wire	Normal	WHT - RED	37.4 Ω ~ 53.9 Ω	RED - ORN	YLW - RED	RED - BLU					
Color of lead wire	Normal												
WHT - RED	37.4 Ω ~ 53.9 Ω												
RED - ORN													
YLW - RED													
RED - BLU													
High pressure switch (HPS) MXZ-3D68VA/4D72VA MXZ-4D83VA/5D102VA	<table border="1"> <thead> <tr> <th rowspan="2">HPS</th> <th>Pressure</th> <th>Normal</th> </tr> </thead> <tbody> <tr> <td>3.7 ± 0.3 MPa</td> <td>Close</td> </tr> <tr> <td>4.8 ± 0.2 MPa</td> <td>Open</td> </tr> </tbody> </table>	HPS	Pressure	Normal	3.7 ± 0.3 MPa	Close	4.8 ± 0.2 MPa	Open					
HPS	Pressure		Normal										
	3.7 ± 0.3 MPa	Close											
4.8 ± 0.2 MPa	Open												
Defrost heater MXZ-2D53VAH	Measure the resistance with a tester. (Part temperature : -10 °C ~ 40 °C)												
	<table border="1"> <thead> <tr> <th>Normal</th> </tr> </thead> <tbody> <tr> <td>349 Ω ~ 428 Ω</td> </tr> </tbody> </table>	Normal	349 Ω ~ 428 Ω										
Normal													
349 Ω ~ 428 Ω													

11-6. TROUBLESHOOTING FLOW

• When outdoor unit does not operate, LED on outdoor P.C. board is not lighting.

Ⓐ Check of power supply

MXZ-2D33VA/2D40VA/2D53VA/2D53VAH

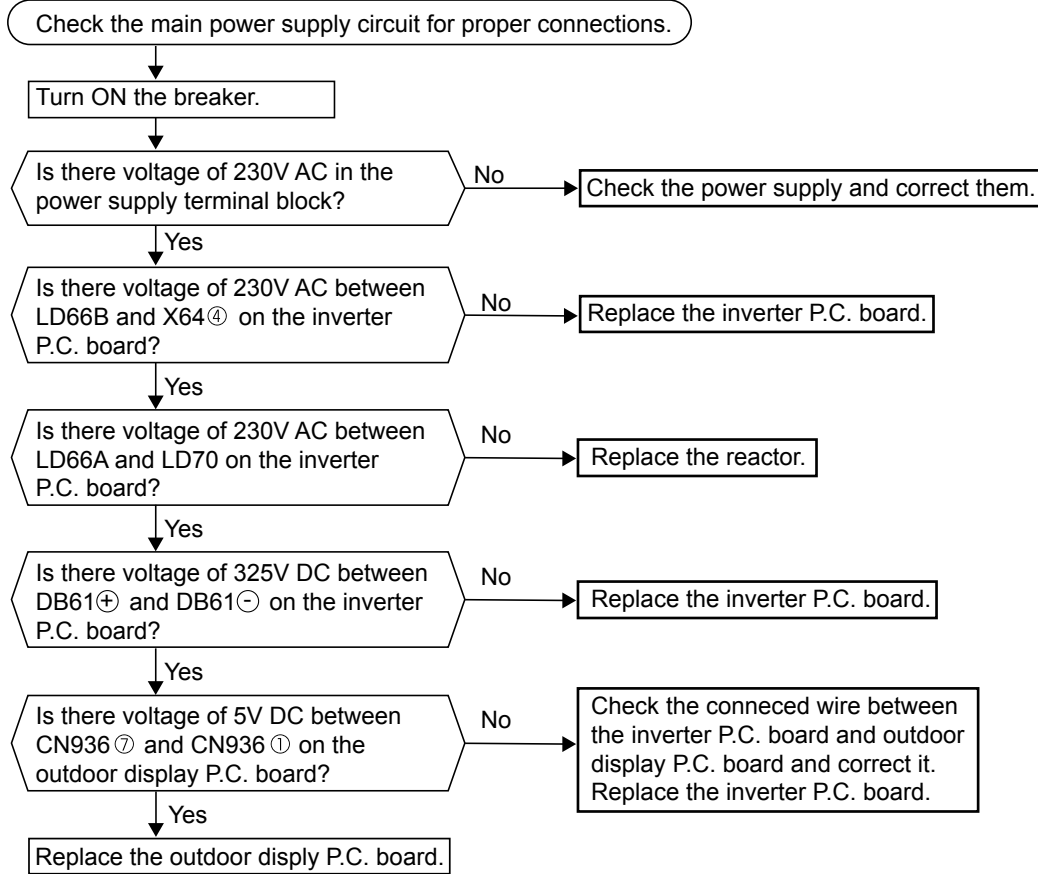

MXZ-3D54VA/3D68VA/4D72/4D83VA/5D102VA

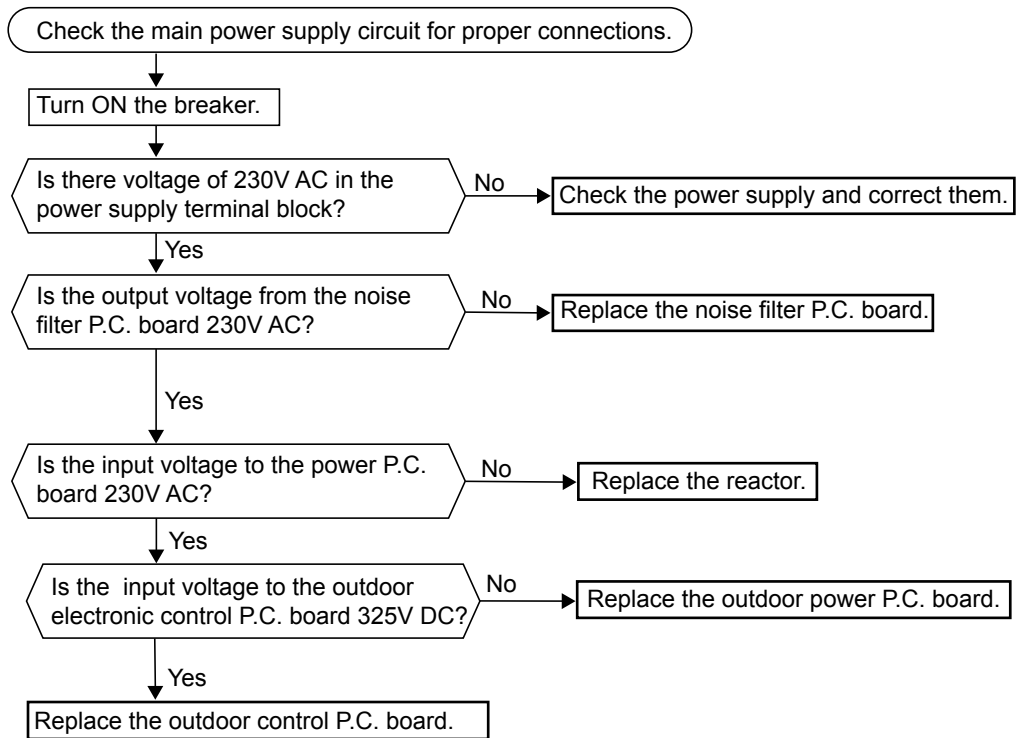

- When the indoor unit does not operate, it cannot be operated either with the remote controller or with the **EMERGENCY OPERATION** switch.
- When the outdoor unit does not operate, the **OPERATION INDICATOR** lamp on the indoor unit flashes **ON and OFF every 0.5-second**.

Ⓑ How to check miswiring and serial signal error (when outdoor unit does not work)

LED indication for communication status

Communication status is indicated by the LED.

Unit status

Blinking: normal communication
 Lighted: abnormal communication or not connected
 Not lighted: The outdoor P.C. board is abnormal.
 NOTE: "Lighted" and "Not lighted" in the table below does not indicate abnormal.

MXZ-2D33/2D40/2D53VA/2D53VAH

Outdoor display P.C. board

LED1 LED2

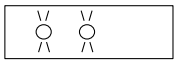

LED 1	LED 2
Unit A status	Unit B status

MXZ-3D54/3D68/4D72VA

Outdoor control P.C. board

LED3 LED2 LED1

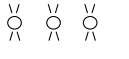

Blinking

Pattern	LED 3	LED 2	LED 1
1	Lighted	Unit B status	Unit A status
2	Not lighted	Unit D status	Unit C status

MXZ-4D83/5D102VA

Outdoor control P.C. board

LED3 LED2 LED1



Blinking

Pattern	LED 1	LED 2	LED 3
1	Unit A status	Unit B status	Unit C status
2	Unit D status	Unit E status	Not lighted

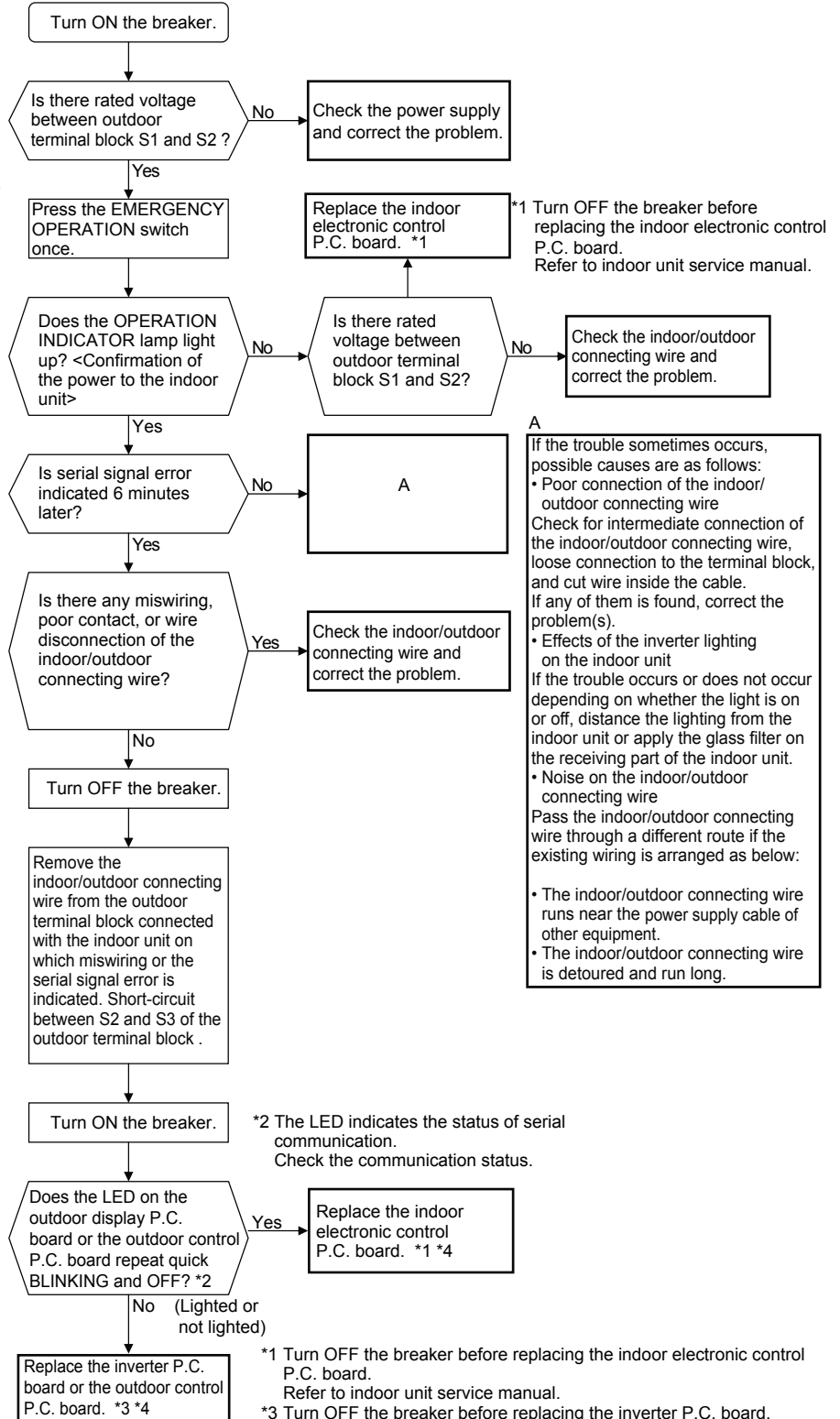

A
 If the trouble sometimes occurs, possible causes are as follows:
 • Poor connection of the indoor/outdoor connecting wire
 Check for intermediate connection of the indoor/outdoor connecting wire, loose connection to the terminal block, and cut wire inside the cable. If any of them is found, correct the problem(s).
 • Effects of the inverter lighting on the indoor unit
 If the trouble occurs or does not occur depending on whether the light is on or off, distance the lighting from the indoor unit or apply the glass filter on the receiving part of the indoor unit.
 • Noise on the indoor/outdoor connecting wire
 Pass the indoor/outdoor connecting wire through a different route if the existing wiring is arranged as below:
 • The indoor/outdoor connecting wire runs near the power supply cable of other equipment.
 • The indoor/outdoor connecting wire is detoured and run long.

*2 The LED indicates the status of serial communication.
 Check the communication status.

*1 Turn OFF the breaker before replacing the indoor electronic control P.C. board.
 Refer to indoor unit service manual.

*3 Turn OFF the breaker before replacing the inverter P.C. board.
 Be careful of residual voltage of smoothing capacitor.

*4 Remove the short-circuit between outdoor terminal block S2 and S3. Connect the indoor/outdoor connecting wire.

- In heating, the room does not get warm.
- In cooling, the room does not get cool.

© How to check inverter/compressor

Disconnect the connector (CNMC) between the inverter P.C. board/the outdoor control P.C. board and compressor, or disconnect the terminal of the compressor.
3 minutes after turning ON the breaker, start EMERGENCY OPERATION.

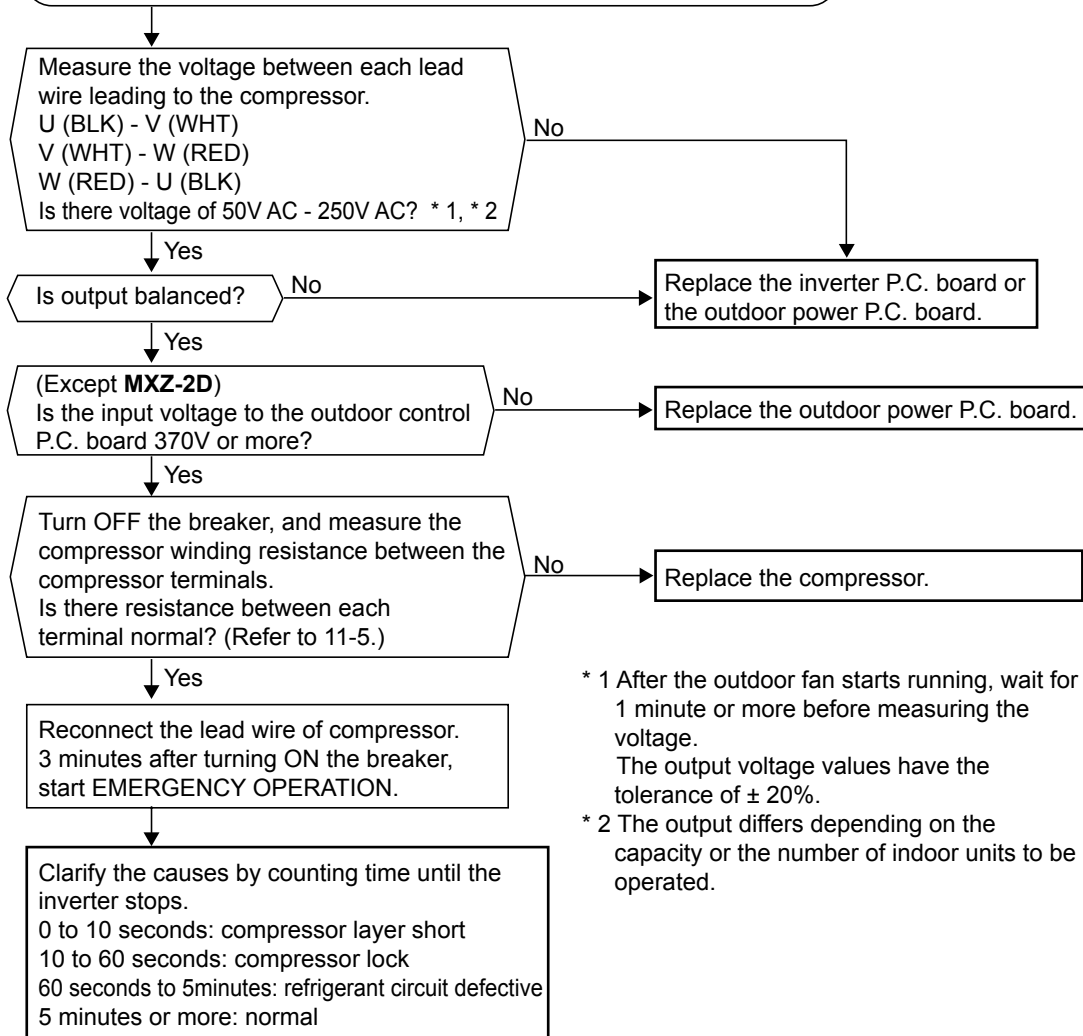

* 1 After the outdoor fan starts running, wait for 1 minute or more before measuring the voltage.
The output voltage values have the tolerance of $\pm 20\%$.

* 2 The output differs depending on the capacity or the number of indoor units to be operated.

• The thermistor is abnormal.

① Check of outdoor thermistors

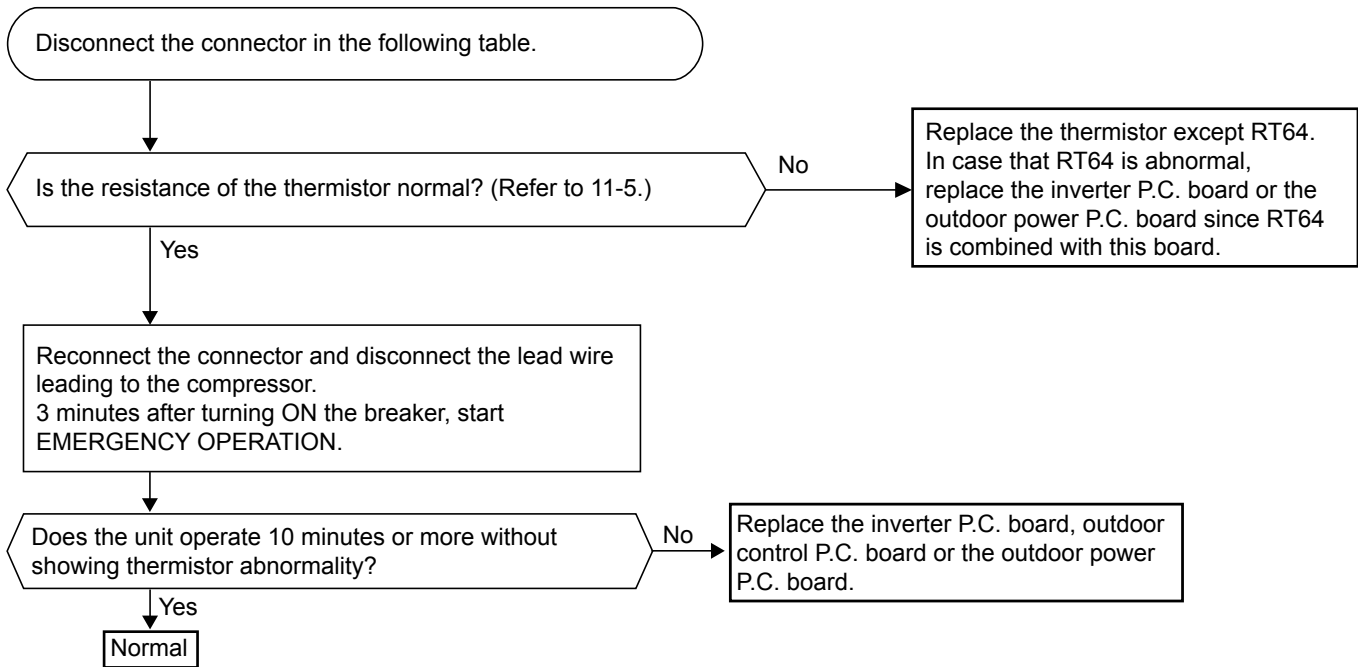

MXZ-2D30/2D40/2D53VA/2D53VAH

Thermistor	Symbol	Connector, Pin No.	Board
Defrost	RT61	CN641 pin1 and pin2	Inverter P.C. board
Discharge temperature	RT62	CN641 pin3 and pin4	
Fin temperature	RT64	CN642 pin1 and pin2	
Ambient temperature	RT65	CN643 pin1 and pin2	
Outdoor heat exchanger temperature	RT68	CN644 pin1 and pin3	

MXZ-3D54/3D68/4D72VA

Thermistor	Symbol	Connector, Pin No.	Board
Defrost	RT61	CN661 pin1 and pin2	Outdoor control P.C. board
Discharge temperature	RT62	CN661 pin3 and pin4	Outdoor power P.C. board
Fin temperature	RT64	CN9 pin1 and pin2	
Ambient temperature	RT65	CN665 pin1 and pin2	Outdoor control P.C. board
Outdoor heat exchanger temperature	RT68	CN661 pin7 and pin8	

MXZ-4D83/5D102VA

Thermistor	Symbol	Connector, Pin No.	Board
Defrost	RT61	CN661 pin1 and pin2	Outdoor control P.C. board
Discharge temperature	RT62	CN661 pin3 and pin4	
Fin temperature	RT64	CN3 pin1 and pin2	Outdoor power P.C. board
Ambient temperature	RT65	CN661 pin7 and pin8	Outdoor control P.C. board
Outdoor heat exchanger temperature	RT68	CN663 pin1 and pin2	



- In cooling, the heat exchanger of non-operating indoor unit has frosted.
- In heating, non-operating indoor unit gets warm.

Ⓔ Check of LEV

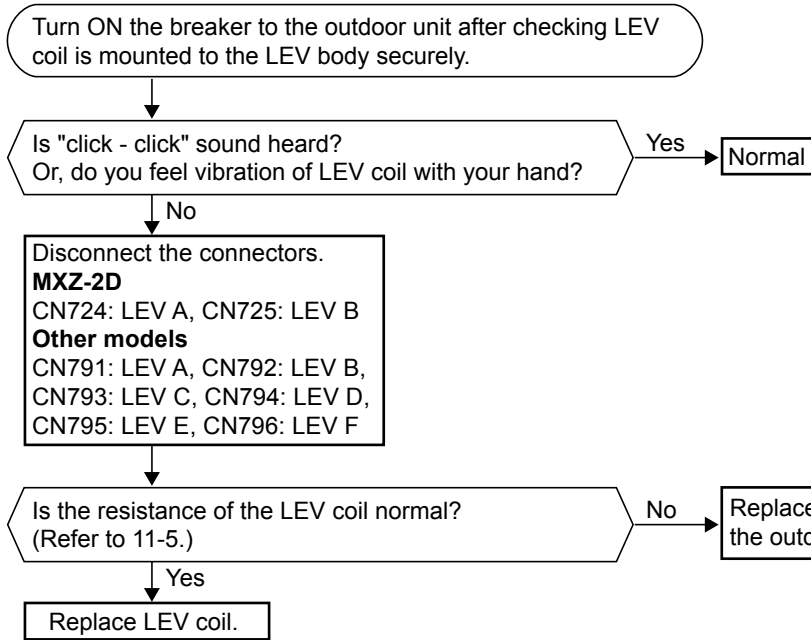

	MXZ-2D	MXZ-3D/4D/5D
CN724 CN725	Inverter P.C. board	Outdoor control P.C. board
CN793 CN794 CN795 CN796	_____	

• Fan motor does not operate or stops operating shortly after starting the operation.

Ⓕ Check of outdoor fan motor

MXZ-2D33VA/2D40VA/2D53VA/2D53VAH
MXZ-4D83VA/5D102VA

	MXZ-2D	MXZ-4D83VA/5D102VA
CN931	Inverter P.C. board	Outdoor control P.C. board
CN932	Inverter P.C. board	Outdoor control P.C. board

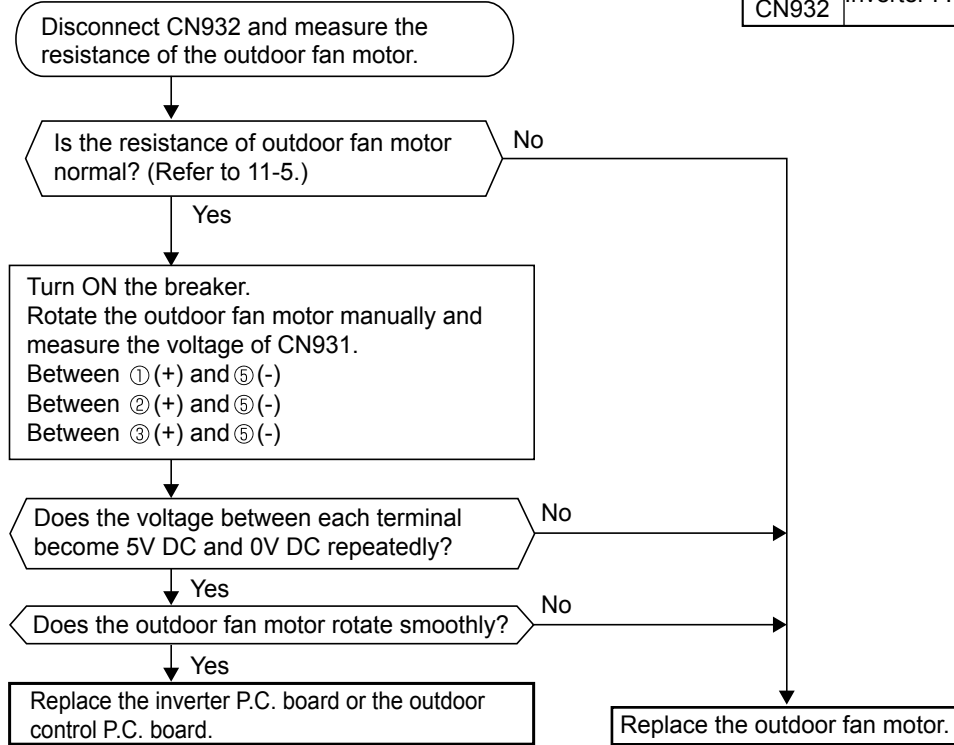

MXZ-3D54VA/3D68VA/4D72VA

	MXZ-3D54VA/3D68VA/4D72VA
CN931	Outdoor control P.C. board

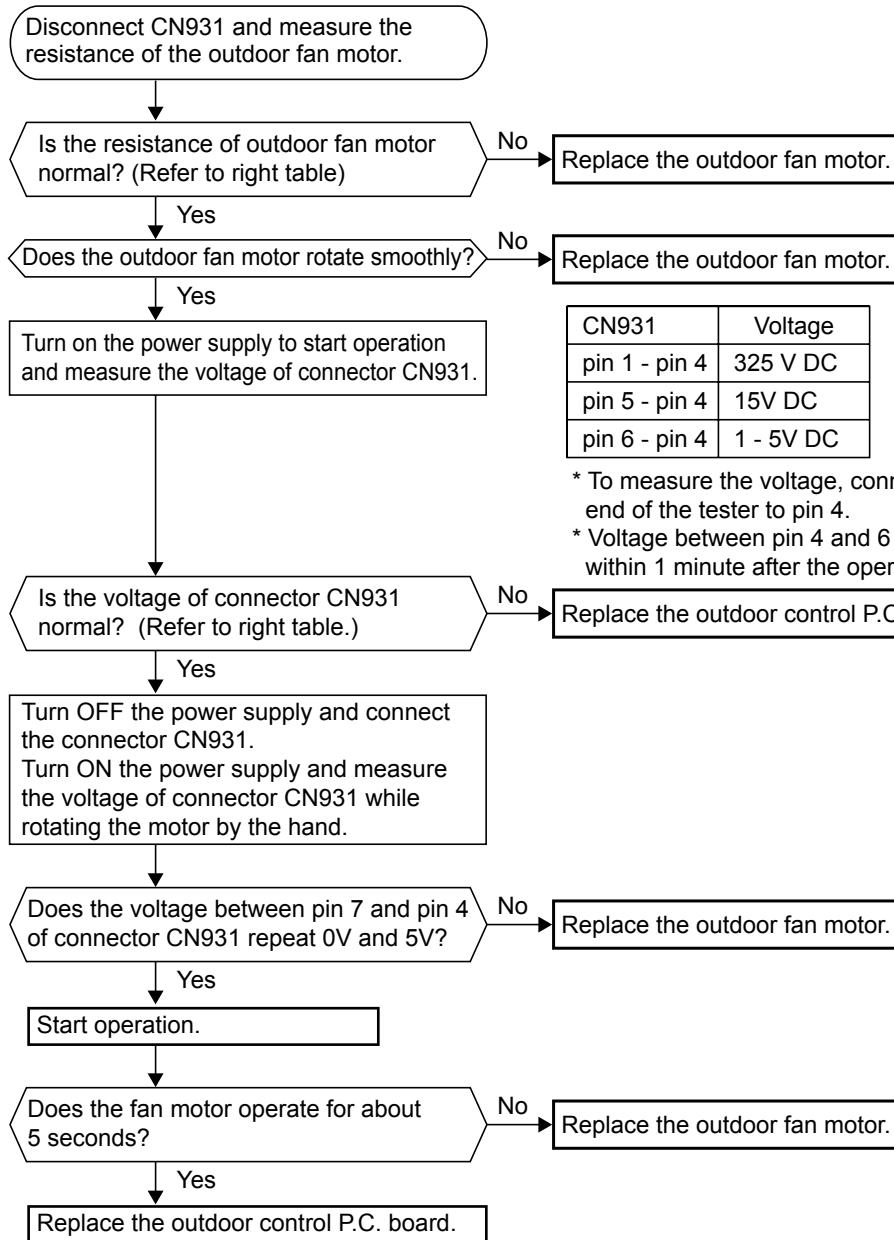

Measuring points	Resistance
pin 1 - pin 4	∞
pin 5 - pin 4	60 kΩ
pin 6 - pin 4	160 kΩ
pin 7 - pin 4	∞

* To measure the resistance, connect the negative (-) end of the tester to pin 4.

CN931	Voltage
pin 1 - pin 4	325 V DC
pin 5 - pin 4	15V DC
pin 6 - pin 4	1 - 5V DC

* To measure the voltage, connect the negative (-) end of the tester to pin 4.

* Voltage between pin 4 and 6 should be measured within 1 minute after the operation starts.

The cooling operation or the heating operation does not operate.

© Check of R.V. coil

MXZ-2D33VA/2D40VA/2D53VA/2D53VAH

	MXZ-2D
CN721	Inverter P.C. board

• The heating operation does not operate.

1. Disconnect the lead wire leading to the compressor.
2. 3 minutes after turning ON the breaker, start EMERGENCY OPERATION in HEAT mode.

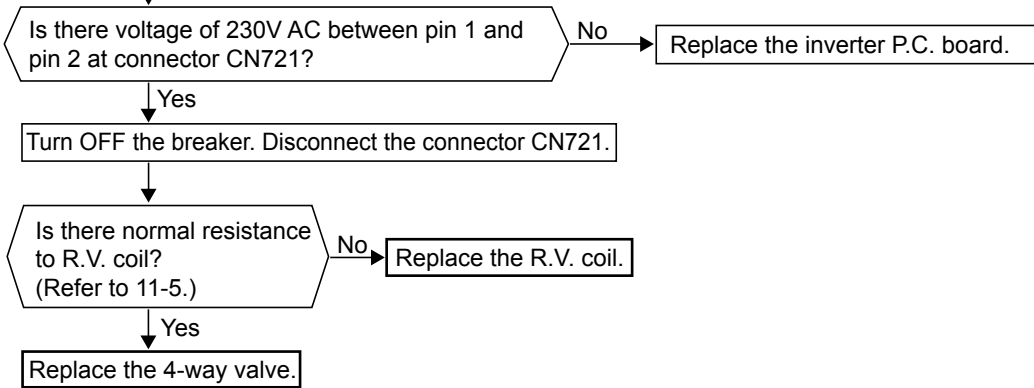

• The cooling operation does not operate.

1. Disconnect the lead wire leading to the compressor.
2. 3 minutes after turning ON the breaker, start EMERGENCY OPERATION in COOL mode.

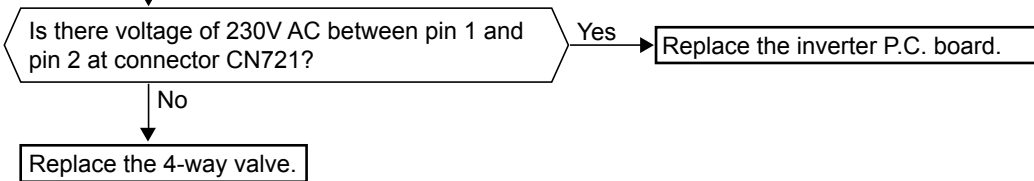

MXZ-3D54VA/3D68VA/4D72VA

• When heating operation does not work.

1. Disconnect the lead wire leading to the compressor.
2. 3 minutes after turning ON the breaker, start EMERGENCY OPERATION in HEAT mode.

	MXZ-3D54VA/3D68VA/4D72VA
CN711 CN712	Outdoor control P.C. board

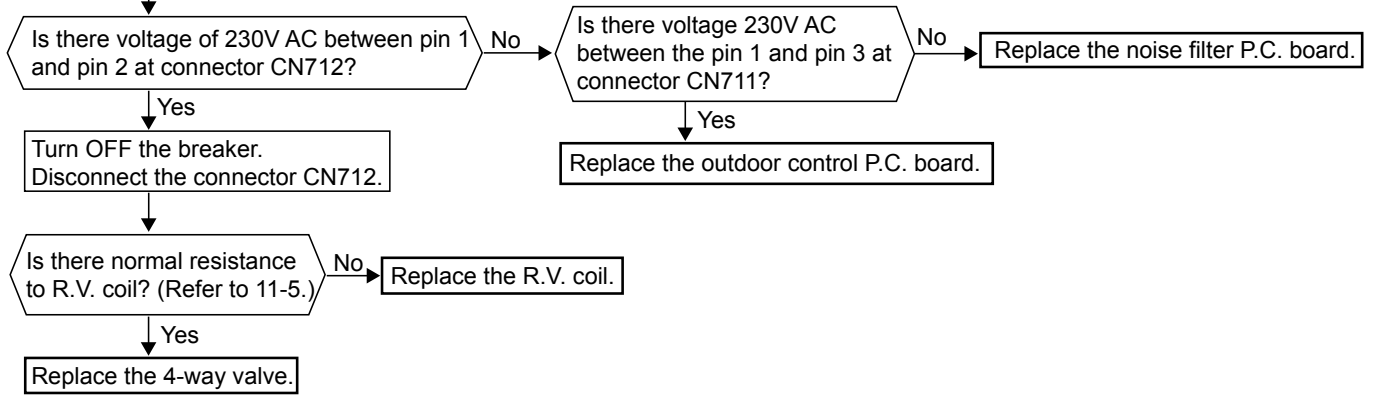

• When cooling operation does not work.

1. Disconnect the lead wire leading to the compressor.
2. 3 minutes after turning ON the breaker, start EMERGENCY OPERATION in COOL mode.

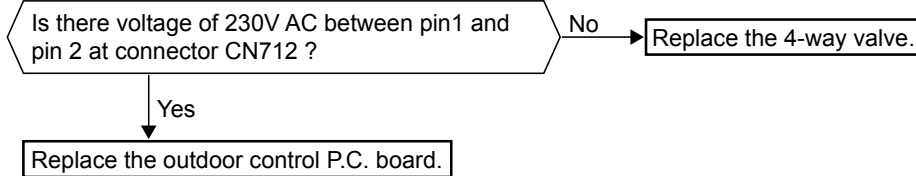

MXZ-4D83VA/5D102VA

	MXZ-4D83/5D102VAVA
CN721	Outdoor control P.C. board

• When heating operation does not work.

1. Disconnect the lead wire leading to the compressor.
2. 3 minutes after turning ON the breaker, start EMERGENCY OPERATION in HEAT mode.

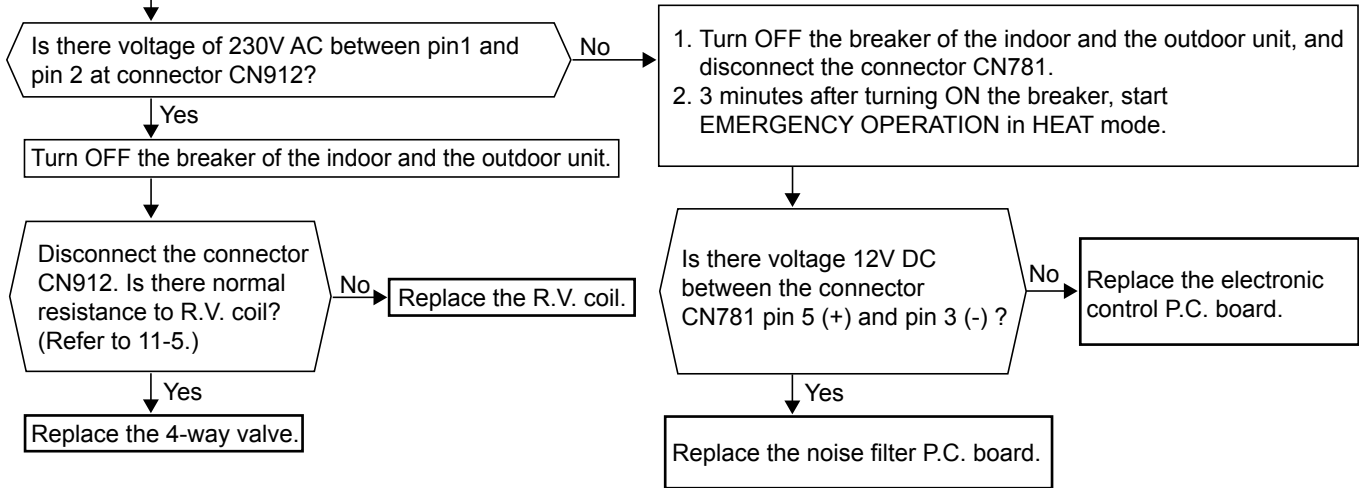

• When cooling operation does not work.

1. Disconnect the lead wire leading to the compressor.
2. 3 minutes after turning ON the breaker, start EMERGENCY OPERATION in COOL mode.

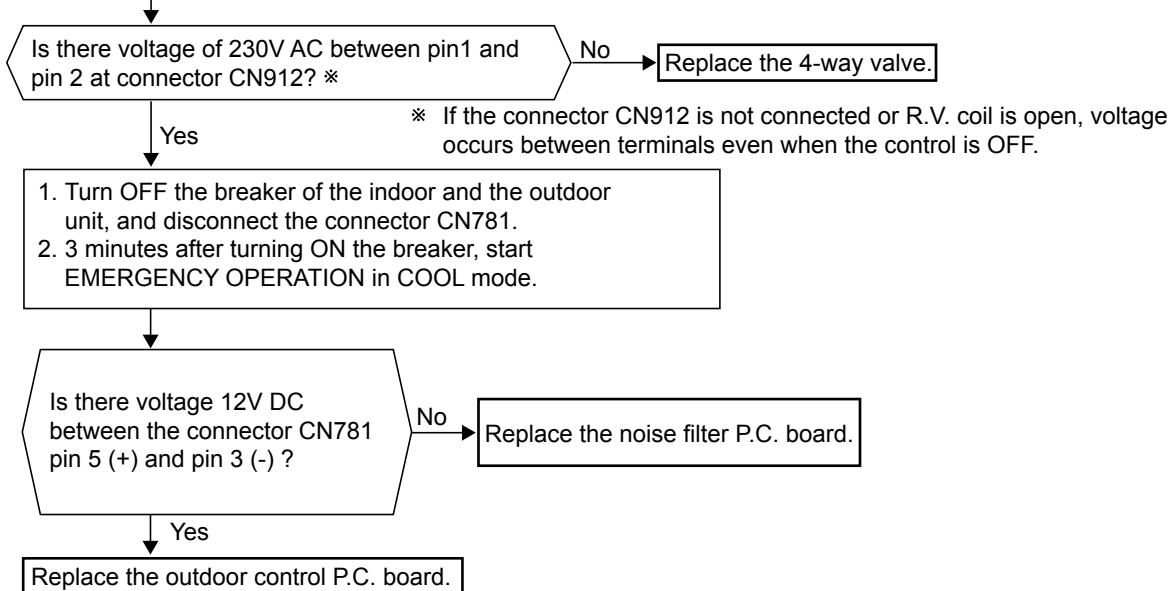



• When the operation frequency does not go up from lowest frequency.

⊕ Check of HPS

	MXZ-3D68VA/4D72VA/4D83VA/5D102VA
CN681	Outdoor control P.C. board

MXZ-3D68VA/4D72VA/4D83VA/5D102VA

- 1. Disconnect the connector CN681.
- 2. Check the resistance of HPS 1 minute after the outdoor unit breaker was turned OFF.

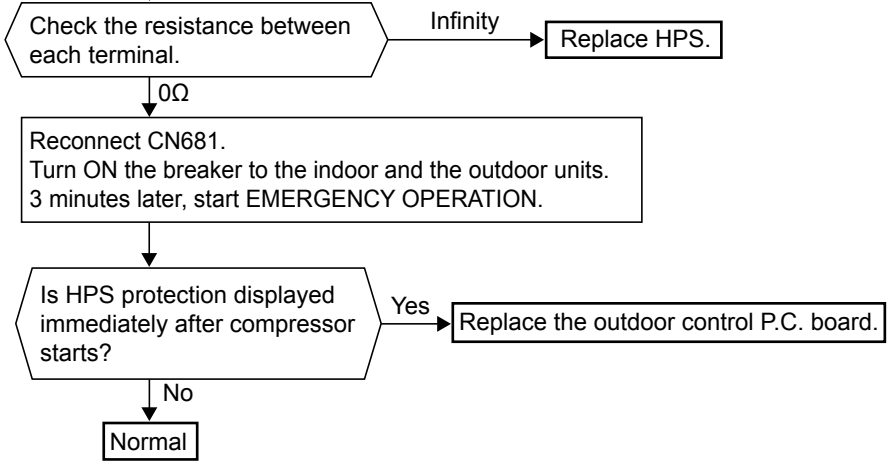

① Check of bus-bar voltage

MXZ-3D54VA/3D68VA/4D72VA
MXZ-4D83VA/5D102VA

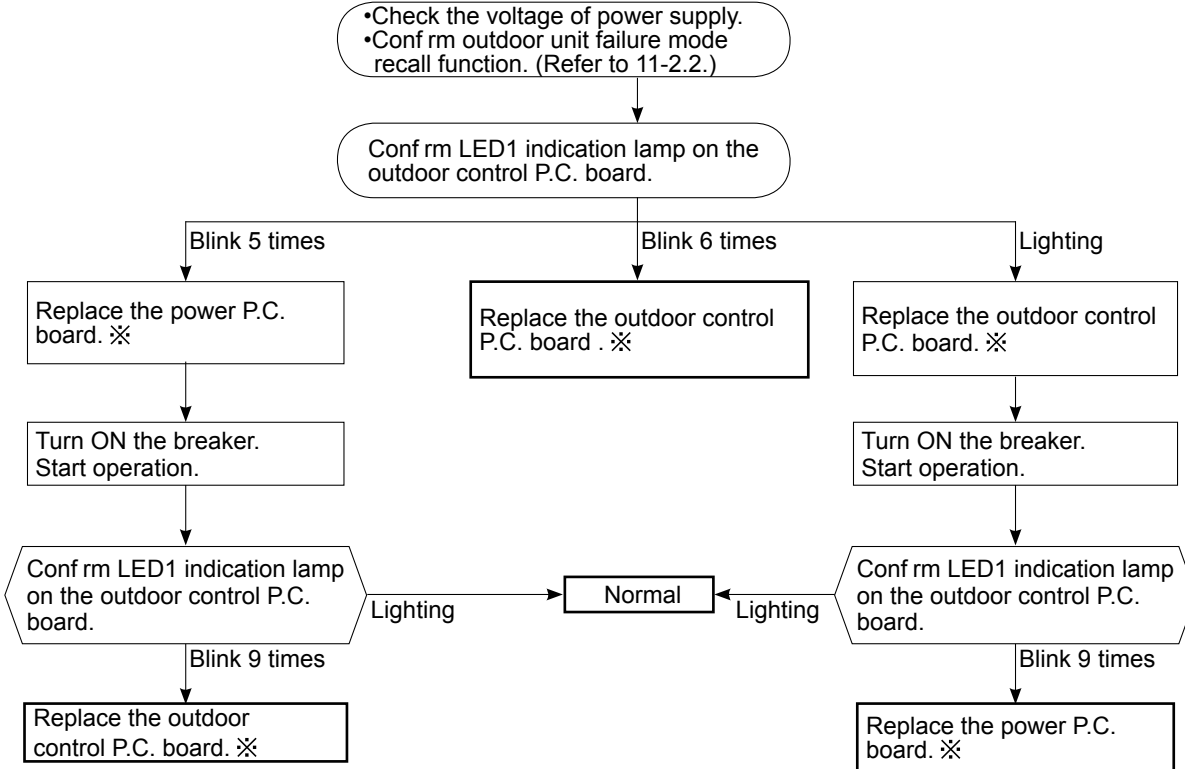

✖ Turn OFF the breaker before removing P.C. board.

② The other cases

Indoor unit does not operate. (different operating models in multi system)

- When you try to run two indoor units simultaneously, one for cooling and the other for heating, the unit which transmits signal to the outdoor unit first decides the operation mode.
- When the above situation occurs, set all the indoor units to the same mode, turn OFF the indoor units, then turn them back ON.
- Though the top of the indoor unit sometimes gets warm, this does not mean malfunction.
The reason is that the refrigerant gas continuously flows into the indoor unit even while it is not operating.

11-7. TEST POINT DIAGRAM AND VOLTAGE

1. Inverter P.C. board

MXZ-2D33VA MXZ-2D40VA MXZ-2D53VA MXZ-2D53VAH

Back side of unit

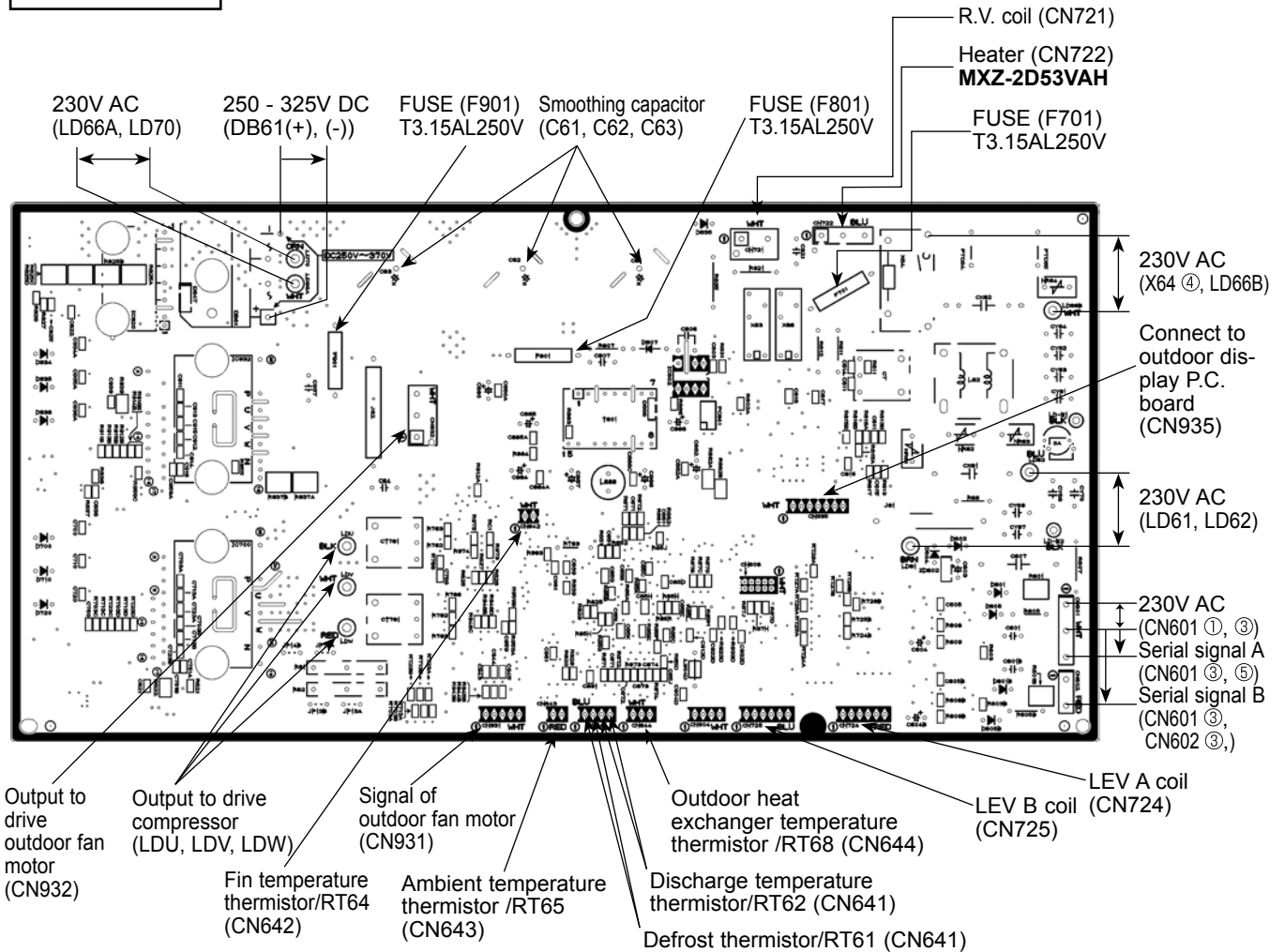

Front side of unit

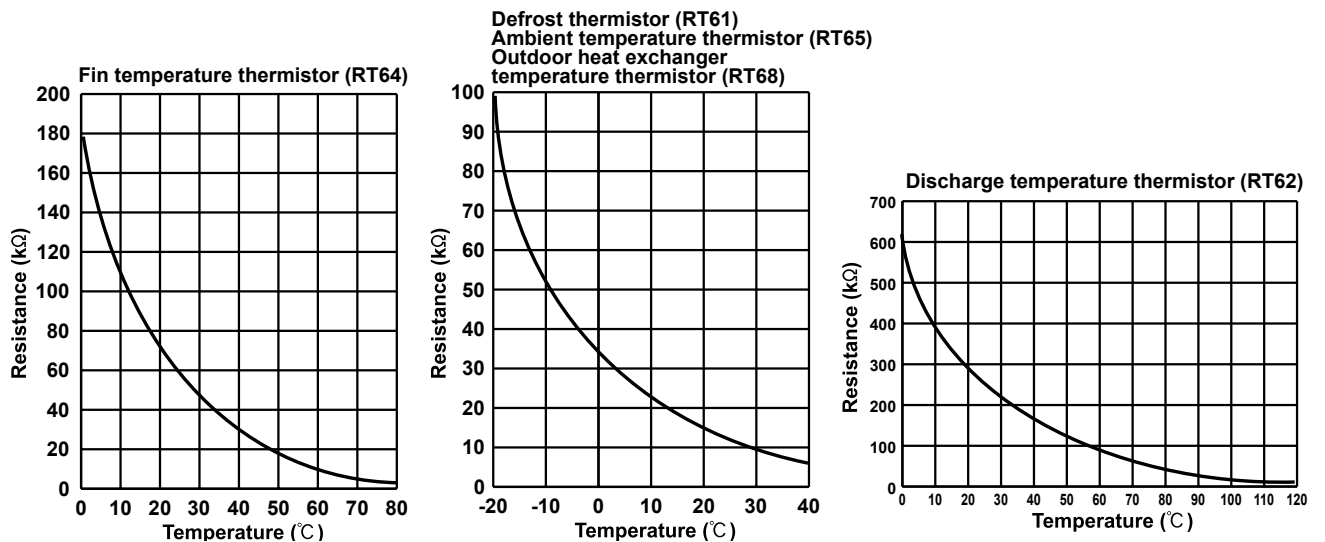

2. Outdoor control P.C. board

MXZ-3D54VA MXZ-3D68VA MXZ-4D72VA

Defrost thermistor (RT61)
Ambient temperature thermistor (RT65)
Outdoor heat exchanger temperature thermistor (RT68)

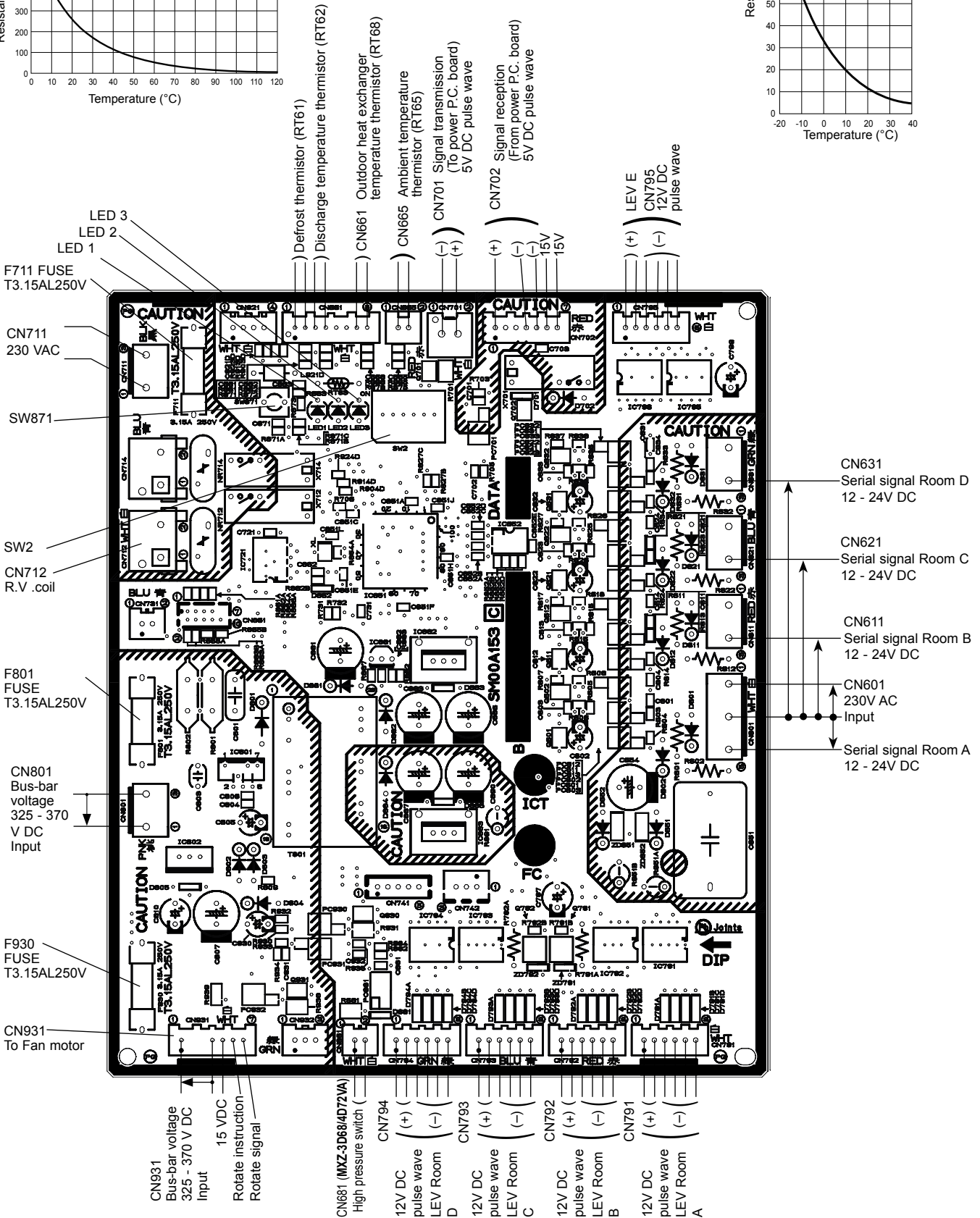
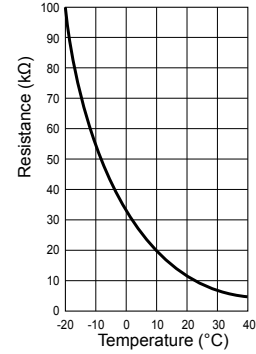
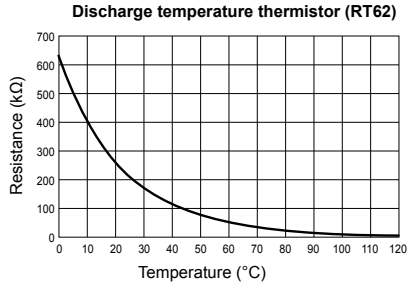

MXZ-4D83VA MXZ-5D102VA

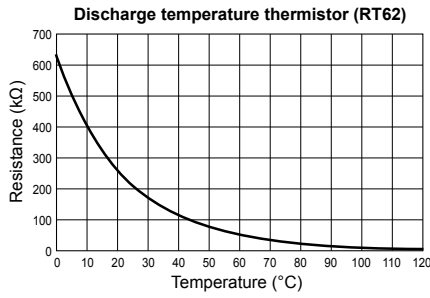

Defrost thermistor (RT61)
Ambient temperature thermistor (RT65)
Outdoor heat exchanger temperature thermistor (RT68)

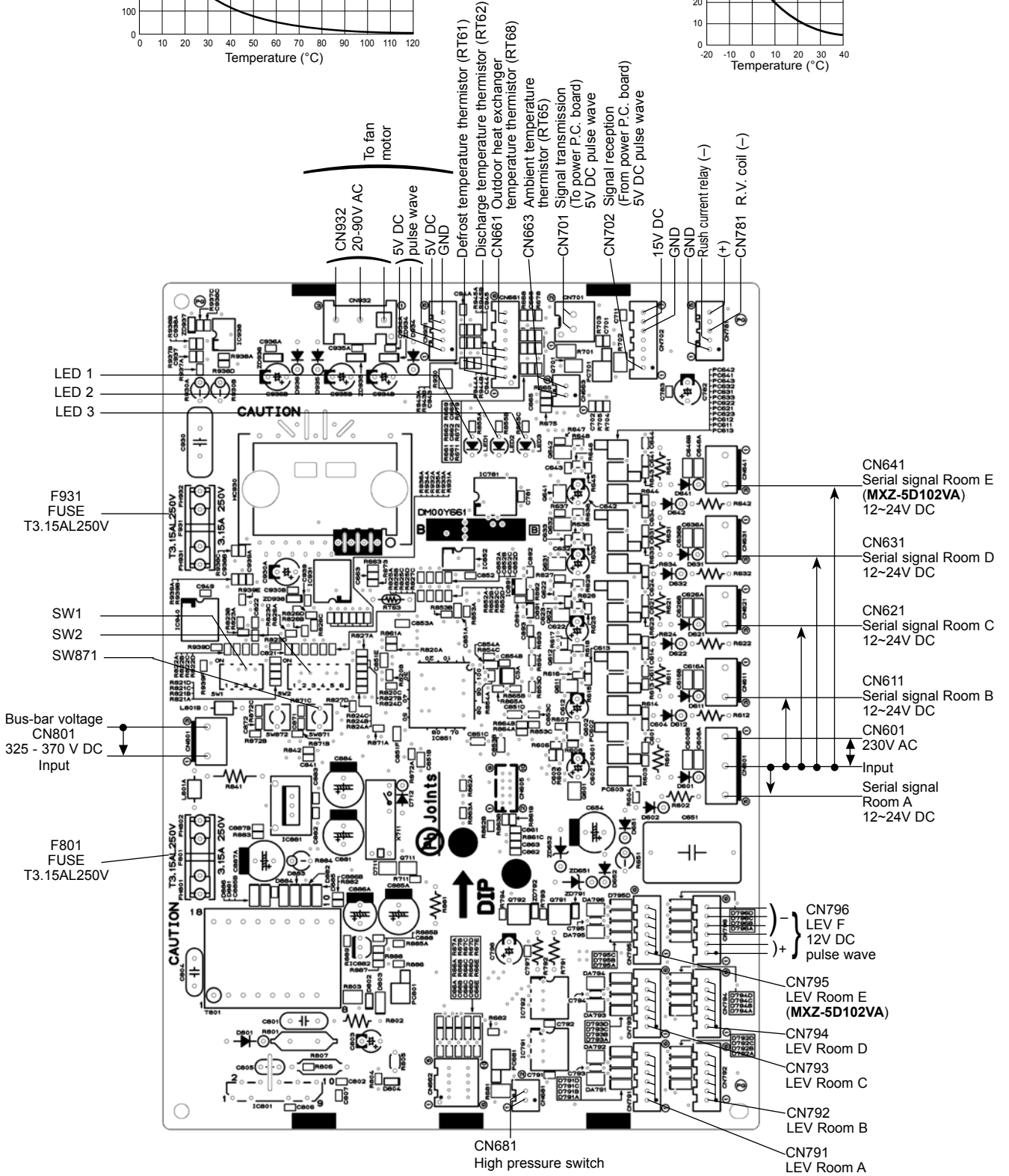
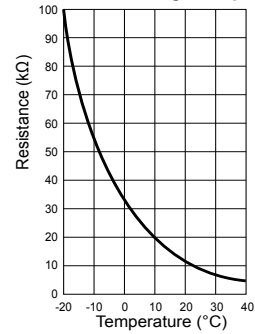

3. Outdoor power P.C. board

MXZ-3D54VA MXZ-3D68VA MXZ-4D72VA

CN5
Primary current detection
(Connect to the noise filter)

Signal reception
(From electronic control P.C. board)
5V DC pulse wave

CN3
Fin temperature thermistor RT64

CN2
Connect to the controller board
(+)-1-5(-): Signal transmission
(To electronic control P.C. board)
5V DC pulse wave
(+)-2-5(-): Zero cross signal
3-4 : Not used
(+)-6-5(-): 15V
(+)-7-5(-): 15V

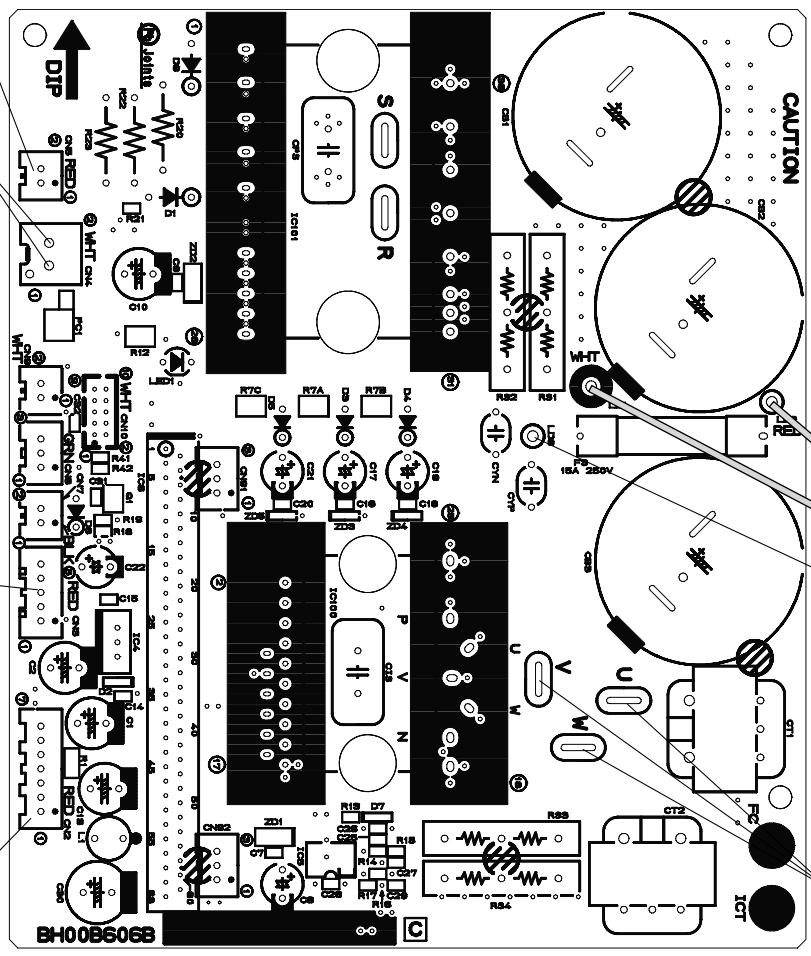

Fin temperature thermistor (RT64)

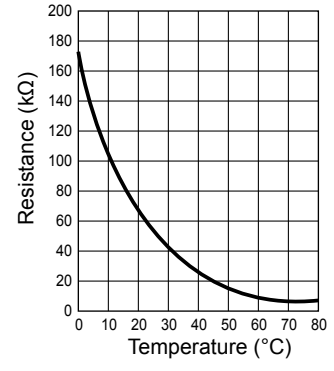

(Red)
1 (+)
325-370V DC
Output
(White)
3 (-)
Connect to the earth

Connect to the compressor
Voltage among
phases: 5V to 180V

MXZ-4D83VA MXZ-5D102VA

Fin temperature thermistor (RT64)

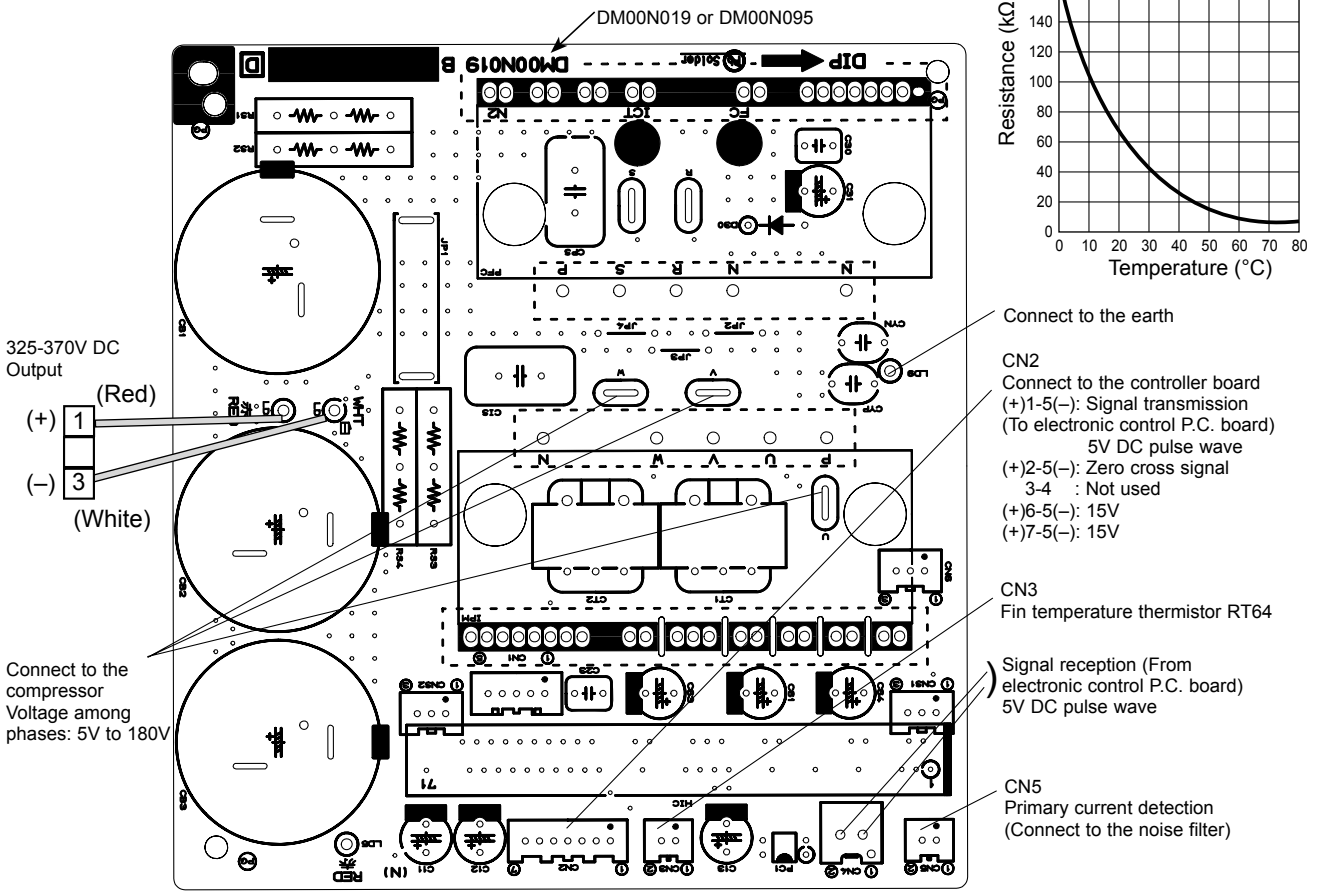

4. Outdoor display P.C. board

MXZ-2D33VA MXZ-2D40VA MXZ-2D53VA MXZ-2D53VAH

To inverter P.C. board (CN936)

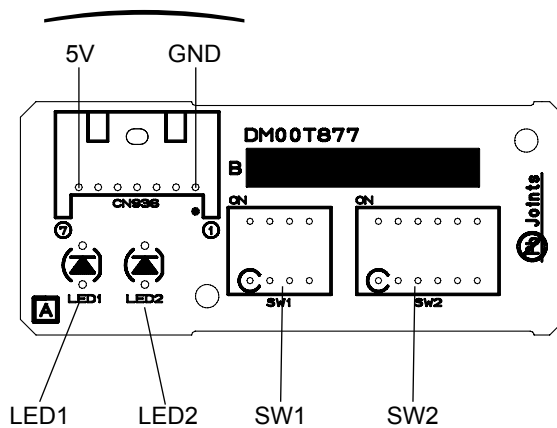

5. Noise filter P.C. board
MXZ-3D54VA MXZ-3D68VA MXZ-4D72VA

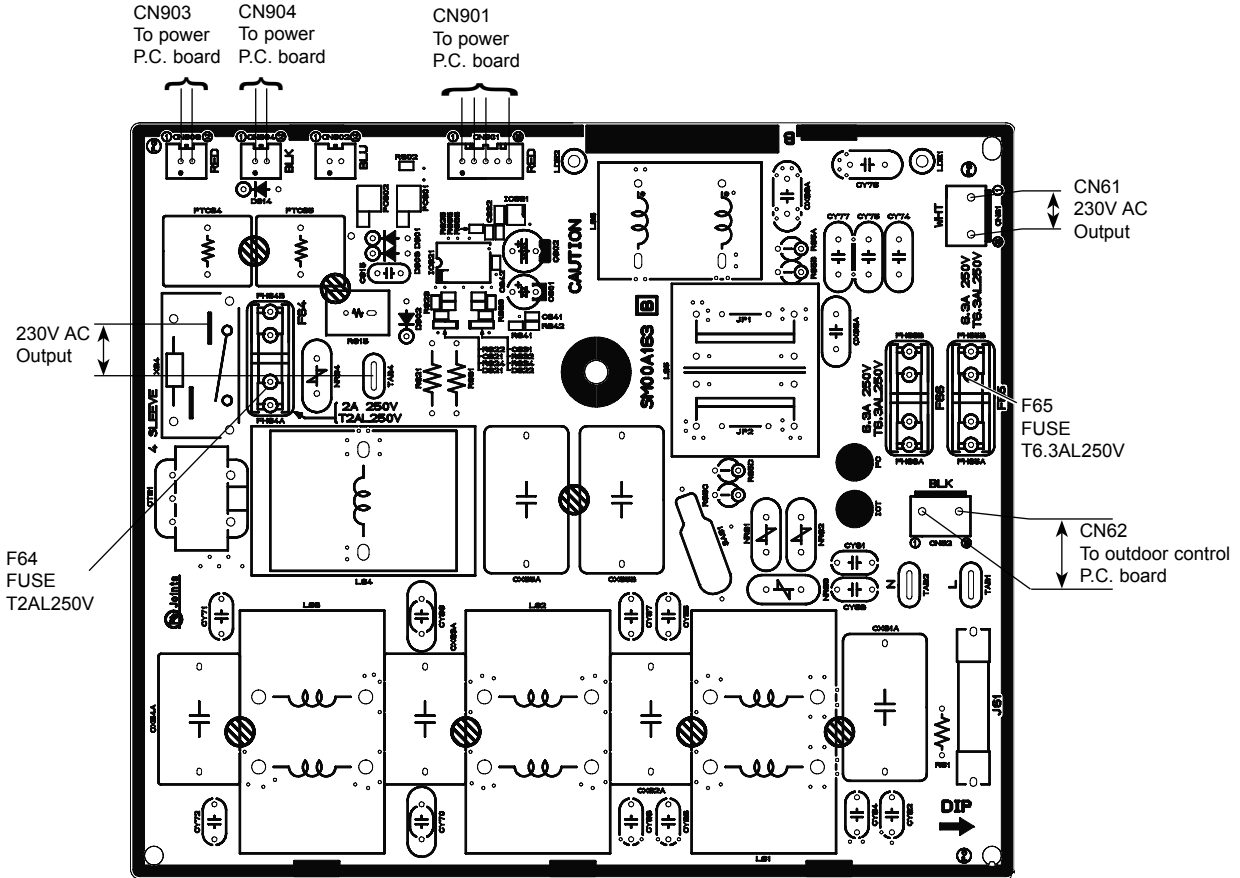

MXZ-4D83VA MXZ-5D102VA

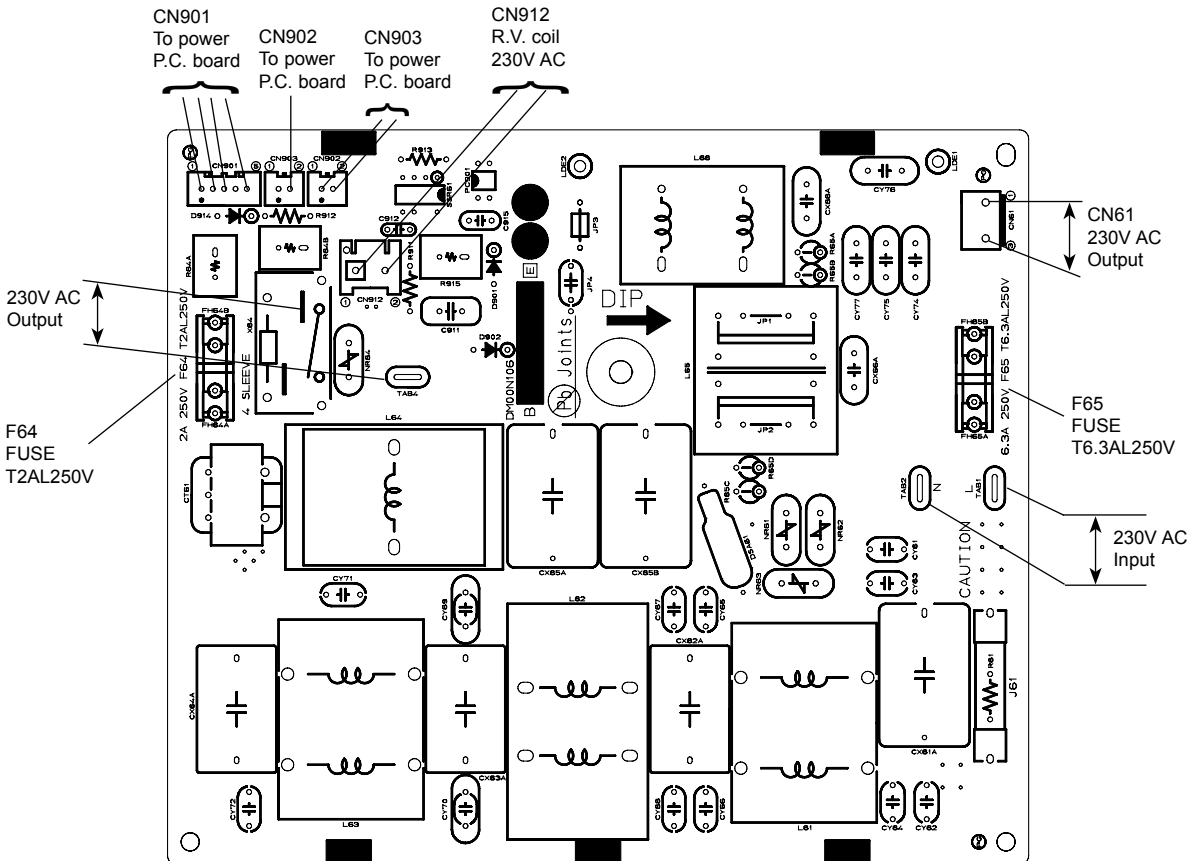

<"Terminal with locking mechanism" Detaching points>

The terminal which has the locking mechanism can be detached as shown below.
 There are two types (Refer to (1) and (2)) of the terminal with locking mechanism.
 The terminal without locking mechanism can be detached by pulling it out.
 Check the shape of the terminal before detaching.

(1) Slide the sleeve and check if there is a locking lever or not.

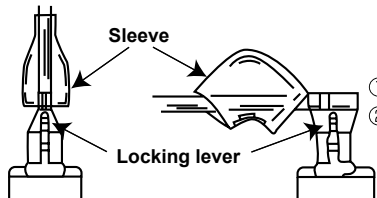

① Slide the sleeve.
 ② Pull the terminal while pushing the locking lever.

(2) The terminal with this connector has the locking mechanism.

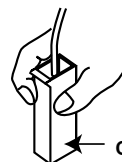

① Hold the sleeve, and pull out the terminal slowly.

Connector

12-1. MXZ-2D33VA MXZ-2D40VA MXZ-2D53VA MXZ-2D53VAH

NOTE: Turn OFF power supply before disassembly.

OPERATING PROCEDURE	PHOTOS
<p>1. Removing the cabinet and the panels</p> <ol style="list-style-type: none"> (1) Remove the screw fixing the service panel. (2) Pull down the service panel and remove it. (3) Disconnect the power supply and indoor/outdoor connecting wire. (4) Remove the screws fixing the top panel. (5) Remove the top panel. (6) Remove the screws fixing the cabinet. (7) Remove the cabinet. (8) Remove the screws fixing the back panel. (9) Remove the back panel. <p>Photo 2</p> <p>Screws of the terminal block support and the back panel</p> <p>Screws of the cabinet</p>	<p>Photo 1</p> <p>Screws of the top panel</p> <p>Direction to remove</p> <p>Hooks</p> <p>Screws of Service panel</p> <p>Photo 3</p> <p>Screws of the back panel</p>

OPERATING PROCEDURE

2. Removing the inverter assembly and the inverter P.C. board

- (1) Remove the service panel, the top panel and the cabinet (Refer to 1).
- (2) Disconnect the power supply and indoor/outdoor connecting wire and remove the back panel (Refer to 1).
- (3) Disconnect all connectors and lead wires on the inverter P.C. board.
- (4) Remove the compressor connector (CNMC).
- (5) Remove the screws fixing the heat sink support and the separator.
- (6) Remove the screws of the terminal block support and the back panel. (Photo 2)
- (7) Remove the inverter assembly.
- (8) Remove the screw of the earth wire and screws of the terminal block support.
- (9) Remove the hooks of the heat sink support and remove the heat sink support from the P.C. board support.
- (10) Remove the screw fixing the inverter P.C. board and remove the inverter P.C. board from the P.C. board support.

3. Removing the R.V. coil

- (1) Remove the service panel, the top panel and the cabinet (Refer to 1).
- (2) Disconnect the power supply and indoor/outdoor connecting wire and remove the back panel (Refer to 1).
- (3) Remove the inverter assembly (Refer to 2).
- (4) Remove the R.V. coil.

4. Removing the discharge temperature thermistor, defrost thermistor and outdoor heat exchanger temperature thermistor

- (1) Remove the service panel, the top panel and the cabinet (Refer to 1).
- (2) Disconnect the power supply and indoor/outdoor connecting wire and remove the back panel (Refer to 1).
- (3) Remove the inverter assembly (Refer to 2).
- (4) Pull out the discharge temperature thermistor from its holder.
- (5) Pull out the defrost thermistor from its holder (Photo 7).
- (6) Pull out the outdoor heat exchanger temperature thermistor from its holder (Photo 7).

PHOTOS

Photo 4

Screws of the heat sink support and the separator

Inverter assembly



Photo 5

Screws of the terminal block support

Reactor (ACL2)

Compressor connector

P.C. board support

Hooks of the heat sink support

Screw of the earth wire
Screw of the inverter P.C. board

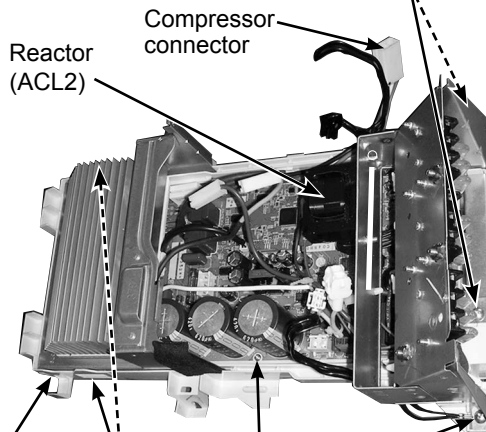
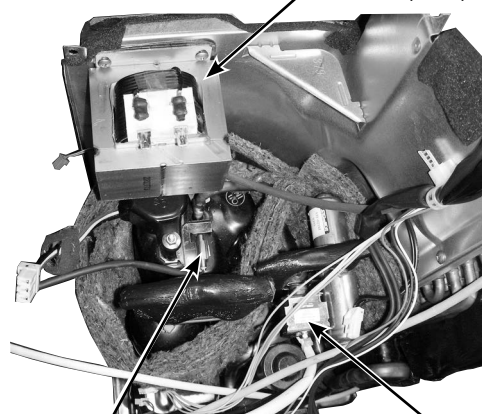

Photo 6

Reactor (ACL)

Discharge temperature thermistor (RT62)

R.V. coil



OPERATING PROCEDURE

5. Removing the outdoor fan motor

- (1) Remove the service panel, the top panel and the cabinet (Refer to 1).
- (2) Disconnect the power supply and indoor/outdoor connecting wire.
- (3) Disconnect the connectors for outdoor fan motor.
- (4) Remove the propeller nut.
- (5) Remove the propeller.
- (6) Remove the screws fixing the fan motor.
- (7) Remove the fan motor.

6. Removing the compressor and the 4-way valve

- (1) Remove the service panel, the top panel and the cabinet (Refer to 1).
 - (2) Disconnect the power supply and indoor/outdoor connecting wire and remove the back panel (Refer to 1).
 - (3) Remove the inverter assembly (Refer to 2).
 - (4) Recover gas from the refrigerant circuit.
- NOTE:** Recover gas from the pipes until the pressure gauge shows 0 kg/cm² (0 MPa).
- (5) Detach the brazed part of the suction and the discharge pipe connected with compressor.
 - (6) Remove the nuts of compressor legs.
 - (7) Remove the compressor.
 - (8) Detach the brazed part of pipes connected with 4-way valve.

Photo 10

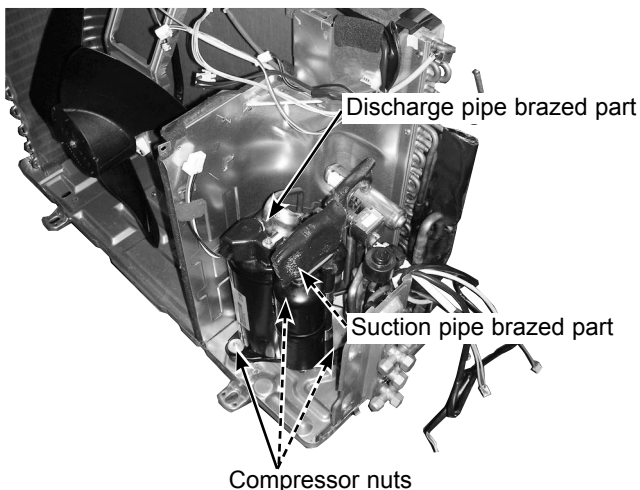

PHOTOS

Photo 7

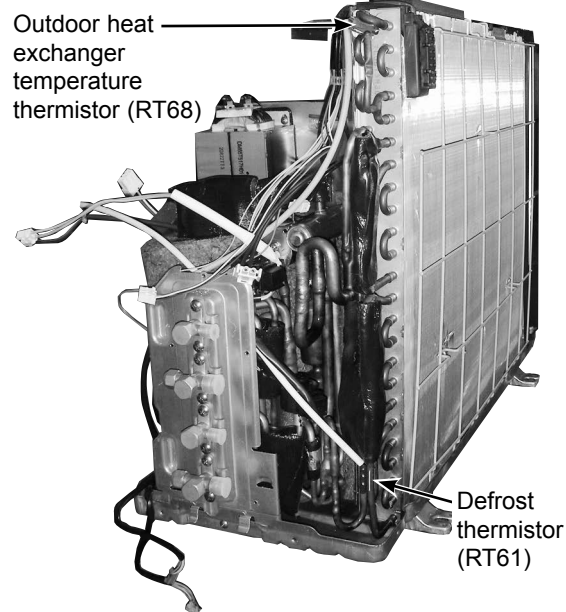

Photo 8

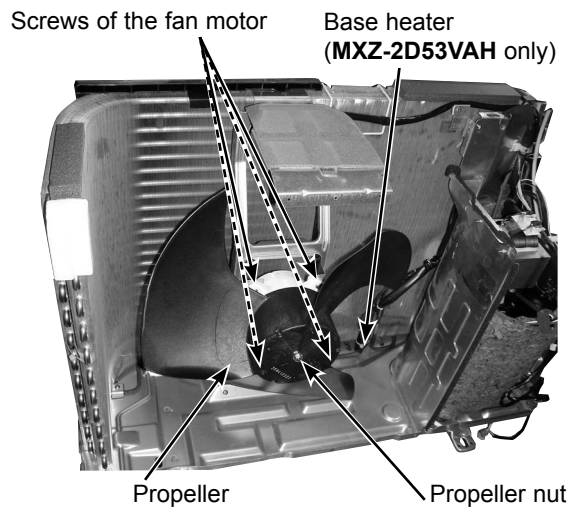
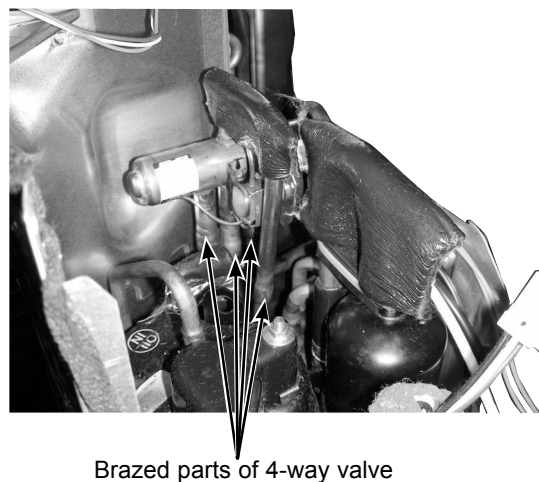
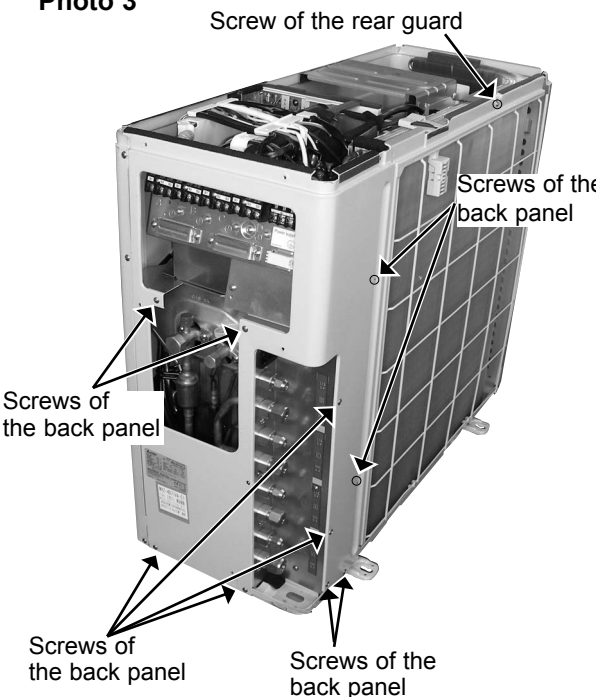
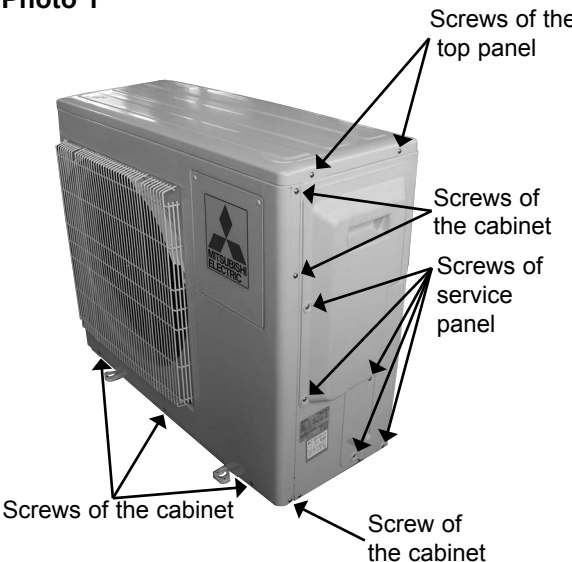
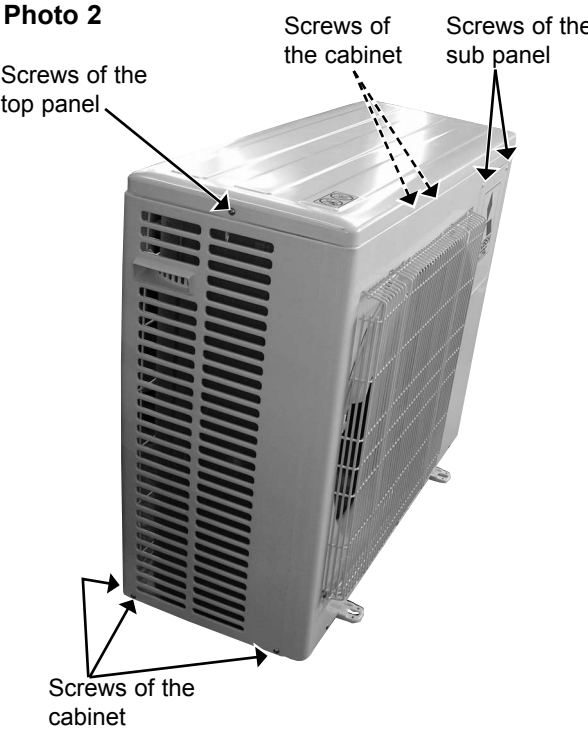

Photo 9



12-2. MXZ-3D54VA MXZ-3D68VA MXZ-4D72VA

NOTE: Turn OFF power supply before disassembly.

OPERATING PROCEDURE	PHOTOS
<p>1. Removing the cabinet and the panels</p> <p>(1) Remove the screws of the service panel, and remove the service panel.</p> <p>(2) Remove the screws of the top panel, and remove the top panel.</p> <p>(3) Remove the screws of the cabinet, and remove the cabinet.</p> <p>(4) Remove the screws of the back panel, and remove the back panel (Photo 3).</p> <p>Photo 3</p> 	<p>Photo 1</p>  <p>Photo 2</p> 

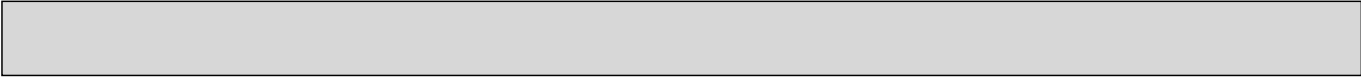

OPERATING PROCEDURE

2. Removing the outdoor control P.C. board, the outdoor power P.C. board and the noise filter P.C. board

- (1) Remove the service panel (Photo 1).
- (2) Remove the top panel, the cabinet, and the back panel (Photo 1, 2, 3).
- (3) Disconnect all connectors and lead wires on the outdoor control P.C. board.
- (4) Remove the outdoor control P.C. board.
- (5) Remove the screws fixing the outdoor power P.C. board.
- (6) Disconnect all connectors and lead wires on the outdoor power P.C. board.
- (7) Pull up the power P.C. board and remove it upward.
- (8) Disconnect all connectors and lead wires on the noise filter P.C. board.
- (9) Remove the noise filter P.C. board.

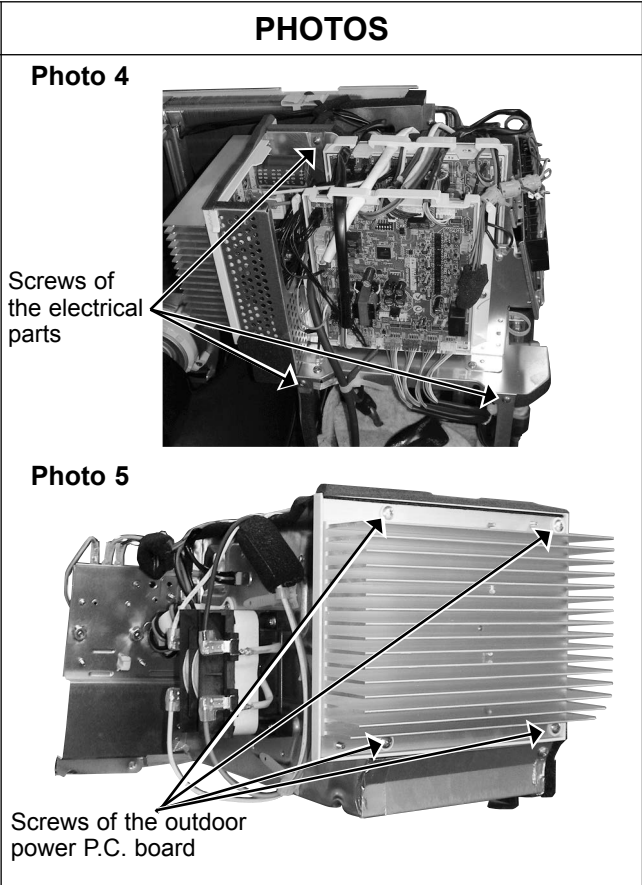

3. Removing the reactor

- (1) Remove the service panel (Photo 1).
- (2) Remove the top panel, cabinet, back panel, and the electrical parts (Photo 1, 2, 3, 4).
- (3) Disconnect the reactor lead wire from the terminal of the reactor.
- (4) Remove the screws of the reactor, and remove the reactor.

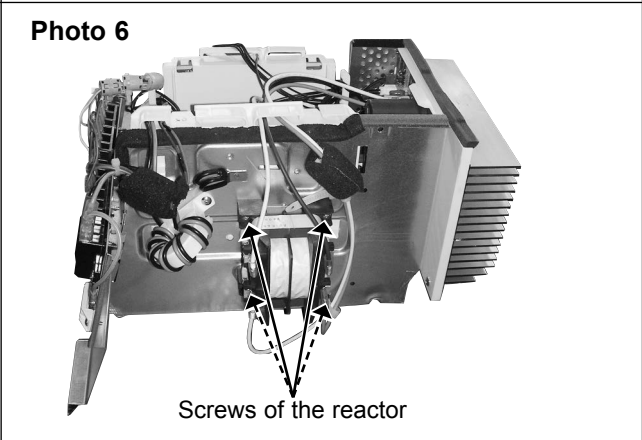

4. Removing the fan motor

- (1) Remove the service panel, the top panel, and the cabinet (Photo 1, 2).
- (2) Disconnect the connector CN931 on the outdoor control P.C. board.
- (3) Remove the propeller.
- (4) Remove the fan motor.

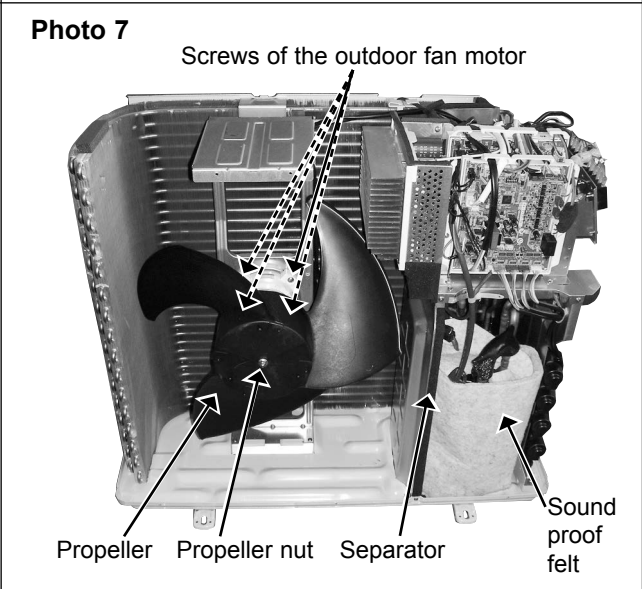

OPERATING PROCEDURE

5. Removing the compressor and the 4-way valve

- (1) Remove the service panel (Photo 1).
- (2) Remove the top panel, the cabinet, and the back panel (Photo 1, 2, 3).
- (3) Recover gas from the refrigerant circuit.
NOTE: Recover gas from the pipes until the pressure gauge shows 0 kg/cm² (0 MPa).
- (4) Disconnect the compressor lead wire from terminal of the compressor (U, V, W).
- (5) Disconnect the outdoor control P.C. board connectors:
CN661, CN665, CN681 (**MXZ-3D68VA, MXZ-4D72VA**),
CN711, CN712, CN791, CN792, CN793,
CN794 (**MXZ-4D72VA**), CN795, CN931
- (6) Remove the screws of the electrical parts, and remove the electrical parts (Photo 4).
- (7) Remove the propeller.
- (8) Remove the screws of the separator, and remove the separator (Photo 7).
- (9) Remove the sound proof felt (Photo 7).
- (10) Detach the brazed parts of the compressor suction and discharge pipes.
- (11) Remove the compressor nuts and remove the compressor.
- (12) Detach the brazed parts of 4-way valve and pipe.

PHOTOS

Photo 8

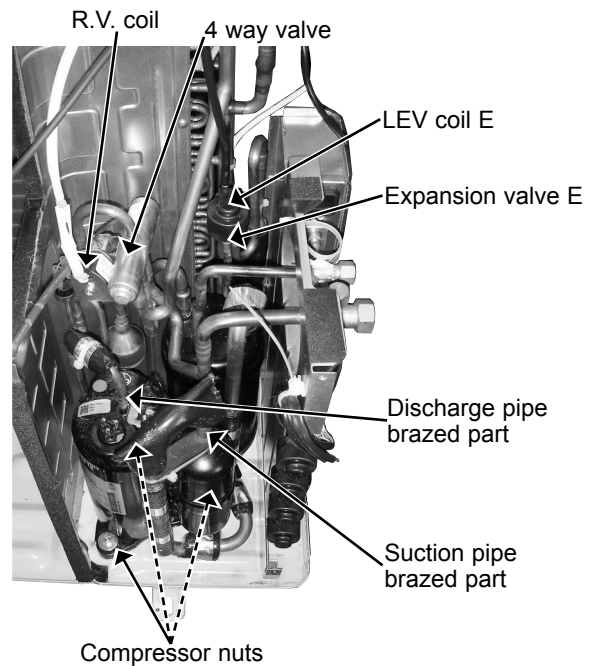
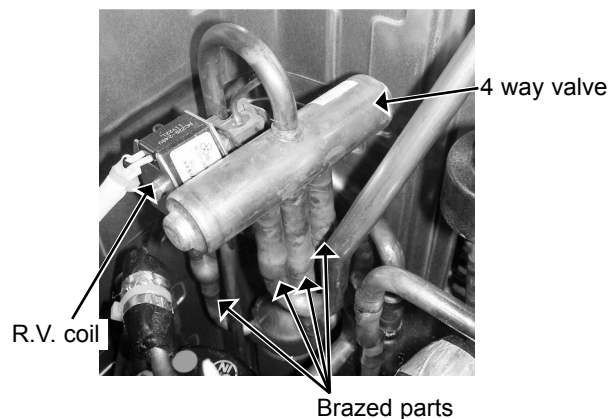

Photo 9



6. Removing the expansion valve

- (1) Remove the service panel (Photo 1).
- (2) Remove the top panel, the cabinet, and the back panel (Photo 1, 2, 3).
(Gas recovery is not required if the unit is pumped down.)
- (3) Remove the electrical parts for removing LEV E (Photo 4, 8).
- (4) Remove the LEV coils.
- (5) Detach the brazed parts of expansion valves and pipes.

Photo 10

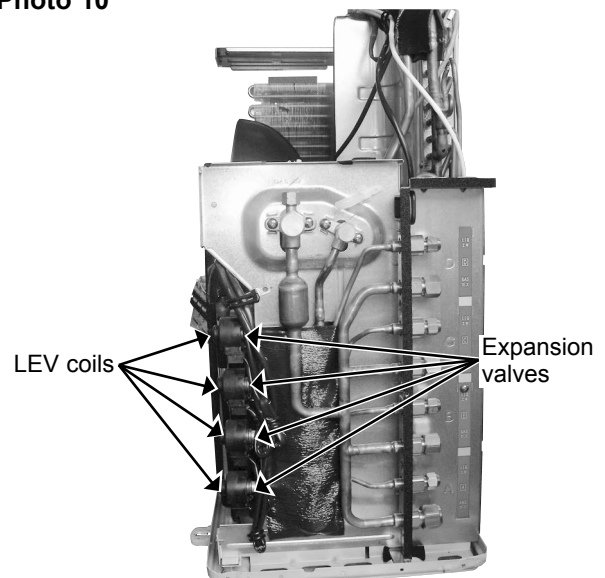

12-3. MXZ-4D83VA MXZ-5D102VA

NOTE: Turn OFF power supply before disassembly.

OPERATING PROCEDURE

1. Removing the panels

- (1) Remove the screws of the service panel, and remove the service panel.
- (2) Remove the screws of the top panel, and remove the service panel.
- (3) Remove the screws of the front panel, and remove the front panel.
- (4) Remove the screws of the rear panel, and remove the rear panel.

PHOTOS

Photo 1

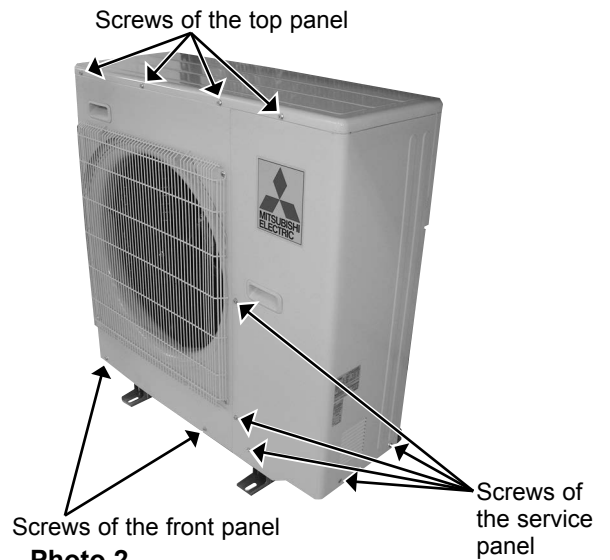
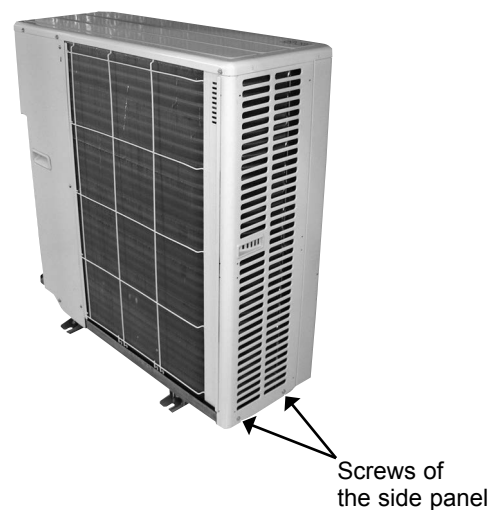

Photo 2



Photo 3



OPERATING PROCEDURE

2. Removing the outdoor control P.C. board the outdoor power P.C. board and the noise filter P.C. board

- (1) Remove the service panel.
- (2) Remove the top panel, the front panel, and the rear panel.
- (3) Disconnect all connectors and lead wires on the outdoor control P.C. board.
- (4) Remove the outdoor control P.C. board.
- (5) Remove the screws fixing the outdoor power P.C. board.
- (6) Disconnect all connectors and lead wires on the outdoor power P.C. board.
- (7) Remove the outdoor power P.C. board.
- (8) Disconnect all connectors and lead wires on the noise filter P.C. board.
- (9) Remove the noise filter P.C. board.

PHOTOS

Photo 4

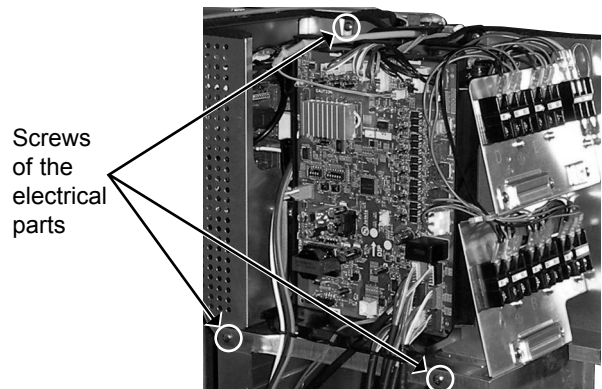

3. Removing the reactor

- (1) Remove the top panel (Photo 1).
- (2) Disconnect the reactor lead wire.
- (3) Remove the screws of the reactor, and remove the reactor.

Photo 5

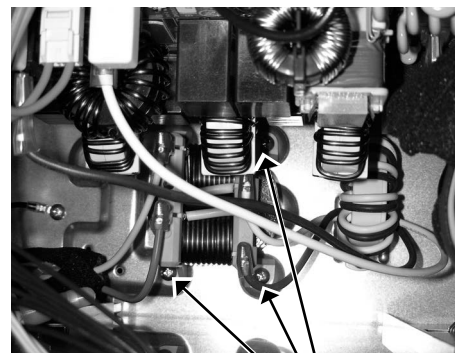

Screws of the reactor

4. Removing the fan motor

- (1) Remove the service panel, the top panel, and the front panel (Photo 1).
- (2) Disconnect the connector CN931 and CN932 on the outdoor control P.C. board.
- (3) Remove the propeller.
- (4) Remove the fan motor.

Photo 6

Screws of the outdoor fan motor

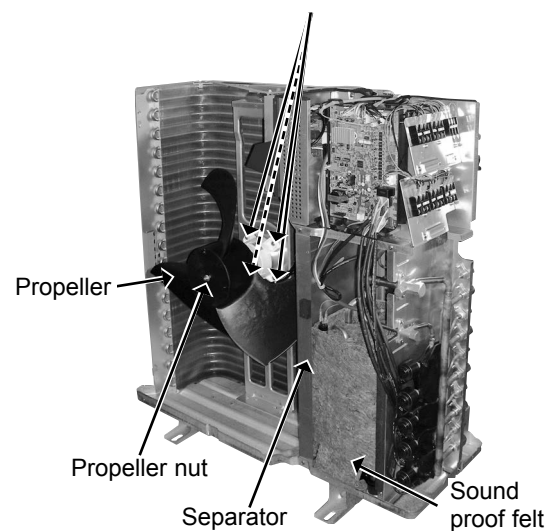

OPERATING PROCEDURE

5. Removing the compressor and the 4-way valve

- (1) Remove the service panel (Photo 1).
- (2) Remove the top panel, the front panel and the rear panel.
- (3) Recover gas from the refrigerant circuit.

NOTE: Recover gas from the pipes until the pressure gauge shows 0 kg/cm² (0 MPa).

- (4) Disconnect the compressor lead wire from terminal of compressor (U, V, W).
- (5) Disconnect the outdoor control P.C. board connectors:
CN661, CN663, CN681, CN791, CN792, CN793, CN794, CN795 (**MXZ-5D102VA**), CN796, CN931, CN932
Disconnect the noise filter P.C. board connector:
CN912
- (6) Remove the screws of the electrical parts, and remove the electrical parts.
- (7) Remove the propeller.
- (8) Remove the screws of the separator, and remove the separator (Photo 6).
- (9) Remove the sound proof felt (Photo 6).
- (10) Detach the brazed parts of the compressor suction and discharge pipes.
- (11) Remove the compressor nuts and remove the compressor.
- (12) Detach the brazed parts of 4-way valve and pipe.

6. Removing the expansion valve

- (1) Remove the service panel (Photo 1, 2).
- (2) Remove the top panel (Photo 1).
(Gas recovery is not required if the unit is pumped down.)
- (3) Remove the front panel for removing LEV F (Photo 1).
- (4) Remove the electrical parts for removing LEV F (Photo 4).
- (5) Remove the LEV coils.
- (6) Detach the brazed parts of expansion valves and pipes.

PHOTOS

Photo 7

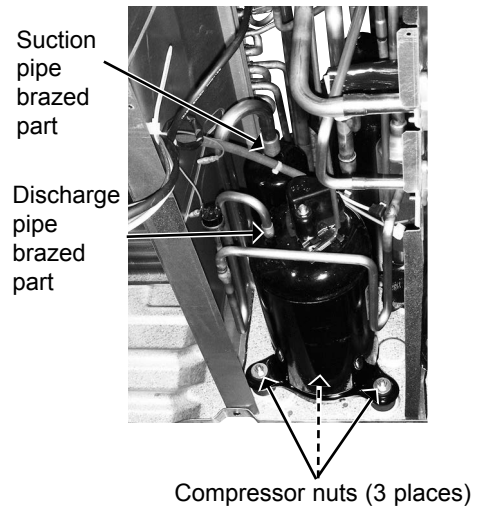

Photo 8

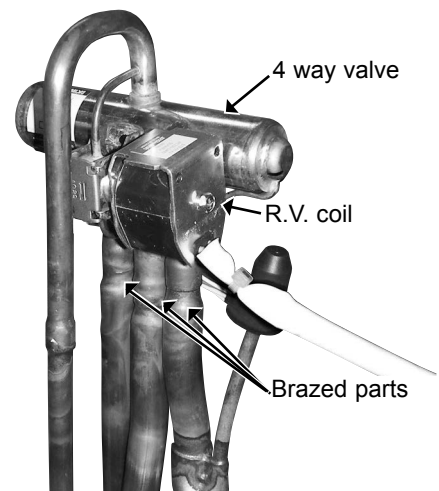
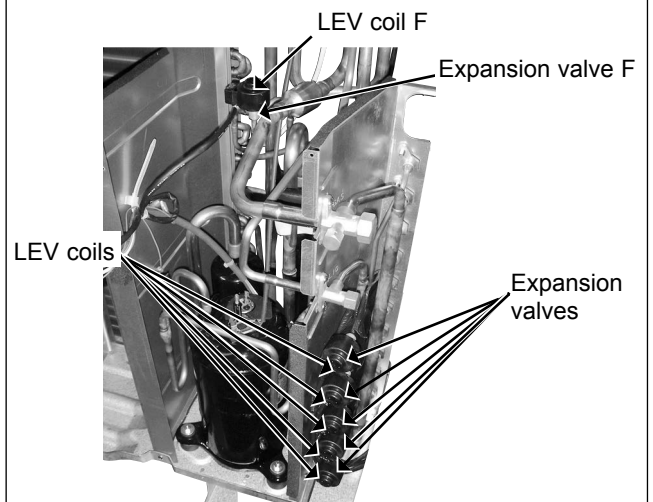

Photo 9



MITSUBISHI ELECTRIC CORPORATION

HEAD OFFICE: TOKYO BLDG., 2-7-3, MARUNOUCHI, CHIYODA-KU, TOKYO 100-8310, JAPAN

© Copyright 2012 MITSUBISHI ELECTRIC CORPORATION
Distributed in Jan. 2013. No.OBH626 REVISED EDITION-B
Distributed in Dec. 2012. No.OBH626 REVISED EDITION-A
Distributed in Nov. 2012. No.OBH626
Made in Japan

New publication, effective Jan. 2013
Specifications are subject to change without notice.

MXZ-2D33VA COOLING

Indoor units combination	Cooling capacity (kW)			Outdoor unit power consumption(kW)	Current (A)	Power factor(%)
	Unit A	Unit B	Total			
15	1.50	-	1.50 (0.90 - 2.40)	0.333 (0.143 - 0.673)	1.61	90
18	1.80	-	1.80 (0.90 - 3.00)	0.326 (0.116 - 0.616)	1.57	90
20	2.00	-	2.00 (0.90 - 2.60)	0.441 (0.141 - 0.721)	2.13	90
22	2.20	-	2.20 (0.90 - 3.00)	0.406 (0.116 - 0.616)	1.96	90
25	2.50	-	2.50 (0.90 - 3.30)	0.486 (0.116 - 0.686)	2.35	90
15+15	1.20	1.20	2.40 (1.10 - 3.80)	0.536 (0.296 - 1.106)	2.59	90
15+18	1.50	1.80	3.30 (1.10 - 3.80)	0.869 (0.279 - 1.029)	4.20	90
15+20	1.41	1.89	3.30 (1.10 - 3.80)	0.894 (0.304 - 1.104)	4.32	90
15+22	1.34	1.96	3.30 (1.10 - 3.80)	0.869 (0.279 - 1.029)	4.20	90
15+25	1.24	2.06	3.30 (1.10 - 3.80)	0.892 (0.302 - 1.102)	4.31	90
18+18	1.65	1.65	3.30 (1.10 - 3.80)	0.752 (0.252 - 0.962)	3.63	90
18+20	1.56	1.74	3.30 (1.10 - 3.80)	0.867 (0.277 - 1.027)	4.19	90
18+22	1.49	1.82	3.30 (1.10 - 3.80)	0.892 (0.302 - 1.102)	4.31	90
18+25	1.38	1.92	3.30 (1.10 - 3.90)	0.752 (0.252 - 1.002)	3.63	90
20+20	1.65	1.65	3.30 (1.10 - 3.80)	0.892 (0.302 - 1.102)	4.31	90
20+22	1.57	1.73	3.30 (1.10 - 3.80)	0.867 (0.277 - 1.027)	4.19	90
20+25	1.47	1.83	3.30 (1.10 - 3.80)	0.867 (0.277 - 1.027)	4.19	90
22+22	1.65	1.65	3.30 (1.10 - 3.80)	0.752 (0.252 - 0.962)	3.63	90
22+25	1.54	1.76	3.30 (1.10 - 3.90)	0.752 (0.252 - 1.002)	3.63	90
25+25	1.65	1.65	3.30 (1.10 - 4.00)	0.752 (0.252 - 1.042)	3.63	90

MXZ-2D33VA HEATING

Indoor units combination	Heating capacity (kW)			Outdoor unit power consumption(kW)	Current (A)	Power factor(%)
	Unit A	Unit B	Total			
15	1.70	-	1.70 (0.90 - 3.10)	0.353 (0.143 - 0.823)	1.71	90
18	3.30	-	3.30 (0.90 - 4.00)	0.673 (0.113 - 1.103)	3.25	90
20	2.20	-	2.20 (0.90 - 3.10)	0.471 (0.141 - 0.851)	2.28	90
22	3.30	-	3.30 (0.90 - 4.00)	0.673 (0.113 - 1.103)	3.25	90
25	3.60	-	3.60 (0.90 - 4.40)	0.733 (0.113 - 1.253)	3.54	90
15+15	1.50	1.50	3.00 (1.00 - 3.90)	0.636 (0.246 - 0.936)	3.07	90
15+18	1.36	2.64	4.00 (1.00 - 4.10)	0.916 (0.226 - 0.956)	4.43	90
15+20	1.70	2.20	3.90 (1.00 - 4.00)	0.934 (0.254 - 0.974)	4.51	90
15+22	1.36	2.64	4.00 (1.00 - 4.10)	0.916 (0.226 - 0.956)	4.43	90
15+25	1.28	2.72	4.00 (1.00 - 4.00)	0.972 (0.252 - 0.972)	4.70	90
18+18	2.00	2.00	4.00 (1.00 - 4.30)	0.836 (0.196 - 0.956)	4.04	90
18+20	2.40	1.60	4.00 (1.00 - 4.10)	0.914 (0.234 - 0.954)	4.42	90
18+22	2.00	2.00	4.00 (1.00 - 4.00)	0.972 (0.252 - 0.972)	4.70	90
18+25	1.91	2.09	4.00 (1.00 - 4.30)	0.836 (0.196 - 0.956)	4.04	90
20+20	2.00	2.00	4.00 (1.00 - 4.00)	0.972 (0.252 - 0.972)	4.70	90
20+22	1.60	2.40	4.00 (1.00 - 4.10)	0.914 (0.234 - 0.954)	4.42	90
20+25	1.49	2.44	4.00 (1.00 - 4.10)	0.914 (0.234 - 0.954)	4.42	90
22+22	2.00	2.00	4.00 (1.00 - 4.30)	0.836 (0.196 - 0.956)	4.04	90
22+25	1.91	2.09	4.00 (1.00 - 4.30)	0.836 (0.196 - 0.956)	4.04	90
25+25	2.00	2.00	4.00 (1.00 - 4.40)	0.836 (0.196 - 0.996)	4.04	90

MXZ-2D40VA COOLING

Indoor units combination	Cooling capacity (kW)			Outdoor unit power consumption(kW)	Current (A)	Power factor(%)
	Unit A	Unit B	Total			
15	1.50	-	1.50 (0.90 - 2.70)	0.333 (0.263 - 0.893)	1.61	90
18	1.80	-	1.80 (0.90 - 3.00)	0.336 (0.116 - 0.616)	1.62	90
20	2.00	-	2.00 (0.90 - 2.70)	0.501 (0.261 - 0.891)	2.42	90
22	2.20	-	2.20 (0.90 - 3.00)	0.426 (0.116 - 0.616)	2.06	90
25	2.50	-	2.50 (0.90 - 3.30)	0.486 (0.116 - 0.686)	2.35	90
35	3.50	-	3.50 (0.90 - 4.00)	0.726 (0.116 - 0.896)	3.51	90
15+15	1.40	1.40	2.80 (1.10 - 4.30)	0.626 (0.446 - 1.286)	3.02	90
15+18	1.50	1.80	3.30 (1.10 - 4.30)	1.069 (0.289 - 1.539)	5.16	90
15+20	1.41	1.89	3.30 (1.10 - 4.30)	1.314 (0.334 - 1.944)	6.35	90
15+22	1.34	1.96	3.30 (1.10 - 4.30)	1.069 (0.289 - 1.539)	5.16	90
15+25	1.50	2.50	4.00 (1.10 - 4.30)	1.162 (0.292 - 1.472)	5.61	90
15+35	1.20	2.80	4.00 (1.10 - 4.40)	1.162 (0.292 - 1.512)	5.61	90
18+18	1.65	1.65	3.30 (1.10 - 4.30)	0.732 (0.252 - 1.142)	3.54	90
18+20	1.66	1.84	3.50 (1.10 - 4.30)	1.137 (0.287 - 1.537)	5.49	90
18+22	1.80	2.20	4.00 (1.10 - 4.30)	0.942 (0.252 - 1.142)	4.55	90
18+25	1.67	2.33	4.00 (1.10 - 4.40)	0.942 (0.252 - 1.182)	4.55	90
18+35	1.36	2.64	4.00 (1.10 - 4.40)	0.942 (0.252 - 1.182)	4.55	90
20+20	2.00	2.00	4.00 (1.10 - 4.30)	1.222 (0.442 - 1.282)	5.90	90
20+22	1.90	2.10	4.00 (1.10 - 4.30)	1.307 (0.287 - 1.537)	6.31	90
20+25	1.78	2.22	4.00 (1.10 - 4.30)	1.307 (0.287 - 1.537)	6.31	90
20+35	1.45	2.55	4.00 (1.10 - 4.40)	1.307 (0.287 - 1.577)	6.31	90
22+22	2.00	2.00	4.00 (1.10 - 4.30)	0.942 (0.252 - 1.142)	4.55	90
22+25	1.87	2.13	4.00 (1.10 - 4.40)	0.942 (0.252 - 1.182)	4.55	90
22+35	1.54	2.46	4.00 (1.10 - 4.40)	0.942 (0.252 - 1.182)	4.55	90
25+25	2.00	2.00	4.00 (1.10 - 4.40)	0.942 (0.252 - 1.182)	4.55	90
25+35	1.67	2.33	4.00 (1.10 - 4.50)	0.942 (0.252 - 1.212)	4.55	90

MXZ-2D40VA HEATING

Indoor units combination	Heating capacity (kW)			Outdoor unit power consumption(kW)	Current (A)	Power factor(%)
	Unit A	Unit B	Total			
15	1.70	-	1.70 (0.90 - 3.10)	0.383 (0.233 - 1.083)	1.85	90
18	3.30	-	3.30 (0.90 - 4.00)	0.673 (0.113 - 0.913)	3.25	90
20	2.20	-	2.20 (0.90 - 3.10)	0.551 (0.231 - 1.081)	2.66	90
22	3.30	-	3.30 (0.90 - 4.00)	0.673 (0.113 - 0.913)	3.25	90
25	3.60	-	3.60 (0.90 - 4.50)	0.733 (0.113 - 1.053)	3.54	90
35	4.00	-	4.00 (0.90 - 4.80)	0.869 (0.109 - 1.149)	4.20	90
15+15	1.60	1.60	3.20 (1.00 - 4.80)	0.666 (0.356 - 1.126)	3.22	90
15+18	1.36	2.64	4.00 (1.00 - 4.80)	1.056 (0.276 - 1.366)	5.10	90
15+20	1.70	2.20	3.90 (1.00 - 4.80)	1.314 (0.364 - 1.724)	6.35	90
15+22	1.36	2.64	4.00 (1.00 - 4.80)	1.056 (0.276 - 1.366)	5.10	90
15+25	1.44	3.06	4.50 (1.00 - 4.80)	1.116 (0.276 - 1.296)	5.39	90
15+35	1.34	3.16	4.50 (1.00 - 4.90)	1.116 (0.276 - 1.326)	5.39	90
18+18	2.00	2.00	4.00 (1.00 - 4.80)	0.786 (0.196 - 0.996)	3.80	90
18+20	2.40	1.60	4.00 (1.00 - 4.80)	1.054 (0.284 - 1.364)	5.09	90
18+22	2.25	2.25	4.50 (1.00 - 4.80)	0.916 (0.196 - 0.996)	4.43	90
18+25	2.15	2.35	4.50 (1.00 - 4.80)	0.916 (0.196 - 0.996)	4.43	90
18+35	2.03	2.47	4.50 (1.00 - 4.90)	0.912 (0.202 - 1.022)	4.41	90
20+20	2.20	2.20	4.40 (1.00 - 4.80)	1.052 (0.362 - 1.122)	5.08	90
20+22	1.80	2.70	4.50 (1.00 - 4.80)	1.184 (0.284 - 1.364)	5.72	90
20+25	1.71	2.79	4.50 (1.00 - 4.80)	1.184 (0.284 - 1.364)	5.72	90
20+35	1.60	2.90	4.50 (1.00 - 4.90)	1.180 (0.280 - 1.390)	5.70	90
22+22	2.25	2.25	4.50 (1.00 - 4.80)	0.916 (0.196 - 0.996)	4.43	90
22+25	2.15	2.35	4.50 (1.00 - 4.80)	0.916 (0.196 - 0.996)	4.43	90
22+35	2.03	2.47	4.50 (1.00 - 4.90)	0.912 (0.202 - 1.022)	4.41	90
25+25	2.25	2.25	4.50 (1.00 - 4.90)	0.916 (0.196 - 1.026)	4.43	90
25+35	2.13	2.37	4.50 (1.00 - 5.00)	0.912 (0.202 - 1.052)	4.41	90

MXZ-2D53VA(H) COOLING

Indoor units combination	Cooling capacity (kW)			Outdoor unit power consumption(kW)	Current (A)	Power factor(%)
	Unit A	Unit B	Total			
15	1.50	-	1.50 (0.90 - 2.80)	0.313 (0.283 - 0.823)	1.43	95
18	1.80	-	1.80 (0.90 - 3.00)	0.326 (0.116 - 0.616)	1.49	95
20	2.00	-	2.00 (0.90 - 2.90)	0.471 (0.281 - 0.871)	2.16	95
22	2.20	-	2.20 (0.90 - 3.00)	0.426 (0.116 - 0.616)	1.95	95
25	2.50	-	2.50 (0.90 - 3.30)	0.486 (0.116 - 0.686)	2.22	95
35	3.50	-	3.50 (0.90 - 4.00)	0.726 (0.116 - 0.896)	3.32	95
42	4.20	-	4.20 (1.00 - 4.90)	1.096 (0.156 - 1.496)	5.02	95
50	4.50	-	4.50 (1.00 - 5.00)	1.222 (0.162 - 1.552)	5.59	95
15+15	1.50	1.50	3.00 (1.10 - 4.80)	0.706 (0.326 - 1.326)	3.16	97
15+18	1.50	1.80	3.30 (1.10 - 5.00)	0.779 (0.289 - 1.299)	3.49	97
15+20	1.50	2.00	3.50 (1.10 - 4.80)	0.914 (0.334 - 1.324)	4.10	97
15+22	1.50	2.20	3.70 (1.10 - 5.00)	0.959 (0.289 - 1.299)	4.30	97
15+25	1.50	2.50	4.00 (1.10 - 4.80)	1.332 (0.372 - 1.652)	5.97	97
15+35	1.50	3.50	5.00 (1.10 - 5.60)	1.452 (0.292 - 1.882)	6.51	97
15+42	1.39	3.91	5.30 (1.10 - 5.60)	1.732 (0.292 - 1.882)	7.76	97
15+50	1.22	4.08	5.30 (1.10 - 5.80)	1.855 (0.295 - 2.035)	8.31	97
18+18	1.80	1.80	3.60 (1.10 - 5.30)	0.912 (0.252 - 1.512)	4.09	97
18+20	1.80	2.00	3.80 (1.10 - 5.00)	0.987 (0.287 - 1.297)	4.42	97
18+22	1.80	2.20	4.00 (1.10 - 4.80)	1.112 (0.332 - 1.322)	4.98	97
18+25	1.80	2.50	4.30 (1.10 - 5.40)	1.072 (0.252 - 1.532)	4.81	97
18+35	1.80	3.50	5.30 (1.10 - 5.60)	1.512 (0.252 - 1.552)	6.78	97
18+42	1.59	3.71	5.30 (1.10 - 5.80)	1.512 (0.252 - 1.582)	6.78	97
15+50	1.40	3.90	5.30 (1.10 - 6.00)	1.508 (0.248 - 1.618)	6.76	97
20+20	2.00	2.00	4.00 (1.10 - 4.80)	1.112 (0.332 - 1.322)	4.98	97
20+22	2.00	2.20	4.20 (1.10 - 5.00)	1.107 (0.287 - 1.297)	4.96	97
20+25	2.00	2.50	4.50 (1.10 - 5.20)	1.177 (0.287 - 1.617)	5.28	97
20+35	1.93	3.37	5.30 (1.10 - 5.60)	1.857 (0.287 - 2.007)	8.32	97
20+42	1.71	3.59	5.30 (1.10 - 5.80)	1.857 (0.287 - 2.037)	8.32	97
20+50	1.51	3.79	5.30 (1.10 - 6.00)	1.732 (0.292 - 1.952)	7.76	97
22+22	2.20	2.20	4.40 (1.10 - 5.30)	1.102 (0.252 - 1.512)	4.94	97
22+25	2.20	2.50	4.70 (1.10 - 5.40)	1.162 (0.252 - 1.532)	5.21	97
22+35	2.05	3.25	5.30 (1.10 - 5.60)	1.512 (0.252 - 1.552)	6.78	97
22+42	1.82	3.48	5.30 (1.10 - 5.80)	1.512 (0.252 - 1.582)	6.78	97
22+50	1.62	3.68	5.30 (1.10 - 6.00)	1.508 (0.248 - 1.618)	6.76	97

MXZ-2D53VA(H) COOLING

Indoor units combination	Cooling capacity (kW)			Outdoor unit power consumption(kW)	Current (A)	Power factor(%)
	Unit A	Unit B	Total			
25+25	2.50	2.50	5.00 (1.10 - 5.60)	1.232 (0.252 - 1.552)	5.52	97
25+35	2.21	3.09	5.30 (1.10 - 5.80)	1.512 (0.252 - 1.582)	6.78	97
25+42	1.98	3.32	5.30 (1.10 - 5.80)	1.512 (0.252 - 1.582)	6.78	97
25+50	1.77	3.53	5.30 (1.10 - 6.00)	1.508 (0.248 - 1.618)	6.76	97
35+35	2.65	2.65	5.30 (1.10 - 6.00)	1.512 (0.252 - 1.622)	6.78	97

MXZ-2D53VA(H) HEATING

Indoor units combination	Heating capacity (kW)			Outdoor unit power consumption(kW)	Current (A)	Power factor(%)
	Unit A	Unit B	Total			
15	1.70	-	1.70 (0.90 - 3.10)	0.473 (0.203 - 1.143)	2.16	95
18	3.30	-	3.30 (0.90 - 4.00)	0.673 (0.113 - 0.913)	3.08	95
20	2.20	-	2.20 (0.90 - 3.30)	0.701 (0.201 - 1.171)	3.21	95
22	3.30	-	3.30 (0.90 - 4.00)	0.673 (0.113 - 0.913)	3.08	95
25	3.60	-	3.60 (0.90 - 4.50)	0.733 (0.113 - 1.053)	3.35	95
35	4.00	-	4.00 (0.90 - 4.80)	0.869 (0.109 - 1.149)	3.98	95
42	4.80	-	4.80 (0.90 - 5.30)	1.579 (0.099 - 1.999)	7.23	95
50	5.00	-	5.00 (0.90 - 5.50)	1.776 (0.096 - 2.076)	8.13	95
15+15	1.70	1.70	3.40 (1.00 - 5.00)	0.706 (0.356 - 1.176)	3.16	97
15+18	1.46	2.84	4.30 (1.00 - 5.30)	0.926 (0.356 - 1.246)	4.15	97
15+20	1.70	2.20	3.90 (1.00 - 5.20)	0.874 (0.364 - 1.314)	3.92	97
15+22	1.46	2.84	4.30 (1.00 - 5.30)	0.926 (0.356 - 1.246)	4.15	97
15+25	1.44	3.06	4.50 (1.00 - 5.40)	1.232 (0.442 - 1.752)	5.52	97
15+35	1.70	4.00	5.70 (1.00 - 7.00)	1.756 (0.276 - 2.126)	7.87	97
15+42	1.67	4.73	6.40 (1.00 - 7.00)	1.842 (0.282 - 2.122)	8.26	97
15+50	1.62	4.78	6.40 (1.00 - 7.00)	1.949 (0.279 - 2.249)	8.74	97
18+18	3.05	3.05	6.10 (1.00 - 6.70)	1.376 (0.196 - 1.736)	6.17	97
18+20	3.12	2.08	5.20 (1.00 - 6.10)	1.214 (0.364 - 1.484)	5.44	97
18+22	2.25	2.25	4.50 (1.00 - 5.40)	1.032 (0.362 - 1.452)	4.63	97
18+25	2.97	3.23	6.20 (1.00 - 6.80)	1.466 (0.196 - 1.766)	6.57	97
18+35	2.89	3.51	6.40 (1.00 - 7.00)	1.642 (0.202 - 1.822)	7.36	97
18+42	2.61	3.79	6.40 (1.00 - 7.00)	1.642 (0.202 - 1.822)	7.36	97
15+50	1.62	4.78	6.40 (1.00 - 7.00)	1.639 (0.199 - 1.819)	7.35	97
20+20	2.20	2.20	4.40 (1.00 - 5.40)	1.032 (0.362 - 1.452)	4.63	97
20+22	2.08	3.12	5.20 (1.00 - 6.10)	1.214 (0.364 - 1.484)	5.44	97
20+25	2.05	3.35	5.40 (1.00 - 6.20)	1.344 (0.364 - 1.574)	6.02	97
20+35	2.20	4.00	6.20 (1.00 - 7.00)	1.950 (0.280 - 2.250)	8.74	97
20+42	2.01	4.39	6.40 (1.00 - 7.00)	1.950 (0.280 - 2.250)	8.74	97
20+50	1.96	4.44	6.40 (1.00 - 7.00)	1.838 (0.278 - 2.118)	8.24	97
22+22	3.05	3.05	6.10 (1.00 - 6.70)	1.376 (0.196 - 1.736)	6.17	97
22+25	2.97	3.23	6.20 (1.00 - 6.80)	1.466 (0.196 - 1.766)	6.57	97
22+35	2.89	3.51	6.40 (1.00 - 7.00)	1.642 (0.202 - 1.822)	7.36	97
22+42	2.61	3.79	6.40 (1.00 - 7.00)	1.642 (0.202 - 1.822)	7.36	97
22+50	2.54	3.86	6.40 (1.00 - 7.00)	1.639 (0.199 - 1.819)	7.35	97

MXZ-2D53VA(H) HEATING

Indoor units combination	Heating capacity (kW)			Outdoor unit power consumption(kW)	Current (A)	Power factor(%)
	Unit A	Unit B	Total			
25+25	3.15	3.15	6.30 (1.00 - 7.00)	1.556 (0.196 - 1.826)	6.97	97
25+35	3.03	3.37	6.40 (1.00 - 7.00)	1.642 (0.202 - 1.822)	7.36	97
25+42	2.74	3.66	6.40 (1.00 - 7.00)	1.642 (0.202 - 1.822)	7.36	97
25+50	2.68	3.72	6.40 (1.00 - 7.00)	1.639 (0.199 - 1.819)	7.35	97
35+35	3.20	3.20	6.40 (1.00 - 7.00)	1.638 (0.198 - 1.818)	7.34	97

MXZ-3D54VA COOLING

Indoor units combination	Cooling capacity (kW)						Outdoor unit power consumption(kW)	Current (A)	Power factor(%)
	Unit A	Unit B	Unit C	Unit D	Unit E	Total			
15	1.50	-	-	-	-	1.50 (1.40-3.00)	0.490 (0.450-1.020)	2.15	99
18	1.80	-	-	-	-	1.80 (1.40-3.00)	0.420 (0.420-0.740)	1.84	99
20	2.00	-	-	-	-	2.00 (1.40-3.00)	0.540 (0.450-1.020)	2.37	99
22	2.20	-	-	-	-	2.20 (1.40-3.00)	0.510 (0.420-0.740)	2.24	99
25	2.50	-	-	-	-	2.50 (1.40-3.30)	0.580 (0.420-0.830)	2.55	99
35	3.50	-	-	-	-	3.50 (1.50-4.30)	0.820 (0.430-1.180)	3.60	99
42	4.20	-	-	-	-	4.20 (1.60-5.00)	1.080 (0.450-1.420)	4.74	99
50	5.00	-	-	-	-	5.00 (1.60-5.60)	1.430 (0.480-1.660)	6.28	99
15+15	1.50	1.50	-	-	-	3.00 (2.00-5.40)	0.790 (0.540-1.800)	3.47	99
15+18	1.50	1.80	-	-	-	3.30 (2.00-5.40)	0.841 (0.620-1.890)	3.69	99
15+20	1.50	2.00	-	-	-	3.50 (2.00-5.40)	0.885 (0.700-2.005)	3.89	99
15+22	1.50	2.20	-	-	-	3.70 (2.00-5.40)	0.929 (0.660-1.850)	4.08	99
15+25	1.50	2.50	-	-	-	4.00 (2.00-5.40)	1.130 (0.780-1.970)	4.96	99
15+35	1.50	3.50	-	-	-	5.00 (2.00-6.00)	1.470 (0.620-2.150)	6.46	99
15+42	1.42	3.98	-	-	-	5.40 (2.00-6.80)	1.613 (0.620-2.790)	7.08	99
15+50	1.25	4.15	-	-	-	5.40 (2.00-6.80)	1.613 (0.630-2.780)	7.08	99
18+18	1.80	1.80	-	-	-	3.60 (2.00-5.40)	0.832 (0.540-1.640)	3.65	99
18+20	1.80	2.00	-	-	-	3.80 (2.00-5.40)	0.996 (0.700-1.890)	4.37	99
18+22	1.80	2.20	-	-	-	4.00 (2.00-5.40)	1.100 (0.700-1.800)	4.83	99
18+25	1.80	2.50	-	-	-	4.30 (2.00-5.40)	1.177 (0.580-1.680)	5.17	99
18+35	1.80	3.50	-	-	-	5.30 (2.00-6.60)	1.547 (0.540-2.460)	6.79	99
18+42	1.62	3.78	-	-	-	5.40 (2.00-6.80)	1.583 (0.540-2.620)	6.95	99
18+50	1.43	3.97	-	-	-	5.40 (2.00-6.80)	1.583 (0.550-2.610)	6.95	99
20+20	2.00	2.00	-	-	-	4.00 (2.00-5.40)	1.100 (0.700-1.800)	4.83	99
20+22	2.00	2.20	-	-	-	4.20 (2.00-5.40)	1.181 (0.700-1.890)	5.19	99
20+25	2.00	2.50	-	-	-	4.50 (2.00-5.50)	1.272 (0.620-1.865)	5.59	99
20+35	1.96	3.44	-	-	-	5.40 (2.00-6.80)	1.613 (0.620-2.790)	7.08	99
20+42	1.74	3.66	-	-	-	5.40 (2.00-6.80)	1.613 (0.620-2.790)	7.08	99
20+50	1.54	3.86	-	-	-	5.40 (2.00-6.80)	1.613 (0.630-2.780)	7.08	99
22+22	2.20	2.20	-	-	-	4.40 (2.00-5.40)	1.202 (0.540-1.640)	5.28	99
22+25	2.20	2.50	-	-	-	4.70 (2.00-5.70)	1.321 (0.540-1.810)	5.80	99
22+35	2.08	3.32	-	-	-	5.40 (2.00-6.80)	1.583 (0.540-2.620)	6.95	99
22+42	1.86	3.54	-	-	-	5.40 (2.00-6.80)	1.583 (0.540-2.620)	6.95	99
22+50	1.65	3.75	-	-	-	5.40 (2.00-6.80)	1.583 (0.550-2.610)	6.95	99
25+25	2.50	2.50	-	-	-	5.00 (2.00-6.00)	1.440 (0.540-1.980)	6.32	99
25+35	2.25	3.15	-	-	-	5.40 (2.00-6.80)	1.583 (0.540-2.620)	6.95	99
25+42	2.01	3.39	-	-	-	5.40 (2.00-6.80)	1.583 (0.540-2.620)	6.95	99
25+50	1.80	3.60	-	-	-	5.40 (2.00-6.80)	1.583 (0.550-2.610)	6.95	99
35+35	2.70	2.70	-	-	-	5.40 (2.00-6.80)	1.583 (0.540-2.620)	6.95	99
35+42	2.45	2.95	-	-	-	5.40 (2.00-6.80)	1.583 (0.550-2.620)	6.95	99
35+50	2.22	3.18	-	-	-	5.40 (2.00-6.80)	1.580 (0.560-2.595)	6.94	99

MXZ-3D54VA COOLING

Indoor units combination	Cooling capacity (kW)						Outdoor unit power consumption(kW)	Current (A)	Power factor(%)
	Unit A	Unit B	Unit C	Unit D	Unit E	Total			
42+42	2.70	2.70	-	-	-	5.40 (2.00-6.80)	1.583 (0.550-2.620)	6.95	99
42+50	2.47	2.93	-	-	-	5.40 (2.10-6.80)	1.557 (0.570-2.470)	6.84	99
50+50	2.70	2.70	-	-	-	5.40 (2.10-6.80)	1.530 (0.560-2.340)	6.72	99
15+15+15	1.50	1.50	1.50	-	-	4.50 (2.90-6.80)	0.960 (0.670-1.770)	4.22	99
15+15+18	1.50	1.50	1.80	-	-	4.80 (2.90-6.80)	1.189 (0.730-2.130)	5.22	99
15+15+20	1.50	1.50	2.00	-	-	5.00 (2.90-6.80)	1.326 (0.760-2.310)	5.82	99
15+15+22	1.50	1.50	2.20	-	-	5.20 (2.90-6.80)	1.362 (0.730-2.130)	5.98	99
15+15+25	1.47	1.47	2.45	-	-	5.40 (2.90-6.80)	1.448 (0.730-2.130)	6.36	99
15+15+35	1.25	1.25	2.91	-	-	5.40 (2.90-6.80)	1.448 (0.730-2.130)	6.36	99
15+15+42	1.13	1.13	3.15	-	-	5.40 (2.90-6.80)	1.428 (0.730-2.120)	6.27	99
15+15+50	1.01	1.01	3.38	-	-	5.40 (2.90-6.80)	1.418 (0.730-2.110)	6.23	99
15+18+18	1.50	1.80	1.80	-	-	5.10 (2.90-6.80)	1.269 (0.700-1.950)	5.57	99
15+18+20	1.50	1.80	2.00	-	-	5.30 (2.90-6.80)	1.405 (0.730-2.130)	6.17	99
15+18+22	1.47	1.77	2.16	-	-	5.40 (2.90-6.80)	1.398 (0.700-1.950)	6.14	99
15+18+25	1.40	1.68	2.33	-	-	5.40 (2.90-6.80)	1.398 (0.700-1.950)	6.14	99
15+18+35	1.19	1.43	2.78	-	-	5.40 (2.90-6.80)	1.398 (0.700-1.950)	6.14	99
15+18+42	1.08	1.30	3.02	-	-	5.40 (2.90-6.80)	1.378 (0.700-1.940)	6.05	99
15+18+50	0.98	1.17	3.25	-	-	5.40 (2.90-6.80)	1.368 (0.700-1.930)	6.01	99
15+20+20	1.47	1.96	1.96	-	-	5.40 (2.90-6.80)	1.498 (0.760-2.310)	6.58	99
15+20+22	1.42	1.89	2.08	-	-	5.40 (2.90-6.80)	1.448 (0.730-2.130)	6.36	99
15+20+25	1.35	1.80	2.25	-	-	5.40 (2.90-6.80)	1.448 (0.730-2.130)	6.36	99
15+20+35	1.16	1.54	2.70	-	-	5.40 (2.90-6.80)	1.448 (0.730-2.130)	6.36	99
15+20+42	1.05	1.40	2.95	-	-	5.40 (2.90-6.80)	1.428 (0.730-2.120)	6.27	99
15+20+50	0.95	1.27	3.18	-	-	5.40 (2.90-6.80)	1.418 (0.730-2.110)	6.23	99
15+22+22	1.37	2.01	2.01	-	-	5.40 (2.90-6.80)	1.398 (0.700-1.950)	6.14	99
15+22+25	1.31	1.92	2.18	-	-	5.40 (2.90-6.80)	1.398 (0.700-1.950)	6.14	99
15+22+35	1.13	1.65	2.63	-	-	5.40 (2.90-6.80)	1.398 (0.700-1.950)	6.14	99
15+22+42	1.03	1.50	2.87	-	-	5.40 (2.90-6.80)	1.378 (0.700-1.940)	6.05	99
15+22+50	0.93	1.37	3.10	-	-	5.40 (2.90-6.80)	1.368 (0.700-1.930)	6.01	99
15+25+25	1.25	2.08	2.08	-	-	5.40 (2.90-6.80)	1.398 (0.700-1.950)	6.14	99
15+25+35	1.08	1.80	2.52	-	-	5.40 (2.90-6.80)	1.398 (0.700-1.950)	6.14	99
15+25+42	0.99	1.65	2.77	-	-	5.40 (2.90-6.80)	1.378 (0.700-1.940)	6.05	99
15+25+50	0.90	1.50	3.00	-	-	5.40 (2.90-6.80)	1.368 (0.700-1.930)	6.01	99
15+35+35	0.95	2.22	2.22	-	-	5.40 (2.90-6.80)	1.398 (0.700-1.950)	6.14	99
15+35+42	0.88	2.05	2.47	-	-	5.40 (2.90-6.80)	1.378 (0.700-1.940)	6.05	99
15+35+50	0.81	1.89	2.70	-	-	5.40 (2.90-6.80)	1.368 (0.700-1.930)	6.01	99
15+42+42	0.82	2.29	2.29	-	-	5.40 (2.90-6.80)	1.358 (0.700-1.930)	5.96	99
18+18+18	1.80	1.80	1.80	-	-	5.40 (2.90-6.80)	1.348 (0.670-1.770)	5.92	99
18+18+20	1.74	1.74	1.93	-	-	5.40 (2.90-6.80)	1.398 (0.700-1.950)	6.14	99
18+18+22	1.68	1.68	2.05	-	-	5.40 (2.90-6.80)	1.348 (0.670-1.770)	5.92	99
18+18+25	1.59	1.59	2.21	-	-	5.40 (2.90-6.80)	1.348 (0.670-1.770)	5.92	99

MXZ-3D54VA COOLING

Indoor units combination	Cooling capacity (kW)					Total	Outdoor unit power consumption(kW)	Current (A)	Power factor(%)
	Unit A	Unit B	Unit C	Unit D	Unit E				
18+18+35	1.37	1.37	2.66	-	-	5.40 (2.90-6.80)	1.348 (0.670-1.770)	5.92	99
18+18+42	1.25	1.25	2.91	-	-	5.40 (2.90-6.80)	1.328 (0.670-1.760)	5.83	99
18+18+50	1.13	1.13	3.14	-	-	5.40 (2.90-6.80)	1.318 (0.670-1.750)	5.79	99
18+20+20	1.68	1.86	1.86	-	-	5.40 (2.90-6.80)	1.448 (0.730-2.130)	6.36	99
18+20+22	1.62	1.80	1.98	-	-	5.40 (2.90-6.80)	1.398 (0.700-1.950)	6.14	99
18+20+25	1.54	1.71	2.14	-	-	5.40 (2.90-6.80)	1.398 (0.700-1.950)	6.14	99
18+20+35	1.33	1.48	2.59	-	-	5.40 (2.90-6.80)	1.398 (0.700-1.950)	6.14	99
18+20+42	1.22	1.35	2.84	-	-	5.40 (2.90-6.80)	1.378 (0.700-1.940)	6.05	99
18+20+50	1.10	1.23	3.07	-	-	5.40 (2.90-6.80)	1.368 (0.700-1.930)	6.01	99
18+22+22	1.57	1.92	1.92	-	-	5.40 (2.90-6.80)	1.348 (0.670-1.770)	5.92	99
18+22+25	1.50	1.83	2.08	-	-	5.40 (2.90-6.80)	1.348 (0.670-1.770)	5.92	99
18+22+35	1.30	1.58	2.52	-	-	5.40 (2.90-6.80)	1.348 (0.670-1.770)	5.92	99
18+22+42	1.19	1.45	2.77	-	-	5.40 (2.90-6.80)	1.328 (0.670-1.760)	5.83	99
18+22+50	1.08	1.32	3.00	-	-	5.40 (2.90-6.80)	1.318 (0.670-1.750)	5.79	99
18+25+25	1.43	1.99	1.99	-	-	5.40 (2.90-6.80)	1.348 (0.670-1.770)	5.92	99
18+25+35	1.25	1.73	2.42	-	-	5.40 (2.90-6.80)	1.348 (0.670-1.770)	5.92	99
18+25+42	1.14	1.59	2.67	-	-	5.40 (2.90-6.80)	1.328 (0.670-1.760)	5.83	99
18+25+50	1.05	1.45	2.90	-	-	5.40 (2.90-6.80)	1.318 (0.670-1.750)	5.79	99
18+35+35	1.10	2.15	2.15	-	-	5.40 (2.90-6.80)	1.348 (0.670-1.770)	5.92	99
18+35+42	1.02	1.99	2.39	-	-	5.40 (2.90-6.80)	1.328 (0.670-1.760)	5.83	99
20+20+20	1.80	1.80	1.80	-	-	5.40 (2.90-6.80)	1.498 (0.760-2.310)	6.58	99
20+20+22	1.74	1.74	1.92	-	-	5.40 (2.90-6.80)	1.448 (0.730-2.130)	6.36	99
20+20+25	1.66	1.66	2.08	-	-	5.40 (2.90-6.80)	1.448 (0.730-2.130)	6.36	99
20+20+35	1.44	1.44	2.52	-	-	5.40 (2.90-6.80)	1.448 (0.730-2.130)	6.36	99
20+20+42	1.32	1.32	2.77	-	-	5.40 (2.90-6.80)	1.428 (0.730-2.120)	6.27	99
20+20+50	1.20	1.20	3.00	-	-	5.40 (2.90-6.80)	1.418 (0.730-2.110)	6.23	99
20+22+22	1.69	1.86	1.86	-	-	5.40 (2.90-6.80)	1.398 (0.700-1.950)	6.14	99
20+22+25	1.61	1.77	2.01	-	-	5.40 (2.90-6.80)	1.398 (0.700-1.950)	6.14	99
20+22+35	1.40	1.54	2.45	-	-	5.40 (2.90-6.80)	1.398 (0.700-1.950)	6.14	99
20+22+42	1.29	1.41	2.70	-	-	5.40 (2.90-6.80)	1.378 (0.700-1.940)	6.05	99
20+22+50	1.17	1.29	2.93	-	-	5.40 (2.90-6.80)	1.368 (0.700-1.930)	6.01	99
20+25+25	1.54	1.93	1.93	-	-	5.40 (2.90-6.80)	1.398 (0.700-1.950)	6.14	99
20+25+35	1.35	1.69	2.36	-	-	5.40 (2.90-6.80)	1.398 (0.700-1.950)	6.14	99
20+25+42	1.24	1.55	2.61	-	-	5.40 (2.90-6.80)	1.378 (0.700-1.940)	6.05	99
20+25+50	1.14	1.42	2.84	-	-	5.40 (2.90-6.80)	1.368 (0.700-1.930)	6.01	99
20+35+35	1.20	2.10	2.10	-	-	5.40 (2.90-6.80)	1.398 (0.700-1.950)	6.14	99
20+35+42	1.11	1.95	2.34	-	-	5.40 (2.90-6.80)	1.378 (0.700-1.940)	6.05	99
22+22+22	1.80	1.80	1.80	-	-	5.40 (2.90-6.80)	1.348 (0.670-1.770)	5.92	99
22+22+25	1.72	1.72	1.96	-	-	5.40 (2.90-6.80)	1.348 (0.670-1.770)	5.92	99
22+22+35	1.50	1.50	2.39	-	-	5.40 (2.90-6.80)	1.348 (0.670-1.770)	5.92	99
22+22+42	1.38	1.38	2.64	-	-	5.40 (2.90-6.80)	1.328 (0.670-1.760)	5.83	99

MXZ-3D54VA COOLING

Indoor units combination	Cooling capacity (kW)						Outdoor unit power consumption(kW)	Current (A)	Power factor(%)
	Unit A	Unit B	Unit C	Unit D	Unit E	Total			
22+22+50	1.26	1.26	2.87	-	-	5.40 (2.90-6.80)	1.318 (0.670-1.750)	5.79	99
22+25+25	1.65	1.88	1.88	-	-	5.40 (2.90-6.80)	1.348 (0.670-1.770)	5.92	99
22+25+35	1.45	1.65	2.30	-	-	5.40 (2.90-6.80)	1.348 (0.670-1.770)	5.92	99
22+25+42	1.33	1.52	2.55	-	-	5.40 (2.90-6.80)	1.328 (0.670-1.760)	5.83	99
22+25+50	1.22	1.39	2.78	-	-	5.40 (2.90-6.80)	1.318 (0.670-1.750)	5.79	99
22+35+35	1.29	2.05	2.05	-	-	5.40 (2.90-6.80)	1.348 (0.670-1.770)	5.92	99
22+35+42	1.20	1.91	2.29	-	-	5.40 (2.90-6.80)	1.328 (0.670-1.760)	5.83	99
25+25+25	1.80	1.80	1.80	-	-	5.40 (2.90-6.80)	1.348 (0.670-1.770)	5.92	99
25+25+35	1.59	1.59	2.22	-	-	5.40 (2.90-6.80)	1.348 (0.670-1.770)	5.92	99
25+25+42	1.47	1.47	2.47	-	-	5.40 (2.90-6.80)	1.328 (0.670-1.760)	5.83	99
25+25+50	1.35	1.35	2.70	-	-	5.40 (2.90-6.80)	1.318 (0.670-1.750)	5.79	99
25+35+35	1.42	1.99	1.99	-	-	5.40 (2.90-6.80)	1.348 (0.670-1.770)	5.92	99

MXZ-3D54VA HEATING

Indoor units combination	Heating capacity (kW)						Outdoor unit power consumption(kW)	Current (A)	Power factor(%)
	Unit A	Unit B	Unit C	Unit D	Unit E	Total			
15	1.70	-	-	-	-	1.70 (1.20-3.00)	0.460 (0.400-1.020)	2.02	99
18	3.30	-	-	-	-	3.30 (1.20-4.20)	0.780 (0.380-1.090)	3.43	99
20	2.20	-	-	-	-	2.20 (1.20-3.90)	0.610 (0.390-1.440)	2.68	99
22	3.30	-	-	-	-	3.30 (1.20-4.20)	0.780 (0.380-1.090)	3.43	99
25	3.60	-	-	-	-	3.60 (1.20-4.50)	0.880 (0.380-1.190)	3.86	99
35	4.00	-	-	-	-	4.00 (1.20-4.80)	1.020 (0.380-1.300)	4.48	99
42	5.40	-	-	-	-	5.40 (1.30-6.50)	1.400 (0.370-1.800)	6.15	99
50	6.80	-	-	-	-	6.80 (1.40-8.20)	1.770 (0.370-2.300)	7.77	99
15+15	1.70	1.70	-	-	-	3.40 (1.80-5.00)	0.796 (0.670-1.300)	3.50	99
15+18	1.70	3.30	-	-	-	5.00 (1.80-6.10)	1.146 (0.540-1.530)	5.03	99
15+20	1.70	2.20	-	-	-	3.90 (1.80-5.80)	0.966 (0.650-1.625)	4.24	99
15+22	1.70	3.30	-	-	-	5.00 (1.80-6.10)	1.146 (0.540-1.530)	5.03	99
15+25	1.60	3.40	-	-	-	5.00 (1.80-6.10)	1.146 (0.540-1.530)	5.03	99
15+35	1.55	3.65	-	-	-	5.20 (1.80-7.90)	1.230 (0.540-2.090)	5.40	99
15+42	1.25	3.95	-	-	-	5.20 (1.80-7.90)	1.230 (0.540-2.090)	5.40	99
15+50	1.04	4.16	-	-	-	5.20 (1.80-7.90)	1.220 (0.540-2.080)	5.36	99
18+18	3.30	3.30	-	-	-	6.60 (1.80-7.20)	1.496 (0.410-1.760)	6.57	99
18+20	3.30	2.20	-	-	-	5.50 (1.80-6.90)	1.316 (0.520-1.855)	5.78	99
18+22	3.30	3.30	-	-	-	6.60 (1.80-7.20)	1.496 (0.410-1.760)	6.57	99
18+25	3.16	3.44	-	-	-	6.60 (1.80-7.20)	1.496 (0.410-1.760)	6.57	99
18+35	3.07	3.73	-	-	-	6.80 (1.80-9.00)	1.580 (0.410-2.320)	6.94	99
18+42	2.58	4.22	-	-	-	6.80 (1.80-9.00)	1.580 (0.410-2.320)	6.94	99
18+50	2.22	4.58	-	-	-	6.80 (1.80-9.00)	1.570 (0.410-2.310)	6.90	99
20+20	2.20	2.20	-	-	-	4.40 (1.80-6.60)	1.136 (0.630-1.950)	4.99	99
20+22	2.20	3.30	-	-	-	5.50 (1.80-6.90)	1.316 (0.520-1.855)	5.78	99
20+25	2.09	3.41	-	-	-	5.50 (1.80-7.20)	1.330 (0.520-1.950)	5.84	99
20+35	2.02	3.68	-	-	-	5.70 (1.80-8.70)	1.400 (0.520-2.415)	6.15	99
20+42	1.65	4.05	-	-	-	5.70 (1.80-8.70)	1.400 (0.520-2.415)	6.15	99
20+50	1.39	4.31	-	-	-	5.70 (1.80-8.70)	1.390 (0.520-2.405)	6.10	99
22+22	3.30	3.30	-	-	-	6.60 (1.80-7.20)	1.496 (0.410-1.760)	6.57	99
22+25	3.20	3.50	-	-	-	6.70 (1.80-8.10)	1.538 (0.410-2.040)	6.75	99
22+35	3.07	3.73	-	-	-	6.80 (1.80-9.00)	1.580 (0.410-2.320)	6.94	99
22+42	2.58	4.22	-	-	-	6.80 (1.80-9.00)	1.580 (0.410-2.320)	6.94	99
22+50	2.22	4.58	-	-	-	6.80 (1.80-9.00)	1.550 (0.410-2.300)	6.81	99
25+25	3.40	3.40	-	-	-	6.80 (1.80-9.00)	1.580 (0.410-2.320)	6.94	99
25+35	3.22	3.58	-	-	-	6.80 (1.80-9.00)	1.580 (0.410-2.320)	6.94	99
25+42	2.72	4.08	-	-	-	6.80 (1.80-9.00)	1.580 (0.410-2.320)	6.94	99
25+50	2.35	4.45	-	-	-	6.80 (1.80-9.00)	1.520 (0.410-2.290)	6.68	99
35+35	3.40	3.40	-	-	-	6.80 (1.80-9.00)	1.580 (0.410-2.320)	6.94	99
35+42	2.89	3.91	-	-	-	6.80 (1.80-9.00)	1.510 (0.410-2.290)	6.63	99
35+50	2.52	4.28	-	-	-	6.80 (1.80-9.00)	1.427 (0.410-2.240)	6.27	99

MXZ-3D54VA HEATING

Indoor units combination	Heating capacity (kW)						Outdoor unit power consumption(kW)	Current (A)	Power factor(%)
	Unit A	Unit B	Unit C	Unit D	Unit E	Total			
42+42	3.40	3.40	-	-	-	6.80 (1.80-9.00)	1.440 (0.410-2.260)	6.32	99
42+50	3.01	3.79	-	-	-	6.80 (1.90-9.00)	1.405 (0.390-2.170)	6.17	99
50+50	3.40	3.40	-	-	-	6.80 (1.90-9.00)	1.370 (0.360-2.080)	6.02	99
15+15+15	1.70	1.70	1.70	-	-	5.10 (2.60-7.90)	1.149 (0.710-2.410)	5.05	99
15+15+18	1.47	1.47	2.86	-	-	5.80 (2.60-8.40)	1.269 (0.640-2.300)	5.57	99
15+15+20	1.70	1.70	2.20	-	-	5.60 (2.60-8.10)	1.319 (0.600-2.380)	5.79	99
15+15+22	1.47	1.47	2.86	-	-	5.80 (2.60-8.40)	1.269 (0.560-2.300)	5.57	99
15+15+25	1.41	1.41	2.98	-	-	5.80 (2.60-8.40)	1.269 (0.550-2.300)	5.57	99
15+15+35	1.33	1.33	3.14	-	-	5.80 (2.60-8.40)	1.269 (0.550-2.300)	5.57	99
15+15+42	1.12	1.12	3.56	-	-	5.80 (2.60-8.40)	1.269 (0.520-2.300)	5.57	99
15+15+50	0.97	0.97	3.87	-	-	5.80 (2.60-8.40)	1.269 (0.520-2.300)	5.57	99
15+18+18	1.31	2.54	2.54	-	-	6.40 (2.60-8.70)	1.389 (0.570-2.190)	6.10	99
15+18+20	1.49	2.89	1.93	-	-	6.30 (2.60-8.40)	1.439 (0.530-2.270)	6.32	99
15+18+22	1.31	2.54	2.54	-	-	6.40 (2.60-8.70)	1.389 (0.540-2.190)	6.10	99
15+18+25	1.27	2.46	2.68	-	-	6.40 (2.60-8.70)	1.389 (0.630-2.190)	6.10	99
15+18+35	1.21	2.35	2.84	-	-	6.40 (2.60-8.70)	1.389 (0.510-2.190)	6.10	99
15+18+42	1.05	2.03	3.32	-	-	6.40 (2.60-8.70)	1.389 (0.510-2.190)	6.10	99
15+18+50	0.92	1.79	3.69	-	-	6.40 (2.60-8.70)	1.389 (0.510-2.190)	6.10	99
15+20+20	1.70	2.20	2.20	-	-	6.10 (2.60-8.10)	1.489 (0.540-2.350)	6.54	99
15+20+22	1.49	1.93	2.89	-	-	6.30 (2.60-8.40)	1.439 (0.600-2.270)	6.32	99
15+20+25	1.43	1.85	3.02	-	-	6.30 (2.60-8.40)	1.439 (0.690-2.270)	6.32	99
15+20+35	1.36	1.75	3.19	-	-	6.30 (2.60-8.40)	1.439 (0.510-2.270)	6.32	99
15+20+42	1.15	1.49	3.66	-	-	6.30 (2.60-8.40)	1.439 (0.510-2.270)	6.32	99
15+20+50	1.00	1.30	4.00	-	-	6.30 (2.60-8.40)	1.439 (0.510-2.270)	6.32	99
15+22+22	1.31	2.54	2.54	-	-	6.40 (2.60-8.70)	1.389 (0.660-2.190)	6.10	99
15+22+25	1.27	2.46	2.68	-	-	6.40 (2.60-8.70)	1.389 (0.630-2.190)	6.10	99
15+22+35	1.21	2.35	2.84	-	-	6.40 (2.60-8.70)	1.389 (0.510-2.190)	6.10	99
15+22+42	1.05	2.03	3.32	-	-	6.40 (2.60-8.70)	1.389 (0.510-2.190)	6.10	99
15+22+50	0.92	1.79	3.69	-	-	6.40 (2.60-8.70)	1.389 (0.510-2.190)	6.10	99
15+25+25	1.22	2.59	2.59	-	-	6.40 (2.60-8.70)	1.389 (0.540-2.190)	6.10	99
15+25+35	1.17	2.48	2.75	-	-	6.40 (2.60-8.70)	1.389 (0.510-2.190)	6.10	99
15+25+42	1.02	2.15	3.23	-	-	6.40 (2.60-8.70)	1.389 (0.510-2.190)	6.10	99
15+25+50	0.90	1.90	3.60	-	-	6.40 (2.60-8.70)	1.389 (0.510-2.190)	6.10	99
15+35+35	1.12	2.64	2.64	-	-	6.40 (2.60-8.70)	1.389 (0.510-2.190)	6.10	99
15+35+42	0.98	2.31	3.11	-	-	6.40 (2.60-8.70)	1.389 (0.510-2.190)	6.10	99
15+35+50	0.87	2.05	3.48	-	-	6.40 (2.60-8.70)	1.389 (0.510-2.190)	6.10	99
15+42+42	0.87	2.76	2.76	-	-	6.40 (2.60-8.70)	1.389 (0.510-2.190)	6.10	99
18+18+18	2.33	2.33	2.33	-	-	7.00 (2.60-9.00)	1.509 (0.500-2.080)	6.63	99
18+18+20	2.59	2.59	1.73	-	-	6.90 (2.60-8.70)	1.559 (0.560-2.160)	6.85	99
18+18+22	2.33	2.33	2.33	-	-	7.00 (2.60-9.00)	1.509 (0.620-2.080)	6.63	99
18+18+25	2.26	2.26	2.47	-	-	7.00 (2.60-9.00)	1.509 (0.650-2.080)	6.63	99

MXZ-3D54VA HEATING

Indoor units combination	Heating capacity (kW)						Outdoor unit power consumption(kW)	Current (A)	Power factor(%)
	Unit A	Unit B	Unit C	Unit D	Unit E	Total			
18+18+35	2.18	2.18	2.64	-	-	7.00 (2.60-9.00)	1.509 (0.500-2.080)	6.63	99
18+18+42	1.93	1.93	3.15	-	-	7.00 (2.60-9.00)	1.509 (0.500-2.080)	6.63	99
18+18+50	1.72	1.72	3.55	-	-	7.00 (2.60-9.00)	1.509 (0.500-2.080)	6.63	99
18+20+20	2.91	1.94	1.94	-	-	6.80 (2.60-8.40)	1.609 (0.620-2.240)	7.07	99
18+20+22	2.59	1.73	2.59	-	-	6.90 (2.60-8.70)	1.559 (0.680-2.160)	6.85	99
18+20+25	2.50	1.67	2.73	-	-	6.90 (2.60-8.70)	1.559 (0.590-2.160)	6.85	99
18+20+35	2.40	1.60	2.91	-	-	6.90 (2.60-8.70)	1.559 (0.500-2.160)	6.85	99
18+20+42	2.09	1.39	3.42	-	-	6.90 (2.60-8.70)	1.559 (0.500-2.160)	6.85	99
18+20+50	1.85	1.23	3.81	-	-	6.90 (2.60-8.70)	1.559 (0.500-2.160)	6.85	99
18+22+22	2.33	2.33	2.33	-	-	7.00 (2.60-9.00)	1.509 (0.620-2.080)	6.63	99
18+22+25	2.26	2.26	2.47	-	-	7.00 (2.60-9.00)	1.509 (0.530-2.080)	6.63	99
18+22+35	2.18	2.18	2.64	-	-	7.00 (2.60-9.00)	1.509 (0.500-2.080)	6.63	99
18+22+42	1.93	1.93	3.15	-	-	7.00 (2.60-9.00)	1.509 (0.500-2.080)	6.63	99
18+22+50	1.72	1.72	3.55	-	-	7.00 (2.60-9.00)	1.509 (0.500-2.080)	6.63	99
18+25+25	2.20	2.40	2.40	-	-	7.00 (2.60-9.00)	1.509 (0.500-2.080)	6.63	99
18+25+35	2.12	2.31	2.57	-	-	7.00 (2.60-9.00)	1.509 (0.500-2.080)	6.63	99
18+25+42	1.88	2.05	3.07	-	-	7.00 (2.60-9.00)	1.509 (0.500-2.080)	6.63	99
18+25+50	1.69	1.84	3.47	-	-	7.00 (2.60-9.00)	1.509 (0.500-2.080)	6.63	99
18+35+35	2.04	2.48	2.48	-	-	7.00 (2.60-9.00)	1.509 (0.500-2.080)	6.63	99
18+35+42	1.82	2.20	2.98	-	-	7.00 (2.60-9.00)	1.509 (0.500-2.080)	6.63	99
20+20+20	2.20	2.20	2.20	-	-	6.60 (2.60-8.00)	1.659 (0.680-2.320)	7.29	99
20+20+22	1.94	1.94	2.91	-	-	6.80 (2.60-8.40)	1.609 (0.620-2.240)	7.07	99
20+20+25	1.87	1.87	3.06	-	-	6.80 (2.60-8.40)	1.609 (0.530-2.240)	7.07	99
20+20+35	1.78	1.78	3.24	-	-	6.80 (2.60-8.40)	1.609 (0.500-2.240)	7.07	99
20+20+42	1.53	1.53	3.75	-	-	6.80 (2.60-8.40)	1.609 (0.500-2.240)	7.07	99
20+20+50	1.34	1.34	4.13	-	-	6.80 (2.60-8.40)	1.609 (0.500-2.240)	7.07	99
20+22+22	1.73	2.59	2.59	-	-	6.90 (2.60-8.70)	1.559 (0.560-2.160)	6.85	99
20+22+25	1.67	2.50	2.73	-	-	6.90 (2.60-8.70)	1.559 (0.500-2.160)	6.85	99
20+22+35	1.60	2.40	2.91	-	-	6.90 (2.60-8.70)	1.559 (0.500-2.160)	6.85	99
20+22+42	1.39	2.09	3.42	-	-	6.90 (2.60-8.70)	1.559 (0.500-2.160)	6.85	99
20+22+50	1.23	1.85	3.81	-	-	6.90 (2.60-8.70)	1.559 (0.500-2.160)	6.85	99
20+25+25	1.61	2.64	2.64	-	-	6.90 (2.60-8.70)	1.559 (0.500-2.160)	6.85	99
20+25+35	1.55	2.53	2.82	-	-	6.90 (2.60-8.70)	1.559 (0.500-2.160)	6.85	99
20+25+42	1.36	2.22	3.33	-	-	6.90 (2.60-8.70)	1.559 (0.500-2.160)	6.85	99
20+25+50	1.20	1.97	3.72	-	-	6.90 (2.60-8.70)	1.559 (0.500-2.160)	6.85	99
20+35+35	1.49	2.71	2.71	-	-	6.90 (2.60-8.70)	1.559 (0.500-2.160)	6.85	99
20+35+42	1.31	2.38	3.21	-	-	6.90 (2.60-8.70)	1.559 (0.500-2.160)	6.85	99
22+22+22	2.33	2.33	2.33	-	-	7.00 (2.60-9.00)	1.509 (0.500-2.080)	6.63	99
22+22+25	2.26	2.26	2.47	-	-	7.00 (2.60-9.00)	1.509 (0.500-2.080)	6.63	99
22+22+35	2.18	2.18	2.64	-	-	7.00 (2.60-9.00)	1.509 (0.500-2.080)	6.63	99
22+22+42	1.93	1.93	3.15	-	-	7.00 (2.60-9.00)	1.509 (0.500-2.080)	6.63	99

MXZ-3D54VA HEATING

Indoor units combination	Heating capacity (kW)						Outdoor unit power consumption(kW)	Current (A)	Power factor(%)
	Unit A	Unit B	Unit C	Unit D	Unit E	Total			
22+22+50	1.72	1.72	3.55	-	-	7.00 (2.60-9.00)	1.509 (0.500-2.080)	6.63	99
22+25+25	2.20	2.40	2.40	-	-	7.00 (2.60-9.00)	1.509 (0.500-2.080)	6.63	99
22+25+35	2.12	2.31	2.57	-	-	7.00 (2.60-9.00)	1.509 (0.500-2.080)	6.63	99
22+25+42	1.88	2.05	3.07	-	-	7.00 (2.60-9.00)	1.509 (0.500-2.080)	6.63	99
22+25+50	1.69	1.84	3.47	-	-	7.00 (2.60-9.00)	1.509 (0.500-2.080)	6.63	99
22+35+35	2.04	2.48	2.48	-	-	7.00 (2.60-9.00)	1.509 (0.500-2.080)	6.63	99
22+35+42	1.82	2.20	2.98	-	-	7.00 (2.60-9.00)	1.509 (0.500-2.080)	6.63	99
25+25+25	2.33	2.33	2.33	-	-	7.00 (2.60-9.00)	1.509 (0.500-2.080)	6.63	99
25+25+35	2.25	2.25	2.50	-	-	7.00 (2.60-9.00)	1.509 (0.500-2.080)	6.63	99
25+25+42	2.00	2.00	3.00	-	-	7.00 (2.60-9.00)	1.509 (0.500-2.080)	6.63	99
25+25+50	1.80	1.80	3.40	-	-	7.00 (2.60-9.00)	1.509 (0.500-2.080)	6.63	99
25+35+35	2.17	2.41	2.41	-	-	7.00 (2.60-9.00)	1.509 (0.500-2.080)	6.63	99

MXZ-3D68VA COOLING

Indoor units combination	Cooling capacity (kW)						Outdoor unit power consumption(kW)	Current (A)	Power factor(%)
	Unit A	Unit B	Unit C	Unit D	Unit E	Total			
15	1.50	-	-	-	-	1.50 (1.40-3.00)	0.490 (0.450-1.020)	2.15	99
18	1.80	-	-	-	-	1.80 (1.40-3.00)	0.420 (0.420-0.740)	1.84	99
20	2.00	-	-	-	-	2.00 (1.40-3.00)	0.540 (0.450-1.020)	2.37	99
22	2.20	-	-	-	-	2.20 (1.40-3.00)	0.510 (0.420-0.740)	2.24	99
25	2.50	-	-	-	-	2.50 (1.40-3.30)	0.580 (0.420-0.830)	2.55	99
35	3.50	-	-	-	-	3.50 (1.50-4.30)	0.820 (0.430-1.180)	3.60	99
42	4.20	-	-	-	-	4.20 (1.60-5.00)	1.080 (0.450-1.420)	4.74	99
50	5.00	-	-	-	-	5.00 (1.60-5.60)	1.430 (0.480-1.660)	6.28	99
60	6.00	-	-	-	-	6.00 (1.60-6.60)	1.700 (0.480-2.250)	7.47	99
15+15	1.50	1.50	-	-	-	3.00 (2.00-5.40)	0.790 (0.540-1.800)	3.47	99
15+18	1.50	1.80	-	-	-	3.30 (2.00-5.40)	0.841 (0.620-1.890)	3.69	99
15+20	1.50	2.00	-	-	-	3.50 (2.00-5.40)	0.885 (0.700-2.005)	3.89	99
15+22	1.50	2.20	-	-	-	3.70 (2.00-5.40)	0.929 (0.660-1.850)	4.08	99
15+25	1.50	2.50	-	-	-	4.00 (2.00-5.40)	1.130 (0.780-1.970)	4.96	99
15+35	1.50	3.50	-	-	-	5.00 (2.00-6.00)	1.470 (0.620-2.150)	6.46	99
15+42	1.50	4.20	-	-	-	5.70 (2.00-6.40)	1.691 (0.620-2.500)	7.43	99
15+50	1.50	5.00	-	-	-	6.50 (2.00-6.90)	2.064 (0.630-2.860)	9.06	99
15+60	1.36	5.44	-	-	-	6.80 (2.00-7.10)	2.232 (0.640-2.980)	9.80	99
18+18	1.80	1.80	-	-	-	3.60 (2.00-5.40)	0.832 (0.540-1.640)	3.65	99
18+20	1.80	2.00	-	-	-	3.80 (2.00-5.40)	0.996 (0.700-1.890)	4.37	99
18+22	1.80	2.20	-	-	-	4.00 (2.00-5.40)	1.100 (0.700-1.800)	4.83	99
18+25	1.80	2.50	-	-	-	4.30 (2.00-5.40)	1.177 (0.580-1.680)	5.17	99
18+35	1.80	3.50	-	-	-	5.30 (2.00-6.20)	1.535 (0.540-2.130)	6.74	99
18+42	1.80	4.20	-	-	-	6.00 (2.00-6.60)	1.755 (0.540-2.480)	7.71	99
18+60	1.57	5.23	-	-	-	6.80 (2.00-7.10)	2.202 (0.560-2.810)	9.67	99
20+20	2.00	2.00	-	-	-	4.00 (2.00-5.40)	1.100 (0.700-1.800)	4.83	99
20+22	2.00	2.20	-	-	-	4.20 (2.00-5.40)	1.181 (0.700-1.890)	5.19	99
20+25	2.00	2.50	-	-	-	4.50 (2.00-5.50)	1.272 (0.620-1.865)	5.59	99
20+35	2.00	3.50	-	-	-	5.50 (2.00-6.30)	1.628 (0.620-2.400)	7.15	99
20+42	2.00	4.20	-	-	-	6.20 (2.00-6.70)	1.897 (0.620-2.740)	8.33	99
20+50	1.94	4.86	-	-	-	6.80 (2.00-7.10)	2.232 (0.630-2.990)	9.80	99
20+60	1.70	5.10	-	-	-	6.80 (2.00-7.10)	2.232 (0.640-2.980)	9.80	99
22+22	2.20	2.20	-	-	-	4.40 (2.00-5.40)	1.202 (0.540-1.640)	5.28	99
22+25	2.20	2.50	-	-	-	4.70 (2.00-5.70)	1.321 (0.540-1.810)	5.80	99
22+35	2.20	3.50	-	-	-	5.70 (2.00-6.40)	1.661 (0.540-2.330)	7.29	99
22+42	2.20	4.20	-	-	-	6.40 (2.00-6.90)	1.979 (0.540-2.655)	8.69	99
22+50	2.08	4.72	-	-	-	6.80 (2.00-7.10)	2.202 (0.550-2.820)	9.67	99
22+60	1.82	4.98	-	-	-	6.80 (2.00-7.10)	2.202 (0.560-2.810)	9.67	99
25+25	2.50	2.50	-	-	-	5.00 (2.00-6.00)	1.440 (0.540-1.980)	6.32	99
25+35	2.50	3.50	-	-	-	6.00 (2.00-6.60)	1.755 (0.540-2.480)	7.71	99
25+42	2.50	4.20	-	-	-	6.70 (2.00-7.00)	2.146 (0.540-2.785)	9.42	99

MXZ-3D68VA COOLING

Indoor units combination	Cooling capacity (kW)						Outdoor unit power consumption(kW)	Current (A)	Power factor(%)
	Unit A	Unit B	Unit C	Unit D	Unit E	Total			
25+50	2.27	4.53	-	-	-	6.80 (2.00-7.10)	2.202 (0.550-2.820)	9.67	99
25+60	2.00	4.80	-	-	-	6.80 (2.00-7.10)	2.194 (0.560-2.810)	9.64	99
35+35	3.40	3.40	-	-	-	6.80 (2.00-7.10)	2.202 (0.540-2.830)	9.67	99
35+42	3.09	3.71	-	-	-	6.80 (2.00-7.10)	2.202 (0.540-2.830)	9.67	99
35+50	2.80	4.00	-	-	-	6.80 (2.00-7.10)	2.194 (0.550-2.820)	9.64	99
35+60	2.51	4.29	-	-	-	6.80 (2.10-7.10)	2.119 (0.570-2.830)	9.31	99
42+42	3.40	3.40	-	-	-	6.80 (2.00-7.10)	2.202 (0.540-2.830)	9.67	99
42+50	3.10	3.70	-	-	-	6.80 (2.10-7.10)	2.142 (0.560-2.835)	9.41	99
42+60	2.80	4.00	-	-	-	6.80 (2.10-7.10)	2.064 (0.580-2.845)	9.06	99
50+50	3.40	3.40	-	-	-	6.80 (2.10-7.10)	2.081 (0.560-2.860)	9.14	99
50+60	3.09	3.71	-	-	-	6.80 (2.10-7.10)	1.997 (0.600-2.860)	8.77	99
60+60	3.40	3.40	-	-	-	6.80 (2.10-7.10)	1.912 (0.580-2.920)	8.40	99
15+15+15	1.50	1.50	1.50	-	-	4.50 (2.90-6.80)	0.810 (0.670-1.770)	3.56	99
15+15+18	1.50	1.50	1.80	-	-	4.80 (2.90-6.80)	1.097 (0.750-2.130)	4.82	99
15+15+20	1.50	1.50	2.00	-	-	5.00 (2.90-6.60)	1.267 (0.790-2.160)	5.56	99
15+15+22	1.50	1.50	2.20	-	-	5.20 (2.90-6.80)	1.336 (0.750-2.130)	5.87	99
15+15+25	1.50	1.50	2.50	-	-	5.50 (2.90-7.00)	1.499 (0.750-2.305)	6.58	99
15+15+35	1.50	1.50	3.50	-	-	6.50 (2.90-8.10)	1.928 (0.750-3.235)	8.47	99
15+15+42	1.42	1.42	3.97	-	-	6.80 (2.90-8.40)	2.236 (0.750-3.280)	9.82	99
15+15+50	1.28	1.28	4.25	-	-	6.80 (2.90-8.40)	2.165 (0.750-3.270)	9.51	99
15+15+60	1.13	1.13	4.53	-	-	6.80 (2.90-8.40)	2.012 (0.750-3.255)	8.84	99
15+18+18	1.50	1.80	1.80	-	-	5.10 (2.90-6.80)	1.223 (0.710-1.950)	5.37	99
15+18+20	1.50	1.80	2.00	-	-	5.30 (2.90-6.60)	1.392 (0.750-1.980)	6.11	99
15+18+22	1.50	1.80	2.20	-	-	5.50 (2.90-7.00)	1.445 (0.710-2.125)	6.35	99
15+18+25	1.50	1.80	2.50	-	-	5.80 (2.90-7.70)	1.574 (0.710-2.645)	6.91	99
15+18+42	1.36	1.63	3.81	-	-	6.80 (2.90-8.40)	2.182 (0.710-3.100)	9.58	99
15+18+50	1.23	1.47	4.10	-	-	6.80 (2.90-8.40)	2.074 (0.710-3.085)	9.11	99
15+18+60	1.10	1.32	4.39	-	-	6.80 (2.90-8.40)	1.921 (0.710-3.075)	8.44	99
15+20+20	1.50	2.00	2.00	-	-	5.50 (2.90-6.60)	1.545 (0.790-2.185)	6.79	99
15+20+22	1.50	2.00	2.20	-	-	5.70 (2.90-7.30)	1.581 (0.750-2.500)	6.94	99
15+20+25	1.50	2.00	2.50	-	-	6.00 (2.90-7.90)	1.710 (0.750-3.020)	7.51	99
15+20+35	1.46	1.94	3.40	-	-	6.80 (2.90-8.20)	2.252 (0.750-3.140)	9.89	99
15+20+42	1.32	1.77	3.71	-	-	6.80 (2.90-8.20)	2.207 (0.750-3.130)	9.69	99
15+20+50	1.20	1.60	4.00	-	-	6.80 (2.90-8.20)	2.099 (0.750-3.115)	9.22	99
15+20+60	1.07	1.43	4.29	-	-	6.80 (2.90-8.20)	1.946 (0.750-3.105)	8.55	99
15+22+22	1.50	2.20	2.20	-	-	5.90 (2.90-7.90)	1.617 (0.710-2.815)	7.10	99
15+22+25	1.50	2.20	2.50	-	-	6.20 (2.90-8.10)	1.746 (0.710-3.015)	7.67	99
15+22+35	1.42	2.08	3.31	-	-	6.80 (2.90-8.40)	2.202 (0.710-3.110)	9.67	99
15+22+42	1.29	1.89	3.62	-	-	6.80 (2.90-8.40)	2.133 (0.710-3.100)	9.37	99
15+22+50	1.17	1.72	3.91	-	-	6.80 (2.90-8.40)	2.024 (0.710-3.085)	8.89	99
15+22+60	1.05	1.54	4.21	-	-	6.80 (2.90-8.40)	1.871 (0.710-3.075)	8.22	99

MXZ-3D68VA COOLING

Indoor units combination	Cooling capacity (kW)						Outdoor unit power consumption(kW)	Current (A)	Power factor(%)
	Unit A	Unit B	Unit C	Unit D	Unit E	Total			
15+25+25	1.50	2.50	2.50	-	-	6.50 (2.90-8.10)	1.874 (0.710-3.055)	8.23	99
15+25+35	1.36	2.27	3.17	-	-	6.80 (2.90-8.40)	2.202 (0.710-3.110)	9.67	99
15+25+42	1.24	2.07	3.48	-	-	6.80 (2.90-8.40)	2.096 (0.710-3.100)	9.21	99
15+25+50	1.13	1.89	3.78	-	-	6.80 (2.90-8.40)	1.988 (0.710-3.085)	8.73	99
15+25+60	1.02	1.70	4.08	-	-	6.80 (2.90-8.40)	1.835 (0.710-3.070)	8.06	99
15+35+35	1.20	2.80	2.80	-	-	6.80 (2.90-8.40)	2.079 (0.710-3.105)	9.13	99
15+35+42	1.11	2.59	3.10	-	-	6.80 (2.90-8.40)	1.973 (0.710-3.095)	8.66	99
15+35+50	1.02	2.38	3.40	-	-	6.80 (2.90-8.40)	1.865 (0.710-3.080)	8.19	99
15+35+60	0.93	2.16	3.71	-	-	6.80 (2.90-8.40)	1.773 (0.710-3.070)	7.79	99
15+42+42	1.03	2.88	2.88	-	-	6.80 (2.90-8.40)	1.867 (0.710-3.080)	8.20	99
15+42+50	0.95	2.67	3.18	-	-	6.80 (2.90-8.40)	1.783 (0.710-3.070)	7.83	99
15+42+60	0.87	2.44	3.49	-	-	6.80 (2.90-8.40)	1.753 (0.710-3.060)	7.70	99
15+50+50	0.89	2.96	2.96	-	-	6.80 (2.90-8.40)	1.773 (0.710-3.060)	7.79	99
18+18+18	1.80	1.80	1.80	-	-	5.40 (2.90-6.80)	1.348 (0.670-1.770)	5.92	99
18+18+20	1.80	1.80	2.00	-	-	5.60 (2.90-7.00)	1.484 (0.710-2.145)	6.52	99
18+18+22	1.80	1.80	2.20	-	-	5.80 (2.90-7.70)	1.520 (0.670-2.465)	6.68	99
18+18+25	1.80	1.80	2.50	-	-	6.10 (2.90-8.10)	1.649 (0.670-2.825)	7.24	99
18+18+35	1.72	1.72	3.35	-	-	6.80 (2.90-8.40)	2.148 (0.670-2.930)	9.43	99
18+18+42	1.57	1.57	3.66	-	-	6.80 (2.90-8.40)	2.091 (0.670-2.920)	9.18	99
18+18+50	1.42	1.42	3.95	-	-	6.80 (2.90-8.40)	1.983 (0.670-2.905)	8.71	99
18+18+60	1.28	1.28	4.25	-	-	6.80 (2.90-8.40)	1.830 (0.670-2.895)	8.04	99
18+20+20	1.80	2.00	2.00	-	-	5.60 (2.90-7.30)	1.620 (0.750-2.525)	7.11	99
18+20+22	1.80	2.00	2.20	-	-	6.00 (2.90-7.90)	1.656 (0.710-2.840)	7.27	99
18+20+25	1.80	2.00	2.50	-	-	6.30 (2.90-7.90)	1.785 (0.710-2.880)	7.84	99
18+20+35	1.68	1.86	3.26	-	-	6.80 (2.90-8.20)	2.198 (0.710-2.960)	9.65	99
18+20+42	1.53	1.70	3.57	-	-	6.80 (2.90-8.20)	2.117 (0.710-2.950)	9.30	99
18+20+50	1.39	1.55	3.86	-	-	6.80 (2.90-8.20)	2.008 (0.710-2.935)	8.82	99
18+20+60	1.25	1.39	4.16	-	-	6.80 (2.90-8.20)	1.855 (0.710-2.920)	8.15	99
18+22+22	1.80	2.20	2.20	-	-	6.20 (2.90-8.10)	1.692 (0.670-2.835)	7.43	99
18+22+25	1.80	2.20	2.50	-	-	6.50 (2.90-8.10)	1.820 (0.670-2.875)	7.99	99
18+22+35	1.63	1.99	3.17	-	-	6.80 (2.90-8.40)	2.148 (0.670-2.930)	9.43	99
18+22+42	1.49	1.82	3.48	-	-	6.80 (2.90-8.40)	2.042 (0.670-2.920)	8.97	99
18+22+50	1.36	1.66	3.78	-	-	6.80 (2.90-8.40)	1.934 (0.670-2.905)	8.49	99
18+22+60	1.22	1.50	4.08	-	-	6.80 (2.90-8.40)	1.781 (0.670-2.890)	7.82	99
18+25+25	1.80	2.50	2.50	-	-	6.80 (2.90-8.40)	2.148 (0.670-2.930)	9.43	99
18+25+35	1.57	2.18	3.05	-	-	6.80 (2.90-8.40)	2.111 (0.670-2.930)	9.27	99
18+25+42	1.44	2.00	3.36	-	-	6.80 (2.90-8.40)	2.005 (0.670-2.915)	8.81	99
18+25+50	1.32	1.83	3.66	-	-	6.80 (2.90-8.40)	1.897 (0.670-2.905)	8.33	99
18+25+60	1.19	1.65	3.96	-	-	6.80 (2.90-8.40)	1.744 (0.670-2.890)	7.66	99
18+35+35	1.39	2.70	2.70	-	-	6.80 (2.90-8.40)	1.988 (0.670-2.925)	8.73	99
18+35+42	1.29	2.51	3.01	-	-	6.80 (2.90-8.40)	1.882 (0.670-2.915)	8.27	99

MXZ-3D68VA COOLING

Indoor units combination	Cooling capacity (kW)						Outdoor unit power consumption(kW)	Current (A)	Power factor(%)
	Unit A	Unit B	Unit C	Unit D	Unit E	Total			
18+35+50	1.19	2.31	3.30	-	-	6.80 (2.90-8.40)	1.774 (0.670-2.900)	7.79	99
18+35+60	1.08	2.11	3.61	-	-	6.80 (2.90-8.40)	1.719 (0.670-2.890)	7.55	99
18+42+42	1.20	2.80	2.80	-	-	6.80 (2.90-8.40)	1.776 (0.670-2.900)	7.80	99
18+42+50	1.11	2.60	3.09	-	-	6.80 (2.90-8.40)	1.729 (0.670-2.890)	7.59	99
18+42+60	1.02	2.38	3.40	-	-	6.80 (2.90-8.40)	1.699 (0.670-2.880)	7.46	99
18+50+50	1.04	2.88	2.88	-	-	6.80 (2.90-8.40)	1.719 (0.670-2.880)	7.55	99
20+20+20	2.00	2.00	2.00	-	-	6.00 (2.90-7.50)	1.756 (0.790-2.900)	7.71	99
20+20+22	2.00	2.00	2.20	-	-	6.20 (2.90-7.70)	1.792 (0.750-2.895)	7.87	99
20+20+25	2.00	2.00	2.50	-	-	6.50 (2.90-7.70)	1.920 (0.750-2.935)	8.43	99
20+20+35	1.81	1.81	3.17	-	-	6.80 (2.90-8.00)	2.248 (0.750-2.990)	9.87	99
20+20+42	1.66	1.66	3.48	-	-	6.80 (2.90-8.00)	2.142 (0.750-2.980)	9.41	99
20+20+50	1.51	1.51	3.78	-	-	6.80 (2.90-8.00)	2.034 (0.750-2.965)	8.93	99
20+20+60	1.36	1.36	4.08	-	-	6.80 (2.90-8.00)	1.881 (0.750-2.950)	8.26	99
20+22+22	2.00	2.20	2.20	-	-	6.40 (2.90-7.90)	1.827 (0.710-2.895)	8.02	99
20+22+25	2.00	2.20	2.50	-	-	6.70 (2.90-8.10)	2.056 (0.710-2.940)	9.03	99
20+22+35	1.77	1.94	3.09	-	-	6.80 (2.90-8.20)	2.173 (0.710-2.960)	9.54	99
20+22+42	1.62	1.78	3.40	-	-	6.80 (2.90-8.20)	2.067 (0.710-2.945)	9.08	99
20+22+50	1.48	1.63	3.70	-	-	6.80 (2.90-8.20)	1.959 (0.710-2.935)	8.60	99
20+22+60	1.33	1.47	4.00	-	-	6.80 (2.90-8.20)	1.806 (0.710-2.920)	7.93	99
20+25+25	1.94	2.43	2.43	-	-	6.80 (2.90-8.20)	2.198 (0.710-2.960)	9.65	99
20+25+35	1.70	2.13	2.98	-	-	6.80 (2.90-8.20)	2.137 (0.710-2.960)	9.39	99
20+25+42	1.56	1.95	3.28	-	-	6.80 (2.90-8.20)	2.030 (0.710-2.945)	8.92	99
20+25+50	1.43	1.79	3.58	-	-	6.80 (2.90-8.20)	1.922 (0.710-2.935)	8.44	99
20+25+60	1.30	1.62	3.89	-	-	6.80 (2.90-8.20)	1.769 (0.710-2.920)	7.77	99
20+35+35	1.51	2.64	2.64	-	-	6.80 (2.90-8.20)	2.014 (0.710-2.955)	8.84	99
20+35+42	1.40	2.45	2.94	-	-	6.80 (2.90-8.20)	1.907 (0.710-2.945)	8.38	99
20+35+50	1.30	2.27	3.24	-	-	6.80 (2.90-8.20)	1.799 (0.710-2.930)	7.90	99
20+35+60	1.18	2.07	3.55	-	-	6.80 (2.90-8.20)	1.769 (0.710-2.920)	7.77	99
20+42+42	1.31	2.75	2.75	-	-	6.80 (2.90-8.20)	1.801 (0.710-2.930)	7.91	99
20+42+50	1.21	2.55	3.04	-	-	6.80 (2.90-8.20)	1.779 (0.710-2.920)	7.81	99
20+50+50	1.13	2.83	2.83	-	-	6.80 (2.90-8.20)	1.769 (0.710-2.910)	7.77	99
22+22+22	2.20	2.20	2.20	-	-	6.60 (2.90-8.10)	1.863 (0.670-2.890)	8.18	99
22+22+25	2.17	2.17	2.46	-	-	6.80 (2.90-8.40)	2.148 (0.670-2.930)	9.43	99
22+22+35	1.89	1.89	3.01	-	-	6.80 (2.90-8.40)	2.099 (0.670-2.930)	9.22	99
22+22+42	1.74	1.74	3.32	-	-	6.80 (2.90-8.40)	1.993 (0.670-2.915)	8.75	99
22+22+50	1.59	1.59	3.62	-	-	6.80 (2.90-8.40)	1.884 (0.670-2.905)	8.27	99
22+22+60	1.44	1.44	3.92	-	-	6.80 (2.90-8.40)	1.731 (0.670-2.890)	7.60	99
22+25+25	2.08	2.36	2.36	-	-	6.80 (2.90-8.40)	2.148 (0.670-2.930)	9.43	99
22+25+35	1.82	2.07	2.90	-	-	6.80 (2.90-8.40)	2.062 (0.670-2.930)	9.06	99
22+25+42	1.68	1.91	3.21	-	-	6.80 (2.90-8.40)	1.956 (0.670-2.915)	8.59	99
22+25+50	1.54	1.75	3.51	-	-	6.80 (2.90-8.40)	1.847 (0.670-2.905)	8.11	99

MXZ-3D68VA COOLING

Indoor units combination	Cooling capacity (kW)						Outdoor unit power consumption(kW)	Current (A)	Power factor(%)
	Unit A	Unit B	Unit C	Unit D	Unit E	Total			
22+25+60	1.40	1.59	3.81	-	-	6.80 (2.90-8.40)	1.719 (0.670-2.890)	7.55	99
22+35+35	1.63	2.59	2.59	-	-	6.80 (2.90-8.40)	1.939 (0.670-2.925)	8.52	99
22+35+42	1.51	2.40	2.88	-	-	6.80 (2.90-8.40)	1.833 (0.670-2.910)	8.05	99
22+35+50	1.40	2.22	3.18	-	-	6.80 (2.90-8.40)	1.749 (0.670-2.900)	7.68	99
22+35+60	1.28	2.03	3.49	-	-	6.80 (2.90-8.40)	1.719 (0.670-2.890)	7.55	99
22+42+42	1.41	2.69	2.69	-	-	6.80 (2.90-8.40)	1.739 (0.670-2.900)	7.64	99
22+42+50	1.31	2.51	2.98	-	-	6.80 (2.90-8.40)	1.729 (0.670-2.890)	7.59	99
25+25+25	2.27	2.27	2.27	-	-	6.80 (2.90-8.40)	2.148 (0.670-2.930)	9.43	99
25+25+35	2.00	2.00	2.80	-	-	6.80 (2.90-8.40)	2.025 (0.670-2.925)	8.89	99
25+25+42	1.85	1.85	3.10	-	-	6.80 (2.90-8.40)	1.919 (0.670-2.915)	8.43	99
25+25+50	1.70	1.70	3.40	-	-	6.80 (2.90-8.40)	1.811 (0.670-2.900)	7.95	99
25+25+60	1.55	1.55	3.71	-	-	6.80 (2.90-8.40)	1.719 (0.670-2.890)	7.55	99
25+35+35	1.79	2.51	2.51	-	-	6.80 (2.90-8.40)	1.902 (0.670-2.925)	8.35	99
25+35+42	1.67	2.33	2.80	-	-	6.80 (2.90-8.40)	1.796 (0.670-2.910)	7.89	99
25+35+50	1.55	2.16	3.09	-	-	6.80 (2.90-8.40)	1.749 (0.670-2.900)	7.68	99
25+35+60	1.42	1.98	3.40	-	-	6.80 (2.90-8.40)	1.719 (0.670-2.890)	7.55	99
25+42+42	1.56	2.62	2.62	-	-	6.80 (2.90-8.40)	1.739 (0.670-2.900)	7.64	99
25+42+50	1.45	2.44	2.91	-	-	6.80 (2.90-8.40)	1.729 (0.670-2.890)	7.59	99
35+35+35	2.27	2.27	2.27	-	-	6.80 (2.90-8.40)	1.779 (0.670-2.920)	7.81	99
35+35+42	2.13	2.13	2.55	-	-	6.80 (2.90-8.40)	1.759 (0.670-2.910)	7.73	99
35+35+50	1.98	1.98	2.83	-	-	6.80 (2.90-8.40)	1.749 (0.670-2.900)	7.68	99
35+42+42	2.00	2.40	2.40	-	-	6.80 (2.90-8.40)	1.739 (0.670-2.900)	7.64	99

MXZ-3D68VA HEATING

Indoor units combination	Heating capacity (kW)					Outdoor unit power consumption(kW)	Current (A)	Power factor(%)	
	Unit A	Unit B	Unit C	Unit D	Unit E				Total
15	1.70	-	-	-	-	1.70 (1.20-3.00)	0.500 (0.400-0.950)	2.20	99
18	3.30	-	-	-	-	3.30 (1.20-4.20)	0.760 (0.380-1.090)	3.34	99
20	2.20	-	-	-	-	2.20 (1.20-3.90)	0.610 (0.390-1.330)	2.68	99
22	3.30	-	-	-	-	3.30 (1.20-4.20)	0.760 (0.380-1.090)	3.34	99
25	3.60	-	-	-	-	3.60 (1.20-4.50)	0.860 (0.380-1.190)	3.78	99
35	4.00	-	-	-	-	4.00 (1.20-4.80)	1.000 (0.380-1.300)	4.39	99
42	5.40	-	-	-	-	5.40 (1.30-6.50)	1.460 (0.370-1.800)	6.41	99
50	7.20	-	-	-	-	7.20 (1.40-8.20)	1.880 (0.370-2.300)	8.26	99
60	7.90	-	-	-	-	7.90 (1.40-8.60)	2.120 (0.360-2.410)	9.31	99
15+15	1.70	1.70	-	-	-	3.40 (1.80-5.00)	0.796 (0.670-1.300)	3.50	99
15+18	1.70	3.30	-	-	-	5.00 (1.80-6.10)	1.146 (0.540-1.530)	5.03	99
15+20	1.70	2.20	-	-	-	3.90 (1.80-5.80)	0.966 (0.650-1.625)	4.24	99
15+22	1.70	3.30	-	-	-	5.00 (1.80-6.10)	1.146 (0.540-1.530)	5.03	99
15+25	1.60	3.40	-	-	-	5.00 (1.80-6.10)	1.146 (0.540-1.530)	5.03	99
15+35	1.67	3.93	-	-	-	5.60 (1.80-7.90)	1.320 (0.540-2.190)	5.80	99
15+42	1.46	4.64	-	-	-	6.10 (1.80-7.90)	1.446 (0.540-2.190)	6.35	99
15+50	1.28	5.42	-	-	-	6.70 (1.80-7.90)	1.575 (0.540-2.180)	6.92	99
15+60	1.24	5.76	-	-	-	7.00 (1.80-7.90)	1.671 (0.540-2.150)	7.34	99
18+18	3.30	3.30	-	-	-	6.60 (1.80-7.20)	1.496 (0.410-1.760)	6.57	99
18+20	3.30	2.20	-	-	-	5.50 (1.80-6.90)	1.316 (0.520-1.855)	5.78	99
18+22	3.30	3.30	-	-	-	6.60 (1.80-7.20)	1.496 (0.410-1.760)	6.57	99
18+25	3.16	3.44	-	-	-	6.60 (1.80-7.20)	1.496 (0.410-1.760)	6.57	99
18+35	3.30	4.00	-	-	-	7.30 (1.80-9.00)	1.724 (0.410-2.420)	7.57	99
18+42	3.00	4.90	-	-	-	7.90 (1.80-9.00)	1.850 (0.410-2.420)	8.12	99
18+60	2.53	6.07	-	-	-	8.60 (1.80-9.00)	2.034 (0.400-2.365)	8.93	99
20+20	2.20	2.20	-	-	-	4.40 (1.80-6.60)	1.136 (0.630-1.950)	4.99	99
20+22	2.20	3.30	-	-	-	5.50 (1.80-6.90)	1.316 (0.520-1.855)	5.78	99
20+25	2.12	3.48	-	-	-	5.60 (1.80-7.20)	1.347 (0.520-1.965)	5.92	99
20+35	2.20	4.00	-	-	-	6.20 (1.80-8.70)	1.580 (0.520-2.515)	6.94	99
20+42	2.00	4.90	-	-	-	6.90 (1.80-8.70)	1.704 (0.520-2.515)	7.48	99
20+50	1.76	5.74	-	-	-	7.50 (1.80-8.70)	1.830 (0.520-2.505)	8.04	99
20+60	1.63	5.87	-	-	-	7.50 (1.80-8.70)	1.863 (0.510-2.450)	8.18	99
22+22	3.30	3.30	-	-	-	6.60 (1.80-7.20)	1.496 (0.410-1.760)	6.57	99
22+25	3.30	3.60	-	-	-	6.90 (1.80-8.10)	1.588 (0.410-2.095)	6.97	99
22+35	3.30	4.00	-	-	-	7.30 (1.80-9.00)	1.796 (0.410-2.420)	7.89	99
22+42	3.11	5.09	-	-	-	8.20 (1.80-9.00)	1.918 (0.410-2.420)	8.42	99
22+50	2.70	5.90	-	-	-	8.60 (1.80-9.00)	2.019 (0.410-2.400)	8.87	99
22+60	2.53	6.07	-	-	-	8.60 (1.80-9.00)	2.051 (0.400-2.350)	9.01	99
25+25	3.60	3.60	-	-	-	7.20 (1.80-9.00)	1.680 (0.410-2.430)	7.38	99
25+35	3.60	4.00	-	-	-	7.60 (1.80-9.00)	1.850 (0.410-2.420)	8.12	99
25+42	3.36	5.04	-	-	-	8.40 (1.80-9.00)	1.969 (0.410-2.420)	8.65	99

MXZ-3D68VA HEATING

Indoor units combination	Heating capacity (kW)					Outdoor unit power consumption(kW)	Current (A)	Power factor(%)	
	Unit A	Unit B	Unit C	Unit D	Unit E				Total
25+50	2.87	5.73	-	-	-	8.60 (1.80-9.00)	2.031 (0.410-2.390)	8.92	99
25+60	2.69	5.91	-	-	-	8.60 (1.80-9.00)	2.043 (0.400-2.335)	8.97	99
35+35	4.00	4.00	-	-	-	8.00 (1.80-9.00)	2.010 (0.410-2.410)	8.83	99
35+42	3.66	4.94	-	-	-	8.60 (1.80-9.00)	2.040 (0.410-2.380)	8.96	99
35+50	3.07	5.53	-	-	-	8.60 (1.80-9.00)	2.043 (0.400-2.335)	8.97	99
35+60	2.89	5.71	-	-	-	8.60 (1.90-9.00)	1.864 (0.370-2.275)	8.19	99
42+42	4.30	4.30	-	-	-	8.60 (1.80-9.00)	2.070 (0.400-2.350)	9.09	99
42+50	3.69	4.91	-	-	-	8.60 (1.90-9.00)	1.925 (0.380-2.300)	8.45	99
42+60	3.49	5.11	-	-	-	8.60 (1.90-9.00)	1.778 (0.360-2.235)	7.81	99
50+50	4.30	4.30	-	-	-	8.60 (1.90-9.00)	1.780 (0.360-2.250)	7.82	99
50+60	4.10	4.50	-	-	-	8.60 (1.90-9.00)	1.760 (0.360-2.160)	7.73	99
60+60	4.30	4.30	-	-	-	8.60 (1.90-9.00)	1.740 (0.360-2.070)	7.64	99
15+15+15	1.70	1.70	1.70	-	-	5.10 (2.60-8.50)	1.129 (0.890-2.425)	4.96	99
15+15+18	1.62	1.62	3.15	-	-	6.40 (2.60-9.20)	1.519 (0.760-2.775)	6.67	99
15+15+20	1.70	1.70	2.20	-	-	5.60 (2.60-9.00)	1.269 (0.890-2.645)	5.57	99
15+15+22	1.62	1.62	3.15	-	-	6.40 (2.60-9.20)	1.519 (0.760-2.775)	6.67	99
15+15+25	1.55	1.55	3.29	-	-	6.40 (2.60-9.20)	1.519 (0.760-2.775)	6.67	99
15+15+35	1.47	1.47	3.46	-	-	6.40 (2.60-9.20)	1.509 (0.760-2.765)	6.63	99
15+15+42	1.24	1.24	3.93	-	-	6.40 (2.60-9.20)	1.509 (0.760-2.765)	6.63	99
15+15+50	1.03	1.03	4.35	-	-	6.40 (2.60-9.20)	1.499 (1.510-2.755)	6.58	99
15+15+60	0.96	0.96	4.47	-	-	6.40 (2.60-9.20)	1.489 (3.010-2.745)	6.54	99
15+18+18	1.54	2.98	2.98	-	-	7.50 (2.60-9.90)	1.909 (0.630-3.125)	8.38	99
15+18+20	1.63	3.16	2.11	-	-	6.90 (2.60-9.70)	1.659 (0.760-2.995)	7.29	99
15+18+22	1.54	2.98	2.98	-	-	7.50 (2.60-9.90)	1.909 (0.630-3.125)	8.38	99
15+18+25	1.48	2.88	3.14	-	-	7.50 (2.60-9.90)	1.909 (0.630-3.125)	8.38	99
15+18+42	1.23	2.38	3.89	-	-	7.50 (2.60-9.90)	1.899 (0.630-3.115)	8.34	99
15+18+50	1.05	2.03	4.43	-	-	7.50 (2.60-9.90)	1.889 (1.830-3.105)	8.30	99
15+18+60	0.99	1.92	4.59	-	-	7.50 (2.60-9.90)	1.879 (3.330-3.095)	8.25	99
15+20+20	1.70	2.20	2.20	-	-	6.10 (2.60-9.50)	1.409 (0.890-2.865)	6.19	99
15+20+22	1.63	2.11	3.16	-	-	6.90 (2.60-9.70)	1.659 (0.760-2.995)	7.29	99
15+20+25	1.56	2.02	3.31	-	-	6.90 (2.60-9.70)	1.659 (0.760-2.995)	7.29	99
15+20+35	1.48	1.92	3.49	-	-	6.90 (2.60-9.70)	1.649 (0.760-2.985)	7.24	99
15+20+42	1.26	1.63	4.01	-	-	6.90 (2.60-9.70)	1.649 (1.060-2.985)	7.24	99
15+20+50	1.06	1.37	4.48	-	-	6.90 (2.60-9.70)	1.639 (2.260-2.975)	7.20	99
15+20+60	0.99	1.29	4.62	-	-	6.90 (2.60-9.70)	1.629 (3.760-2.965)	7.15	99
15+22+22	1.54	2.98	2.98	-	-	7.50 (2.60-9.90)	1.909 (0.630-3.125)	8.38	99
15+22+25	1.48	2.88	3.14	-	-	7.50 (2.60-9.90)	1.909 (0.630-3.125)	8.38	99
15+22+35	1.42	2.75	3.33	-	-	7.50 (2.60-9.90)	1.899 (0.630-3.115)	8.34	99
15+22+42	1.23	2.38	3.89	-	-	7.50 (2.60-9.90)	1.899 (1.230-3.115)	8.34	99
15+22+50	1.05	2.03	4.43	-	-	7.50 (2.60-9.90)	1.889 (2.430-3.105)	8.30	99
15+22+60	0.99	1.92	4.59	-	-	7.50 (2.60-9.90)	1.879 (3.930-3.095)	8.25	99

MXZ-3D68VA HEATING

Indoor units combination	Heating capacity (kW)						Outdoor unit power consumption(kW)	Current (A)	Power factor(%)
	Unit A	Unit B	Unit C	Unit D	Unit E	Total			
15+25+25	1.43	3.03	3.03	-	-	7.50 (2.60-9.90)	1.909 (0.630-3.125)	8.38	99
15+25+35	1.37	2.90	3.23	-	-	7.50 (2.60-9.90)	1.899 (0.630-3.115)	8.34	99
15+25+42	1.19	2.52	3.79	-	-	7.50 (2.60-9.90)	1.899 (1.680-3.115)	8.34	99
15+25+50	1.02	2.16	4.32	-	-	7.50 (2.60-9.90)	1.889 (2.880-3.105)	8.30	99
15+25+60	0.97	2.05	4.49	-	-	7.50 (2.60-9.90)	1.879 (4.380-3.095)	8.25	99
15+35+35	1.31	3.09	3.09	-	-	7.50 (2.60-9.90)	1.889 (2.130-3.105)	8.30	99
15+35+42	1.15	2.70	3.65	-	-	7.50 (2.60-9.90)	1.889 (3.180-3.105)	8.30	99
15+35+50	0.99	2.33	4.19	-	-	7.50 (2.60-9.90)	1.879 (4.380-3.095)	8.25	99
15+35+60	0.94	2.21	4.36	-	-	7.50 (2.60-9.90)	1.869 (4.060-3.085)	8.21	99
15+42+42	1.02	3.24	3.24	-	-	7.50 (2.60-9.90)	1.889 (4.230-3.105)	8.30	99
15+42+50	0.89	2.83	3.78	-	-	7.50 (2.60-9.90)	1.879 (4.700-3.095)	8.25	99
15+42+60	0.85	2.70	3.95	-	-	7.50 (2.60-9.90)	1.869 (2.560-3.085)	8.21	99
15+50+50	0.79	3.35	3.35	-	-	7.50 (2.60-9.90)	1.869 (2.990-3.085)	8.21	99
18+18+18	2.87	2.87	2.87	-	-	8.60 (2.60-10.60)	2.299 (0.500-3.475)	10.10	99
18+18+20	3.00	3.00	2.00	-	-	8.00 (2.60-10.40)	2.049 (0.630-3.345)	9.00	99
18+18+22	2.87	2.87	2.87	-	-	8.60 (2.60-10.60)	2.299 (0.500-3.475)	10.10	99
18+18+25	2.78	2.78	3.04	-	-	8.60 (2.60-10.60)	2.299 (0.500-3.475)	10.10	99
18+18+35	2.68	2.68	3.25	-	-	8.60 (2.60-10.60)	2.289 (0.500-3.465)	10.05	99
18+18+42	2.37	2.37	3.87	-	-	8.60 (2.60-10.60)	2.289 (0.950-3.465)	10.05	99
18+18+50	2.06	2.06	4.49	-	-	8.60 (2.60-10.60)	2.279 (2.150-3.455)	10.01	99
18+18+60	1.96	1.96	4.69	-	-	8.60 (2.60-10.60)	2.269 (3.650-3.445)	9.96	99
18+20+20	3.17	2.11	2.11	-	-	7.40 (2.60-10.20)	1.799 (0.760-3.215)	7.90	99
18+20+22	3.00	2.00	3.00	-	-	8.00 (2.60-10.40)	2.049 (0.630-3.345)	9.00	99
18+20+25	2.90	1.93	3.16	-	-	8.00 (2.60-10.40)	2.049 (0.630-3.345)	9.00	99
18+20+35	2.78	1.85	3.37	-	-	8.00 (2.60-10.40)	2.039 (0.630-3.335)	8.95	99
18+20+42	2.42	1.61	3.96	-	-	8.00 (2.60-10.40)	2.039 (1.380-3.335)	8.95	99
18+20+50	2.08	1.39	4.54	-	-	8.00 (2.60-10.40)	2.029 (2.580-3.325)	8.91	99
18+20+60	1.97	1.31	4.72	-	-	8.00 (2.60-10.40)	2.019 (4.080-3.315)	8.87	99
18+22+22	2.87	2.87	2.87	-	-	8.60 (2.60-10.60)	2.299 (0.500-3.475)	10.10	99
18+22+25	2.78	2.78	3.04	-	-	8.60 (2.60-10.60)	2.299 (0.500-3.475)	10.10	99
18+22+35	2.68	2.68	3.25	-	-	8.60 (2.60-10.60)	2.289 (0.500-3.465)	10.05	99
18+22+42	2.37	2.37	3.87	-	-	8.60 (2.60-10.60)	2.289 (1.550-3.465)	10.05	99
18+22+50	2.06	2.06	4.49	-	-	8.60 (2.60-10.60)	2.279 (2.750-3.455)	10.01	99
18+22+60	1.96	1.96	4.69	-	-	8.60 (2.60-10.60)	2.269 (4.250-3.445)	9.96	99
18+25+25	2.70	2.95	2.95	-	-	8.60 (2.60-10.60)	2.299 (0.500-3.475)	10.10	99
18+25+35	2.60	2.84	3.16	-	-	8.60 (2.60-10.60)	2.289 (0.950-3.465)	10.05	99
18+25+42	2.31	2.52	3.78	-	-	8.60 (2.60-10.60)	2.289 (2.000-3.465)	10.05	99
18+25+50	2.01	2.20	4.39	-	-	8.60 (2.60-10.60)	2.279 (3.200-3.455)	10.01	99
18+25+60	1.92	2.09	4.59	-	-	8.60 (2.60-10.60)	2.269 (4.700-3.445)	9.96	99
18+35+35	2.51	3.04	3.04	-	-	8.60 (2.60-10.60)	2.279 (2.450-3.455)	10.01	99
18+35+42	2.23	2.71	3.66	-	-	8.60 (2.60-10.60)	2.279 (3.500-3.455)	10.01	99

MXZ-3D68VA HEATING

Indoor units combination	Heating capacity (kW)						Outdoor unit power consumption(kW)	Current (A)	Power factor(%)
	Unit A	Unit B	Unit C	Unit D	Unit E	Total			
18+35+50	1.96	2.37	4.27	-	-	8.60 (2.60-10.60)	2.269 (4.700-3.445)	9.96	99
18+35+60	1.87	2.26	4.47	-	-	8.60 (2.60-10.60)	2.259 (3.290-3.435)	9.92	99
18+42+42	2.01	3.29	3.29	-	-	8.60 (2.60-10.60)	2.279 (4.550-3.455)	10.01	99
18+42+50	1.78	2.92	3.89	-	-	8.60 (2.60-10.60)	2.269 (3.930-3.445)	9.96	99
18+42+60	1.71	2.80	4.09	-	-	8.60 (2.60-10.60)	2.259 (1.790-3.435)	9.92	99
18+50+50	1.60	3.50	3.50	-	-	8.60 (2.60-10.60)	2.259 (2.210-3.435)	9.92	99
20+20+20	2.20	2.20	2.20	-	-	6.60 (2.60-10.00)	1.549 (0.890-3.085)	6.80	99
20+20+22	2.11	2.11	3.17	-	-	7.40 (2.60-10.20)	1.799 (0.760-3.215)	7.90	99
20+20+25	2.04	2.04	3.33	-	-	7.40 (2.60-10.20)	1.799 (0.760-3.215)	7.90	99
20+20+35	1.94	1.94	3.52	-	-	7.40 (2.60-10.20)	1.789 (0.760-3.205)	7.86	99
20+20+42	1.66	1.66	4.08	-	-	7.40 (2.60-10.20)	1.789 (1.810-3.205)	7.86	99
20+20+50	1.40	1.40	4.59	-	-	7.40 (2.60-10.20)	1.779 (3.010-3.195)	7.81	99
20+20+60	1.32	1.32	4.75	-	-	7.40 (2.60-10.20)	1.769 (4.510-3.185)	7.77	99
20+22+22	2.00	3.00	3.00	-	-	8.00 (2.60-10.40)	2.049 (0.630-3.345)	9.00	99
20+22+25	1.93	2.90	3.16	-	-	8.00 (2.60-10.40)	2.049 (0.630-3.345)	9.00	99
20+22+35	1.85	2.78	3.37	-	-	8.00 (2.60-10.40)	2.039 (0.930-3.335)	8.95	99
20+22+42	1.61	2.42	3.96	-	-	8.00 (2.60-10.40)	2.039 (1.980-3.335)	8.95	99
20+22+50	1.39	2.08	4.54	-	-	8.00 (2.60-10.40)	2.029 (3.180-3.325)	8.91	99
20+22+60	1.31	1.97	4.72	-	-	8.00 (2.60-10.40)	2.019 (4.680-3.315)	8.87	99
20+25+25	1.87	3.06	3.06	-	-	8.00 (2.60-10.40)	2.049 (0.630-3.345)	9.00	99
20+25+35	1.80	2.94	3.27	-	-	8.00 (2.60-10.40)	2.039 (1.380-3.335)	8.95	99
20+25+42	1.57	2.57	3.86	-	-	8.00 (2.60-10.40)	2.039 (2.430-3.335)	8.95	99
20+25+50	1.35	2.22	4.43	-	-	8.00 (2.60-10.40)	2.029 (3.630-3.325)	8.91	99
20+25+60	1.28	2.10	4.61	-	-	8.00 (2.60-10.40)	2.019 (5.130-3.315)	8.87	99
20+35+35	1.73	3.14	3.14	-	-	8.00 (2.60-10.40)	2.029 (2.880-3.325)	8.91	99
20+35+42	1.52	2.76	3.72	-	-	8.00 (2.60-10.40)	2.029 (3.930-3.325)	8.91	99
20+35+50	1.31	2.39	4.30	-	-	8.00 (2.60-10.40)	2.019 (5.130-3.315)	8.87	99
20+35+60	1.25	2.27	4.48	-	-	8.00 (2.60-10.40)	2.009 (2.990-3.305)	8.82	99
20+42+42	1.35	3.32	3.32	-	-	8.00 (2.60-10.40)	2.029 (4.980-3.325)	8.91	99
20+42+50	1.19	2.92	3.89	-	-	8.00 (2.60-10.40)	2.019 (3.630-3.315)	8.87	99
20+50+50	1.06	3.47	3.47	-	-	8.00 (2.60-10.40)	2.009 (1.920-3.305)	8.82	99
22+22+22	2.87	2.87	2.87	-	-	8.60 (2.60-10.60)	2.299 (0.500-3.475)	10.10	99
22+22+25	2.78	2.78	3.04	-	-	8.60 (2.60-10.60)	2.299 (0.500-3.475)	10.10	99
22+22+35	2.68	2.68	3.25	-	-	8.60 (2.60-10.60)	2.289 (1.100-3.465)	10.05	99
22+22+42	2.37	2.37	3.87	-	-	8.60 (2.60-10.60)	2.289 (2.150-3.465)	10.05	99
22+22+50	2.06	2.06	4.49	-	-	8.60 (2.60-10.60)	2.279 (3.350-3.455)	10.01	99
22+22+60	1.96	1.96	4.69	-	-	8.60 (2.60-10.60)	2.269 (4.850-3.445)	9.96	99
22+25+25	2.70	2.95	2.95	-	-	8.60 (2.60-10.60)	2.299 (0.500-3.475)	10.10	99
22+25+35	2.60	2.84	3.16	-	-	8.60 (2.60-10.60)	2.289 (1.550-3.465)	10.05	99
22+25+42	2.31	2.52	3.78	-	-	8.60 (2.60-10.60)	2.289 (2.600-3.465)	10.05	99
22+25+50	2.01	2.20	4.39	-	-	8.60 (2.60-10.60)	2.279 (3.800-3.455)	10.01	99

MXZ-3D68VA HEATING

Indoor units combination	Heating capacity (kW)						Outdoor unit power consumption(kW)	Current (A)	Power factor(%)
	Unit A	Unit B	Unit C	Unit D	Unit E	Total			
22+25+60	1.92	2.09	4.59	-	-	8.60 (2.60-10.60)	2.269 (4.570-3.445)	9.96	99
22+35+35	2.51	3.04	3.04	-	-	8.60 (2.60-10.60)	2.279 (3.050-3.455)	10.01	99
22+35+42	2.23	2.71	3.66	-	-	8.60 (2.60-10.60)	2.279 (4.100-3.455)	10.01	99
22+35+50	1.96	2.37	4.27	-	-	8.60 (2.60-10.60)	2.269 (4.570-3.445)	9.96	99
22+35+60	1.87	2.26	4.47	-	-	8.60 (2.60-10.60)	2.259 (2.430-3.435)	9.92	99
22+42+42	2.01	3.29	3.29	-	-	8.60 (2.60-10.60)	2.279 (4.790-3.455)	10.01	99
22+42+50	1.78	2.92	3.89	-	-	8.60 (2.60-10.60)	2.269 (3.070-3.445)	9.96	99
25+25+25	2.87	2.87	2.87	-	-	8.60 (2.60-10.60)	2.299 (0.500-3.475)	10.10	99
25+25+35	2.76	2.76	3.07	-	-	8.60 (2.60-10.60)	2.289 (2.000-3.465)	10.05	99
25+25+42	2.46	2.46	3.69	-	-	8.60 (2.60-10.60)	2.289 (3.050-3.465)	10.05	99
25+25+50	2.15	2.15	4.30	-	-	8.60 (2.60-10.60)	2.279 (4.250-3.455)	10.01	99
25+25+60	2.05	2.05	4.50	-	-	8.60 (2.60-10.60)	2.269 (3.930-3.445)	9.96	99
25+35+35	2.67	2.97	2.97	-	-	8.60 (2.60-10.60)	2.279 (3.500-3.455)	10.01	99
25+35+42	2.38	2.65	3.57	-	-	8.60 (2.60-10.60)	2.279 (4.550-3.455)	10.01	99
25+35+50	2.09	2.32	4.18	-	-	8.60 (2.60-10.60)	2.269 (3.930-3.445)	9.96	99
25+35+60	2.00	2.22	4.38	-	-	8.60 (2.60-10.60)	2.259 (1.790-3.435)	9.92	99
25+42+42	2.15	3.23	3.23	-	-	8.60 (2.60-10.60)	2.279 (4.140-3.455)	10.01	99
25+42+50	1.91	2.87	3.82	-	-	8.60 (2.60-10.60)	2.269 (2.430-3.445)	9.96	99
35+35+35	2.87	2.87	2.87	-	-	8.60 (2.60-10.60)	2.269 (5.000-3.445)	9.96	99
35+35+42	2.57	2.57	3.47	-	-	8.60 (2.60-10.60)	2.269 (3.500-3.445)	9.96	99
35+35+50	2.26	2.26	4.07	-	-	8.60 (2.60-10.60)	2.259 (1.790-3.435)	9.92	99
35+42+42	2.32	3.14	3.14	-	-	8.60 (2.60-10.60)	2.269 (2.000-3.445)	9.96	99

MXZ-4D72VA COOLING

Indoor units combination	Cooling capacity (kW)						Outdoor unit power consumption(kW)	Current (A)	Power factor(%)
	Unit A	Unit B	Unit C	Unit D	Unit E	Total			
15	1.50	-	-	-	-	1.50 (1.40-3.00)	0.490 (0.450-1.020)	2.15	99
18	1.80	-	-	-	-	1.80 (1.40-3.00)	0.420 (0.420-0.740)	1.84	99
20	2.00	-	-	-	-	2.00 (1.40-3.00)	0.540 (0.450-1.020)	2.37	99
22	2.20	-	-	-	-	2.20 (1.40-3.00)	0.510 (0.420-0.740)	2.24	99
25	2.50	-	-	-	-	2.50 (1.40-3.30)	0.580 (0.420-0.830)	2.55	99
35	3.50	-	-	-	-	3.50 (1.50-4.30)	0.820 (0.430-1.180)	3.60	99
42	4.20	-	-	-	-	4.20 (1.60-5.00)	1.080 (0.450-1.420)	4.74	99
50	5.00	-	-	-	-	5.00 (1.60-5.60)	1.430 (0.480-1.660)	6.28	99
60	6.00	-	-	-	-	6.00 (1.60-6.60)	1.700 (0.480-2.250)	7.47	99
15+15	1.50	1.50	-	-	-	3.00 (2.00-5.40)	0.790 (0.540-1.800)	3.47	99
15+18	1.50	1.80	-	-	-	3.30 (2.00-5.40)	0.841 (0.620-1.890)	3.69	99
15+20	1.50	2.00	-	-	-	3.50 (2.00-5.40)	0.885 (0.700-2.005)	3.89	99
15+22	1.50	2.20	-	-	-	3.70 (2.00-5.40)	0.929 (0.660-1.850)	4.08	99
15+25	1.50	2.50	-	-	-	4.00 (2.00-5.40)	1.130 (0.780-1.970)	4.96	99
15+35	1.50	3.50	-	-	-	5.00 (2.00-6.00)	1.470 (0.620-2.150)	6.46	99
15+42	1.50	4.20	-	-	-	5.70 (2.00-6.40)	1.691 (0.620-2.500)	7.43	99
15+50	1.50	5.00	-	-	-	6.50 (2.00-6.90)	2.064 (0.630-2.860)	9.06	99
15+60	1.36	5.44	-	-	-	6.80 (2.00-7.10)	2.232 (0.640-2.980)	9.80	99
18+18	1.80	1.80	-	-	-	3.60 (2.00-5.40)	0.832 (0.540-1.640)	3.65	99
18+20	1.80	2.00	-	-	-	3.80 (2.00-5.40)	0.996 (0.700-1.890)	4.37	99
18+22	1.80	2.20	-	-	-	4.00 (2.00-5.40)	1.100 (0.700-1.800)	4.83	99
18+25	1.80	2.50	-	-	-	4.30 (2.00-5.40)	1.177 (0.580-1.680)	5.17	99
18+35	1.80	3.50	-	-	-	5.30 (2.00-6.20)	1.535 (0.540-2.130)	6.74	99
18+42	1.80	4.20	-	-	-	6.00 (2.00-6.60)	1.755 (0.540-2.480)	7.71	99
18+50	1.80	5.00	-	-	-	6.80 (2.00-7.10)	2.202 (0.550-2.820)	9.67	99
18+60	1.57	5.23	-	-	-	6.80 (2.00-7.10)	2.202 (0.560-2.810)	9.67	99
20+20	2.00	2.00	-	-	-	4.00 (2.00-5.40)	1.100 (0.700-1.800)	4.83	99
20+22	2.00	2.20	-	-	-	4.20 (2.00-5.40)	1.181 (0.700-1.890)	5.19	99
20+25	2.00	2.50	-	-	-	4.50 (2.00-5.50)	1.272 (0.620-1.865)	5.59	99
20+35	2.00	3.50	-	-	-	5.50 (2.00-6.30)	1.628 (0.620-2.400)	7.15	99
20+42	2.00	4.20	-	-	-	6.20 (2.00-6.70)	1.897 (0.620-2.740)	8.33	99
20+50	1.94	4.86	-	-	-	6.80 (2.00-7.10)	2.232 (0.630-2.990)	9.80	99
20+60	1.70	5.10	-	-	-	6.80 (2.00-7.10)	2.232 (0.640-2.980)	9.80	99
22+22	2.20	2.20	-	-	-	4.40 (2.00-5.40)	1.202 (0.540-1.640)	5.28	99
22+25	2.20	2.50	-	-	-	4.70 (2.00-5.70)	1.321 (0.540-1.810)	5.80	99
22+35	2.20	3.50	-	-	-	5.70 (2.00-6.40)	1.661 (0.540-2.330)	7.29	99
22+42	2.20	4.20	-	-	-	6.40 (2.00-6.90)	1.979 (0.540-2.655)	8.69	99
22+60	1.82	4.98	-	-	-	6.80 (2.00-7.10)	2.202 (0.560-2.810)	9.67	99
25+25	2.50	2.50	-	-	-	5.00 (2.00-6.00)	1.440 (0.540-1.980)	6.32	99
25+35	2.50	3.50	-	-	-	6.00 (2.00-6.60)	1.755 (0.540-2.480)	7.71	99
25+42	2.50	4.20	-	-	-	6.70 (2.00-7.00)	2.146 (0.540-2.785)	9.42	99

MXZ-4D72VA COOLING

Indoor units combination	Cooling capacity (kW)						Outdoor unit power consumption(kW)	Current (A)	Power factor(%)
	Unit A	Unit B	Unit C	Unit D	Unit E	Total			
25+50	2.27	4.53	-	-	-	6.80 (2.00-7.10)	2.202 (0.550-2.820)	9.67	99
25+60	2.00	4.80	-	-	-	6.80 (2.00-7.10)	2.194 (0.560-2.810)	9.64	99
35+35	3.40	3.40	-	-	-	6.80 (2.00-7.10)	2.202 (0.540-2.830)	9.67	99
35+42	3.09	3.71	-	-	-	6.80 (2.00-7.10)	2.202 (0.540-2.830)	9.67	99
35+50	2.80	4.00	-	-	-	6.80 (2.00-7.10)	2.194 (0.550-2.820)	9.64	99
35+60	2.51	4.29	-	-	-	6.80 (2.10-7.10)	2.119 (0.570-2.830)	9.31	99
42+42	3.40	3.40	-	-	-	6.80 (2.00-7.10)	2.202 (0.540-2.830)	9.67	99
42+50	3.10	3.70	-	-	-	6.80 (2.10-7.10)	2.142 (0.560-2.835)	9.41	99
42+60	2.80	4.00	-	-	-	6.80 (2.10-7.10)	2.064 (0.580-2.845)	9.06	99
50+50	3.40	3.40	-	-	-	6.80 (2.10-7.10)	2.081 (0.560-2.860)	9.14	99
50+60	3.09	3.71	-	-	-	6.80 (2.10-7.10)	1.997 (0.600-2.860)	8.77	99
60+60	3.40	3.40	-	-	-	6.80 (2.10-7.10)	1.912 (0.580-2.920)	8.40	99
15+15+15	1.50	1.50	1.50	-	-	4.50 (2.90-7.30)	0.970 (0.780-2.310)	4.26	99
15+15+18	1.50	1.50	1.80	-	-	4.80 (2.90-7.60)	1.176 (0.800-2.210)	5.16	99
15+15+20	1.50	1.50	2.00	-	-	5.00 (2.90-7.70)	1.300 (0.810-2.130)	5.71	99
15+15+22	1.50	1.50	2.20	-	-	5.20 (2.90-7.90)	1.344 (0.750-1.970)	5.90	99
15+15+25	1.50	1.50	2.50	-	-	5.50 (2.90-8.10)	1.475 (0.750-2.205)	6.48	99
15+15+35	1.50	1.50	3.50	-	-	6.50 (2.90-8.10)	1.635 (0.750-3.140)	7.18	99
15+15+50	1.35	1.35	4.50	-	-	7.20 (2.90-8.50)	1.907 (0.730-2.555)	8.38	99
15+15+60	1.20	1.20	4.80	-	-	7.20 (2.90-8.50)	1.810 (0.730-2.535)	7.95	99
15+18+18	1.50	1.80	1.80	-	-	5.10 (2.90-7.80)	1.262 (0.740-1.990)	5.54	99
15+18+20	1.50	1.80	2.00	-	-	5.30 (2.90-8.00)	1.386 (0.740-1.910)	6.09	99
15+18+22	1.50	1.80	2.20	-	-	5.50 (2.90-8.10)	1.435 (0.720-2.165)	6.30	99
15+18+25	1.50	1.80	2.50	-	-	5.80 (2.90-8.10)	1.576 (0.770-3.230)	6.92	99
15+18+35	1.50	1.80	3.50	-	-	6.80 (2.90-8.20)	1.697 (0.700-2.790)	7.45	99
15+18+42	1.44	1.73	4.03	-	-	7.20 (2.90-8.50)	1.910 (0.700-2.530)	8.39	99
15+18+50	1.30	1.56	4.34	-	-	7.20 (2.90-8.50)	1.847 (0.700-2.510)	8.11	99
15+18+60	1.16	1.39	4.65	-	-	7.20 (2.90-8.50)	1.750 (0.700-2.490)	7.69	99
15+20+20	1.50	2.00	2.00	-	-	5.50 (2.90-8.10)	1.515 (0.780-2.245)	6.65	99
15+20+22	1.50	2.00	2.20	-	-	5.70 (2.90-8.10)	1.569 (0.780-2.915)	6.89	99
15+20+25	1.50	2.00	2.50	-	-	6.00 (2.90-8.10)	1.710 (0.830-3.980)	7.51	99
15+20+35	1.50	2.00	3.50	-	-	7.00 (2.90-8.30)	1.853 (0.740-2.690)	8.14	99
15+20+42	1.40	1.87	3.93	-	-	7.20 (2.90-8.50)	1.937 (0.730-2.570)	8.51	99
15+20+50	1.27	1.69	4.24	-	-	7.20 (2.90-8.50)	1.873 (0.730-2.550)	8.23	99
15+20+60	1.14	1.52	4.55	-	-	7.20 (2.90-8.50)	1.777 (0.730-2.530)	7.80	99
15+22+22	1.50	2.20	2.20	-	-	5.90 (2.90-8.10)	1.623 (0.780-3.585)	7.13	99
15+22+25	1.50	2.20	2.50	-	-	6.20 (2.90-8.10)	1.640 (0.770-3.605)	7.20	99
15+22+42	1.37	2.01	3.83	-	-	7.20 (2.90-8.50)	1.883 (0.700-2.525)	8.27	99
15+22+50	1.24	1.82	4.14	-	-	7.20 (2.90-8.50)	1.820 (0.700-2.510)	7.99	99
15+22+60	1.11	1.63	4.45	-	-	7.20 (2.90-8.50)	1.723 (0.700-2.490)	7.57	99
15+25+25	1.50	2.50	2.50	-	-	6.50 (2.90-8.10)	1.595 (0.720-3.100)	7.00	99

MXZ-4D72VA COOLING

Indoor units combination	Cooling capacity (kW)						Outdoor unit power consumption(kW)	Current (A)	Power factor(%)
	Unit A	Unit B	Unit C	Unit D	Unit E	Total			
15+25+35	1.44	2.40	3.36	-	-	7.20 (2.90-8.50)	1.930 (0.700-2.540)	8.48	99
15+25+42	1.32	2.20	3.69	-	-	7.20 (2.90-8.50)	1.863 (0.700-2.525)	8.18	99
15+25+50	1.20	2.00	4.00	-	-	7.20 (2.90-8.50)	1.800 (0.700-2.505)	7.91	99
15+25+60	1.08	1.80	4.32	-	-	7.20 (2.90-8.50)	1.703 (0.700-2.485)	7.48	99
15+35+35	1.27	2.96	2.96	-	-	7.20 (2.90-8.50)	1.863 (0.700-2.530)	8.18	99
15+35+42	1.17	2.74	3.29	-	-	7.20 (2.90-8.50)	1.797 (0.700-2.515)	7.89	99
15+35+50	1.08	2.52	3.60	-	-	7.20 (2.90-8.50)	1.733 (0.700-2.495)	7.61	99
15+35+60	0.98	2.29	3.93	-	-	7.20 (2.90-8.50)	1.670 (0.700-2.480)	7.33	99
15+42+42	1.09	3.05	3.05	-	-	7.20 (2.90-8.50)	1.730 (0.700-2.495)	7.60	99
15+42+50	1.01	2.83	3.36	-	-	7.20 (2.90-8.50)	1.680 (0.700-2.480)	7.38	99
15+42+60	0.92	2.58	3.69	-	-	7.20 (2.90-8.50)	1.650 (0.700-2.470)	7.25	99
15+50+50	0.94	3.13	3.13	-	-	7.20 (2.90-8.50)	1.670 (0.700-2.470)	7.33	99
15+50+60	0.86	2.88	3.46	-	-	7.20 (2.90-8.50)	1.640 (0.700-2.460)	7.20	99
18+18+18	1.80	1.80	1.80	-	-	5.40 (2.90-8.10)	1.348 (0.670-1.770)	5.92	99
18+18+20	1.80	1.80	2.00	-	-	5.60 (2.90-8.10)	1.482 (0.730-2.520)	6.51	99
18+18+22	1.80	1.80	2.20	-	-	5.80 (2.90-8.10)	1.536 (0.740-3.190)	6.75	99
18+18+25	1.80	1.80	2.50	-	-	6.10 (2.90-8.10)	1.615 (0.750-3.730)	7.09	99
18+18+35	1.80	1.80	3.50	-	-	7.10 (2.90-8.40)	1.832 (0.680-2.540)	8.05	99
18+18+42	1.66	1.66	3.88	-	-	7.20 (2.90-8.50)	1.850 (0.670-2.485)	8.12	99
18+18+50	1.51	1.51	4.19	-	-	7.20 (2.90-8.50)	1.787 (0.670-2.470)	7.85	99
18+18+60	1.35	1.35	4.50	-	-	7.20 (2.90-8.50)	1.690 (0.670-2.450)	7.42	99
18+20+20	1.80	2.00	2.00	-	-	5.80 (2.90-8.10)	1.616 (0.800-3.270)	7.10	99
18+20+22	1.80	2.00	2.20	-	-	6.00 (2.90-8.10)	1.670 (0.800-3.940)	7.33	99
18+20+25	1.80	2.00	2.50	-	-	6.30 (2.90-8.10)	1.625 (0.750-3.435)	7.14	99
18+20+35	1.78	1.97	3.45	-	-	7.20 (2.90-8.40)	1.930 (0.710-2.520)	8.48	99
18+20+42	1.62	1.80	3.78	-	-	7.20 (2.90-8.50)	1.877 (0.700-2.525)	8.24	99
18+20+50	1.47	1.64	4.09	-	-	7.20 (2.90-8.50)	1.813 (0.700-2.505)	7.96	99
18+20+60	1.32	1.47	4.41	-	-	7.20 (2.90-8.50)	1.717 (0.700-2.485)	7.54	99
18+22+22	1.80	2.20	2.20	-	-	6.20 (2.90-8.10)	1.600 (0.740-3.565)	7.03	99
18+22+25	1.80	2.20	2.50	-	-	6.50 (2.90-8.10)	1.555 (0.690-3.060)	6.83	99
18+22+35	1.73	2.11	3.36	-	-	7.20 (2.90-8.50)	1.890 (0.670-2.500)	8.30	99
18+22+42	1.58	1.93	3.69	-	-	7.20 (2.90-8.50)	1.823 (0.670-2.485)	8.01	99
18+22+50	1.44	1.76	4.00	-	-	7.20 (2.90-8.50)	1.760 (0.670-2.465)	7.73	99
18+22+60	1.30	1.58	4.32	-	-	7.20 (2.90-8.50)	1.663 (0.670-2.445)	7.30	99
18+25+25	1.80	2.50	2.50	-	-	6.80 (2.90-8.20)	1.657 (0.670-2.750)	7.28	99
18+25+35	1.66	2.31	3.23	-	-	7.20 (2.90-8.50)	1.870 (0.670-2.495)	8.21	99
18+25+42	1.52	2.12	3.56	-	-	7.20 (2.90-8.50)	1.803 (0.670-2.480)	7.92	99
18+25+50	1.39	1.94	3.87	-	-	7.20 (2.90-8.50)	1.740 (0.670-2.460)	7.64	99
18+25+60	1.26	1.75	4.19	-	-	7.20 (2.90-8.50)	1.643 (0.670-2.440)	7.22	99
18+35+35	1.47	2.86	2.86	-	-	7.20 (2.90-8.50)	1.803 (0.670-2.485)	7.92	99
18+35+42	1.36	2.65	3.18	-	-	7.20 (2.90-8.50)	1.737 (0.670-2.470)	7.63	99

MXZ-4D72VA COOLING

Indoor units combination	Cooling capacity (kW)						Outdoor unit power consumption(kW)	Current (A)	Power factor(%)
	Unit A	Unit B	Unit C	Unit D	Unit E	Total			
18+35+50	1.26	2.45	3.50	-	-	7.20 (2.90-8.50)	1.673 (0.670-2.450)	7.35	99
18+35+60	1.15	2.23	3.82	-	-	7.20 (2.90-8.50)	1.630 (0.670-2.440)	7.16	99
18+42+42	1.27	2.96	2.96	-	-	7.20 (2.90-8.50)	1.670 (0.670-2.455)	7.33	99
18+42+50	1.18	2.75	3.27	-	-	7.20 (2.90-8.50)	1.640 (0.670-2.440)	7.20	99
18+42+60	1.08	2.52	3.60	-	-	7.20 (2.90-8.50)	1.610 (0.670-2.430)	7.07	99
18+50+50	1.10	3.05	3.05	-	-	7.20 (2.90-8.50)	1.630 (0.670-2.430)	7.16	99
20+20+20	2.00	2.00	2.00	-	-	6.00 (2.90-8.10)	1.630 (0.770-3.900)	7.16	99
20+20+22	2.00	2.00	2.20	-	-	6.20 (2.90-8.10)	1.680 (0.800-3.645)	7.38	99
20+20+25	2.00	2.00	2.50	-	-	6.50 (2.90-8.10)	1.635 (0.750-3.140)	7.18	99
20+20+35	1.92	1.92	3.36	-	-	7.20 (2.90-8.50)	1.970 (0.730-2.580)	8.65	99
20+20+42	1.76	1.76	3.69	-	-	7.20 (2.90-8.50)	1.903 (0.730-2.565)	8.36	99
20+20+50	1.60	1.60	4.00	-	-	7.20 (2.90-8.50)	1.840 (0.730-2.545)	8.08	99
20+20+60	1.44	1.44	4.32	-	-	7.20 (2.90-8.50)	1.743 (0.730-2.525)	7.65	99
20+22+22	2.00	2.20	2.20	-	-	6.40 (2.90-8.10)	1.610 (0.730-3.265)	7.07	99
20+22+25	2.00	2.20	2.50	-	-	6.70 (2.90-8.20)	1.638 (0.700-2.860)	7.19	99
20+22+35	1.87	2.06	3.27	-	-	7.20 (2.90-8.50)	1.917 (0.700-2.540)	8.42	99
20+22+42	1.71	1.89	3.60	-	-	7.20 (2.90-8.50)	1.850 (0.700-2.520)	8.12	99
20+22+50	1.57	1.72	3.91	-	-	7.20 (2.90-8.50)	1.787 (0.700-2.505)	7.85	99
20+22+60	1.41	1.55	4.24	-	-	7.20 (2.90-8.50)	1.690 (0.700-2.485)	7.42	99
20+25+25	2.00	2.50	2.50	-	-	7.00 (2.90-8.30)	1.813 (0.710-2.650)	7.96	99
20+25+35	1.80	2.25	3.15	-	-	7.20 (2.90-8.50)	1.897 (0.700-2.535)	8.33	99
20+25+42	1.66	2.07	3.48	-	-	7.20 (2.90-8.50)	1.830 (0.700-2.520)	8.04	99
20+25+50	1.52	1.89	3.79	-	-	7.20 (2.90-8.50)	1.767 (0.700-2.500)	7.76	99
20+25+60	1.37	1.71	4.11	-	-	7.20 (2.90-8.50)	1.670 (0.700-2.480)	7.33	99
20+35+35	1.60	2.80	2.80	-	-	7.20 (2.90-8.50)	1.830 (0.700-2.525)	8.04	99
20+35+42	1.48	2.60	3.12	-	-	7.20 (2.90-8.50)	1.763 (0.700-2.510)	7.74	99
20+35+50	1.37	2.40	3.43	-	-	7.20 (2.90-8.50)	1.700 (0.700-2.490)	7.47	99
20+35+60	1.25	2.19	3.76	-	-	7.20 (2.90-8.50)	1.670 (0.700-2.480)	7.33	99
20+42+42	1.38	2.91	2.91	-	-	7.20 (2.90-8.50)	1.697 (0.700-2.490)	7.45	99
20+42+50	1.29	2.70	3.21	-	-	7.20 (2.90-8.50)	1.680 (0.700-2.480)	7.38	99
20+42+60	1.18	2.48	3.54	-	-	7.20 (2.90-8.50)	1.650 (0.700-2.470)	7.25	99
20+50+50	1.20	3.00	3.00	-	-	7.20 (2.90-8.50)	1.670 (0.700-2.470)	7.33	99
22+22+22	2.20	2.20	2.20	-	-	6.60 (2.90-8.10)	1.540 (0.670-2.890)	6.76	99
22+22+25	2.20	2.20	2.50	-	-	6.90 (2.90-8.30)	1.715 (0.680-2.680)	7.53	99
22+22+35	2.01	2.01	3.19	-	-	7.20 (2.90-8.50)	1.863 (0.670-2.495)	8.18	99
22+22+42	1.84	1.84	3.52	-	-	7.20 (2.90-8.50)	1.797 (0.670-2.480)	7.89	99
22+22+50	1.69	1.69	3.83	-	-	7.20 (2.90-8.50)	1.733 (0.670-2.460)	7.61	99
22+22+60	1.52	1.52	4.15	-	-	7.20 (2.90-8.50)	1.637 (0.670-2.440)	7.19	99
22+25+35	1.93	2.20	3.07	-	-	7.20 (2.90-8.50)	1.843 (0.670-2.495)	8.09	99
22+25+42	1.78	2.02	3.40	-	-	7.20 (2.90-8.50)	1.777 (0.670-2.475)	7.80	99
22+25+50	1.63	1.86	3.71	-	-	7.20 (2.90-8.50)	1.713 (0.670-2.460)	7.52	99

MXZ-4D72VA COOLING

Indoor units combination	Cooling capacity (kW)						Outdoor unit power consumption(kW)	Current (A)	Power factor(%)
	Unit A	Unit B	Unit C	Unit D	Unit E	Total			
22+25+60	1.48	1.68	4.04	-	-	7.20 (2.90-8.50)	1.630 (0.670-2.440)	7.16	99
22+35+35	1.72	2.74	2.74	-	-	7.20 (2.90-8.50)	1.777 (0.670-2.485)	7.80	99
22+35+42	1.60	2.55	3.05	-	-	7.20 (2.90-8.50)	1.710 (0.670-2.465)	7.51	99
22+35+50	1.48	2.36	3.36	-	-	7.20 (2.90-8.50)	1.660 (0.670-2.450)	7.29	99
22+35+60	1.35	2.15	3.69	-	-	7.20 (2.90-8.50)	1.630 (0.670-2.440)	7.16	99
22+42+42	1.49	2.85	2.85	-	-	7.20 (2.90-8.50)	1.650 (0.670-2.450)	7.25	99
22+42+50	1.39	2.65	3.16	-	-	7.20 (2.90-8.50)	1.640 (0.670-2.440)	7.20	99
22+42+60	1.28	2.44	3.48	-	-	7.20 (2.90-8.50)	1.610 (0.670-2.430)	7.07	99
22+50+50	1.30	2.95	2.95	-	-	7.20 (2.90-8.50)	1.630 (0.670-2.430)	7.16	99
25+25+25	2.40	2.40	2.40	-	-	7.20 (2.90-8.50)	1.890 (0.670-2.500)	8.30	99
25+25+35	2.12	2.12	2.96	-	-	7.20 (2.90-8.50)	1.823 (0.670-2.490)	8.01	99
25+25+42	1.96	1.96	3.29	-	-	7.20 (2.90-8.50)	1.757 (0.670-2.475)	7.72	99
25+25+50	1.80	1.80	3.60	-	-	7.20 (2.90-8.50)	1.693 (0.670-2.455)	7.44	99
25+25+60	1.64	1.64	3.93	-	-	7.20 (2.90-8.50)	1.630 (0.670-2.440)	7.16	99
25+35+35	1.89	2.65	2.65	-	-	7.20 (2.90-8.50)	1.757 (0.670-2.480)	7.72	99
25+35+42	1.76	2.47	2.96	-	-	7.20 (2.90-8.50)	1.690 (0.670-2.465)	7.42	99
25+35+50	1.64	2.29	3.27	-	-	7.20 (2.90-8.50)	1.660 (0.670-2.450)	7.29	99
25+35+60	1.50	2.10	3.60	-	-	7.20 (2.90-8.50)	1.630 (0.670-2.440)	7.16	99
25+42+42	1.65	2.77	2.77	-	-	7.20 (2.90-8.50)	1.650 (0.670-2.450)	7.25	99
25+42+50	1.54	2.58	3.08	-	-	7.20 (2.90-8.50)	1.640 (0.670-2.440)	7.20	99
25+50+50	1.44	2.88	2.88	-	-	7.20 (2.90-8.50)	1.630 (0.670-2.430)	7.16	99
35+35+35	2.40	2.40	2.40	-	-	7.20 (2.90-8.50)	1.690 (0.670-2.470)	7.42	99
35+35+42	2.25	2.25	2.70	-	-	7.20 (2.90-8.50)	1.670 (0.670-2.460)	7.33	99
35+35+50	2.10	2.10	3.00	-	-	7.20 (2.90-8.50)	1.660 (0.670-2.450)	7.29	99
35+42+42	2.12	2.54	2.54	-	-	7.20 (2.90-8.50)	1.650 (0.670-2.450)	7.25	99
15+15+15+15	1.50	1.50	1.50	1.50	-	6.00 (3.70-8.00)	1.788 (0.800-3.190)	7.85	99
15+15+15+18	1.50	1.50	1.50	1.80	-	6.30 (3.70-8.20)	2.010 (0.890-3.340)	8.83	99
15+15+15+20	1.50	1.50	1.50	2.00	-	6.50 (3.70-8.00)	2.117 (0.920-3.390)	9.30	99
15+15+15+22	1.50	1.50	1.50	2.20	-	6.70 (3.70-8.20)	2.145 (0.890-3.340)	9.42	99
15+15+15+25	1.50	1.50	1.50	2.50	-	7.00 (3.70-8.20)	2.246 (0.890-3.340)	9.86	99
15+15+15+35	1.35	1.35	1.35	3.15	-	7.20 (3.70-8.20)	2.314 (0.890-3.340)	10.16	99
15+15+15+42	1.24	1.24	1.24	3.48	-	7.20 (3.70-8.20)	2.294 (0.890-3.330)	10.07	99
15+15+15+50	1.14	1.14	1.14	3.79	-	7.20 (3.70-8.20)	2.284 (0.890-3.320)	10.03	99
15+15+15+60	1.03	1.03	1.03	4.11	-	7.20 (3.70-8.20)	2.254 (0.890-3.310)	9.90	99
15+15+18+18	1.50	1.50	1.80	1.80	-	6.60 (3.70-8.40)	2.071 (0.860-3.290)	9.10	99
15+15+18+20	1.50	1.50	1.80	2.00	-	6.80 (3.70-8.20)	2.179 (0.890-3.340)	9.57	99
15+15+18+22	1.50	1.50	1.80	2.20	-	7.00 (3.70-8.40)	2.206 (0.860-3.290)	9.69	99
15+15+18+25	1.48	1.48	1.78	2.47	-	7.20 (3.70-8.40)	2.274 (0.860-3.290)	9.99	99
15+15+18+35	1.30	1.30	1.56	3.04	-	7.20 (3.70-8.40)	2.274 (0.860-3.290)	9.99	99
15+15+18+42	1.20	1.20	1.44	3.36	-	7.20 (3.70-8.40)	2.254 (0.860-3.280)	9.90	99
15+15+18+50	1.10	1.10	1.32	3.67	-	7.20 (3.70-8.40)	2.244 (0.860-3.270)	9.86	99

MXZ-4D72VA COOLING

Indoor units combination	Cooling capacity (kW)						Outdoor unit power consumption(kW)	Current (A)	Power factor(%)
	Unit A	Unit B	Unit C	Unit D	Unit E	Total			
15+15+18+60	1.00	1.00	1.20	4.00	-	7.20 (3.70-8.40)	2.214 (0.860-3.260)	9.72	99
15+15+20+20	1.50	1.50	2.00	2.00	-	7.00 (3.70-8.00)	2.286 (0.920-3.390)	10.04	99
15+15+20+25	1.44	1.44	1.92	2.40	-	7.20 (3.70-8.20)	2.314 (0.890-3.340)	10.16	99
15+15+20+35	1.27	1.27	1.69	2.96	-	7.20 (3.70-8.20)	2.314 (0.890-3.340)	10.16	99
15+15+20+42	1.17	1.17	1.57	3.29	-	7.20 (3.70-8.20)	2.294 (0.890-3.330)	10.07	99
15+15+20+50	1.08	1.08	1.44	3.60	-	7.20 (3.70-8.20)	2.284 (0.890-3.320)	10.03	99
15+15+20+60	0.98	0.98	1.31	3.93	-	7.20 (3.70-8.20)	2.254 (0.890-3.310)	9.90	99
15+15+22+22	1.46	1.46	2.14	2.14	-	7.20 (3.70-8.40)	2.274 (0.860-3.290)	9.99	99
15+15+22+25	1.40	1.40	2.06	2.34	-	7.20 (3.70-8.40)	2.274 (0.860-3.290)	9.99	99
15+15+22+35	1.24	1.24	1.82	2.90	-	7.20 (3.70-8.40)	2.274 (0.860-3.290)	9.99	99
15+15+22+42	1.15	1.15	1.69	3.22	-	7.20 (3.70-8.40)	2.254 (0.860-3.280)	9.90	99
15+15+22+50	1.06	1.06	1.55	3.53	-	7.20 (3.70-8.40)	2.244 (0.860-3.270)	9.86	99
15+15+22+60	0.96	0.96	1.41	3.86	-	7.20 (3.70-8.40)	2.214 (0.860-3.260)	9.72	99
15+15+25+25	1.35	1.35	2.25	2.25	-	7.20 (3.70-8.40)	2.274 (0.860-3.290)	9.99	99
15+15+25+35	1.20	1.20	2.00	2.80	-	7.20 (3.70-8.40)	2.274 (0.860-3.290)	9.99	99
15+15+25+42	1.11	1.11	1.86	3.12	-	7.20 (3.70-8.40)	2.254 (0.860-3.280)	9.90	99
15+15+25+50	1.03	1.03	1.71	3.43	-	7.20 (3.70-8.40)	2.244 (0.860-3.270)	9.86	99
15+15+25+60	0.94	0.94	1.57	3.76	-	7.20 (3.70-8.40)	2.214 (0.860-3.260)	9.72	99
15+15+35+35	1.08	1.08	2.52	2.52	-	7.20 (3.70-8.40)	2.274 (0.860-3.290)	9.99	99
15+15+35+42	1.01	1.01	2.36	2.83	-	7.20 (3.70-8.40)	2.254 (0.860-3.280)	9.90	99
15+15+35+50	0.94	0.94	2.19	3.13	-	7.20 (3.70-8.40)	2.244 (0.860-3.270)	9.86	99
15+15+35+60	0.86	0.86	2.02	3.46	-	7.20 (3.70-8.40)	2.214 (0.860-3.260)	9.72	99
15+15+42+42	0.95	0.95	2.65	2.65	-	7.20 (3.70-8.40)	2.234 (0.860-3.270)	9.81	99
15+15+42+50	0.89	0.89	2.48	2.95	-	7.20 (3.70-8.40)	2.224 (0.860-3.260)	9.77	99
15+18+18+18	1.50	1.80	1.80	1.80	-	6.90 (3.70-8.60)	2.133 (0.830-3.240)	9.37	99
15+18+18+20	1.50	1.80	1.80	2.00	-	7.10 (3.70-8.40)	2.240 (0.860-3.290)	9.84	99
15+18+18+22	1.48	1.78	1.78	2.17	-	7.20 (3.70-8.60)	2.234 (0.830-3.240)	9.81	99
15+18+18+25	1.42	1.71	1.71	2.37	-	7.20 (3.70-8.60)	2.234 (0.830-3.240)	9.81	99
15+18+18+35	1.26	1.51	1.51	2.93	-	7.20 (3.70-8.60)	2.234 (0.830-3.240)	9.81	99
15+18+18+42	1.16	1.39	1.39	3.25	-	7.20 (3.70-8.60)	2.214 (0.830-3.230)	9.72	99
15+18+18+50	1.07	1.28	1.28	3.56	-	7.20 (3.70-8.60)	2.204 (0.830-3.220)	9.68	99
15+18+18+60	0.97	1.17	1.17	3.89	-	7.20 (3.70-8.60)	2.174 (0.830-3.210)	9.55	99
15+18+20+20	1.48	1.78	1.97	1.97	-	7.20 (3.70-8.20)	2.314 (0.890-3.340)	10.16	99
15+18+20+22	1.44	1.73	1.92	2.11	-	7.20 (3.70-8.40)	2.274 (0.860-3.290)	9.99	99
15+18+20+25	1.38	1.66	1.85	2.31	-	7.20 (3.70-8.40)	2.274 (0.860-3.290)	9.99	99
15+18+20+35	1.23	1.47	1.64	2.86	-	7.20 (3.70-8.40)	2.274 (0.860-3.290)	9.99	99
15+18+20+42	1.14	1.36	1.52	3.18	-	7.20 (3.70-8.40)	2.254 (0.860-3.280)	9.90	99
15+18+20+50	1.05	1.26	1.40	3.50	-	7.20 (3.70-8.40)	2.244 (0.860-3.270)	9.86	99
15+18+20+60	0.96	1.15	1.27	3.82	-	7.20 (3.70-8.40)	2.214 (0.860-3.260)	9.72	99
15+18+22+22	1.40	1.68	2.06	2.06	-	7.20 (3.70-8.60)	2.234 (0.830-3.240)	9.81	99
15+18+22+25	1.35	1.62	1.98	2.25	-	7.20 (3.70-8.60)	2.234 (0.830-3.240)	9.81	99

MXZ-4D72VA COOLING

Indoor units combination	Cooling capacity (kW)						Outdoor unit power consumption(kW)	Current (A)	Power factor(%)
	Unit A	Unit B	Unit C	Unit D	Unit E	Total			
15+18+22+35	1.20	1.44	1.76	2.80	-	7.20 (3.70-8.60)	2.234 (0.830-3.240)	9.81	99
15+18+22+42	1.11	1.34	1.63	3.12	-	7.20 (3.70-8.60)	2.214 (0.830-3.230)	9.72	99
15+18+22+50	1.03	1.23	1.51	3.43	-	7.20 (3.70-8.60)	2.204 (0.830-3.220)	9.68	99
15+18+22+60	0.94	1.13	1.38	3.76	-	7.20 (3.70-8.60)	2.174 (0.830-3.210)	9.55	99
15+18+25+25	1.30	1.56	2.17	2.17	-	7.20 (3.70-8.60)	2.234 (0.830-3.240)	9.81	99
15+18+25+35	1.16	1.39	1.94	2.71	-	7.20 (3.70-8.60)	2.234 (0.830-3.240)	9.81	99
15+18+25+42	1.08	1.30	1.80	3.02	-	7.20 (3.70-8.60)	2.214 (0.830-3.230)	9.72	99
15+18+25+50	1.00	1.20	1.67	3.33	-	7.20 (3.70-8.60)	2.204 (0.830-3.220)	9.68	99
15+18+25+60	0.92	1.10	1.53	3.66	-	7.20 (3.70-8.60)	2.174 (0.830-3.210)	9.55	99
15+18+35+35	1.05	1.26	2.45	2.45	-	7.20 (3.70-8.60)	2.234 (0.830-3.240)	9.81	99
15+18+35+42	0.98	1.18	2.29	2.75	-	7.20 (3.70-8.60)	2.214 (0.830-3.230)	9.72	99
15+18+35+50	0.92	1.10	2.14	3.05	-	7.20 (3.70-8.60)	2.204 (0.830-3.220)	9.68	99
15+18+42+42	0.92	1.11	2.58	2.58	-	7.20 (3.70-8.60)	2.194 (0.830-3.220)	9.64	99
15+18+42+50	0.86	1.04	2.42	2.88	-	7.20 (3.70-8.60)	2.184 (0.830-3.210)	9.59	99
15+20+20+20	1.44	1.92	1.92	1.92	-	7.20 (3.70-8.00)	2.354 (0.920-3.390)	10.34	99
15+20+20+22	1.40	1.87	1.87	2.06	-	7.20 (3.70-8.20)	2.314 (0.890-3.340)	10.16	99
15+20+20+25	1.35	1.80	1.80	2.25	-	7.20 (3.70-8.20)	2.314 (0.890-3.340)	10.16	99
15+20+20+35	1.20	1.60	1.60	2.80	-	7.20 (3.70-8.20)	2.314 (0.890-3.340)	10.16	99
15+20+20+42	1.11	1.48	1.48	3.12	-	7.20 (3.70-8.20)	2.294 (0.890-3.330)	10.07	99
15+20+20+50	1.03	1.37	1.37	3.43	-	7.20 (3.70-8.20)	2.284 (0.890-3.320)	10.03	99
15+20+20+60	0.94	1.25	1.25	3.76	-	7.20 (3.70-8.20)	2.254 (0.890-3.310)	9.90	99
15+20+22+22	1.37	1.82	2.01	2.01	-	7.20 (3.70-8.40)	2.274 (0.860-3.290)	9.99	99
15+20+22+25	1.32	1.76	1.93	2.20	-	7.20 (3.70-8.40)	2.274 (0.860-3.290)	9.99	99
15+20+22+35	1.17	1.57	1.72	2.74	-	7.20 (3.70-8.40)	2.274 (0.860-3.290)	9.99	99
15+20+22+42	1.09	1.45	1.60	3.05	-	7.20 (3.70-8.40)	2.254 (0.860-3.280)	9.90	99
15+20+22+50	1.01	1.35	1.48	3.36	-	7.20 (3.70-8.40)	2.244 (0.860-3.270)	9.86	99
15+20+22+60	0.92	1.23	1.35	3.69	-	7.20 (3.70-8.40)	2.214 (0.860-3.260)	9.72	99
15+20+25+25	1.27	1.69	2.12	2.12	-	7.20 (3.70-8.40)	2.274 (0.860-3.290)	9.99	99
15+20+25+35	1.14	1.52	1.89	2.65	-	7.20 (3.70-8.40)	2.274 (0.860-3.290)	9.99	99
15+20+25+42	1.06	1.41	1.76	2.96	-	7.20 (3.70-8.40)	2.254 (0.860-3.280)	9.90	99
15+20+25+50	0.98	1.31	1.64	3.27	-	7.20 (3.70-8.40)	2.244 (0.860-3.270)	9.86	99
15+20+25+60	0.90	1.20	1.50	3.60	-	7.20 (3.70-8.40)	2.214 (0.860-3.260)	9.72	99
15+20+35+35	1.03	1.37	2.40	2.40	-	7.20 (3.70-8.40)	2.274 (0.860-3.290)	9.99	99
15+20+35+42	0.96	1.29	2.25	2.70	-	7.20 (3.70-8.40)	2.254 (0.860-3.280)	9.90	99
15+20+35+50	0.90	1.20	2.10	3.00	-	7.20 (3.70-8.40)	2.244 (0.860-3.270)	9.86	99
15+20+42+42	0.91	1.21	2.54	2.54	-	7.20 (3.70-8.40)	2.234 (0.860-3.270)	9.81	99
15+22+22+22	1.33	1.96	1.96	1.96	-	7.20 (3.70-8.60)	2.234 (0.830-3.240)	9.81	99
15+22+22+25	1.29	1.89	1.89	2.14	-	7.20 (3.70-8.60)	2.234 (0.830-3.240)	9.81	99
15+22+22+35	1.15	1.69	1.69	2.68	-	7.20 (3.70-8.60)	2.234 (0.830-3.240)	9.81	99
15+22+22+42	1.07	1.57	1.57	2.99	-	7.20 (3.70-8.60)	2.214 (0.830-3.230)	9.72	99
15+22+22+50	0.99	1.45	1.45	3.30	-	7.20 (3.70-8.60)	2.204 (0.830-3.220)	9.68	99

MXZ-4D72VA COOLING

Indoor units combination	Cooling capacity (kW)						Outdoor unit power consumption(kW)	Current (A)	Power factor(%)
	Unit A	Unit B	Unit C	Unit D	Unit E	Total			
15+22+22+60	0.91	1.33	1.33	3.63	-	7.20 (3.70-8.60)	2.174 (0.830-3.210)	9.55	99
15+22+25+25	1.24	1.82	2.07	2.07	-	7.20 (3.70-8.60)	2.234 (0.830-3.240)	9.81	99
15+22+25+35	1.11	1.63	1.86	2.60	-	7.20 (3.70-8.60)	2.234 (0.830-3.240)	9.81	99
15+22+25+42	1.04	1.52	1.73	2.91	-	7.20 (3.70-8.60)	2.214 (0.830-3.230)	9.72	99
15+22+25+50	0.96	1.41	1.61	3.21	-	7.20 (3.70-8.60)	2.204 (0.830-3.220)	9.68	99
15+22+25+60	0.89	1.30	1.48	3.54	-	7.20 (3.70-8.60)	2.174 (0.830-3.210)	9.55	99
15+22+35+35	1.01	1.48	2.36	2.36	-	7.20 (3.70-8.60)	2.234 (0.830-3.240)	9.81	99
15+22+35+42	0.95	1.39	2.21	2.65	-	7.20 (3.70-8.60)	2.214 (0.830-3.230)	9.72	99
15+22+35+50	0.89	1.30	2.07	2.95	-	7.20 (3.70-8.60)	2.204 (0.830-3.220)	9.68	99
15+22+42+42	0.89	1.31	2.50	2.50	-	7.20 (3.70-8.60)	2.194 (0.830-3.220)	9.64	99
15+25+25+25	1.20	2.00	2.00	2.00	-	7.20 (3.70-8.60)	2.234 (0.830-3.240)	9.81	99
15+25+25+35	1.08	1.80	1.80	2.52	-	7.20 (3.70-8.60)	2.234 (0.830-3.240)	9.81	99
15+25+25+42	1.01	1.68	1.68	2.83	-	7.20 (3.70-8.60)	2.214 (0.830-3.230)	9.72	99
15+25+25+50	0.94	1.57	1.57	3.13	-	7.20 (3.70-8.60)	2.204 (0.830-3.220)	9.68	99
15+25+25+60	0.86	1.44	1.44	3.46	-	7.20 (3.70-8.60)	2.174 (0.830-3.210)	9.55	99
15+25+35+35	0.98	1.64	2.29	2.29	-	7.20 (3.70-8.60)	2.234 (0.830-3.240)	9.81	99
15+25+35+42	0.92	1.54	2.15	2.58	-	7.20 (3.70-8.60)	2.214 (0.830-3.230)	9.72	99
15+25+35+50	0.86	1.44	2.02	2.88	-	7.20 (3.70-8.60)	2.204 (0.830-3.220)	9.68	99
15+25+42+42	0.87	1.45	2.44	2.44	-	7.20 (3.70-8.60)	2.194 (0.830-3.220)	9.64	99
15+35+35+35	0.90	2.10	2.10	2.10	-	7.20 (3.70-8.60)	2.234 (0.830-3.240)	9.81	99
18+18+18+18	1.80	1.80	1.80	1.80	-	7.20 (3.70-8.80)	2.194 (0.800-3.190)	9.64	99
18+18+18+20	1.75	1.75	1.75	1.95	-	7.20 (3.70-8.60)	2.234 (0.830-3.240)	9.81	99
18+18+18+22	1.71	1.71	1.71	2.08	-	7.20 (3.70-8.80)	2.194 (0.800-3.190)	9.64	99
18+18+18+25	1.64	1.64	1.64	2.28	-	7.20 (3.70-8.80)	2.194 (0.800-3.190)	9.64	99
18+18+18+35	1.46	1.46	1.46	2.83	-	7.20 (3.70-8.80)	2.194 (0.800-3.190)	9.64	99
18+18+18+42	1.35	1.35	1.35	3.15	-	7.20 (3.70-8.80)	2.174 (0.800-3.180)	9.55	99
18+18+18+50	1.25	1.25	1.25	3.46	-	7.20 (3.70-8.80)	2.164 (0.800-3.170)	9.50	99
18+18+18+60	1.14	1.14	1.14	3.79	-	7.20 (3.70-8.80)	2.134 (0.800-3.160)	9.37	99
18+18+20+20	1.71	1.71	1.89	1.89	-	7.20 (3.70-8.40)	2.274 (0.860-3.290)	9.99	99
18+18+20+22	1.66	1.66	1.85	2.03	-	7.20 (3.70-8.60)	2.234 (0.830-3.240)	9.81	99
18+18+20+25	1.60	1.60	1.78	2.22	-	7.20 (3.70-8.60)	2.234 (0.830-3.240)	9.81	99
18+18+20+35	1.42	1.42	1.58	2.77	-	7.20 (3.70-8.60)	2.234 (0.830-3.240)	9.81	99
18+18+20+42	1.32	1.32	1.47	3.09	-	7.20 (3.70-8.60)	2.214 (0.830-3.230)	9.72	99
18+18+20+50	1.22	1.22	1.36	3.40	-	7.20 (3.70-8.60)	2.204 (0.830-3.220)	9.68	99
18+18+20+60	1.12	1.12	1.24	3.72	-	7.20 (3.70-8.60)	2.174 (0.830-3.210)	9.55	99
18+18+22+22	1.62	1.62	1.98	1.98	-	7.20 (3.70-8.80)	2.194 (0.800-3.190)	9.64	99
18+18+22+25	1.56	1.56	1.91	2.17	-	7.20 (3.70-8.80)	2.194 (0.800-3.190)	9.64	99
18+18+22+35	1.39	1.39	1.70	2.71	-	7.20 (3.70-8.80)	2.194 (0.800-3.190)	9.64	99
18+18+22+42	1.30	1.30	1.58	3.02	-	7.20 (3.70-8.80)	2.174 (0.800-3.180)	9.55	99
18+18+22+50	1.20	1.20	1.47	3.33	-	7.20 (3.70-8.80)	2.164 (0.800-3.170)	9.50	99
18+18+22+60	1.10	1.10	1.34	3.66	-	7.20 (3.70-8.80)	2.134 (0.800-3.160)	9.37	99

MXZ-4D72VA COOLING

Indoor units combination	Cooling capacity (kW)						Outdoor unit power consumption(kW)	Current (A)	Power factor(%)
	Unit A	Unit B	Unit C	Unit D	Unit E	Total			
18+18+25+25	1.51	1.51	2.09	2.09	-	7.20 (3.70-8.80)	2.194 (0.800-3.190)	9.64	99
18+18+25+35	1.35	1.35	1.88	2.63	-	7.20 (3.70-8.80)	2.194 (0.800-3.190)	9.64	99
18+18+25+42	1.26	1.26	1.75	2.94	-	7.20 (3.70-8.80)	2.174 (0.800-3.180)	9.55	99
18+18+25+50	1.17	1.17	1.62	3.24	-	7.20 (3.70-8.80)	2.164 (0.800-3.170)	9.50	99
18+18+25+60	1.07	1.07	1.49	3.57	-	7.20 (3.70-8.80)	2.134 (0.800-3.160)	9.37	99
18+18+35+35	1.22	1.22	2.38	2.38	-	7.20 (3.70-8.80)	2.194 (0.800-3.190)	9.64	99
18+18+35+42	1.15	1.15	2.23	2.68	-	7.20 (3.70-8.80)	2.174 (0.800-3.180)	9.55	99
18+18+35+50	1.07	1.07	2.08	2.98	-	7.20 (3.70-8.80)	2.164 (0.800-3.170)	9.50	99
18+18+42+42	1.08	1.08	2.52	2.52	-	7.20 (3.70-8.80)	2.154 (0.800-3.170)	9.46	99
18+20+20+20	1.66	1.85	1.85	1.85	-	7.20 (3.70-8.20)	2.314 (0.890-3.340)	10.16	99
18+20+20+22	1.62	1.80	1.80	1.98	-	7.20 (3.70-8.40)	2.274 (0.860-3.290)	9.99	99
18+20+20+25	1.56	1.73	1.73	2.17	-	7.20 (3.70-8.40)	2.274 (0.860-3.290)	9.99	99
18+20+20+35	1.39	1.55	1.55	2.71	-	7.20 (3.70-8.40)	2.274 (0.860-3.290)	9.99	99
18+20+20+42	1.30	1.44	1.44	3.02	-	7.20 (3.70-8.40)	2.254 (0.860-3.280)	9.90	99
18+20+20+50	1.20	1.33	1.33	3.33	-	7.20 (3.70-8.40)	2.244 (0.860-3.270)	9.86	99
18+20+20+60	1.10	1.22	1.22	3.66	-	7.20 (3.70-8.40)	2.214 (0.860-3.260)	9.72	99
18+20+22+22	1.58	1.76	1.93	1.93	-	7.20 (3.70-8.60)	2.234 (0.830-3.240)	9.81	99
18+20+22+25	1.52	1.69	1.86	2.12	-	7.20 (3.70-8.60)	2.234 (0.830-3.240)	9.81	99
18+20+22+35	1.36	1.52	1.67	2.65	-	7.20 (3.70-8.60)	2.234 (0.830-3.240)	9.81	99
18+20+22+42	1.27	1.41	1.55	2.96	-	7.20 (3.70-8.60)	2.214 (0.830-3.230)	9.72	99
18+20+22+50	1.18	1.31	1.44	3.27	-	7.20 (3.70-8.60)	2.204 (0.830-3.220)	9.68	99
18+20+22+60	1.08	1.20	1.32	3.60	-	7.20 (3.70-8.60)	2.174 (0.830-3.210)	9.55	99
18+20+25+25	1.47	1.64	2.05	2.05	-	7.20 (3.70-8.60)	2.234 (0.830-3.240)	9.81	99
18+20+25+35	1.32	1.47	1.84	2.57	-	7.20 (3.70-8.60)	2.234 (0.830-3.240)	9.81	99
18+20+25+42	1.23	1.37	1.71	2.88	-	7.20 (3.70-8.60)	2.214 (0.830-3.230)	9.72	99
18+20+25+50	1.15	1.27	1.59	3.19	-	7.20 (3.70-8.60)	2.204 (0.830-3.220)	9.68	99
18+20+25+60	1.05	1.17	1.46	3.51	-	7.20 (3.70-8.60)	2.174 (0.830-3.210)	9.55	99
18+20+35+35	1.20	1.33	2.33	2.33	-	7.20 (3.70-8.60)	2.234 (0.830-3.240)	9.81	99
18+20+35+42	1.13	1.25	2.19	2.63	-	7.20 (3.70-8.60)	2.214 (0.830-3.230)	9.72	99
18+20+35+50	1.05	1.17	2.05	2.93	-	7.20 (3.70-8.60)	2.204 (0.830-3.220)	9.68	99
18+20+42+42	1.06	1.18	2.48	2.48	-	7.20 (3.70-8.60)	2.194 (0.830-3.220)	9.64	99
18+22+22+22	1.54	1.89	1.89	1.89	-	7.20 (3.70-8.80)	2.194 (0.800-3.190)	9.64	99
18+22+22+25	1.49	1.82	1.82	2.07	-	7.20 (3.70-8.80)	2.194 (0.800-3.190)	9.64	99
18+22+22+35	1.34	1.63	1.63	2.60	-	7.20 (3.70-8.80)	2.194 (0.800-3.190)	9.64	99
18+22+22+42	1.25	1.52	1.52	2.91	-	7.20 (3.70-8.80)	2.174 (0.800-3.180)	9.55	99
18+22+22+50	1.16	1.41	1.41	3.21	-	7.20 (3.70-8.80)	2.164 (0.800-3.170)	9.50	99
18+22+22+60	1.06	1.30	1.30	3.54	-	7.20 (3.70-8.80)	2.134 (0.800-3.160)	9.37	99
18+22+25+25	1.44	1.76	2.00	2.00	-	7.20 (3.70-8.80)	2.194 (0.800-3.190)	9.64	99
18+22+25+35	1.30	1.58	1.80	2.52	-	7.20 (3.70-8.80)	2.194 (0.800-3.190)	9.64	99
18+22+25+42	1.21	1.48	1.68	2.83	-	7.20 (3.70-8.80)	2.174 (0.800-3.180)	9.55	99
18+22+25+50	1.13	1.38	1.57	3.13	-	7.20 (3.70-8.80)	2.164 (0.800-3.170)	9.50	99

MXZ-4D72VA COOLING

Indoor units combination	Cooling capacity (kW)						Outdoor unit power consumption(kW)	Current (A)	Power factor(%)
	Unit A	Unit B	Unit C	Unit D	Unit E	Total			
18+22+25+60	1.04	1.27	1.44	3.46	-	7.20 (3.70-8.80)	2.134 (0.800-3.160)	9.37	99
18+22+35+35	1.18	1.44	2.29	2.29	-	7.20 (3.70-8.80)	2.194 (0.800-3.190)	9.64	99
18+22+35+42	1.11	1.35	2.15	2.58	-	7.20 (3.70-8.80)	2.174 (0.800-3.180)	9.55	99
18+22+35+50	1.04	1.27	2.02	2.88	-	7.20 (3.70-8.80)	2.164 (0.800-3.170)	9.50	99
18+22+42+42	1.05	1.28	2.44	2.44	-	7.20 (3.70-8.80)	2.154 (0.800-3.170)	9.46	99
18+25+25+25	1.39	1.94	1.94	1.94	-	7.20 (3.70-8.80)	2.194 (0.800-3.190)	9.64	99
18+25+25+35	1.26	1.75	1.75	2.45	-	7.20 (3.70-8.80)	2.194 (0.800-3.190)	9.64	99
18+25+25+42	1.18	1.64	1.64	2.75	-	7.20 (3.70-8.80)	2.174 (0.800-3.180)	9.55	99
18+25+25+50	1.10	1.53	1.53	3.05	-	7.20 (3.70-8.80)	2.164 (0.800-3.170)	9.50	99
18+25+35+35	1.15	1.59	2.23	2.23	-	7.20 (3.70-8.80)	2.194 (0.800-3.190)	9.64	99
18+25+35+42	1.08	1.50	2.10	2.52	-	7.20 (3.70-8.80)	2.174 (0.800-3.180)	9.55	99
18+35+35+35	1.05	2.05	2.05	2.05	-	7.20 (3.70-8.80)	2.194 (0.800-3.190)	9.64	99
20+20+20+20	1.80	1.80	1.80	1.80	-	7.20 (3.70-8.00)	2.194 (0.800-3.190)	9.64	99
20+20+20+22	1.76	1.76	1.76	1.93	-	7.20 (3.70-8.20)	2.314 (0.890-3.340)	10.16	99
20+20+20+25	1.69	1.69	1.69	2.12	-	7.20 (3.70-8.20)	2.314 (0.890-3.340)	10.16	99
20+20+20+35	1.52	1.52	1.52	2.65	-	7.20 (3.70-8.20)	2.314 (0.890-3.340)	10.16	99
20+20+20+42	1.41	1.41	1.41	2.96	-	7.20 (3.70-8.20)	2.294 (0.890-3.330)	10.07	99
20+20+20+50	1.31	1.31	1.31	3.27	-	7.20 (3.70-8.20)	2.284 (0.890-3.320)	10.03	99
20+20+20+60	1.20	1.20	1.20	3.60	-	7.20 (3.70-8.20)	2.254 (0.890-3.310)	9.90	99
20+20+22+22	1.71	1.71	1.89	1.89	-	7.20 (3.70-8.40)	2.274 (0.860-3.290)	9.99	99
20+20+22+25	1.66	1.66	1.82	2.07	-	7.20 (3.70-8.40)	2.274 (0.860-3.290)	9.99	99
20+20+22+35	1.48	1.48	1.63	2.60	-	7.20 (3.70-8.40)	2.274 (0.860-3.290)	9.99	99
20+20+22+42	1.38	1.38	1.52	2.91	-	7.20 (3.70-8.40)	2.254 (0.860-3.280)	9.90	99
20+20+22+50	1.29	1.29	1.41	3.21	-	7.20 (3.70-8.40)	2.244 (0.860-3.270)	9.86	99
20+20+22+60	1.18	1.18	1.30	3.54	-	7.20 (3.70-8.40)	2.214 (0.860-3.260)	9.72	99
20+20+25+25	1.60	1.60	2.00	2.00	-	7.20 (3.70-8.40)	2.274 (0.860-3.290)	9.99	99
20+20+25+35	1.44	1.44	1.80	2.52	-	7.20 (3.70-8.40)	2.274 (0.860-3.290)	9.99	99
20+20+25+42	1.35	1.35	1.68	2.83	-	7.20 (3.70-8.40)	2.254 (0.860-3.280)	9.90	99
20+20+25+50	1.25	1.25	1.57	3.13	-	7.20 (3.70-8.40)	2.244 (0.860-3.270)	9.86	99
20+20+25+60	1.15	1.15	1.44	3.46	-	7.20 (3.70-8.40)	2.214 (0.860-3.260)	9.72	99
20+20+35+35	1.31	1.31	2.29	2.29	-	7.20 (3.70-8.40)	2.274 (0.860-3.290)	9.99	99
20+20+35+42	1.23	1.23	2.15	2.58	-	7.20 (3.70-8.40)	2.254 (0.860-3.280)	9.90	99
20+20+35+50	1.15	1.15	2.02	2.88	-	7.20 (3.70-8.40)	2.244 (0.860-3.270)	9.86	99
20+20+42+42	1.16	1.16	2.44	2.44	-	7.20 (3.70-8.40)	2.234 (0.860-3.270)	9.81	99
20+22+22+22	1.67	1.84	1.84	1.84	-	7.20 (3.70-8.60)	2.234 (0.830-3.240)	9.81	99
20+22+22+25	1.62	1.78	1.78	2.02	-	7.20 (3.70-8.60)	2.234 (0.830-3.240)	9.81	99
20+22+22+35	1.45	1.60	1.60	2.55	-	7.20 (3.70-8.60)	2.234 (0.830-3.240)	9.81	99
20+22+22+42	1.36	1.49	1.49	2.85	-	7.20 (3.70-8.60)	2.214 (0.830-3.230)	9.72	99
20+22+22+50	1.26	1.39	1.39	3.16	-	7.20 (3.70-8.60)	2.204 (0.830-3.220)	9.68	99
20+22+22+60	1.16	1.28	1.28	3.48	-	7.20 (3.70-8.60)	2.174 (0.830-3.210)	9.55	99
20+22+25+25	1.57	1.72	1.96	1.96	-	7.20 (3.70-8.60)	2.234 (0.830-3.240)	9.81	99

MXZ-4D72VA COOLING

Indoor units combination	Cooling capacity (kW)						Outdoor unit power consumption(kW)	Current (A)	Power factor(%)
	Unit A	Unit B	Unit C	Unit D	Unit E	Total			
20+22+25+35	1.41	1.55	1.76	2.47	-	7.20 (3.70-8.60)	2.234 (0.830-3.240)	9.81	99
20+22+25+42	1.32	1.45	1.65	2.77	-	7.20 (3.70-8.60)	2.214 (0.830-3.230)	9.72	99
20+22+25+50	1.23	1.35	1.54	3.08	-	7.20 (3.70-8.60)	2.204 (0.830-3.220)	9.68	99
20+22+35+35	1.29	1.41	2.25	2.25	-	7.20 (3.70-8.60)	2.234 (0.830-3.240)	9.81	99
20+22+35+42	1.21	1.33	2.12	2.54	-	7.20 (3.70-8.60)	2.214 (0.830-3.230)	9.72	99
20+25+25+25	1.52	1.89	1.89	1.89	-	7.20 (3.70-8.60)	2.234 (0.830-3.240)	9.81	99
20+25+25+35	1.37	1.71	1.71	2.40	-	7.20 (3.70-8.60)	2.234 (0.830-3.240)	9.81	99
20+25+25+42	1.29	1.61	1.61	2.70	-	7.20 (3.70-8.60)	2.214 (0.830-3.230)	9.72	99
20+25+25+50	1.20	1.50	1.50	3.00	-	7.20 (3.70-8.60)	2.204 (0.830-3.220)	9.68	99
20+25+35+35	1.25	1.57	2.19	2.19	-	7.20 (3.70-8.60)	2.234 (0.830-3.240)	9.81	99
20+25+35+42	1.18	1.48	2.07	2.48	-	7.20 (3.70-8.60)	2.214 (0.830-3.230)	9.72	99
20+35+35+35	1.15	2.02	2.02	2.02	-	7.20 (3.70-8.60)	2.234 (0.830-3.240)	9.81	99
22+22+22+22	1.80	1.80	1.80	1.80	-	7.20 (3.70-8.80)	2.194 (0.800-3.190)	9.64	99
22+22+22+25	1.74	1.74	1.74	1.98	-	7.20 (3.70-8.80)	2.194 (0.800-3.190)	9.64	99
22+22+22+35	1.57	1.57	1.57	2.50	-	7.20 (3.70-8.80)	2.194 (0.800-3.190)	9.64	99
22+22+22+42	1.47	1.47	1.47	2.80	-	7.20 (3.70-8.80)	2.174 (0.800-3.180)	9.55	99
22+22+22+50	1.37	1.37	1.37	3.10	-	7.20 (3.70-8.80)	2.164 (0.800-3.170)	9.50	99
22+22+25+25	1.69	1.69	1.91	1.91	-	7.20 (3.70-8.80)	2.194 (0.800-3.190)	9.64	99
22+22+25+35	1.52	1.52	1.73	2.42	-	7.20 (3.70-8.80)	2.194 (0.800-3.190)	9.64	99
22+22+25+42	1.43	1.43	1.62	2.72	-	7.20 (3.70-8.80)	2.174 (0.800-3.180)	9.55	99
22+22+25+50	1.33	1.33	1.51	3.03	-	7.20 (3.70-8.80)	2.164 (0.800-3.170)	9.50	99
22+22+35+35	1.39	1.39	2.21	2.21	-	7.20 (3.70-8.80)	2.194 (0.800-3.190)	9.64	99
22+22+35+42	1.31	1.31	2.08	2.50	-	7.20 (3.70-8.80)	2.174 (0.800-3.180)	9.55	99
22+25+25+25	1.63	1.86	1.86	1.86	-	7.20 (3.70-8.80)	2.194 (0.800-3.190)	9.64	99
22+25+25+35	1.48	1.68	1.68	2.36	-	7.20 (3.70-8.80)	2.194 (0.800-3.190)	9.64	99
22+25+25+42	1.39	1.58	1.58	2.65	-	7.20 (3.70-8.80)	2.174 (0.800-3.180)	9.55	99
22+25+25+50	1.30	1.48	1.48	2.95	-	7.20 (3.70-8.80)	2.164 (0.800-3.170)	9.50	99
22+25+35+35	1.35	1.54	2.15	2.15	-	7.20 (3.70-8.80)	2.194 (0.800-3.190)	9.64	99
22+25+35+42	1.28	1.45	2.03	2.44	-	7.20 (3.70-8.80)	2.174 (0.800-3.180)	9.55	99
25+25+25+25	1.80	1.80	1.80	1.80	-	7.20 (3.70-8.80)	2.194 (0.800-3.190)	9.64	99
25+25+25+35	1.64	1.64	1.64	2.29	-	7.20 (3.70-8.80)	2.194 (0.800-3.190)	9.64	99
25+25+25+42	1.54	1.54	1.54	2.58	-	7.20 (3.70-8.80)	2.174 (0.800-3.180)	9.55	99
25+25+25+50	1.44	1.44	1.44	2.88	-	7.20 (3.70-8.80)	2.164 (0.800-3.170)	9.50	99
25+25+35+35	1.50	1.50	2.10	2.10	-	7.20 (3.70-8.80)	2.194 (0.800-3.190)	9.64	99

MXZ-4D72VA HEATING

Indoor units combination	Heating capacity (kW)					Outdoor unit power consumption(kW)	Current (A)	Power factor(%)	
	Unit A	Unit B	Unit C	Unit D	Unit E				Total
15	1.70	-	-	-	-	1.70 (1.20-3.00)	0.500 (0.400-0.950)	2.20	99
18	3.30	-	-	-	-	3.30 (1.20-4.20)	0.760 (0.380-1.090)	3.34	99
20	2.20	-	-	-	-	2.20 (1.20-3.90)	0.610 (0.390-1.330)	2.68	99
22	3.30	-	-	-	-	3.30 (1.20-4.20)	0.760 (0.380-1.090)	3.34	99
25	3.60	-	-	-	-	3.60 (1.20-4.50)	0.860 (0.380-1.190)	3.78	99
35	4.00	-	-	-	-	4.00 (1.20-4.80)	1.000 (0.380-1.300)	4.39	99
42	5.40	-	-	-	-	5.40 (1.30-6.50)	1.460 (0.370-1.800)	6.41	99
50	7.20	-	-	-	-	7.20 (1.40-8.20)	1.880 (0.370-2.300)	8.26	99
60	7.90	-	-	-	-	7.90 (1.40-8.60)	2.120 (0.360-2.410)	9.31	99
15+15	1.70	1.70	-	-	-	3.40 (1.80-5.00)	0.796 (0.670-1.300)	3.50	99
15+18	1.70	3.30	-	-	-	5.00 (1.80-6.10)	1.146 (0.540-1.530)	5.03	99
15+20	1.70	2.20	-	-	-	3.90 (1.80-5.80)	0.966 (0.650-1.625)	4.24	99
15+22	1.70	3.30	-	-	-	5.00 (1.80-6.10)	1.146 (0.540-1.530)	5.03	99
15+25	1.60	3.40	-	-	-	5.00 (1.80-6.10)	1.146 (0.540-1.530)	5.03	99
15+35	1.67	3.93	-	-	-	5.60 (1.80-7.90)	1.320 (0.540-2.190)	5.80	99
15+42	1.46	4.64	-	-	-	6.10 (1.80-7.90)	1.446 (0.540-2.190)	6.35	99
15+50	1.28	5.42	-	-	-	6.70 (1.80-7.90)	1.575 (0.540-2.180)	6.92	99
15+60	1.24	5.76	-	-	-	7.00 (1.80-7.90)	1.671 (0.540-2.150)	7.34	99
18+18	3.30	3.30	-	-	-	6.60 (1.80-7.20)	1.496 (0.410-1.760)	6.57	99
18+20	3.30	2.20	-	-	-	5.50 (1.80-6.90)	1.316 (0.520-1.855)	5.78	99
18+22	3.30	3.30	-	-	-	6.60 (1.80-7.20)	1.496 (0.410-1.760)	6.57	99
18+25	3.16	3.44	-	-	-	6.60 (1.80-7.20)	1.496 (0.410-1.760)	6.57	99
18+35	3.30	4.00	-	-	-	7.30 (1.80-9.00)	1.724 (0.410-2.420)	7.57	99
18+42	3.00	4.90	-	-	-	7.90 (1.80-9.00)	1.850 (0.410-2.420)	8.12	99
18+50	2.67	5.83	-	-	-	8.50 (1.80-9.00)	1.976 (0.410-2.410)	8.68	99
18+60	2.53	6.07	-	-	-	8.60 (1.80-9.00)	2.034 (0.400-2.365)	8.93	99
20+20	2.20	2.20	-	-	-	4.40 (1.80-6.60)	1.136 (0.630-1.950)	4.99	99
20+22	2.20	3.30	-	-	-	5.50 (1.80-6.90)	1.316 (0.520-1.855)	5.78	99
20+25	2.12	3.48	-	-	-	5.60 (1.80-7.20)	1.347 (0.520-1.965)	5.92	99
20+35	2.20	4.00	-	-	-	6.20 (1.80-8.70)	1.580 (0.520-2.515)	6.94	99
20+42	2.00	4.90	-	-	-	6.90 (1.80-8.70)	1.704 (0.520-2.515)	7.48	99
20+50	1.76	5.74	-	-	-	7.50 (1.80-8.70)	1.830 (0.520-2.505)	8.04	99
20+60	1.63	5.87	-	-	-	7.50 (1.80-8.70)	1.863 (0.510-2.450)	8.18	99
22+22	3.30	3.30	-	-	-	6.60 (1.80-7.20)	1.496 (0.410-1.760)	6.57	99
22+25	3.30	3.60	-	-	-	6.90 (1.80-8.10)	1.588 (0.410-2.095)	6.97	99
22+35	3.30	4.00	-	-	-	7.30 (1.80-9.00)	1.796 (0.410-2.420)	7.89	99
22+42	3.11	5.09	-	-	-	8.20 (1.80-9.00)	1.918 (0.410-2.420)	8.42	99
22+60	2.53	6.07	-	-	-	8.60 (1.80-9.00)	2.051 (0.400-2.350)	9.01	99
25+25	3.60	3.60	-	-	-	7.20 (1.80-9.00)	1.680 (0.410-2.430)	7.38	99
25+35	3.60	4.00	-	-	-	7.60 (1.80-9.00)	1.850 (0.410-2.420)	8.12	99
25+42	3.36	5.04	-	-	-	8.40 (1.80-9.00)	1.969 (0.410-2.420)	8.65	99

MXZ-4D72VA HEATING

Indoor units combination	Heating capacity (kW)						Outdoor unit power consumption(kW)	Current (A)	Power factor(%)
	Unit A	Unit B	Unit C	Unit D	Unit E	Total			
25+50	2.87	5.73	-	-	-	8.60 (1.80-9.00)	2.031 (0.410-2.390)	8.92	99
25+60	2.69	5.91	-	-	-	8.60 (1.80-9.00)	2.043 (0.400-2.335)	8.97	99
35+35	4.00	4.00	-	-	-	8.00 (1.80-9.00)	2.010 (0.410-2.410)	8.83	99
35+42	3.66	4.94	-	-	-	8.60 (1.80-9.00)	2.040 (0.410-2.380)	8.96	99
35+50	3.07	5.53	-	-	-	8.60 (1.80-9.00)	2.043 (0.400-2.335)	8.97	99
35+60	2.89	5.71	-	-	-	8.60 (1.90-9.00)	1.864 (0.370-2.275)	8.19	99
42+42	4.30	4.30	-	-	-	8.60 (1.80-9.00)	2.070 (0.400-2.350)	9.09	99
42+50	3.69	4.91	-	-	-	8.60 (1.90-9.00)	1.925 (0.380-2.300)	8.45	99
42+60	3.49	5.11	-	-	-	8.60 (1.90-9.00)	1.778 (0.360-2.235)	7.81	99
50+50	4.30	4.30	-	-	-	8.60 (1.90-9.00)	1.780 (0.360-2.250)	7.82	99
50+60	4.10	4.50	-	-	-	8.60 (1.90-9.00)	1.760 (0.360-2.160)	7.73	99
60+60	4.30	4.30	-	-	-	8.60 (1.90-9.00)	1.740 (0.360-2.070)	7.64	99
15+15+15	1.70	1.70	1.70	-	-	5.10 (2.60-8.50)	1.129 (0.890-2.425)	4.96	99
15+15+18	1.62	1.62	3.15	-	-	6.40 (2.60-9.20)	1.519 (0.770-2.775)	6.67	99
15+15+20	1.70	1.70	2.20	-	-	5.60 (2.60-9.00)	1.269 (0.910-2.645)	5.57	99
15+15+22	1.62	1.62	3.15	-	-	6.40 (2.60-9.20)	1.519 (0.780-2.775)	6.67	99
15+15+25	1.55	1.55	3.29	-	-	6.40 (2.60-9.20)	1.519 (0.790-2.775)	6.67	99
15+15+35	1.47	1.47	3.46	-	-	6.40 (2.60-9.20)	1.509 (0.790-2.765)	6.63	99
15+15+50	1.03	1.03	4.35	-	-	6.40 (2.60-9.20)	1.499 (0.790-2.755)	6.58	99
15+15+60	0.96	0.96	4.47	-	-	6.40 (2.60-9.20)	1.489 (0.790-2.745)	6.54	99
15+18+18	1.54	2.98	2.98	-	-	7.50 (2.60-9.90)	1.909 (0.650-3.125)	8.38	99
15+18+20	1.63	3.16	2.11	-	-	6.90 (2.60-9.70)	1.659 (0.790-2.995)	7.29	99
15+18+22	1.54	2.98	2.98	-	-	7.50 (2.60-9.90)	1.909 (0.660-3.125)	8.38	99
15+18+25	1.48	2.88	3.14	-	-	7.50 (2.60-9.90)	1.909 (0.640-3.125)	8.38	99
15+18+35	1.42	2.75	3.33	-	-	7.50 (2.60-9.90)	1.899 (0.660-3.115)	8.34	99
15+18+42	1.23	2.38	3.89	-	-	7.50 (2.60-9.90)	1.899 (0.660-3.115)	8.34	99
15+18+50	1.05	2.03	4.43	-	-	7.50 (2.60-9.90)	1.889 (0.660-3.105)	8.30	99
15+18+60	0.99	1.92	4.59	-	-	7.50 (2.60-9.90)	1.879 (0.660-3.095)	8.25	99
15+20+20	1.70	2.20	2.20	-	-	6.10 (2.60-9.50)	1.409 (0.920-2.865)	6.19	99
15+20+22	1.63	2.11	3.16	-	-	6.90 (2.60-9.70)	1.659 (0.780-2.995)	7.29	99
15+20+25	1.56	2.02	3.31	-	-	6.90 (2.60-9.70)	1.659 (0.760-2.995)	7.29	99
15+20+35	1.48	1.92	3.49	-	-	6.90 (2.60-9.70)	1.649 (0.790-2.985)	7.24	99
15+20+42	1.26	1.63	4.01	-	-	6.90 (2.60-9.70)	1.649 (0.790-2.985)	7.24	99
15+20+50	1.06	1.37	4.48	-	-	6.90 (2.60-9.70)	1.639 (0.790-2.975)	7.20	99
15+20+60	0.99	1.29	4.62	-	-	6.90 (2.60-9.70)	1.629 (0.790-2.965)	7.15	99
15+22+22	1.54	2.98	2.98	-	-	7.50 (2.60-9.90)	1.909 (0.640-3.125)	8.38	99
15+22+25	1.48	2.88	3.14	-	-	7.50 (2.60-9.90)	1.909 (0.640-3.125)	8.38	99
15+22+42	1.23	2.38	3.89	-	-	7.50 (2.60-9.90)	1.899 (0.660-3.115)	8.34	99
15+22+50	1.05	2.03	4.43	-	-	7.50 (2.60-9.90)	1.889 (0.660-3.105)	8.30	99
15+22+60	0.99	1.92	4.59	-	-	7.50 (2.60-9.90)	1.879 (0.660-3.095)	8.25	99
15+25+25	1.43	3.03	3.03	-	-	7.50 (2.60-9.90)	1.909 (0.660-3.125)	8.38	99

MXZ-4D72VA HEATING

Indoor units combination	Heating capacity (kW)						Outdoor unit power consumption(kW)	Current (A)	Power factor(%)
	Unit A	Unit B	Unit C	Unit D	Unit E	Total			
15+25+35	1.37	2.90	3.23	-	-	7.50 (2.60-9.90)	1.899 (0.660-3.115)	8.34	99
15+25+42	1.19	2.52	3.79	-	-	7.50 (2.60-9.90)	1.899 (0.660-3.115)	8.34	99
15+25+50	1.02	2.16	4.32	-	-	7.50 (2.60-9.90)	1.889 (0.660-3.105)	8.30	99
15+25+60	0.97	2.05	4.49	-	-	7.50 (2.60-9.90)	1.879 (0.660-3.095)	8.25	99
15+35+35	1.31	3.09	3.09	-	-	7.50 (2.60-9.90)	1.889 (0.660-3.105)	8.30	99
15+35+42	1.15	2.70	3.65	-	-	7.50 (2.60-9.90)	1.889 (0.660-3.105)	8.30	99
15+35+50	0.99	2.33	4.19	-	-	7.50 (2.60-9.90)	1.879 (0.660-3.095)	8.25	99
15+35+60	0.94	2.21	4.36	-	-	7.50 (2.60-9.90)	1.869 (0.660-3.085)	8.21	99
15+42+42	1.02	3.24	3.24	-	-	7.50 (2.60-9.90)	1.889 (0.660-3.105)	8.30	99
15+42+50	0.89	2.83	3.78	-	-	7.50 (2.60-9.90)	1.879 (0.660-3.095)	8.25	99
15+42+60	0.85	2.70	3.95	-	-	7.50 (2.60-9.90)	1.869 (0.650-3.085)	8.21	99
15+50+50	0.79	3.35	3.35	-	-	7.50 (2.60-9.90)	1.869 (0.650-3.085)	8.21	99
15+50+60	0.76	3.21	3.53	-	-	7.50 (2.60-9.90)	1.859 (0.640-3.075)	8.16	99
18+18+18	2.87	2.87	2.87	-	-	8.60 (2.60-10.60)	2.299 (0.530-3.475)	10.10	99
18+18+20	3.00	3.00	2.00	-	-	8.00 (2.60-10.40)	2.049 (0.650-3.345)	9.00	99
18+18+22	2.87	2.87	2.87	-	-	8.60 (2.60-10.60)	2.299 (0.510-3.475)	10.10	99
18+18+25	2.78	2.78	3.04	-	-	8.60 (2.60-10.60)	2.299 (0.510-3.475)	10.10	99
18+18+35	2.68	2.68	3.25	-	-	8.60 (2.60-10.60)	2.289 (0.530-3.465)	10.05	99
18+18+42	2.37	2.37	3.87	-	-	8.60 (2.60-10.60)	2.289 (0.530-3.465)	10.05	99
18+18+50	2.06	2.06	4.49	-	-	8.60 (2.60-10.60)	2.279 (0.530-3.455)	10.01	99
18+18+60	1.96	1.96	4.69	-	-	8.60 (2.60-10.60)	2.269 (0.530-3.445)	9.96	99
18+20+20	3.17	2.11	2.11	-	-	7.40 (2.60-10.20)	1.799 (0.770-3.215)	7.90	99
18+20+22	3.00	2.00	3.00	-	-	8.00 (2.60-10.40)	2.049 (0.630-3.345)	9.00	99
18+20+25	2.90	1.93	3.16	-	-	8.00 (2.60-10.40)	2.049 (0.650-3.345)	9.00	99
18+20+35	2.78	1.85	3.37	-	-	8.00 (2.60-10.40)	2.039 (0.660-3.335)	8.95	99
18+20+42	2.42	1.61	3.96	-	-	8.00 (2.60-10.40)	2.039 (0.660-3.335)	8.95	99
18+20+50	2.08	1.39	4.54	-	-	8.00 (2.60-10.40)	2.029 (0.660-3.325)	8.91	99
18+20+60	1.97	1.31	4.72	-	-	8.00 (2.60-10.40)	2.019 (0.660-3.315)	8.87	99
18+22+22	2.87	2.87	2.87	-	-	8.60 (2.60-10.60)	2.299 (0.510-3.475)	10.10	99
18+22+25	2.78	2.78	3.04	-	-	8.60 (2.60-10.60)	2.299 (0.530-3.475)	10.10	99
18+22+35	2.68	2.68	3.25	-	-	8.60 (2.60-10.60)	2.289 (0.530-3.465)	10.05	99
18+22+42	2.37	2.37	3.87	-	-	8.60 (2.60-10.60)	2.289 (0.530-3.465)	10.05	99
18+22+50	2.06	2.06	4.49	-	-	8.60 (2.60-10.60)	2.279 (0.530-3.455)	10.01	99
18+22+60	1.96	1.96	4.69	-	-	8.60 (2.60-10.60)	2.269 (0.530-3.445)	9.96	99
18+25+25	2.70	2.95	2.95	-	-	8.60 (2.60-10.60)	2.299 (0.530-3.475)	10.10	99
18+25+35	2.60	2.84	3.16	-	-	8.60 (2.60-10.60)	2.289 (0.530-3.465)	10.05	99
18+25+42	2.31	2.52	3.78	-	-	8.60 (2.60-10.60)	2.289 (0.530-3.465)	10.05	99
18+25+50	2.01	2.20	4.39	-	-	8.60 (2.60-10.60)	2.279 (0.530-3.455)	10.01	99
18+25+60	1.92	2.09	4.59	-	-	8.60 (2.60-10.60)	2.269 (0.530-3.445)	9.96	99
18+35+35	2.51	3.04	3.04	-	-	8.60 (2.60-10.60)	2.279 (0.530-3.455)	10.01	99
18+35+42	2.23	2.71	3.66	-	-	8.60 (2.60-10.60)	2.279 (0.530-3.455)	10.01	99

MXZ-4D72VA HEATING

Indoor units combination	Heating capacity (kW)						Outdoor unit power consumption(kW)	Current (A)	Power factor(%)
	Unit A	Unit B	Unit C	Unit D	Unit E	Total			
18+35+50	1.96	2.37	4.27	-	-	8.60 (2.60-10.60)	2.269 (0.530-3.445)	9.96	99
18+35+60	1.87	2.26	4.47	-	-	8.60 (2.60-10.60)	2.259 (0.520-3.435)	9.92	99
18+42+42	2.01	3.29	3.29	-	-	8.60 (2.60-10.60)	2.279 (0.530-3.455)	10.01	99
18+42+50	1.78	2.92	3.89	-	-	8.60 (2.60-10.60)	2.269 (0.530-3.445)	9.96	99
18+42+60	1.71	2.80	4.09	-	-	8.60 (2.60-10.60)	2.259 (0.520-3.435)	9.92	99
18+50+50	1.60	3.50	3.50	-	-	8.60 (2.60-10.60)	2.259 (0.520-3.435)	9.92	99
20+20+20	2.20	2.20	2.20	-	-	6.60 (2.60-10.00)	1.549 (0.890-3.085)	6.80	99
20+20+22	2.11	2.11	3.17	-	-	7.40 (2.60-10.20)	1.799 (0.770-3.215)	7.90	99
20+20+25	2.04	2.04	3.33	-	-	7.40 (2.60-10.20)	1.799 (0.790-3.215)	7.90	99
20+20+35	1.94	1.94	3.52	-	-	7.40 (2.60-10.20)	1.789 (0.790-3.205)	7.86	99
20+20+42	1.66	1.66	4.08	-	-	7.40 (2.60-10.20)	1.789 (0.790-3.205)	7.86	99
20+20+50	1.40	1.40	4.59	-	-	7.40 (2.60-10.20)	1.779 (0.790-3.195)	7.81	99
20+20+60	1.32	1.32	4.75	-	-	7.40 (2.60-10.20)	1.769 (0.790-3.185)	7.77	99
20+22+22	2.00	3.00	3.00	-	-	8.00 (2.60-10.40)	2.049 (0.650-3.345)	9.00	99
20+22+25	1.93	2.90	3.16	-	-	8.00 (2.60-10.40)	2.049 (0.660-3.345)	9.00	99
20+22+35	1.85	2.78	3.37	-	-	8.00 (2.60-10.40)	2.039 (0.660-3.335)	8.95	99
20+22+42	1.61	2.42	3.96	-	-	8.00 (2.60-10.40)	2.039 (0.660-3.335)	8.95	99
20+22+50	1.39	2.08	4.54	-	-	8.00 (2.60-10.40)	2.029 (0.660-3.325)	8.91	99
20+22+60	1.31	1.97	4.72	-	-	8.00 (2.60-10.40)	2.019 (0.660-3.315)	8.87	99
20+25+25	1.87	3.06	3.06	-	-	8.00 (2.60-10.40)	2.049 (0.660-3.345)	9.00	99
20+25+35	1.80	2.94	3.27	-	-	8.00 (2.60-10.40)	2.039 (0.660-3.335)	8.95	99
20+25+42	1.57	2.57	3.86	-	-	8.00 (2.60-10.40)	2.039 (0.660-3.335)	8.95	99
20+25+50	1.35	2.22	4.43	-	-	8.00 (2.60-10.40)	2.029 (0.660-3.325)	8.91	99
20+25+60	1.28	2.10	4.61	-	-	8.00 (2.60-10.40)	2.019 (0.660-3.315)	8.87	99
20+35+35	1.73	3.14	3.14	-	-	8.00 (2.60-10.40)	2.029 (0.660-3.325)	8.91	99
20+35+42	1.52	2.76	3.72	-	-	8.00 (2.60-10.40)	2.029 (0.660-3.325)	8.91	99
20+35+50	1.31	2.39	4.30	-	-	8.00 (2.60-10.40)	2.019 (0.660-3.315)	8.87	99
20+35+60	1.25	2.27	4.48	-	-	8.00 (2.60-10.40)	2.009 (0.650-3.305)	8.82	99
20+42+42	1.35	3.32	3.32	-	-	8.00 (2.60-10.40)	2.029 (0.660-3.325)	8.91	99
20+42+50	1.19	2.92	3.89	-	-	8.00 (2.60-10.40)	2.019 (0.650-3.315)	8.87	99
20+42+60	1.14	2.79	4.08	-	-	8.00 (2.60-10.40)	2.009 (0.640-3.305)	8.82	99
20+50+50	1.06	3.47	3.47	-	-	8.00 (2.60-10.40)	2.009 (0.650-3.305)	8.82	99
22+22+22	2.87	2.87	2.87	-	-	8.60 (2.60-10.60)	2.299 (0.530-3.475)	10.10	99
22+22+25	2.78	2.78	3.04	-	-	8.60 (2.60-10.60)	2.299 (0.530-3.475)	10.10	99
22+22+35	2.68	2.68	3.25	-	-	8.60 (2.60-10.60)	2.289 (0.530-3.465)	10.05	99
22+22+42	2.37	2.37	3.87	-	-	8.60 (2.60-10.60)	2.289 (0.530-3.465)	10.05	99
22+22+50	2.06	2.06	4.49	-	-	8.60 (2.60-10.60)	2.279 (0.530-3.455)	10.01	99
22+22+60	1.96	1.96	4.69	-	-	8.60 (2.60-10.60)	2.269 (0.530-3.445)	9.96	99
22+25+35	2.60	2.84	3.16	-	-	8.60 (2.60-10.60)	2.289 (0.530-3.465)	10.05	99
22+25+42	2.31	2.52	3.78	-	-	8.60 (2.60-10.60)	2.289 (0.530-3.465)	10.05	99
22+25+50	2.01	2.20	4.39	-	-	8.60 (2.60-10.60)	2.279 (0.530-3.455)	10.01	99

MXZ-4D72VA HEATING

Indoor units combination	Heating capacity (kW)						Outdoor unit power consumption(kW)	Current (A)	Power factor(%)
	Unit A	Unit B	Unit C	Unit D	Unit E	Total			
22+25+60	1.92	2.09	4.59	-	-	8.60 (2.60-10.60)	2.269 (0.530-3.445)	9.96	99
22+35+35	2.51	3.04	3.04	-	-	8.60 (2.60-10.60)	2.279 (0.530-3.455)	10.01	99
22+35+42	2.23	2.71	3.66	-	-	8.60 (2.60-10.60)	2.279 (0.530-3.455)	10.01	99
22+35+50	1.96	2.37	4.27	-	-	8.60 (2.60-10.60)	2.269 (0.530-3.445)	9.96	99
22+35+60	1.87	2.26	4.47	-	-	8.60 (2.60-10.60)	2.259 (0.520-3.435)	9.92	99
22+42+42	2.01	3.29	3.29	-	-	8.60 (2.60-10.60)	2.279 (0.530-3.455)	10.01	99
22+42+50	1.78	2.92	3.89	-	-	8.60 (2.60-10.60)	2.269 (0.520-3.445)	9.96	99
22+42+60	1.71	2.80	4.09	-	-	8.60 (2.60-10.60)	2.259 (0.510-3.435)	9.92	99
22+50+50	1.60	3.50	3.50	-	-	8.60 (2.60-10.60)	2.259 (0.510-3.435)	9.92	99
25+25+25	2.87	2.87	2.87	-	-	8.60 (2.60-10.60)	2.299 (0.530-3.475)	10.10	99
25+25+35	2.76	2.76	3.07	-	-	8.60 (2.60-10.60)	2.289 (0.530-3.465)	10.05	99
25+25+42	2.46	2.46	3.69	-	-	8.60 (2.60-10.60)	2.289 (0.530-3.465)	10.05	99
25+25+50	2.15	2.15	4.30	-	-	8.60 (2.60-10.60)	2.279 (0.530-3.455)	10.01	99
25+25+60	2.05	2.05	4.50	-	-	8.60 (2.60-10.60)	2.269 (0.530-3.445)	9.96	99
25+35+35	2.67	2.97	2.97	-	-	8.60 (2.60-10.60)	2.279 (0.530-3.455)	10.01	99
25+35+42	2.38	2.65	3.57	-	-	8.60 (2.60-10.60)	2.279 (0.530-3.455)	10.01	99
25+35+50	2.09	2.32	4.18	-	-	8.60 (2.60-10.60)	2.269 (0.530-3.445)	9.96	99
25+35+60	2.00	2.22	4.38	-	-	8.60 (2.60-10.60)	2.259 (0.520-3.435)	9.92	99
25+42+42	2.15	3.23	3.23	-	-	8.60 (2.60-10.60)	2.279 (0.530-3.455)	10.01	99
25+42+50	1.91	2.87	3.82	-	-	8.60 (2.60-10.60)	2.269 (0.520-3.445)	9.96	99
25+50+50	1.72	3.44	3.44	-	-	8.60 (2.60-10.60)	2.259 (0.510-3.435)	9.92	99
35+35+35	2.87	2.87	2.87	-	-	8.60 (2.60-10.60)	2.269 (0.530-3.445)	9.96	99
35+35+42	2.57	2.57	3.47	-	-	8.60 (2.60-10.60)	2.269 (0.520-3.445)	9.96	99
35+35+50	2.26	2.26	4.07	-	-	8.60 (2.60-10.60)	2.259 (0.520-3.435)	9.92	99
35+42+42	2.32	3.14	3.14	-	-	8.60 (2.60-10.60)	2.269 (0.520-3.445)	9.96	99
15+15+15+15	1.70	1.70	1.70	1.70	-	6.80 (3.40-9.50)	1.492 (0.880-2.470)	6.55	99
15+15+15+18	1.50	1.50	1.50	2.91	-	7.40 (3.40-9.80)	1.662 (0.810-2.550)	7.30	99
15+15+15+20	1.70	1.70	1.70	2.20	-	7.30 (3.40-9.80)	1.762 (0.880-2.695)	7.74	99
15+15+15+22	1.50	1.50	1.50	2.91	-	7.40 (3.40-9.80)	1.662 (0.810-2.550)	7.30	99
15+15+15+25	1.45	1.45	1.45	3.06	-	7.40 (3.40-9.80)	1.662 (0.810-2.550)	7.30	99
15+15+15+35	1.38	1.38	1.38	3.25	-	7.40 (3.40-9.80)	1.652 (0.810-2.540)	7.26	99
15+15+15+42	1.20	1.20	1.20	3.81	-	7.40 (3.40-9.80)	1.652 (0.810-2.700)	7.26	99
15+15+15+50	1.02	1.02	1.02	4.33	-	7.40 (3.40-9.80)	1.642 (0.810-2.710)	7.21	99
15+15+15+60	0.97	0.97	0.97	4.50	-	7.40 (3.40-9.80)	1.632 (0.810-2.700)	7.17	99
15+15+18+18	1.33	1.33	2.57	2.57	-	7.80 (3.40-10.10)	1.832 (0.740-2.630)	8.05	99
15+15+18+20	1.49	1.49	2.89	1.93	-	7.80 (3.40-10.10)	1.932 (0.810-2.775)	8.48	99
15+15+18+22	1.33	1.33	2.57	2.57	-	7.80 (3.40-10.10)	1.832 (0.740-2.630)	8.05	99
15+15+18+25	1.29	1.29	2.50	2.73	-	7.80 (3.40-10.10)	1.832 (0.740-2.630)	8.05	99
15+15+18+35	1.24	1.24	2.41	2.92	-	7.80 (3.40-10.10)	1.822 (0.740-2.690)	8.00	99
15+15+18+42	1.10	1.10	2.13	3.48	-	7.80 (3.40-10.10)	1.822 (0.740-2.800)	8.00	99
15+15+18+50	0.95	0.95	1.85	4.04	-	7.80 (3.40-10.10)	1.812 (0.740-2.790)	7.96	99

MXZ-4D72VA HEATING

Indoor units combination	Heating capacity (kW)						Outdoor unit power consumption(kW)	Current (A)	Power factor(%)
	Unit A	Unit B	Unit C	Unit D	Unit E	Total			
15+15+18+60	0.91	0.91	1.76	4.22	-	7.80 (3.40-10.10)	1.802 (0.740-2.780)	7.91	99
15+15+20+20	1.70	1.70	2.20	2.20	-	7.80 (3.40-10.10)	2.032 (0.880-2.920)	8.92	99
15+15+20+25	1.44	1.44	1.87	3.05	-	7.80 (3.40-10.10)	1.932 (0.810-2.775)	8.48	99
15+15+20+35	1.38	1.38	1.79	3.25	-	7.80 (3.40-10.10)	1.922 (0.810-2.880)	8.44	99
15+15+20+42	1.21	1.21	1.56	3.83	-	7.80 (3.40-10.10)	1.922 (0.810-2.945)	8.44	99
15+15+20+50	1.04	1.04	1.34	4.39	-	7.80 (3.40-10.10)	1.912 (0.810-2.935)	8.40	99
15+15+20+60	0.98	0.98	1.27	4.56	-	7.80 (3.40-10.10)	1.902 (0.810-2.925)	8.35	99
15+15+22+22	1.33	1.33	2.57	2.57	-	7.80 (3.40-10.10)	1.832 (0.740-2.630)	8.05	99
15+15+22+25	1.29	1.29	2.50	2.73	-	7.80 (3.40-10.10)	1.832 (0.740-2.630)	8.05	99
15+15+22+35	1.24	1.24	2.41	2.92	-	7.80 (3.40-10.10)	1.822 (0.740-2.780)	8.00	99
15+15+22+42	1.10	1.10	2.13	3.48	-	7.80 (3.40-10.10)	1.822 (0.740-2.800)	8.00	99
15+15+22+50	0.95	0.95	1.85	4.04	-	7.80 (3.40-10.10)	1.812 (0.740-2.790)	7.96	99
15+15+22+60	0.91	0.91	1.76	4.22	-	7.80 (3.40-10.10)	1.802 (0.740-2.780)	7.91	99
15+15+25+25	1.25	1.25	2.65	2.65	-	7.80 (3.40-10.10)	1.832 (0.740-2.630)	8.05	99
15+15+25+35	1.21	1.21	2.55	2.84	-	7.80 (3.40-10.10)	1.822 (0.740-2.800)	8.00	99
15+15+25+42	1.07	1.07	2.26	3.40	-	7.80 (3.40-10.10)	1.822 (0.740-2.800)	8.00	99
15+15+25+50	0.93	0.93	1.98	3.95	-	7.80 (3.40-10.10)	1.812 (0.740-2.790)	7.96	99
15+15+25+60	0.89	0.89	1.88	4.14	-	7.80 (3.40-10.10)	1.802 (0.740-2.780)	7.91	99
15+15+35+35	1.16	1.16	2.74	2.74	-	7.80 (3.40-10.10)	1.812 (0.740-2.790)	7.96	99
15+15+35+42	1.04	1.04	2.44	3.29	-	7.80 (3.40-10.10)	1.812 (0.740-2.790)	7.96	99
15+15+35+50	0.91	0.91	2.14	3.85	-	7.80 (3.40-10.10)	1.802 (0.740-2.780)	7.91	99
15+15+35+60	0.87	0.87	2.04	4.03	-	7.80 (3.40-10.10)	1.792 (0.740-2.770)	7.87	99
15+15+42+42	0.93	0.93	2.97	2.97	-	7.80 (3.40-10.10)	1.812 (0.740-2.790)	7.96	99
15+15+42+50	0.83	0.83	2.63	3.51	-	7.80 (3.40-10.10)	1.802 (0.740-2.780)	7.91	99
15+18+18+18	1.20	2.33	2.33	2.33	-	8.20 (3.40-10.40)	2.002 (0.670-2.710)	8.79	99
15+18+18+20	1.33	2.58	2.58	1.72	-	8.20 (3.40-10.40)	2.102 (0.740-2.855)	9.23	99
15+18+18+22	1.20	2.33	2.33	2.33	-	8.20 (3.40-10.40)	2.002 (0.670-2.710)	8.79	99
15+18+18+25	1.17	2.27	2.27	2.48	-	8.20 (3.40-10.40)	2.002 (0.670-2.710)	8.79	99
15+18+18+35	1.13	2.20	2.20	2.67	-	8.20 (3.40-10.40)	1.992 (0.670-2.835)	8.75	99
15+18+18+42	1.02	1.98	1.98	3.23	-	8.20 (3.40-10.40)	1.992 (0.670-2.880)	8.75	99
15+18+18+50	0.90	1.75	1.75	3.81	-	8.20 (3.40-10.40)	1.982 (0.670-2.870)	8.70	99
15+18+18+60	0.86	1.67	1.67	4.00	-	8.20 (3.40-10.40)	1.972 (0.670-2.860)	8.66	99
15+18+20+20	1.48	2.88	1.92	1.92	-	8.20 (3.40-10.40)	2.202 (0.810-3.000)	9.67	99
15+18+20+22	1.33	2.58	1.72	2.58	-	8.20 (3.40-10.40)	2.102 (0.740-2.855)	9.23	99
15+18+20+25	1.29	2.51	1.67	2.73	-	8.20 (3.40-10.40)	2.102 (0.740-2.855)	9.23	99
15+18+20+35	1.24	2.42	1.61	2.93	-	8.20 (3.40-10.40)	2.092 (0.740-3.025)	9.19	99
15+18+20+42	1.11	2.15	1.43	3.51	-	8.20 (3.40-10.40)	2.092 (0.740-3.025)	9.19	99
15+18+20+50	0.97	1.88	1.25	4.10	-	8.20 (3.40-10.40)	2.082 (0.740-3.015)	9.14	99
15+18+20+60	0.92	1.79	1.19	4.29	-	8.20 (3.40-10.40)	2.072 (0.740-3.005)	9.10	99
15+18+22+22	1.20	2.33	2.33	2.33	-	8.20 (3.40-10.40)	2.002 (0.670-2.710)	8.79	99
15+18+22+25	1.17	2.27	2.27	2.48	-	8.20 (3.40-10.40)	2.002 (0.670-2.710)	8.79	99

MXZ-4D72VA HEATING

Indoor units combination	Heating capacity (kW)						Outdoor unit power consumption(kW)	Current (A)	Power factor(%)
	Unit A	Unit B	Unit C	Unit D	Unit E	Total			
15+18+22+35	1.13	2.20	2.20	2.67	-	8.20 (3.40-10.40)	1.992 (0.670-2.880)	8.75	99
15+18+22+42	1.02	1.98	1.98	3.23	-	8.20 (3.40-10.40)	1.992 (0.670-2.880)	8.75	99
15+18+22+50	0.90	1.75	1.75	3.81	-	8.20 (3.40-10.40)	1.982 (0.670-2.870)	8.70	99
15+18+22+60	0.86	1.67	1.67	4.00	-	8.20 (3.40-10.40)	1.972 (0.670-2.860)	8.66	99
15+18+25+25	1.14	2.22	2.42	2.42	-	8.20 (3.40-10.40)	2.002 (0.670-2.780)	8.79	99
15+18+25+35	1.11	2.15	2.34	2.60	-	8.20 (3.40-10.40)	1.992 (0.670-2.880)	8.75	99
15+18+25+42	1.00	1.93	2.11	3.16	-	8.20 (3.40-10.40)	1.992 (0.670-2.880)	8.75	99
15+18+25+50	0.88	1.71	1.87	3.74	-	8.20 (3.40-10.40)	1.982 (0.670-2.870)	8.70	99
15+18+25+60	0.84	1.64	1.79	3.93	-	8.20 (3.40-10.40)	1.972 (0.670-2.860)	8.66	99
15+18+35+35	1.07	2.08	2.52	2.52	-	8.20 (3.40-10.40)	1.982 (0.670-2.870)	8.70	99
15+18+35+42	0.97	1.88	2.28	3.08	-	8.20 (3.40-10.40)	1.982 (0.670-2.870)	8.70	99
15+18+35+50	0.86	1.67	2.02	3.64	-	8.20 (3.40-10.40)	1.972 (0.670-2.860)	8.66	99
15+18+42+42	0.88	1.71	2.80	2.80	-	8.20 (3.40-10.40)	1.982 (0.670-2.870)	8.70	99
15+18+42+50	0.79	1.54	2.52	3.35	-	8.20 (3.40-10.40)	1.972 (0.670-2.860)	8.66	99
15+20+20+20	1.68	2.17	2.17	2.17	-	8.20 (3.40-10.40)	2.302 (0.880-3.145)	10.11	99
15+20+20+22	1.48	1.92	1.92	2.88	-	8.20 (3.40-10.40)	2.202 (0.810-3.000)	9.67	99
15+20+20+25	1.44	1.86	1.86	3.04	-	8.20 (3.40-10.40)	2.202 (0.810-3.000)	9.67	99
15+20+20+35	1.38	1.79	1.79	3.25	-	8.20 (3.40-10.40)	2.192 (0.810-3.170)	9.63	99
15+20+20+42	1.21	1.57	1.57	3.85	-	8.20 (3.40-10.40)	2.192 (0.810-3.170)	9.63	99
15+20+20+50	1.05	1.36	1.36	4.44	-	8.20 (3.40-10.40)	2.182 (0.810-3.160)	9.58	99
15+20+20+60	1.00	1.29	1.29	4.63	-	8.20 (3.40-10.40)	2.172 (0.810-3.150)	9.54	99
15+20+22+22	1.33	1.72	2.58	2.58	-	8.20 (3.40-10.40)	2.102 (0.740-2.855)	9.23	99
15+20+22+25	1.29	1.67	2.51	2.73	-	8.20 (3.40-10.40)	2.102 (0.740-2.900)	9.23	99
15+20+22+35	1.24	1.61	2.42	2.93	-	8.20 (3.40-10.40)	2.092 (0.740-3.025)	9.19	99
15+20+22+42	1.11	1.43	2.15	3.51	-	8.20 (3.40-10.40)	2.092 (0.740-3.025)	9.19	99
15+20+22+50	0.97	1.25	1.88	4.10	-	8.20 (3.40-10.40)	2.082 (0.740-3.015)	9.14	99
15+20+22+60	0.92	1.19	1.79	4.29	-	8.20 (3.40-10.40)	2.072 (0.740-3.005)	9.10	99
15+20+25+25	1.26	1.63	2.66	2.66	-	8.20 (3.40-10.40)	2.102 (0.740-2.970)	9.23	99
15+20+25+35	1.21	1.57	2.57	2.85	-	8.20 (3.40-10.40)	2.092 (0.740-3.025)	9.19	99
15+20+25+42	1.08	1.40	2.29	3.43	-	8.20 (3.40-10.40)	2.092 (0.740-3.025)	9.19	99
15+20+25+50	0.95	1.23	2.01	4.02	-	8.20 (3.40-10.40)	2.082 (0.740-3.015)	9.14	99
15+20+25+60	0.91	1.17	1.92	4.21	-	8.20 (3.40-10.40)	2.072 (0.740-3.005)	9.10	99
15+20+35+35	1.17	1.52	2.76	2.76	-	8.20 (3.40-10.40)	2.082 (0.740-3.015)	9.14	99
15+20+35+42	1.05	1.36	2.47	3.33	-	8.20 (3.40-10.40)	2.082 (0.740-3.015)	9.14	99
15+20+35+50	0.92	1.19	2.17	3.91	-	8.20 (3.40-10.40)	2.072 (0.740-3.005)	9.10	99
15+20+42+42	0.95	1.23	3.01	3.01	-	8.20 (3.40-10.40)	2.082 (0.740-3.015)	9.14	99
15+22+22+22	1.20	2.33	2.33	2.33	-	8.20 (3.40-10.40)	2.002 (0.670-2.735)	8.79	99
15+22+22+25	1.17	2.27	2.27	2.48	-	8.20 (3.40-10.40)	2.002 (0.670-2.800)	8.79	99
15+22+22+35	1.13	2.20	2.20	2.67	-	8.20 (3.40-10.40)	1.992 (0.670-2.880)	8.75	99
15+22+22+42	1.02	1.98	1.98	3.23	-	8.20 (3.40-10.40)	1.992 (0.670-2.880)	8.75	99
15+22+22+50	0.90	1.75	1.75	3.81	-	8.20 (3.40-10.40)	1.982 (0.670-2.870)	8.70	99

MXZ-4D72VA HEATING

Indoor units combination	Heating capacity (kW)						Outdoor unit power consumption(kW)	Current (A)	Power factor(%)
	Unit A	Unit B	Unit C	Unit D	Unit E	Total			
15+22+22+60	0.86	1.67	1.67	4.00	-	8.20 (3.40-10.40)	1.972 (0.670-2.860)	8.66	99
15+22+25+25	1.14	2.22	2.42	2.42	-	8.20 (3.40-10.40)	2.002 (0.670-2.870)	8.79	99
15+22+25+35	1.11	2.15	2.34	2.60	-	8.20 (3.40-10.40)	1.992 (0.670-2.880)	8.75	99
15+22+25+42	1.00	1.93	2.11	3.16	-	8.20 (3.40-10.40)	1.992 (0.670-2.880)	8.75	99
15+22+25+50	0.88	1.71	1.87	3.74	-	8.20 (3.40-10.40)	1.982 (0.670-2.870)	8.70	99
15+22+25+60	0.84	1.64	1.79	3.93	-	8.20 (3.40-10.40)	1.972 (0.670-2.860)	8.66	99
15+22+35+35	1.07	2.08	2.52	2.52	-	8.20 (3.40-10.40)	1.982 (0.670-2.870)	8.70	99
15+22+35+42	0.97	1.88	2.28	3.08	-	8.20 (3.40-10.40)	1.982 (0.670-2.870)	8.70	99
15+22+35+50	0.86	1.67	2.02	3.64	-	8.20 (3.40-10.40)	1.972 (0.670-2.860)	8.66	99
15+22+42+42	0.88	1.71	2.80	2.80	-	8.20 (3.40-10.40)	1.982 (0.670-2.870)	8.70	99
15+25+25+25	1.12	2.36	2.36	2.36	-	8.20 (3.40-10.40)	2.002 (0.670-2.890)	8.79	99
15+25+25+35	1.08	2.29	2.29	2.54	-	8.20 (3.40-10.40)	1.992 (0.670-2.880)	8.75	99
15+25+25+42	0.97	2.06	2.06	3.10	-	8.20 (3.40-10.40)	1.992 (0.670-2.880)	8.75	99
15+25+25+50	0.87	1.83	1.83	3.67	-	8.20 (3.40-10.40)	1.982 (0.670-2.870)	8.70	99
15+25+25+60	0.83	1.76	1.76	3.86	-	8.20 (3.40-10.40)	1.972 (0.670-2.860)	8.66	99
15+25+35+35	1.05	2.22	2.47	2.47	-	8.20 (3.40-10.40)	1.982 (0.670-2.870)	8.70	99
15+25+35+42	0.95	2.01	2.23	3.01	-	8.20 (3.40-10.40)	1.982 (0.670-2.870)	8.70	99
15+25+35+50	0.84	1.79	1.99	3.58	-	8.20 (3.40-10.40)	1.972 (0.670-2.860)	8.66	99
15+25+42+42	0.87	1.83	2.75	2.75	-	8.20 (3.40-10.40)	1.982 (0.670-2.870)	8.70	99
15+35+35+35	1.02	2.39	2.39	2.39	-	8.20 (3.40-10.40)	1.972 (0.670-2.860)	8.66	99
18+18+18+18	2.15	2.15	2.15	2.15	-	8.60 (3.40-10.70)	2.172 (0.600-2.790)	9.54	99
18+18+18+20	2.35	2.35	2.35	1.56	-	8.60 (3.40-10.70)	2.272 (0.670-2.935)	9.98	99
18+18+18+22	2.15	2.15	2.15	2.15	-	8.60 (3.40-10.70)	2.172 (0.600-2.790)	9.54	99
18+18+18+25	2.10	2.10	2.10	2.29	-	8.60 (3.40-10.70)	2.172 (0.600-2.790)	9.54	99
18+18+18+35	2.04	2.04	2.04	2.47	-	8.60 (3.40-10.70)	2.162 (0.600-2.960)	9.49	99
18+18+18+42	1.85	1.85	1.85	3.04	-	8.60 (3.40-10.70)	2.162 (0.600-2.960)	9.49	99
18+18+18+50	1.66	1.66	1.66	3.62	-	8.60 (3.40-10.70)	2.152 (0.600-2.950)	9.45	99
18+18+18+60	1.59	1.59	1.59	3.82	-	8.60 (3.40-10.70)	2.142 (0.600-2.940)	9.41	99
18+18+20+20	2.58	2.58	1.72	1.72	-	8.60 (3.40-10.70)	2.372 (0.740-3.080)	10.42	99
18+18+20+22	2.35	2.35	1.56	2.35	-	8.60 (3.40-10.70)	2.272 (0.670-2.935)	9.98	99
18+18+20+25	2.29	2.29	1.53	2.50	-	8.60 (3.40-10.70)	2.272 (0.670-2.960)	9.98	99
18+18+20+35	2.22	2.22	1.48	2.69	-	8.60 (3.40-10.70)	2.262 (0.670-3.105)	9.93	99
18+18+20+42	2.00	2.00	1.33	3.27	-	8.60 (3.40-10.70)	2.262 (0.670-3.105)	9.93	99
18+18+20+50	1.77	1.77	1.18	3.87	-	8.60 (3.40-10.70)	2.252 (0.670-3.095)	9.89	99
18+18+20+60	1.70	1.70	1.13	4.07	-	8.60 (3.40-10.70)	2.242 (0.670-3.085)	9.85	99
18+18+22+22	2.15	2.15	2.15	2.15	-	8.60 (3.40-10.70)	2.172 (0.600-2.790)	9.54	99
18+18+22+25	2.10	2.10	2.10	2.29	-	8.60 (3.40-10.70)	2.172 (0.600-2.860)	9.54	99
18+18+22+35	2.04	2.04	2.04	2.47	-	8.60 (3.40-10.70)	2.162 (0.600-2.960)	9.49	99
18+18+22+42	1.85	1.85	1.85	3.04	-	8.60 (3.40-10.70)	2.162 (0.600-2.960)	9.49	99
18+18+22+50	1.66	1.66	1.66	3.62	-	8.60 (3.40-10.70)	2.152 (0.600-2.950)	9.45	99
18+18+22+60	1.59	1.59	1.59	3.82	-	8.60 (3.40-10.70)	2.142 (0.600-2.940)	9.41	99

MXZ-4D72VA HEATING

Indoor units combination	Heating capacity (kW)						Outdoor unit power consumption(kW)	Current (A)	Power factor(%)
	Unit A	Unit B	Unit C	Unit D	Unit E	Total			
18+18+25+25	2.06	2.06	2.24	2.24	-	8.60 (3.40-10.70)	2.172 (0.600-2.925)	9.54	99
18+18+25+35	2.00	2.00	2.18	2.42	-	8.60 (3.40-10.70)	2.162 (0.600-2.960)	9.49	99
18+18+25+42	1.82	1.82	1.98	2.98	-	8.60 (3.40-10.70)	2.162 (0.600-2.960)	9.49	99
18+18+25+50	1.63	1.63	1.78	3.56	-	8.60 (3.40-10.70)	2.152 (0.600-2.950)	9.45	99
18+18+25+60	1.57	1.57	1.71	3.75	-	8.60 (3.40-10.70)	2.142 (0.600-2.940)	9.41	99
18+18+35+35	1.94	1.94	2.36	2.36	-	8.60 (3.40-10.70)	2.152 (0.600-2.950)	9.45	99
18+18+35+42	1.77	1.77	2.15	2.90	-	8.60 (3.40-10.70)	2.152 (0.600-2.950)	9.45	99
18+18+35+50	1.59	1.59	1.93	3.48	-	8.60 (3.40-10.70)	2.142 (0.600-2.940)	9.41	99
18+18+42+42	1.63	1.63	2.67	2.67	-	8.60 (3.40-10.70)	2.152 (0.600-2.950)	9.45	99
18+20+20+20	2.87	1.91	1.91	1.91	-	8.60 (3.40-10.70)	2.472 (0.810-3.225)	10.86	99
18+20+20+22	2.58	1.72	1.72	2.58	-	8.60 (3.40-10.70)	2.372 (0.740-3.080)	10.42	99
18+20+20+25	2.51	1.67	1.67	2.74	-	8.60 (3.40-10.70)	2.372 (0.740-3.150)	10.42	99
18+20+20+35	2.43	1.62	1.62	2.94	-	8.60 (3.40-10.70)	2.362 (0.740-3.250)	10.37	99
18+20+20+42	2.17	1.44	1.44	3.55	-	8.60 (3.40-10.70)	2.362 (0.740-3.250)	10.37	99
18+20+20+50	1.90	1.27	1.27	4.16	-	8.60 (3.40-10.70)	2.352 (0.740-3.240)	10.33	99
18+20+20+60	1.82	1.21	1.21	4.36	-	8.60 (3.40-10.70)	2.342 (0.740-3.230)	10.29	99
18+20+22+22	2.35	1.56	2.35	2.35	-	8.60 (3.40-10.70)	2.272 (0.670-2.980)	9.98	99
18+20+22+25	2.29	1.53	2.29	2.50	-	8.60 (3.40-10.70)	2.272 (0.670-3.050)	9.98	99
18+20+22+35	2.22	1.48	2.22	2.69	-	8.60 (3.40-10.70)	2.262 (0.670-3.105)	9.93	99
18+20+22+42	2.00	1.33	2.00	3.27	-	8.60 (3.40-10.70)	2.262 (0.670-3.105)	9.93	99
18+20+22+50	1.77	1.18	1.77	3.87	-	8.60 (3.40-10.70)	2.252 (0.670-3.095)	9.89	99
18+20+22+60	1.70	1.13	1.70	4.07	-	8.60 (3.40-10.70)	2.242 (0.670-3.085)	9.85	99
18+20+25+25	2.23	1.49	2.44	2.44	-	8.60 (3.40-10.70)	2.272 (0.670-3.115)	9.98	99
18+20+25+35	2.17	1.44	2.36	2.63	-	8.60 (3.40-10.70)	2.262 (0.670-3.105)	9.93	99
18+20+25+42	1.96	1.30	2.14	3.20	-	8.60 (3.40-10.70)	2.262 (0.670-3.105)	9.93	99
18+20+25+50	1.74	1.16	1.90	3.80	-	8.60 (3.40-10.70)	2.252 (0.670-3.095)	9.89	99
18+20+25+60	1.67	1.11	1.82	4.00	-	8.60 (3.40-10.70)	2.242 (0.670-3.085)	9.85	99
18+20+35+35	2.10	1.40	2.55	2.55	-	8.60 (3.40-10.70)	2.252 (0.670-3.095)	9.89	99
18+20+35+42	1.90	1.27	2.31	3.12	-	8.60 (3.40-10.70)	2.252 (0.670-3.095)	9.89	99
18+20+35+50	1.70	1.13	2.06	3.71	-	8.60 (3.40-10.70)	2.242 (0.670-3.085)	9.85	99
18+20+42+42	1.74	1.16	2.85	2.85	-	8.60 (3.40-10.70)	2.252 (0.670-3.095)	9.89	99
18+22+22+22	2.15	2.15	2.15	2.15	-	8.60 (3.40-10.70)	2.172 (0.600-2.880)	9.54	99
18+22+22+25	2.10	2.10	2.10	2.29	-	8.60 (3.40-10.70)	2.172 (0.600-2.950)	9.54	99
18+22+22+35	2.04	2.04	2.04	2.47	-	8.60 (3.40-10.70)	2.162 (0.600-2.960)	9.49	99
18+22+22+42	1.85	1.85	1.85	3.04	-	8.60 (3.40-10.70)	2.162 (0.600-2.960)	9.49	99
18+22+22+50	1.66	1.66	1.66	3.62	-	8.60 (3.40-10.70)	2.152 (0.600-2.950)	9.45	99
18+22+22+60	1.59	1.59	1.59	3.82	-	8.60 (3.40-10.70)	2.142 (0.600-2.940)	9.41	99
18+22+25+25	2.06	2.06	2.24	2.24	-	8.60 (3.40-10.70)	2.172 (0.600-2.970)	9.54	99
18+22+25+35	2.00	2.00	2.18	2.42	-	8.60 (3.40-10.70)	2.162 (0.600-2.960)	9.49	99
18+22+25+42	1.82	1.82	1.98	2.98	-	8.60 (3.40-10.70)	2.162 (0.600-2.960)	9.49	99
18+22+25+50	1.63	1.63	1.78	3.56	-	8.60 (3.40-10.70)	2.152 (0.600-2.950)	9.45	99

MXZ-4D72VA HEATING

Indoor units combination	Heating capacity (kW)						Outdoor unit power consumption(kW)	Current (A)	Power factor(%)
	Unit A	Unit B	Unit C	Unit D	Unit E	Total			
18+22+25+60	1.57	1.57	1.71	3.75	-	8.60 (3.40-10.70)	2.142 (0.600-2.940)	9.41	99
18+22+35+35	1.94	1.94	2.36	2.36	-	8.60 (3.40-10.70)	2.152 (0.600-2.950)	9.45	99
18+22+35+42	1.77	1.77	2.15	2.90	-	8.60 (3.40-10.70)	2.152 (0.600-2.950)	9.45	99
18+22+35+50	1.59	1.59	1.93	3.48	-	8.60 (3.40-10.70)	2.142 (0.600-2.940)	9.41	99
18+22+42+42	1.63	1.63	2.67	2.67	-	8.60 (3.40-10.70)	2.152 (0.600-2.950)	9.45	99
18+25+25+25	2.01	2.20	2.20	2.20	-	8.60 (3.40-10.70)	2.172 (0.600-2.970)	9.54	99
18+25+25+35	1.96	2.14	2.14	2.37	-	8.60 (3.40-10.70)	2.162 (0.600-2.960)	9.49	99
18+25+25+42	1.78	1.95	1.95	2.92	-	8.60 (3.40-10.70)	2.162 (0.600-2.960)	9.49	99
18+25+25+50	1.60	1.75	1.75	3.50	-	8.60 (3.40-10.70)	2.152 (0.600-2.950)	9.45	99
18+25+35+35	1.90	2.08	2.31	2.31	-	8.60 (3.40-10.70)	2.152 (0.600-2.950)	9.45	99
18+25+35+42	1.74	1.90	2.11	2.85	-	8.60 (3.40-10.70)	2.152 (0.600-2.950)	9.45	99
18+35+35+35	1.85	2.25	2.25	2.25	-	8.60 (3.40-10.70)	2.142 (0.600-2.940)	9.41	99
20+20+20+20	2.15	2.15	2.15	2.15	-	8.60 (3.40-10.70)	2.572 (0.880-3.370)	11.30	99
20+20+20+22	1.91	1.91	1.91	2.87	-	8.60 (3.40-10.70)	2.472 (0.810-3.270)	10.86	99
20+20+20+25	1.85	1.85	1.85	3.04	-	8.60 (3.40-10.70)	2.472 (0.810-3.340)	10.86	99
20+20+20+35	1.78	1.78	1.78	3.25	-	8.60 (3.40-10.70)	2.462 (0.810-3.395)	10.81	99
20+20+20+42	1.58	1.58	1.58	3.87	-	8.60 (3.40-10.70)	2.462 (0.810-3.395)	10.81	99
20+20+20+50	1.37	1.37	1.37	4.49	-	8.60 (3.40-10.70)	2.452 (0.810-3.385)	10.77	99
20+20+20+60	1.30	1.30	1.30	4.69	-	8.60 (3.40-10.70)	2.442 (0.810-3.375)	10.72	99
20+20+22+22	1.72	1.72	2.58	2.58	-	8.60 (3.40-10.70)	2.372 (0.740-3.170)	10.42	99
20+20+22+25	1.67	1.67	2.51	2.74	-	8.60 (3.40-10.70)	2.372 (0.740-3.240)	10.42	99
20+20+22+35	1.62	1.62	2.43	2.94	-	8.60 (3.40-10.70)	2.362 (0.740-3.250)	10.37	99
20+20+22+42	1.44	1.44	2.17	3.55	-	8.60 (3.40-10.70)	2.362 (0.740-3.250)	10.37	99
20+20+22+50	1.27	1.27	1.90	4.16	-	8.60 (3.40-10.70)	2.352 (0.740-3.240)	10.33	99
20+20+22+60	1.21	1.21	1.82	4.36	-	8.60 (3.40-10.70)	2.342 (0.740-3.230)	10.29	99
20+20+25+25	1.63	1.63	2.67	2.67	-	8.60 (3.40-10.70)	2.372 (0.740-3.260)	10.42	99
20+20+25+35	1.58	1.58	2.58	2.87	-	8.60 (3.40-10.70)	2.362 (0.740-3.250)	10.37	99
20+20+25+42	1.41	1.41	2.31	3.47	-	8.60 (3.40-10.70)	2.362 (0.740-3.250)	10.37	99
20+20+25+50	1.24	1.24	2.04	4.07	-	8.60 (3.40-10.70)	2.352 (0.740-3.240)	10.33	99
20+20+25+60	1.19	1.19	1.95	4.27	-	8.60 (3.40-10.70)	2.342 (0.740-3.230)	10.29	99
20+20+35+35	1.53	1.53	2.77	2.77	-	8.60 (3.40-10.70)	2.352 (0.740-3.240)	10.33	99
20+20+35+42	1.37	1.37	2.49	3.37	-	8.60 (3.40-10.70)	2.352 (0.740-3.240)	10.33	99
20+20+35+50	1.21	1.21	2.21	3.97	-	8.60 (3.40-10.70)	2.342 (0.740-3.230)	10.29	99
20+20+42+42	1.24	1.24	3.06	3.06	-	8.60 (3.40-10.70)	2.352 (0.740-3.240)	10.33	99
20+22+22+22	1.56	2.35	2.35	2.35	-	8.60 (3.40-10.70)	2.272 (0.670-3.070)	9.98	99
20+22+22+25	1.53	2.29	2.29	2.50	-	8.60 (3.40-10.70)	2.272 (0.670-3.115)	9.98	99
20+22+22+35	1.48	2.22	2.22	2.69	-	8.60 (3.40-10.70)	2.262 (0.670-3.105)	9.93	99
20+22+22+42	1.33	2.00	2.00	3.27	-	8.60 (3.40-10.70)	2.262 (0.670-3.105)	9.93	99
20+22+22+50	1.18	1.77	1.77	3.87	-	8.60 (3.40-10.70)	2.252 (0.670-3.095)	9.89	99
20+22+22+60	1.13	1.70	1.70	4.07	-	8.60 (3.40-10.70)	2.242 (0.670-3.085)	9.85	99
20+22+25+25	1.49	2.23	2.44	2.44	-	8.60 (3.40-10.70)	2.272 (0.670-3.115)	9.98	99

MXZ-4D72VA HEATING

Indoor units combination	Heating capacity (kW)						Outdoor unit power consumption(kW)	Current (A)	Power factor(%)
	Unit A	Unit B	Unit C	Unit D	Unit E	Total			
20+22+25+35	1.44	2.17	2.36	2.63	-	8.60 (3.40-10.70)	2.262 (0.670-3.105)	9.93	99
20+22+25+42	1.30	1.96	2.14	3.20	-	8.60 (3.40-10.70)	2.262 (0.670-3.105)	9.93	99
20+22+25+50	1.16	1.74	1.90	3.80	-	8.60 (3.40-10.70)	2.252 (0.670-3.095)	9.89	99
20+22+35+35	1.40	2.10	2.55	2.55	-	8.60 (3.40-10.70)	2.252 (0.670-3.095)	9.89	99
20+22+35+42	1.27	1.90	2.31	3.12	-	8.60 (3.40-10.70)	2.252 (0.670-3.095)	9.89	99
20+25+25+25	1.46	2.38	2.38	2.38	-	8.60 (3.40-10.70)	2.272 (0.670-3.115)	9.98	99
20+25+25+35	1.41	2.31	2.31	2.57	-	8.60 (3.40-10.70)	2.262 (0.670-3.105)	9.93	99
20+25+25+42	1.28	2.09	2.09	3.14	-	8.60 (3.40-10.70)	2.262 (0.670-3.105)	9.93	99
20+25+25+50	1.14	1.87	1.87	3.73	-	8.60 (3.40-10.70)	2.252 (0.670-3.095)	9.89	99
20+25+35+35	1.37	2.24	2.49	2.49	-	8.60 (3.40-10.70)	2.252 (0.670-3.095)	9.89	99
20+25+35+42	1.24	2.04	2.26	3.06	-	8.60 (3.40-10.70)	2.252 (0.670-3.095)	9.89	99
20+35+35+35	1.33	2.42	2.42	2.42	-	8.60 (3.40-10.70)	2.242 (0.670-3.085)	9.85	99
22+22+22+22	2.15	2.15	2.15	2.15	-	8.60 (3.40-10.70)	2.172 (0.600-2.970)	9.54	99
22+22+22+25	2.10	2.10	2.10	2.29	-	8.60 (3.40-10.70)	2.172 (0.600-2.970)	9.54	99
22+22+22+35	2.04	2.04	2.04	2.47	-	8.60 (3.40-10.70)	2.162 (0.600-2.960)	9.49	99
22+22+22+42	1.85	1.85	1.85	3.04	-	8.60 (3.40-10.70)	2.162 (0.600-2.960)	9.49	99
22+22+22+50	1.66	1.66	1.66	3.62	-	8.60 (3.40-10.70)	2.152 (0.600-2.950)	9.45	99
22+22+25+25	2.06	2.06	2.24	2.24	-	8.60 (3.40-10.70)	2.172 (0.600-2.970)	9.54	99
22+22+25+35	2.00	2.00	2.18	2.42	-	8.60 (3.40-10.70)	2.162 (0.600-2.960)	9.49	99
22+22+25+42	1.82	1.82	1.98	2.98	-	8.60 (3.40-10.70)	2.162 (0.600-2.960)	9.49	99
22+22+25+50	1.63	1.63	1.78	3.56	-	8.60 (3.40-10.70)	2.152 (0.600-2.950)	9.45	99
22+22+35+35	1.94	1.94	2.36	2.36	-	8.60 (3.40-10.70)	2.152 (0.600-2.950)	9.45	99
22+22+35+42	1.77	1.77	2.15	2.90	-	8.60 (3.40-10.70)	2.152 (0.600-2.950)	9.45	99
22+25+25+25	2.01	2.20	2.20	2.20	-	8.60 (3.40-10.70)	2.172 (0.600-2.970)	9.54	99
22+25+25+35	1.96	2.14	2.14	2.37	-	8.60 (3.40-10.70)	2.162 (0.600-2.960)	9.49	99
22+25+25+42	1.78	1.95	1.95	2.92	-	8.60 (3.40-10.70)	2.162 (0.600-2.960)	9.49	99
22+25+25+50	1.60	1.75	1.75	3.50	-	8.60 (3.40-10.70)	2.152 (0.600-2.950)	9.45	99
22+25+35+35	1.90	2.08	2.31	2.31	-	8.60 (3.40-10.70)	2.152 (0.600-2.950)	9.45	99
22+25+35+42	1.74	1.90	2.11	2.85	-	8.60 (3.40-10.70)	2.152 (0.600-2.950)	9.45	99
25+25+25+25	2.15	2.15	2.15	2.15	-	8.60 (3.40-10.70)	2.172 (0.600-2.970)	9.54	99
25+25+25+35	2.09	2.09	2.09	2.32	-	8.60 (3.40-10.70)	2.162 (0.600-2.960)	9.49	99
25+25+25+42	1.91	1.91	1.91	2.87	-	8.60 (3.40-10.70)	2.162 (0.600-2.960)	9.49	99
25+25+25+50	1.72	1.72	1.72	3.44	-	8.60 (3.40-10.70)	2.152 (0.600-2.950)	9.45	99
25+25+35+35	2.04	2.04	2.26	2.26	-	8.60 (3.40-10.70)	2.152 (0.600-2.950)	9.45	99

MXZ-4D83VA COOLING

Indoor units combination	Cooling capacity (kW)						Outdoor unit power consumption(kW)	Current (A)	Power factor(%)
	Unit A	Unit B	Unit C	Unit D	Unit E	Total			
15	1.50	-	-	-	-	1.50 (1.40-2.10)	0.540 (0.470-1.000)	2.37	99
18	1.80	-	-	-	-	1.80 (1.40-3.00)	0.560 (0.400-0.920)	2.46	99
20	2.00	-	-	-	-	2.00 (1.40-2.80)	0.720 (0.470-1.330)	3.16	99
22	2.20	-	-	-	-	2.20 (1.40-3.00)	0.680 (0.400-0.920)	2.99	99
25	2.50	-	-	-	-	2.50 (1.40-3.30)	0.760 (0.400-1.010)	3.34	99
35	3.50	-	-	-	-	3.50 (1.50-4.30)	1.030 (0.400-1.290)	4.52	99
42	4.20	-	-	-	-	4.20 (1.60-5.00)	1.230 (0.410-1.460)	5.40	99
50	5.00	-	-	-	-	5.00 (1.60-5.60)	1.440 (0.420-1.630)	6.32	99
60	6.00	-	-	-	-	6.00 (1.60-6.60)	1.880 (0.400-2.130)	8.26	99
71	7.10	-	-	-	-	7.10 (1.70-7.40)	2.340 (0.410-2.710)	10.28	99
15+15	1.50	1.50	-	-	-	3.00 (2.00-4.00)	0.750 (0.600-2.120)	3.29	99
15+18	1.50	1.80	-	-	-	3.30 (2.00-4.80)	0.838 (0.600-1.860)	3.68	99
15+20	1.50	2.00	-	-	-	3.50 (2.00-5.00)	1.003 (0.600-2.440)	4.40	99
15+22	1.50	2.20	-	-	-	3.70 (2.00-5.40)	0.991 (0.600-1.860)	4.35	99
15+25	1.50	2.50	-	-	-	4.00 (2.00-5.40)	1.067 (0.600-1.860)	4.69	99
15+35	1.50	3.50	-	-	-	5.00 (2.00-6.00)	1.400 (0.580-2.210)	6.15	99
15+42	1.50	4.20	-	-	-	5.70 (2.00-6.60)	1.665 (0.580-2.615)	7.31	99
15+50	1.50	5.00	-	-	-	6.50 (2.00-7.20)	2.040 (0.580-2.870)	8.96	99
15+60	1.50	6.00	-	-	-	7.50 (2.00-7.80)	2.609 (0.580-3.050)	11.46	99
15+71	1.36	6.44	-	-	-	7.80 (2.00-8.10)	2.805 (0.590-3.150)	12.32	99
18+18	1.80	1.80	-	-	-	3.60 (2.00-5.60)	0.925 (0.600-1.600)	4.06	99
18+20	1.80	2.00	-	-	-	3.80 (2.00-5.40)	1.056 (0.600-2.180)	4.64	99
18+22	1.80	2.20	-	-	-	4.00 (2.00-5.60)	1.027 (0.600-1.600)	4.51	99
18+25	1.80	2.50	-	-	-	4.30 (2.00-5.60)	1.104 (0.600-1.600)	4.85	99
18+35	1.80	3.50	-	-	-	5.30 (2.00-6.50)	1.495 (0.580-2.125)	6.57	99
18+42	1.80	4.20	-	-	-	6.00 (2.00-7.10)	1.760 (0.580-2.530)	7.73	99
18+50	1.80	5.00	-	-	-	6.80 (2.00-7.60)	2.144 (0.580-2.665)	9.42	99
18+60	1.78	5.92	-	-	-	7.70 (2.00-8.10)	2.710 (0.580-2.835)	11.90	99
18+71	1.58	6.22	-	-	-	7.80 (2.00-8.40)	2.758 (0.590-2.945)	12.11	99
20+20	2.00	2.00	-	-	-	4.00 (2.00-5.20)	1.187 (0.600-2.760)	5.21	99
20+22	2.00	2.20	-	-	-	4.20 (2.00-5.40)	1.159 (0.600-2.180)	5.09	99
20+25	2.00	2.50	-	-	-	4.50 (2.00-5.50)	1.248 (0.600-2.240)	5.48	99
20+35	2.00	3.50	-	-	-	5.50 (2.00-6.50)	1.665 (0.580-2.825)	7.31	99
20+42	2.00	4.20	-	-	-	6.20 (2.00-7.00)	1.936 (0.580-3.145)	8.50	99
20+50	2.00	5.00	-	-	-	7.00 (2.00-7.50)	2.320 (0.580-3.280)	10.19	99
20+60	1.93	5.78	-	-	-	7.70 (2.00-7.90)	2.810 (0.580-3.425)	12.34	99
20+71	1.71	6.09	-	-	-	7.80 (2.00-8.30)	2.833 (0.590-3.560)	12.44	99
22+22	2.20	2.20	-	-	-	4.40 (2.00-5.60)	1.130 (0.600-1.600)	4.96	99
22+25	2.20	2.50	-	-	-	4.70 (2.00-5.90)	1.245 (0.590-1.775)	5.47	99
22+35	2.20	3.50	-	-	-	5.70 (2.00-6.80)	1.675 (0.580-2.365)	7.36	99
22+42	2.20	4.20	-	-	-	6.40 (2.00-7.30)	1.952 (0.580-2.600)	8.57	99

MXZ-4D83VA COOLING

Indoor units combination	Cooling capacity (kW)						Outdoor unit power consumption(kW)	Current (A)	Power factor(%)
	Unit A	Unit B	Unit C	Unit D	Unit E	Total			
22+50	2.20	5.00	-	-	-	7.20 (2.00-7.80)	2.371 (0.580-2.740)	10.41	99
22+60	2.09	5.71	-	-	-	7.80 (2.00-8.20)	2.750 (0.590-2.850)	12.08	99
22+71	1.87	6.03	-	-	-	7.90 (2.10-8.50)	2.748 (0.590-3.020)	12.07	99
25+25	2.50	2.50	-	-	-	5.00 (2.00-6.20)	1.360 (0.580-1.950)	5.97	99
25+35	2.50	3.50	-	-	-	6.00 (2.00-7.10)	1.810 (0.580-2.540)	7.95	99
25+42	2.50	4.20	-	-	-	6.70 (2.00-7.50)	2.096 (0.580-2.655)	9.21	99
25+50	2.50	5.00	-	-	-	7.50 (2.00-8.00)	2.569 (0.580-2.800)	11.28	99
25+60	2.29	5.51	-	-	-	7.80 (2.00-8.20)	2.768 (0.590-2.880)	12.16	99
25+71	2.06	5.84	-	-	-	7.90 (2.10-8.70)	2.740 (0.590-3.075)	12.03	99
35+35	3.50	3.50	-	-	-	7.00 (2.00-7.70)	2.290 (0.580-2.720)	10.06	99
35+42	3.50	4.20	-	-	-	7.70 (2.00-8.10)	2.700 (0.580-2.850)	11.86	99
35+50	3.21	4.59	-	-	-	7.80 (2.00-8.20)	2.768 (0.590-2.890)	12.16	99
35+60	2.91	4.99	-	-	-	7.90 (2.10-8.60)	2.743 (0.590-3.065)	12.05	99
35+71	2.61	5.29	-	-	-	7.90 (2.10-8.80)	2.667 (0.580-3.115)	11.71	99
42+42	3.90	3.90	-	-	-	7.80 (2.00-8.20)	2.720 (0.590-2.870)	11.95	99
42+50	3.61	4.29	-	-	-	7.90 (2.10-8.50)	2.700 (0.590-3.010)	11.86	99
42+71	2.97	5.03	-	-	-	8.00 (2.10-8.80)	2.544 (0.560-3.070)	11.17	99
50+50	3.95	3.95	-	-	-	7.90 (2.10-8.80)	2.680 (0.590-3.150)	11.77	99
50+60	3.64	4.36	-	-	-	8.00 (2.10-8.80)	2.575 (0.570-3.085)	11.31	99
50+71	3.31	4.69	-	-	-	8.00 (2.10-8.80)	2.470 (0.550-3.020)	10.85	99
60+60	4.00	4.00	-	-	-	8.00 (2.10-8.80)	2.470 (0.550-3.020)	10.85	99
60+71	3.66	4.34	-	-	-	8.00 (2.10-8.80)	2.470 (0.550-3.010)	10.85	99
15+15+15	1.50	1.50	1.50	-	-	4.50 (2.90-5.70)	1.306 (0.780-3.010)	5.74	99
15+15+18	1.50	1.50	1.80	-	-	4.80 (2.90-6.50)	1.345 (0.750-2.810)	5.91	99
15+15+20	1.50	1.50	2.00	-	-	5.00 (2.90-6.70)	1.438 (0.780-3.240)	6.32	99
15+15+22	1.50	1.50	2.20	-	-	5.20 (2.90-7.30)	1.450 (0.750-2.810)	6.37	99
15+15+25	1.50	1.50	2.50	-	-	5.50 (2.90-7.70)	1.529 (0.750-2.810)	6.71	99
15+15+35	1.50	1.50	3.50	-	-	6.50 (2.90-7.70)	1.794 (0.750-2.810)	7.88	99
15+15+42	1.50	1.50	4.20	-	-	7.20 (2.90-8.30)	2.067 (0.750-3.200)	9.08	99
15+15+50	1.43	1.43	4.75	-	-	7.60 (2.90-8.60)	2.213 (0.760-3.395)	9.72	99
15+15+60	1.30	1.30	5.20	-	-	7.80 (2.90-8.60)	2.230 (0.770-3.390)	9.79	99
15+15+71	1.17	1.17	5.55	-	-	7.90 (2.90-8.60)	2.261 (0.780-3.385)	9.93	99
15+18+18	1.50	1.80	1.80	-	-	5.10 (2.90-7.30)	1.384 (0.720-2.610)	6.08	99
15+18+20	1.50	1.80	2.00	-	-	5.30 (2.90-7.50)	1.477 (0.750-3.040)	6.49	99
15+18+22	1.50	1.80	2.20	-	-	5.50 (2.90-7.90)	1.489 (0.720-2.610)	6.54	99
15+18+25	1.50	1.80	2.50	-	-	5.80 (2.90-7.90)	1.568 (0.720-2.610)	6.89	99
15+18+35	1.50	1.80	3.50	-	-	6.80 (2.90-8.10)	1.869 (0.720-2.745)	8.21	99
15+18+42	1.50	1.80	4.20	-	-	7.50 (2.90-8.80)	2.160 (0.720-3.200)	9.49	99
15+18+60	1.26	1.51	5.03	-	-	7.80 (2.90-8.80)	2.204 (0.740-3.190)	9.68	99
15+18+71	1.15	1.38	5.46	-	-	8.00 (2.90-8.80)	2.235 (0.750-3.190)	9.82	99
15+20+20	1.50	2.00	2.00	-	-	5.50 (2.90-7.50)	1.569 (0.780-3.470)	6.89	99

MXZ-4D83VA COOLING

Indoor units combination	Cooling capacity (kW)						Outdoor unit power consumption(kW)	Current (A)	Power factor(%)
	Unit A	Unit B	Unit C	Unit D	Unit E	Total			
15+20+22	1.50	2.00	2.20	-	-	5.70 (2.90-7.70)	1.582 (0.750-3.040)	6.95	99
15+20+25	1.50	2.00	2.50	-	-	6.00 (2.90-7.70)	1.661 (0.750-3.040)	7.29	99
15+20+35	1.50	2.00	3.50	-	-	7.00 (2.90-8.10)	1.998 (0.750-3.305)	8.77	99
15+20+42	1.46	1.95	4.09	-	-	7.50 (2.90-8.60)	2.209 (0.750-3.630)	9.70	99
15+20+50	1.36	1.81	4.53	-	-	7.70 (2.90-8.60)	2.237 (0.760-3.625)	9.82	99
15+20+60	1.23	1.64	4.93	-	-	7.80 (2.90-8.60)	2.253 (0.770-3.625)	9.89	99
15+20+71	1.13	1.51	5.36	-	-	8.00 (2.90-8.60)	2.280 (0.780-3.620)	10.01	99
15+22+22	1.50	2.20	2.20	-	-	5.90 (2.90-7.90)	1.595 (0.720-2.610)	7.00	99
15+22+25	1.50	2.20	2.50	-	-	6.20 (2.90-7.90)	1.674 (0.720-2.610)	7.35	99
15+22+35	1.50	2.20	3.50	-	-	7.20 (2.90-8.50)	2.047 (0.720-3.010)	8.99	99
15+22+42	1.44	2.12	4.04	-	-	7.60 (2.90-8.80)	2.179 (0.720-3.205)	9.57	99
15+22+50	1.33	1.95	4.43	-	-	7.70 (2.90-8.80)	2.206 (0.730-3.200)	9.69	99
15+22+60	1.22	1.79	4.89	-	-	7.90 (2.90-8.80)	2.223 (0.740-3.195)	9.76	99
15+22+71	1.11	1.63	5.26	-	-	8.00 (2.90-8.80)	2.240 (0.750-3.195)	9.84	99
15+25+25	1.50	2.50	2.50	-	-	6.50 (2.90-7.90)	1.754 (0.720-2.610)	7.70	99
15+25+35	1.50	2.50	3.50	-	-	7.50 (2.90-8.80)	2.180 (0.720-3.210)	9.57	99
15+25+42	1.39	2.32	3.89	-	-	7.60 (2.90-8.80)	2.193 (0.730-3.205)	9.63	99
15+25+50	1.30	2.17	4.33	-	-	7.80 (2.90-8.80)	2.220 (0.740-3.200)	9.75	99
15+25+60	1.19	1.98	4.74	-	-	7.90 (2.90-8.80)	2.237 (0.750-3.195)	9.82	99
15+25+71	1.08	1.80	5.12	-	-	8.00 (2.90-8.80)	2.240 (0.740-3.200)	9.84	99
15+35+35	1.36	3.17	3.17	-	-	7.70 (2.90-8.80)	2.227 (0.730-3.215)	9.78	99
15+35+42	1.27	2.97	3.56	-	-	7.80 (2.90-8.80)	2.239 (0.740-3.210)	9.83	99
15+35+50	1.19	2.77	3.95	-	-	7.90 (2.90-8.80)	2.267 (0.750-3.205)	9.96	99
15+35+60	1.09	2.55	4.36	-	-	8.00 (2.90-8.80)	2.260 (0.740-3.210)	9.93	99
15+35+71	0.99	2.31	4.69	-	-	8.00 (2.90-8.80)	2.240 (0.730-3.220)	9.84	99
15+42+42	1.20	3.35	3.35	-	-	7.90 (2.90-8.80)	2.252 (0.740-3.205)	9.89	99
15+42+50	1.12	3.14	3.74	-	-	8.00 (2.90-8.80)	2.270 (0.750-3.205)	9.97	99
15+42+60	1.03	2.87	4.10	-	-	8.00 (2.90-8.80)	2.240 (0.730-3.215)	9.84	99
15+42+71	0.94	2.63	4.44	-	-	8.00 (2.90-8.80)	2.220 (0.720-3.215)	9.75	99
15+50+50	1.04	3.48	3.48	-	-	8.00 (2.90-8.80)	2.260 (0.740-3.210)	9.93	99
15+50+60	0.96	3.20	3.84	-	-	8.00 (2.90-8.80)	2.230 (0.720-3.220)	9.79	99
15+50+71	0.88	2.94	4.18	-	-	8.00 (2.90-8.80)	2.210 (0.730-3.195)	9.71	99
15+60+60	0.89	3.56	3.56	-	-	8.00 (2.90-8.80)	2.200 (0.730-3.195)	9.66	99
18+18+18	1.80	1.80	1.80	-	-	5.40 (2.90-8.10)	1.423 (0.690-2.410)	6.25	99
18+18+20	1.80	1.80	2.00	-	-	5.60 (2.90-7.90)	1.516 (0.720-2.840)	6.66	99
18+18+22	1.80	1.80	2.20	-	-	5.80 (2.90-8.10)	1.528 (0.690-2.410)	6.71	99
18+18+25	1.80	1.80	2.50	-	-	6.10 (2.90-8.10)	1.608 (0.690-2.410)	7.06	99
18+18+35	1.80	1.80	3.50	-	-	7.10 (2.90-8.60)	1.962 (0.690-2.745)	8.62	99
18+18+42	1.75	1.75	4.09	-	-	7.60 (2.90-9.00)	2.134 (0.690-3.000)	9.37	99
18+18+50	1.61	1.61	4.48	-	-	7.70 (2.90-9.00)	2.161 (0.700-2.995)	9.49	99
18+18+60	1.48	1.48	4.94	-	-	7.90 (2.90-9.00)	2.178 (0.710-2.995)	9.57	99

MXZ-4D83VA COOLING

Indoor units combination	Cooling capacity (kW)						Outdoor unit power consumption(kW)	Current (A)	Power factor(%)
	Unit A	Unit B	Unit C	Unit D	Unit E	Total			
18+18+71	1.35	1.35	5.31	-	-	8.00 (2.90-9.00)	2.200 (0.720-2.995)	9.66	99
18+20+20	1.80	2.00	2.00	-	-	5.80 (2.90-7.70)	1.608 (0.750-3.270)	7.06	99
18+20+22	1.80	2.00	2.20	-	-	6.00 (2.90-7.90)	1.621 (0.720-2.840)	7.12	99
18+20+25	1.80	2.00	2.50	-	-	6.30 (2.90-7.90)	1.701 (0.720-2.840)	7.47	99
18+20+35	1.80	2.00	3.50	-	-	7.30 (2.90-8.60)	2.091 (0.720-3.305)	9.18	99
18+20+42	1.71	1.90	3.99	-	-	7.60 (2.90-8.80)	2.183 (0.730-3.435)	9.59	99
18+20+50	1.58	1.75	4.38	-	-	7.70 (2.90-8.80)	2.211 (0.730-3.430)	9.71	99
18+20+60	1.45	1.61	4.84	-	-	7.90 (2.90-8.80)	2.227 (0.740-3.425)	9.78	99
18+20+71	1.32	1.47	5.21	-	-	8.00 (2.90-8.80)	2.240 (0.740-3.430)	9.84	99
18+22+22	1.80	2.20	2.20	-	-	6.20 (2.90-8.10)	1.634 (0.690-2.410)	7.18	99
18+22+25	1.80	2.20	2.50	-	-	6.50 (2.90-8.10)	1.714 (0.690-2.410)	7.53	99
18+22+35	1.80	2.20	3.50	-	-	7.50 (2.90-9.00)	2.140 (0.690-3.010)	9.40	99
18+22+42	1.67	2.04	3.89	-	-	7.60 (2.90-9.00)	2.153 (0.700-3.005)	9.46	99
18+22+50	1.56	1.91	4.33	-	-	7.80 (2.90-9.00)	2.180 (0.710-3.000)	9.57	99
18+22+60	1.42	1.74	4.74	-	-	7.90 (2.90-9.00)	2.197 (0.720-2.995)	9.65	99
18+22+71	1.30	1.59	5.12	-	-	8.00 (2.90-9.00)	2.200 (0.710-3.000)	9.66	99
18+25+25	1.80	2.50	2.50	-	-	6.80 (2.90-8.30)	1.829 (0.690-2.545)	8.03	99
18+25+35	1.75	2.44	3.41	-	-	7.60 (2.90-9.00)	2.154 (0.690-3.010)	9.46	99
18+25+42	1.63	2.26	3.80	-	-	7.70 (2.90-9.00)	2.167 (0.700-3.005)	9.52	99
18+25+50	1.51	2.10	4.19	-	-	7.80 (2.90-9.00)	2.194 (0.710-3.000)	9.64	99
18+25+60	1.40	1.94	4.66	-	-	8.00 (2.90-9.00)	2.211 (0.720-3.000)	9.71	99
18+25+71	1.26	1.75	4.98	-	-	8.00 (2.90-9.00)	2.200 (0.710-3.005)	9.66	99
18+35+35	1.58	3.06	3.06	-	-	7.70 (2.90-9.00)	2.201 (0.700-3.020)	9.67	99
18+35+42	1.48	2.87	3.45	-	-	7.80 (2.90-9.00)	2.213 (0.710-3.015)	9.72	99
18+35+50	1.40	2.72	3.88	-	-	8.00 (2.90-9.00)	2.241 (0.720-3.010)	9.84	99
18+35+60	1.27	2.48	4.25	-	-	8.00 (2.90-9.00)	2.220 (0.710-3.015)	9.75	99
18+35+71	1.16	2.26	4.58	-	-	8.00 (2.90-9.00)	2.200 (0.690-3.025)	9.66	99
18+42+42	1.41	3.29	3.29	-	-	8.00 (2.90-9.00)	2.226 (0.720-3.010)	9.78	99
18+42+50	1.31	3.05	3.64	-	-	8.00 (2.90-9.00)	2.230 (0.710-3.010)	9.79	99
18+42+60	1.20	2.80	4.00	-	-	8.00 (2.90-9.00)	2.200 (0.700-3.020)	9.66	99
18+42+71	1.10	2.56	4.34	-	-	8.00 (2.90-9.00)	2.180 (0.700-3.010)	9.57	99
18+50+50	1.22	3.39	3.39	-	-	8.00 (2.90-9.00)	2.220 (0.700-3.015)	9.75	99
18+50+60	1.13	3.13	3.75	-	-	8.00 (2.90-9.00)	2.190 (0.690-3.015)	9.62	99
18+50+71	1.04	2.88	4.09	-	-	8.00 (2.90-9.00)	2.170 (0.710-2.990)	9.53	99
18+60+60	1.04	3.48	3.48	-	-	8.00 (2.90-9.00)	2.160 (0.710-2.990)	9.49	99
20+20+20	2.00	2.00	2.00	-	-	6.00 (2.90-7.50)	1.701 (0.780-3.700)	7.47	99
20+20+22	2.00	2.00	2.20	-	-	6.20 (2.90-7.70)	1.714 (0.750-3.270)	7.53	99
20+20+25	2.00	2.00	2.50	-	-	6.50 (2.90-7.70)	1.794 (0.750-3.270)	7.88	99
20+20+35	2.00	2.00	3.50	-	-	7.50 (2.90-8.60)	2.220 (0.750-3.870)	9.75	99
20+20+42	1.85	1.85	3.89	-	-	7.60 (2.90-8.60)	2.233 (0.760-3.865)	9.81	99
20+20+50	1.73	1.73	4.33	-	-	7.80 (2.90-8.60)	2.260 (0.770-3.860)	9.93	99

MXZ-4D83VA COOLING

Indoor units combination	Cooling capacity (kW)						Outdoor unit power consumption(kW)	Current (A)	Power factor(%)
	Unit A	Unit B	Unit C	Unit D	Unit E	Total			
20+20+60	1.58	1.58	4.74	-	-	7.90 (2.90-8.60)	2.277 (0.780-3.855)	10.00	99
20+20+71	1.44	1.44	5.12	-	-	8.00 (2.90-8.60)	2.280 (0.770-3.860)	10.01	99
20+22+22	2.00	2.20	2.20	-	-	6.40 (2.90-7.90)	1.727 (0.720-2.840)	7.58	99
20+22+25	2.00	2.20	2.50	-	-	6.70 (2.90-8.00)	1.824 (0.720-2.905)	8.01	99
20+22+35	1.95	2.14	3.41	-	-	7.50 (2.90-8.80)	2.189 (0.720-3.440)	9.61	99
20+22+42	1.83	2.02	3.85	-	-	7.70 (2.90-8.80)	2.202 (0.730-3.435)	9.67	99
20+22+50	1.70	1.87	4.24	-	-	7.80 (2.90-8.80)	2.229 (0.740-3.430)	9.79	99
20+22+60	1.57	1.73	4.71	-	-	8.00 (2.90-8.80)	2.246 (0.750-3.430)	9.86	99
20+22+71	1.42	1.56	5.03	-	-	8.00 (2.90-8.80)	2.240 (0.740-3.435)	9.84	99
20+25+25	2.00	2.50	2.50	-	-	7.00 (2.90-8.30)	1.958 (0.720-3.105)	8.60	99
20+25+35	1.90	2.38	3.33	-	-	7.60 (2.90-8.80)	2.203 (0.730-3.445)	9.68	99
20+25+42	1.77	2.21	3.72	-	-	7.70 (2.90-8.80)	2.216 (0.730-3.440)	9.73	99
20+25+50	1.64	2.05	4.11	-	-	7.80 (2.90-8.80)	2.243 (0.740-3.435)	9.85	99
20+25+60	1.52	1.90	4.57	-	-	8.00 (2.90-8.80)	2.260 (0.750-3.430)	9.93	99
20+25+71	1.38	1.72	4.90	-	-	8.00 (2.90-8.80)	2.240 (0.730-3.440)	9.84	99
20+35+35	1.73	3.03	3.03	-	-	7.80 (2.90-8.80)	2.250 (0.740-3.450)	9.88	99
20+35+42	1.63	2.85	3.42	-	-	7.90 (2.90-8.80)	2.263 (0.740-3.445)	9.94	99
20+35+50	1.52	2.67	3.81	-	-	8.00 (2.90-8.80)	2.290 (0.750-3.440)	10.06	99
20+35+60	1.39	2.43	4.17	-	-	8.00 (2.90-8.80)	2.260 (0.740-3.450)	9.93	99
20+35+71	1.27	2.22	4.51	-	-	8.00 (2.90-8.80)	2.240 (0.720-3.460)	9.84	99
20+42+42	1.54	3.23	3.23	-	-	8.00 (2.90-8.80)	2.275 (0.750-3.440)	9.99	99
20+42+50	1.43	3.00	3.57	-	-	8.00 (2.90-8.80)	2.270 (0.740-3.445)	9.97	99
20+42+60	1.31	2.75	3.93	-	-	8.00 (2.90-8.80)	2.240 (0.730-3.450)	9.84	99
20+42+71	1.20	2.53	4.27	-	-	8.00 (2.90-8.80)	2.220 (0.730-3.440)	9.75	99
20+50+50	1.33	3.33	3.33	-	-	8.00 (2.90-8.80)	2.260 (0.730-3.450)	9.93	99
20+50+60	1.23	3.08	3.69	-	-	8.00 (2.90-8.80)	2.230 (0.730-3.445)	9.79	99
20+50+71	1.13	2.84	4.03	-	-	8.00 (2.90-8.80)	2.210 (0.740-3.415)	9.71	99
20+60+60	1.14	3.43	3.43	-	-	8.00 (2.90-8.80)	2.200 (0.740-3.415)	9.66	99
22+22+22	2.20	2.20	2.20	-	-	6.60 (2.90-8.10)	1.740 (0.690-2.410)	7.64	99
22+22+25	2.20	2.20	2.50	-	-	6.90 (2.90-8.40)	1.873 (0.690-2.610)	8.23	99
22+22+35	2.12	2.12	3.37	-	-	7.60 (2.90-9.00)	2.159 (0.690-3.015)	9.48	99
22+22+42	1.97	1.97	3.76	-	-	7.70 (2.90-9.00)	2.171 (0.700-3.005)	9.53	99
22+22+50	1.83	1.83	4.15	-	-	7.80 (2.90-9.00)	2.199 (0.710-3.005)	9.66	99
22+22+60	1.69	1.69	4.62	-	-	8.00 (2.90-9.00)	2.215 (0.720-3.000)	9.73	99
22+22+71	1.53	1.53	4.94	-	-	8.00 (2.90-9.00)	2.200 (0.710-3.010)	9.66	99
22+25+25	2.20	2.50	2.50	-	-	7.20 (2.90-8.70)	2.007 (0.690-2.810)	8.81	99
22+25+35	2.04	2.32	3.24	-	-	7.60 (2.90-9.00)	2.173 (0.700-3.015)	9.54	99
22+25+42	1.90	2.16	3.63	-	-	7.70 (2.90-9.00)	2.185 (0.700-3.010)	9.60	99
22+25+50	1.79	2.04	4.07	-	-	7.90 (2.90-9.00)	2.213 (0.710-3.005)	9.72	99
22+25+60	1.64	1.87	4.49	-	-	8.00 (2.90-9.00)	2.220 (0.720-3.005)	9.75	99
22+25+71	1.49	1.69	4.81	-	-	8.00 (2.90-9.00)	2.200 (0.700-3.015)	9.66	99

MXZ-4D83VA COOLING

Indoor units combination	Cooling capacity (kW)						Outdoor unit power consumption(kW)	Current (A)	Power factor(%)
	Unit A	Unit B	Unit C	Unit D	Unit E	Total			
22+35+35	1.87	2.97	2.97	-	-	7.80 (2.90-9.00)	2.219 (0.710-3.020)	9.75	99
22+35+42	1.76	2.79	3.35	-	-	7.90 (2.90-9.00)	2.232 (0.710-3.015)	9.80	99
22+35+50	1.64	2.62	3.74	-	-	8.00 (2.90-9.00)	2.250 (0.720-3.015)	9.88	99
22+35+60	1.50	2.39	4.10	-	-	8.00 (2.90-9.00)	2.220 (0.700-3.025)	9.75	99
22+35+71	1.38	2.19	4.44	-	-	8.00 (2.90-9.00)	2.200 (0.690-3.025)	9.66	99
22+42+42	1.66	3.17	3.17	-	-	8.00 (2.90-9.00)	2.240 (0.720-3.010)	9.84	99
22+42+50	1.54	2.95	3.51	-	-	8.00 (2.90-9.00)	2.230 (0.710-3.015)	9.79	99
22+42+60	1.42	2.71	3.87	-	-	8.00 (2.90-9.00)	2.200 (0.690-3.025)	9.66	99
22+42+71	1.30	2.49	4.21	-	-	8.00 (2.90-9.00)	2.180 (0.700-3.005)	9.57	99
22+50+50	1.44	3.28	3.28	-	-	8.00 (2.90-9.00)	2.220 (0.700-3.020)	9.75	99
22+50+60	1.33	3.03	3.64	-	-	8.00 (2.90-9.00)	2.190 (0.700-3.010)	9.62	99
22+50+71	1.23	2.80	3.97	-	-	8.00 (2.90-9.00)	2.170 (0.710-2.980)	9.53	99
22+60+60	1.24	3.38	3.38	-	-	8.00 (2.90-9.00)	2.160 (0.710-2.985)	9.49	99
25+25+25	2.50	2.50	2.50	-	-	7.50 (2.90-9.00)	2.140 (0.690-3.010)	9.40	99
25+25+35	2.26	2.26	3.17	-	-	7.70 (2.90-9.00)	2.187 (0.700-3.015)	9.60	99
25+25+42	2.12	2.12	3.56	-	-	7.80 (2.90-9.00)	2.199 (0.710-3.010)	9.66	99
25+25+50	1.98	1.98	3.95	-	-	7.90 (2.90-9.00)	2.227 (0.720-3.005)	9.78	99
25+25+60	1.82	1.82	4.36	-	-	8.00 (2.90-9.00)	2.220 (0.710-3.010)	9.75	99
25+25+71	1.65	1.65	4.69	-	-	8.00 (2.90-9.00)	2.200 (0.700-3.020)	9.66	99
25+35+35	2.05	2.87	2.87	-	-	7.80 (2.90-9.00)	2.233 (0.710-3.025)	9.81	99
25+35+42	1.96	2.75	3.29	-	-	8.00 (2.90-9.00)	2.246 (0.720-3.020)	9.86	99
25+35+50	1.82	2.55	3.64	-	-	8.00 (2.90-9.00)	2.250 (0.710-3.020)	9.88	99
25+35+60	1.67	2.33	4.00	-	-	8.00 (2.90-9.00)	2.220 (0.700-3.030)	9.75	99
25+35+71	1.53	2.14	4.34	-	-	8.00 (2.90-9.00)	2.200 (0.700-3.020)	9.66	99
25+42+42	1.83	3.08	3.08	-	-	8.00 (2.90-9.00)	2.240 (0.710-3.020)	9.84	99
25+42+50	1.71	2.87	3.42	-	-	8.00 (2.90-9.00)	2.230 (0.700-3.025)	9.79	99
25+42+60	1.57	2.65	3.78	-	-	8.00 (2.90-9.00)	2.200 (0.690-3.030)	9.66	99
25+42+71	1.45	2.43	4.12	-	-	8.00 (2.90-9.00)	2.180 (0.710-3.000)	9.57	99
25+50+50	1.60	3.20	3.20	-	-	8.00 (2.90-9.00)	2.220 (0.690-3.030)	9.75	99
25+50+60	1.48	2.96	3.56	-	-	8.00 (2.90-9.00)	2.190 (0.700-3.005)	9.62	99
25+60+60	1.38	3.31	3.31	-	-	8.00 (2.90-9.00)	2.160 (0.710-2.980)	9.49	99
35+35+35	2.67	2.67	2.67	-	-	8.00 (2.90-9.00)	2.280 (0.720-3.030)	10.01	99
35+35+42	2.50	2.50	3.00	-	-	8.00 (2.90-9.00)	2.260 (0.710-3.035)	9.93	99
35+35+50	2.33	2.33	3.33	-	-	8.00 (2.90-9.00)	2.250 (0.700-3.040)	9.88	99
35+35+60	2.15	2.15	3.69	-	-	8.00 (2.90-9.00)	2.220 (0.700-3.035)	9.75	99
35+35+71	1.99	1.99	4.03	-	-	8.00 (2.90-9.00)	2.200 (0.710-3.005)	9.66	99
35+42+42	2.35	2.82	2.82	-	-	8.00 (2.90-9.00)	2.240 (0.700-3.035)	9.84	99
35+42+50	2.20	2.65	3.15	-	-	8.00 (2.90-9.00)	2.230 (0.690-3.040)	9.79	99
35+42+60	2.04	2.45	3.50	-	-	8.00 (2.90-9.00)	2.200 (0.700-3.010)	9.66	99
35+50+50	2.07	2.96	2.96	-	-	8.00 (2.90-9.00)	2.220 (0.700-3.015)	9.75	99
35+50+60	1.93	2.76	3.31	-	-	8.00 (2.90-9.00)	2.190 (0.710-2.990)	9.62	99

MXZ-4D83VA COOLING

Indoor units combination	Cooling capacity (kW)						Outdoor unit power consumption(kW)	Current (A)	Power factor(%)
	Unit A	Unit B	Unit C	Unit D	Unit E	Total			
42+42+42	2.67	2.67	2.67	-	-	8.00 (2.90-9.00)	2.220 (0.690-3.040)	9.75	99
42+42+50	2.51	2.51	2.99	-	-	8.00 (2.90-9.00)	2.210 (0.700-3.015)	9.71	99
42+42+60	2.33	2.33	3.33	-	-	8.00 (2.90-9.00)	2.180 (0.710-2.990)	9.57	99
42+50+50	2.37	2.82	2.82	-	-	8.00 (2.90-9.00)	2.200 (0.710-2.995)	9.66	99
15+15+15+15	1.50	1.50	1.50	1.50	-	6.00 (3.70-6.40)	1.405 (0.930-3.195)	6.17	99
15+15+15+18	1.50	1.50	1.50	1.80	-	6.30 (3.70-7.10)	1.655 (0.900-3.195)	7.27	99
15+15+15+20	1.48	1.48	1.48	1.97	-	6.40 (3.70-7.20)	1.582 (0.930-3.265)	6.95	99
15+15+15+22	1.50	1.50	1.50	2.20	-	6.70 (3.70-7.80)	1.789 (0.900-3.195)	7.86	99
15+15+15+25	1.50	1.50	1.50	2.50	-	7.00 (3.70-8.30)	1.889 (0.900-3.195)	8.30	99
15+15+15+35	1.50	1.50	1.50	3.50	-	8.00 (3.70-8.60)	2.224 (0.900-3.195)	9.77	99
15+15+15+42	1.43	1.43	1.43	4.01	-	8.30 (3.70-8.60)	2.304 (0.900-3.185)	10.12	99
15+15+15+50	1.31	1.31	1.31	4.37	-	8.30 (3.70-8.60)	2.294 (0.900-3.175)	10.07	99
15+15+15+60	1.19	1.19	1.19	4.74	-	8.30 (3.70-8.60)	2.264 (0.900-3.165)	9.94	99
15+15+15+71	1.07	1.07	1.07	5.08	-	8.30 (3.70-8.60)	2.244 (0.900-3.155)	9.86	99
15+15+18+18	1.50	1.50	1.80	1.80	-	6.60 (3.70-7.80)	1.906 (0.870-3.195)	8.37	99
15+15+18+20	1.48	1.48	1.77	1.97	-	6.70 (3.70-7.90)	1.832 (0.900-3.265)	8.05	99
15+15+18+22	1.50	1.50	1.80	2.20	-	7.00 (3.70-8.50)	2.039 (0.870-3.195)	8.95	99
15+15+18+25	1.50	1.50	1.80	2.50	-	7.30 (3.70-8.80)	2.140 (0.870-3.195)	9.40	99
15+15+18+42	1.38	1.38	1.66	3.87	-	8.30 (3.70-8.80)	2.454 (0.870-3.185)	10.78	99
15+15+18+50	1.27	1.27	1.52	4.23	-	8.30 (3.70-8.80)	2.444 (0.870-3.175)	10.73	99
15+15+18+60	1.15	1.15	1.38	4.61	-	8.30 (3.70-8.80)	2.414 (0.870-3.165)	10.60	99
15+15+18+71	1.05	1.05	1.26	4.95	-	8.30 (3.70-8.80)	2.394 (0.870-3.155)	10.51	99
15+15+20+20	1.46	1.46	1.94	1.94	-	6.80 (3.70-8.10)	1.759 (0.930-3.335)	7.73	99
15+15+20+22	1.48	1.48	1.97	2.17	-	7.10 (3.70-8.60)	1.966 (0.900-3.265)	8.63	99
15+15+20+25	1.48	1.48	1.97	2.47	-	7.40 (3.70-8.60)	2.067 (0.900-3.265)	9.08	99
15+15+20+35	1.45	1.45	1.93	3.38	-	8.20 (3.70-8.60)	2.334 (0.900-3.265)	10.25	99
15+15+20+42	1.34	1.34	1.78	3.74	-	8.20 (3.70-8.60)	2.314 (0.900-3.255)	10.16	99
15+15+20+50	1.23	1.23	1.64	4.10	-	8.20 (3.70-8.60)	2.304 (0.900-3.245)	10.12	99
15+15+20+60	1.12	1.12	1.49	4.47	-	8.20 (3.70-8.60)	2.274 (0.900-3.235)	9.99	99
15+15+20+71	1.02	1.02	1.36	4.81	-	8.20 (3.70-8.60)	2.254 (0.900-3.225)	9.90	99
15+15+22+22	1.50	1.50	2.20	2.20	-	7.40 (3.70-8.80)	2.173 (0.870-3.195)	9.54	99
15+15+22+25	1.50	1.50	2.20	2.50	-	7.70 (3.70-8.80)	2.274 (0.870-3.195)	9.99	99
15+15+22+35	1.43	1.43	2.10	3.34	-	8.30 (3.70-8.80)	2.474 (0.870-3.195)	10.87	99
15+15+22+42	1.32	1.32	1.94	3.71	-	8.30 (3.70-8.80)	2.454 (0.870-3.185)	10.78	99
15+15+22+50	1.22	1.22	1.79	4.07	-	8.30 (3.70-8.80)	2.444 (0.870-3.175)	10.73	99
15+15+22+60	1.11	1.11	1.63	4.45	-	8.30 (3.70-8.80)	2.414 (0.870-3.165)	10.60	99
15+15+22+71	1.01	1.01	1.48	4.79	-	8.30 (3.70-8.80)	2.394 (0.870-3.155)	10.51	99
15+15+25+25	1.50	1.50	2.50	2.50	-	8.00 (3.70-8.80)	2.374 (0.870-3.195)	10.43	99
15+15+25+35	1.38	1.38	2.31	3.23	-	8.30 (3.70-8.80)	2.474 (0.870-3.195)	10.87	99
15+15+25+42	1.28	1.28	2.14	3.59	-	8.30 (3.70-8.80)	2.454 (0.870-3.185)	10.78	99
15+15+25+50	1.19	1.19	1.98	3.95	-	8.30 (3.70-8.80)	2.444 (0.870-3.175)	10.73	99

MXZ-4D83VA COOLING

Indoor units combination	Cooling capacity (kW)						Outdoor unit power consumption(kW)	Current (A)	Power factor(%)
	Unit A	Unit B	Unit C	Unit D	Unit E	Total			
15+15+25+60	1.08	1.08	1.80	4.33	-	8.30 (3.70-8.80)	2.414 (0.870-3.165)	10.60	99
15+15+25+71	0.99	0.99	1.65	4.68	-	8.30 (3.70-8.80)	2.394 (0.870-3.155)	10.51	99
15+15+35+35	1.25	1.25	2.91	2.91	-	8.30 (3.70-8.80)	2.474 (0.870-3.195)	10.87	99
15+15+35+42	1.16	1.16	2.71	3.26	-	8.30 (3.70-8.80)	2.454 (0.870-3.185)	10.78	99
15+15+35+50	1.08	1.08	2.53	3.61	-	8.30 (3.70-8.80)	2.444 (0.870-3.175)	10.73	99
15+15+35+60	1.00	1.00	2.32	3.98	-	8.30 (3.70-8.80)	2.414 (0.870-3.165)	10.60	99
15+15+35+71	0.92	0.92	2.14	4.33	-	8.30 (3.70-8.80)	2.394 (0.870-3.155)	10.51	99
15+15+42+42	1.09	1.09	3.06	3.06	-	8.30 (3.70-8.80)	2.434 (0.870-3.175)	10.69	99
15+15+42+50	1.02	1.02	2.86	3.40	-	8.30 (3.70-8.80)	2.424 (0.870-3.165)	10.65	99
15+15+42+60	0.94	0.94	2.64	3.77	-	8.30 (3.70-8.80)	2.394 (0.870-3.155)	10.51	99
15+15+42+71	0.87	0.87	2.44	4.12	-	8.30 (3.70-8.80)	2.374 (0.870-3.145)	10.43	99
15+15+50+50	0.96	0.96	3.19	3.19	-	8.30 (3.70-8.80)	2.414 (0.870-3.155)	10.60	99
15+15+50+60	0.89	0.89	2.96	3.56	-	8.30 (3.70-8.80)	2.384 (0.870-3.145)	10.47	99
15+18+18+18	1.50	1.80	1.80	1.80	-	6.90 (3.70-8.50)	2.156 (0.840-3.195)	9.47	99
15+18+18+20	1.48	1.77	1.77	1.97	-	7.00 (3.70-8.60)	2.083 (0.870-3.265)	9.15	99
15+18+18+22	1.50	1.80	1.80	2.20	-	7.30 (3.70-9.00)	2.290 (0.840-3.195)	10.06	99
15+18+18+25	1.50	1.80	1.80	2.50	-	7.60 (3.70-9.00)	2.390 (0.840-3.195)	10.50	99
15+18+18+35	1.45	1.74	1.74	3.38	-	8.30 (3.70-9.00)	2.624 (0.840-3.195)	11.52	99
15+18+18+42	1.34	1.61	1.61	3.75	-	8.30 (3.70-9.00)	2.604 (0.840-3.185)	11.44	99
15+18+18+50	1.23	1.48	1.48	4.11	-	8.30 (3.70-9.00)	2.594 (0.840-3.175)	11.39	99
15+18+18+60	1.12	1.35	1.35	4.49	-	8.30 (3.70-9.00)	2.564 (0.840-3.165)	11.26	99
15+18+18+71	1.02	1.22	1.22	4.83	-	8.30 (3.70-9.00)	2.544 (0.840-3.155)	11.17	99
15+18+20+20	1.46	1.75	1.95	1.95	-	7.10 (3.70-8.60)	2.010 (0.900-3.335)	8.83	99
15+18+20+22	1.48	1.78	1.97	2.17	-	7.40 (3.70-8.80)	2.217 (0.870-3.265)	9.74	99
15+18+20+25	1.48	1.78	1.97	2.47	-	7.70 (3.70-8.80)	2.317 (0.870-3.265)	10.18	99
15+18+20+35	1.40	1.68	1.86	3.26	-	8.20 (3.70-8.80)	2.484 (0.870-3.265)	10.91	99
15+18+20+42	1.29	1.55	1.73	3.63	-	8.20 (3.70-8.80)	2.464 (0.870-3.255)	10.82	99
15+18+20+50	1.19	1.43	1.59	3.98	-	8.20 (3.70-8.80)	2.454 (0.870-3.245)	10.78	99
15+18+20+60	1.09	1.31	1.45	4.35	-	8.20 (3.70-8.80)	2.424 (0.870-3.235)	10.65	99
15+18+20+71	0.99	1.19	1.32	4.70	-	8.20 (3.70-8.80)	2.404 (0.870-3.225)	10.56	99
15+18+22+22	1.50	1.80	2.20	2.20	-	7.70 (3.70-9.00)	2.424 (0.840-3.195)	10.65	99
15+18+22+25	1.50	1.80	2.20	2.50	-	8.00 (3.70-9.00)	2.524 (0.840-3.195)	11.08	99
15+18+22+35	1.38	1.66	2.03	3.23	-	8.30 (3.70-9.00)	2.624 (0.840-3.195)	11.52	99
15+18+22+42	1.28	1.54	1.88	3.59	-	8.30 (3.70-9.00)	2.604 (0.840-3.185)	11.44	99
15+18+22+50	1.19	1.42	1.74	3.95	-	8.30 (3.70-9.00)	2.594 (0.840-3.175)	11.39	99
15+18+22+60	1.08	1.30	1.59	4.33	-	8.30 (3.70-9.00)	2.564 (0.840-3.165)	11.26	99
15+18+22+71	0.99	1.19	1.45	4.68	-	8.30 (3.70-9.00)	2.544 (0.840-3.155)	11.17	99
15+18+25+35	1.34	1.61	2.23	3.12	-	8.30 (3.70-9.00)	2.624 (0.840-3.195)	11.52	99
15+18+25+42	1.25	1.49	2.08	3.49	-	8.30 (3.70-9.00)	2.604 (0.840-3.185)	11.44	99
15+18+25+50	1.15	1.38	1.92	3.84	-	8.30 (3.70-9.00)	2.594 (0.840-3.175)	11.39	99
15+18+25+60	1.06	1.27	1.76	4.22	-	8.30 (3.70-9.00)	2.564 (0.840-3.165)	11.26	99

MXZ-4D83VA COOLING

Indoor units combination	Cooling capacity (kW)						Outdoor unit power consumption(kW)	Current (A)	Power factor(%)
	Unit A	Unit B	Unit C	Unit D	Unit E	Total			
15+18+25+71	0.97	1.16	1.61	4.57	-	8.30 (3.70-9.00)	2.544 (0.840-3.155)	11.17	99
15+18+35+35	1.21	1.45	2.82	2.82	-	8.30 (3.70-9.00)	2.624 (0.840-3.195)	11.52	99
15+18+35+42	1.13	1.36	2.64	3.17	-	8.30 (3.70-9.00)	2.604 (0.840-3.185)	11.44	99
15+18+35+50	1.06	1.27	2.46	3.52	-	8.30 (3.70-9.00)	2.594 (0.840-3.175)	11.39	99
15+18+35+60	0.97	1.17	2.27	3.89	-	8.30 (3.70-9.00)	2.564 (0.840-3.165)	11.26	99
15+18+35+71	0.90	1.07	2.09	4.24	-	8.30 (3.70-9.00)	2.544 (0.840-3.155)	11.17	99
15+18+42+42	1.06	1.28	2.98	2.98	-	8.30 (3.70-9.00)	2.584 (0.840-3.175)	11.35	99
15+18+42+50	1.00	1.20	2.79	3.32	-	8.30 (3.70-9.00)	2.574 (0.840-3.165)	11.30	99
15+18+42+60	0.92	1.11	2.58	3.69	-	8.30 (3.70-9.00)	2.544 (0.840-3.155)	11.17	99
15+18+50+50	0.94	1.12	3.12	3.12	-	8.30 (3.70-9.00)	2.564 (0.840-3.155)	11.26	99
15+18+50+60	0.87	1.04	2.90	3.48	-	8.30 (3.70-9.00)	2.534 (0.840-3.145)	11.13	99
15+20+20+20	1.44	1.92	1.92	1.92	-	7.20 (3.70-8.40)	1.937 (0.930-3.405)	8.51	99
15+20+20+22	1.46	1.95	1.95	2.14	-	7.50 (3.70-8.60)	2.144 (0.900-3.335)	9.42	99
15+20+20+25	1.46	1.95	1.95	2.44	-	7.80 (3.70-8.60)	2.244 (0.900-3.335)	9.86	99
15+20+20+35	1.35	1.80	1.80	3.15	-	8.10 (3.70-8.60)	2.344 (0.900-3.335)	10.29	99
15+20+20+42	1.25	1.67	1.67	3.51	-	8.10 (3.70-8.60)	2.324 (0.900-3.325)	10.21	99
15+20+20+50	1.16	1.54	1.54	3.86	-	8.10 (3.70-8.60)	2.314 (0.900-3.315)	10.16	99
15+20+20+60	1.06	1.41	1.41	4.23	-	8.10 (3.70-8.60)	2.284 (0.900-3.305)	10.03	99
15+20+20+71	0.96	1.29	1.29	4.56	-	8.10 (3.70-8.60)	2.264 (0.900-3.295)	9.94	99
15+20+22+22	1.48	1.97	2.17	2.17	-	7.80 (3.70-8.80)	2.351 (0.870-3.265)	10.32	99
15+20+22+25	1.48	1.98	2.17	2.47	-	8.10 (3.70-8.80)	2.451 (0.870-3.265)	10.76	99
15+20+22+35	1.34	1.78	1.96	3.12	-	8.20 (3.70-8.80)	2.484 (0.870-3.265)	10.91	99
15+20+22+42	1.24	1.66	1.82	3.48	-	8.20 (3.70-8.80)	2.464 (0.870-3.255)	10.82	99
15+20+22+50	1.15	1.53	1.69	3.83	-	8.20 (3.70-8.80)	2.454 (0.870-3.245)	10.78	99
15+20+22+60	1.05	1.40	1.54	4.21	-	8.20 (3.70-8.80)	2.424 (0.870-3.235)	10.65	99
15+20+22+71	0.96	1.28	1.41	4.55	-	8.20 (3.70-8.80)	2.404 (0.870-3.225)	10.56	99
15+20+25+25	1.45	1.93	2.41	2.41	-	8.20 (3.70-8.80)	2.484 (0.870-3.265)	10.91	99
15+20+25+35	1.29	1.73	2.16	3.02	-	8.20 (3.70-8.80)	2.484 (0.870-3.265)	10.91	99
15+20+25+42	1.21	1.61	2.01	3.38	-	8.20 (3.70-8.80)	2.464 (0.870-3.255)	10.82	99
15+20+25+50	1.12	1.49	1.86	3.73	-	8.20 (3.70-8.80)	2.454 (0.870-3.245)	10.78	99
15+20+25+60	1.03	1.37	1.71	4.10	-	8.20 (3.70-8.80)	2.424 (0.870-3.235)	10.65	99
15+20+25+71	0.94	1.25	1.56	4.44	-	8.20 (3.70-8.80)	2.404 (0.870-3.225)	10.56	99
15+20+35+35	1.17	1.56	2.73	2.73	-	8.20 (3.70-8.80)	2.484 (0.870-3.265)	10.91	99
15+20+35+42	1.10	1.46	2.56	3.08	-	8.20 (3.70-8.80)	2.464 (0.870-3.255)	10.82	99
15+20+35+50	1.03	1.37	2.39	3.42	-	8.20 (3.70-8.80)	2.454 (0.870-3.245)	10.78	99
15+20+35+60	0.95	1.26	2.21	3.78	-	8.20 (3.70-8.80)	2.424 (0.870-3.235)	10.65	99
15+20+35+71	0.87	1.16	2.04	4.13	-	8.20 (3.70-8.80)	2.404 (0.870-3.225)	10.56	99
15+20+42+42	1.03	1.38	2.89	2.89	-	8.20 (3.70-8.80)	2.444 (0.870-3.245)	10.73	99
15+20+42+50	0.97	1.29	2.71	3.23	-	8.20 (3.70-8.80)	2.434 (0.870-3.235)	10.69	99
15+20+42+60	0.90	1.20	2.51	3.59	-	8.20 (3.70-8.80)	2.404 (0.870-3.225)	10.56	99
15+20+50+50	0.91	1.21	3.04	3.04	-	8.20 (3.70-8.80)	2.424 (0.870-3.225)	10.65	99

MXZ-4D83VA COOLING

Indoor units combination	Cooling capacity (kW)						Outdoor unit power consumption(kW)	Current (A)	Power factor(%)
	Unit A	Unit B	Unit C	Unit D	Unit E	Total			
15+20+50+60	0.85	1.13	2.83	3.39	-	8.20 (3.70-8.80)	2.394 (0.870-3.215)	10.51	99
15+22+22+22	1.50	2.20	2.20	2.20	-	8.10 (3.70-9.00)	2.557 (0.840-3.195)	11.23	99
15+22+22+25	1.48	2.17	2.17	2.47	-	8.30 (3.70-9.00)	2.624 (0.840-3.195)	11.52	99
15+22+22+35	1.32	1.94	1.94	3.09	-	8.30 (3.70-9.00)	2.624 (0.840-3.195)	11.52	99
15+22+22+42	1.23	1.81	1.81	3.45	-	8.30 (3.70-9.00)	2.604 (0.840-3.185)	11.44	99
15+22+22+50	1.14	1.68	1.68	3.81	-	8.30 (3.70-9.00)	2.594 (0.840-3.175)	11.39	99
15+22+22+60	1.05	1.53	1.53	4.18	-	8.30 (3.70-9.00)	2.564 (0.840-3.165)	11.26	99
15+22+22+71	0.96	1.40	1.40	4.53	-	8.30 (3.70-9.00)	2.544 (0.840-3.155)	11.17	99
15+22+25+25	1.43	2.10	2.39	2.39	-	8.30 (3.70-9.00)	2.624 (0.840-3.195)	11.52	99
15+22+25+35	1.28	1.88	2.14	2.99	-	8.30 (3.70-9.00)	2.624 (0.840-3.195)	11.52	99
15+22+25+42	1.20	1.76	2.00	3.35	-	8.30 (3.70-9.00)	2.604 (0.840-3.185)	11.44	99
15+22+25+50	1.11	1.63	1.85	3.71	-	8.30 (3.70-9.00)	2.594 (0.840-3.175)	11.39	99
15+22+25+60	1.02	1.50	1.70	4.08	-	8.30 (3.70-9.00)	2.564 (0.840-3.165)	11.26	99
15+22+25+71	0.94	1.37	1.56	4.43	-	8.30 (3.70-9.00)	2.544 (0.840-3.155)	11.17	99
15+22+35+35	1.16	1.71	2.71	2.71	-	8.30 (3.70-9.00)	2.624 (0.840-3.195)	11.52	99
15+22+35+42	1.09	1.60	2.55	3.06	-	8.30 (3.70-9.00)	2.604 (0.840-3.185)	11.44	99
15+22+35+50	1.02	1.50	2.38	3.40	-	8.30 (3.70-9.00)	2.594 (0.840-3.175)	11.39	99
15+22+35+60	0.94	1.38	2.20	3.77	-	8.30 (3.70-9.00)	2.564 (0.840-3.165)	11.26	99
15+22+35+71	0.87	1.28	2.03	4.12	-	8.30 (3.70-9.00)	2.544 (0.840-3.155)	11.17	99
15+22+42+42	1.03	1.51	2.88	2.88	-	8.30 (3.70-9.00)	2.584 (0.840-3.175)	11.35	99
15+22+42+50	0.97	1.42	2.70	3.22	-	8.30 (3.70-9.00)	2.574 (0.840-3.165)	11.30	99
15+22+42+60	0.90	1.31	2.51	3.58	-	8.30 (3.70-9.00)	2.544 (0.840-3.155)	11.17	99
15+22+50+50	0.91	1.33	3.03	3.03	-	8.30 (3.70-9.00)	2.564 (0.840-3.155)	11.26	99
15+25+25+25	1.38	2.31	2.31	2.31	-	8.30 (3.70-9.00)	2.624 (0.840-3.195)	11.52	99
15+25+25+35	1.25	2.08	2.08	2.91	-	8.30 (3.70-9.00)	2.624 (0.840-3.195)	11.52	99
15+25+25+42	1.16	1.94	1.94	3.26	-	8.30 (3.70-9.00)	2.604 (0.840-3.185)	11.44	99
15+25+25+50	1.08	1.80	1.80	3.61	-	8.30 (3.70-9.00)	2.594 (0.840-3.175)	11.39	99
15+25+25+60	1.00	1.66	1.66	3.98	-	8.30 (3.70-9.00)	2.564 (0.840-3.165)	11.26	99
15+25+25+71	0.92	1.53	1.53	4.33	-	8.30 (3.70-9.00)	2.544 (0.840-3.155)	11.17	99
15+25+35+35	1.13	1.89	2.64	2.64	-	8.30 (3.70-9.00)	2.624 (0.840-3.195)	11.52	99
15+25+35+42	1.06	1.77	2.48	2.98	-	8.30 (3.70-9.00)	2.604 (0.840-3.185)	11.44	99
15+25+35+50	1.00	1.66	2.32	3.32	-	8.30 (3.70-9.00)	2.594 (0.840-3.175)	11.39	99
15+25+35+60	0.92	1.54	2.15	3.69	-	8.30 (3.70-9.00)	2.564 (0.840-3.165)	11.26	99
15+25+42+42	1.00	1.67	2.81	2.81	-	8.30 (3.70-9.00)	2.584 (0.840-3.175)	11.35	99
15+25+42+50	0.94	1.57	2.64	3.14	-	8.30 (3.70-9.00)	2.574 (0.840-3.165)	11.30	99
15+25+42+60	0.88	1.46	2.45	3.51	-	8.30 (3.70-9.00)	2.544 (0.840-3.155)	11.17	99
15+25+50+50	0.89	1.48	2.96	2.96	-	8.30 (3.70-9.00)	2.564 (0.840-3.155)	11.26	99
15+35+35+35	1.04	2.42	2.42	2.42	-	8.30 (3.70-9.00)	2.624 (0.840-3.195)	11.52	99
15+35+35+42	0.98	2.29	2.29	2.74	-	8.30 (3.70-9.00)	2.604 (0.840-3.185)	11.44	99
15+35+35+50	0.92	2.15	2.15	3.07	-	8.30 (3.70-9.00)	2.594 (0.840-3.175)	11.39	99
15+35+35+60	0.86	2.00	2.00	3.43	-	8.30 (3.70-9.00)	2.564 (0.840-3.165)	11.26	99

MXZ-4D83VA COOLING

Indoor units combination	Cooling capacity (kW)						Outdoor unit power consumption(kW)	Current (A)	Power factor(%)
	Unit A	Unit B	Unit C	Unit D	Unit E	Total			
15+35+42+42	0.93	2.17	2.60	2.60	-	8.30 (3.70-9.00)	2.584 (0.840-3.175)	11.35	99
15+35+42+50	0.88	2.05	2.45	2.92	-	8.30 (3.70-9.00)	2.574 (0.840-3.165)	11.30	99
15+42+42+42	0.88	2.47	2.47	2.47	-	8.30 (3.70-9.00)	2.564 (0.840-3.165)	11.26	99
18+18+18+18	1.80	1.80	1.80	1.80	-	7.20 (3.70-9.20)	2.406 (0.810-3.195)	10.57	99
18+18+18+20	1.78	1.78	1.78	1.97	-	7.30 (3.70-9.00)	2.333 (0.840-3.265)	10.25	99
18+18+18+22	1.80	1.80	1.80	2.20	-	7.60 (3.70-9.20)	2.540 (0.810-3.195)	11.16	99
18+18+18+25	1.80	1.80	1.80	2.50	-	7.90 (3.70-9.20)	2.641 (0.810-3.195)	11.60	99
18+18+18+35	1.68	1.68	1.68	3.26	-	8.30 (3.70-9.20)	2.774 (0.810-3.195)	12.18	99
18+18+18+42	1.56	1.56	1.56	3.63	-	8.30 (3.70-9.20)	2.754 (0.810-3.185)	12.09	99
18+18+18+50	1.44	1.44	1.44	3.99	-	8.30 (3.70-9.20)	2.744 (0.810-3.175)	12.05	99
18+18+18+60	1.31	1.31	1.31	4.37	-	8.30 (3.70-9.20)	2.714 (0.810-3.165)	11.92	99
18+18+18+71	1.20	1.20	1.20	4.71	-	8.30 (3.70-9.20)	2.694 (0.810-3.155)	11.83	99
18+18+20+20	1.75	1.75	1.95	1.95	-	7.40 (3.70-8.80)	2.260 (0.870-3.335)	9.93	99
18+18+20+22	1.78	1.78	1.97	2.17	-	7.70 (3.70-9.00)	2.467 (0.840-3.265)	10.83	99
18+18+20+25	1.78	1.78	1.98	2.47	-	8.00 (3.70-9.00)	2.567 (0.840-3.265)	11.27	99
18+18+20+35	1.62	1.62	1.80	3.15	-	8.20 (3.70-9.00)	2.634 (0.840-3.265)	11.57	99
18+18+20+42	1.51	1.51	1.67	3.51	-	8.20 (3.70-9.00)	2.614 (0.840-3.255)	11.48	99
18+18+20+50	1.39	1.39	1.55	3.87	-	8.20 (3.70-9.00)	2.604 (0.840-3.245)	11.44	99
18+18+20+60	1.27	1.27	1.41	4.24	-	8.20 (3.70-9.00)	2.574 (0.840-3.235)	11.30	99
18+18+20+71	1.16	1.16	1.29	4.58	-	8.20 (3.70-9.00)	2.554 (0.840-3.225)	11.22	99
18+18+22+22	1.80	1.80	2.20	2.20	-	8.00 (3.70-9.20)	2.674 (0.810-3.195)	11.74	99
18+18+22+25	1.80	1.80	2.20	2.50	-	8.30 (3.70-9.20)	2.774 (0.810-3.195)	12.18	99
18+18+22+35	1.61	1.61	1.96	3.12	-	8.30 (3.70-9.20)	2.774 (0.810-3.195)	12.18	99
18+18+22+42	1.49	1.49	1.83	3.49	-	8.30 (3.70-9.20)	2.754 (0.810-3.185)	12.09	99
18+18+22+50	1.38	1.38	1.69	3.84	-	8.30 (3.70-9.20)	2.744 (0.810-3.175)	12.05	99
18+18+22+60	1.27	1.27	1.55	4.22	-	8.30 (3.70-9.20)	2.714 (0.810-3.165)	11.92	99
18+18+22+71	1.16	1.16	1.42	4.57	-	8.30 (3.70-9.20)	2.694 (0.810-3.155)	11.83	99
18+18+25+25	1.74	1.74	2.41	2.41	-	8.30 (3.70-9.20)	2.774 (0.810-3.195)	12.18	99
18+18+25+35	1.56	1.56	2.16	3.03	-	8.30 (3.70-9.20)	2.774 (0.810-3.195)	12.18	99
18+18+25+42	1.45	1.45	2.01	3.38	-	8.30 (3.70-9.20)	2.754 (0.810-3.185)	12.09	99
18+18+25+50	1.35	1.35	1.87	3.74	-	8.30 (3.70-9.20)	2.744 (0.810-3.175)	12.05	99
18+18+25+60	1.23	1.23	1.71	4.12	-	8.30 (3.70-9.20)	2.714 (0.810-3.165)	11.92	99
18+18+25+71	1.13	1.13	1.57	4.46	-	8.30 (3.70-9.20)	2.694 (0.810-3.155)	11.83	99
18+18+35+35	1.41	1.41	2.74	2.74	-	8.30 (3.70-9.20)	2.774 (0.810-3.195)	12.18	99
18+18+35+42	1.32	1.32	2.57	3.08	-	8.30 (3.70-9.20)	2.754 (0.810-3.185)	12.09	99
18+18+35+50	1.23	1.23	2.40	3.43	-	8.30 (3.70-9.20)	2.744 (0.810-3.175)	12.05	99
18+18+35+60	1.14	1.14	2.22	3.80	-	8.30 (3.70-9.20)	2.714 (0.810-3.165)	11.92	99
18+18+35+71	1.05	1.05	2.05	4.15	-	8.30 (3.70-9.20)	2.694 (0.810-3.155)	11.83	99
18+18+42+42	1.25	1.25	2.91	2.91	-	8.30 (3.70-9.20)	2.734 (0.810-3.175)	12.01	99
18+18+42+50	1.17	1.17	2.72	3.24	-	8.30 (3.70-9.20)	2.724 (0.810-3.165)	11.96	99
18+18+42+60	1.08	1.08	2.53	3.61	-	8.30 (3.70-9.20)	2.694 (0.810-3.155)	11.83	99

MXZ-4D83VA COOLING

Indoor units combination	Cooling capacity (kW)						Outdoor unit power consumption(kW)	Current (A)	Power factor(%)
	Unit A	Unit B	Unit C	Unit D	Unit E	Total			
18+18+50+50	1.10	1.10	3.05	3.05	-	8.30 (3.70-9.20)	2.714 (0.810-3.155)	11.92	99
18+20+20+20	1.73	1.92	1.92	1.92	-	7.50 (3.70-8.60)	2.187 (0.900-3.405)	9.60	99
18+20+20+22	1.76	1.95	1.95	2.15	-	7.80 (3.70-8.80)	2.394 (0.870-3.335)	10.51	99
18+20+20+35	1.57	1.74	1.74	3.05	-	8.10 (3.70-8.80)	2.494 (0.870-3.335)	10.95	99
18+20+20+42	1.46	1.62	1.62	3.40	-	8.10 (3.70-8.80)	2.474 (0.870-3.325)	10.87	99
18+20+20+50	1.35	1.50	1.50	3.75	-	8.10 (3.70-8.80)	2.464 (0.870-3.315)	10.82	99
18+20+20+60	1.24	1.37	1.37	4.12	-	8.10 (3.70-8.80)	2.434 (0.870-3.305)	10.69	99
18+20+20+71	1.13	1.26	1.26	4.46	-	8.10 (3.70-8.80)	2.414 (0.870-3.295)	10.60	99
18+20+22+22	1.78	1.98	2.17	2.17	-	8.10 (3.70-9.00)	2.601 (0.840-3.265)	11.42	99
18+20+22+25	1.74	1.93	2.12	2.41	-	8.20 (3.70-9.00)	2.634 (0.840-3.265)	11.57	99
18+20+22+35	1.55	1.73	1.90	3.02	-	8.20 (3.70-9.00)	2.634 (0.840-3.265)	11.57	99
18+20+22+42	1.45	1.61	1.77	3.38	-	8.20 (3.70-9.00)	2.614 (0.840-3.255)	11.48	99
18+20+22+50	1.34	1.49	1.64	3.73	-	8.20 (3.70-9.00)	2.604 (0.840-3.245)	11.44	99
18+20+22+60	1.23	1.37	1.50	4.10	-	8.20 (3.70-9.00)	2.574 (0.840-3.235)	11.30	99
18+20+22+71	1.13	1.25	1.38	4.44	-	8.20 (3.70-9.00)	2.554 (0.840-3.225)	11.22	99
18+20+25+25	1.68	1.86	2.33	2.33	-	8.20 (3.70-9.00)	2.634 (0.840-3.265)	11.57	99
18+20+25+35	1.51	1.67	2.09	2.93	-	8.20 (3.70-9.00)	2.634 (0.840-3.265)	11.57	99
18+20+25+42	1.41	1.56	1.95	3.28	-	8.20 (3.70-9.00)	2.614 (0.840-3.255)	11.48	99
18+20+25+50	1.31	1.45	1.81	3.63	-	8.20 (3.70-9.00)	2.604 (0.840-3.245)	11.44	99
18+20+25+60	1.20	1.33	1.67	4.00	-	8.20 (3.70-9.00)	2.574 (0.840-3.235)	11.30	99
18+20+25+71	1.10	1.22	1.53	4.34	-	8.20 (3.70-9.00)	2.554 (0.840-3.225)	11.22	99
18+20+35+35	1.37	1.52	2.66	2.66	-	8.20 (3.70-9.00)	2.634 (0.840-3.265)	11.57	99
18+20+35+42	1.28	1.43	2.50	2.99	-	8.20 (3.70-9.00)	2.614 (0.840-3.255)	11.48	99
18+20+35+50	1.20	1.33	2.33	3.33	-	8.20 (3.70-9.00)	2.604 (0.840-3.245)	11.44	99
18+20+35+60	1.11	1.23	2.16	3.70	-	8.20 (3.70-9.00)	2.574 (0.840-3.235)	11.30	99
18+20+35+71	1.03	1.14	1.99	4.04	-	8.20 (3.70-9.00)	2.554 (0.840-3.225)	11.22	99
18+20+42+42	1.21	1.34	2.82	2.82	-	8.20 (3.70-9.00)	2.594 (0.840-3.245)	11.39	99
18+20+42+50	1.14	1.26	2.65	3.15	-	8.20 (3.70-9.00)	2.584 (0.840-3.235)	11.35	99
18+20+42+60	1.05	1.17	2.46	3.51	-	8.20 (3.70-9.00)	2.554 (0.840-3.225)	11.22	99
18+20+50+50	1.07	1.19	2.97	2.97	-	8.20 (3.70-9.00)	2.574 (0.840-3.225)	11.30	99
18+22+22+22	1.78	2.17	2.17	2.17	-	8.30 (3.70-9.20)	2.774 (0.810-3.195)	12.18	99
18+22+22+25	1.72	2.10	2.10	2.39	-	8.30 (3.70-9.20)	2.774 (0.810-3.195)	12.18	99
18+22+22+35	1.54	1.88	1.88	2.99	-	8.30 (3.70-9.20)	2.774 (0.810-3.195)	12.18	99
18+22+22+42	1.44	1.76	1.76	3.35	-	8.30 (3.70-9.20)	2.754 (0.810-3.185)	12.09	99
18+22+22+50	1.33	1.63	1.63	3.71	-	8.30 (3.70-9.20)	2.744 (0.810-3.175)	12.05	99
18+22+22+60	1.22	1.50	1.50	4.08	-	8.30 (3.70-9.20)	2.714 (0.810-3.165)	11.92	99
18+22+22+71	1.12	1.37	1.37	4.43	-	8.30 (3.70-9.20)	2.694 (0.810-3.155)	11.83	99
18+22+25+25	1.66	2.03	2.31	2.31	-	8.30 (3.70-9.20)	2.774 (0.810-3.195)	12.18	99
18+22+25+35	1.49	1.83	2.08	2.91	-	8.30 (3.70-9.20)	2.774 (0.810-3.195)	12.18	99
18+22+25+42	1.40	1.71	1.94	3.26	-	8.30 (3.70-9.20)	2.754 (0.810-3.185)	12.09	99
18+22+25+50	1.30	1.59	1.80	3.61	-	8.30 (3.70-9.20)	2.744 (0.810-3.175)	12.05	99

MXZ-4D83VA COOLING

Indoor units combination	Cooling capacity (kW)						Outdoor unit power consumption(kW)	Current (A)	Power factor(%)
	Unit A	Unit B	Unit C	Unit D	Unit E	Total			
18+22+25+60	1.20	1.46	1.66	3.98	-	8.30 (3.70-9.20)	2.714 (0.810-3.165)	11.92	99
18+22+25+71	1.10	1.34	1.53	4.33	-	8.30 (3.70-9.20)	2.694 (0.810-3.155)	11.83	99
18+22+35+35	1.36	1.66	2.64	2.64	-	8.30 (3.70-9.20)	2.774 (0.810-3.195)	12.18	99
18+22+35+42	1.28	1.56	2.48	2.98	-	8.30 (3.70-9.20)	2.754 (0.810-3.185)	12.09	99
18+22+35+50	1.20	1.46	2.32	3.32	-	8.30 (3.70-9.20)	2.744 (0.810-3.175)	12.05	99
18+22+35+60	1.11	1.35	2.15	3.69	-	8.30 (3.70-9.20)	2.714 (0.810-3.165)	11.92	99
18+22+42+42	1.20	1.47	2.81	2.81	-	8.30 (3.70-9.20)	2.734 (0.810-3.175)	12.01	99
18+22+42+50	1.13	1.38	2.64	3.14	-	8.30 (3.70-9.20)	2.724 (0.810-3.165)	11.96	99
18+22+42+60	1.05	1.29	2.45	3.51	-	8.30 (3.70-9.20)	2.694 (0.810-3.155)	11.83	99
18+22+50+50	1.07	1.30	2.96	2.96	-	8.30 (3.70-9.20)	2.714 (0.810-3.155)	11.92	99
18+25+25+25	1.61	2.23	2.23	2.23	-	8.30 (3.70-9.20)	2.774 (0.810-3.195)	12.18	99
18+25+25+35	1.45	2.01	2.01	2.82	-	8.30 (3.70-9.20)	2.774 (0.810-3.195)	12.18	99
18+25+25+42	1.36	1.89	1.89	3.17	-	8.30 (3.70-9.20)	2.754 (0.810-3.185)	12.09	99
18+25+25+50	1.27	1.76	1.76	3.52	-	8.30 (3.70-9.20)	2.744 (0.810-3.175)	12.05	99
18+25+25+60	1.17	1.62	1.62	3.89	-	8.30 (3.70-9.20)	2.714 (0.810-3.165)	11.92	99
18+25+25+71	1.07	1.49	1.49	4.24	-	8.30 (3.70-9.20)	2.694 (0.810-3.155)	11.83	99
18+25+35+35	1.32	1.84	2.57	2.57	-	8.30 (3.70-9.20)	2.774 (0.810-3.195)	12.18	99
18+25+35+42	1.25	1.73	2.42	2.91	-	8.30 (3.70-9.20)	2.754 (0.810-3.185)	12.09	99
18+25+35+50	1.17	1.62	2.27	3.24	-	8.30 (3.70-9.20)	2.744 (0.810-3.175)	12.05	99
18+25+35+60	1.08	1.50	2.11	3.61	-	8.30 (3.70-9.20)	2.714 (0.810-3.165)	11.92	99
18+25+42+42	1.18	1.63	2.74	2.74	-	8.30 (3.70-9.20)	2.734 (0.810-3.175)	12.01	99
18+25+42+50	1.11	1.54	2.58	3.07	-	8.30 (3.70-9.20)	2.724 (0.810-3.165)	11.96	99
18+25+42+60	1.03	1.43	2.40	3.43	-	8.30 (3.70-9.20)	2.694 (0.810-3.155)	11.83	99
18+25+50+50	1.04	1.45	2.90	2.90	-	8.30 (3.70-9.20)	2.714 (0.810-3.155)	11.92	99
18+35+35+35	1.21	2.36	2.36	2.36	-	8.30 (3.70-9.20)	2.774 (0.810-3.195)	12.18	99
18+35+35+42	1.15	2.23	2.23	2.68	-	8.30 (3.70-9.20)	2.754 (0.810-3.185)	12.09	99
18+35+35+50	1.08	2.11	2.11	3.01	-	8.30 (3.70-9.20)	2.744 (0.810-3.175)	12.05	99
18+35+42+42	1.09	2.12	2.54	2.54	-	8.30 (3.70-9.20)	2.734 (0.810-3.175)	12.01	99
18+35+42+50	1.03	2.00	2.40	2.86	-	8.30 (3.70-9.20)	2.724 (0.810-3.165)	11.96	99
18+42+42+42	1.04	2.42	2.42	2.42	-	8.30 (3.70-9.20)	2.714 (0.810-3.165)	11.92	99
20+20+20+20	1.90	1.90	1.90	1.90	-	7.60 (3.70-8.40)	2.114 (0.930-3.475)	9.28	99
20+20+20+22	1.93	1.93	1.93	2.12	-	7.90 (3.70-8.60)	2.321 (0.900-3.405)	10.19	99
20+20+20+25	1.88	1.88	1.88	2.35	-	8.00 (3.70-8.60)	2.354 (0.900-3.405)	10.34	99
20+20+20+35	1.68	1.68	1.68	2.95	-	8.00 (3.70-8.60)	2.354 (0.900-3.405)	10.34	99
20+20+20+42	1.57	1.57	1.57	3.29	-	8.00 (3.70-8.60)	2.334 (0.900-3.395)	10.25	99
20+20+20+50	1.45	1.45	1.45	3.64	-	8.00 (3.70-8.60)	2.324 (0.900-3.385)	10.21	99
20+20+20+60	1.33	1.33	1.33	4.00	-	8.00 (3.70-8.60)	2.294 (0.900-3.375)	10.07	99
20+20+20+71	1.22	1.22	1.22	4.34	-	8.00 (3.70-8.60)	2.274 (0.900-3.365)	9.99	99
20+20+22+22	1.93	1.93	2.12	2.12	-	8.10 (3.70-8.80)	2.494 (0.870-3.335)	10.95	99
20+20+22+25	1.86	1.86	2.05	2.33	-	8.10 (3.70-8.80)	2.494 (0.870-3.335)	10.95	99
20+20+22+35	1.67	1.67	1.84	2.92	-	8.10 (3.70-8.80)	2.494 (0.870-3.335)	10.95	99

MXZ-4D83VA COOLING

Indoor units combination	Cooling capacity (kW)						Outdoor unit power consumption(kW)	Current (A)	Power factor(%)
	Unit A	Unit B	Unit C	Unit D	Unit E	Total			
20+20+22+42	1.56	1.56	1.71	3.27	-	8.10 (3.70-8.80)	2.474 (0.870-3.325)	10.87	99
20+20+22+50	1.45	1.45	1.59	3.62	-	8.10 (3.70-8.80)	2.464 (0.870-3.315)	10.82	99
20+20+22+60	1.33	1.33	1.46	3.98	-	8.10 (3.70-8.80)	2.434 (0.870-3.305)	10.69	99
20+20+22+71	1.22	1.22	1.34	4.32	-	8.10 (3.70-8.80)	2.414 (0.870-3.295)	10.60	99
20+20+25+25	1.80	1.80	2.25	2.25	-	8.10 (3.70-8.80)	2.494 (0.870-3.335)	10.95	99
20+20+25+35	1.62	1.62	2.03	2.84	-	8.10 (3.70-8.80)	2.494 (0.870-3.335)	10.95	99
20+20+25+42	1.51	1.51	1.89	3.18	-	8.10 (3.70-8.80)	2.474 (0.870-3.325)	10.87	99
20+20+25+50	1.41	1.41	1.76	3.52	-	8.10 (3.70-8.80)	2.464 (0.870-3.315)	10.82	99
20+20+25+60	1.30	1.30	1.62	3.89	-	8.10 (3.70-8.80)	2.434 (0.870-3.305)	10.69	99
20+20+25+71	1.19	1.19	1.49	4.23	-	8.10 (3.70-8.80)	2.414 (0.870-3.295)	10.60	99
20+20+35+35	1.47	1.47	2.58	2.58	-	8.10 (3.70-8.80)	2.494 (0.870-3.335)	10.95	99
20+20+35+42	1.38	1.38	2.42	2.91	-	8.10 (3.70-8.80)	2.474 (0.870-3.325)	10.87	99
20+20+35+50	1.30	1.30	2.27	3.24	-	8.10 (3.70-8.80)	2.464 (0.870-3.315)	10.82	99
20+20+35+60	1.20	1.20	2.10	3.60	-	8.10 (3.70-8.80)	2.434 (0.870-3.305)	10.69	99
20+20+42+42	1.31	1.31	2.74	2.74	-	8.10 (3.70-8.80)	2.454 (0.870-3.315)	10.78	99
20+20+42+50	1.23	1.23	2.58	3.07	-	8.10 (3.70-8.80)	2.444 (0.870-3.305)	10.73	99
20+20+42+60	1.14	1.14	2.40	3.42	-	8.10 (3.70-8.80)	2.414 (0.870-3.295)	10.60	99
20+20+50+50	1.16	1.16	2.89	2.89	-	8.10 (3.70-8.80)	2.434 (0.870-3.295)	10.69	99
20+22+22+22	1.91	2.10	2.10	2.10	-	8.20 (3.70-9.00)	2.634 (0.840-3.265)	11.57	99
20+22+22+25	1.84	2.03	2.03	2.30	-	8.20 (3.70-9.00)	2.634 (0.840-3.265)	11.57	99
20+22+22+35	1.66	1.82	1.82	2.90	-	8.20 (3.70-9.00)	2.634 (0.840-3.265)	11.57	99
20+22+22+42	1.55	1.70	1.70	3.25	-	8.20 (3.70-9.00)	2.614 (0.840-3.255)	11.48	99
20+22+22+50	1.44	1.58	1.58	3.60	-	8.20 (3.70-9.00)	2.604 (0.840-3.245)	11.44	99
20+22+22+60	1.32	1.45	1.45	3.97	-	8.20 (3.70-9.00)	2.574 (0.840-3.235)	11.30	99
20+22+22+71	1.21	1.34	1.34	4.31	-	8.20 (3.70-9.00)	2.554 (0.840-3.225)	11.22	99
20+22+25+25	1.78	1.96	2.23	2.23	-	8.20 (3.70-9.00)	2.634 (0.840-3.265)	11.57	99
20+22+25+35	1.61	1.77	2.01	2.81	-	8.20 (3.70-9.00)	2.634 (0.840-3.265)	11.57	99
20+22+25+42	1.50	1.66	1.88	3.16	-	8.20 (3.70-9.00)	2.614 (0.840-3.255)	11.48	99
20+22+25+50	1.40	1.54	1.75	3.50	-	8.20 (3.70-9.00)	2.604 (0.840-3.245)	11.44	99
20+22+25+60	1.29	1.42	1.61	3.87	-	8.20 (3.70-9.00)	2.574 (0.840-3.235)	11.30	99
20+22+25+71	1.19	1.31	1.49	4.22	-	8.20 (3.70-9.00)	2.554 (0.840-3.225)	11.22	99
20+22+35+35	1.46	1.61	2.56	2.56	-	8.20 (3.70-9.00)	2.634 (0.840-3.265)	11.57	99
20+22+35+42	1.38	1.52	2.41	2.89	-	8.20 (3.70-9.00)	2.614 (0.840-3.255)	11.48	99
20+22+35+50	1.29	1.42	2.26	3.23	-	8.20 (3.70-9.00)	2.604 (0.840-3.245)	11.44	99
20+22+35+60	1.20	1.32	2.09	3.59	-	8.20 (3.70-9.00)	2.574 (0.840-3.235)	11.30	99
20+22+42+42	1.30	1.43	2.73	2.73	-	8.20 (3.70-9.00)	2.594 (0.840-3.245)	11.39	99
20+22+42+50	1.22	1.35	2.57	3.06	-	8.20 (3.70-9.00)	2.584 (0.840-3.235)	11.35	99
20+22+42+60	1.14	1.25	2.39	3.42	-	8.20 (3.70-9.00)	2.554 (0.840-3.225)	11.22	99
20+22+50+50	1.15	1.27	2.89	2.89	-	8.20 (3.70-9.00)	2.574 (0.840-3.225)	11.30	99
20+25+25+25	1.73	2.16	2.16	2.16	-	8.20 (3.70-9.00)	2.634 (0.840-3.265)	11.57	99
20+25+25+35	1.56	1.95	1.95	2.73	-	8.20 (3.70-9.00)	2.634 (0.840-3.265)	11.57	99

MXZ-4D83VA COOLING

Indoor units combination	Cooling capacity (kW)						Outdoor unit power consumption(kW)	Current (A)	Power factor(%)
	Unit A	Unit B	Unit C	Unit D	Unit E	Total			
20+25+25+42	1.46	1.83	1.83	3.08	-	8.20 (3.70-9.00)	2.614 (0.840-3.255)	11.48	99
20+25+25+50	1.37	1.71	1.71	3.42	-	8.20 (3.70-9.00)	2.604 (0.840-3.245)	11.44	99
20+25+25+60	1.26	1.58	1.58	3.78	-	8.20 (3.70-9.00)	2.574 (0.840-3.235)	11.30	99
20+25+25+71	1.16	1.45	1.45	4.13	-	8.20 (3.70-9.00)	2.554 (0.840-3.225)	11.22	99
20+25+35+35	1.43	1.78	2.50	2.50	-	8.20 (3.70-9.00)	2.634 (0.840-3.265)	11.57	99
20+25+35+42	1.34	1.68	2.35	2.82	-	8.20 (3.70-9.00)	2.614 (0.840-3.255)	11.48	99
20+25+35+50	1.26	1.58	2.21	3.15	-	8.20 (3.70-9.00)	2.604 (0.840-3.245)	11.44	99
20+25+35+60	1.17	1.46	2.05	3.51	-	8.20 (3.70-9.00)	2.574 (0.840-3.235)	11.30	99
20+25+42+42	1.27	1.59	2.67	2.67	-	8.20 (3.70-9.00)	2.594 (0.840-3.245)	11.39	99
20+25+42+50	1.20	1.50	2.51	2.99	-	8.20 (3.70-9.00)	2.584 (0.840-3.235)	11.35	99
20+25+50+50	1.13	1.41	2.83	2.83	-	8.20 (3.70-9.00)	2.574 (0.840-3.225)	11.30	99
20+35+35+35	1.31	2.30	2.30	2.30	-	8.20 (3.70-9.00)	2.634 (0.840-3.265)	11.57	99
20+35+35+42	1.24	2.17	2.17	2.61	-	8.20 (3.70-9.00)	2.614 (0.840-3.255)	11.48	99
20+35+35+50	1.17	2.05	2.05	2.93	-	8.20 (3.70-9.00)	2.604 (0.840-3.245)	11.44	99
20+35+42+42	1.18	2.06	2.48	2.48	-	8.20 (3.70-9.00)	2.594 (0.840-3.245)	11.39	99
22+22+22+22	2.08	2.08	2.08	2.08	-	8.30 (3.70-9.20)	2.774 (0.810-3.195)	12.18	99
22+22+22+25	2.01	2.01	2.01	2.28	-	8.30 (3.70-9.20)	2.774 (0.810-3.195)	12.18	99
22+22+22+35	1.81	1.81	1.81	2.88	-	8.30 (3.70-9.20)	2.774 (0.810-3.195)	12.18	99
22+22+22+42	1.69	1.69	1.69	3.23	-	8.30 (3.70-9.20)	2.754 (0.810-3.185)	12.09	99
22+22+22+50	1.57	1.57	1.57	3.58	-	8.30 (3.70-9.20)	2.744 (0.810-3.175)	12.05	99
22+22+22+60	1.45	1.45	1.45	3.95	-	8.30 (3.70-9.20)	2.714 (0.810-3.165)	11.92	99
22+22+22+71	1.33	1.33	1.33	4.30	-	8.30 (3.70-9.20)	2.694 (0.810-3.155)	11.83	99
22+22+25+25	1.94	1.94	2.21	2.21	-	8.30 (3.70-9.20)	2.774 (0.810-3.195)	12.18	99
22+22+25+35	1.76	1.76	2.00	2.79	-	8.30 (3.70-9.20)	2.774 (0.810-3.195)	12.18	99
22+22+25+42	1.65	1.65	1.87	3.14	-	8.30 (3.70-9.20)	2.754 (0.810-3.185)	12.09	99
22+22+25+50	1.53	1.53	1.74	3.49	-	8.30 (3.70-9.20)	2.744 (0.810-3.175)	12.05	99
22+22+25+60	1.42	1.42	1.61	3.86	-	8.30 (3.70-9.20)	2.714 (0.810-3.165)	11.92	99
22+22+25+71	1.30	1.30	1.48	4.21	-	8.30 (3.70-9.20)	2.694 (0.810-3.155)	11.83	99
22+22+35+35	1.60	1.60	2.55	2.55	-	8.30 (3.70-9.20)	2.774 (0.810-3.195)	12.18	99
22+22+35+42	1.51	1.51	2.40	2.88	-	8.30 (3.70-9.20)	2.754 (0.810-3.185)	12.09	99
22+22+35+50	1.42	1.42	2.25	3.22	-	8.30 (3.70-9.20)	2.744 (0.810-3.175)	12.05	99
22+22+35+60	1.31	1.31	2.09	3.58	-	8.30 (3.70-9.20)	2.714 (0.810-3.165)	11.92	99
22+22+42+42	1.43	1.43	2.72	2.72	-	8.30 (3.70-9.20)	2.734 (0.810-3.175)	12.01	99
22+22+42+50	1.34	1.34	2.56	3.05	-	8.30 (3.70-9.20)	2.724 (0.810-3.165)	11.96	99
22+22+50+50	1.27	1.27	2.88	2.88	-	8.30 (3.70-9.20)	2.714 (0.810-3.155)	11.92	99
22+25+25+25	1.88	2.14	2.14	2.14	-	8.30 (3.70-9.20)	2.774 (0.810-3.195)	12.18	99
22+25+25+35	1.71	1.94	1.94	2.71	-	8.30 (3.70-9.20)	2.774 (0.810-3.195)	12.18	99
22+25+25+42	1.60	1.82	1.82	3.06	-	8.30 (3.70-9.20)	2.754 (0.810-3.185)	12.09	99
22+25+25+50	1.50	1.70	1.70	3.40	-	8.30 (3.70-9.20)	2.744 (0.810-3.175)	12.05	99
22+25+25+60	1.38	1.57	1.57	3.77	-	8.30 (3.70-9.20)	2.714 (0.810-3.165)	11.92	99
22+25+25+71	1.28	1.45	1.45	4.12	-	8.30 (3.70-9.20)	2.694 (0.810-3.155)	11.83	99

MXZ-4D83VA COOLING

Indoor units combination	Cooling capacity (kW)						Outdoor unit power consumption(kW)	Current (A)	Power factor(%)
	Unit A	Unit B	Unit C	Unit D	Unit E	Total			
22+25+35+35	1.56	1.77	2.48	2.48	-	8.30 (3.70-9.20)	2.774 (0.810-3.195)	12.18	99
22+25+35+42	1.47	1.67	2.34	2.81	-	8.30 (3.70-9.20)	2.754 (0.810-3.185)	12.09	99
22+25+35+50	1.38	1.57	2.20	3.14	-	8.30 (3.70-9.20)	2.744 (0.810-3.175)	12.05	99
22+25+35+60	1.29	1.46	2.05	3.51	-	8.30 (3.70-9.20)	2.714 (0.810-3.165)	11.92	99
22+25+42+42	1.39	1.58	2.66	2.66	-	8.30 (3.70-9.20)	2.734 (0.810-3.175)	12.01	99
22+25+42+50	1.31	1.49	2.51	2.99	-	8.30 (3.70-9.20)	2.724 (0.810-3.165)	11.96	99
22+35+35+35	1.44	2.29	2.29	2.29	-	8.30 (3.70-9.20)	2.774 (0.810-3.195)	12.18	99
22+35+35+42	1.36	2.17	2.17	2.60	-	8.30 (3.70-9.20)	2.754 (0.810-3.185)	12.09	99
22+35+35+50	1.29	2.05	2.05	2.92	-	8.30 (3.70-9.20)	2.744 (0.810-3.175)	12.05	99
22+35+42+42	1.30	2.06	2.47	2.47	-	8.30 (3.70-9.20)	2.734 (0.810-3.175)	12.01	99
25+25+25+25	2.08	2.08	2.08	2.08	-	8.30 (3.70-9.20)	2.774 (0.810-3.195)	12.18	99
25+25+25+35	1.89	1.89	1.89	2.64	-	8.30 (3.70-9.20)	2.774 (0.810-3.195)	12.18	99
25+25+25+42	1.77	1.77	1.77	2.98	-	8.30 (3.70-9.20)	2.754 (0.810-3.185)	12.09	99
25+25+25+50	1.66	1.66	1.66	3.32	-	8.30 (3.70-9.20)	2.744 (0.810-3.175)	12.05	99
25+25+25+60	1.54	1.54	1.54	3.69	-	8.30 (3.70-9.20)	2.714 (0.810-3.165)	11.92	99
25+25+35+35	1.73	1.73	2.42	2.42	-	8.30 (3.70-9.20)	2.774 (0.810-3.195)	12.18	99
25+25+35+42	1.63	1.63	2.29	2.74	-	8.30 (3.70-9.20)	2.754 (0.810-3.185)	12.09	99
25+25+35+50	1.54	1.54	2.15	3.07	-	8.30 (3.70-9.20)	2.744 (0.810-3.175)	12.05	99
25+25+35+60	1.43	1.43	2.00	3.43	-	8.30 (3.70-9.20)	2.714 (0.810-3.165)	11.92	99
25+25+42+42	1.55	1.55	2.60	2.60	-	8.30 (3.70-9.20)	2.734 (0.810-3.175)	12.01	99
25+25+42+50	1.46	1.46	2.45	2.92	-	8.30 (3.70-9.20)	2.724 (0.810-3.165)	11.96	99
25+35+35+35	1.60	2.23	2.23	2.23	-	8.30 (3.70-9.20)	2.774 (0.810-3.195)	12.18	99
25+35+35+42	1.51	2.12	2.12	2.54	-	8.30 (3.70-9.20)	2.754 (0.810-3.185)	12.09	99
25+35+35+50	1.43	2.00	2.00	2.86	-	8.30 (3.70-9.20)	2.744 (0.810-3.175)	12.05	99
25+35+42+42	1.44	2.02	2.42	2.42	-	8.30 (3.70-9.20)	2.734 (0.810-3.175)	12.01	99
35+35+35+35	2.08	2.08	2.08	2.08	-	8.30 (3.70-9.20)	2.774 (0.810-3.195)	12.18	99

MXZ-4D83VA HEATING

Indoor units combination	Heating capacity (kW)						Outdoor unit power consumption(kW)	Current (A)	Power factor(%)
	Unit A	Unit B	Unit C	Unit D	Unit E	Total			
15	1.70	-	-	-	-	1.70 (1.20-3.00)	0.650 (0.540-1.670)	2.85	99
18	3.30	-	-	-	-	3.30 (1.20-4.20)	0.890 (0.340-1.590)	3.91	99
20	2.20	-	-	-	-	2.20 (1.20-3.90)	0.830 (0.540-2.170)	3.65	99
22	3.30	-	-	-	-	3.30 (1.20-4.20)	0.890 (0.340-1.590)	3.91	99
25	3.60	-	-	-	-	3.60 (1.20-4.50)	0.990 (0.340-1.740)	4.35	99
35	4.00	-	-	-	-	4.00 (1.20-5.50)	1.140 (0.330-1.810)	5.01	99
42	5.40	-	-	-	-	5.40 (1.30-6.50)	1.610 (0.330-2.260)	7.07	99
50	7.20	-	-	-	-	7.20 (1.40-7.70)	2.270 (0.330-2.710)	9.97	99
60	7.90	-	-	-	-	7.90 (1.40-8.60)	2.270 (0.330-3.060)	9.97	99
71	8.60	-	-	-	-	8.60 (1.60-9.20)	2.410 (0.360-3.520)	10.58	99
15+15	1.70	1.70	-	-	-	3.40 (1.80-5.00)	0.770 (0.520-2.800)	3.38	99
15+18	1.70	3.30	-	-	-	5.00 (1.80-6.10)	1.170 (0.500-2.780)	5.14	99
15+20	1.70	2.20	-	-	-	3.90 (1.80-5.80)	0.620 (0.490-2.775)	2.72	99
15+22	1.70	3.30	-	-	-	5.00 (1.80-6.10)	1.170 (0.490-3.000)	5.14	99
15+25	1.60	3.40	-	-	-	5.00 (1.80-6.10)	1.170 (0.520-3.680)	5.14	99
15+35	1.67	3.93	-	-	-	5.60 (1.80-7.70)	1.360 (0.480-3.150)	5.97	99
15+42	1.41	4.49	-	-	-	5.90 (1.80-8.20)	1.479 (0.480-3.275)	6.50	99
15+50	1.18	5.02	-	-	-	6.20 (1.80-8.60)	1.585 (0.480-3.320)	6.96	99
15+60	1.22	5.68	-	-	-	6.90 (1.80-9.10)	1.815 (0.470-3.290)	7.97	99
15+71	1.38	6.42	-	-	-	7.80 (1.80-9.80)	2.098 (0.460-3.255)	9.21	99
18+18	3.30	3.30	-	-	-	6.60 (1.80-7.20)	1.570 (0.480-2.760)	6.90	99
18+20	3.30	2.20	-	-	-	5.50 (1.80-6.90)	1.020 (0.500-3.215)	4.48	99
18+22	3.30	3.30	-	-	-	6.60 (1.80-7.20)	1.570 (0.520-3.670)	6.90	99
18+25	3.16	3.44	-	-	-	6.60 (1.80-7.20)	1.570 (0.490-2.990)	6.90	99
18+35	3.30	4.00	-	-	-	7.30 (1.80-9.00)	1.811 (0.480-3.195)	7.95	99
18+42	2.88	4.72	-	-	-	7.60 (1.80-9.50)	1.930 (0.480-3.320)	8.48	99
18+50	2.48	5.42	-	-	-	7.90 (1.80-9.70)	2.024 (0.480-3.310)	8.89	99
18+60	2.59	6.21	-	-	-	8.80 (1.80-10.40)	2.320 (0.470-3.270)	10.19	99
18+71	2.77	6.63	-	-	-	9.40 (1.80-11.00)	2.464 (0.450-3.255)	10.82	99
20+20	2.20	2.20	-	-	-	4.40 (1.80-6.60)	0.470 (0.520-3.670)	2.06	99
20+22	2.20	3.30	-	-	-	5.50 (1.80-6.90)	1.020 (0.500-3.215)	4.48	99
20+25	2.12	3.48	-	-	-	5.60 (1.80-7.20)	1.052 (0.480-2.825)	4.62	99
20+35	2.20	4.00	-	-	-	6.20 (1.80-8.90)	1.295 (0.480-3.230)	5.69	99
20+42	1.91	4.69	-	-	-	6.60 (1.80-9.30)	1.406 (0.480-3.320)	6.17	99
20+50	1.61	5.29	-	-	-	6.90 (1.80-9.50)	1.500 (0.480-3.310)	6.59	99
20+60	1.72	6.18	-	-	-	7.90 (1.80-10.30)	1.840 (0.470-3.265)	8.08	99
20+71	1.81	6.49	-	-	-	8.30 (1.80-10.70)	1.891 (0.450-3.260)	8.30	99
22+22	3.30	3.30	-	-	-	6.60 (1.80-7.20)	1.570 (0.480-2.760)	6.90	99
22+25	3.30	3.60	-	-	-	6.90 (1.80-8.00)	1.665 (0.480-2.950)	7.31	99
22+35	3.30	4.00	-	-	-	7.30 (1.80-9.30)	1.879 (0.480-3.265)	8.25	99
22+42	2.96	4.84	-	-	-	7.80 (1.80-9.60)	1.982 (0.480-3.320)	8.70	99

MXZ-4D83VA HEATING

Indoor units combination	Heating capacity (kW)					Outdoor unit power consumption(kW)	Current (A)	Power factor(%)	
	Unit A	Unit B	Unit C	Unit D	Unit E				Total
22+50	2.58	5.62	-	-	-	8.20 (1.80-10.00)	2.120 (0.480-3.305)	9.31	99
22+60	2.71	6.49	-	-	-	9.20 (1.80-10.70)	2.460 (0.460-3.255)	10.80	99
22+71	2.77	6.63	-	-	-	9.40 (1.90-11.10)	2.419 (0.450-3.270)	10.62	99
25+25	3.60	3.60	-	-	-	7.20 (1.80-8.80)	1.760 (0.480-3.140)	7.73	99
25+35	3.60	4.00	-	-	-	7.60 (1.80-9.50)	1.930 (0.480-3.320)	8.48	99
25+42	3.16	4.74	-	-	-	7.90 (1.80-9.70)	2.021 (0.480-3.320)	8.88	99
25+50	2.83	5.67	-	-	-	8.50 (1.80-10.20)	2.225 (0.470-3.290)	9.77	99
25+60	2.94	6.46	-	-	-	9.40 (1.80-10.90)	2.519 (0.460-3.255)	11.06	99
25+71	2.94	6.46	-	-	-	9.40 (1.90-11.10)	2.385 (0.450-3.280)	10.47	99
35+35	4.00	4.00	-	-	-	8.00 (1.80-9.80)	2.060 (0.480-3.320)	9.05	99
35+42	3.70	5.00	-	-	-	8.70 (1.80-10.40)	2.305 (0.470-3.295)	10.12	99
35+50	3.36	6.04	-	-	-	9.40 (1.80-10.90)	2.529 (0.460-3.265)	11.11	99
35+60	3.16	6.24	-	-	-	9.40 (1.90-11.10)	2.406 (0.450-3.285)	10.57	99
35+71	3.16	6.24	-	-	-	9.40 (1.90-11.20)	2.271 (0.440-3.290)	9.97	99
42+42	4.70	4.70	-	-	-	9.40 (1.80-10.90)	2.550 (0.460-3.270)	11.20	99
42+50	4.03	5.37	-	-	-	9.40 (1.90-11.10)	2.450 (0.450-3.285)	10.76	99
42+71	3.82	5.58	-	-	-	9.40 (1.90-11.20)	2.191 (0.440-3.290)	9.62	99
50+50	4.70	4.70	-	-	-	9.40 (1.90-11.20)	2.350 (0.440-3.300)	10.32	99
50+60	4.48	4.92	-	-	-	9.40 (1.90-11.20)	2.225 (0.440-3.290)	9.77	99
50+71	4.48	4.92	-	-	-	9.40 (1.90-11.20)	2.100 (0.440-3.280)	9.22	99
60+60	4.70	4.70	-	-	-	9.40 (1.90-11.20)	2.100 (0.440-3.280)	9.22	99
60+71	4.70	4.70	-	-	-	9.40 (1.90-11.20)	2.090 (0.440-3.270)	9.18	99
15+15+15	1.70	1.70	1.70	-	-	5.10 (2.60-8.50)	1.150 (0.650-3.900)	5.05	99
15+15+18	1.60	1.60	3.10	-	-	6.30 (2.60-9.20)	1.420 (0.610-3.620)	6.24	99
15+15+20	1.70	1.70	2.20	-	-	5.60 (2.60-8.90)	1.310 (0.650-3.435)	5.75	99
15+15+22	1.60	1.60	3.10	-	-	6.30 (2.60-9.20)	1.420 (0.610-3.245)	6.24	99
15+15+25	1.53	1.53	3.24	-	-	6.30 (2.60-9.20)	1.420 (0.610-3.200)	6.24	99
15+15+35	1.45	1.45	3.41	-	-	6.30 (2.60-9.20)	1.420 (0.610-3.200)	6.24	99
15+15+42	1.26	1.26	3.99	-	-	6.50 (2.60-9.90)	1.473 (0.610-3.300)	6.47	99
15+15+50	1.09	1.09	4.62	-	-	6.80 (2.60-10.20)	1.565 (0.610-3.415)	6.87	99
15+15+60	1.05	1.05	4.89	-	-	7.00 (2.60-10.20)	1.620 (0.610-3.395)	7.11	99
15+15+71	1.05	1.05	4.89	-	-	7.00 (2.60-10.20)	1.610 (0.610-3.365)	7.07	99
15+18+18	1.54	2.98	2.98	-	-	7.50 (2.60-9.90)	1.690 (0.570-3.340)	7.42	99
15+18+20	1.61	3.12	2.08	-	-	6.80 (2.60-9.60)	1.580 (0.610-3.155)	6.94	99
15+18+22	1.54	2.98	2.98	-	-	7.50 (2.60-9.90)	1.690 (0.570-3.200)	7.42	99
15+18+25	1.48	2.88	3.14	-	-	7.50 (2.60-9.90)	1.690 (0.570-3.620)	7.42	99
15+18+35	1.44	2.79	3.38	-	-	7.60 (2.60-10.10)	1.708 (0.570-3.140)	7.50	99
15+18+42	1.28	2.48	4.05	-	-	7.80 (2.60-10.90)	1.770 (0.570-3.420)	7.77	99
15+18+60	1.08	2.10	5.02	-	-	8.20 (2.60-10.90)	1.890 (0.570-3.390)	8.30	99
15+18+71	1.08	2.10	5.02	-	-	8.20 (2.60-10.90)	1.880 (0.570-3.360)	8.26	99
15+20+20	1.70	2.20	2.20	-	-	6.10 (2.60-9.30)	1.470 (0.650-3.200)	6.46	99

MXZ-4D83VA HEATING

Indoor units combination	Heating capacity (kW)						Outdoor unit power consumption(kW)	Current (A)	Power factor(%)
	Unit A	Unit B	Unit C	Unit D	Unit E	Total			
15+20+22	1.61	2.08	3.12	-	-	6.80 (2.60-9.60)	1.580 (0.610-3.480)	6.94	99
15+20+25	1.54	1.99	3.26	-	-	6.80 (2.60-9.60)	1.580 (0.610-3.900)	6.94	99
15+20+35	1.48	1.92	3.49	-	-	6.90 (2.60-10.00)	1.616 (0.610-3.220)	7.10	99
15+20+42	1.32	1.70	4.18	-	-	7.20 (2.60-10.60)	1.686 (0.610-3.420)	7.40	99
15+20+50	1.15	1.49	4.86	-	-	7.50 (2.60-10.60)	1.790 (0.610-3.410)	7.86	99
15+20+60	1.08	1.40	5.02	-	-	7.50 (2.60-10.60)	1.780 (0.610-3.385)	7.82	99
15+20+71	1.08	1.40	5.02	-	-	7.50 (2.60-10.60)	1.770 (0.610-3.360)	7.77	99
15+22+22	1.54	2.98	2.98	-	-	7.50 (2.60-9.90)	1.690 (0.570-3.760)	7.42	99
15+22+25	1.48	2.88	3.14	-	-	7.50 (2.60-9.90)	1.690 (0.570-3.620)	7.42	99
15+22+35	1.45	2.82	3.42	-	-	7.70 (2.60-10.60)	1.743 (0.570-3.300)	7.65	99
15+22+42	1.31	2.54	4.15	-	-	8.00 (2.60-10.90)	1.822 (0.570-3.415)	8.00	99
15+22+50	1.14	2.22	4.84	-	-	8.20 (2.60-10.90)	1.900 (0.570-3.405)	8.34	99
15+22+60	1.08	2.10	5.02	-	-	8.20 (2.60-10.90)	1.890 (0.570-3.380)	8.30	99
15+22+71	1.08	2.10	5.02	-	-	8.20 (2.60-10.90)	1.880 (0.570-3.360)	8.26	99
15+25+25	1.43	3.03	3.03	-	-	7.50 (2.60-9.90)	1.690 (0.570-3.200)	7.42	99
15+25+35	1.43	3.02	3.35	-	-	7.80 (2.60-10.90)	1.770 (0.570-3.420)	7.77	99
15+25+42	1.29	2.73	4.09	-	-	8.10 (2.60-10.90)	1.861 (0.570-3.415)	8.17	99
15+25+50	1.12	2.36	4.72	-	-	8.20 (2.60-10.90)	1.900 (0.570-3.405)	8.34	99
15+25+60	1.06	2.24	4.91	-	-	8.20 (2.60-10.90)	1.890 (0.570-3.380)	8.30	99
15+25+71	1.06	2.24	4.91	-	-	8.20 (2.60-10.90)	1.880 (0.570-3.360)	8.26	99
15+35+35	1.44	3.38	3.38	-	-	8.20 (2.60-10.90)	1.900 (0.570-3.410)	8.34	99
15+35+42	1.26	2.95	3.99	-	-	8.20 (2.60-10.90)	1.900 (0.570-3.400)	8.34	99
15+35+50	1.08	2.54	4.58	-	-	8.20 (2.60-10.90)	1.900 (0.570-3.390)	8.34	99
15+35+60	1.03	2.41	4.76	-	-	8.20 (2.60-10.90)	1.890 (0.570-3.370)	8.30	99
15+35+71	1.03	2.41	4.76	-	-	8.20 (2.60-10.90)	1.880 (0.570-3.360)	8.26	99
15+42+42	1.12	3.54	3.54	-	-	8.20 (2.60-10.90)	1.900 (0.570-3.390)	8.34	99
15+42+50	0.97	3.10	4.13	-	-	8.20 (2.60-10.90)	1.900 (0.570-3.380)	8.34	99
15+42+60	0.93	2.95	4.32	-	-	8.20 (2.60-10.90)	1.890 (0.570-3.370)	8.30	99
15+42+71	0.93	2.95	4.32	-	-	8.20 (2.60-10.90)	1.880 (0.570-3.360)	8.26	99
15+50+50	0.87	3.67	3.67	-	-	8.20 (2.60-10.90)	1.900 (0.570-3.380)	8.34	99
15+50+60	0.83	3.51	3.86	-	-	8.20 (2.60-10.90)	1.890 (0.570-3.370)	8.30	99
15+50+71	0.83	3.51	3.86	-	-	8.20 (2.60-10.90)	1.880 (0.570-3.360)	8.26	99
15+60+60	0.80	3.70	3.70	-	-	8.20 (2.60-10.90)	1.880 (0.570-3.360)	8.26	99
18+18+18	2.90	2.90	2.90	-	-	8.70 (2.60-10.60)	1.960 (0.530-3.060)	8.61	99
18+18+20	3.00	3.00	2.00	-	-	8.00 (2.60-10.30)	1.850 (0.570-3.340)	8.12	99
18+18+22	2.90	2.90	2.90	-	-	8.70 (2.60-10.60)	1.960 (0.530-3.620)	8.61	99
18+18+25	2.81	2.81	3.07	-	-	8.70 (2.60-10.60)	1.960 (0.530-3.760)	8.61	99
18+18+35	2.77	2.77	3.36	-	-	8.90 (2.60-11.20)	2.004 (0.530-3.260)	8.80	99
18+18+42	2.50	2.50	4.10	-	-	9.10 (2.60-11.60)	2.079 (0.530-3.415)	9.13	99
18+18+50	2.25	2.25	4.90	-	-	9.40 (2.60-11.60)	2.170 (0.530-3.410)	9.53	99
18+18+60	2.14	2.14	5.12	-	-	9.40 (2.60-11.60)	2.160 (0.530-3.385)	9.49	99

MXZ-4D83VA HEATING

Indoor units combination	Heating capacity (kW)						Outdoor unit power consumption(kW)	Current (A)	Power factor(%)
	Unit A	Unit B	Unit C	Unit D	Unit E	Total			
18+18+71	2.14	2.14	5.12	-	-	9.40 (2.60-11.60)	2.150 (0.530-3.360)	9.44	99
18+20+20	3.13	2.09	2.09	-	-	7.30 (2.60-10.00)	1.740 (0.610-3.620)	7.64	99
18+20+22	3.00	2.00	3.00	-	-	8.00 (2.60-10.30)	1.850 (0.570-3.900)	8.12	99
18+20+25	2.90	1.93	3.16	-	-	8.00 (2.60-10.30)	1.850 (0.570-3.480)	8.12	99
18+20+35	2.85	1.90	3.45	-	-	8.20 (2.60-11.10)	1.912 (0.570-3.340)	8.40	99
18+20+42	2.57	1.72	4.21	-	-	8.50 (2.60-11.30)	1.995 (0.570-3.415)	8.76	99
18+20+50	2.26	1.51	4.93	-	-	8.70 (2.60-11.30)	2.060 (0.570-3.405)	9.05	99
18+20+60	2.14	1.43	5.13	-	-	8.70 (2.60-11.30)	2.050 (0.570-3.380)	9.00	99
18+20+71	2.14	1.43	5.13	-	-	8.70 (2.60-11.30)	2.040 (0.570-3.360)	8.96	99
18+22+22	2.90	2.90	2.90	-	-	8.70 (2.60-10.60)	1.960 (0.530-3.620)	8.61	99
18+22+25	2.81	2.81	3.07	-	-	8.70 (2.60-10.60)	1.960 (0.530-3.200)	8.61	99
18+22+35	2.80	2.80	3.40	-	-	9.00 (2.60-11.60)	2.040 (0.530-3.420)	8.96	99
18+22+42	2.56	2.56	4.19	-	-	9.30 (2.60-11.60)	2.131 (0.530-3.415)	9.36	99
18+22+50	2.25	2.25	4.90	-	-	9.40 (2.60-11.60)	2.170 (0.530-3.405)	9.53	99
18+22+60	2.14	2.14	5.12	-	-	9.40 (2.60-11.60)	2.160 (0.530-3.380)	9.49	99
18+22+71	2.14	2.14	5.12	-	-	9.40 (2.60-11.60)	2.150 (0.530-3.360)	9.44	99
18+25+25	2.77	3.02	3.02	-	-	8.80 (2.60-10.80)	1.978 (0.530-3.140)	8.69	99
18+25+35	2.76	3.01	3.34	-	-	9.10 (2.60-11.60)	2.079 (0.530-3.415)	9.13	99
18+25+42	2.52	2.75	4.13	-	-	9.40 (2.60-11.60)	2.170 (0.530-3.410)	9.53	99
18+25+50	2.20	2.40	4.80	-	-	9.40 (2.60-11.60)	2.170 (0.530-3.400)	9.53	99
18+25+60	2.10	2.29	5.02	-	-	9.40 (2.60-11.60)	2.160 (0.530-3.375)	9.49	99
18+25+71	2.10	2.29	5.02	-	-	9.40 (2.60-11.60)	2.150 (0.530-3.360)	9.44	99
18+35+35	2.75	3.33	3.33	-	-	9.40 (2.60-11.60)	2.170 (0.530-3.405)	9.53	99
18+35+42	2.44	2.96	4.00	-	-	9.40 (2.60-11.60)	2.170 (0.530-3.395)	9.53	99
18+35+50	2.14	2.59	4.67	-	-	9.40 (2.60-11.60)	2.170 (0.530-3.385)	9.53	99
18+35+60	2.04	2.47	4.89	-	-	9.40 (2.60-11.60)	2.160 (0.530-3.370)	9.49	99
18+35+71	2.04	2.47	4.89	-	-	9.40 (2.60-11.60)	2.150 (0.530-3.360)	9.44	99
18+42+42	2.20	3.60	3.60	-	-	9.40 (2.60-11.60)	2.170 (0.530-3.385)	9.53	99
18+42+50	1.95	3.19	4.26	-	-	9.40 (2.60-11.60)	2.170 (0.530-3.380)	9.53	99
18+42+60	1.87	3.06	4.47	-	-	9.40 (2.60-11.60)	2.160 (0.530-3.370)	9.49	99
18+42+71	1.87	3.06	4.47	-	-	9.40 (2.60-11.60)	2.150 (0.530-3.360)	9.44	99
18+50+50	1.75	3.82	3.82	-	-	9.40 (2.60-11.60)	2.170 (0.530-3.380)	9.53	99
18+50+60	1.69	3.68	4.04	-	-	9.40 (2.60-11.60)	2.160 (0.530-3.370)	9.49	99
18+50+71	1.69	3.68	4.04	-	-	9.40 (2.60-11.60)	2.150 (0.530-3.360)	9.44	99
18+60+60	1.62	3.89	3.89	-	-	9.40 (2.60-11.60)	2.150 (0.530-3.360)	9.44	99
20+20+20	2.20	2.20	2.20	-	-	6.60 (2.60-9.70)	1.630 (0.650-3.900)	7.16	99
20+20+22	2.09	2.09	3.13	-	-	7.30 (2.60-10.00)	1.740 (0.610-3.620)	7.64	99
20+20+25	2.01	2.01	3.29	-	-	7.30 (2.60-10.00)	1.740 (0.610-3.200)	7.64	99
20+20+35	1.99	1.99	3.62	-	-	7.60 (2.60-11.00)	1.820 (0.610-3.420)	7.99	99
20+20+42	1.77	1.77	4.35	-	-	7.90 (2.60-11.00)	1.911 (0.610-3.415)	8.39	99
20+20+50	1.52	1.52	4.97	-	-	8.00 (2.60-11.00)	1.950 (0.610-3.405)	8.56	99

MXZ-4D83VA HEATING

Indoor units combination	Heating capacity (kW)						Outdoor unit power consumption(kW)	Current (A)	Power factor(%)
	Unit A	Unit B	Unit C	Unit D	Unit E	Total			
20+20+60	1.43	1.43	5.14	-	-	8.00 (2.60-11.00)	1.940 (0.610-3.380)	8.52	99
20+20+71	1.43	1.43	5.14	-	-	8.00 (2.60-11.00)	1.930 (0.610-3.360)	8.48	99
20+22+22	2.00	3.00	3.00	-	-	8.00 (2.60-10.30)	1.850 (0.570-3.340)	8.12	99
20+22+25	1.93	2.90	3.16	-	-	8.00 (2.60-10.40)	1.859 (0.570-3.100)	8.16	99
20+22+35	1.95	2.92	3.54	-	-	8.40 (2.60-11.30)	1.956 (0.570-3.420)	8.59	99
20+22+42	1.76	2.63	4.31	-	-	8.70 (2.60-11.30)	2.047 (0.570-3.410)	8.99	99
20+22+50	1.51	2.26	4.93	-	-	8.70 (2.60-11.30)	2.060 (0.570-3.400)	9.05	99
20+22+60	1.43	2.14	5.13	-	-	8.70 (2.60-11.30)	2.050 (0.570-3.375)	9.00	99
20+22+71	1.43	2.14	5.13	-	-	8.70 (2.60-11.30)	2.040 (0.570-3.360)	8.96	99
20+25+25	1.90	3.10	3.10	-	-	8.10 (2.60-10.70)	1.886 (0.570-3.220)	8.28	99
20+25+35	1.91	3.12	3.47	-	-	8.50 (2.60-11.30)	1.995 (0.570-3.415)	8.76	99
20+25+42	1.71	2.80	4.19	-	-	8.70 (2.60-11.30)	2.060 (0.570-3.405)	9.05	99
20+25+50	1.47	2.41	4.82	-	-	8.70 (2.60-11.30)	2.060 (0.570-3.395)	9.05	99
20+25+60	1.40	2.29	5.02	-	-	8.70 (2.60-11.30)	2.050 (0.570-3.370)	9.00	99
20+25+71	1.40	2.29	5.02	-	-	8.70 (2.60-11.30)	2.040 (0.570-3.360)	8.96	99
20+35+35	1.88	3.41	3.41	-	-	8.70 (2.60-11.30)	2.060 (0.570-3.405)	9.05	99
20+35+42	1.65	3.00	4.05	-	-	8.70 (2.60-11.30)	2.060 (0.570-3.390)	9.05	99
20+35+50	1.43	2.60	4.67	-	-	8.70 (2.60-11.30)	2.060 (0.570-3.380)	9.05	99
20+35+60	1.36	2.47	4.87	-	-	8.70 (2.60-11.30)	2.050 (0.570-3.370)	9.00	99
20+35+71	1.36	2.47	4.87	-	-	8.70 (2.60-11.30)	2.040 (0.570-3.360)	8.96	99
20+42+42	1.47	3.61	3.61	-	-	8.70 (2.60-11.30)	2.060 (0.570-3.380)	9.05	99
20+42+50	1.29	3.17	4.23	-	-	8.70 (2.60-11.30)	2.060 (0.570-3.380)	9.05	99
20+42+60	1.23	3.03	4.43	-	-	8.70 (2.60-11.30)	2.050 (0.570-3.370)	9.00	99
20+42+71	1.23	3.03	4.43	-	-	8.70 (2.60-11.30)	2.040 (0.570-3.360)	8.96	99
20+50+50	1.15	3.77	3.77	-	-	8.70 (2.60-11.30)	2.060 (0.570-3.380)	9.05	99
20+50+60	1.11	3.62	3.97	-	-	8.70 (2.60-11.30)	2.050 (0.570-3.370)	9.00	99
20+50+71	1.11	3.62	3.97	-	-	8.70 (2.60-11.30)	2.040 (0.570-3.360)	8.96	99
20+60+60	1.06	3.82	3.82	-	-	8.70 (2.60-11.30)	2.040 (0.570-3.360)	8.96	99
22+22+22	2.90	2.90	2.90	-	-	8.70 (2.60-10.60)	1.960 (0.530-3.060)	8.61	99
22+22+25	2.85	2.85	3.11	-	-	8.80 (2.60-10.90)	1.987 (0.530-3.180)	8.73	99
22+22+35	2.86	2.86	3.47	-	-	9.20 (2.60-11.60)	2.092 (0.530-3.415)	9.19	99
22+22+42	2.59	2.59	4.23	-	-	9.40 (2.60-11.60)	2.170 (0.530-3.410)	9.53	99
22+22+50	2.25	2.25	4.90	-	-	9.40 (2.60-11.60)	2.170 (0.530-3.395)	9.53	99
22+22+60	2.14	2.14	5.12	-	-	9.40 (2.60-11.60)	2.160 (0.530-3.370)	9.49	99
22+22+71	2.14	2.14	5.12	-	-	9.40 (2.60-11.60)	2.150 (0.530-3.360)	9.44	99
22+25+25	2.80	3.05	3.05	-	-	8.90 (2.60-11.30)	2.013 (0.530-3.300)	8.84	99
22+25+35	2.82	3.07	3.41	-	-	9.30 (2.60-11.60)	2.131 (0.530-3.415)	9.36	99
22+25+42	2.52	2.75	4.13	-	-	9.40 (2.60-11.60)	2.170 (0.530-3.405)	9.53	99
22+25+50	2.20	2.40	4.80	-	-	9.40 (2.60-11.60)	2.170 (0.530-3.390)	9.53	99
22+25+60	2.10	2.29	5.02	-	-	9.40 (2.60-11.60)	2.160 (0.530-3.370)	9.49	99
22+25+71	2.10	2.29	5.02	-	-	9.40 (2.60-11.60)	2.150 (0.530-3.360)	9.44	99

MXZ-4D83VA HEATING

Indoor units combination	Heating capacity (kW)						Outdoor unit power consumption(kW)	Current (A)	Power factor(%)
	Unit A	Unit B	Unit C	Unit D	Unit E	Total			
22+35+35	2.75	3.33	3.33	-	-	9.40 (2.60-11.60)	2.170 (0.530-3.400)	9.53	99
22+35+42	2.44	2.96	4.00	-	-	9.40 (2.60-11.60)	2.170 (0.530-3.390)	9.53	99
22+35+50	2.14	2.59	4.67	-	-	9.40 (2.60-11.60)	2.170 (0.530-3.380)	9.53	99
22+35+60	2.04	2.47	4.89	-	-	9.40 (2.60-11.60)	2.160 (0.530-3.370)	9.49	99
22+35+71	2.04	2.47	4.89	-	-	9.40 (2.60-11.60)	2.150 (0.530-3.360)	9.44	99
22+42+42	2.20	3.60	3.60	-	-	9.40 (2.60-11.60)	2.170 (0.530-3.380)	9.53	99
22+42+50	1.95	3.19	4.26	-	-	9.40 (2.60-11.60)	2.170 (0.530-3.380)	9.53	99
22+42+60	1.87	3.06	4.47	-	-	9.40 (2.60-11.60)	2.160 (0.530-3.370)	9.49	99
22+42+71	1.87	3.06	4.47	-	-	9.40 (2.60-11.60)	2.150 (0.530-3.360)	9.44	99
22+50+50	1.75	3.82	3.82	-	-	9.40 (2.60-11.60)	2.170 (0.530-3.380)	9.53	99
22+50+60	1.69	3.68	4.04	-	-	9.40 (2.60-11.60)	2.160 (0.530-3.370)	9.49	99
22+50+71	1.69	3.68	4.04	-	-	9.40 (2.60-11.60)	2.150 (0.530-3.360)	9.44	99
22+60+60	1.62	3.89	3.89	-	-	9.40 (2.60-11.60)	2.150 (0.530-3.360)	9.44	99
25+25+25	3.00	3.00	3.00	-	-	9.00 (2.60-11.60)	2.040 (0.530-3.420)	8.96	99
25+25+35	3.02	3.02	3.36	-	-	9.40 (2.60-11.60)	2.170 (0.530-3.410)	9.53	99
25+25+42	2.69	2.69	4.03	-	-	9.40 (2.60-11.60)	2.170 (0.530-3.400)	9.53	99
25+25+50	2.35	2.35	4.70	-	-	9.40 (2.60-11.60)	2.170 (0.530-3.390)	9.53	99
25+25+60	2.24	2.24	4.92	-	-	9.40 (2.60-11.60)	2.160 (0.530-3.370)	9.49	99
25+25+71	2.24	2.24	4.92	-	-	9.40 (2.60-11.60)	2.150 (0.530-3.360)	9.44	99
25+35+35	2.92	3.24	3.24	-	-	9.40 (2.60-11.60)	2.170 (0.530-3.395)	9.53	99
25+35+42	2.60	2.89	3.90	-	-	9.40 (2.60-11.60)	2.170 (0.530-3.385)	9.53	99
25+35+50	2.29	2.54	4.57	-	-	9.40 (2.60-11.60)	2.170 (0.530-3.380)	9.53	99
25+35+60	2.18	2.43	4.79	-	-	9.40 (2.60-11.60)	2.160 (0.530-3.370)	9.49	99
25+35+71	2.18	2.43	4.79	-	-	9.40 (2.60-11.60)	2.150 (0.530-3.360)	9.44	99
25+42+42	2.35	3.53	3.53	-	-	9.40 (2.60-11.60)	2.170 (0.530-3.380)	9.53	99
25+42+50	2.09	3.13	4.18	-	-	9.40 (2.60-11.60)	2.170 (0.530-3.380)	9.53	99
25+42+60	2.00	3.00	4.39	-	-	9.40 (2.60-11.60)	2.160 (0.530-3.370)	9.49	99
25+42+71	2.00	3.00	4.39	-	-	9.40 (2.60-11.60)	2.150 (0.530-3.360)	9.44	99
25+50+50	1.88	3.76	3.76	-	-	9.40 (2.60-11.60)	2.170 (0.530-3.380)	9.53	99
25+50+60	1.81	3.62	3.97	-	-	9.40 (2.60-11.60)	2.160 (0.530-3.370)	9.49	99
25+60+60	1.74	3.83	3.83	-	-	9.40 (2.60-11.60)	2.150 (0.530-3.360)	9.44	99
35+35+35	3.13	3.13	3.13	-	-	9.40 (2.60-11.60)	2.170 (0.530-3.380)	9.53	99
35+35+42	2.81	2.81	3.79	-	-	9.40 (2.60-11.60)	2.170 (0.530-3.380)	9.53	99
35+35+50	2.47	2.47	4.45	-	-	9.40 (2.60-11.60)	2.170 (0.530-3.380)	9.53	99
35+35+60	2.36	2.36	4.67	-	-	9.40 (2.60-11.60)	2.160 (0.530-3.370)	9.49	99
35+35+71	2.36	2.36	4.67	-	-	9.40 (2.60-11.60)	2.150 (0.530-3.360)	9.44	99
35+42+42	2.54	3.43	3.43	-	-	9.40 (2.60-11.60)	2.170 (0.530-3.380)	9.53	99
35+42+50	2.27	3.06	4.08	-	-	9.40 (2.60-11.60)	2.170 (0.530-3.380)	9.53	99
35+42+60	2.17	2.93	4.29	-	-	9.40 (2.60-11.60)	2.160 (0.530-3.370)	9.49	99
35+50+50	2.04	3.68	3.68	-	-	9.40 (2.60-11.60)	2.170 (0.530-3.380)	9.53	99
35+50+60	1.97	3.54	3.89	-	-	9.40 (2.60-11.60)	2.160 (0.530-3.370)	9.49	99

MXZ-4D83VA HEATING

Indoor units combination	Heating capacity (kW)						Outdoor unit power consumption(kW)	Current (A)	Power factor(%)
	Unit A	Unit B	Unit C	Unit D	Unit E	Total			
42+42+42	3.13	3.13	3.13	-	-	9.40 (2.60-11.60)	2.170 (0.530-3.380)	9.53	99
42+42+50	2.82	2.82	3.76	-	-	9.40 (2.60-11.60)	2.170 (0.530-3.380)	9.53	99
42+42+60	2.71	2.71	3.97	-	-	9.40 (2.60-11.60)	2.160 (0.530-3.370)	9.49	99
42+50+50	2.56	3.42	3.42	-	-	9.40 (2.60-11.60)	2.170 (0.530-3.380)	9.53	99
15+15+15+15	1.70	1.70	1.70	1.70	-	6.80 (3.40-8.80)	1.532 (0.790-3.900)	6.73	99
15+15+15+18	1.52	1.52	1.52	2.95	-	7.50 (3.40-9.50)	1.727 (0.740-3.780)	7.58	99
15+15+15+20	1.70	1.70	1.70	2.20	-	7.30 (3.40-9.30)	1.697 (0.790-3.700)	7.45	99
15+15+15+22	1.52	1.52	1.52	2.95	-	7.50 (3.40-9.50)	1.727 (0.740-3.620)	7.58	99
15+15+15+25	1.47	1.47	1.47	3.10	-	7.50 (3.40-9.50)	1.727 (0.740-3.500)	7.58	99
15+15+15+35	1.40	1.40	1.40	3.30	-	7.50 (3.40-9.50)	1.727 (0.740-3.900)	7.58	99
15+15+15+42	1.21	1.21	1.21	3.86	-	7.50 (3.40-9.50)	1.727 (0.740-3.480)	7.58	99
15+15+15+50	1.04	1.04	1.04	4.39	-	7.50 (3.40-9.50)	1.727 (0.740-3.420)	7.58	99
15+15+15+60	0.98	0.98	0.98	4.56	-	7.50 (3.40-9.50)	1.717 (0.740-3.410)	7.54	99
15+15+15+71	0.98	0.98	0.98	4.56	-	7.50 (3.40-9.50)	1.707 (0.740-3.400)	7.50	99
15+15+18+18	1.36	1.36	2.64	2.64	-	8.00 (3.40-10.20)	1.922 (0.690-3.660)	8.44	99
15+15+18+20	1.49	1.49	2.89	1.93	-	7.80 (3.40-10.00)	1.892 (0.740-3.580)	8.31	99
15+15+18+22	1.36	1.36	2.64	2.64	-	8.00 (3.40-10.20)	1.922 (0.690-3.500)	8.44	99
15+15+18+25	1.32	1.32	2.56	2.80	-	8.00 (3.40-10.20)	1.922 (0.690-3.480)	8.44	99
15+15+18+42	1.12	1.12	2.18	3.57	-	8.00 (3.40-10.20)	1.922 (0.690-3.420)	8.44	99
15+15+18+50	0.98	0.98	1.90	4.14	-	8.00 (3.40-10.20)	1.922 (0.690-3.420)	8.44	99
15+15+18+60	0.93	0.93	1.81	4.33	-	8.00 (3.40-10.20)	1.912 (0.690-3.410)	8.40	99
15+15+18+71	0.93	0.93	1.81	4.33	-	8.00 (3.40-10.20)	1.902 (0.690-3.400)	8.35	99
15+15+20+20	1.66	1.66	2.14	2.14	-	7.60 (3.40-9.80)	1.862 (0.790-3.500)	8.18	99
15+15+20+22	1.49	1.49	1.93	2.89	-	7.80 (3.40-10.00)	1.892 (0.740-3.420)	8.31	99
15+15+20+25	1.44	1.44	1.87	3.05	-	7.80 (3.40-10.00)	1.892 (0.740-3.600)	8.31	99
15+15+20+35	1.38	1.38	1.79	3.25	-	7.80 (3.40-10.00)	1.892 (0.740-3.600)	8.31	99
15+15+20+42	1.21	1.21	1.56	3.83	-	7.80 (3.40-10.00)	1.892 (0.740-3.420)	8.31	99
15+15+20+50	1.04	1.04	1.34	4.39	-	7.80 (3.40-10.00)	1.892 (0.740-3.420)	8.31	99
15+15+20+60	0.98	0.98	1.27	4.56	-	7.80 (3.40-10.00)	1.882 (0.740-3.410)	8.27	99
15+15+20+71	0.98	0.98	1.27	4.56	-	7.80 (3.40-10.00)	1.872 (0.740-3.400)	8.22	99
15+15+22+22	1.36	1.36	2.64	2.64	-	8.00 (3.40-10.20)	1.922 (0.690-3.540)	8.44	99
15+15+22+25	1.32	1.32	2.56	2.80	-	8.00 (3.40-10.20)	1.922 (0.690-3.720)	8.44	99
15+15+22+35	1.27	1.27	2.47	2.99	-	8.00 (3.40-10.20)	1.922 (0.690-3.480)	8.44	99
15+15+22+42	1.12	1.12	2.18	3.57	-	8.00 (3.40-10.20)	1.922 (0.690-3.420)	8.44	99
15+15+22+50	0.98	0.98	1.90	4.14	-	8.00 (3.40-10.20)	1.922 (0.690-3.420)	8.44	99
15+15+22+60	0.93	0.93	1.81	4.33	-	8.00 (3.40-10.20)	1.912 (0.690-3.410)	8.40	99
15+15+22+71	0.93	0.93	1.81	4.33	-	8.00 (3.40-10.20)	1.902 (0.690-3.400)	8.35	99
15+15+25+25	1.28	1.28	2.72	2.72	-	8.00 (3.40-10.20)	1.922 (0.690-3.900)	8.44	99
15+15+25+35	1.24	1.24	2.62	2.91	-	8.00 (3.40-10.20)	1.922 (0.690-3.420)	8.44	99
15+15+25+42	1.10	1.10	2.32	3.48	-	8.00 (3.40-10.20)	1.922 (0.690-3.420)	8.44	99
15+15+25+50	0.96	0.96	2.03	4.06	-	8.00 (3.40-10.20)	1.922 (0.690-3.420)	8.44	99

MXZ-4D83VA HEATING

Indoor units combination	Heating capacity (kW)						Outdoor unit power consumption(kW)	Current (A)	Power factor(%)
	Unit A	Unit B	Unit C	Unit D	Unit E	Total			
15+15+25+60	0.91	0.91	1.93	4.24	-	8.00 (3.40-10.20)	1.912 (0.690-3.410)	8.40	99
15+15+25+71	0.91	0.91	1.93	4.24	-	8.00 (3.40-10.20)	1.902 (0.690-3.400)	8.35	99
15+15+35+35	1.19	1.19	2.81	2.81	-	8.00 (3.40-10.20)	1.922 (0.690-3.420)	8.44	99
15+15+35+42	1.06	1.06	2.50	3.38	-	8.00 (3.40-10.20)	1.922 (0.690-3.420)	8.44	99
15+15+35+50	0.93	0.93	2.19	3.95	-	8.00 (3.40-10.20)	1.922 (0.690-3.420)	8.44	99
15+15+35+60	0.89	0.89	2.09	4.13	-	8.00 (3.40-10.20)	1.912 (0.690-3.410)	8.40	99
15+15+35+71	0.89	0.89	2.09	4.13	-	8.00 (3.40-10.20)	1.902 (0.690-3.400)	8.35	99
15+15+42+42	0.96	0.96	3.04	3.04	-	8.00 (3.40-10.20)	1.922 (0.690-3.420)	8.44	99
15+15+42+50	0.85	0.85	2.70	3.60	-	8.00 (3.40-10.20)	1.922 (0.690-3.420)	8.44	99
15+15+42+60	0.81	0.81	2.59	3.78	-	8.00 (3.40-10.20)	1.912 (0.690-3.410)	8.40	99
15+15+42+71	0.81	0.81	2.59	3.78	-	8.00 (3.40-10.20)	1.902 (0.690-3.400)	8.35	99
15+15+50+50	0.76	0.76	3.24	3.24	-	8.00 (3.40-10.20)	1.922 (0.690-3.420)	8.44	99
15+15+50+60	0.74	0.74	3.11	3.42	-	8.00 (3.40-10.20)	1.912 (0.690-3.410)	8.40	99
15+18+18+18	1.25	2.42	2.42	2.42	-	8.50 (3.40-10.90)	2.117 (0.640-3.540)	9.30	99
15+18+18+20	1.34	2.61	2.61	1.74	-	8.30 (3.40-10.70)	2.087 (0.690-3.460)	9.17	99
15+18+18+22	1.25	2.42	2.42	2.42	-	8.50 (3.40-10.90)	2.117 (0.640-3.480)	9.30	99
15+18+18+25	1.21	2.36	2.36	2.57	-	8.50 (3.40-10.90)	2.117 (0.640-3.660)	9.30	99
15+18+18+35	1.17	2.28	2.28	2.76	-	8.50 (3.40-10.90)	2.117 (0.640-3.540)	9.30	99
15+18+18+42	1.05	2.05	2.05	3.35	-	8.50 (3.40-10.90)	2.117 (0.640-3.420)	9.30	99
15+18+18+50	0.93	1.81	1.81	3.95	-	8.50 (3.40-10.90)	2.117 (0.640-3.420)	9.30	99
15+18+18+60	0.89	1.73	1.73	4.15	-	8.50 (3.40-10.90)	2.107 (0.640-3.410)	9.25	99
15+18+18+71	0.89	1.73	1.73	4.15	-	8.50 (3.40-10.90)	2.097 (0.640-3.400)	9.21	99
15+18+20+20	1.46	2.84	1.90	1.90	-	8.10 (3.40-10.50)	2.057 (0.740-3.480)	9.03	99
15+18+20+22	1.34	2.61	1.74	2.61	-	8.30 (3.40-10.70)	2.087 (0.690-3.600)	9.17	99
15+18+20+25	1.31	2.54	1.69	2.77	-	8.30 (3.40-10.70)	2.087 (0.690-3.780)	9.17	99
15+18+20+35	1.26	2.45	1.63	2.96	-	8.30 (3.40-10.70)	2.087 (0.690-3.420)	9.17	99
15+18+20+42	1.12	2.17	1.45	3.56	-	8.30 (3.40-10.70)	2.087 (0.690-3.420)	9.17	99
15+18+20+50	0.98	1.90	1.27	4.15	-	8.30 (3.40-10.70)	2.087 (0.690-3.420)	9.17	99
15+18+20+60	0.93	1.81	1.21	4.34	-	8.30 (3.40-10.70)	2.077 (0.690-3.410)	9.12	99
15+18+20+71	0.93	1.81	1.21	4.34	-	8.30 (3.40-10.70)	2.067 (0.690-3.400)	9.08	99
15+18+22+22	1.25	2.42	2.42	2.42	-	8.50 (3.40-10.90)	2.117 (0.640-3.720)	9.30	99
15+18+22+25	1.21	2.36	2.36	2.57	-	8.50 (3.40-10.90)	2.117 (0.640-3.900)	9.30	99
15+18+22+35	1.17	2.28	2.28	2.76	-	8.50 (3.40-10.90)	2.117 (0.640-3.420)	9.30	99
15+18+22+42	1.05	2.05	2.05	3.35	-	8.50 (3.40-10.90)	2.117 (0.640-3.420)	9.30	99
15+18+22+50	0.93	1.81	1.81	3.95	-	8.50 (3.40-10.90)	2.117 (0.640-3.420)	9.30	99
15+18+22+60	0.89	1.73	1.73	4.15	-	8.50 (3.40-10.90)	2.107 (0.640-3.410)	9.25	99
15+18+22+71	0.89	1.73	1.73	4.15	-	8.50 (3.40-10.90)	2.097 (0.640-3.400)	9.21	99
15+18+25+35	1.15	2.23	2.43	2.70	-	8.50 (3.40-10.90)	2.117 (0.640-3.420)	9.30	99
15+18+25+42	1.03	2.00	2.19	3.28	-	8.50 (3.40-10.90)	2.117 (0.640-3.420)	9.30	99
15+18+25+50	0.91	1.78	1.94	3.87	-	8.50 (3.40-10.90)	2.117 (0.640-3.420)	9.30	99
15+18+25+60	0.88	1.70	1.85	4.07	-	8.50 (3.40-10.90)	2.107 (0.640-3.410)	9.25	99

MXZ-4D83VA HEATING

Indoor units combination	Heating capacity (kW)						Outdoor unit power consumption(kW)	Current (A)	Power factor(%)
	Unit A	Unit B	Unit C	Unit D	Unit E	Total			
15+18+25+71	0.88	1.70	1.85	4.07	-	8.50 (3.40-10.90)	2.097 (0.640-3.400)	9.21	99
15+18+35+35	1.11	2.16	2.62	2.62	-	8.50 (3.40-10.90)	2.117 (0.640-3.420)	9.30	99
15+18+35+42	1.00	1.95	2.36	3.19	-	8.50 (3.40-10.90)	2.117 (0.640-3.420)	9.30	99
15+18+35+50	0.89	1.73	2.10	3.78	-	8.50 (3.40-10.90)	2.117 (0.640-3.420)	9.30	99
15+18+35+60	0.86	1.66	2.01	3.97	-	8.50 (3.40-10.90)	2.107 (0.640-3.410)	9.25	99
15+18+35+71	0.86	1.66	2.01	3.97	-	8.50 (3.40-10.90)	2.097 (0.640-3.400)	9.21	99
15+18+42+42	0.91	1.78	2.91	2.91	-	8.50 (3.40-10.90)	2.117 (0.640-3.420)	9.30	99
15+18+42+50	0.82	1.59	2.61	3.48	-	8.50 (3.40-10.90)	2.117 (0.640-3.420)	9.30	99
15+18+42+60	0.79	1.53	2.51	3.67	-	8.50 (3.40-10.90)	2.107 (0.640-3.410)	9.25	99
15+18+50+50	0.74	1.45	3.15	3.15	-	8.50 (3.40-10.90)	2.117 (0.640-3.420)	9.30	99
15+18+50+60	0.72	1.40	3.04	3.34	-	8.50 (3.40-10.90)	2.107 (0.640-3.410)	9.25	99
15+20+20+20	1.62	2.09	2.09	2.09	-	7.90 (3.40-10.30)	2.027 (0.790-3.600)	8.90	99
15+20+20+22	1.46	1.90	1.90	2.84	-	8.10 (3.40-10.50)	2.057 (0.740-3.720)	9.03	99
15+20+20+25	1.42	1.84	1.84	3.01	-	8.10 (3.40-10.50)	2.057 (0.740-3.900)	9.03	99
15+20+20+35	1.36	1.76	1.76	3.21	-	8.10 (3.40-10.50)	2.057 (0.740-3.420)	9.03	99
15+20+20+42	1.20	1.55	1.55	3.80	-	8.10 (3.40-10.50)	2.057 (0.740-3.420)	9.03	99
15+20+20+50	1.04	1.34	1.34	4.38	-	8.10 (3.40-10.50)	2.057 (0.740-3.420)	9.03	99
15+20+20+60	0.98	1.27	1.27	4.57	-	8.10 (3.40-10.50)	2.047 (0.740-3.410)	8.99	99
15+20+20+71	0.98	1.27	1.27	4.57	-	8.10 (3.40-10.50)	2.037 (0.740-3.400)	8.95	99
15+20+22+22	1.34	1.74	2.61	2.61	-	8.30 (3.40-10.70)	2.087 (0.690-3.840)	9.17	99
15+20+22+25	1.31	1.69	2.54	2.77	-	8.30 (3.40-10.70)	2.087 (0.690-3.780)	9.17	99
15+20+22+35	1.26	1.63	2.45	2.96	-	8.30 (3.40-10.70)	2.087 (0.690-3.420)	9.17	99
15+20+22+42	1.12	1.45	2.17	3.56	-	8.30 (3.40-10.70)	2.087 (0.690-3.420)	9.17	99
15+20+22+50	0.98	1.27	1.90	4.15	-	8.30 (3.40-10.70)	2.087 (0.690-3.420)	9.17	99
15+20+22+60	0.93	1.21	1.81	4.34	-	8.30 (3.40-10.70)	2.077 (0.690-3.410)	9.12	99
15+20+22+71	0.93	1.21	1.81	4.34	-	8.30 (3.40-10.70)	2.067 (0.690-3.400)	9.08	99
15+20+25+25	1.27	1.65	2.69	2.69	-	8.30 (3.40-10.70)	2.087 (0.690-3.600)	9.17	99
15+20+25+35	1.23	1.59	2.60	2.89	-	8.30 (3.40-10.70)	2.087 (0.690-3.420)	9.17	99
15+20+25+42	1.09	1.42	2.32	3.47	-	8.30 (3.40-10.70)	2.087 (0.690-3.420)	9.17	99
15+20+25+50	0.96	1.24	2.03	4.07	-	8.30 (3.40-10.70)	2.087 (0.690-3.420)	9.17	99
15+20+25+60	0.92	1.19	1.94	4.26	-	8.30 (3.40-10.70)	2.077 (0.690-3.410)	9.12	99
15+20+25+71	0.92	1.19	1.94	4.26	-	8.30 (3.40-10.70)	2.067 (0.690-3.400)	9.08	99
15+20+35+35	1.19	1.53	2.79	2.79	-	8.30 (3.40-10.70)	2.087 (0.690-3.420)	9.17	99
15+20+35+42	1.06	1.37	2.50	3.37	-	8.30 (3.40-10.70)	2.087 (0.690-3.420)	9.17	99
15+20+35+50	0.93	1.21	2.20	3.96	-	8.30 (3.40-10.70)	2.087 (0.690-3.420)	9.17	99
15+20+35+60	0.89	1.16	2.10	4.15	-	8.30 (3.40-10.70)	2.077 (0.690-3.410)	9.12	99
15+20+35+71	0.89	1.16	2.10	4.15	-	8.30 (3.40-10.70)	2.067 (0.690-3.400)	9.08	99
15+20+42+42	0.96	1.24	3.05	3.05	-	8.30 (3.40-10.70)	2.087 (0.690-3.420)	9.17	99
15+20+42+50	0.86	1.11	2.72	3.62	-	8.30 (3.40-10.70)	2.087 (0.690-3.420)	9.17	99
15+20+42+60	0.82	1.06	2.61	3.81	-	8.30 (3.40-10.70)	2.077 (0.690-3.410)	9.12	99
15+20+50+50	0.77	1.00	3.27	3.27	-	8.30 (3.40-10.70)	2.087 (0.690-3.420)	9.17	99

MXZ-4D83VA HEATING

Indoor units combination	Heating capacity (kW)						Outdoor unit power consumption(kW)	Current (A)	Power factor(%)
	Unit A	Unit B	Unit C	Unit D	Unit E	Total			
15+20+50+60	0.74	0.96	3.15	3.45	-	8.30 (3.40-10.70)	2.077 (0.690-3.410)	9.12	99
15+22+22+22	1.25	2.42	2.42	2.42	-	8.50 (3.40-10.90)	2.117 (0.640-3.840)	9.30	99
15+22+22+25	1.21	2.36	2.36	2.57	-	8.50 (3.40-10.90)	2.117 (0.640-3.660)	9.30	99
15+22+22+35	1.17	2.28	2.28	2.76	-	8.50 (3.40-10.90)	2.117 (0.640-3.420)	9.30	99
15+22+22+42	1.05	2.05	2.05	3.35	-	8.50 (3.40-10.90)	2.117 (0.640-3.420)	9.30	99
15+22+22+50	0.93	1.81	1.81	3.95	-	8.50 (3.40-10.90)	2.117 (0.640-3.420)	9.30	99
15+22+22+60	0.89	1.73	1.73	4.15	-	8.50 (3.40-10.90)	2.107 (0.640-3.410)	9.25	99
15+22+22+71	0.89	1.73	1.73	4.15	-	8.50 (3.40-10.90)	2.097 (0.640-3.400)	9.21	99
15+22+25+25	1.18	2.30	2.51	2.51	-	8.50 (3.40-10.90)	2.117 (0.640-3.480)	9.30	99
15+22+25+35	1.15	2.23	2.43	2.70	-	8.50 (3.40-10.90)	2.117 (0.640-3.420)	9.30	99
15+22+25+42	1.03	2.00	2.19	3.28	-	8.50 (3.40-10.90)	2.117 (0.640-3.420)	9.30	99
15+22+25+50	0.91	1.78	1.94	3.87	-	8.50 (3.40-10.90)	2.117 (0.640-3.420)	9.30	99
15+22+25+60	0.88	1.70	1.85	4.07	-	8.50 (3.40-10.90)	2.107 (0.640-3.410)	9.25	99
15+22+25+71	0.88	1.70	1.85	4.07	-	8.50 (3.40-10.90)	2.097 (0.640-3.400)	9.21	99
15+22+35+35	1.11	2.16	2.62	2.62	-	8.50 (3.40-10.90)	2.117 (0.640-3.420)	9.30	99
15+22+35+42	1.00	1.95	2.36	3.19	-	8.50 (3.40-10.90)	2.117 (0.640-3.420)	9.30	99
15+22+35+50	0.89	1.73	2.10	3.78	-	8.50 (3.40-10.90)	2.117 (0.640-3.420)	9.30	99
15+22+35+60	0.86	1.66	2.01	3.97	-	8.50 (3.40-10.90)	2.107 (0.640-3.410)	9.25	99
15+22+35+71	0.86	1.66	2.01	3.97	-	8.50 (3.40-10.90)	2.097 (0.640-3.400)	9.21	99
15+22+42+42	0.91	1.78	2.91	2.91	-	8.50 (3.40-10.90)	2.117 (0.640-3.420)	9.30	99
15+22+42+50	0.82	1.59	2.61	3.48	-	8.50 (3.40-10.90)	2.117 (0.640-3.420)	9.30	99
15+22+42+60	0.79	1.53	2.51	3.67	-	8.50 (3.40-10.90)	2.107 (0.640-3.410)	9.25	99
15+22+50+50	0.74	1.45	3.15	3.15	-	8.50 (3.40-10.90)	2.117 (0.640-3.420)	9.30	99
15+25+25+25	1.16	2.45	2.45	2.45	-	8.50 (3.40-10.90)	2.117 (0.640-3.420)	9.30	99
15+25+25+35	1.12	2.37	2.37	2.64	-	8.50 (3.40-10.90)	2.117 (0.640-3.420)	9.30	99
15+25+25+42	1.01	2.14	2.14	3.21	-	8.50 (3.40-10.90)	2.117 (0.640-3.420)	9.30	99
15+25+25+50	0.90	1.90	1.90	3.80	-	8.50 (3.40-10.90)	2.117 (0.640-3.420)	9.30	99
15+25+25+60	0.86	1.82	1.82	4.00	-	8.50 (3.40-10.90)	2.107 (0.640-3.410)	9.25	99
15+25+25+71	0.86	1.82	1.82	4.00	-	8.50 (3.40-10.90)	2.097 (0.640-3.400)	9.21	99
15+25+35+35	1.09	2.30	2.56	2.56	-	8.50 (3.40-10.90)	2.117 (0.640-3.420)	9.30	99
15+25+35+42	0.98	2.08	2.31	3.12	-	8.50 (3.40-10.90)	2.117 (0.640-3.420)	9.30	99
15+25+35+50	0.88	1.85	2.06	3.71	-	8.50 (3.40-10.90)	2.117 (0.640-3.420)	9.30	99
15+25+35+60	0.84	1.78	1.98	3.90	-	8.50 (3.40-10.90)	2.107 (0.640-3.410)	9.25	99
15+25+42+42	0.90	1.90	2.85	2.85	-	8.50 (3.40-10.90)	2.117 (0.640-3.420)	9.30	99
15+25+42+50	0.81	1.71	2.56	3.42	-	8.50 (3.40-10.90)	2.117 (0.640-3.420)	9.30	99
15+25+42+60	0.78	1.65	2.47	3.61	-	8.50 (3.40-10.90)	2.107 (0.640-3.410)	9.25	99
15+25+50+50	0.73	1.55	3.11	3.11	-	8.50 (3.40-10.90)	2.117 (0.640-3.420)	9.30	99
15+35+35+35	1.05	2.48	2.48	2.48	-	8.50 (3.40-10.90)	2.117 (0.640-3.420)	9.30	99
15+35+35+42	0.96	2.25	2.25	3.04	-	8.50 (3.40-10.90)	2.117 (0.640-3.420)	9.30	99
15+35+35+50	0.86	2.01	2.01	3.62	-	8.50 (3.40-10.90)	2.117 (0.640-3.420)	9.30	99
15+35+35+60	0.82	1.93	1.93	3.82	-	8.50 (3.40-10.90)	2.107 (0.640-3.410)	9.25	99

MXZ-4D83VA HEATING

Indoor units combination	Heating capacity (kW)						Outdoor unit power consumption(kW)	Current (A)	Power factor(%)
	Unit A	Unit B	Unit C	Unit D	Unit E	Total			
15+35+42+42	0.88	2.06	2.78	2.78	-	8.50 (3.40-10.90)	2.117 (0.640-3.420)	9.30	99
15+35+42+50	0.79	1.86	2.51	3.34	-	8.50 (3.40-10.90)	2.117 (0.640-3.420)	9.30	99
15+42+42+42	0.81	2.56	2.56	2.56	-	8.50 (3.40-10.90)	2.117 (0.640-3.420)	9.30	99
18+18+18+18	2.25	2.25	2.25	2.25	-	9.00 (3.40-11.60)	2.312 (0.590-3.420)	10.15	99
18+18+18+20	2.40	2.40	2.40	1.60	-	8.80 (3.40-11.40)	2.282 (0.640-3.540)	10.02	99
18+18+18+22	2.25	2.25	2.25	2.25	-	9.00 (3.40-11.60)	2.312 (0.590-3.660)	10.15	99
18+18+18+25	2.20	2.20	2.20	2.40	-	9.00 (3.40-11.60)	2.312 (0.590-3.840)	10.15	99
18+18+18+35	2.14	2.14	2.14	2.59	-	9.00 (3.40-11.60)	2.312 (0.590-3.420)	10.15	99
18+18+18+42	1.94	1.94	1.94	3.18	-	9.00 (3.40-11.60)	2.312 (0.590-3.420)	10.15	99
18+18+18+50	1.74	1.74	1.74	3.79	-	9.00 (3.40-11.60)	2.312 (0.590-3.420)	10.15	99
18+18+18+60	1.67	1.67	1.67	3.99	-	9.00 (3.40-11.60)	2.302 (0.590-3.410)	10.11	99
18+18+18+71	1.67	1.67	1.67	3.99	-	9.00 (3.40-11.60)	2.292 (0.590-3.400)	10.07	99
18+18+20+20	2.58	2.58	1.72	1.72	-	8.60 (3.40-11.20)	2.252 (0.690-3.660)	9.89	99
18+18+20+22	2.40	2.40	1.60	2.40	-	8.80 (3.40-11.40)	2.282 (0.640-3.780)	10.02	99
18+18+20+25	2.34	2.34	1.56	2.55	-	8.80 (3.40-11.40)	2.282 (0.640-3.840)	10.02	99
18+18+20+35	2.27	2.27	1.51	2.75	-	8.80 (3.40-11.40)	2.282 (0.640-3.420)	10.02	99
18+18+20+42	2.05	2.05	1.36	3.35	-	8.80 (3.40-11.40)	2.282 (0.640-3.420)	10.02	99
18+18+20+50	1.82	1.82	1.21	3.96	-	8.80 (3.40-11.40)	2.282 (0.640-3.420)	10.02	99
18+18+20+60	1.74	1.74	1.16	4.16	-	8.80 (3.40-11.40)	2.272 (0.640-3.410)	9.98	99
18+18+20+71	1.74	1.74	1.16	4.16	-	8.80 (3.40-11.40)	2.262 (0.640-3.400)	9.93	99
18+18+22+22	2.25	2.25	2.25	2.25	-	9.00 (3.40-11.60)	2.312 (0.590-3.900)	10.15	99
18+18+22+25	2.20	2.20	2.20	2.40	-	9.00 (3.40-11.60)	2.312 (0.590-3.420)	10.15	99
18+18+22+35	2.14	2.14	2.14	2.59	-	9.00 (3.40-11.60)	2.312 (0.590-3.420)	10.15	99
18+18+22+42	1.94	1.94	1.94	3.18	-	9.00 (3.40-11.60)	2.312 (0.590-3.420)	10.15	99
18+18+22+50	1.74	1.74	1.74	3.79	-	9.00 (3.40-11.60)	2.312 (0.590-3.420)	10.15	99
18+18+22+60	1.67	1.67	1.67	3.99	-	9.00 (3.40-11.60)	2.302 (0.590-3.410)	10.11	99
18+18+22+71	1.67	1.67	1.67	3.99	-	9.00 (3.40-11.60)	2.292 (0.590-3.400)	10.07	99
18+18+25+25	2.15	2.15	2.35	2.35	-	9.00 (3.40-11.60)	2.312 (0.590-3.540)	10.15	99
18+18+25+35	2.09	2.09	2.28	2.54	-	9.00 (3.40-11.60)	2.312 (0.590-3.420)	10.15	99
18+18+25+42	1.90	1.90	2.08	3.12	-	9.00 (3.40-11.60)	2.312 (0.590-3.420)	10.15	99
18+18+25+50	1.71	1.71	1.86	3.72	-	9.00 (3.40-11.60)	2.312 (0.590-3.420)	10.15	99
18+18+25+60	1.64	1.64	1.79	3.93	-	9.00 (3.40-11.60)	2.302 (0.590-3.410)	10.11	99
18+18+25+71	1.64	1.64	1.79	3.93	-	9.00 (3.40-11.60)	2.292 (0.590-3.400)	10.07	99
18+18+35+35	2.03	2.03	2.47	2.47	-	9.00 (3.40-11.60)	2.312 (0.590-3.420)	10.15	99
18+18+35+42	1.86	1.86	2.25	3.04	-	9.00 (3.40-11.60)	2.312 (0.590-3.420)	10.15	99
18+18+35+50	1.67	1.67	2.02	3.64	-	9.00 (3.40-11.60)	2.312 (0.590-3.420)	10.15	99
18+18+35+60	1.61	1.61	1.95	3.84	-	9.00 (3.40-11.60)	2.302 (0.590-3.410)	10.11	99
18+18+35+71	1.61	1.61	1.95	3.84	-	9.00 (3.40-11.60)	2.292 (0.590-3.400)	10.07	99
18+18+42+42	1.71	1.71	2.79	2.79	-	9.00 (3.40-11.60)	2.312 (0.590-3.420)	10.15	99
18+18+42+50	1.55	1.55	2.53	3.38	-	9.00 (3.40-11.60)	2.312 (0.590-3.420)	10.15	99
18+18+42+60	1.49	1.49	2.44	3.57	-	9.00 (3.40-11.60)	2.302 (0.590-3.410)	10.11	99

MXZ-4D83VA HEATING

Indoor units combination	Heating capacity (kW)						Outdoor unit power consumption(kW)	Current (A)	Power factor(%)
	Unit A	Unit B	Unit C	Unit D	Unit E	Total			
18+18+50+50	1.41	1.41	3.09	3.09	-	9.00 (3.40-11.60)	2.312 (0.590-3.420)	10.15	99
18+20+20+20	2.80	1.87	1.87	1.87	-	8.40 (3.40-11.00)	2.222 (0.740-3.780)	9.76	99
18+20+20+22	2.58	1.72	1.72	2.58	-	8.60 (3.40-11.20)	2.252 (0.690-3.900)	9.89	99
18+20+20+35	2.43	1.62	1.62	2.94	-	8.60 (3.40-11.20)	2.252 (0.690-3.420)	9.89	99
18+20+20+42	2.17	1.44	1.44	3.55	-	8.60 (3.40-11.20)	2.252 (0.690-3.420)	9.89	99
18+20+20+50	1.90	1.27	1.27	4.16	-	8.60 (3.40-11.20)	2.252 (0.690-3.420)	9.89	99
18+20+20+60	1.82	1.21	1.21	4.36	-	8.60 (3.40-11.20)	2.242 (0.690-3.410)	9.85	99
18+20+20+71	1.82	1.21	1.21	4.36	-	8.60 (3.40-11.20)	2.232 (0.690-3.400)	9.80	99
18+20+22+22	2.40	1.60	2.40	2.40	-	8.80 (3.40-11.40)	2.282 (0.640-3.780)	10.02	99
18+20+22+25	2.34	1.56	2.34	2.55	-	8.80 (3.40-11.40)	2.282 (0.640-3.600)	10.02	99
18+20+22+35	2.27	1.51	2.27	2.75	-	8.80 (3.40-11.40)	2.282 (0.640-3.420)	10.02	99
18+20+22+42	2.05	1.36	2.05	3.35	-	8.80 (3.40-11.40)	2.282 (0.640-3.420)	10.02	99
18+20+22+50	1.82	1.21	1.82	3.96	-	8.80 (3.40-11.40)	2.282 (0.640-3.420)	10.02	99
18+20+22+60	1.74	1.16	1.74	4.16	-	8.80 (3.40-11.40)	2.272 (0.640-3.410)	9.98	99
18+20+22+71	1.74	1.16	1.74	4.16	-	8.80 (3.40-11.40)	2.262 (0.640-3.400)	9.93	99
18+20+25+25	2.29	1.52	2.49	2.49	-	8.80 (3.40-11.40)	2.282 (0.640-3.420)	10.02	99
18+20+25+35	2.22	1.48	2.42	2.69	-	8.80 (3.40-11.40)	2.282 (0.640-3.420)	10.02	99
18+20+25+42	2.00	1.34	2.18	3.28	-	8.80 (3.40-11.40)	2.282 (0.640-3.420)	10.02	99
18+20+25+50	1.78	1.19	1.94	3.89	-	8.80 (3.40-11.40)	2.282 (0.640-3.420)	10.02	99
18+20+25+60	1.71	1.14	1.86	4.09	-	8.80 (3.40-11.40)	2.272 (0.640-3.410)	9.98	99
18+20+25+71	1.71	1.14	1.86	4.09	-	8.80 (3.40-11.40)	2.262 (0.640-3.400)	9.93	99
18+20+35+35	2.15	1.43	2.61	2.61	-	8.80 (3.40-11.40)	2.282 (0.640-3.420)	10.02	99
18+20+35+42	1.95	1.30	2.36	3.19	-	8.80 (3.40-11.40)	2.282 (0.640-3.420)	10.02	99
18+20+35+50	1.74	1.16	2.11	3.79	-	8.80 (3.40-11.40)	2.282 (0.640-3.420)	10.02	99
18+20+35+60	1.67	1.11	2.02	4.00	-	8.80 (3.40-11.40)	2.272 (0.640-3.410)	9.98	99
18+20+35+71	1.67	1.11	2.02	4.00	-	8.80 (3.40-11.40)	2.262 (0.640-3.400)	9.93	99
18+20+42+42	1.78	1.19	2.92	2.92	-	8.80 (3.40-11.40)	2.282 (0.640-3.420)	10.02	99
18+20+42+50	1.60	1.07	2.63	3.50	-	8.80 (3.40-11.40)	2.282 (0.640-3.420)	10.02	99
18+20+42+60	1.54	1.03	2.53	3.70	-	8.80 (3.40-11.40)	2.272 (0.640-3.410)	9.98	99
18+20+50+50	1.46	0.97	3.18	3.18	-	8.80 (3.40-11.40)	2.282 (0.640-3.420)	10.02	99
18+22+22+22	2.25	2.25	2.25	2.25	-	9.00 (3.40-11.60)	2.312 (0.590-3.660)	10.15	99
18+22+22+25	2.20	2.20	2.20	2.40	-	9.00 (3.40-11.60)	2.312 (0.590-3.480)	10.15	99
18+22+22+35	2.14	2.14	2.14	2.59	-	9.00 (3.40-11.60)	2.312 (0.590-3.420)	10.15	99
18+22+22+42	1.94	1.94	1.94	3.18	-	9.00 (3.40-11.60)	2.312 (0.590-3.420)	10.15	99
18+22+22+50	1.74	1.74	1.74	3.79	-	9.00 (3.40-11.60)	2.312 (0.590-3.420)	10.15	99
18+22+22+60	1.67	1.67	1.67	3.99	-	9.00 (3.40-11.60)	2.302 (0.590-3.410)	10.11	99
18+22+22+71	1.67	1.67	1.67	3.99	-	9.00 (3.40-11.60)	2.292 (0.590-3.400)	10.07	99
18+22+25+25	2.15	2.15	2.35	2.35	-	9.00 (3.40-11.60)	2.312 (0.590-3.420)	10.15	99
18+22+25+35	2.09	2.09	2.28	2.54	-	9.00 (3.40-11.60)	2.312 (0.590-3.420)	10.15	99
18+22+25+42	1.90	1.90	2.08	3.12	-	9.00 (3.40-11.60)	2.312 (0.590-3.420)	10.15	99
18+22+25+50	1.71	1.71	1.86	3.72	-	9.00 (3.40-11.60)	2.312 (0.590-3.420)	10.15	99

MXZ-4D83VA HEATING

Indoor units combination	Heating capacity (kW)						Outdoor unit power consumption(kW)	Current (A)	Power factor(%)
	Unit A	Unit B	Unit C	Unit D	Unit E	Total			
18+22+25+60	1.64	1.64	1.79	3.93	-	9.00 (3.40-11.60)	2.302 (0.590-3.410)	10.11	99
18+22+25+71	1.64	1.64	1.79	3.93	-	9.00 (3.40-11.60)	2.292 (0.590-3.400)	10.07	99
18+22+35+35	2.03	2.03	2.47	2.47	-	9.00 (3.40-11.60)	2.312 (0.590-3.420)	10.15	99
18+22+35+42	1.86	1.86	2.25	3.04	-	9.00 (3.40-11.60)	2.312 (0.590-3.420)	10.15	99
18+22+35+50	1.67	1.67	2.02	3.64	-	9.00 (3.40-11.60)	2.312 (0.590-3.420)	10.15	99
18+22+35+60	1.61	1.61	1.95	3.84	-	9.00 (3.40-11.60)	2.302 (0.590-3.410)	10.11	99
18+22+42+42	1.71	1.71	2.79	2.79	-	9.00 (3.40-11.60)	2.312 (0.590-3.420)	10.15	99
18+22+42+50	1.55	1.55	2.53	3.38	-	9.00 (3.40-11.60)	2.312 (0.590-3.420)	10.15	99
18+22+42+60	1.49	1.49	2.44	3.57	-	9.00 (3.40-11.60)	2.302 (0.590-3.410)	10.11	99
18+22+50+50	1.41	1.41	3.09	3.09	-	9.00 (3.40-11.60)	2.312 (0.590-3.420)	10.15	99
18+25+25+25	2.11	2.30	2.30	2.30	-	9.00 (3.40-11.60)	2.312 (0.590-3.420)	10.15	99
18+25+25+35	2.05	2.23	2.23	2.48	-	9.00 (3.40-11.60)	2.312 (0.590-3.420)	10.15	99
18+25+25+42	1.87	2.04	2.04	3.06	-	9.00 (3.40-11.60)	2.312 (0.590-3.420)	10.15	99
18+25+25+50	1.68	1.83	1.83	3.66	-	9.00 (3.40-11.60)	2.312 (0.590-3.420)	10.15	99
18+25+25+60	1.61	1.76	1.76	3.86	-	9.00 (3.40-11.60)	2.302 (0.590-3.410)	10.11	99
18+25+25+71	1.61	1.76	1.76	3.86	-	9.00 (3.40-11.60)	2.292 (0.590-3.400)	10.07	99
18+25+35+35	1.99	2.17	2.42	2.42	-	9.00 (3.40-11.60)	2.312 (0.590-3.420)	10.15	99
18+25+35+42	1.82	1.99	2.21	2.98	-	9.00 (3.40-11.60)	2.312 (0.590-3.420)	10.15	99
18+25+35+50	1.64	1.79	1.99	3.58	-	9.00 (3.40-11.60)	2.312 (0.590-3.420)	10.15	99
18+25+35+60	1.58	1.72	1.91	3.78	-	9.00 (3.40-11.60)	2.302 (0.590-3.410)	10.11	99
18+25+42+42	1.68	1.83	2.75	2.75	-	9.00 (3.40-11.60)	2.312 (0.590-3.420)	10.15	99
18+25+42+50	1.52	1.66	2.49	3.32	-	9.00 (3.40-11.60)	2.312 (0.590-3.420)	10.15	99
18+25+42+60	1.47	1.60	2.41	3.52	-	9.00 (3.40-11.60)	2.302 (0.590-3.410)	10.11	99
18+25+50+50	1.39	1.52	3.04	3.04	-	9.00 (3.40-11.60)	2.312 (0.590-3.420)	10.15	99
18+35+35+35	1.94	2.35	2.35	2.35	-	9.00 (3.40-11.60)	2.312 (0.590-3.420)	10.15	99
18+35+35+42	1.78	2.16	2.16	2.91	-	9.00 (3.40-11.60)	2.312 (0.590-3.420)	10.15	99
18+35+35+50	1.61	1.95	1.95	3.50	-	9.00 (3.40-11.60)	2.312 (0.590-3.420)	10.15	99
18+35+42+42	1.64	1.99	2.69	2.69	-	9.00 (3.40-11.60)	2.312 (0.590-3.420)	10.15	99
18+35+42+50	1.49	1.81	2.44	3.26	-	9.00 (3.40-11.60)	2.312 (0.590-3.420)	10.15	99
18+42+42+42	1.52	2.49	2.49	2.49	-	9.00 (3.40-11.60)	2.312 (0.590-3.420)	10.15	99
20+20+20+20	2.05	2.05	2.05	2.05	-	8.20 (3.40-10.80)	2.192 (0.790-3.900)	9.63	99
20+20+20+22	1.87	1.87	1.87	2.80	-	8.40 (3.40-11.00)	2.222 (0.740-3.780)	9.76	99
20+20+20+25	1.81	1.81	1.81	2.96	-	8.40 (3.40-11.00)	2.222 (0.740-3.600)	9.76	99
20+20+20+35	1.74	1.74	1.74	3.17	-	8.40 (3.40-11.00)	2.222 (0.740-3.420)	9.76	99
20+20+20+42	1.54	1.54	1.54	3.78	-	8.40 (3.40-11.00)	2.222 (0.740-3.420)	9.76	99
20+20+20+50	1.34	1.34	1.34	4.38	-	8.40 (3.40-11.00)	2.222 (0.740-3.420)	9.76	99
20+20+20+60	1.27	1.27	1.27	4.58	-	8.40 (3.40-11.00)	2.212 (0.740-3.410)	9.71	99
20+20+20+71	1.27	1.27	1.27	4.58	-	8.40 (3.40-11.00)	2.202 (0.740-3.400)	9.67	99
20+20+22+22	1.72	1.72	2.58	2.58	-	8.60 (3.40-11.20)	2.252 (0.690-3.660)	9.89	99
20+20+22+25	1.67	1.67	2.51	2.74	-	8.60 (3.40-11.20)	2.252 (0.690-3.480)	9.89	99
20+20+22+35	1.62	1.62	2.43	2.94	-	8.60 (3.40-11.20)	2.252 (0.690-3.420)	9.89	99

MXZ-4D83VA HEATING

Indoor units combination	Heating capacity (kW)						Outdoor unit power consumption(kW)	Current (A)	Power factor(%)
	Unit A	Unit B	Unit C	Unit D	Unit E	Total			
20+20+22+42	1.44	1.44	2.17	3.55	-	8.60 (3.40-11.20)	2.252 (0.690-3.420)	9.89	99
20+20+22+50	1.27	1.27	1.90	4.16	-	8.60 (3.40-11.20)	2.252 (0.690-3.420)	9.89	99
20+20+22+60	1.21	1.21	1.82	4.36	-	8.60 (3.40-11.20)	2.242 (0.690-3.410)	9.85	99
20+20+22+71	1.21	1.21	1.82	4.36	-	8.60 (3.40-11.20)	2.232 (0.690-3.400)	9.80	99
20+20+25+25	1.63	1.63	2.67	2.67	-	8.60 (3.40-11.20)	2.252 (0.690-3.420)	9.89	99
20+20+25+35	1.58	1.58	2.58	2.87	-	8.60 (3.40-11.20)	2.252 (0.690-3.420)	9.89	99
20+20+25+42	1.41	1.41	2.31	3.47	-	8.60 (3.40-11.20)	2.252 (0.690-3.420)	9.89	99
20+20+25+50	1.24	1.24	2.04	4.07	-	8.60 (3.40-11.20)	2.252 (0.690-3.420)	9.89	99
20+20+25+60	1.19	1.19	1.95	4.27	-	8.60 (3.40-11.20)	2.242 (0.690-3.410)	9.85	99
20+20+25+71	1.19	1.19	1.95	4.27	-	8.60 (3.40-11.20)	2.232 (0.690-3.400)	9.80	99
20+20+35+35	1.53	1.53	2.77	2.77	-	8.60 (3.40-11.20)	2.252 (0.690-3.420)	9.89	99
20+20+35+42	1.37	1.37	2.49	3.37	-	8.60 (3.40-11.20)	2.252 (0.690-3.420)	9.89	99
20+20+35+50	1.21	1.21	2.21	3.97	-	8.60 (3.40-11.20)	2.252 (0.690-3.420)	9.89	99
20+20+35+60	1.16	1.16	2.11	4.17	-	8.60 (3.40-11.20)	2.242 (0.690-3.410)	9.85	99
20+20+42+42	1.24	1.24	3.06	3.06	-	8.60 (3.40-11.20)	2.252 (0.690-3.420)	9.89	99
20+20+42+50	1.11	1.11	2.73	3.64	-	8.60 (3.40-11.20)	2.252 (0.690-3.420)	9.89	99
20+20+42+60	1.07	1.07	2.62	3.84	-	8.60 (3.40-11.20)	2.242 (0.690-3.410)	9.85	99
20+20+50+50	1.01	1.01	3.29	3.29	-	8.60 (3.40-11.20)	2.252 (0.690-3.420)	9.89	99
20+22+22+22	1.60	2.40	2.40	2.40	-	8.80 (3.40-11.40)	2.282 (0.640-3.540)	10.02	99
20+22+22+25	1.56	2.34	2.34	2.55	-	8.80 (3.40-11.40)	2.282 (0.640-3.420)	10.02	99
20+22+22+35	1.51	2.27	2.27	2.75	-	8.80 (3.40-11.40)	2.282 (0.640-3.420)	10.02	99
20+22+22+42	1.36	2.05	2.05	3.35	-	8.80 (3.40-11.40)	2.282 (0.640-3.420)	10.02	99
20+22+22+50	1.21	1.82	1.82	3.96	-	8.80 (3.40-11.40)	2.282 (0.640-3.420)	10.02	99
20+22+22+60	1.16	1.74	1.74	4.16	-	8.80 (3.40-11.40)	2.272 (0.640-3.410)	9.98	99
20+22+22+71	1.16	1.74	1.74	4.16	-	8.80 (3.40-11.40)	2.262 (0.640-3.400)	9.93	99
20+22+25+25	1.52	2.29	2.49	2.49	-	8.80 (3.40-11.40)	2.282 (0.640-3.420)	10.02	99
20+22+25+35	1.48	2.22	2.42	2.69	-	8.80 (3.40-11.40)	2.282 (0.640-3.420)	10.02	99
20+22+25+42	1.34	2.00	2.18	3.28	-	8.80 (3.40-11.40)	2.282 (0.640-3.420)	10.02	99
20+22+25+50	1.19	1.78	1.94	3.89	-	8.80 (3.40-11.40)	2.282 (0.640-3.420)	10.02	99
20+22+25+60	1.14	1.71	1.86	4.09	-	8.80 (3.40-11.40)	2.272 (0.640-3.410)	9.98	99
20+22+25+71	1.14	1.71	1.86	4.09	-	8.80 (3.40-11.40)	2.262 (0.640-3.400)	9.93	99
20+22+35+35	1.43	2.15	2.61	2.61	-	8.80 (3.40-11.40)	2.282 (0.640-3.420)	10.02	99
20+22+35+42	1.30	1.95	2.36	3.19	-	8.80 (3.40-11.40)	2.282 (0.640-3.420)	10.02	99
20+22+35+50	1.16	1.74	2.11	3.79	-	8.80 (3.40-11.40)	2.282 (0.640-3.420)	10.02	99
20+22+35+60	1.11	1.67	2.02	4.00	-	8.80 (3.40-11.40)	2.272 (0.640-3.410)	9.98	99
20+22+42+42	1.19	1.78	2.92	2.92	-	8.80 (3.40-11.40)	2.282 (0.640-3.420)	10.02	99
20+22+42+50	1.07	1.60	2.63	3.50	-	8.80 (3.40-11.40)	2.282 (0.640-3.420)	10.02	99
20+22+42+60	1.03	1.54	2.53	3.70	-	8.80 (3.40-11.40)	2.272 (0.640-3.410)	9.98	99
20+22+50+50	0.97	1.46	3.18	3.18	-	8.80 (3.40-11.40)	2.282 (0.640-3.420)	10.02	99
20+25+25+25	1.49	2.44	2.44	2.44	-	8.80 (3.40-11.40)	2.282 (0.640-3.420)	10.02	99
20+25+25+35	1.44	2.36	2.36	2.63	-	8.80 (3.40-11.40)	2.282 (0.640-3.420)	10.02	99

MXZ-4D83VA HEATING

Indoor units combination	Heating capacity (kW)						Outdoor unit power consumption(kW)	Current (A)	Power factor(%)
	Unit A	Unit B	Unit C	Unit D	Unit E	Total			
20+25+25+42	1.31	2.14	2.14	3.21	-	8.80 (3.40-11.40)	2.282 (0.640-3.420)	10.02	99
20+25+25+50	1.17	1.91	1.91	3.82	-	8.80 (3.40-11.40)	2.282 (0.640-3.420)	10.02	99
20+25+25+60	1.12	1.83	1.83	4.02	-	8.80 (3.40-11.40)	2.272 (0.640-3.410)	9.98	99
20+25+25+71	1.12	1.83	1.83	4.02	-	8.80 (3.40-11.40)	2.262 (0.640-3.400)	9.93	99
20+25+35+35	1.40	2.30	2.55	2.55	-	8.80 (3.40-11.40)	2.282 (0.640-3.420)	10.02	99
20+25+35+42	1.27	2.08	2.32	3.13	-	8.80 (3.40-11.40)	2.282 (0.640-3.420)	10.02	99
20+25+35+50	1.14	1.86	2.07	3.73	-	8.80 (3.40-11.40)	2.282 (0.640-3.420)	10.02	99
20+25+35+60	1.09	1.79	1.99	3.93	-	8.80 (3.40-11.40)	2.272 (0.640-3.410)	9.98	99
20+25+42+42	1.17	1.91	2.86	2.86	-	8.80 (3.40-11.40)	2.282 (0.640-3.420)	10.02	99
20+25+42+50	1.05	1.72	2.58	3.44	-	8.80 (3.40-11.40)	2.282 (0.640-3.420)	10.02	99
20+25+50+50	0.96	1.57	3.14	3.14	-	8.80 (3.40-11.40)	2.282 (0.640-3.420)	10.02	99
20+35+35+35	1.36	2.48	2.48	2.48	-	8.80 (3.40-11.40)	2.282 (0.640-3.420)	10.02	99
20+35+35+42	1.24	2.26	2.26	3.05	-	8.80 (3.40-11.40)	2.282 (0.640-3.420)	10.02	99
20+35+35+50	1.11	2.02	2.02	3.64	-	8.80 (3.40-11.40)	2.282 (0.640-3.420)	10.02	99
20+35+42+42	1.14	2.07	2.80	2.80	-	8.80 (3.40-11.40)	2.282 (0.640-3.420)	10.02	99
22+22+22+22	2.25	2.25	2.25	2.25	-	9.00 (3.40-11.60)	2.312 (0.590-3.420)	10.15	99
22+22+22+25	2.20	2.20	2.20	2.40	-	9.00 (3.40-11.60)	2.312 (0.590-3.420)	10.15	99
22+22+22+35	2.14	2.14	2.14	2.59	-	9.00 (3.40-11.60)	2.312 (0.590-3.420)	10.15	99
22+22+22+42	1.94	1.94	1.94	3.18	-	9.00 (3.40-11.60)	2.312 (0.590-3.420)	10.15	99
22+22+22+50	1.74	1.74	1.74	3.79	-	9.00 (3.40-11.60)	2.312 (0.590-3.420)	10.15	99
22+22+22+60	1.67	1.67	1.67	3.99	-	9.00 (3.40-11.60)	2.302 (0.590-3.410)	10.11	99
22+22+22+71	1.67	1.67	1.67	3.99	-	9.00 (3.40-11.60)	2.292 (0.590-3.400)	10.07	99
22+22+25+25	2.15	2.15	2.35	2.35	-	9.00 (3.40-11.60)	2.312 (0.590-3.420)	10.15	99
22+22+25+35	2.09	2.09	2.28	2.54	-	9.00 (3.40-11.60)	2.312 (0.590-3.420)	10.15	99
22+22+25+42	1.90	1.90	2.08	3.12	-	9.00 (3.40-11.60)	2.312 (0.590-3.420)	10.15	99
22+22+25+50	1.71	1.71	1.86	3.72	-	9.00 (3.40-11.60)	2.312 (0.590-3.420)	10.15	99
22+22+25+60	1.64	1.64	1.79	3.93	-	9.00 (3.40-11.60)	2.302 (0.590-3.410)	10.11	99
22+22+25+71	1.64	1.64	1.79	3.93	-	9.00 (3.40-11.60)	2.292 (0.590-3.400)	10.07	99
22+22+35+35	2.03	2.03	2.47	2.47	-	9.00 (3.40-11.60)	2.312 (0.590-3.420)	10.15	99
22+22+35+42	1.86	1.86	2.25	3.04	-	9.00 (3.40-11.60)	2.312 (0.590-3.420)	10.15	99
22+22+35+50	1.67	1.67	2.02	3.64	-	9.00 (3.40-11.60)	2.312 (0.590-3.420)	10.15	99
22+22+35+60	1.61	1.61	1.95	3.84	-	9.00 (3.40-11.60)	2.302 (0.590-3.410)	10.11	99
22+22+42+42	1.71	1.71	2.79	2.79	-	9.00 (3.40-11.60)	2.312 (0.590-3.420)	10.15	99
22+22+42+50	1.55	1.55	2.53	3.38	-	9.00 (3.40-11.60)	2.312 (0.590-3.420)	10.15	99
22+22+50+50	1.41	1.41	3.09	3.09	-	9.00 (3.40-11.60)	2.312 (0.590-3.420)	10.15	99
22+25+25+25	2.11	2.30	2.30	2.30	-	9.00 (3.40-11.60)	2.312 (0.590-3.420)	10.15	99
22+25+25+35	2.05	2.23	2.23	2.48	-	9.00 (3.40-11.60)	2.312 (0.590-3.420)	10.15	99
22+25+25+42	1.87	2.04	2.04	3.06	-	9.00 (3.40-11.60)	2.312 (0.590-3.420)	10.15	99
22+25+25+50	1.68	1.83	1.83	3.66	-	9.00 (3.40-11.60)	2.312 (0.590-3.420)	10.15	99
22+25+25+60	1.61	1.76	1.76	3.86	-	9.00 (3.40-11.60)	2.302 (0.590-3.410)	10.11	99
22+25+25+71	1.61	1.76	1.76	3.86	-	9.00 (3.40-11.60)	2.292 (0.590-3.400)	10.07	99

MXZ-4D83VA HEATING

Indoor units combination	Heating capacity (kW)						Outdoor unit power consumption(kW)	Current (A)	Power factor(%)
	Unit A	Unit B	Unit C	Unit D	Unit E	Total			
22+25+35+35	1.99	2.17	2.42	2.42	-	9.00 (3.40-11.60)	2.312 (0.590-3.420)	10.15	99
22+25+35+42	1.82	1.99	2.21	2.98	-	9.00 (3.40-11.60)	2.312 (0.590-3.420)	10.15	99
22+25+35+50	1.64	1.79	1.99	3.58	-	9.00 (3.40-11.60)	2.312 (0.590-3.420)	10.15	99
22+25+35+60	1.58	1.72	1.91	3.78	-	9.00 (3.40-11.60)	2.302 (0.590-3.410)	10.11	99
22+25+42+42	1.68	1.83	2.75	2.75	-	9.00 (3.40-11.60)	2.312 (0.590-3.420)	10.15	99
22+25+42+50	1.52	1.66	2.49	3.32	-	9.00 (3.40-11.60)	2.312 (0.590-3.420)	10.15	99
22+35+35+35	1.94	2.35	2.35	2.35	-	9.00 (3.40-11.60)	2.312 (0.590-3.420)	10.15	99
22+35+35+42	1.78	2.16	2.16	2.91	-	9.00 (3.40-11.60)	2.312 (0.590-3.420)	10.15	99
22+35+35+50	1.61	1.95	1.95	3.50	-	9.00 (3.40-11.60)	2.312 (0.590-3.420)	10.15	99
22+35+42+42	1.64	1.99	2.69	2.69	-	9.00 (3.40-11.60)	2.312 (0.590-3.420)	10.15	99
25+25+25+25	2.25	2.25	2.25	2.25	-	9.00 (3.40-11.60)	2.312 (0.590-3.420)	10.15	99
25+25+25+35	2.19	2.19	2.19	2.43	-	9.00 (3.40-11.60)	2.312 (0.590-3.420)	10.15	99
25+25+25+42	2.00	2.00	2.00	3.00	-	9.00 (3.40-11.60)	2.312 (0.590-3.420)	10.15	99
25+25+25+50	1.80	1.80	1.80	3.60	-	9.00 (3.40-11.60)	2.312 (0.590-3.420)	10.15	99
25+25+25+60	1.73	1.73	1.73	3.80	-	9.00 (3.40-11.60)	2.302 (0.590-3.410)	10.11	99
25+25+35+35	2.13	2.13	2.37	2.37	-	9.00 (3.40-11.60)	2.312 (0.590-3.420)	10.15	99
25+25+35+42	1.95	1.95	2.17	2.93	-	9.00 (3.40-11.60)	2.312 (0.590-3.420)	10.15	99
25+25+35+50	1.76	1.76	1.96	3.52	-	9.00 (3.40-11.60)	2.312 (0.590-3.420)	10.15	99
25+25+35+60	1.70	1.70	1.88	3.72	-	9.00 (3.40-11.60)	2.302 (0.590-3.410)	10.11	99
25+25+42+42	1.80	1.80	2.70	2.70	-	9.00 (3.40-11.60)	2.312 (0.590-3.420)	10.15	99
25+25+42+50	1.64	1.64	2.45	3.27	-	9.00 (3.40-11.60)	2.312 (0.590-3.420)	10.15	99
25+35+35+35	2.08	2.31	2.31	2.31	-	9.00 (3.40-11.60)	2.312 (0.590-3.420)	10.15	99
25+35+35+42	1.91	2.12	2.12	2.86	-	9.00 (3.40-11.60)	2.312 (0.590-3.420)	10.15	99
25+35+35+50	1.72	1.91	1.91	3.45	-	9.00 (3.40-11.60)	2.312 (0.590-3.420)	10.15	99
25+35+42+42	1.76	1.96	2.64	2.64	-	9.00 (3.40-11.60)	2.312 (0.590-3.420)	10.15	99
35+35+35+35	2.25	2.25	2.25	2.25	-	9.00 (3.40-11.60)	2.312 (0.590-3.420)	10.15	99

MXZ-5D102VA COOLING

Indoor units combination	Cooling capacity (kW)						Outdoor unit power consumption(kW)	Current (A)	Power factor(%)
	Unit A	Unit B	Unit C	Unit D	Unit E	Total			
15	1.50	-	-	-	-	1.50 (1.40-2.10)	0.540 (0.470-1.000)	2.37	99
18	1.80	-	-	-	-	1.80 (1.40-3.00)	0.560 (0.400-0.920)	2.46	99
20	2.00	-	-	-	-	2.00 (1.40-2.80)	0.720 (0.470-1.330)	3.16	99
22	2.20	-	-	-	-	2.20 (1.40-3.00)	0.680 (0.400-0.920)	2.99	99
25	2.50	-	-	-	-	2.50 (1.40-3.30)	0.760 (0.400-1.010)	3.34	99
35	3.50	-	-	-	-	3.50 (1.50-4.30)	1.030 (0.400-1.290)	4.52	99
42	4.20	-	-	-	-	4.20 (1.60-5.00)	1.230 (0.410-1.460)	5.40	99
50	5.00	-	-	-	-	5.00 (1.60-5.60)	1.440 (0.420-1.630)	6.32	99
60	6.00	-	-	-	-	6.00 (1.60-6.60)	1.880 (0.400-2.130)	8.26	99
71	7.10	-	-	-	-	7.10 (1.70-7.40)	2.340 (0.410-2.710)	10.28	99
15+15	1.50	1.50	-	-	-	3.00 (2.00-4.00)	0.670 (0.600-1.600)	2.94	99
15+18	1.50	1.80	-	-	-	3.30 (2.00-4.80)	0.838 (0.600-1.860)	3.68	99
15+20	1.50	2.00	-	-	-	3.50 (2.00-5.00)	1.003 (0.600-2.440)	4.40	99
15+22	1.50	2.20	-	-	-	3.70 (2.00-5.40)	0.991 (0.600-1.860)	4.35	99
15+25	1.50	2.50	-	-	-	4.00 (2.00-5.40)	1.067 (0.600-1.860)	4.69	99
15+35	1.50	3.50	-	-	-	5.00 (2.00-6.00)	1.400 (0.580-2.210)	6.15	99
15+42	1.50	4.20	-	-	-	5.70 (2.00-6.60)	1.665 (0.580-2.615)	7.31	99
15+50	1.50	5.00	-	-	-	6.50 (2.00-7.20)	2.040 (0.580-2.870)	8.96	99
15+60	1.46	5.84	-	-	-	7.30 (2.00-7.90)	2.476 (0.580-3.150)	10.87	99
15+71	1.38	6.52	-	-	-	7.90 (2.00-8.60)	2.861 (0.590-3.525)	12.56	99
18+18	1.80	1.80	-	-	-	3.60 (2.00-5.60)	0.925 (0.600-1.600)	4.06	99
18+20	1.80	2.00	-	-	-	3.80 (2.00-5.40)	1.056 (0.600-2.180)	4.64	99
18+22	1.80	2.20	-	-	-	4.00 (2.00-5.60)	1.027 (0.600-1.600)	4.51	99
18+25	1.80	2.50	-	-	-	4.30 (2.00-5.60)	1.104 (0.600-1.600)	4.85	99
18+35	1.80	3.50	-	-	-	5.30 (2.00-6.50)	1.495 (0.580-2.125)	6.57	99
18+42	1.80	4.20	-	-	-	6.00 (2.00-7.10)	1.760 (0.580-2.530)	7.73	99
18+50	1.80	5.00	-	-	-	6.80 (2.00-7.60)	2.144 (0.580-2.665)	9.42	99
18+60	1.73	5.77	-	-	-	7.50 (2.00-8.30)	2.554 (0.590-3.010)	11.22	99
18+71	1.62	6.38	-	-	-	8.00 (2.00-8.90)	2.868 (0.590-3.305)	12.60	99
20+20	2.00	2.00	-	-	-	4.00 (2.00-5.20)	1.027 (0.600-1.600)	4.51	99
20+22	2.00	2.20	-	-	-	4.20 (2.00-5.40)	1.159 (0.600-2.180)	5.09	99
20+25	2.00	2.50	-	-	-	4.50 (2.00-5.50)	1.248 (0.600-2.240)	5.48	99
20+35	2.00	3.50	-	-	-	5.50 (2.00-6.50)	1.665 (0.580-2.825)	7.31	99
20+42	2.00	4.20	-	-	-	6.20 (2.00-7.00)	1.936 (0.580-3.145)	8.50	99
20+50	2.00	5.00	-	-	-	7.00 (2.00-7.50)	2.320 (0.580-3.280)	10.19	99
20+60	1.90	5.70	-	-	-	7.60 (2.00-8.30)	2.713 (0.590-3.670)	11.91	99
20+71	1.76	6.24	-	-	-	8.00 (2.00-8.70)	2.979 (0.590-3.910)	13.08	99
22+22	2.20	2.20	-	-	-	4.40 (2.00-5.60)	1.130 (0.600-1.600)	4.96	99
22+25	2.20	2.50	-	-	-	4.70 (2.00-5.90)	1.245 (0.590-1.775)	5.47	99
22+35	2.20	3.50	-	-	-	5.70 (2.00-6.80)	1.675 (0.580-2.365)	7.36	99
22+42	2.20	4.20	-	-	-	6.40 (2.00-7.30)	1.952 (0.580-2.600)	8.57	99

MXZ-5D102VA COOLING

Indoor units combination	Cooling capacity (kW)						Outdoor unit power consumption(kW)	Current (A)	Power factor(%)
	Unit A	Unit B	Unit C	Unit D	Unit E	Total			
22+50	2.17	4.93	-	-	-	7.10 (2.00-7.90)	2.319 (0.580-2.780)	10.18	99
22+60	2.07	5.63	-	-	-	7.70 (2.00-8.60)	2.711 (0.590-3.170)	11.91	99
22+71	1.92	6.18	-	-	-	8.10 (2.10-9.00)	2.931 (0.590-3.355)	12.87	99
25+25	2.50	2.50	-	-	-	5.00 (2.00-6.20)	1.360 (0.580-1.950)	5.97	99
25+35	2.50	3.50	-	-	-	6.00 (2.00-7.10)	1.810 (0.580-2.540)	7.95	99
25+42	2.50	4.20	-	-	-	6.70 (2.00-7.50)	2.096 (0.580-2.655)	9.21	99
25+50	2.43	4.87	-	-	-	7.30 (2.00-8.10)	2.436 (0.580-2.900)	10.70	99
25+60	2.29	5.51	-	-	-	7.80 (2.00-8.80)	2.806 (0.590-3.265)	12.32	99
25+71	2.14	6.06	-	-	-	8.20 (2.10-9.00)	2.978 (0.590-3.390)	13.08	99
35+35	3.50	3.50	-	-	-	7.00 (2.00-7.70)	2.290 (0.580-2.720)	10.06	99
35+42	3.36	4.04	-	-	-	7.40 (2.00-8.30)	2.515 (0.590-2.990)	11.05	99
35+50	3.21	4.59	-	-	-	7.80 (2.00-8.80)	2.806 (0.590-3.275)	12.32	99
35+60	2.98	5.12	-	-	-	8.10 (2.10-9.00)	2.962 (0.590-3.390)	13.01	99
35+71	2.81	5.69	-	-	-	8.50 (2.10-9.20)	3.061 (0.580-3.475)	13.44	99
42+42	3.90	3.90	-	-	-	7.80 (2.00-8.80)	2.840 (0.590-3.280)	12.47	99
42+50	3.70	4.40	-	-	-	8.10 (2.10-9.00)	2.865 (0.590-3.350)	12.58	99
42+71	3.23	5.47	-	-	-	8.70 (2.10-9.20)	3.036 (0.560-3.510)	13.33	99
50+50	4.15	4.15	-	-	-	8.30 (2.10-9.10)	3.090 (0.590-3.480)	13.57	99
50+60	3.91	4.69	-	-	-	8.60 (2.10-9.20)	3.025 (0.570-3.490)	13.29	99
50+71	3.68	5.22	-	-	-	8.90 (2.10-9.30)	3.056 (0.550-3.545)	13.42	99
60+60	4.45	4.45	-	-	-	8.90 (2.10-9.30)	3.160 (0.550-3.600)	13.88	99
60+71	4.12	4.88	-	-	-	9.00 (2.10-9.40)	3.015 (0.550-3.580)	13.24	99
71+71	4.55	4.55	-	-	-	9.10 (2.10-9.50)	3.070 (0.550-3.700)	13.48	99
15+15+15	1.50	1.50	1.50	-	-	4.50 (2.90-5.70)	1.186 (0.690-2.410)	5.21	99
15+15+18	1.50	1.50	1.80	-	-	4.80 (2.90-6.50)	1.345 (0.750-2.810)	5.91	99
15+15+20	1.50	1.50	2.00	-	-	5.00 (2.90-6.70)	1.438 (0.780-3.240)	6.32	99
15+15+22	1.50	1.50	2.20	-	-	5.20 (2.90-7.30)	1.450 (0.750-2.810)	6.37	99
15+15+25	1.50	1.50	2.50	-	-	5.50 (2.90-7.70)	1.529 (0.750-2.810)	6.71	99
15+15+35	1.50	1.50	3.50	-	-	6.50 (2.90-7.70)	1.794 (0.750-2.810)	7.88	99
15+15+42	1.50	1.50	4.20	-	-	7.20 (2.90-8.30)	2.067 (0.750-3.200)	9.08	99
15+15+50	1.44	1.44	4.81	-	-	7.70 (2.90-8.70)	2.252 (0.760-3.395)	9.89	99
15+15+60	1.35	1.35	5.40	-	-	8.10 (2.90-8.80)	2.345 (0.770-3.390)	10.30	99
15+15+71	1.26	1.26	5.98	-	-	8.50 (2.90-8.90)	2.461 (0.780-3.385)	10.81	99
15+18+18	1.50	1.80	1.80	-	-	5.10 (2.90-7.30)	1.384 (0.720-2.610)	6.08	99
15+18+20	1.50	1.80	2.00	-	-	5.30 (2.90-7.50)	1.477 (0.750-3.040)	6.49	99
15+18+22	1.50	1.80	2.20	-	-	5.50 (2.90-7.90)	1.489 (0.720-2.610)	6.54	99
15+18+25	1.50	1.80	2.50	-	-	5.80 (2.90-7.90)	1.568 (0.720-2.610)	6.89	99
15+18+35	1.50	1.80	3.50	-	-	6.80 (2.90-8.10)	1.869 (0.720-2.745)	8.21	99
15+18+42	1.50	1.80	4.20	-	-	7.50 (2.90-8.80)	2.160 (0.720-3.200)	9.49	99
15+18+50	1.41	1.69	4.70	-	-	7.80 (2.90-8.90)	2.249 (0.730-3.195)	9.88	99
15+18+60	1.32	1.59	5.29	-	-	8.20 (2.90-9.00)	2.342 (0.740-3.190)	10.29	99

MXZ-5D102VA COOLING

Indoor units combination	Cooling capacity (kW)						Outdoor unit power consumption(kW)	Current (A)	Power factor(%)
	Unit A	Unit B	Unit C	Unit D	Unit E	Total			
15+18+71	1.24	1.49	5.87	-	-	8.60 (2.90-9.20)	2.458 (0.750-3.190)	10.79	99
15+20+20	1.50	2.00	2.00	-	-	5.50 (2.90-7.50)	1.569 (0.780-3.470)	6.89	99
15+20+22	1.50	2.00	2.20	-	-	5.70 (2.90-7.70)	1.582 (0.750-3.040)	6.95	99
15+20+25	1.50	2.00	2.50	-	-	6.00 (2.90-7.70)	1.661 (0.750-3.040)	7.29	99
15+20+35	1.50	2.00	3.50	-	-	7.00 (2.90-8.10)	1.998 (0.750-3.305)	8.77	99
15+20+42	1.48	1.97	4.15	-	-	7.60 (2.90-8.60)	2.225 (0.750-3.630)	9.77	99
15+20+50	1.39	1.86	4.65	-	-	7.90 (2.90-8.70)	2.313 (0.760-3.625)	10.16	99
15+20+60	1.29	1.73	5.18	-	-	8.20 (2.90-8.90)	2.407 (0.770-3.625)	10.57	99
15+20+71	1.22	1.62	5.76	-	-	8.60 (2.90-9.00)	2.520 (0.780-3.625)	11.07	99
15+22+22	1.50	2.20	2.20	-	-	5.90 (2.90-7.90)	1.595 (0.720-2.610)	7.00	99
15+22+25	1.50	2.20	2.50	-	-	6.20 (2.90-7.90)	1.674 (0.720-2.610)	7.35	99
15+22+35	1.50	2.20	3.50	-	-	7.20 (2.90-8.50)	2.047 (0.720-3.010)	8.99	99
15+22+42	1.44	2.12	4.04	-	-	7.60 (2.90-8.90)	2.209 (0.720-3.205)	9.70	99
15+22+50	1.36	2.00	4.54	-	-	7.90 (2.90-9.00)	2.298 (0.730-3.200)	10.09	99
15+22+60	1.28	1.88	5.13	-	-	8.30 (2.90-9.10)	2.391 (0.740-3.195)	10.50	99
15+22+71	1.21	1.77	5.72	-	-	8.70 (2.90-9.30)	2.501 (0.750-3.205)	10.98	99
15+25+25	1.50	2.50	2.50	-	-	6.50 (2.90-7.90)	1.754 (0.720-2.610)	7.70	99
15+25+35	1.50	2.50	3.50	-	-	7.50 (2.90-8.80)	2.180 (0.720-3.210)	9.57	99
15+25+42	1.43	2.38	4.00	-	-	7.80 (2.90-8.90)	2.246 (0.730-3.205)	9.86	99
15+25+50	1.35	2.25	4.50	-	-	8.10 (2.90-9.00)	2.335 (0.740-3.200)	10.25	99
15+25+60	1.26	2.10	5.04	-	-	8.40 (2.90-9.10)	2.428 (0.750-3.195)	10.66	99
15+25+71	1.18	1.96	5.56	-	-	8.70 (2.90-9.30)	2.533 (0.740-3.220)	11.12	99
15+35+35	1.39	3.25	3.25	-	-	7.90 (2.90-8.90)	2.303 (0.730-3.215)	10.11	99
15+35+42	1.32	3.08	3.70	-	-	8.10 (2.90-9.00)	2.370 (0.740-3.210)	10.41	99
15+35+50	1.26	2.94	4.20	-	-	8.40 (2.90-9.10)	2.458 (0.750-3.205)	10.79	99
15+35+60	1.19	2.77	4.75	-	-	8.70 (2.90-9.30)	2.542 (0.740-3.225)	11.16	99
15+35+71	1.10	2.57	5.22	-	-	8.90 (2.90-9.60)	2.638 (0.730-3.265)	11.59	99
15+42+42	1.27	3.56	3.56	-	-	8.40 (2.90-9.10)	2.436 (0.740-3.205)	10.70	99
15+42+50	1.21	3.38	4.02	-	-	8.60 (2.90-9.20)	2.521 (0.750-3.210)	11.07	99
15+42+60	1.13	3.16	4.51	-	-	8.80 (2.90-9.50)	2.596 (0.730-3.245)	11.40	99
15+42+71	1.05	2.95	4.99	-	-	9.00 (2.90-9.80)	2.675 (0.720-3.305)	11.75	99
15+50+50	1.15	3.83	3.83	-	-	8.80 (2.90-9.40)	2.595 (0.740-3.240)	11.40	99
15+50+60	1.08	3.60	4.32	-	-	9.00 (2.90-9.70)	2.670 (0.720-3.275)	11.73	99
15+50+71	1.01	3.38	4.80	-	-	9.20 (2.90-10.10)	2.685 (0.710-3.395)	11.79	99
15+60+60	1.02	4.09	4.09	-	-	9.20 (2.90-10.00)	2.673 (0.710-3.385)	11.74	99
15+60+71	0.96	3.82	4.52	-	-	9.30 (2.90-10.50)	2.680 (0.700-3.510)	11.77	99
15+71+71	0.90	4.25	4.25	-	-	9.40 (2.90-10.60)	2.670 (0.690-3.550)	11.73	99
18+18+18	1.80	1.80	1.80	-	-	5.40 (2.90-8.10)	1.423 (0.690-2.410)	6.25	99
18+18+20	1.80	1.80	2.00	-	-	5.60 (2.90-7.90)	1.516 (0.720-2.840)	6.66	99
18+18+22	1.80	1.80	2.20	-	-	5.80 (2.90-8.10)	1.528 (0.690-2.410)	6.71	99
18+18+25	1.80	1.80	2.50	-	-	6.10 (2.90-8.10)	1.608 (0.690-2.410)	7.06	99

MXZ-5D102VA COOLING

Indoor units combination	Cooling capacity (kW)						Outdoor unit power consumption(kW)	Current (A)	Power factor(%)
	Unit A	Unit B	Unit C	Unit D	Unit E	Total			
18+18+35	1.80	1.80	3.50	-	-	7.10 (2.90-8.60)	1.962 (0.690-2.745)	8.62	99
18+18+42	1.75	1.75	4.09	-	-	7.60 (2.90-9.00)	2.157 (0.690-3.000)	9.47	99
18+18+50	1.65	1.65	4.59	-	-	7.90 (2.90-9.10)	2.246 (0.700-2.995)	9.86	99
18+18+60	1.56	1.56	5.19	-	-	8.30 (2.90-9.30)	2.339 (0.710-2.995)	10.27	99
18+18+71	1.45	1.45	5.71	-	-	8.60 (2.90-9.40)	2.451 (0.720-3.000)	10.76	99
18+20+20	1.80	2.00	2.00	-	-	5.80 (2.90-7.70)	1.608 (0.750-3.270)	7.06	99
18+20+22	1.80	2.00	2.20	-	-	6.00 (2.90-7.90)	1.621 (0.720-2.840)	7.12	99
18+20+25	1.80	2.00	2.50	-	-	6.30 (2.90-7.90)	1.701 (0.720-2.840)	7.47	99
18+20+35	1.80	2.00	3.50	-	-	7.30 (2.90-8.60)	2.091 (0.720-3.305)	9.18	99
18+20+42	1.73	1.93	4.04	-	-	7.70 (2.90-8.90)	2.222 (0.730-3.435)	9.76	99
18+20+50	1.64	1.82	4.55	-	-	8.00 (2.90-9.00)	2.310 (0.730-3.430)	10.14	99
18+20+60	1.52	1.69	5.08	-	-	8.30 (2.90-9.10)	2.404 (0.740-3.425)	10.56	99
18+20+71	1.44	1.60	5.67	-	-	8.70 (2.90-9.30)	2.512 (0.740-3.440)	11.03	99
18+22+22	1.80	2.20	2.20	-	-	6.20 (2.90-8.10)	1.634 (0.690-2.410)	7.18	99
18+22+25	1.80	2.20	2.50	-	-	6.50 (2.90-8.10)	1.714 (0.690-2.410)	7.53	99
18+22+35	1.80	2.20	3.50	-	-	7.50 (2.90-9.00)	2.140 (0.690-3.010)	9.40	99
18+22+42	1.71	2.09	4.00	-	-	7.80 (2.90-9.10)	2.206 (0.700-3.005)	9.69	99
18+22+50	1.62	1.98	4.50	-	-	8.10 (2.90-9.20)	2.295 (0.710-3.000)	10.08	99
18+22+60	1.51	1.85	5.04	-	-	8.40 (2.90-9.30)	2.388 (0.720-2.995)	10.49	99
18+22+71	1.41	1.72	5.56	-	-	8.70 (2.90-9.50)	2.493 (0.710-3.020)	10.95	99
18+25+25	1.80	2.50	2.50	-	-	6.80 (2.90-8.30)	1.829 (0.690-2.545)	8.03	99
18+25+35	1.75	2.44	3.41	-	-	7.60 (2.90-9.00)	2.177 (0.690-3.010)	9.56	99
18+25+42	1.67	2.32	3.90	-	-	7.90 (2.90-9.10)	2.243 (0.700-3.005)	9.85	99
18+25+50	1.59	2.20	4.41	-	-	8.20 (2.90-9.20)	2.332 (0.710-3.000)	10.24	99
18+25+60	1.49	2.06	4.95	-	-	8.50 (2.90-9.40)	2.425 (0.720-3.000)	10.65	99
18+25+71	1.39	1.93	5.48	-	-	8.80 (2.90-9.60)	2.524 (0.710-3.035)	11.08	99
18+35+35	1.64	3.18	3.18	-	-	8.00 (2.90-9.20)	2.300 (0.700-3.020)	10.10	99
18+35+42	1.55	3.02	3.63	-	-	8.20 (2.90-9.30)	2.367 (0.710-3.015)	10.40	99
18+35+50	1.49	2.89	4.13	-	-	8.50 (2.90-9.40)	2.455 (0.720-3.010)	10.78	99
18+35+60	1.40	2.73	4.67	-	-	8.80 (2.90-9.60)	2.534 (0.710-3.040)	11.13	99
18+35+71	1.31	2.54	5.15	-	-	9.00 (2.90-9.90)	2.629 (0.690-3.080)	11.55	99
18+42+50	1.42	3.32	3.95	-	-	8.70 (2.90-9.50)	2.512 (0.710-3.025)	11.03	99
18+42+60	1.34	3.12	4.45	-	-	8.90 (2.90-9.80)	2.587 (0.700-3.060)	11.36	99
18+42+71	1.25	2.92	4.93	-	-	9.10 (2.90-10.10)	2.643 (0.680-3.145)	11.61	99
18+50+50	1.34	3.73	3.73	-	-	8.80 (2.90-9.70)	2.586 (0.700-3.050)	11.36	99
18+50+60	1.27	3.52	4.22	-	-	9.00 (2.90-10.00)	2.645 (0.690-3.105)	11.62	99
18+50+71	1.19	3.31	4.70	-	-	9.20 (2.90-10.40)	2.653 (0.670-3.235)	11.65	99
18+60+60	1.20	4.00	4.00	-	-	9.20 (2.90-10.40)	2.640 (0.680-3.220)	11.59	99
18+60+71	1.14	3.79	4.48	-	-	9.40 (2.90-10.80)	2.648 (0.660-3.350)	11.63	99
18+71+71	1.06	4.17	4.17	-	-	9.40 (2.90-10.80)	2.630 (0.660-3.350)	11.55	99
20+20+20	2.00	2.00	2.00	-	-	6.00 (2.90-7.50)	1.581 (0.690-2.410)	6.94	99

MXZ-5D102VA COOLING

Indoor units combination	Cooling capacity (kW)						Outdoor unit power consumption(kW)	Current (A)	Power factor(%)
	Unit A	Unit B	Unit C	Unit D	Unit E	Total			
20+20+22	2.00	2.00	2.20	-	-	6.20 (2.90-7.70)	1.714 (0.750-3.270)	7.53	99
20+20+25	2.00	2.00	2.50	-	-	6.50 (2.90-7.70)	1.794 (0.750-3.270)	7.88	99
20+20+35	2.00	2.00	3.50	-	-	7.50 (2.90-8.60)	2.220 (0.750-3.870)	9.75	99
20+20+42	1.90	1.90	4.00	-	-	7.80 (2.90-8.70)	2.286 (0.760-3.865)	10.04	99
20+20+50	1.80	1.80	4.50	-	-	8.10 (2.90-8.80)	2.375 (0.770-3.860)	10.43	99
20+20+60	1.68	1.68	5.04	-	-	8.40 (2.90-8.90)	2.468 (0.780-3.855)	10.84	99
20+20+71	1.57	1.57	5.56	-	-	8.70 (2.90-9.10)	2.573 (0.770-3.880)	11.30	99
20+22+22	2.00	2.20	2.20	-	-	6.40 (2.90-7.90)	1.727 (0.720-2.840)	7.58	99
20+22+25	2.00	2.20	2.50	-	-	6.70 (2.90-8.00)	1.824 (0.720-2.905)	8.01	99
20+22+35	1.97	2.17	3.45	-	-	7.60 (2.90-8.80)	2.205 (0.720-3.440)	9.68	99
20+22+42	1.86	2.04	3.90	-	-	7.80 (2.90-8.90)	2.271 (0.730-3.435)	9.97	99
20+22+50	1.76	1.94	4.40	-	-	8.10 (2.90-9.00)	2.360 (0.740-3.430)	10.36	99
20+22+71	1.56	1.71	5.53	-	-	8.80 (2.90-9.40)	2.554 (0.740-3.460)	11.22	99
20+25+25	2.00	2.50	2.50	-	-	7.00 (2.90-8.30)	1.958 (0.720-3.105)	8.60	99
20+25+35	1.93	2.41	3.37	-	-	7.70 (2.90-8.90)	2.242 (0.730-3.445)	9.85	99
20+25+42	1.82	2.27	3.81	-	-	7.90 (2.90-9.00)	2.308 (0.730-3.440)	10.14	99
20+25+50	1.73	2.16	4.32	-	-	8.20 (2.90-9.10)	2.397 (0.740-3.435)	10.53	99
20+25+60	1.64	2.05	4.91	-	-	8.60 (2.90-9.20)	2.490 (0.750-3.430)	10.94	99
20+25+71	1.52	1.90	5.39	-	-	8.80 (2.90-9.50)	2.585 (0.730-3.470)	11.35	99
20+35+35	1.80	3.15	3.15	-	-	8.10 (2.90-9.00)	2.365 (0.740-3.450)	10.39	99
20+35+42	1.71	2.99	3.59	-	-	8.30 (2.90-9.10)	2.431 (0.740-3.445)	10.68	99
20+35+50	1.64	2.87	4.10	-	-	8.60 (2.90-9.20)	2.520 (0.750-3.440)	11.07	99
20+35+60	1.53	2.68	4.59	-	-	8.80 (2.90-9.40)	2.595 (0.740-3.480)	11.40	99
20+35+71	1.43	2.50	5.07	-	-	9.00 (2.90-9.70)	2.690 (0.720-3.520)	11.81	99
20+42+42	1.65	3.47	3.47	-	-	8.60 (2.90-9.20)	2.498 (0.750-3.440)	10.97	99
20+42+50	1.55	3.26	3.88	-	-	8.70 (2.90-9.40)	2.573 (0.740-3.465)	11.30	99
20+42+60	1.46	3.06	4.38	-	-	8.90 (2.90-9.60)	2.648 (0.730-3.500)	11.63	99
20+42+71	1.37	2.87	4.86	-	-	9.10 (2.90-10.00)	2.688 (0.710-3.600)	11.81	99
20+50+50	1.48	3.71	3.71	-	-	8.90 (2.90-9.60)	2.647 (0.730-3.490)	11.62	99
20+50+60	1.40	3.50	4.20	-	-	9.10 (2.90-9.90)	2.690 (0.720-3.560)	11.81	99
20+50+71	1.32	3.30	4.68	-	-	9.30 (2.90-10.30)	2.698 (0.700-3.690)	11.85	99
20+60+60	1.31	3.94	3.94	-	-	9.20 (2.90-10.20)	2.685 (0.700-3.675)	11.79	99
20+60+71	1.25	3.74	4.42	-	-	9.40 (2.90-10.60)	2.690 (0.690-3.790)	11.81	99
20+71+71	1.16	4.12	4.12	-	-	9.40 (2.90-10.60)	2.670 (0.690-3.780)	11.73	99
22+22+22	2.20	2.20	2.20	-	-	6.60 (2.90-8.10)	1.740 (0.690-2.410)	7.64	99
22+22+25	2.20	2.20	2.50	-	-	6.90 (2.90-8.40)	1.873 (0.690-2.610)	8.23	99
22+22+35	2.12	2.12	3.37	-	-	7.60 (2.90-9.10)	2.189 (0.690-3.015)	9.61	99
22+22+42	2.02	2.02	3.86	-	-	7.90 (2.90-9.10)	2.256 (0.700-3.005)	9.91	99
22+22+50	1.92	1.92	4.36	-	-	8.20 (2.90-9.30)	2.344 (0.710-3.005)	10.29	99
22+22+60	1.82	1.82	4.96	-	-	8.60 (2.90-9.40)	2.438 (0.720-3.000)	10.71	99
22+22+71	1.68	1.68	5.43	-	-	8.80 (2.90-9.60)	2.535 (0.710-3.040)	11.13	99

MXZ-5D102VA COOLING

Indoor units combination	Cooling capacity (kW)						Outdoor unit power consumption(kW)	Current (A)	Power factor(%)
	Unit A	Unit B	Unit C	Unit D	Unit E	Total			
22+25+25	2.20	2.50	2.50	-	-	7.20 (2.90-8.70)	2.007 (0.690-2.810)	8.81	99
22+25+35	2.09	2.38	3.33	-	-	7.80 (2.90-9.10)	2.226 (0.700-3.015)	9.78	99
22+25+42	1.98	2.25	3.78	-	-	8.00 (2.90-9.20)	2.293 (0.700-3.010)	10.07	99
22+25+50	1.88	2.14	4.28	-	-	8.30 (2.90-9.30)	2.381 (0.710-3.005)	10.46	99
22+25+60	1.77	2.01	4.82	-	-	8.60 (2.90-9.40)	2.471 (0.720-3.010)	10.85	99
22+25+71	1.64	1.86	5.29	-	-	8.80 (2.90-9.70)	2.566 (0.700-3.050)	11.27	99
22+35+35	1.94	3.08	3.08	-	-	8.10 (2.90-9.20)	2.350 (0.710-3.020)	10.32	99
22+35+42	1.87	2.97	3.56	-	-	8.40 (2.90-9.30)	2.416 (0.710-3.015)	10.61	99
22+35+50	1.77	2.81	4.02	-	-	8.60 (2.90-9.40)	2.501 (0.720-3.020)	10.98	99
22+35+60	1.65	2.63	4.51	-	-	8.80 (2.90-9.70)	2.576 (0.700-3.055)	11.31	99
22+35+71	1.55	2.46	4.99	-	-	9.00 (2.90-10.00)	2.655 (0.690-3.115)	11.66	99
22+42+42	1.78	3.41	3.41	-	-	8.60 (2.90-9.40)	2.480 (0.720-3.015)	10.89	99
22+42+50	1.70	3.24	3.86	-	-	8.80 (2.90-9.60)	2.554 (0.710-3.045)	11.22	99
22+42+60	1.60	3.05	4.35	-	-	9.00 (2.90-9.90)	2.629 (0.690-3.080)	11.55	99
22+42+71	1.50	2.86	4.84	-	-	9.20 (2.90-10.20)	2.653 (0.680-3.195)	11.65	99
22+50+50	1.60	3.65	3.65	-	-	8.90 (2.90-9.80)	2.628 (0.700-3.070)	11.54	99
22+50+60	1.52	3.45	4.14	-	-	9.10 (2.90-10.10)	2.655 (0.680-3.155)	11.66	99
22+50+71	1.43	3.25	4.62	-	-	9.30 (2.90-10.50)	2.663 (0.670-3.285)	11.70	99
22+60+60	1.44	3.93	3.93	-	-	9.30 (2.90-10.50)	2.650 (0.670-3.270)	11.64	99
22+60+71	1.35	3.69	4.36	-	-	9.40 (2.90-10.80)	2.650 (0.660-3.360)	11.64	99
22+71+71	1.26	4.07	4.07	-	-	9.40 (2.90-10.80)	2.630 (0.660-3.350)	11.55	99
25+25+25	2.50	2.50	2.50	-	-	7.50 (2.90-9.00)	2.140 (0.690-3.010)	9.40	99
25+25+35	2.32	2.32	3.25	-	-	7.90 (2.90-9.10)	2.263 (0.700-3.015)	9.94	99
25+25+42	2.20	2.20	3.70	-	-	8.10 (2.90-9.20)	2.330 (0.710-3.010)	10.23	99
25+25+50	2.10	2.10	4.20	-	-	8.40 (2.90-9.30)	2.418 (0.720-3.005)	10.62	99
25+25+60	1.98	1.98	4.75	-	-	8.70 (2.90-9.50)	2.502 (0.710-3.025)	10.99	99
25+25+71	1.84	1.84	5.22	-	-	8.90 (2.90-9.80)	2.598 (0.700-3.065)	11.41	99
25+35+35	2.16	3.02	3.02	-	-	8.20 (2.90-9.30)	2.387 (0.710-3.025)	10.48	99
25+35+50	1.98	2.77	3.95	-	-	8.70 (2.90-9.50)	2.532 (0.710-3.035)	11.12	99
25+35+60	1.85	2.60	4.45	-	-	8.90 (2.90-9.80)	2.607 (0.700-3.070)	11.45	99
25+35+71	1.74	2.43	4.93	-	-	9.10 (2.90-10.10)	2.663 (0.680-3.155)	11.70	99
25+42+42	2.00	3.35	3.35	-	-	8.70 (2.90-9.50)	2.512 (0.710-3.030)	11.03	99
25+42+50	1.88	3.16	3.76	-	-	8.80 (2.90-9.70)	2.586 (0.700-3.055)	11.36	99
25+42+60	1.77	2.98	4.25	-	-	9.00 (2.90-9.90)	2.653 (0.690-3.105)	11.65	99
25+42+71	1.67	2.80	4.73	-	-	9.20 (2.90-10.40)	2.660 (0.680-3.230)	11.68	99
25+50+50	1.80	3.60	3.60	-	-	9.00 (2.90-9.90)	2.660 (0.690-3.085)	11.68	99
25+50+60	1.70	3.41	4.09	-	-	9.20 (2.90-10.20)	2.663 (0.680-3.195)	11.70	99
25+50+71	1.59	3.18	4.52	-	-	9.30 (2.90-10.70)	2.670 (0.670-3.320)	11.73	99
25+60+60	1.60	3.85	3.85	-	-	9.30 (2.90-10.60)	2.658 (0.670-3.310)	11.67	99
25+60+71	1.51	3.62	4.28	-	-	9.40 (2.90-10.80)	2.650 (0.660-3.360)	11.64	99
25+71+71	1.41	4.00	4.00	-	-	9.40 (2.90-10.80)	2.630 (0.660-3.350)	11.55	99

MXZ-5D102VA COOLING

Indoor units combination	Cooling capacity (kW)						Outdoor unit power consumption(kW)	Current (A)	Power factor(%)
	Unit A	Unit B	Unit C	Unit D	Unit E	Total			
35+35+35	2.87	2.87	2.87	-	-	8.60 (2.90-9.40)	2.510 (0.720-3.030)	11.02	99
35+35+42	2.72	2.72	3.26	-	-	8.70 (2.90-9.60)	2.563 (0.710-3.055)	11.26	99
35+35+50	2.60	2.60	3.71	-	-	8.90 (2.90-9.80)	2.637 (0.700-3.080)	11.58	99
35+35+60	2.45	2.45	4.20	-	-	9.10 (2.90-10.10)	2.680 (0.690-3.150)	11.77	99
35+35+71	2.31	2.31	4.68	-	-	9.30 (2.90-10.50)	2.688 (0.670-3.280)	11.81	99
35+42+42	2.62	3.14	3.14	-	-	8.90 (2.90-9.70)	2.617 (0.700-3.075)	11.49	99
35+42+50	2.48	2.98	3.54	-	-	9.00 (2.90-9.90)	2.683 (0.690-3.115)	11.78	99
35+42+60	2.35	2.82	4.03	-	-	9.20 (2.90-10.30)	2.678 (0.680-3.230)	11.76	99
35+42+71	2.22	2.67	4.51	-	-	9.40 (2.90-10.70)	2.685 (0.660-3.355)	11.79	99
35+50+50	2.39	3.41	3.41	-	-	9.20 (2.90-10.20)	2.693 (0.680-3.205)	11.83	99
35+50+60	2.24	3.21	3.85	-	-	9.30 (2.90-10.60)	2.688 (0.670-3.320)	11.81	99
35+50+71	2.11	3.01	4.28	-	-	9.40 (2.90-10.80)	2.680 (0.660-3.370)	11.77	99
35+60+60	2.12	3.64	3.64	-	-	9.40 (2.90-10.80)	2.670 (0.660-3.370)	11.73	99
35+60+71	1.98	3.40	4.02	-	-	9.40 (2.90-10.80)	2.650 (0.660-3.360)	11.64	99
42+42+42	3.00	3.00	3.00	-	-	9.00 (2.90-9.90)	2.730 (0.690-3.130)	11.99	99
42+42+50	2.85	2.85	3.40	-	-	9.10 (2.90-10.20)	2.680 (0.680-3.190)	11.77	99
42+42+60	2.71	2.71	3.88	-	-	9.30 (2.90-10.60)	2.675 (0.670-3.305)	11.75	99
42+42+71	2.55	2.55	4.31	-	-	9.40 (2.90-10.80)	2.670 (0.660-3.370)	11.73	99
42+50+50	2.75	3.27	3.27	-	-	9.30 (2.90-10.50)	2.690 (0.670-3.280)	11.81	99
42+50+60	2.60	3.09	3.71	-	-	9.40 (2.90-10.80)	2.680 (0.660-3.370)	11.77	99
42+50+71	2.42	2.88	4.09	-	-	9.40 (2.90-10.80)	2.660 (0.660-3.360)	11.68	99
42+60+60	2.44	3.48	3.48	-	-	9.40 (2.90-10.80)	2.650 (0.660-3.360)	11.64	99
50+50+50	3.13	3.13	3.13	-	-	9.40 (2.90-10.80)	2.790 (0.660-3.430)	12.25	99
50+50+60	2.94	2.94	3.53	-	-	9.40 (2.90-10.80)	2.670 (0.660-3.360)	11.73	99
50+50+71	2.75	2.75	3.90	-	-	9.40 (2.90-10.80)	2.650 (0.660-3.350)	11.64	99
50+60+60	2.76	3.32	3.32	-	-	9.40 (2.90-10.80)	2.640 (0.660-3.350)	11.59	99
15+15+15+15	1.50	1.50	1.50	1.50	-	6.00 (3.70-6.40)	2.005 (0.810-3.195)	8.81	99
15+15+15+18	1.50	1.50	1.50	1.80	-	6.30 (3.70-7.10)	1.655 (0.900-3.195)	7.27	99
15+15+15+20	1.48	1.48	1.48	1.97	-	6.40 (3.70-7.20)	1.582 (0.930-3.265)	6.95	99
15+15+15+22	1.50	1.50	1.50	2.20	-	6.70 (3.70-7.80)	1.789 (0.900-3.195)	7.86	99
15+15+15+25	1.50	1.50	1.50	2.50	-	7.00 (3.70-8.30)	1.889 (0.900-3.195)	8.30	99
15+15+15+35	1.50	1.50	1.50	3.50	-	8.00 (3.70-8.60)	2.224 (0.900-3.195)	9.77	99
15+15+15+42	1.50	1.50	1.50	4.20	-	8.70 (3.70-8.60)	2.445 (0.900-3.185)	10.74	99
15+15+15+50	1.37	1.37	1.37	4.58	-	8.70 (3.70-9.00)	2.470 (0.900-3.320)	10.85	99
15+15+15+60	1.24	1.24	1.24	4.97	-	8.70 (3.70-9.30)	2.478 (0.900-3.425)	10.88	99
15+15+15+71	1.15	1.15	1.15	5.45	-	8.90 (3.70-9.30)	2.540 (0.900-3.450)	11.16	99
15+15+18+18	1.50	1.50	1.80	1.80	-	6.60 (3.70-7.80)	1.906 (0.870-3.195)	8.37	99
15+15+18+20	1.48	1.48	1.77	1.97	-	6.70 (3.70-7.90)	1.832 (0.900-3.265)	8.05	99
15+15+18+22	1.50	1.50	1.80	2.20	-	7.00 (3.70-8.50)	2.039 (0.870-3.195)	8.95	99
15+15+18+25	1.50	1.50	1.80	2.50	-	7.30 (3.70-8.80)	2.140 (0.870-3.195)	9.40	99
15+15+18+35	1.50	1.50	1.80	3.50	-	8.30 (3.70-8.80)	2.474 (0.870-3.195)	10.87	99

MXZ-5D102VA COOLING

Indoor units combination	Cooling capacity (kW)					Outdoor unit power consumption(kW)	Current (A)	Power factor(%)	
	Unit A	Unit B	Unit C	Unit D	Unit E				Total
15+15+18+42	1.47	1.47	1.76	4.11	-	8.80 (3.70-8.90)	2.630 (0.870-3.225)	11.55	99
15+15+18+50	1.32	1.32	1.58	4.39	-	8.60 (3.70-9.40)	2.620 (0.870-3.380)	11.51	99
15+15+18+60	1.22	1.22	1.47	4.89	-	8.80 (3.70-9.50)	2.650 (0.870-3.435)	11.64	99
15+15+18+71	1.13	1.13	1.36	5.37	-	9.00 (3.70-9.50)	2.713 (0.870-3.455)	11.91	99
15+15+20+20	1.46	1.46	1.94	1.94	-	6.80 (3.70-8.10)	1.759 (0.930-3.335)	7.73	99
15+15+20+22	1.48	1.48	1.97	2.17	-	7.10 (3.70-8.60)	1.966 (0.900-3.265)	8.63	99
15+15+20+25	1.48	1.48	1.97	2.47	-	7.40 (3.70-8.60)	2.067 (0.900-3.265)	9.08	99
15+15+20+35	1.48	1.48	1.98	3.46	-	8.40 (3.70-8.60)	2.404 (0.900-3.265)	10.56	99
15+15+20+42	1.40	1.40	1.87	3.93	-	8.60 (3.70-8.80)	2.490 (0.900-3.335)	10.94	99
15+15+20+50	1.28	1.28	1.70	4.25	-	8.50 (3.70-9.30)	2.480 (0.902-3.490)	10.89	99
15+15+20+60	1.19	1.19	1.58	4.75	-	8.70 (3.70-9.30)	2.525 (0.900-3.510)	11.09	99
15+15+20+71	1.10	1.10	1.47	5.22	-	8.90 (3.70-9.40)	2.588 (0.900-3.535)	11.37	99
15+15+22+22	1.50	1.50	2.20	2.20	-	7.40 (3.70-8.80)	2.173 (0.870-3.195)	9.54	99
15+15+22+25	1.50	1.50	2.20	2.50	-	7.70 (3.70-8.80)	2.274 (0.870-3.195)	9.99	99
15+15+22+35	1.50	1.50	2.20	3.50	-	8.70 (3.70-8.80)	2.615 (0.870-3.195)	11.48	99
15+15+22+42	1.39	1.39	2.04	3.89	-	8.70 (3.70-9.20)	2.630 (0.870-3.310)	11.55	99
15+15+22+60	1.18	1.18	1.73	4.71	-	8.80 (3.70-9.50)	2.680 (0.870-3.445)	11.77	99
15+15+22+71	1.11	1.11	1.63	5.25	-	9.10 (3.70-9.60)	2.743 (0.870-3.470)	12.05	99
15+15+25+25	1.50	1.50	2.50	2.50	-	8.00 (3.70-8.80)	2.374 (0.870-3.195)	10.43	99
15+15+25+35	1.47	1.47	2.44	3.42	-	8.80 (3.70-8.90)	2.650 (0.870-3.235)	11.64	99
15+15+25+42	1.35	1.35	2.24	3.77	-	8.70 (3.70-9.30)	2.630 (0.870-3.370)	11.55	99
15+15+25+50	1.24	1.24	2.07	4.14	-	8.70 (3.70-9.50)	2.658 (0.870-3.435)	11.67	99
15+15+25+60	1.16	1.16	1.93	4.64	-	8.90 (3.70-9.50)	2.703 (0.870-3.455)	11.87	99
15+15+25+71	1.08	1.08	1.81	5.13	-	9.10 (3.70-9.60)	2.765 (0.870-3.480)	12.14	99
15+15+35+35	1.29	1.29	3.01	3.01	-	8.60 (3.70-9.50)	2.650 (0.872-3.440)	11.64	99
15+15+35+42	1.22	1.22	2.85	3.41	-	8.70 (3.70-9.50)	2.683 (0.870-3.450)	11.78	99
15+15+35+50	1.16	1.16	2.71	3.87	-	8.90 (3.70-9.50)	2.733 (0.870-3.465)	12.00	99
15+15+35+60	1.09	1.09	2.55	4.37	-	9.10 (3.70-9.60)	2.778 (0.870-3.485)	12.20	99
15+15+35+71	1.03	1.03	2.39	4.86	-	9.30 (3.70-9.60)	2.840 (0.870-3.510)	12.47	99
15+15+42+42	1.17	1.17	3.28	3.28	-	8.90 (3.70-9.50)	2.715 (0.870-3.460)	11.92	99
15+15+42+50	1.11	1.11	3.10	3.69	-	9.00 (3.70-9.60)	2.765 (0.870-3.475)	12.14	99
15+15+42+60	1.05	1.05	2.93	4.18	-	9.20 (3.70-9.60)	2.810 (0.870-3.495)	12.34	99
15+15+42+71	0.99	0.99	2.76	4.67	-	9.40 (3.70-9.60)	2.850 (0.870-3.510)	12.52	99
15+15+50+50	1.06	1.06	3.54	3.54	-	9.20 (3.70-9.60)	2.815 (0.870-3.490)	12.36	99
15+15+50+60	1.01	1.01	3.36	4.03	-	9.40 (3.70-9.60)	2.860 (0.870-3.510)	12.56	99
15+15+50+71	0.93	0.93	3.11	4.42	-	9.40 (3.70-9.60)	2.840 (0.870-3.500)	12.47	99
15+15+60+60	0.94	0.94	3.76	3.76	-	9.40 (3.70-9.60)	2.830 (0.870-3.500)	12.43	99
15+15+60+71	0.88	0.88	3.50	4.15	-	9.40 (3.70-9.60)	2.810 (0.870-3.490)	12.34	99
15+15+71+71	0.82	0.82	3.88	3.88	-	9.40 (3.70-9.60)	2.790 (0.870-3.480)	12.25	99
15+18+18+18	1.50	1.80	1.80	1.80	-	6.90 (3.70-8.50)	2.156 (0.840-3.195)	9.47	99
15+18+18+20	1.48	1.77	1.77	1.97	-	7.00 (3.70-8.60)	2.083 (0.870-3.265)	9.15	99

MXZ-5D102VA COOLING

Indoor units combination	Cooling capacity (kW)						Outdoor unit power consumption(kW)	Current (A)	Power factor(%)
	Unit A	Unit B	Unit C	Unit D	Unit E	Total			
15+18+18+22	1.50	1.80	1.80	2.20	-	7.30 (3.70-9.00)	2.290 (0.840-3.195)	10.06	99
15+18+18+25	1.50	1.80	1.80	2.50	-	7.60 (3.70-9.00)	2.390 (0.840-3.195)	10.50	99
15+18+18+35	1.50	1.80	1.80	3.50	-	8.60 (3.70-9.00)	2.730 (0.840-3.195)	11.99	99
15+18+18+42	1.40	1.68	1.68	3.93	-	8.70 (3.70-9.30)	2.780 (0.840-3.285)	12.21	99
15+18+18+50	1.28	1.53	1.53	4.26	-	8.60 (3.70-9.70)	2.778 (0.840-3.425)	12.20	99
15+18+18+60	1.19	1.43	1.43	4.76	-	8.80 (3.70-9.70)	2.823 (0.840-3.445)	12.40	99
15+18+18+71	1.11	1.33	1.33	5.24	-	9.00 (3.70-9.80)	2.885 (0.840-3.465)	12.67	99
15+18+20+20	1.46	1.75	1.95	1.95	-	7.10 (3.70-8.60)	2.010 (0.900-3.335)	8.83	99
15+18+20+22	1.48	1.78	1.97	2.17	-	7.40 (3.70-8.80)	2.217 (0.870-3.265)	9.74	99
15+18+20+25	1.48	1.78	1.97	2.47	-	7.70 (3.70-8.80)	2.317 (0.870-3.265)	10.18	99
15+18+20+35	1.48	1.78	1.98	3.46	-	8.70 (3.70-8.80)	2.660 (0.870-3.265)	11.68	99
15+18+20+42	1.36	1.63	1.81	3.80	-	8.60 (3.70-9.20)	2.640 (0.870-3.400)	11.59	99
15+18+20+50	1.25	1.50	1.67	4.17	-	8.60 (3.70-9.50)	2.653 (0.870-3.500)	11.65	99
15+18+20+60	1.17	1.40	1.56	4.67	-	8.80 (3.70-9.50)	2.698 (0.870-3.520)	11.85	99
15+18+20+71	1.09	1.31	1.45	5.15	-	9.00 (3.70-9.60)	2.760 (0.870-3.540)	12.12	99
15+18+22+22	1.50	1.80	2.20	2.20	-	7.70 (3.70-9.00)	2.424 (0.840-3.195)	10.65	99
15+18+22+25	1.50	1.80	2.20	2.50	-	8.00 (3.70-9.00)	2.524 (0.840-3.195)	11.08	99
15+18+22+35	1.47	1.76	2.15	3.42	-	8.80 (3.70-9.10)	2.800 (0.840-3.235)	12.30	99
15+18+22+42	1.35	1.61	1.97	3.77	-	8.70 (3.70-9.50)	2.780 (0.840-3.370)	12.21	99
15+18+22+50	1.24	1.49	1.82	4.14	-	8.70 (3.70-9.70)	2.808 (0.840-3.435)	12.33	99
15+18+22+60	1.16	1.39	1.70	4.64	-	8.90 (3.70-9.70)	2.853 (0.840-3.455)	12.53	99
15+18+22+71	1.08	1.30	1.59	5.13	-	9.10 (3.70-9.80)	2.915 (0.840-3.480)	12.80	99
15+18+25+25	1.50	1.80	2.50	2.50	-	8.30 (3.70-9.00)	2.624 (0.840-3.195)	11.52	99
15+18+25+35	1.40	1.68	2.34	3.27	-	8.70 (3.70-9.30)	2.800 (0.840-3.295)	12.30	99
15+18+25+42	1.29	1.55	2.15	3.61	-	8.60 (3.70-9.70)	2.780 (0.842-3.430)	12.21	99
15+18+25+50	1.22	1.47	2.04	4.07	-	8.80 (3.70-9.70)	2.830 (0.840-3.445)	12.43	99
15+18+25+60	1.14	1.37	1.91	4.58	-	9.00 (3.70-9.70)	2.875 (0.840-3.465)	12.63	99
15+18+25+71	1.07	1.28	1.78	5.06	-	9.20 (3.70-9.80)	2.938 (0.840-3.485)	12.90	99
15+18+35+35	1.27	1.52	2.96	2.96	-	8.70 (3.70-9.70)	2.823 (0.840-3.450)	12.40	99
15+18+35+42	1.20	1.44	2.80	3.36	-	8.80 (3.70-9.70)	2.855 (0.840-3.460)	12.54	99
15+18+35+50	1.14	1.37	2.67	3.81	-	9.00 (3.70-9.70)	2.905 (0.840-3.475)	12.76	99
15+18+35+60	1.08	1.29	2.52	4.31	-	9.20 (3.70-9.80)	2.950 (0.840-3.495)	12.96	99
15+18+35+71	1.01	1.22	2.37	4.80	-	9.40 (3.70-9.80)	3.013 (0.840-3.515)	13.23	99
15+18+42+42	1.14	1.37	3.19	3.19	-	8.90 (3.70-9.70)	2.888 (0.840-3.470)	12.68	99
15+18+42+50	1.09	1.31	3.06	3.64	-	9.10 (3.70-9.80)	2.938 (0.840-3.485)	12.90	99
15+18+42+60	1.03	1.24	2.89	4.13	-	9.30 (3.70-9.80)	2.983 (0.840-3.505)	13.10	99
15+18+42+71	0.97	1.16	2.70	4.57	-	9.40 (3.70-9.80)	3.000 (0.840-3.510)	13.18	99
15+18+50+50	1.05	1.26	3.50	3.50	-	9.30 (3.70-9.80)	2.988 (0.840-3.500)	13.12	99
15+18+50+60	0.99	1.18	3.29	3.94	-	9.40 (3.70-9.80)	3.010 (0.840-3.510)	13.22	99
15+18+50+71	0.92	1.10	3.05	4.33	-	9.40 (3.70-9.80)	2.990 (0.840-3.500)	13.13	99
15+18+60+60	0.92	1.11	3.69	3.69	-	9.40 (3.70-9.80)	2.980 (0.840-3.500)	13.09	99

MXZ-5D102VA COOLING

Indoor units combination	Cooling capacity (kW)						Outdoor unit power consumption(kW)	Current (A)	Power factor(%)
	Unit A	Unit B	Unit C	Unit D	Unit E	Total			
15+18+60+71	0.86	1.03	3.44	4.07	-	9.40 (3.70-9.80)	2.960 (0.840-3.490)	13.00	99
15+20+20+20	1.44	1.92	1.92	1.92	-	7.20 (3.70-8.40)	1.937 (0.930-3.405)	8.51	99
15+20+20+22	1.46	1.95	1.95	2.14	-	7.50 (3.70-8.60)	2.144 (0.900-3.335)	9.42	99
15+20+20+25	1.46	1.95	1.95	2.44	-	7.80 (3.70-8.60)	2.244 (0.900-3.335)	9.86	99
15+20+20+35	1.43	1.91	1.91	3.34	-	8.60 (3.70-8.70)	2.520 (0.900-3.375)	11.07	99
15+20+20+42	1.31	1.75	1.75	3.68	-	8.50 (3.70-9.10)	2.500 (0.900-3.510)	10.98	99
15+20+20+50	1.21	1.62	1.62	4.05	-	8.50 (3.70-9.30)	2.528 (0.900-3.575)	11.10	99
15+20+20+60	1.13	1.51	1.51	4.54	-	8.70 (3.70-9.30)	2.573 (0.900-3.595)	11.30	99
15+20+20+71	1.06	1.41	1.41	5.02	-	8.90 (3.70-9.40)	2.635 (0.900-3.620)	11.57	99
15+20+22+22	1.48	1.97	2.17	2.17	-	7.80 (3.70-8.80)	2.351 (0.870-3.265)	10.32	99
15+20+22+25	1.48	1.98	2.17	2.47	-	8.10 (3.70-8.80)	2.451 (0.870-3.265)	10.76	99
15+20+22+35	1.40	1.87	2.06	3.27	-	8.60 (3.70-9.00)	2.660 (0.870-3.345)	11.68	99
15+20+22+42	1.29	1.72	1.89	3.61	-	8.50 (3.70-9.40)	2.640 (0.870-3.480)	11.59	99
15+20+22+50	1.21	1.61	1.77	4.02	-	8.60 (3.70-9.50)	2.683 (0.870-3.510)	11.78	99
15+20+22+60	1.13	1.50	1.65	4.51	-	8.80 (3.70-9.50)	2.728 (0.870-3.530)	11.98	99
15+20+22+71	1.07	1.42	1.56	5.05	-	9.10 (3.70-9.60)	2.790 (0.870-3.555)	12.25	99
15+20+25+25	1.48	1.98	2.47	2.47	-	8.40 (3.70-8.80)	2.554 (0.870-3.265)	11.22	99
15+20+25+35	1.36	1.81	2.26	3.17	-	8.60 (3.70-9.20)	2.660 (0.870-3.410)	11.68	99
15+20+25+50	1.19	1.58	1.98	3.95	-	8.70 (3.70-9.50)	2.705 (0.870-3.520)	11.88	99
15+20+25+60	1.11	1.48	1.85	4.45	-	8.90 (3.70-9.60)	2.750 (0.870-3.540)	12.08	99
15+20+25+71	1.04	1.39	1.74	4.93	-	9.10 (3.70-9.60)	2.813 (0.870-3.565)	12.35	99
15+20+35+35	1.23	1.64	2.87	2.87	-	8.60 (3.70-9.50)	2.698 (0.870-3.525)	11.85	99
15+20+35+42	1.17	1.55	2.72	3.26	-	8.70 (3.70-9.50)	2.730 (0.870-3.535)	11.99	99
15+20+35+50	1.11	1.48	2.60	3.71	-	8.90 (3.70-9.60)	2.780 (0.870-3.550)	12.21	99
15+20+35+60	1.05	1.40	2.45	4.20	-	9.10 (3.70-9.60)	2.825 (0.870-3.570)	12.41	99
15+20+35+71	0.99	1.32	2.31	4.68	-	9.30 (3.70-9.60)	2.880 (0.870-3.590)	12.65	99
15+20+42+42	1.12	1.50	3.14	3.14	-	8.90 (3.70-9.50)	2.763 (0.870-3.545)	12.13	99
15+20+42+50	1.06	1.42	2.98	3.54	-	9.00 (3.70-9.60)	2.813 (0.870-3.560)	12.35	99
15+20+42+60	1.01	1.34	2.82	4.03	-	9.20 (3.70-9.60)	2.858 (0.870-3.580)	12.55	99
15+20+42+71	0.94	1.26	2.64	4.46	-	9.30 (3.70-9.60)	2.860 (0.870-3.580)	12.56	99
15+20+50+50	1.02	1.36	3.41	3.41	-	9.20 (3.70-9.60)	2.863 (0.870-3.575)	12.57	99
15+20+50+60	0.96	1.28	3.21	3.85	-	9.30 (3.70-9.60)	2.870 (0.870-3.580)	12.60	99
15+20+50+71	0.89	1.19	2.98	4.23	-	9.30 (3.70-9.60)	2.850 (0.870-3.570)	12.52	99
15+20+60+60	0.90	1.20	3.60	3.60	-	9.30 (3.70-9.60)	2.840 (0.870-3.570)	12.47	99
15+20+60+71	0.84	1.12	3.36	3.98	-	9.30 (3.70-9.60)	2.820 (0.870-3.560)	12.38	99
15+22+22+22	1.50	2.20	2.20	2.20	-	8.10 (3.70-9.00)	2.557 (0.840-3.195)	11.23	99
15+22+22+25	1.50	2.20	2.20	2.50	-	8.40 (3.70-9.00)	2.659 (0.840-3.195)	11.68	99
15+22+22+35	1.39	2.04	2.04	3.24	-	8.70 (3.70-9.40)	2.800 (0.840-3.320)	12.30	99
15+22+22+42	1.28	1.87	1.87	3.58	-	8.60 (3.70-9.70)	2.788 (0.840-3.435)	12.24	99
15+22+22+50	1.21	1.78	1.78	4.04	-	8.80 (3.70-9.70)	2.838 (0.840-3.445)	12.46	99
15+22+22+60	1.13	1.66	1.66	4.54	-	9.00 (3.70-9.70)	2.883 (0.840-3.465)	12.66	99

MXZ-5D102VA COOLING

Indoor units combination	Cooling capacity (kW)						Outdoor unit power consumption(kW)	Current (A)	Power factor(%)
	Unit A	Unit B	Unit C	Unit D	Unit E	Total			
15+22+22+71	1.06	1.56	1.56	5.02	-	9.20 (3.70-9.80)	2.945 (0.840-3.490)	12.93	99
15+22+25+25	1.50	2.20	2.50	2.50	-	8.70 (3.70-9.00)	2.765 (0.840-3.195)	12.14	99
15+22+25+35	1.35	1.97	2.24	3.14	-	8.70 (3.70-9.50)	2.800 (0.840-3.380)	12.30	99
15+22+25+42	1.25	1.84	2.09	3.51	-	8.70 (3.70-9.70)	2.810 (0.840-3.440)	12.34	99
15+22+25+50	1.18	1.73	1.96	3.93	-	8.80 (3.70-9.70)	2.860 (0.840-3.455)	12.56	99
15+22+25+60	1.11	1.62	1.84	4.43	-	9.00 (3.70-9.80)	2.905 (0.840-3.475)	12.76	99
15+22+25+71	1.05	1.54	1.75	4.96	-	9.30 (3.70-9.80)	2.968 (0.840-3.500)	13.03	99
15+22+35+35	1.22	1.79	2.85	2.85	-	8.70 (3.70-9.70)	2.853 (0.840-3.460)	12.53	99
15+22+35+42	1.17	1.72	2.73	3.28	-	8.90 (3.70-9.70)	2.885 (0.840-3.470)	12.67	99
15+22+35+50	1.11	1.62	2.58	3.69	-	9.00 (3.70-9.80)	2.935 (0.840-3.485)	12.89	99
15+22+35+60	1.05	1.53	2.44	4.18	-	9.20 (3.70-9.80)	2.980 (0.840-3.505)	13.09	99
15+22+35+71	0.99	1.45	2.30	4.67	-	9.40 (3.70-9.80)	3.020 (0.840-3.520)	13.26	99
15+22+42+42	1.12	1.64	3.12	3.12	-	9.00 (3.70-9.80)	2.918 (0.840-3.485)	12.82	99
15+22+42+50	1.07	1.57	3.00	3.57	-	9.20 (3.70-9.80)	2.968 (0.840-3.495)	13.03	99
15+22+42+60	1.01	1.49	2.84	4.06	-	9.40 (3.70-9.80)	3.013 (0.840-3.515)	13.23	99
15+22+42+71	0.94	1.38	2.63	4.45	-	9.40 (3.70-9.80)	3.000 (0.840-3.510)	13.18	99
15+22+50+50	1.02	1.49	3.39	3.39	-	9.30 (3.70-9.80)	3.018 (0.840-3.510)	13.25	99
15+22+50+60	0.96	1.41	3.20	3.84	-	9.40 (3.70-9.80)	3.010 (0.840-3.510)	13.22	99
15+22+50+71	0.89	1.31	2.97	4.22	-	9.40 (3.70-9.80)	2.990 (0.840-3.500)	13.13	99
15+22+60+60	0.90	1.32	3.59	3.59	-	9.40 (3.70-9.80)	2.980 (0.840-3.500)	13.09	99
15+22+60+71	0.84	1.23	3.36	3.97	-	9.40 (3.70-9.80)	2.960 (0.840-3.490)	13.00	99
15+25+25+25	1.47	2.44	2.44	2.44	-	8.80 (3.70-9.10)	2.800 (0.840-3.235)	12.30	99
15+25+25+35	1.29	2.15	2.15	3.01	-	8.60 (3.70-9.70)	2.800 (0.842-3.440)	12.30	99
15+25+25+42	1.22	2.03	2.03	3.41	-	8.70 (3.70-9.70)	2.833 (0.840-3.450)	12.44	99
15+25+25+50	1.16	1.93	1.93	3.87	-	8.90 (3.70-9.70)	2.883 (0.840-3.465)	12.66	99
15+25+25+60	1.09	1.82	1.82	4.37	-	9.10 (3.70-9.80)	2.928 (0.840-3.485)	12.86	99
15+25+25+71	1.03	1.71	1.71	4.86	-	9.30 (3.70-9.80)	2.990 (0.840-3.510)	13.13	99
15+25+35+35	1.20	2.00	2.80	2.80	-	8.80 (3.70-9.70)	2.875 (0.840-3.470)	12.63	99
15+25+35+42	1.14	1.90	2.66	3.19	-	8.90 (3.70-9.70)	2.908 (0.840-3.480)	12.77	99
15+25+35+50	1.09	1.82	2.55	3.64	-	9.10 (3.70-9.80)	2.958 (0.840-3.495)	12.99	99
15+25+35+60	1.03	1.72	2.41	4.13	-	9.30 (3.70-9.80)	3.003 (0.840-3.515)	13.19	99
15+25+35+71	0.97	1.61	2.25	4.57	-	9.40 (3.70-9.80)	3.020 (0.840-3.520)	13.26	99
15+25+42+42	1.10	1.83	3.08	3.08	-	9.10 (3.70-9.80)	2.940 (0.840-3.490)	12.91	99
15+25+42+50	1.05	1.74	2.93	3.48	-	9.20 (3.70-9.80)	2.990 (0.840-3.505)	13.13	99
15+25+42+60	0.99	1.65	2.78	3.97	-	9.40 (3.70-9.80)	3.020 (0.840-3.520)	13.26	99
15+25+42+71	0.92	1.54	2.58	4.36	-	9.40 (3.70-9.80)	3.000 (0.840-3.510)	13.18	99
15+25+50+50	1.01	1.68	3.36	3.36	-	9.40 (3.70-9.80)	3.040 (0.840-3.520)	13.35	99
15+25+50+60	0.94	1.57	3.13	3.76	-	9.40 (3.70-9.80)	3.010 (0.840-3.510)	13.22	99
15+25+50+71	0.88	1.46	2.92	4.15	-	9.40 (3.70-9.80)	2.990 (0.840-3.500)	13.13	99
15+25+60+60	0.88	1.47	3.53	3.53	-	9.40 (3.70-9.80)	2.980 (0.840-3.500)	13.09	99
15+25+60+71	0.82	1.37	3.30	3.90	-	9.40 (3.70-9.80)	2.960 (0.840-3.490)	13.00	99

MXZ-5D102VA COOLING

Indoor units combination	Cooling capacity (kW)						Outdoor unit power consumption(kW)	Current (A)	Power factor(%)
	Unit A	Unit B	Unit C	Unit D	Unit E	Total			
15+35+35+35	1.13	2.63	2.63	2.63	-	9.00 (3.70-9.80)	2.950 (0.840-3.500)	12.96	99
15+35+35+42	1.07	2.51	2.51	3.01	-	9.10 (3.70-9.80)	2.983 (0.840-3.510)	13.10	99
15+35+35+50	1.03	2.41	2.41	3.44	-	9.30 (3.70-9.80)	3.033 (0.840-3.525)	13.32	99
15+35+35+60	0.97	2.27	2.27	3.89	-	9.40 (3.70-9.80)	3.040 (0.840-3.530)	13.35	99
15+35+35+71	0.90	2.11	2.11	4.28	-	9.40 (3.70-9.80)	3.020 (0.840-3.520)	13.26	99
15+35+42+42	1.04	2.43	2.91	2.91	-	9.30 (3.70-9.80)	3.015 (0.840-3.520)	13.24	99
15+35+42+50	0.99	2.32	2.78	3.31	-	9.40 (3.70-9.80)	3.050 (0.840-3.530)	13.39	99
15+35+42+60	0.93	2.16	2.60	3.71	-	9.40 (3.70-9.80)	3.020 (0.840-3.520)	13.26	99
15+35+42+71	0.87	2.02	2.42	4.09	-	9.40 (3.70-9.80)	3.000 (0.840-3.510)	13.18	99
15+35+50+50	0.94	2.19	3.13	3.13	-	9.40 (3.70-9.80)	3.040 (0.840-3.520)	13.35	99
15+35+50+60	0.88	2.06	2.94	3.53	-	9.40 (3.70-9.80)	3.010 (0.840-3.510)	13.22	99
15+35+50+71	0.82	1.92	2.75	3.90	-	9.40 (3.70-9.80)	2.990 (0.840-3.500)	13.13	99
15+35+60+60	0.83	1.94	3.32	3.32	-	9.40 (3.70-9.80)	2.980 (0.840-3.500)	13.09	99
15+42+42+42	1.00	2.80	2.80	2.80	-	9.40 (3.70-9.80)	3.040 (0.840-3.530)	13.35	99
15+42+42+50	0.95	2.65	2.65	3.15	-	9.40 (3.70-9.80)	3.030 (0.840-3.520)	13.31	99
15+42+42+60	0.89	2.48	2.48	3.55	-	9.40 (3.70-9.80)	3.000 (0.840-3.510)	13.18	99
15+42+42+71	0.83	2.32	2.32	3.93	-	9.40 (3.70-9.80)	2.980 (0.840-3.500)	13.09	99
15+42+50+50	0.90	2.51	2.99	2.99	-	9.40 (3.70-9.80)	3.020 (0.840-3.510)	13.26	99
15+42+50+60	0.84	2.36	2.81	3.38	-	9.40 (3.70-9.80)	2.990 (0.840-3.500)	13.13	99
15+50+50+50	0.85	2.85	2.85	2.85	-	9.40 (3.70-9.80)	3.010 (0.840-3.500)	13.22	99
18+18+18+18	1.80	1.80	1.80	1.80	-	7.20 (3.70-9.20)	2.406 (0.810-3.195)	10.57	99
18+18+18+20	1.78	1.78	1.78	1.97	-	7.30 (3.70-9.00)	2.333 (0.840-3.265)	10.25	99
18+18+18+22	1.80	1.80	1.80	2.20	-	7.60 (3.70-9.20)	2.540 (0.810-3.195)	11.16	99
18+18+18+25	1.80	1.80	1.80	2.50	-	7.90 (3.70-9.20)	2.641 (0.810-3.195)	11.60	99
18+18+18+35	1.78	1.78	1.78	3.46	-	8.80 (3.70-9.30)	2.950 (0.810-3.215)	12.96	99
18+18+18+42	1.63	1.63	1.63	3.81	-	8.70 (3.70-9.70)	2.930 (0.810-3.350)	12.87	99
18+18+18+50	1.51	1.51	1.51	4.18	-	8.70 (3.70-9.90)	2.950 (0.810-3.430)	12.96	99
18+18+18+60	1.41	1.41	1.41	4.68	-	8.90 (3.70-9.90)	2.995 (0.810-3.450)	13.15	99
18+18+18+71	1.31	1.31	1.31	5.17	-	9.10 (3.70-10.00)	3.058 (0.810-3.475)	13.43	99
18+18+20+20	1.75	1.75	1.95	1.95	-	7.40 (3.70-8.80)	2.260 (0.870-3.335)	9.93	99
18+18+20+22	1.78	1.78	1.97	2.17	-	7.70 (3.70-9.00)	2.467 (0.840-3.265)	10.83	99
18+18+20+25	1.78	1.78	1.98	2.47	-	8.00 (3.70-9.00)	2.567 (0.840-3.265)	11.27	99
18+18+20+35	1.72	1.72	1.91	3.35	-	8.70 (3.70-9.20)	2.810 (0.840-3.325)	12.34	99
18+18+20+42	1.56	1.56	1.73	3.64	-	8.50 (3.70-9.60)	2.790 (0.840-3.460)	12.25	99
18+18+20+50	1.46	1.46	1.62	4.06	-	8.60 (3.70-9.70)	2.825 (0.840-3.510)	12.41	99
18+18+20+60	1.37	1.37	1.52	4.55	-	8.80 (3.70-9.70)	2.870 (0.840-3.530)	12.60	99
18+18+20+71	1.28	1.28	1.42	5.03	-	9.00 (3.70-9.80)	2.933 (0.840-3.550)	12.88	99
18+18+22+22	1.80	1.80	2.20	2.20	-	8.00 (3.70-9.20)	2.674 (0.810-3.195)	11.74	99
18+18+22+25	1.80	1.80	2.20	2.50	-	8.30 (3.70-9.20)	2.774 (0.810-3.195)	12.18	99
18+18+22+35	1.68	1.68	2.06	3.27	-	8.70 (3.70-9.50)	2.950 (0.810-3.295)	12.96	99
18+18+22+42	1.55	1.55	1.89	3.61	-	8.60 (3.70-9.90)	2.930 (0.812-3.430)	12.87	99

MXZ-5D102VA COOLING

Indoor units combination	Cooling capacity (kW)						Outdoor unit power consumption(kW)	Current (A)	Power factor(%)
	Unit A	Unit B	Unit C	Unit D	Unit E	Total			
18+18+22+50	1.47	1.47	1.79	4.07	-	8.80 (3.70-9.90)	2.980 (0.810-3.445)	13.09	99
18+18+22+60	1.37	1.37	1.68	4.58	-	9.00 (3.70-9.90)	3.025 (0.810-3.465)	13.29	99
18+18+22+71	1.28	1.28	1.57	5.06	-	9.20 (3.70-10.00)	3.088 (0.810-3.485)	13.56	99
18+18+25+25	1.80	1.80	2.50	2.50	-	8.60 (3.70-9.20)	2.880 (0.810-3.195)	12.65	99
18+18+25+35	1.63	1.63	2.27	3.17	-	8.70 (3.70-9.70)	2.950 (0.810-3.360)	12.96	99
18+18+25+42	1.52	1.52	2.11	3.55	-	8.70 (3.70-9.90)	2.953 (0.810-3.440)	12.97	99
18+18+25+50	1.43	1.43	1.98	3.96	-	8.80 (3.70-9.90)	3.003 (0.810-3.455)	13.19	99
18+18+25+60	1.34	1.34	1.86	4.46	-	9.00 (3.70-10.00)	3.048 (0.810-3.475)	13.39	99
18+18+25+71	1.25	1.25	1.74	4.95	-	9.20 (3.70-10.00)	3.110 (0.810-3.495)	13.66	99
18+18+35+35	1.48	1.48	2.87	2.87	-	8.70 (3.70-9.90)	2.995 (0.810-3.460)	13.15	99
18+18+35+42	1.42	1.42	2.76	3.31	-	8.90 (3.70-9.90)	3.028 (0.810-3.470)	13.30	99
18+18+35+50	1.34	1.34	2.60	3.72	-	9.00 (3.70-10.00)	3.078 (0.810-3.485)	13.52	99
18+18+35+60	1.26	1.26	2.46	4.21	-	9.20 (3.70-10.00)	3.123 (0.810-3.505)	13.72	99
18+18+35+71	1.19	1.19	2.32	4.70	-	9.40 (3.70-10.00)	3.170 (0.810-3.520)	13.92	99
18+18+42+42	1.35	1.35	3.15	3.15	-	9.00 (3.70-10.00)	3.060 (0.810-3.480)	13.44	99
18+18+42+50	1.29	1.29	3.02	3.59	-	9.20 (3.70-10.00)	3.110 (0.810-3.495)	13.66	99
18+18+42+60	1.23	1.23	2.86	4.09	-	9.40 (3.70-10.00)	3.155 (0.810-3.515)	13.86	99
18+18+42+71	1.14	1.14	2.65	4.48	-	9.40 (3.70-10.00)	3.150 (0.810-3.510)	13.83	99
18+18+50+50	1.23	1.23	3.42	3.42	-	9.30 (3.70-10.00)	3.160 (0.810-3.510)	13.88	99
18+18+50+60	1.16	1.16	3.22	3.86	-	9.40 (3.70-10.00)	3.160 (0.810-3.510)	13.88	99
18+18+50+71	1.08	1.08	2.99	4.25	-	9.40 (3.70-10.00)	3.140 (0.810-3.500)	13.79	99
18+18+60+60	1.08	1.08	3.62	3.62	-	9.40 (3.70-10.00)	3.130 (0.810-3.500)	13.75	99
18+18+60+71	1.01	1.01	3.38	4.00	-	9.40 (3.70-10.00)	3.110 (0.810-3.490)	13.66	99
18+20+20+20	1.73	1.92	1.92	1.92	-	7.50 (3.70-8.60)	2.187 (0.900-3.405)	9.60	99
18+20+20+22	1.76	1.95	1.95	2.15	-	7.80 (3.70-8.80)	2.394 (0.870-3.335)	10.51	99
18+20+20+25	1.76	1.95	1.95	2.44	-	8.10 (3.70-8.80)	2.494 (0.870-3.335)	10.95	99
18+20+20+35	1.65	1.83	1.83	3.20	-	8.50 (3.70-9.10)	2.670 (0.870-3.435)	11.73	99
18+20+20+42	1.51	1.68	1.68	3.53	-	8.40 (3.70-9.50)	2.650 (0.872-3.570)	11.64	99
18+20+20+50	1.43	1.59	1.59	3.98	-	8.60 (3.70-9.50)	2.700 (0.870-3.585)	11.86	99
18+20+20+60	1.34	1.49	1.49	4.47	-	8.80 (3.70-9.50)	2.745 (0.870-3.605)	12.06	99
18+20+20+71	1.26	1.40	1.40	4.95	-	9.00 (3.70-9.60)	2.808 (0.870-3.625)	12.33	99
18+20+22+22	1.78	1.98	2.17	2.17	-	8.10 (3.70-9.00)	2.601 (0.840-3.265)	11.42	99
18+20+22+25	1.78	1.98	2.17	2.47	-	8.40 (3.70-9.00)	2.704 (0.840-3.265)	11.88	99
18+20+22+35	1.63	1.81	1.99	3.17	-	8.60 (3.70-9.40)	2.810 (0.840-3.410)	12.34	99
18+20+22+50	1.42	1.58	1.74	3.95	-	8.70 (3.70-9.70)	2.855 (0.840-3.520)	12.54	99
18+20+22+60	1.34	1.48	1.63	4.45	-	8.90 (3.70-9.80)	2.900 (0.840-3.540)	12.74	99
18+20+22+71	1.25	1.39	1.53	4.93	-	9.10 (3.70-9.80)	2.963 (0.840-3.565)	13.01	99
18+20+25+25	1.78	1.98	2.47	2.47	-	8.70 (3.70-9.00)	2.810 (0.840-3.265)	12.34	99
18+20+25+35	1.56	1.73	2.17	3.04	-	8.50 (3.70-9.60)	2.810 (0.840-3.470)	12.34	99
18+20+25+42	1.47	1.64	2.05	3.44	-	8.60 (3.70-9.70)	2.828 (0.840-3.515)	12.42	99
18+20+25+50	1.40	1.56	1.95	3.89	-	8.80 (3.70-9.70)	2.878 (0.840-3.530)	12.64	99

MXZ-5D102VA COOLING

Indoor units combination	Cooling capacity (kW)						Outdoor unit power consumption(kW)	Current (A)	Power factor(%)
	Unit A	Unit B	Unit C	Unit D	Unit E	Total			
18+20+25+60	1.32	1.46	1.83	4.39	-	9.00 (3.70-9.80)	2.923 (0.840-3.550)	12.84	99
18+20+25+71	1.24	1.37	1.72	4.87	-	9.20 (3.70-9.80)	2.985 (0.840-3.570)	13.11	99
18+20+35+35	1.45	1.61	2.82	2.82	-	8.70 (3.70-9.70)	2.870 (0.840-3.535)	12.60	99
18+20+35+42	1.38	1.53	2.68	3.21	-	8.80 (3.70-9.70)	2.903 (0.840-3.545)	12.75	99
18+20+35+50	1.32	1.46	2.56	3.66	-	9.00 (3.70-9.80)	2.953 (0.840-3.560)	12.97	99
18+20+35+60	1.25	1.38	2.42	4.15	-	9.20 (3.70-9.80)	2.998 (0.840-3.580)	13.17	99
18+20+35+71	1.16	1.29	2.26	4.59	-	9.30 (3.70-9.80)	3.030 (0.840-3.590)	13.31	99
18+20+42+42	1.31	1.46	3.06	3.06	-	8.90 (3.70-9.80)	2.935 (0.840-3.555)	12.89	99
18+20+42+50	1.26	1.40	2.94	3.50	-	9.10 (3.70-9.80)	2.985 (0.840-3.570)	13.11	99
18+20+42+60	1.20	1.33	2.79	3.99	-	9.30 (3.70-9.80)	3.030 (0.840-3.590)	13.31	99
18+20+42+71	1.11	1.23	2.59	4.37	-	9.30 (3.70-9.80)	3.010 (0.840-3.580)	13.22	99
18+20+50+50	1.21	1.35	3.37	3.37	-	9.30 (3.70-9.80)	3.035 (0.840-3.585)	13.33	99
18+20+50+60	1.13	1.26	3.14	3.77	-	9.30 (3.70-9.80)	3.020 (0.840-3.580)	13.26	99
18+20+50+71	1.05	1.17	2.92	4.15	-	9.30 (3.70-9.80)	3.000 (0.840-3.570)	13.18	99
18+20+60+60	1.06	1.18	3.53	3.53	-	9.30 (3.70-9.80)	2.990 (0.840-3.570)	13.13	99
18+20+60+71	0.99	1.10	3.30	3.91	-	9.30 (3.70-9.80)	2.970 (0.840-3.560)	13.04	99
18+22+22+22	1.80	2.20	2.20	2.20	-	8.40 (3.70-9.20)	2.809 (0.810-3.195)	12.34	99
18+22+22+25	1.80	2.20	2.20	2.50	-	8.70 (3.70-9.20)	2.915 (0.810-3.195)	12.80	99
18+22+22+35	1.61	1.97	1.97	3.14	-	8.70 (3.70-9.70)	2.950 (0.810-3.380)	12.96	99
18+22+22+42	1.51	1.84	1.84	3.51	-	8.70 (3.70-9.90)	2.960 (0.810-3.440)	13.00	99
18+22+22+50	1.41	1.73	1.73	3.93	-	8.80 (3.70-9.90)	3.010 (0.810-3.455)	13.22	99
18+22+22+60	1.33	1.62	1.62	4.43	-	9.00 (3.70-10.00)	3.055 (0.810-3.475)	13.42	99
18+22+22+71	1.26	1.54	1.54	4.96	-	9.30 (3.70-10.00)	3.118 (0.810-3.500)	13.69	99
18+22+25+25	1.76	2.15	2.44	2.44	-	8.80 (3.70-9.30)	2.950 (0.810-3.235)	12.96	99
18+22+25+35	1.55	1.89	2.15	3.01	-	8.60 (3.70-9.90)	2.950 (0.812-3.440)	12.96	99
18+22+25+42	1.46	1.79	2.03	3.41	-	8.70 (3.70-9.90)	2.983 (0.810-3.450)	13.10	99
18+22+25+50	1.39	1.70	1.93	3.87	-	8.90 (3.70-9.90)	3.033 (0.810-3.465)	13.32	99
18+22+25+60	1.31	1.60	1.82	4.37	-	9.10 (3.70-10.00)	3.078 (0.810-3.485)	13.52	99
18+22+25+71	1.23	1.50	1.71	4.86	-	9.30 (3.70-10.00)	3.140 (0.810-3.510)	13.79	99
18+22+35+35	1.44	1.76	2.80	2.80	-	8.80 (3.70-9.90)	3.025 (0.810-3.470)	13.29	99
18+22+35+42	1.37	1.67	2.66	3.19	-	8.90 (3.70-9.90)	3.058 (0.810-3.480)	13.43	99
18+22+35+50	1.31	1.60	2.55	3.64	-	9.10 (3.70-10.00)	3.108 (0.810-3.495)	13.65	99
18+22+35+60	1.24	1.52	2.41	4.13	-	9.30 (3.70-10.00)	3.153 (0.810-3.515)	13.85	99
18+22+35+71	1.16	1.42	2.25	4.57	-	9.40 (3.70-10.00)	3.170 (0.810-3.520)	13.92	99
18+22+42+42	1.32	1.61	3.08	3.08	-	9.10 (3.70-10.00)	3.090 (0.810-3.490)	13.57	99
18+22+42+50	1.25	1.53	2.93	3.48	-	9.20 (3.70-10.00)	3.140 (0.810-3.505)	13.79	99
18+22+42+60	1.19	1.46	2.78	3.97	-	9.40 (3.70-10.00)	3.170 (0.810-3.520)	13.92	99
18+22+42+71	1.11	1.35	2.58	4.36	-	9.40 (3.70-10.00)	3.150 (0.810-3.510)	13.83	99
18+22+50+50	1.21	1.48	3.36	3.36	-	9.40 (3.70-10.00)	3.190 (0.810-3.520)	14.01	99
18+22+50+60	1.13	1.38	3.13	3.76	-	9.40 (3.70-10.00)	3.160 (0.810-3.510)	13.88	99
18+22+50+71	1.05	1.28	2.92	4.15	-	9.40 (3.70-10.00)	3.140 (0.810-3.500)	13.79	99

MXZ-5D102VA COOLING

Indoor units combination	Cooling capacity (kW)						Outdoor unit power consumption(kW)	Current (A)	Power factor(%)
	Unit A	Unit B	Unit C	Unit D	Unit E	Total			
18+22+60+60	1.06	1.29	3.53	3.53	-	9.40 (3.70-10.00)	3.130 (0.810-3.500)	13.75	99
18+22+60+71	0.99	1.21	3.30	3.90	-	9.40 (3.70-10.00)	3.110 (0.810-3.490)	13.66	99
18+25+25+25	1.68	2.34	2.34	2.34	-	8.70 (3.70-9.50)	2.950 (0.810-3.295)	12.96	99
18+25+25+35	1.52	2.11	2.11	2.96	-	8.70 (3.70-9.90)	2.973 (0.810-3.450)	13.06	99
18+25+25+42	1.44	2.00	2.00	3.36	-	8.80 (3.70-9.90)	3.005 (0.810-3.460)	13.20	99
18+25+25+50	1.37	1.91	1.91	3.81	-	9.00 (3.70-9.90)	3.055 (0.810-3.475)	13.42	99
18+25+25+60	1.29	1.80	1.80	4.31	-	9.20 (3.70-10.00)	3.100 (0.810-3.495)	13.61	99
18+25+25+71	1.22	1.69	1.69	4.80	-	9.40 (3.70-10.00)	3.163 (0.810-3.515)	13.89	99
18+25+35+35	1.42	1.97	2.76	2.76	-	8.90 (3.70-9.90)	3.048 (0.810-3.480)	13.39	99
18+25+35+42	1.35	1.88	2.63	3.15	-	9.00 (3.70-10.00)	3.080 (0.810-3.490)	13.53	99
18+25+35+50	1.29	1.80	2.52	3.59	-	9.20 (3.70-10.00)	3.130 (0.810-3.505)	13.75	99
18+25+35+60	1.23	1.70	2.38	4.09	-	9.40 (3.70-10.00)	3.175 (0.810-3.525)	13.94	99
18+25+35+71	1.14	1.58	2.21	4.48	-	9.40 (3.70-10.00)	3.170 (0.810-3.520)	13.92	99
18+25+42+42	1.29	1.79	3.01	3.01	-	9.10 (3.70-10.00)	3.113 (0.810-3.500)	13.67	99
18+25+42+50	1.24	1.72	2.89	3.44	-	9.30 (3.70-10.00)	3.163 (0.810-3.515)	13.89	99
18+25+42+60	1.17	1.62	2.72	3.89	-	9.40 (3.70-10.00)	3.170 (0.810-3.520)	13.92	99
18+25+42+71	1.08	1.51	2.53	4.28	-	9.40 (3.70-10.00)	3.150 (0.810-3.510)	13.83	99
18+25+50+50	1.18	1.64	3.29	3.29	-	9.40 (3.70-10.00)	3.190 (0.810-3.520)	14.01	99
18+25+50+60	1.11	1.54	3.07	3.69	-	9.40 (3.70-10.00)	3.160 (0.810-3.510)	13.88	99
18+25+50+71	1.03	1.43	2.87	4.07	-	9.40 (3.70-10.00)	3.140 (0.810-3.500)	13.79	99
18+25+60+60	1.04	1.44	3.46	3.46	-	9.40 (3.70-10.00)	3.130 (0.810-3.500)	13.75	99
18+35+35+35	1.33	2.59	2.59	2.59	-	9.10 (3.70-10.00)	3.123 (0.810-3.510)	13.72	99
18+35+35+42	1.27	2.48	2.48	2.97	-	9.20 (3.70-10.00)	3.155 (0.810-3.520)	13.86	99
18+35+35+50	1.23	2.38	2.38	3.41	-	9.40 (3.70-10.00)	3.205 (0.810-3.535)	14.08	99
18+35+35+60	1.14	2.22	2.22	3.81	-	9.40 (3.70-10.00)	3.190 (0.810-3.530)	14.01	99
18+35+35+71	1.06	2.07	2.07	4.20	-	9.40 (3.70-10.00)	3.170 (0.810-3.520)	13.92	99
18+35+42+42	1.22	2.38	2.85	2.85	-	9.30 (3.70-10.00)	3.188 (0.810-3.530)	14.00	99
18+35+42+50	1.17	2.27	2.72	3.24	-	9.40 (3.70-10.00)	3.200 (0.810-3.530)	14.05	99
18+35+42+60	1.09	2.12	2.55	3.64	-	9.40 (3.70-10.00)	3.170 (0.810-3.520)	13.92	99
18+35+42+71	1.02	1.98	2.38	4.02	-	9.40 (3.70-10.00)	3.150 (0.810-3.510)	13.83	99
18+35+50+50	1.11	2.15	3.07	3.07	-	9.40 (3.70-10.00)	3.190 (0.810-3.520)	14.01	99
18+35+50+60	1.04	2.02	2.88	3.46	-	9.40 (3.70-10.00)	3.160 (0.810-3.510)	13.88	99
18+42+42+42	1.18	2.74	2.74	2.74	-	9.40 (3.70-10.00)	3.190 (0.810-3.530)	14.01	99
18+42+42+50	1.11	2.60	2.60	3.09	-	9.40 (3.70-10.00)	3.180 (0.810-3.520)	13.97	99
18+42+42+60	1.04	2.44	2.44	3.48	-	9.40 (3.70-10.00)	3.150 (0.810-3.510)	13.83	99
18+42+50+50	1.06	2.47	2.94	2.94	-	9.40 (3.70-10.00)	3.170 (0.810-3.510)	13.92	99
18+42+50+60	1.00	2.32	2.76	3.32	-	9.40 (3.70-10.00)	3.140 (0.810-3.500)	13.79	99
18+50+50+50	1.01	2.80	2.80	2.80	-	9.40 (3.70-10.00)	3.160 (0.810-3.500)	13.88	99
20+20+20+20	1.90	1.90	1.90	1.90	-	7.60 (3.70-8.40)	2.674 (0.810-3.195)	11.74	99
20+20+20+22	1.93	1.93	1.93	2.12	-	7.90 (3.70-8.60)	2.321 (0.900-3.405)	10.19	99
20+20+20+25	1.93	1.93	1.93	2.41	-	8.20 (3.70-8.60)	2.424 (0.900-3.405)	10.65	99

MXZ-5D102VA COOLING

Indoor units combination	Cooling capacity (kW)						Outdoor unit power consumption(kW)	Current (A)	Power factor(%)
	Unit A	Unit B	Unit C	Unit D	Unit E	Total			
20+20+20+35	1.77	1.77	1.77	3.09	-	8.40 (3.70-9.00)	2.530 (0.900-3.550)	11.11	99
20+20+20+50	1.55	1.55	1.55	3.86	-	8.50 (3.70-9.30)	2.575 (0.900-3.660)	11.31	99
20+20+20+60	1.45	1.45	1.45	4.35	-	8.70 (3.70-9.40)	2.620 (0.900-3.680)	11.51	99
20+20+20+71	1.36	1.36	1.36	4.82	-	8.90 (3.70-9.40)	2.683 (0.900-3.705)	11.78	99
20+20+22+22	1.95	1.95	2.15	2.15	-	8.20 (3.70-8.80)	2.529 (0.870-3.335)	11.11	99
20+20+22+25	1.95	1.95	2.15	2.44	-	8.50 (3.70-8.80)	2.635 (0.870-3.335)	11.57	99
20+20+22+35	1.75	1.75	1.93	3.07	-	8.50 (3.70-9.30)	2.670 (0.870-3.520)	11.73	99
20+20+22+42	1.63	1.63	1.80	3.43	-	8.50 (3.70-9.50)	2.680 (0.870-3.580)	11.77	99
20+20+22+50	1.54	1.54	1.69	3.84	-	8.60 (3.70-9.50)	2.730 (0.870-3.595)	11.99	99
20+20+22+60	1.44	1.44	1.59	4.33	-	8.80 (3.70-9.60)	2.775 (0.870-3.615)	12.19	99
20+20+22+71	1.37	1.37	1.51	4.86	-	9.10 (3.70-9.60)	2.838 (0.870-3.640)	12.46	99
20+20+25+25	1.91	1.91	2.39	2.39	-	8.60 (3.70-8.90)	2.670 (0.870-3.375)	11.73	99
20+20+25+35	1.68	1.68	2.10	2.94	-	8.40 (3.70-9.50)	2.670 (0.872-3.580)	11.73	99
20+20+25+42	1.59	1.59	1.99	3.34	-	8.50 (3.70-9.50)	2.703 (0.870-3.590)	11.87	99
20+20+25+50	1.51	1.51	1.89	3.78	-	8.70 (3.70-9.50)	2.753 (0.870-3.605)	12.09	99
20+20+25+60	1.42	1.42	1.78	4.27	-	8.90 (3.70-9.60)	2.798 (0.870-3.625)	12.29	99
20+20+25+71	1.34	1.34	1.67	4.75	-	9.10 (3.70-9.60)	2.860 (0.870-3.650)	12.56	99
20+20+35+35	1.56	1.56	2.74	2.74	-	8.60 (3.70-9.50)	2.745 (0.870-3.610)	12.06	99
20+20+35+42	1.49	1.49	2.60	3.12	-	8.70 (3.70-9.50)	2.778 (0.870-3.620)	12.20	99
20+20+35+50	1.42	1.42	2.49	3.56	-	8.90 (3.70-9.60)	2.828 (0.870-3.635)	12.42	99
20+20+35+60	1.35	1.35	2.36	4.04	-	9.10 (3.70-9.60)	2.873 (0.870-3.655)	12.62	99
20+20+35+71	1.26	1.26	2.21	4.47	-	9.20 (3.70-9.60)	2.890 (0.870-3.660)	12.69	99
20+20+42+42	1.44	1.44	3.01	3.01	-	8.90 (3.70-9.60)	2.810 (0.870-3.630)	12.34	99
20+20+42+50	1.36	1.36	2.86	3.41	-	9.00 (3.70-9.60)	2.860 (0.870-3.645)	12.56	99
20+20+42+60	1.30	1.30	2.72	3.89	-	9.20 (3.70-9.60)	2.890 (0.870-3.660)	12.69	99
20+20+42+71	1.20	1.20	2.53	4.27	-	9.20 (3.70-9.60)	2.870 (0.870-3.650)	12.60	99
20+20+50+50	1.31	1.31	3.29	3.29	-	9.20 (3.70-9.60)	2.910 (0.870-3.660)	12.78	99
20+20+50+60	1.23	1.23	3.07	3.68	-	9.20 (3.70-9.60)	2.880 (0.870-3.650)	12.65	99
20+20+50+71	1.14	1.14	2.86	4.06	-	9.20 (3.70-9.60)	2.860 (0.870-3.640)	12.56	99
20+20+60+60	1.15	1.15	3.45	3.45	-	9.20 (3.70-9.60)	2.850 (0.870-3.640)	12.52	99
20+20+60+71	1.08	1.08	3.23	3.82	-	9.20 (3.70-9.60)	2.830 (0.870-3.630)	12.43	99
20+22+22+22	1.98	2.17	2.17	2.17	-	8.50 (3.70-9.00)	2.740 (0.840-3.265)	12.03	99
20+22+22+25	1.96	2.15	2.15	2.44	-	8.70 (3.70-9.10)	2.810 (0.840-3.285)	12.34	99
20+22+22+35	1.72	1.89	1.89	3.01	-	8.50 (3.70-9.60)	2.810 (0.840-3.490)	12.34	99
20+22+22+42	1.62	1.78	1.78	3.41	-	8.60 (3.70-9.70)	2.835 (0.840-3.520)	12.45	99
20+22+22+50	1.54	1.70	1.70	3.86	-	8.80 (3.70-9.70)	2.885 (0.840-3.530)	12.67	99
20+22+22+60	1.45	1.60	1.60	4.35	-	9.00 (3.70-9.80)	2.930 (0.840-3.550)	12.87	99
20+22+22+71	1.36	1.50	1.50	4.84	-	9.20 (3.70-9.80)	2.993 (0.840-3.575)	13.14	99
20+22+25+25	1.87	2.06	2.34	2.34	-	8.60 (3.70-9.20)	2.810 (0.840-3.345)	12.34	99
20+22+25+42	1.60	1.76	2.00	3.35	-	8.70 (3.70-9.70)	2.858 (0.840-3.525)	12.55	99
20+22+25+50	1.50	1.65	1.88	3.76	-	8.80 (3.70-9.70)	2.908 (0.840-3.540)	12.77	99

MXZ-5D102VA COOLING

Indoor units combination	Cooling capacity (kW)						Outdoor unit power consumption(kW)	Current (A)	Power factor(%)
	Unit A	Unit B	Unit C	Unit D	Unit E	Total			
20+22+25+60	1.42	1.56	1.77	4.25	-	9.00 (3.70-9.80)	2.953 (0.840-3.560)	12.97	99
20+22+25+71	1.35	1.48	1.68	4.78	-	9.30 (3.70-9.80)	3.015 (0.840-3.585)	13.24	99
20+22+35+35	1.55	1.71	2.72	2.72	-	8.70 (3.70-9.70)	2.900 (0.840-3.545)	12.74	99
20+22+35+42	1.50	1.65	2.62	3.14	-	8.90 (3.70-9.70)	2.933 (0.840-3.555)	12.88	99
20+22+35+50	1.42	1.56	2.48	3.54	-	9.00 (3.70-9.80)	2.983 (0.840-3.570)	13.10	99
20+22+35+60	1.34	1.48	2.35	4.03	-	9.20 (3.70-9.80)	3.028 (0.840-3.590)	13.30	99
20+22+35+71	1.26	1.38	2.20	4.46	-	9.30 (3.70-9.80)	3.030 (0.840-3.590)	13.31	99
20+22+42+42	1.43	1.57	3.00	3.00	-	9.00 (3.70-9.80)	2.965 (0.840-3.570)	13.02	99
20+22+42+50	1.37	1.51	2.88	3.43	-	9.20 (3.70-9.80)	3.015 (0.840-3.580)	13.24	99
20+22+42+60	1.29	1.42	2.71	3.88	-	9.30 (3.70-9.80)	3.030 (0.840-3.590)	13.31	99
20+22+42+71	1.20	1.32	2.52	4.26	-	9.30 (3.70-9.80)	3.010 (0.840-3.580)	13.22	99
20+22+50+50	1.31	1.44	3.27	3.27	-	9.30 (3.70-9.80)	3.050 (0.840-3.590)	13.39	99
20+22+50+60	1.22	1.35	3.06	3.67	-	9.30 (3.70-9.80)	3.020 (0.840-3.580)	13.26	99
20+22+50+71	1.14	1.26	2.85	4.05	-	9.30 (3.70-9.80)	3.000 (0.840-3.570)	13.18	99
20+22+60+60	1.15	1.26	3.44	3.44	-	9.30 (3.70-9.80)	2.990 (0.840-3.570)	13.13	99
20+25+25+25	1.81	2.26	2.26	2.26	-	8.60 (3.70-9.40)	2.810 (0.840-3.410)	12.34	99
20+25+25+35	1.64	2.05	2.05	2.87	-	8.60 (3.70-9.70)	2.848 (0.840-3.525)	12.51	99
20+25+25+42	1.55	1.94	1.94	3.26	-	8.70 (3.70-9.70)	2.880 (0.840-3.535)	12.65	99
20+25+25+50	1.48	1.85	1.85	3.71	-	8.90 (3.70-9.80)	2.930 (0.840-3.550)	12.87	99
20+25+25+60	1.40	1.75	1.75	4.20	-	9.10 (3.70-9.80)	2.975 (0.840-3.570)	13.07	99
20+25+25+71	1.32	1.65	1.65	4.68	-	9.30 (3.70-9.80)	3.030 (0.840-3.590)	13.31	99
20+25+35+35	1.53	1.91	2.68	2.68	-	8.80 (3.70-9.70)	2.923 (0.840-3.555)	12.84	99
20+25+35+42	1.46	1.82	2.55	3.06	-	8.90 (3.70-9.80)	2.955 (0.840-3.565)	12.98	99
20+25+35+50	1.40	1.75	2.45	3.50	-	9.10 (3.70-9.80)	3.005 (0.840-3.580)	13.20	99
20+25+35+60	1.33	1.66	2.33	3.99	-	9.30 (3.70-9.80)	3.050 (0.840-3.600)	13.39	99
20+25+35+71	1.23	1.54	2.16	4.37	-	9.30 (3.70-9.80)	3.030 (0.840-3.590)	13.31	99
20+25+42+42	1.41	1.76	2.96	2.96	-	9.10 (3.70-9.80)	2.988 (0.840-3.575)	13.12	99
20+25+42+50	1.34	1.68	2.82	3.36	-	9.20 (3.70-9.80)	3.038 (0.840-3.590)	13.34	99
20+25+42+60	1.27	1.58	2.66	3.80	-	9.30 (3.70-9.80)	3.030 (0.840-3.590)	13.31	99
20+25+42+71	1.18	1.47	2.47	4.18	-	9.30 (3.70-9.80)	3.010 (0.840-3.580)	13.22	99
20+25+50+50	1.28	1.60	3.21	3.21	-	9.30 (3.70-9.80)	3.050 (0.840-3.590)	13.39	99
20+25+50+60	1.20	1.50	3.00	3.60	-	9.30 (3.70-9.80)	3.020 (0.840-3.580)	13.26	99
20+25+50+71	1.12	1.40	2.80	3.98	-	9.30 (3.70-9.80)	3.000 (0.840-3.570)	13.18	99
20+25+60+60	1.13	1.41	3.38	3.38	-	9.30 (3.70-9.80)	2.990 (0.840-3.570)	13.13	99
20+35+35+35	1.44	2.52	2.52	2.52	-	9.00 (3.70-9.80)	2.998 (0.840-3.585)	13.17	99
20+35+35+42	1.38	2.41	2.41	2.90	-	9.10 (3.70-9.80)	3.030 (0.840-3.595)	13.31	99
20+35+35+50	1.33	2.33	2.33	3.32	-	9.30 (3.70-9.80)	3.080 (0.840-3.610)	13.53	99
20+35+35+60	1.24	2.17	2.17	3.72	-	9.30 (3.70-9.80)	3.050 (0.840-3.600)	13.39	99
20+35+35+71	1.16	2.02	2.02	4.10	-	9.30 (3.70-9.80)	3.030 (0.840-3.590)	13.31	99
20+35+42+42	1.34	2.34	2.81	2.81	-	9.30 (3.70-9.80)	3.063 (0.840-3.605)	13.45	99
20+35+42+50	1.27	2.21	2.66	3.16	-	9.30 (3.70-9.80)	3.060 (0.840-3.600)	13.44	99

MXZ-5D102VA COOLING

Indoor units combination	Cooling capacity (kW)						Outdoor unit power consumption(kW)	Current (A)	Power factor(%)
	Unit A	Unit B	Unit C	Unit D	Unit E	Total			
20+35+42+60	1.18	2.07	2.49	3.55	-	9.30 (3.70-9.80)	3.030 (0.840-3.590)	13.31	99
20+35+42+71	1.11	1.94	2.33	3.93	-	9.30 (3.70-9.80)	3.010 (0.840-3.580)	13.22	99
20+35+50+50	1.20	2.10	3.00	3.00	-	9.30 (3.70-9.80)	3.050 (0.840-3.590)	13.39	99
20+35+50+60	1.13	1.97	2.82	3.38	-	9.30 (3.70-9.80)	3.020 (0.840-3.580)	13.26	99
20+42+42+42	1.27	2.68	2.68	2.68	-	9.30 (3.70-9.80)	3.050 (0.840-3.600)	13.39	99
20+42+42+50	1.21	2.54	2.54	3.02	-	9.30 (3.70-9.80)	3.040 (0.840-3.590)	13.35	99
20+42+42+60	1.13	2.38	2.38	3.40	-	9.30 (3.70-9.80)	3.010 (0.840-3.580)	13.22	99
20+42+50+50	1.15	2.41	2.87	2.87	-	9.30 (3.70-9.80)	3.030 (0.840-3.580)	13.31	99
20+42+50+60	1.08	2.27	2.70	3.24	-	9.30 (3.70-9.80)	3.000 (0.840-3.570)	13.18	99
20+50+50+50	1.09	2.74	2.74	2.74	-	9.30 (3.70-9.80)	3.020 (0.840-3.570)	13.26	99
22+22+22+22	2.20	2.20	2.20	2.20	-	8.80 (3.70-9.20)	2.950 (0.810-3.195)	12.96	99
22+22+22+25	2.13	2.13	2.13	2.42	-	8.80 (3.70-9.40)	2.950 (0.810-3.255)	12.96	99
22+22+22+35	1.87	1.87	1.87	2.98	-	8.60 (3.70-9.90)	2.958 (0.810-3.445)	12.99	99
22+22+22+42	1.79	1.79	1.79	3.42	-	8.80 (3.70-9.90)	2.990 (0.810-3.455)	13.13	99
22+22+22+50	1.69	1.69	1.69	3.84	-	8.90 (3.70-9.90)	3.040 (0.810-3.470)	13.35	99
22+22+22+60	1.59	1.59	1.59	4.33	-	9.10 (3.70-10.00)	3.085 (0.810-3.490)	13.55	99
22+22+22+71	1.49	1.49	1.49	4.82	-	9.30 (3.70-10.00)	3.148 (0.810-3.510)	13.83	99
22+22+25+25	2.04	2.04	2.31	2.31	-	8.70 (3.70-9.60)	2.950 (0.810-3.320)	12.96	99
22+22+25+35	1.84	1.84	2.09	2.93	-	8.70 (3.70-9.90)	2.980 (0.810-3.450)	13.09	99
22+22+25+42	1.74	1.74	1.98	3.33	-	8.80 (3.70-9.90)	3.013 (0.810-3.465)	13.23	99
22+22+25+50	1.66	1.66	1.89	3.78	-	9.00 (3.70-9.90)	3.063 (0.810-3.475)	13.45	99
22+22+25+60	1.57	1.57	1.78	4.28	-	9.20 (3.70-10.00)	3.108 (0.810-3.495)	13.65	99
22+22+25+71	1.48	1.48	1.68	4.77	-	9.40 (3.70-10.00)	3.170 (0.810-3.520)	13.92	99
22+22+35+35	1.72	1.72	2.73	2.73	-	8.90 (3.70-9.90)	3.055 (0.810-3.480)	13.42	99
22+22+35+42	1.64	1.64	2.60	3.12	-	9.00 (3.70-10.00)	3.088 (0.810-3.495)	13.56	99
22+22+35+50	1.57	1.57	2.50	3.57	-	9.20 (3.70-10.00)	3.138 (0.810-3.505)	13.78	99
22+22+35+60	1.49	1.49	2.37	4.06	-	9.40 (3.70-10.00)	3.183 (0.810-3.525)	13.98	99
22+22+35+71	1.38	1.38	2.19	4.45	-	9.40 (3.70-10.00)	3.170 (0.810-3.520)	13.92	99
22+22+42+42	1.58	1.58	3.02	3.02	-	9.20 (3.70-10.00)	3.120 (0.810-3.505)	13.70	99
22+22+42+50	1.50	1.50	2.87	3.42	-	9.30 (3.70-10.00)	3.170 (0.810-3.520)	13.92	99
22+22+42+60	1.42	1.42	2.70	3.86	-	9.40 (3.70-10.00)	3.170 (0.810-3.520)	13.92	99
22+22+42+71	1.32	1.32	2.51	4.25	-	9.40 (3.70-10.00)	3.150 (0.810-3.510)	13.83	99
22+22+50+50	1.44	1.44	3.26	3.26	-	9.40 (3.70-10.00)	3.190 (0.810-3.520)	14.01	99
22+22+50+60	1.34	1.34	3.05	3.66	-	9.40 (3.70-10.00)	3.160 (0.810-3.510)	13.88	99
22+22+50+71	1.25	1.25	2.85	4.04	-	9.40 (3.70-10.00)	3.140 (0.810-3.500)	13.79	99
22+22+60+60	1.26	1.26	3.44	3.44	-	9.40 (3.70-10.00)	3.130 (0.810-3.500)	13.75	99
22+25+25+25	1.97	2.24	2.24	2.24	-	8.70 (3.70-9.70)	2.950 (0.810-3.380)	12.96	99
22+25+25+35	1.79	2.03	2.03	2.85	-	8.70 (3.70-9.90)	3.003 (0.810-3.460)	13.19	99
22+25+25+42	1.72	1.95	1.95	3.28	-	8.90 (3.70-9.90)	3.035 (0.810-3.470)	13.33	99
22+25+25+50	1.62	1.84	1.84	3.69	-	9.00 (3.70-10.00)	3.085 (0.810-3.485)	13.55	99
22+25+25+60	1.53	1.74	1.74	4.18	-	9.20 (3.70-10.00)	3.130 (0.810-3.505)	13.75	99

MXZ-5D102VA COOLING

Indoor units combination	Cooling capacity (kW)						Outdoor unit power consumption(kW)	Current (A)	Power factor(%)
	Unit A	Unit B	Unit C	Unit D	Unit E	Total			
22+25+25+71	1.45	1.64	1.64	4.67	-	9.40 (3.70-10.00)	3.170 (0.810-3.520)	13.92	99
22+25+35+35	1.67	1.90	2.66	2.66	-	8.90 (3.70-9.90)	3.078 (0.810-3.490)	13.52	99
22+25+35+42	1.61	1.83	2.57	3.08	-	9.10 (3.70-10.00)	3.110 (0.810-3.500)	13.66	99
22+25+35+50	1.53	1.74	2.44	3.48	-	9.20 (3.70-10.00)	3.160 (0.810-3.515)	13.88	99
22+25+35+60	1.46	1.65	2.32	3.97	-	9.40 (3.70-10.00)	3.190 (0.810-3.530)	14.01	99
22+25+35+71	1.35	1.54	2.15	4.36	-	9.40 (3.70-10.00)	3.170 (0.810-3.520)	13.92	99
22+25+42+42	1.55	1.76	2.95	2.95	-	9.20 (3.70-10.00)	3.143 (0.810-3.515)	13.80	99
22+25+42+50	1.49	1.69	2.84	3.38	-	9.40 (3.70-10.00)	3.193 (0.810-3.525)	14.02	99
22+25+42+60	1.39	1.58	2.65	3.79	-	9.40 (3.70-10.00)	3.170 (0.810-3.520)	13.92	99
22+25+42+71	1.29	1.47	2.47	4.17	-	9.40 (3.70-10.00)	3.150 (0.810-3.510)	13.83	99
22+25+50+50	1.41	1.60	3.20	3.20	-	9.40 (3.70-10.00)	3.190 (0.810-3.520)	14.01	99
22+25+50+60	1.32	1.50	2.99	3.59	-	9.40 (3.70-10.00)	3.160 (0.810-3.510)	13.88	99
22+25+50+71	1.23	1.40	2.80	3.97	-	9.40 (3.70-10.00)	3.140 (0.810-3.500)	13.79	99
22+25+60+60	1.24	1.41	3.38	3.38	-	9.40 (3.70-10.00)	3.130 (0.810-3.500)	13.75	99
22+35+35+35	1.58	2.51	2.51	2.51	-	9.10 (3.70-10.00)	3.153 (0.810-3.520)	13.85	99
22+35+35+42	1.53	2.43	2.43	2.91	-	9.30 (3.70-10.00)	3.185 (0.810-3.530)	13.99	99
22+35+35+50	1.46	2.32	2.32	3.31	-	9.40 (3.70-10.00)	3.220 (0.810-3.540)	14.14	99
22+35+35+60	1.36	2.16	2.16	3.71	-	9.40 (3.70-10.00)	3.190 (0.810-3.530)	14.01	99
22+35+35+71	1.27	2.02	2.02	4.09	-	9.40 (3.70-10.00)	3.170 (0.810-3.520)	13.92	99
22+35+42+42	1.47	2.33	2.80	2.80	-	9.40 (3.70-10.00)	3.210 (0.810-3.540)	14.10	99
22+35+42+50	1.39	2.21	2.65	3.15	-	9.40 (3.70-10.00)	3.200 (0.810-3.530)	14.05	99
22+35+42+60	1.30	2.07	2.48	3.55	-	9.40 (3.70-10.00)	3.170 (0.810-3.520)	13.92	99
22+35+42+71	1.22	1.94	2.32	3.93	-	9.40 (3.70-10.00)	3.150 (0.810-3.510)	13.83	99
22+35+50+50	1.32	2.10	2.99	2.99	-	9.40 (3.70-10.00)	3.190 (0.810-3.520)	14.01	99
22+35+50+60	1.24	1.97	2.81	3.38	-	9.40 (3.70-10.00)	3.160 (0.810-3.510)	13.88	99
22+42+42+42	1.40	2.67	2.67	2.67	-	9.40 (3.70-10.00)	3.190 (0.810-3.530)	14.01	99
22+42+42+50	1.33	2.53	2.53	3.01	-	9.40 (3.70-10.00)	3.180 (0.810-3.520)	13.97	99
22+42+42+60	1.25	2.38	2.38	3.40	-	9.40 (3.70-10.00)	3.150 (0.810-3.510)	13.83	99
22+42+50+50	1.26	2.41	2.87	2.87	-	9.40 (3.70-10.00)	3.170 (0.810-3.510)	13.92	99
22+50+50+50	1.20	2.73	2.73	2.73	-	9.40 (3.70-10.00)	3.160 (0.810-3.500)	13.88	99
25+25+25+25	2.15	2.15	2.15	2.15	-	8.60 (3.70-9.90)	2.950 (0.812-3.440)	12.96	99
25+25+25+35	2.00	2.00	2.00	2.80	-	8.80 (3.70-9.90)	3.025 (0.810-3.470)	13.29	99
25+25+25+42	1.90	1.90	1.90	3.19	-	8.90 (3.70-9.90)	3.058 (0.810-3.480)	13.43	99
25+25+25+50	1.82	1.82	1.82	3.64	-	9.10 (3.70-10.00)	3.108 (0.810-3.495)	13.65	99
25+25+25+60	1.72	1.72	1.72	4.13	-	9.30 (3.70-10.00)	3.153 (0.810-3.515)	13.85	99
25+25+25+71	1.61	1.61	1.61	4.57	-	9.40 (3.70-10.00)	3.170 (0.810-3.520)	13.92	99
25+25+35+35	1.88	1.88	2.63	2.63	-	9.00 (3.70-10.00)	3.100 (0.810-3.500)	13.61	99
25+25+35+42	1.79	1.79	2.51	3.01	-	9.10 (3.70-10.00)	3.133 (0.810-3.510)	13.76	99
25+25+35+50	1.72	1.72	2.41	3.44	-	9.30 (3.70-10.00)	3.183 (0.810-3.525)	13.98	99
25+25+35+60	1.62	1.62	2.27	3.89	-	9.40 (3.70-10.00)	3.190 (0.810-3.530)	14.01	99
25+25+35+71	1.51	1.51	2.11	4.28	-	9.40 (3.70-10.00)	3.170 (0.810-3.520)	13.92	99

MXZ-5D102VA COOLING

Indoor units combination	Cooling capacity (kW)						Outdoor unit power consumption(kW)	Current (A)	Power factor(%)
	Unit A	Unit B	Unit C	Unit D	Unit E	Total			
25+25+42+42	1.74	1.74	2.91	2.91	-	9.30 (3.70-10.00)	3.165 (0.810-3.520)	13.90	99
25+25+42+50	1.65	1.65	2.78	3.31	-	9.40 (3.70-10.00)	3.200 (0.810-3.530)	14.05	99
25+25+42+60	1.55	1.55	2.60	3.71	-	9.40 (3.70-10.00)	3.170 (0.810-3.520)	13.92	99
25+25+42+71	1.44	1.44	2.42	4.09	-	9.40 (3.70-10.00)	3.150 (0.810-3.510)	13.83	99
25+25+50+50	1.57	1.57	3.13	3.13	-	9.40 (3.70-10.00)	3.190 (0.810-3.520)	14.01	99
25+25+50+60	1.47	1.47	2.94	3.53	-	9.40 (3.70-10.00)	3.160 (0.810-3.510)	13.88	99
25+25+50+71	1.37	1.37	2.75	3.90	-	9.40 (3.70-10.00)	3.140 (0.810-3.500)	13.79	99
25+25+60+60	1.38	1.38	3.32	3.32	-	9.40 (3.70-10.00)	3.130 (0.810-3.500)	13.75	99
25+35+35+35	1.77	2.48	2.48	2.48	-	9.20 (3.70-10.00)	3.175 (0.810-3.530)	13.94	99
25+35+35+42	1.70	2.38	2.38	2.85	-	9.30 (3.70-10.00)	3.208 (0.810-3.540)	14.09	99
25+35+35+50	1.62	2.27	2.27	3.24	-	9.40 (3.70-10.00)	3.220 (0.810-3.540)	14.14	99
25+35+35+60	1.52	2.12	2.12	3.64	-	9.40 (3.70-10.00)	3.190 (0.810-3.530)	14.01	99
25+35+35+71	1.42	1.98	1.98	4.02	-	9.40 (3.70-10.00)	3.170 (0.810-3.520)	13.92	99
25+35+42+42	1.63	2.28	2.74	2.74	-	9.40 (3.70-10.00)	3.210 (0.810-3.540)	14.10	99
25+35+42+50	1.55	2.16	2.60	3.09	-	9.40 (3.70-10.00)	3.200 (0.810-3.530)	14.05	99
25+35+42+60	1.45	2.03	2.44	3.48	-	9.40 (3.70-10.00)	3.170 (0.810-3.520)	13.92	99
25+35+50+50	1.47	2.06	2.94	2.94	-	9.40 (3.70-10.00)	3.190 (0.810-3.520)	14.01	99
25+35+50+60	1.38	1.94	2.76	3.32	-	9.40 (3.70-10.00)	3.160 (0.810-3.510)	13.88	99
25+42+42+42	1.56	2.61	2.61	2.61	-	9.40 (3.70-10.00)	3.190 (0.810-3.530)	14.01	99
25+42+42+50	1.48	2.48	2.48	2.96	-	9.40 (3.70-10.00)	3.180 (0.810-3.520)	13.97	99
25+42+42+60	1.39	2.34	2.34	3.34	-	9.40 (3.70-10.00)	3.150 (0.810-3.510)	13.83	99
25+42+50+50	1.41	2.36	2.81	2.81	-	9.40 (3.70-10.00)	3.170 (0.810-3.510)	13.92	99
35+35+35+35	2.35	2.35	2.35	2.35	-	9.40 (3.70-10.00)	3.250 (0.810-3.560)	14.27	99
35+35+35+42	2.24	2.24	2.24	2.69	-	9.40 (3.70-10.00)	3.230 (0.810-3.550)	14.19	99
35+35+35+50	2.12	2.12	2.12	3.03	-	9.40 (3.70-10.00)	3.220 (0.810-3.540)	14.14	99
35+35+35+60	1.99	1.99	1.99	3.42	-	9.40 (3.70-10.00)	3.190 (0.810-3.530)	14.01	99
35+35+42+42	2.14	2.14	2.56	2.56	-	9.40 (3.70-10.00)	3.210 (0.810-3.540)	14.10	99
35+35+42+50	2.03	2.03	2.44	2.90	-	9.40 (3.70-10.00)	3.200 (0.810-3.530)	14.05	99
35+35+42+60	1.91	1.91	2.30	3.28	-	9.40 (3.70-10.00)	3.170 (0.810-3.520)	13.92	99
35+35+50+50	1.94	1.94	2.76	2.76	-	9.40 (3.70-10.00)	3.190 (0.810-3.520)	14.01	99
35+42+42+42	2.04	2.45	2.45	2.45	-	9.40 (3.70-10.00)	3.190 (0.810-3.530)	14.01	99
35+42+42+50	1.95	2.34	2.34	2.78	-	9.40 (3.70-10.00)	3.180 (0.810-3.520)	13.97	99
42+42+42+42	2.35	2.35	2.35	2.35	-	9.40 (3.70-10.00)	3.250 (0.810-3.560)	14.27	99
15+15+15+15+15	1.50	1.50	1.50	1.50	1.50	7.50 (3.90-8.40)	1.980 (0.930-3.435)	8.70	99
15+15+15+15+18	1.50	1.50	1.50	1.50	1.80	7.80 (3.90-8.90)	2.262 (0.900-3.550)	9.93	99
15+15+15+15+20	1.48	1.48	1.48	1.48	1.98	7.90 (3.90-9.10)	2.210 (0.930-3.595)	9.71	99
15+15+15+15+22	1.50	1.50	1.50	1.50	2.20	8.20 (3.90-9.50)	2.438 (0.900-3.700)	10.71	99
15+15+15+15+25	1.50	1.50	1.50	1.50	2.50	8.50 (3.90-9.90)	2.570 (0.900-3.810)	11.29	99
15+15+15+15+35	1.50	1.50	1.50	1.50	3.50	9.50 (3.90-10.60)	2.978 (0.900-4.000)	13.08	99
15+15+15+15+50	1.39	1.39	1.39	1.39	4.64	10.20 (3.90-10.60)	3.210 (0.900-3.980)	14.10	99
15+15+15+15+60	1.28	1.28	1.28	1.28	5.10	10.20 (3.90-10.60)	3.180 (0.900-3.970)	13.97	99

MXZ-5D102VA COOLING

Indoor units combination	Cooling capacity (kW)						Outdoor unit power consumption(kW)	Current (A)	Power factor(%)
	Unit A	Unit B	Unit C	Unit D	Unit E	Total			
15+15+15+15+71	1.17	1.17	1.17	1.17	5.53	10.20 (3.90-10.60)	3.160 (0.900-3.960)	13.88	99
15+15+15+18+18	1.50	1.50	1.50	1.80	1.80	8.10 (3.90-9.40)	2.544 (0.870-3.660)	11.17	99
15+15+15+18+20	1.48	1.48	1.48	1.78	1.98	8.20 (3.90-9.60)	2.492 (0.900-3.705)	10.94	99
15+15+15+18+22	1.50	1.50	1.50	1.80	2.20	8.50 (3.90-10.00)	2.720 (0.870-3.810)	11.95	99
15+15+15+18+25	1.50	1.50	1.50	1.80	2.50	8.80 (3.90-10.40)	2.852 (0.870-3.925)	12.53	99
15+15+15+18+35	1.50	1.50	1.50	1.80	3.50	9.80 (3.90-10.70)	3.240 (0.870-4.000)	14.23	99
15+15+15+18+42	1.46	1.46	1.46	1.75	4.08	10.20 (3.90-10.70)	3.370 (0.870-3.990)	14.80	99
15+15+15+18+50	1.35	1.35	1.35	1.62	4.51	10.20 (3.90-10.70)	3.360 (0.870-3.980)	14.76	99
15+15+15+18+60	1.24	1.24	1.24	1.49	4.98	10.20 (3.90-10.70)	3.330 (0.870-3.970)	14.62	99
15+15+15+18+71	1.14	1.14	1.14	1.37	5.40	10.20 (3.90-10.70)	3.310 (0.870-3.960)	14.54	99
15+15+15+20+20	1.46	1.46	1.46	1.95	1.95	8.30 (3.90-9.80)	2.440 (0.930-3.750)	10.72	99
15+15+15+20+22	1.48	1.48	1.48	1.98	2.17	8.60 (3.90-10.20)	2.668 (0.900-3.855)	11.72	99
15+15+15+20+25	1.48	1.48	1.48	1.98	2.47	8.90 (3.90-10.60)	2.800 (0.900-3.970)	12.30	99
15+15+15+20+35	1.49	1.49	1.49	1.98	3.47	9.90 (3.90-10.60)	3.175 (0.900-3.970)	13.94	99
15+15+15+20+42	1.42	1.42	1.42	1.89	3.96	10.10 (3.90-10.60)	3.230 (0.900-3.960)	14.19	99
15+15+15+20+50	1.32	1.32	1.32	1.76	4.39	10.10 (3.90-10.60)	3.220 (0.900-3.950)	14.14	99
15+15+15+20+60	1.21	1.21	1.21	1.62	4.85	10.10 (3.90-10.60)	3.190 (0.900-3.940)	14.01	99
15+15+15+20+71	1.11	1.11	1.11	1.49	5.27	10.10 (3.90-10.60)	3.170 (0.900-3.930)	13.92	99
15+15+15+22+22	1.50	1.50	1.50	2.20	2.20	8.90 (3.90-10.60)	2.896 (0.870-3.960)	12.72	99
15+15+15+22+25	1.50	1.50	1.50	2.20	2.50	9.20 (3.90-10.70)	3.015 (0.870-4.000)	13.24	99
15+15+15+22+42	1.40	1.40	1.40	2.06	3.93	10.20 (3.90-10.70)	3.370 (0.870-3.990)	14.80	99
15+15+15+22+50	1.31	1.31	1.31	1.92	4.36	10.20 (3.90-10.70)	3.360 (0.870-3.980)	14.76	99
15+15+15+22+60	1.20	1.20	1.20	1.77	4.82	10.20 (3.90-10.70)	3.330 (0.870-3.970)	14.62	99
15+15+15+22+71	1.11	1.11	1.11	1.63	5.25	10.20 (3.90-10.70)	3.310 (0.870-3.960)	14.54	99
15+15+15+25+25	1.50	1.50	1.50	2.50	2.50	9.50 (3.90-10.70)	3.128 (0.870-4.000)	13.74	99
15+15+15+25+35	1.46	1.46	1.46	2.43	3.40	10.20 (3.90-10.70)	3.390 (0.870-4.000)	14.89	99
15+15+15+25+42	1.37	1.37	1.37	2.28	3.83	10.20 (3.90-10.70)	3.370 (0.870-3.990)	14.80	99
15+15+15+25+50	1.28	1.28	1.28	2.13	4.25	10.20 (3.90-10.70)	3.360 (0.870-3.980)	14.76	99
15+15+15+25+60	1.18	1.18	1.18	1.96	4.71	10.20 (3.90-10.70)	3.330 (0.870-3.970)	14.62	99
15+15+15+25+71	1.09	1.09	1.09	1.81	5.14	10.20 (3.90-10.70)	3.310 (0.870-3.960)	14.54	99
15+15+15+35+35	1.33	1.33	1.33	3.10	3.10	10.20 (3.90-10.70)	3.390 (0.870-4.000)	14.89	99
15+15+15+35+42	1.25	1.25	1.25	2.93	3.51	10.20 (3.90-10.70)	3.370 (0.870-3.990)	14.80	99
15+15+15+35+50	1.18	1.18	1.18	2.75	3.92	10.20 (3.90-10.70)	3.360 (0.870-3.980)	14.76	99
15+15+15+35+60	1.09	1.09	1.09	2.55	4.37	10.20 (3.90-10.70)	3.330 (0.870-3.970)	14.62	99
15+15+15+35+71	1.01	1.01	1.01	2.36	4.80	10.20 (3.90-10.70)	3.310 (0.870-3.960)	14.54	99
15+15+15+42+42	1.19	1.19	1.19	3.32	3.32	10.20 (3.90-10.70)	3.350 (0.870-3.980)	14.71	99
15+15+15+42+50	1.12	1.12	1.12	3.13	3.72	10.20 (3.90-10.70)	3.340 (0.870-3.970)	14.67	99
15+15+15+42+60	1.04	1.04	1.04	2.91	4.16	10.20 (3.90-10.70)	3.310 (0.870-3.960)	14.54	99
15+15+15+42+71	0.97	0.97	0.97	2.71	4.58	10.20 (3.90-10.70)	3.290 (0.870-3.950)	14.45	99
15+15+15+50+50	1.06	1.06	1.06	3.52	3.52	10.20 (3.90-10.70)	3.330 (0.870-3.960)	14.62	99
15+15+15+50+60	0.99	0.99	0.99	3.29	3.95	10.20 (3.90-10.70)	3.300 (0.870-3.950)	14.49	99

MXZ-5D102VA COOLING

Indoor units combination	Cooling capacity (kW)						Outdoor unit power consumption(kW)	Current (A)	Power factor(%)
	Unit A	Unit B	Unit C	Unit D	Unit E	Total			
15+15+15+50+71	0.92	0.92	0.92	3.07	4.36	10.20 (3.90-10.70)	3.280 (0.870-3.940)	14.40	99
15+15+15+60+60	0.93	0.93	0.93	3.71	3.71	10.20 (3.90-10.70)	3.270 (0.870-3.940)	14.36	99
15+15+18+18+18	1.50	1.50	1.80	1.80	1.80	8.40 (3.90-10.00)	2.826 (0.840-3.775)	12.41	99
15+15+18+18+20	1.48	1.48	1.78	1.78	1.98	8.50 (3.90-10.10)	2.774 (0.870-3.820)	12.18	99
15+15+18+18+22	1.50	1.50	1.80	1.80	2.20	8.80 (3.90-10.50)	3.002 (0.840-3.925)	13.18	99
15+15+18+18+25	1.50	1.50	1.80	1.80	2.50	9.10 (3.90-10.80)	3.128 (0.840-4.000)	13.74	99
15+15+18+18+35	1.50	1.50	1.80	1.80	3.50	10.10 (3.90-10.80)	3.503 (0.840-4.000)	15.38	99
15+15+18+18+42	1.42	1.42	1.70	1.70	3.97	10.20 (3.90-10.80)	3.520 (0.840-3.990)	15.46	99
15+15+18+18+50	1.32	1.32	1.58	1.58	4.40	10.20 (3.90-10.80)	3.510 (0.840-3.980)	15.42	99
15+15+18+18+60	1.21	1.21	1.46	1.46	4.86	10.20 (3.90-10.80)	3.480 (0.840-3.970)	15.28	99
15+15+18+18+71	1.12	1.12	1.34	1.34	5.29	10.20 (3.90-10.80)	3.460 (0.840-3.960)	15.20	99
15+15+18+20+20	1.47	1.47	1.76	1.95	1.95	8.60 (3.90-10.30)	2.722 (0.900-3.865)	11.95	99
15+15+18+20+22	1.48	1.48	1.78	1.98	2.18	8.90 (3.90-10.70)	2.950 (0.870-3.970)	12.96	99
15+15+18+20+25	1.48	1.48	1.78	1.98	2.47	9.20 (3.90-10.70)	3.063 (0.870-3.970)	13.45	99
15+15+18+20+35	1.47	1.47	1.77	1.96	3.43	10.10 (3.90-10.70)	3.400 (0.870-3.970)	14.93	99
15+15+18+20+42	1.38	1.38	1.65	1.84	3.86	10.10 (3.90-10.70)	3.380 (0.870-3.960)	14.84	99
15+15+18+20+50	1.28	1.28	1.54	1.71	4.28	10.10 (3.90-10.70)	3.370 (0.870-3.950)	14.80	99
15+15+18+20+60	1.18	1.18	1.42	1.58	4.73	10.10 (3.90-10.70)	3.340 (0.870-3.940)	14.67	99
15+15+18+20+71	1.09	1.09	1.31	1.45	5.16	10.10 (3.90-10.70)	3.320 (0.870-3.930)	14.58	99
15+15+18+22+22	1.50	1.50	1.80	2.20	2.20	9.20 (3.90-10.80)	3.165 (0.840-4.000)	13.90	99
15+15+18+22+25	1.50	1.50	1.80	2.20	2.50	9.50 (3.90-10.80)	3.278 (0.840-4.000)	14.40	99
15+15+18+22+35	1.46	1.46	1.75	2.14	3.40	10.20 (3.90-10.80)	3.540 (0.840-4.000)	15.55	99
15+15+18+22+42	1.37	1.37	1.64	2.00	3.83	10.20 (3.90-10.80)	3.520 (0.840-3.990)	15.46	99
15+15+18+22+50	1.28	1.28	1.53	1.87	4.25	10.20 (3.90-10.80)	3.510 (0.840-3.980)	15.42	99
15+15+18+22+60	1.18	1.18	1.41	1.73	4.71	10.20 (3.90-10.80)	3.480 (0.840-3.970)	15.28	99
15+15+18+22+71	1.09	1.09	1.30	1.59	5.14	10.20 (3.90-10.80)	3.460 (0.840-3.960)	15.20	99
15+15+18+25+25	1.50	1.50	1.80	2.50	2.50	9.80 (3.90-10.80)	3.390 (0.840-4.000)	14.89	99
15+15+18+25+35	1.42	1.42	1.70	2.36	3.31	10.20 (3.90-10.80)	3.540 (0.840-4.000)	15.55	99
15+15+18+25+42	1.33	1.33	1.60	2.22	3.73	10.20 (3.90-10.80)	3.520 (0.840-3.990)	15.46	99
15+15+18+25+50	1.24	1.24	1.49	2.07	4.15	10.20 (3.90-10.80)	3.510 (0.840-3.980)	15.42	99
15+15+18+25+60	1.15	1.15	1.38	1.92	4.60	10.20 (3.90-10.80)	3.480 (0.840-3.970)	15.28	99
15+15+18+25+71	1.06	1.06	1.28	1.77	5.03	10.20 (3.90-10.80)	3.460 (0.840-3.960)	15.20	99
15+15+18+35+35	1.30	1.30	1.56	3.03	3.03	10.20 (3.90-10.80)	3.540 (0.840-4.000)	15.55	99
15+15+18+35+42	1.22	1.22	1.47	2.86	3.43	10.20 (3.90-10.80)	3.520 (0.840-3.990)	15.46	99
15+15+18+35+50	1.15	1.15	1.38	2.68	3.83	10.20 (3.90-10.80)	3.510 (0.840-3.980)	15.42	99
15+15+18+35+60	1.07	1.07	1.28	2.50	4.28	10.20 (3.90-10.80)	3.480 (0.840-3.970)	15.28	99
15+15+18+35+71	0.99	0.99	1.19	2.32	4.70	10.20 (3.90-10.80)	3.460 (0.840-3.960)	15.20	99
15+15+18+42+42	1.16	1.16	1.39	3.25	3.25	10.20 (3.90-10.80)	3.500 (0.840-3.980)	15.37	99
15+15+18+42+50	1.09	1.09	1.31	3.06	3.64	10.20 (3.90-10.80)	3.490 (0.840-3.970)	15.33	99
15+15+18+42+60	1.02	1.02	1.22	2.86	4.08	10.20 (3.90-10.80)	3.460 (0.840-3.960)	15.20	99
15+15+18+42+71	0.95	0.95	1.14	2.66	4.50	10.20 (3.90-10.80)	3.440 (0.840-3.950)	15.11	99

MXZ-5D102VA COOLING

Indoor units combination	Cooling capacity (kW)					Outdoor unit power consumption(kW)	Current (A)	Power factor(%)	
	Unit A	Unit B	Unit C	Unit D	Unit E				Total
15+15+18+50+50	1.03	1.03	1.24	3.45	3.45	10.20 (3.90-10.80)	3.480 (0.840-3.960)	15.28	99
15+15+18+50+60	0.97	0.97	1.16	3.23	3.87	10.20 (3.90-10.80)	3.450 (0.840-3.950)	15.15	99
15+15+18+50+71	0.91	0.91	1.09	3.02	4.29	10.20 (3.90-10.80)	3.430 (0.840-3.940)	15.06	99
15+15+18+60+60	0.91	0.91	1.09	3.64	3.64	10.20 (3.90-10.80)	3.420 (0.840-3.940)	15.02	99
15+15+20+20+20	1.45	1.45	1.93	1.93	1.93	8.70 (3.90-10.50)	2.670 (0.930-3.910)	11.73	99
15+15+20+20+22	1.47	1.47	1.96	1.96	2.15	9.00 (3.90-10.60)	2.885 (0.900-3.940)	12.67	99
15+15+20+20+25	1.47	1.47	1.96	1.96	2.45	9.30 (3.90-10.60)	2.998 (0.900-3.940)	13.17	99
15+15+20+20+35	1.43	1.43	1.90	1.90	3.33	10.00 (3.90-10.60)	3.260 (0.900-3.940)	14.32	99
15+15+20+20+42	1.34	1.34	1.79	1.79	3.75	10.00 (3.90-10.60)	3.240 (0.900-3.930)	14.23	99
15+15+20+20+50	1.25	1.25	1.67	1.67	4.17	10.00 (3.90-10.60)	3.230 (0.900-3.920)	14.19	99
15+15+20+20+60	1.15	1.15	1.54	1.54	4.62	10.00 (3.90-10.60)	3.200 (0.900-3.910)	14.05	99
15+15+20+20+71	1.06	1.06	1.42	1.42	5.04	10.00 (3.90-10.60)	3.180 (0.900-3.900)	13.97	99
15+15+20+22+22	1.48	1.48	1.98	2.18	2.18	9.30 (3.90-10.70)	3.100 (0.870-3.970)	13.61	99
15+15+20+22+25	1.48	1.48	1.98	2.18	2.47	9.60 (3.90-10.70)	3.213 (0.870-3.970)	14.11	99
15+15+20+22+35	1.42	1.42	1.89	2.08	3.30	10.10 (3.90-10.70)	3.400 (0.870-3.970)	14.93	99
15+15+20+22+42	1.33	1.33	1.77	1.95	3.72	10.10 (3.90-10.70)	3.380 (0.870-3.960)	14.84	99
15+15+20+22+50	1.24	1.24	1.66	1.82	4.14	10.10 (3.90-10.70)	3.370 (0.870-3.950)	14.80	99
15+15+20+22+60	1.15	1.15	1.53	1.68	4.59	10.10 (3.90-10.70)	3.340 (0.870-3.940)	14.67	99
15+15+20+22+71	1.06	1.06	1.41	1.55	5.01	10.10 (3.90-10.70)	3.320 (0.870-3.930)	14.58	99
15+15+20+25+25	1.49	1.49	1.98	2.48	2.48	9.90 (3.90-10.70)	3.325 (0.870-3.970)	14.60	99
15+15+20+25+35	1.38	1.38	1.84	2.30	3.21	10.10 (3.90-10.70)	3.400 (0.870-3.970)	14.93	99
15+15+20+25+42	1.29	1.29	1.73	2.16	3.63	10.10 (3.90-10.70)	3.380 (0.870-3.960)	14.84	99
15+15+20+25+50	1.21	1.21	1.62	2.02	4.04	10.10 (3.90-10.70)	3.370 (0.870-3.950)	14.80	99
15+15+20+25+60	1.12	1.12	1.50	1.87	4.49	10.10 (3.90-10.70)	3.340 (0.870-3.940)	14.67	99
15+15+20+25+71	1.04	1.04	1.38	1.73	4.91	10.10 (3.90-10.70)	3.320 (0.870-3.930)	14.58	99
15+15+20+35+35	1.26	1.26	1.68	2.95	2.95	10.10 (3.90-10.70)	3.400 (0.870-3.970)	14.93	99
15+15+20+35+42	1.19	1.19	1.59	2.78	3.34	10.10 (3.90-10.70)	3.380 (0.870-3.960)	14.84	99
15+15+20+35+50	1.12	1.12	1.50	2.62	3.74	10.10 (3.90-10.70)	3.370 (0.870-3.950)	14.80	99
15+15+20+35+60	1.04	1.04	1.39	2.44	4.18	10.10 (3.90-10.70)	3.340 (0.870-3.940)	14.67	99
15+15+20+35+71	0.97	0.97	1.29	2.27	4.60	10.10 (3.90-10.70)	3.320 (0.870-3.930)	14.58	99
15+15+20+42+42	1.13	1.13	1.51	3.17	3.17	10.10 (3.90-10.70)	3.360 (0.870-3.950)	14.76	99
15+15+20+42+50	1.07	1.07	1.42	2.99	3.56	10.10 (3.90-10.70)	3.350 (0.870-3.940)	14.71	99
15+15+20+42+60	1.00	1.00	1.33	2.79	3.99	10.10 (3.90-10.70)	3.320 (0.870-3.930)	14.58	99
15+15+20+42+71	0.93	0.93	1.24	2.60	4.40	10.10 (3.90-10.70)	3.300 (0.870-3.920)	14.49	99
15+15+20+50+50	1.01	1.01	1.35	3.37	3.37	10.10 (3.90-10.70)	3.340 (0.870-3.930)	14.67	99
15+15+20+50+60	0.95	0.95	1.26	3.16	3.79	10.10 (3.90-10.70)	3.310 (0.870-3.920)	14.54	99
15+15+20+50+71	0.89	0.89	1.18	2.95	4.19	10.10 (3.90-10.70)	3.290 (0.870-3.910)	14.45	99
15+15+20+60+60	0.89	0.89	1.19	3.56	3.56	10.10 (3.90-10.70)	3.280 (0.870-3.910)	14.40	99
15+15+22+22+22	1.50	1.50	2.20	2.20	2.20	9.60 (3.90-10.80)	3.315 (0.840-4.000)	14.56	99
15+15+22+22+25	1.50	1.50	2.20	2.20	2.50	9.90 (3.90-10.80)	3.428 (0.840-4.000)	15.05	99
15+15+22+22+35	1.40	1.40	2.06	2.06	3.28	10.20 (3.90-10.80)	3.540 (0.840-4.000)	15.55	99

MXZ-5D102VA COOLING

Indoor units combination	Cooling capacity (kW)						Outdoor unit power consumption(kW)	Current (A)	Power factor(%)
	Unit A	Unit B	Unit C	Unit D	Unit E	Total			
15+15+22+22+42	1.32	1.32	1.93	1.93	3.69	10.20 (3.90-10.80)	3.520 (0.840-3.990)	15.46	99
15+15+22+22+50	1.23	1.23	1.81	1.81	4.11	10.20 (3.90-10.80)	3.510 (0.840-3.980)	15.42	99
15+15+22+22+60	1.14	1.14	1.67	1.67	4.57	10.20 (3.90-10.80)	3.480 (0.840-3.970)	15.28	99
15+15+22+22+71	1.06	1.06	1.55	1.55	4.99	10.20 (3.90-10.80)	3.460 (0.840-3.960)	15.20	99
15+15+22+25+35	1.37	1.37	2.00	2.28	3.19	10.20 (3.90-10.80)	3.540 (0.840-4.000)	15.55	99
15+15+22+25+42	1.29	1.29	1.89	2.14	3.60	10.20 (3.90-10.80)	3.520 (0.840-3.990)	15.46	99
15+15+22+25+50	1.20	1.20	1.77	2.01	4.02	10.20 (3.90-10.80)	3.510 (0.840-3.980)	15.42	99
15+15+22+25+60	1.12	1.12	1.64	1.86	4.47	10.20 (3.90-10.80)	3.480 (0.840-3.970)	15.28	99
15+15+22+25+71	1.03	1.03	1.52	1.72	4.89	10.20 (3.90-10.80)	3.460 (0.840-3.960)	15.20	99
15+15+22+35+35	1.25	1.25	1.84	2.93	2.93	10.20 (3.90-10.80)	3.540 (0.840-4.000)	15.55	99
15+15+22+35+42	1.19	1.19	1.74	2.77	3.32	10.20 (3.90-10.80)	3.520 (0.840-3.990)	15.46	99
15+15+22+35+50	1.12	1.12	1.64	2.61	3.72	10.20 (3.90-10.80)	3.510 (0.840-3.980)	15.42	99
15+15+22+35+60	1.04	1.04	1.53	2.43	4.16	10.20 (3.90-10.80)	3.480 (0.840-3.970)	15.28	99
15+15+22+35+71	0.97	0.97	1.42	2.26	4.58	10.20 (3.90-10.80)	3.460 (0.840-3.960)	15.20	99
15+15+22+42+42	1.13	1.13	1.65	3.15	3.15	10.20 (3.90-10.80)	3.500 (0.840-3.980)	15.37	99
15+15+22+42+50	1.06	1.06	1.56	2.98	3.54	10.20 (3.90-10.80)	3.490 (0.840-3.970)	15.33	99
15+15+22+42+60	0.99	0.99	1.46	2.78	3.97	10.20 (3.90-10.80)	3.460 (0.840-3.960)	15.20	99
15+15+22+42+71	0.93	0.93	1.36	2.60	4.39	10.20 (3.90-10.80)	3.440 (0.840-3.950)	15.11	99
15+15+22+50+50	1.01	1.01	1.48	3.36	3.36	10.20 (3.90-10.80)	3.480 (0.840-3.960)	15.28	99
15+15+22+50+60	0.94	0.94	1.39	3.15	3.78	10.20 (3.90-10.80)	3.450 (0.840-3.950)	15.15	99
15+15+22+60+60	0.89	0.89	1.30	3.56	3.56	10.20 (3.90-10.80)	3.420 (0.840-3.940)	15.02	99
15+15+25+25+25	1.46	1.46	2.43	2.43	2.43	10.20 (3.90-10.80)	3.540 (0.840-4.000)	15.55	99
15+15+25+25+35	1.33	1.33	2.22	2.22	3.10	10.20 (3.90-10.80)	3.540 (0.840-4.000)	15.55	99
15+15+25+25+42	1.25	1.25	2.09	2.09	3.51	10.20 (3.90-10.80)	3.520 (0.840-3.990)	15.46	99
15+15+25+25+50	1.18	1.18	1.96	1.96	3.92	10.20 (3.90-10.80)	3.510 (0.840-3.980)	15.42	99
15+15+25+25+60	1.09	1.09	1.82	1.82	4.37	10.20 (3.90-10.80)	3.480 (0.840-3.970)	15.28	99
15+15+25+25+71	1.01	1.01	1.69	1.69	4.80	10.20 (3.90-10.80)	3.460 (0.840-3.960)	15.20	99
15+15+25+35+35	1.22	1.22	2.04	2.86	2.86	10.20 (3.90-10.80)	3.540 (0.840-4.000)	15.55	99
15+15+25+35+42	1.16	1.16	1.93	2.70	3.25	10.20 (3.90-10.80)	3.520 (0.840-3.990)	15.46	99
15+15+25+35+50	1.09	1.09	1.82	2.55	3.64	10.20 (3.90-10.80)	3.510 (0.840-3.980)	15.42	99
15+15+25+35+60	1.02	1.02	1.70	2.38	4.08	10.20 (3.90-10.80)	3.480 (0.840-3.970)	15.28	99
15+15+25+35+71	0.95	0.95	1.58	2.22	4.50	10.20 (3.90-10.80)	3.460 (0.840-3.960)	15.20	99
15+15+25+42+42	1.10	1.10	1.83	3.08	3.08	10.20 (3.90-10.80)	3.500 (0.840-3.980)	15.37	99
15+15+25+42+50	1.04	1.04	1.73	2.91	3.47	10.20 (3.90-10.80)	3.490 (0.840-3.970)	15.33	99
15+15+25+42+60	0.97	0.97	1.62	2.73	3.90	10.20 (3.90-10.80)	3.460 (0.840-3.960)	15.20	99
15+15+25+42+71	0.91	0.91	1.52	2.55	4.31	10.20 (3.90-10.80)	3.440 (0.840-3.950)	15.11	99
15+15+25+50+50	0.99	0.99	1.65	3.29	3.29	10.20 (3.90-10.80)	3.480 (0.840-3.960)	15.28	99
15+15+25+50+60	0.93	0.93	1.55	3.09	3.71	10.20 (3.90-10.80)	3.450 (0.840-3.950)	15.15	99
15+15+35+35+35	1.13	1.13	2.64	2.64	2.64	10.20 (3.90-10.80)	3.540 (0.840-4.000)	15.55	99
15+15+35+35+42	1.08	1.08	2.51	2.51	3.02	10.20 (3.90-10.80)	3.520 (0.840-3.990)	15.46	99
15+15+35+35+50	1.02	1.02	2.38	2.38	3.40	10.20 (3.90-10.80)	3.510 (0.840-3.980)	15.42	99

MXZ-5D102VA COOLING

Indoor units combination	Cooling capacity (kW)						Outdoor unit power consumption(kW)	Current (A)	Power factor(%)
	Unit A	Unit B	Unit C	Unit D	Unit E	Total			
15+15+35+35+60	0.96	0.96	2.23	2.23	3.83	10.20 (3.90-10.80)	3.480 (0.840-3.970)	15.28	99
15+15+35+35+71	0.89	0.89	2.09	2.09	4.24	10.20 (3.90-10.80)	3.460 (0.840-3.960)	15.20	99
15+15+35+42+42	1.03	1.03	2.40	2.88	2.88	10.20 (3.90-10.80)	3.500 (0.840-3.980)	15.37	99
15+15+35+42+50	0.97	0.97	2.27	2.73	3.25	10.20 (3.90-10.80)	3.490 (0.840-3.970)	15.33	99
15+15+35+42+60	0.92	0.92	2.14	2.57	3.66	10.20 (3.90-10.80)	3.460 (0.840-3.960)	15.20	99
15+15+35+50+50	0.93	0.93	2.16	3.09	3.09	10.20 (3.90-10.80)	3.480 (0.840-3.960)	15.28	99
15+15+42+42+42	0.98	0.98	2.75	2.75	2.75	10.20 (3.90-10.80)	3.480 (0.840-3.970)	15.28	99
15+15+42+42+50	0.93	0.93	2.61	2.61	3.11	10.20 (3.90-10.80)	3.470 (0.840-3.960)	15.24	99
15+15+42+50+50	0.89	0.89	2.49	2.97	2.97	10.20 (3.90-10.80)	3.460 (0.840-3.950)	15.20	99
15+18+18+18+18	1.50	1.80	1.80	1.80	1.80	8.70 (3.90-10.50)	3.108 (0.810-3.885)	13.65	99
15+18+18+18+20	1.48	1.78	1.78	1.78	1.98	8.80 (3.90-10.70)	3.056 (0.840-3.930)	13.42	99
15+18+18+18+22	1.50	1.80	1.80	1.80	2.20	9.10 (3.90-10.90)	3.278 (0.810-4.000)	14.40	99
15+18+18+18+25	1.50	1.80	1.80	1.80	2.50	9.40 (3.90-10.90)	3.390 (0.810-4.000)	14.89	99
15+18+18+18+35	1.47	1.77	1.77	1.77	3.43	10.20 (3.90-10.90)	3.690 (0.810-4.000)	16.21	99
15+18+18+18+42	1.38	1.65	1.65	1.65	3.86	10.20 (3.90-10.90)	3.670 (0.810-3.990)	16.12	99
15+18+18+18+50	1.29	1.54	1.54	1.54	4.29	10.20 (3.90-10.90)	3.660 (0.810-3.980)	16.07	99
15+18+18+18+60	1.19	1.42	1.42	1.42	4.74	10.20 (3.90-10.90)	3.630 (0.810-3.970)	15.94	99
15+18+18+18+71	1.09	1.31	1.31	1.31	5.17	10.20 (3.90-10.90)	3.610 (0.810-3.960)	15.85	99
15+18+18+20+20	1.47	1.76	1.76	1.96	1.96	8.90 (3.90-10.70)	2.998 (0.870-3.940)	13.17	99
15+18+18+20+22	1.48	1.78	1.78	1.98	2.18	9.20 (3.90-10.80)	3.213 (0.840-3.970)	14.11	99
15+18+18+20+25	1.48	1.78	1.78	1.98	2.47	9.50 (3.90-10.80)	3.325 (0.840-3.970)	14.60	99
15+18+18+20+35	1.43	1.72	1.72	1.91	3.33	10.10 (3.90-10.80)	3.550 (0.840-3.970)	15.59	99
15+18+18+20+42	1.34	1.61	1.61	1.79	3.75	10.10 (3.90-10.80)	3.530 (0.840-3.960)	15.50	99
15+18+18+20+50	1.25	1.50	1.50	1.67	4.17	10.10 (3.90-10.80)	3.520 (0.840-3.950)	15.46	99
15+18+18+20+60	1.16	1.39	1.39	1.54	4.63	10.10 (3.90-10.80)	3.490 (0.840-3.940)	15.33	99
15+18+18+20+71	1.07	1.28	1.28	1.42	5.05	10.10 (3.90-10.80)	3.470 (0.840-3.930)	15.24	99
15+18+18+22+22	1.50	1.80	1.80	2.20	2.20	9.50 (3.90-10.90)	3.428 (0.810-4.000)	15.05	99
15+18+18+22+25	1.50	1.80	1.80	2.20	2.50	9.80 (3.90-10.90)	3.540 (0.810-4.000)	15.55	99
15+18+18+22+35	1.42	1.70	1.70	2.08	3.31	10.20 (3.90-10.90)	3.690 (0.810-4.000)	16.21	99
15+18+18+22+42	1.33	1.60	1.60	1.95	3.73	10.20 (3.90-10.90)	3.670 (0.810-3.990)	16.12	99
15+18+18+22+50	1.24	1.49	1.49	1.82	4.15	10.20 (3.90-10.90)	3.660 (0.810-3.980)	16.07	99
15+18+18+22+60	1.15	1.38	1.38	1.69	4.60	10.20 (3.90-10.90)	3.630 (0.810-3.970)	15.94	99
15+18+18+22+71	1.06	1.28	1.28	1.56	5.03	10.20 (3.90-10.90)	3.610 (0.810-3.960)	15.85	99
15+18+18+25+25	1.50	1.80	1.80	2.50	2.50	10.10 (3.90-10.90)	3.653 (0.810-4.000)	16.04	99
15+18+18+25+35	1.38	1.65	1.65	2.30	3.22	10.20 (3.90-10.90)	3.690 (0.810-4.000)	16.21	99
15+18+18+25+42	1.30	1.56	1.56	2.16	3.63	10.20 (3.90-10.90)	3.670 (0.810-3.990)	16.12	99
15+18+18+25+50	1.21	1.46	1.46	2.02	4.05	10.20 (3.90-10.90)	3.660 (0.810-3.980)	16.07	99
15+18+18+25+60	1.13	1.35	1.35	1.88	4.50	10.20 (3.90-10.90)	3.630 (0.810-3.970)	15.94	99
15+18+18+25+71	1.04	1.25	1.25	1.73	4.93	10.20 (3.90-10.90)	3.610 (0.810-3.960)	15.85	99
15+18+18+35+35	1.26	1.52	1.52	2.95	2.95	10.20 (3.90-10.90)	3.690 (0.810-4.000)	16.21	99
15+18+18+35+42	1.20	1.43	1.43	2.79	3.35	10.20 (3.90-10.90)	3.670 (0.810-3.990)	16.12	99

MXZ-5D102VA COOLING

Indoor units combination	Cooling capacity (kW)						Outdoor unit power consumption(kW)	Current (A)	Power factor(%)
	Unit A	Unit B	Unit C	Unit D	Unit E	Total			
15+18+18+35+50	1.13	1.35	1.35	2.63	3.75	10.20 (3.90-10.90)	3.660 (0.810-3.980)	16.07	99
15+18+18+35+60	1.05	1.26	1.26	2.45	4.19	10.20 (3.90-10.90)	3.630 (0.810-3.970)	15.94	99
15+18+18+35+71	0.97	1.17	1.17	2.27	4.61	10.20 (3.90-10.90)	3.610 (0.810-3.960)	15.85	99
15+18+18+42+42	1.13	1.36	1.36	3.17	3.17	10.20 (3.90-10.90)	3.650 (0.810-3.980)	16.03	99
15+18+18+42+50	1.07	1.28	1.28	3.00	3.57	10.20 (3.90-10.90)	3.640 (0.810-3.970)	15.99	99
15+18+18+42+60	1.00	1.20	1.20	2.80	4.00	10.20 (3.90-10.90)	3.610 (0.810-3.960)	15.85	99
15+18+18+42+71	0.93	1.12	1.12	2.61	4.42	10.20 (3.90-10.90)	3.590 (0.810-3.950)	15.77	99
15+18+18+50+50	1.01	1.22	1.22	3.38	3.38	10.20 (3.90-10.90)	3.630 (0.810-3.960)	15.94	99
15+18+18+50+60	0.95	1.14	1.14	3.17	3.80	10.20 (3.90-10.90)	3.600 (0.810-3.950)	15.81	99
15+18+18+50+71	0.89	1.07	1.07	2.97	4.21	10.20 (3.90-10.90)	3.580 (0.810-3.940)	15.72	99
15+18+18+60+60	0.89	1.07	1.07	3.58	3.58	10.20 (3.90-10.90)	3.570 (0.810-3.940)	15.68	99
15+18+20+20+20	1.45	1.74	1.94	1.94	1.94	9.00 (3.90-10.60)	2.933 (0.900-3.910)	12.88	99
15+18+20+20+22	1.47	1.76	1.96	1.96	2.15	9.30 (3.90-10.70)	3.148 (0.870-3.940)	13.83	99
15+18+20+20+25	1.47	1.76	1.96	1.96	2.45	9.60 (3.90-10.70)	3.260 (0.870-3.940)	14.32	99
15+18+20+20+35	1.39	1.67	1.85	1.85	3.24	10.00 (3.90-10.70)	3.410 (0.870-3.940)	14.98	99
15+18+20+20+42	1.30	1.57	1.74	1.74	3.65	10.00 (3.90-10.70)	3.390 (0.870-3.930)	14.89	99
15+18+20+20+50	1.22	1.46	1.63	1.63	4.07	10.00 (3.90-10.70)	3.380 (0.870-3.920)	14.84	99
15+18+20+20+60	1.13	1.35	1.50	1.50	4.51	10.00 (3.90-10.70)	3.350 (0.870-3.910)	14.71	99
15+18+20+20+71	1.04	1.25	1.39	1.39	4.93	10.00 (3.90-10.70)	3.330 (0.870-3.900)	14.62	99
15+18+20+22+22	1.48	1.78	1.98	2.18	2.18	9.60 (3.90-10.80)	3.363 (0.840-3.970)	14.77	99
15+18+20+22+25	1.49	1.78	1.98	2.18	2.48	9.90 (3.90-10.80)	3.475 (0.840-3.970)	15.26	99
15+18+20+22+35	1.38	1.65	1.84	2.02	3.21	10.10 (3.90-10.80)	3.550 (0.840-3.970)	15.59	99
15+18+20+22+42	1.29	1.55	1.73	1.90	3.63	10.10 (3.90-10.80)	3.530 (0.840-3.960)	15.50	99
15+18+20+22+50	1.21	1.45	1.62	1.78	4.04	10.10 (3.90-10.80)	3.520 (0.840-3.950)	15.46	99
15+18+20+22+60	1.12	1.35	1.50	1.65	4.49	10.10 (3.90-10.80)	3.490 (0.840-3.940)	15.33	99
15+18+20+22+71	1.04	1.25	1.38	1.52	4.91	10.10 (3.90-10.80)	3.470 (0.840-3.930)	15.24	99
15+18+20+25+25	1.47	1.77	1.96	2.45	2.45	10.10 (3.90-10.80)	3.550 (0.840-3.970)	15.59	99
15+18+20+25+35	1.34	1.61	1.79	2.23	3.13	10.10 (3.90-10.80)	3.550 (0.840-3.970)	15.59	99
15+18+20+25+42	1.26	1.52	1.68	2.10	3.54	10.10 (3.90-10.80)	3.530 (0.840-3.960)	15.50	99
15+18+20+25+50	1.18	1.42	1.58	1.97	3.95	10.10 (3.90-10.80)	3.520 (0.840-3.950)	15.46	99
15+18+20+25+60	1.10	1.32	1.46	1.83	4.39	10.10 (3.90-10.80)	3.490 (0.840-3.940)	15.33	99
15+18+20+25+71	1.02	1.22	1.36	1.69	4.81	10.10 (3.90-10.80)	3.470 (0.840-3.930)	15.24	99
15+18+20+35+35	1.23	1.48	1.64	2.87	2.87	10.10 (3.90-10.80)	3.550 (0.840-3.970)	15.59	99
15+18+20+35+42	1.17	1.40	1.55	2.72	3.26	10.10 (3.90-10.80)	3.530 (0.840-3.960)	15.50	99
15+18+20+35+50	1.10	1.32	1.46	2.56	3.66	10.10 (3.90-10.80)	3.520 (0.840-3.950)	15.46	99
15+18+20+35+60	1.02	1.23	1.36	2.39	4.09	10.10 (3.90-10.80)	3.490 (0.840-3.940)	15.33	99
15+18+20+35+71	0.95	1.14	1.27	2.22	4.51	10.10 (3.90-10.80)	3.470 (0.840-3.930)	15.24	99
15+18+20+42+42	1.11	1.33	1.47	3.10	3.10	10.10 (3.90-10.80)	3.510 (0.840-3.950)	15.42	99
15+18+20+42+50	1.04	1.25	1.39	2.93	3.48	10.10 (3.90-10.80)	3.500 (0.840-3.940)	15.37	99
15+18+20+42+60	0.98	1.17	1.30	2.74	3.91	10.10 (3.90-10.80)	3.470 (0.840-3.930)	15.24	99
15+18+20+42+71	0.91	1.10	1.22	2.56	4.32	10.10 (3.90-10.80)	3.450 (0.840-3.920)	15.15	99

MXZ-5D102VA COOLING

Indoor units combination	Cooling capacity (kW)					Outdoor unit power consumption(kW)	Current (A)	Power factor(%)	
	Unit A	Unit B	Unit C	Unit D	Unit E				Total
15+18+20+50+50	0.99	1.19	1.32	3.30	3.30	10.10 (3.90-10.80)	3.490 (0.840-3.930)	15.33	99
15+18+20+50+60	0.93	1.12	1.24	3.10	3.72	10.10 (3.90-10.80)	3.460 (0.840-3.920)	15.20	99
15+18+22+22+22	1.50	1.80	2.20	2.20	2.20	9.90 (3.90-10.90)	3.578 (0.810-4.000)	15.71	99
15+18+22+22+35	1.37	1.64	2.00	2.00	3.19	10.20 (3.90-10.90)	3.690 (0.810-4.000)	16.21	99
15+18+22+22+42	1.29	1.54	1.89	1.89	3.60	10.20 (3.90-10.90)	3.670 (0.810-3.990)	16.12	99
15+18+22+22+50	1.20	1.45	1.77	1.77	4.02	10.20 (3.90-10.90)	3.660 (0.810-3.980)	16.07	99
15+18+22+22+60	1.12	1.34	1.64	1.64	4.47	10.20 (3.90-10.90)	3.630 (0.810-3.970)	15.94	99
15+18+22+22+71	1.03	1.24	1.52	1.52	4.89	10.20 (3.90-10.90)	3.610 (0.810-3.960)	15.85	99
15+18+22+25+25	1.46	1.75	2.14	2.43	2.43	10.20 (3.90-10.90)	3.690 (0.810-4.000)	16.21	99
15+18+22+25+35	1.33	1.60	1.95	2.22	3.10	10.20 (3.90-10.90)	3.690 (0.810-4.000)	16.21	99
15+18+22+25+42	1.25	1.50	1.84	2.09	3.51	10.20 (3.90-10.90)	3.670 (0.810-3.990)	16.12	99
15+18+22+25+50	1.18	1.41	1.73	1.96	3.92	10.20 (3.90-10.90)	3.660 (0.810-3.980)	16.07	99
15+18+22+25+60	1.09	1.31	1.60	1.82	4.37	10.20 (3.90-10.90)	3.630 (0.810-3.970)	15.94	99
15+18+22+25+71	1.01	1.22	1.49	1.69	4.80	10.20 (3.90-10.90)	3.610 (0.810-3.960)	15.85	99
15+18+22+35+35	1.22	1.47	1.80	2.86	2.86	10.20 (3.90-10.90)	3.690 (0.810-4.000)	16.21	99
15+18+22+35+42	1.16	1.39	1.70	2.70	3.25	10.20 (3.90-10.90)	3.670 (0.810-3.990)	16.12	99
15+18+22+35+50	1.09	1.31	1.60	2.55	3.64	10.20 (3.90-10.90)	3.660 (0.810-3.980)	16.07	99
15+18+22+35+60	1.02	1.22	1.50	2.38	4.08	10.20 (3.90-10.90)	3.630 (0.810-3.970)	15.94	99
15+18+22+35+71	0.95	1.14	1.39	2.22	4.50	10.20 (3.90-10.90)	3.610 (0.810-3.960)	15.85	99
15+18+22+42+42	1.10	1.32	1.61	3.08	3.08	10.20 (3.90-10.90)	3.650 (0.810-3.980)	16.03	99
15+18+22+42+50	1.04	1.25	1.53	2.91	3.47	10.20 (3.90-10.90)	3.640 (0.810-3.970)	15.99	99
15+18+22+42+60	0.97	1.17	1.43	2.73	3.90	10.20 (3.90-10.90)	3.610 (0.810-3.960)	15.85	99
15+18+22+42+71	0.91	1.09	1.34	2.55	4.31	10.20 (3.90-10.90)	3.590 (0.810-3.950)	15.77	99
15+18+22+50+50	0.99	1.18	1.45	3.29	3.29	10.20 (3.90-10.90)	3.630 (0.810-3.960)	15.94	99
15+18+22+50+60	0.93	1.11	1.36	3.09	3.71	10.20 (3.90-10.90)	3.600 (0.810-3.950)	15.81	99
15+18+25+25+25	1.42	1.70	2.36	2.36	2.36	10.20 (3.90-10.90)	3.690 (0.810-4.000)	16.21	99
15+18+25+25+35	1.30	1.56	2.16	2.16	3.03	10.20 (3.90-10.90)	3.690 (0.810-4.000)	16.21	99
15+18+25+25+42	1.22	1.47	2.04	2.04	3.43	10.20 (3.90-10.90)	3.670 (0.810-3.990)	16.12	99
15+18+25+25+50	1.15	1.38	1.92	1.92	3.83	10.20 (3.90-10.90)	3.660 (0.810-3.980)	16.07	99
15+18+25+25+60	1.07	1.28	1.78	1.78	4.28	10.20 (3.90-10.90)	3.630 (0.810-3.970)	15.94	99
15+18+25+25+71	0.99	1.19	1.66	1.66	4.70	10.20 (3.90-10.90)	3.610 (0.810-3.960)	15.85	99
15+18+25+35+35	1.20	1.43	1.99	2.79	2.79	10.20 (3.90-10.90)	3.690 (0.810-4.000)	16.21	99
15+18+25+35+42	1.13	1.36	1.89	2.64	3.17	10.20 (3.90-10.90)	3.670 (0.810-3.990)	16.12	99
15+18+25+35+50	1.07	1.28	1.78	2.50	3.57	10.20 (3.90-10.90)	3.660 (0.810-3.980)	16.07	99
15+18+25+35+60	1.00	1.20	1.67	2.33	4.00	10.20 (3.90-10.90)	3.630 (0.810-3.970)	15.94	99
15+18+25+35+71	0.93	1.12	1.55	2.18	4.42	10.20 (3.90-10.90)	3.610 (0.810-3.960)	15.85	99
15+18+25+42+42	1.08	1.29	1.80	3.02	3.02	10.20 (3.90-10.90)	3.650 (0.810-3.980)	16.03	99
15+18+25+42+50	1.02	1.22	1.70	2.86	3.40	10.20 (3.90-10.90)	3.640 (0.810-3.970)	15.99	99
15+18+25+42+60	0.96	1.15	1.59	2.68	3.83	10.20 (3.90-10.90)	3.610 (0.810-3.960)	15.85	99
15+18+25+42+71	0.89	1.07	1.49	2.51	4.24	10.20 (3.90-10.90)	3.590 (0.810-3.950)	15.77	99
15+18+25+50+50	0.97	1.16	1.61	3.23	3.23	10.20 (3.90-10.90)	3.630 (0.810-3.960)	15.94	99

MXZ-5D102VA COOLING

Indoor units combination	Cooling capacity (kW)						Outdoor unit power consumption(kW)	Current (A)	Power factor(%)
	Unit A	Unit B	Unit C	Unit D	Unit E	Total			
15+18+25+50+60	0.91	1.09	1.52	3.04	3.64	10.20 (3.90-10.90)	3.600 (0.810-3.950)	15.81	99
15+18+35+35+35	1.11	1.33	2.59	2.59	2.59	10.20 (3.90-10.90)	3.690 (0.810-4.000)	16.21	99
15+18+35+35+42	1.06	1.27	2.46	2.46	2.95	10.20 (3.90-10.90)	3.670 (0.810-3.990)	16.12	99
15+18+35+35+50	1.00	1.20	2.33	2.33	3.33	10.20 (3.90-10.90)	3.660 (0.810-3.980)	16.07	99
15+18+35+35+60	0.94	1.13	2.19	2.19	3.75	10.20 (3.90-10.90)	3.630 (0.810-3.970)	15.94	99
15+18+35+42+42	1.01	1.21	2.35	2.82	2.82	10.20 (3.90-10.90)	3.650 (0.810-3.980)	16.03	99
15+18+35+42+50	0.96	1.15	2.23	2.68	3.19	10.20 (3.90-10.90)	3.640 (0.810-3.970)	15.99	99
15+18+35+42+60	0.90	1.08	2.10	2.52	3.60	10.20 (3.90-10.90)	3.610 (0.810-3.960)	15.85	99
15+18+35+50+50	0.91	1.09	2.13	3.04	3.04	10.20 (3.90-10.90)	3.630 (0.810-3.960)	15.94	99
15+18+42+42+42	0.96	1.15	2.69	2.69	2.69	10.20 (3.90-10.90)	3.630 (0.810-3.970)	15.94	99
15+18+42+42+50	0.92	1.10	2.57	2.57	3.05	10.20 (3.90-10.90)	3.620 (0.810-3.960)	15.90	99
15+20+20+20+20	1.44	1.92	1.92	1.92	1.92	9.10 (3.90-10.50)	2.868 (0.930-3.880)	12.60	99
15+20+20+20+22	1.45	1.94	1.94	1.94	2.13	9.40 (3.90-10.60)	3.083 (0.900-3.910)	13.54	99
15+20+20+20+25	1.46	1.94	1.94	1.94	2.43	9.70 (3.90-10.60)	3.195 (0.900-3.910)	14.03	99
15+20+20+20+35	1.35	1.80	1.80	1.80	3.15	9.90 (3.90-10.60)	3.270 (0.900-3.910)	14.36	99
15+20+20+20+42	1.27	1.69	1.69	1.69	3.55	9.90 (3.90-10.60)	3.250 (0.900-3.900)	14.27	99
15+20+20+20+50	1.19	1.58	1.58	1.58	3.96	9.90 (3.90-10.60)	3.240 (0.900-3.890)	14.23	99
15+20+20+20+60	1.10	1.47	1.47	1.47	4.40	9.90 (3.90-10.60)	3.210 (0.900-3.880)	14.10	99
15+20+20+20+71	1.02	1.36	1.36	1.36	4.81	9.90 (3.90-10.60)	3.190 (0.900-3.870)	14.01	99
15+20+20+22+22	1.47	1.96	1.96	2.16	2.16	9.70 (3.90-10.70)	3.298 (0.870-3.940)	14.48	99
15+20+20+22+35	1.34	1.79	1.79	1.96	3.13	10.00 (3.90-10.70)	3.410 (0.870-3.940)	14.98	99
15+20+20+22+42	1.26	1.68	1.68	1.85	3.53	10.00 (3.90-10.70)	3.390 (0.870-3.930)	14.89	99
15+20+20+22+50	1.18	1.57	1.57	1.73	3.94	10.00 (3.90-10.70)	3.380 (0.870-3.920)	14.84	99
15+20+20+22+60	1.09	1.46	1.46	1.61	4.38	10.00 (3.90-10.70)	3.350 (0.870-3.910)	14.71	99
15+20+20+22+71	1.01	1.35	1.35	1.49	4.80	10.00 (3.90-10.70)	3.330 (0.870-3.900)	14.62	99
15+20+20+25+25	1.43	1.90	1.90	2.38	2.38	10.00 (3.90-10.70)	3.410 (0.870-3.940)	14.98	99
15+20+20+25+35	1.30	1.74	1.74	2.17	3.04	10.00 (3.90-10.70)	3.410 (0.870-3.940)	14.98	99
15+20+20+25+42	1.23	1.64	1.64	2.05	3.44	10.00 (3.90-10.70)	3.390 (0.870-3.930)	14.89	99
15+20+20+25+50	1.15	1.54	1.54	1.92	3.85	10.00 (3.90-10.70)	3.380 (0.870-3.920)	14.84	99
15+20+20+25+60	1.07	1.43	1.43	1.79	4.29	10.00 (3.90-10.70)	3.350 (0.870-3.910)	14.71	99
15+20+20+25+71	0.99	1.32	1.32	1.66	4.70	10.00 (3.90-10.70)	3.330 (0.870-3.900)	14.62	99
15+20+20+35+35	1.20	1.60	1.60	2.80	2.80	10.00 (3.90-10.70)	3.410 (0.870-3.940)	14.98	99
15+20+20+35+42	1.14	1.52	1.52	2.65	3.18	10.00 (3.90-10.70)	3.390 (0.870-3.930)	14.89	99
15+20+20+35+50	1.07	1.43	1.43	2.50	3.57	10.00 (3.90-10.70)	3.380 (0.870-3.920)	14.84	99
15+20+20+35+60	1.00	1.33	1.33	2.33	4.00	10.00 (3.90-10.70)	3.350 (0.870-3.910)	14.71	99
15+20+20+35+71	0.93	1.24	1.24	2.17	4.41	10.00 (3.90-10.70)	3.330 (0.870-3.900)	14.62	99
15+20+20+42+42	1.08	1.44	1.44	3.02	3.02	10.00 (3.90-10.70)	3.370 (0.870-3.920)	14.80	99
15+20+20+42+50	1.02	1.36	1.36	2.86	3.40	10.00 (3.90-10.70)	3.360 (0.870-3.910)	14.76	99
15+20+20+42+60	0.96	1.27	1.27	2.68	3.82	10.00 (3.90-10.70)	3.330 (0.870-3.900)	14.62	99
15+20+20+42+71	0.89	1.19	1.19	2.50	4.23	10.00 (3.90-10.70)	3.310 (0.870-3.890)	14.54	99
15+20+20+50+50	0.97	1.29	1.29	3.23	3.23	10.00 (3.90-10.70)	3.350 (0.870-3.900)	14.71	99

MXZ-5D102VA COOLING

Indoor units combination	Cooling capacity (kW)						Outdoor unit power consumption(kW)	Current (A)	Power factor(%)
	Unit A	Unit B	Unit C	Unit D	Unit E	Total			
15+20+20+50+60	0.91	1.21	1.21	3.03	3.64	10.00 (3.90-10.70)	3.320 (0.870-3.890)	14.58	99
15+20+22+22+22	1.49	1.98	2.18	2.18	2.18	10.00 (3.90-10.80)	3.513 (0.840-3.970)	15.43	99
15+20+22+22+25	1.46	1.94	2.14	2.14	2.43	10.10 (3.90-10.80)	3.550 (0.840-3.970)	15.59	99
15+20+22+22+35	1.33	1.77	1.95	1.95	3.10	10.10 (3.90-10.80)	3.550 (0.840-3.970)	15.59	99
15+20+22+22+42	1.25	1.67	1.84	1.84	3.51	10.10 (3.90-10.80)	3.530 (0.840-3.960)	15.50	99
15+20+22+22+50	1.17	1.57	1.72	1.72	3.91	10.10 (3.90-10.80)	3.520 (0.840-3.950)	15.46	99
15+20+22+22+60	1.09	1.45	1.60	1.60	4.36	10.10 (3.90-10.80)	3.490 (0.840-3.940)	15.33	99
15+20+22+22+71	1.01	1.35	1.48	1.48	4.78	10.10 (3.90-10.80)	3.470 (0.840-3.930)	15.24	99
15+20+22+25+25	1.42	1.89	2.08	2.36	2.36	10.10 (3.90-10.80)	3.550 (0.840-3.970)	15.59	99
15+20+22+25+35	1.29	1.73	1.90	2.16	3.02	10.10 (3.90-10.80)	3.550 (0.840-3.970)	15.59	99
15+20+22+25+42	1.22	1.63	1.79	2.04	3.42	10.10 (3.90-10.80)	3.530 (0.840-3.960)	15.50	99
15+20+22+25+50	1.15	1.53	1.68	1.91	3.83	10.10 (3.90-10.80)	3.520 (0.840-3.950)	15.46	99
15+20+22+25+60	1.07	1.42	1.56	1.78	4.27	10.10 (3.90-10.80)	3.490 (0.840-3.940)	15.33	99
15+20+22+25+71	0.99	1.32	1.45	1.65	4.69	10.10 (3.90-10.80)	3.470 (0.840-3.930)	15.24	99
15+20+22+35+35	1.19	1.59	1.75	2.78	2.78	10.10 (3.90-10.80)	3.550 (0.840-3.970)	15.59	99
15+20+22+35+42	1.13	1.51	1.66	2.64	3.17	10.10 (3.90-10.80)	3.530 (0.840-3.960)	15.50	99
15+20+22+35+50	1.07	1.42	1.56	2.49	3.56	10.10 (3.90-10.80)	3.520 (0.840-3.950)	15.46	99
15+20+22+35+60	1.00	1.33	1.46	2.33	3.99	10.10 (3.90-10.80)	3.490 (0.840-3.940)	15.33	99
15+20+22+35+71	0.93	1.24	1.36	2.17	4.40	10.10 (3.90-10.80)	3.470 (0.840-3.930)	15.24	99
15+20+22+42+42	1.07	1.43	1.58	3.01	3.01	10.10 (3.90-10.80)	3.510 (0.840-3.950)	15.42	99
15+20+22+42+50	1.02	1.36	1.49	2.85	3.39	10.10 (3.90-10.80)	3.500 (0.840-3.940)	15.37	99
15+20+22+42+60	0.95	1.27	1.40	2.67	3.81	10.10 (3.90-10.80)	3.470 (0.840-3.930)	15.24	99
15+20+22+42+71	0.89	1.19	1.31	2.50	4.22	10.10 (3.90-10.80)	3.450 (0.840-3.920)	15.15	99
15+20+22+50+50	0.96	1.29	1.42	3.22	3.22	10.10 (3.90-10.80)	3.490 (0.840-3.930)	15.33	99
15+20+22+50+60	0.91	1.21	1.33	3.02	3.63	10.10 (3.90-10.80)	3.460 (0.840-3.920)	15.20	99
15+20+25+25+25	1.38	1.84	2.30	2.30	2.30	10.10 (3.90-10.80)	3.550 (0.840-3.970)	15.59	99
15+20+25+25+35	1.26	1.68	2.10	2.10	2.95	10.10 (3.90-10.80)	3.550 (0.840-3.970)	15.59	99
15+20+25+25+42	1.19	1.59	1.99	1.99	3.34	10.10 (3.90-10.80)	3.530 (0.840-3.960)	15.50	99
15+20+25+25+50	1.12	1.50	1.87	1.87	3.74	10.10 (3.90-10.80)	3.520 (0.840-3.950)	15.46	99
15+20+25+25+60	1.04	1.39	1.74	1.74	4.18	10.10 (3.90-10.80)	3.490 (0.840-3.940)	15.33	99
15+20+25+25+71	0.97	1.29	1.62	1.62	4.60	10.10 (3.90-10.80)	3.470 (0.840-3.930)	15.24	99
15+20+25+35+35	1.17	1.55	1.94	2.72	2.72	10.10 (3.90-10.80)	3.550 (0.840-3.970)	15.59	99
15+20+25+35+42	1.11	1.47	1.84	2.58	3.10	10.10 (3.90-10.80)	3.530 (0.840-3.960)	15.50	99
15+20+25+35+50	1.04	1.39	1.74	2.44	3.48	10.10 (3.90-10.80)	3.520 (0.840-3.950)	15.46	99
15+20+25+35+60	0.98	1.30	1.63	2.28	3.91	10.10 (3.90-10.80)	3.490 (0.840-3.940)	15.33	99
15+20+25+35+71	0.91	1.22	1.52	2.13	4.32	10.10 (3.90-10.80)	3.470 (0.840-3.930)	15.24	99
15+20+25+42+42	1.05	1.40	1.75	2.95	2.95	10.10 (3.90-10.80)	3.510 (0.840-3.950)	15.42	99
15+20+25+42+50	1.00	1.33	1.66	2.79	3.32	10.10 (3.90-10.80)	3.500 (0.840-3.940)	15.37	99
15+20+25+42+60	0.94	1.25	1.56	2.62	3.74	10.10 (3.90-10.80)	3.470 (0.840-3.930)	15.24	99
15+20+25+50+50	0.95	1.26	1.58	3.16	3.16	10.10 (3.90-10.80)	3.490 (0.840-3.930)	15.33	99
15+20+25+50+60	0.89	1.19	1.49	2.97	3.56	10.10 (3.90-10.80)	3.460 (0.840-3.920)	15.20	99

MXZ-5D102VA COOLING

Indoor units combination	Cooling capacity (kW)						Outdoor unit power consumption(kW)	Current (A)	Power factor(%)
	Unit A	Unit B	Unit C	Unit D	Unit E	Total			
15+20+35+35+35	1.08	1.44	2.53	2.53	2.53	10.10 (3.90-10.80)	3.550 (0.840-3.970)	15.59	99
15+20+35+35+42	1.03	1.37	2.40	2.40	2.89	10.10 (3.90-10.80)	3.530 (0.840-3.960)	15.50	99
15+20+35+35+50	0.98	1.30	2.28	2.28	3.26	10.10 (3.90-10.80)	3.520 (0.840-3.950)	15.46	99
15+20+35+35+60	0.92	1.22	2.14	2.14	3.67	10.10 (3.90-10.80)	3.490 (0.840-3.940)	15.33	99
15+20+35+42+42	0.98	1.31	2.30	2.75	2.75	10.10 (3.90-10.80)	3.510 (0.840-3.950)	15.42	99
15+20+35+42+50	0.94	1.25	2.18	2.62	3.12	10.10 (3.90-10.80)	3.500 (0.840-3.940)	15.37	99
15+20+35+42+60	0.88	1.17	2.06	2.47	3.52	10.10 (3.90-10.80)	3.470 (0.840-3.930)	15.24	99
15+20+35+50+50	0.89	1.19	2.08	2.97	2.97	10.10 (3.90-10.80)	3.490 (0.840-3.930)	15.33	99
15+20+42+42+42	0.94	1.25	2.63	2.63	2.63	10.10 (3.90-10.80)	3.490 (0.840-3.940)	15.33	99
15+20+42+42+50	0.90	1.20	2.51	2.51	2.99	10.10 (3.90-10.80)	3.480 (0.840-3.930)	15.28	99
15+22+22+22+22	1.49	2.18	2.18	2.18	2.18	10.20 (3.90-10.90)	3.690 (0.810-4.000)	16.21	99
15+22+22+22+25	1.44	2.12	2.12	2.12	2.41	10.20 (3.90-10.90)	3.690 (0.810-4.000)	16.21	99
15+22+22+22+35	1.32	1.93	1.93	1.93	3.08	10.20 (3.90-10.90)	3.690 (0.810-4.000)	16.21	99
15+22+22+22+42	1.24	1.82	1.82	1.82	3.48	10.20 (3.90-10.90)	3.670 (0.810-3.990)	16.12	99
15+22+22+22+50	1.17	1.71	1.71	1.71	3.89	10.20 (3.90-10.90)	3.660 (0.810-3.980)	16.07	99
15+22+22+22+60	1.09	1.59	1.59	1.59	4.34	10.20 (3.90-10.90)	3.630 (0.810-3.970)	15.94	99
15+22+22+22+71	1.01	1.48	1.48	1.48	4.76	10.20 (3.90-10.90)	3.610 (0.810-3.960)	15.85	99
15+22+22+25+25	1.40	2.06	2.06	2.34	2.34	10.20 (3.90-10.90)	3.690 (0.810-4.000)	16.21	99
15+22+22+25+35	1.29	1.89	1.89	2.14	3.00	10.20 (3.90-10.90)	3.690 (0.810-4.000)	16.21	99
15+22+22+25+42	1.21	1.78	1.78	2.02	3.40	10.20 (3.90-10.90)	3.670 (0.810-3.990)	16.12	99
15+22+22+25+50	1.14	1.67	1.67	1.90	3.81	10.20 (3.90-10.90)	3.660 (0.810-3.980)	16.07	99
15+22+22+25+60	1.06	1.56	1.56	1.77	4.25	10.20 (3.90-10.90)	3.630 (0.810-3.970)	15.94	99
15+22+22+25+71	0.99	1.45	1.45	1.65	4.67	10.20 (3.90-10.90)	3.610 (0.810-3.960)	15.85	99
15+22+22+35+35	1.19	1.74	1.74	2.77	2.77	10.20 (3.90-10.90)	3.690 (0.810-4.000)	16.21	99
15+22+22+35+42	1.13	1.65	1.65	2.63	3.15	10.20 (3.90-10.90)	3.670 (0.810-3.990)	16.12	99
15+22+22+35+50	1.06	1.56	1.56	2.48	3.54	10.20 (3.90-10.90)	3.660 (0.810-3.980)	16.07	99
15+22+22+35+60	0.99	1.46	1.46	2.32	3.97	10.20 (3.90-10.90)	3.630 (0.810-3.970)	15.94	99
15+22+22+35+71	0.93	1.36	1.36	2.16	4.39	10.20 (3.90-10.90)	3.610 (0.810-3.960)	15.85	99
15+22+22+42+42	1.07	1.57	1.57	3.00	3.00	10.20 (3.90-10.90)	3.650 (0.810-3.980)	16.03	99
15+22+22+42+50	1.01	1.49	1.49	2.84	3.38	10.20 (3.90-10.90)	3.640 (0.810-3.970)	15.99	99
15+22+22+42+60	0.95	1.39	1.39	2.66	3.80	10.20 (3.90-10.90)	3.610 (0.810-3.960)	15.85	99
15+22+22+42+71	0.89	1.30	1.30	2.49	4.21	10.20 (3.90-10.90)	3.590 (0.810-3.950)	15.77	99
15+22+22+50+50	0.96	1.41	1.41	3.21	3.21	10.20 (3.90-10.90)	3.630 (0.810-3.960)	15.94	99
15+22+22+50+60	0.91	1.33	1.33	3.02	3.62	10.20 (3.90-10.90)	3.600 (0.810-3.950)	15.81	99
15+22+25+25+25	1.37	2.00	2.28	2.28	2.28	10.20 (3.90-10.90)	3.690 (0.810-4.000)	16.21	99
15+22+25+25+35	1.25	1.84	2.09	2.09	2.93	10.20 (3.90-10.90)	3.690 (0.810-4.000)	16.21	99
15+22+25+25+42	1.19	1.74	1.98	1.98	3.32	10.20 (3.90-10.90)	3.670 (0.810-3.990)	16.12	99
15+22+25+25+50	1.12	1.64	1.86	1.86	3.72	10.20 (3.90-10.90)	3.660 (0.810-3.980)	16.07	99
15+22+25+25+60	1.04	1.53	1.73	1.73	4.16	10.20 (3.90-10.90)	3.630 (0.810-3.970)	15.94	99
15+22+25+25+71	0.97	1.42	1.61	1.61	4.58	10.20 (3.90-10.90)	3.610 (0.810-3.960)	15.85	99
15+22+25+35+35	1.16	1.70	1.93	2.70	2.70	10.20 (3.90-10.90)	3.690 (0.810-4.000)	16.21	99

MXZ-5D102VA COOLING

Indoor units combination	Cooling capacity (kW)						Outdoor unit power consumption(kW)	Current (A)	Power factor(%)
	Unit A	Unit B	Unit C	Unit D	Unit E	Total			
15+22+25+35+42	1.10	1.61	1.83	2.57	3.08	10.20 (3.90-10.90)	3.670 (0.810-3.990)	16.12	99
15+22+25+35+50	1.04	1.53	1.73	2.43	3.47	10.20 (3.90-10.90)	3.660 (0.810-3.980)	16.07	99
15+22+25+35+60	0.97	1.43	1.62	2.27	3.90	10.20 (3.90-10.90)	3.630 (0.810-3.970)	15.94	99
15+22+25+35+71	0.91	1.34	1.52	2.13	4.31	10.20 (3.90-10.90)	3.610 (0.810-3.960)	15.85	99
15+22+25+42+42	1.05	1.54	1.75	2.93	2.93	10.20 (3.90-10.90)	3.650 (0.810-3.980)	16.03	99
15+22+25+42+50	0.99	1.46	1.66	2.78	3.31	10.20 (3.90-10.90)	3.640 (0.810-3.970)	15.99	99
15+22+25+42+60	0.93	1.37	1.55	2.61	3.73	10.20 (3.90-10.90)	3.610 (0.810-3.960)	15.85	99
15+22+25+50+50	0.94	1.39	1.57	3.15	3.15	10.20 (3.90-10.90)	3.630 (0.810-3.960)	15.94	99
15+22+25+50+60	0.89	1.30	1.48	2.97	3.56	10.20 (3.90-10.90)	3.600 (0.810-3.950)	15.81	99
15+22+35+35+35	1.08	1.58	2.51	2.51	2.51	10.20 (3.90-10.90)	3.690 (0.810-4.000)	16.21	99
15+22+35+35+42	1.03	1.51	2.40	2.40	2.88	10.20 (3.90-10.90)	3.670 (0.810-3.990)	16.12	99
15+22+35+35+50	0.97	1.43	2.27	2.27	3.25	10.20 (3.90-10.90)	3.660 (0.810-3.980)	16.07	99
15+22+35+35+60	0.92	1.34	2.14	2.14	3.66	10.20 (3.90-10.90)	3.630 (0.810-3.970)	15.94	99
15+22+35+42+42	0.98	1.44	2.29	2.75	2.75	10.20 (3.90-10.90)	3.650 (0.810-3.980)	16.03	99
15+22+35+42+50	0.93	1.37	2.18	2.61	3.11	10.20 (3.90-10.90)	3.640 (0.810-3.970)	15.99	99
15+22+35+50+50	0.89	1.30	2.08	2.97	2.97	10.20 (3.90-10.90)	3.630 (0.810-3.960)	15.94	99
15+22+42+42+42	0.94	1.38	2.63	2.63	2.63	10.20 (3.90-10.90)	3.630 (0.810-3.970)	15.94	99
15+22+42+42+50	0.89	1.31	2.51	2.51	2.98	10.20 (3.90-10.90)	3.620 (0.810-3.960)	15.90	99
15+25+25+25+25	1.33	2.22	2.22	2.22	2.22	10.20 (3.90-10.90)	3.690 (0.810-4.000)	16.21	99
15+25+25+25+35	1.22	2.04	2.04	2.04	2.86	10.20 (3.90-10.90)	3.690 (0.810-4.000)	16.21	99
15+25+25+25+42	1.16	1.93	1.93	1.93	3.25	10.20 (3.90-10.90)	3.670 (0.810-3.990)	16.12	99
15+25+25+25+50	1.09	1.82	1.82	1.82	3.64	10.20 (3.90-10.90)	3.660 (0.810-3.980)	16.07	99
15+25+25+25+60	1.02	1.70	1.70	1.70	4.08	10.20 (3.90-10.90)	3.630 (0.810-3.970)	15.94	99
15+25+25+25+71	0.95	1.58	1.58	1.58	4.50	10.20 (3.90-10.90)	3.610 (0.810-3.960)	15.85	99
15+25+25+35+35	1.13	1.89	1.89	2.64	2.64	10.20 (3.90-10.90)	3.690 (0.810-4.000)	16.21	99
15+25+25+35+42	1.08	1.80	1.80	2.51	3.02	10.20 (3.90-10.90)	3.670 (0.810-3.990)	16.12	99
15+25+25+35+50	1.02	1.70	1.70	2.38	3.40	10.20 (3.90-10.90)	3.660 (0.810-3.980)	16.07	99
15+25+25+35+60	0.96	1.59	1.59	2.23	3.83	10.20 (3.90-10.90)	3.630 (0.810-3.970)	15.94	99
15+25+25+35+71	0.89	1.49	1.49	2.09	4.24	10.20 (3.90-10.90)	3.610 (0.810-3.960)	15.85	99
15+25+25+42+42	1.03	1.71	1.71	2.88	2.88	10.20 (3.90-10.90)	3.650 (0.810-3.980)	16.03	99
15+25+25+42+50	0.97	1.62	1.62	2.73	3.25	10.20 (3.90-10.90)	3.640 (0.810-3.970)	15.99	99
15+25+25+42+60	0.92	1.53	1.53	2.57	3.66	10.20 (3.90-10.90)	3.610 (0.810-3.960)	15.85	99
15+25+25+50+50	0.93	1.55	1.55	3.09	3.09	10.20 (3.90-10.90)	3.630 (0.810-3.960)	15.94	99
15+25+35+35+35	1.06	1.76	2.46	2.46	2.46	10.20 (3.90-10.90)	3.690 (0.810-4.000)	16.21	99
15+25+35+35+42	1.01	1.68	2.35	2.35	2.82	10.20 (3.90-10.90)	3.670 (0.810-3.990)	16.12	99
15+25+35+35+50	0.96	1.59	2.23	2.23	3.19	10.20 (3.90-10.90)	3.660 (0.810-3.980)	16.07	99
15+25+35+35+60	0.90	1.50	2.10	2.10	3.60	10.20 (3.90-10.90)	3.630 (0.810-3.970)	15.94	99
15+25+35+42+42	0.96	1.60	2.25	2.69	2.69	10.20 (3.90-10.90)	3.650 (0.810-3.980)	16.03	99
15+25+35+42+50	0.92	1.53	2.14	2.57	3.05	10.20 (3.90-10.90)	3.640 (0.810-3.970)	15.99	99
15+25+42+42+42	0.92	1.54	2.58	2.58	2.58	10.20 (3.90-10.90)	3.630 (0.810-3.970)	15.94	99
15+35+35+35+35	0.99	2.30	2.30	2.30	2.30	10.20 (3.90-10.90)	3.690 (0.810-4.000)	16.21	99

MXZ-5D102VA COOLING

Indoor units combination	Cooling capacity (kW)						Outdoor unit power consumption(kW)	Current (A)	Power factor(%)
	Unit A	Unit B	Unit C	Unit D	Unit E	Total			
15+35+35+35+42	0.94	2.20	2.20	2.20	2.64	10.20 (3.90-10.90)	3.670 (0.810-3.990)	16.12	99
15+35+35+35+50	0.90	2.10	2.10	2.10	3.00	10.20 (3.90-10.90)	3.660 (0.810-3.980)	16.07	99
15+35+35+42+42	0.91	2.11	2.11	2.53	2.53	10.20 (3.90-10.90)	3.650 (0.810-3.980)	16.03	99
18+18+18+18+18	1.80	1.80	1.80	1.80	1.80	9.00 (3.90-11.00)	3.390 (0.780-4.000)	14.89	99
18+18+18+18+20	1.78	1.78	1.78	1.78	1.98	9.10 (3.90-10.90)	3.325 (0.810-3.970)	14.60	99
18+18+18+18+22	1.80	1.80	1.80	1.80	2.20	9.40 (3.90-11.00)	3.540 (0.780-4.000)	15.55	99
18+18+18+18+25	1.80	1.80	1.80	1.80	2.50	9.70 (3.90-11.00)	3.653 (0.780-4.000)	16.04	99
18+18+18+18+35	1.72	1.72	1.72	1.72	3.34	10.20 (3.90-11.00)	3.840 (0.780-4.000)	16.86	99
18+18+18+18+42	1.61	1.61	1.61	1.61	3.76	10.20 (3.90-11.00)	3.820 (0.780-3.990)	16.78	99
18+18+18+18+50	1.50	1.50	1.50	1.50	4.18	10.20 (3.90-11.00)	3.810 (0.780-3.980)	16.73	99
18+18+18+18+60	1.39	1.39	1.39	1.39	4.64	10.20 (3.90-11.00)	3.780 (0.780-3.970)	16.60	99
18+18+18+18+71	1.28	1.28	1.28	1.28	5.06	10.20 (3.90-11.00)	3.760 (0.780-3.960)	16.51	99
18+18+18+20+20	1.76	1.76	1.76	1.96	1.96	9.20 (3.90-10.80)	3.260 (0.840-3.940)	14.32	99
18+18+18+20+22	1.78	1.78	1.78	1.98	2.18	9.50 (3.90-10.90)	3.475 (0.810-3.970)	15.26	99
18+18+18+20+25	1.78	1.78	1.78	1.98	2.47	9.80 (3.90-10.90)	3.588 (0.810-3.970)	15.76	99
18+18+18+20+35	1.67	1.67	1.67	1.85	3.24	10.10 (3.90-10.90)	3.700 (0.810-3.970)	16.25	99
18+18+18+20+42	1.57	1.57	1.57	1.74	3.66	10.10 (3.90-10.90)	3.680 (0.810-3.960)	16.16	99
18+18+18+20+50	1.47	1.47	1.47	1.63	4.07	10.10 (3.90-10.90)	3.670 (0.810-3.950)	16.12	99
18+18+18+20+60	1.36	1.36	1.36	1.51	4.52	10.10 (3.90-10.90)	3.640 (0.810-3.940)	15.99	99
18+18+18+20+71	1.25	1.25	1.25	1.39	4.95	10.10 (3.90-10.90)	3.620 (0.810-3.930)	15.90	99
18+18+18+22+22	1.80	1.80	1.80	2.20	2.20	9.80 (3.90-11.00)	3.690 (0.780-4.000)	16.21	99
18+18+18+22+25	1.80	1.80	1.80	2.20	2.50	10.10 (3.90-11.00)	3.803 (0.780-4.000)	16.70	99
18+18+18+22+35	1.65	1.65	1.65	2.02	3.22	10.20 (3.90-11.00)	3.840 (0.780-4.000)	16.86	99
18+18+18+22+42	1.56	1.56	1.56	1.90	3.63	10.20 (3.90-11.00)	3.820 (0.780-3.990)	16.78	99
18+18+18+22+50	1.46	1.46	1.46	1.78	4.05	10.20 (3.90-11.00)	3.810 (0.780-3.980)	16.73	99
18+18+18+22+60	1.35	1.35	1.35	1.65	4.50	10.20 (3.90-11.00)	3.780 (0.780-3.970)	16.60	99
18+18+18+22+71	1.25	1.25	1.25	1.53	4.93	10.20 (3.90-11.00)	3.760 (0.780-3.960)	16.51	99
18+18+18+25+25	1.77	1.77	1.77	2.45	2.45	10.20 (3.90-11.00)	3.840 (0.780-4.000)	16.86	99
18+18+18+25+35	1.61	1.61	1.61	2.24	3.13	10.20 (3.90-11.00)	3.840 (0.780-4.000)	16.86	99
18+18+18+25+42	1.52	1.52	1.52	2.11	3.54	10.20 (3.90-11.00)	3.820 (0.780-3.990)	16.78	99
18+18+18+25+50	1.42	1.42	1.42	1.98	3.95	10.20 (3.90-11.00)	3.810 (0.780-3.980)	16.73	99
18+18+18+25+60	1.32	1.32	1.32	1.83	4.40	10.20 (3.90-11.00)	3.780 (0.780-3.970)	16.60	99
18+18+18+25+71	1.22	1.22	1.22	1.70	4.83	10.20 (3.90-11.00)	3.760 (0.780-3.960)	16.51	99
18+18+18+35+35	1.48	1.48	1.48	2.88	2.88	10.20 (3.90-11.00)	3.840 (0.780-4.000)	16.86	99
18+18+18+35+42	1.40	1.40	1.40	2.73	3.27	10.20 (3.90-11.00)	3.820 (0.780-3.990)	16.78	99
18+18+18+35+50	1.32	1.32	1.32	2.57	3.67	10.20 (3.90-11.00)	3.810 (0.780-3.980)	16.73	99
18+18+18+35+60	1.23	1.23	1.23	2.40	4.11	10.20 (3.90-11.00)	3.780 (0.780-3.970)	16.60	99
18+18+18+35+71	1.15	1.15	1.15	2.23	4.53	10.20 (3.90-11.00)	3.760 (0.780-3.960)	16.51	99
18+18+18+42+42	1.33	1.33	1.33	3.10	3.10	10.20 (3.90-11.00)	3.800 (0.780-3.980)	16.69	99
18+18+18+42+50	1.26	1.26	1.26	2.93	3.49	10.20 (3.90-11.00)	3.790 (0.780-3.970)	16.64	99
18+18+18+42+60	1.18	1.18	1.18	2.75	3.92	10.20 (3.90-11.00)	3.760 (0.780-3.960)	16.51	99

MXZ-5D102VA COOLING

Indoor units combination	Cooling capacity (kW)						Outdoor unit power consumption(kW)	Current (A)	Power factor(%)
	Unit A	Unit B	Unit C	Unit D	Unit E	Total			
18+18+18+42+71	1.10	1.10	1.10	2.57	4.34	10.20 (3.90-11.00)	3.740 (0.780-3.950)	16.43	99
18+18+18+50+50	1.19	1.19	1.19	3.31	3.31	10.20 (3.90-11.00)	3.780 (0.780-3.960)	16.60	99
18+18+18+50+60	1.12	1.12	1.12	3.11	3.73	10.20 (3.90-11.00)	3.750 (0.780-3.950)	16.47	99
18+18+20+20+20	1.74	1.74	1.94	1.94	1.94	9.30 (3.90-10.70)	3.195 (0.870-3.910)	14.03	99
18+18+20+20+22	1.76	1.76	1.96	1.96	2.16	9.60 (3.90-10.80)	3.410 (0.840-3.940)	14.98	99
18+18+20+20+25	1.76	1.76	1.96	1.96	2.45	9.90 (3.90-10.80)	3.523 (0.840-3.940)	15.47	99
18+18+20+20+35	1.62	1.62	1.80	1.80	3.15	10.00 (3.90-10.80)	3.560 (0.840-3.940)	15.63	99
18+18+20+20+42	1.53	1.53	1.69	1.69	3.56	10.00 (3.90-10.80)	3.540 (0.840-3.930)	15.55	99
18+18+20+20+50	1.43	1.43	1.59	1.59	3.97	10.00 (3.90-10.80)	3.530 (0.840-3.920)	15.50	99
18+18+20+20+60	1.32	1.32	1.47	1.47	4.41	10.00 (3.90-10.80)	3.500 (0.840-3.910)	15.37	99
18+18+20+20+71	1.22	1.22	1.36	1.36	4.83	10.00 (3.90-10.80)	3.480 (0.840-3.900)	15.28	99
18+18+20+22+22	1.78	1.78	1.98	2.18	2.18	9.90 (3.90-10.90)	3.625 (0.810-3.970)	15.92	99
18+18+20+22+25	1.77	1.77	1.96	2.16	2.45	10.10 (3.90-10.90)	3.700 (0.810-3.970)	16.25	99
18+18+20+22+35	1.61	1.61	1.79	1.97	3.13	10.10 (3.90-10.90)	3.700 (0.810-3.970)	16.25	99
18+18+20+22+42	1.52	1.52	1.68	1.85	3.54	10.10 (3.90-10.90)	3.680 (0.810-3.960)	16.16	99
18+18+20+22+50	1.42	1.42	1.58	1.74	3.95	10.10 (3.90-10.90)	3.670 (0.810-3.950)	16.12	99
18+18+20+22+60	1.32	1.32	1.46	1.61	4.39	10.10 (3.90-10.90)	3.640 (0.810-3.940)	15.99	99
18+18+20+22+71	1.22	1.22	1.36	1.49	4.81	10.10 (3.90-10.90)	3.620 (0.810-3.930)	15.90	99
18+18+20+25+25	1.72	1.72	1.91	2.38	2.38	10.10 (3.90-10.90)	3.700 (0.810-3.970)	16.25	99
18+18+20+25+35	1.57	1.57	1.74	2.18	3.05	10.10 (3.90-10.90)	3.700 (0.810-3.970)	16.25	99
18+18+20+25+42	1.48	1.48	1.64	2.05	3.45	10.10 (3.90-10.90)	3.680 (0.810-3.960)	16.16	99
18+18+20+25+50	1.39	1.39	1.54	1.93	3.85	10.10 (3.90-10.90)	3.670 (0.810-3.950)	16.12	99
18+18+20+25+60	1.29	1.29	1.43	1.79	4.30	10.10 (3.90-10.90)	3.640 (0.810-3.940)	15.99	99
18+18+20+25+71	1.20	1.20	1.33	1.66	4.72	10.10 (3.90-10.90)	3.620 (0.810-3.930)	15.90	99
18+18+20+35+35	1.44	1.44	1.60	2.81	2.81	10.10 (3.90-10.90)	3.700 (0.810-3.970)	16.25	99
18+18+20+35+42	1.37	1.37	1.52	2.66	3.19	10.10 (3.90-10.90)	3.680 (0.810-3.960)	16.16	99
18+18+20+35+50	1.29	1.29	1.43	2.51	3.58	10.10 (3.90-10.90)	3.670 (0.810-3.950)	16.12	99
18+18+20+35+60	1.20	1.20	1.34	2.34	4.01	10.10 (3.90-10.90)	3.640 (0.810-3.940)	15.99	99
18+18+20+35+71	1.12	1.12	1.25	2.18	4.43	10.10 (3.90-10.90)	3.620 (0.810-3.930)	15.90	99
18+18+20+42+42	1.30	1.30	1.44	3.03	3.03	10.10 (3.90-10.90)	3.660 (0.810-3.950)	16.07	99
18+18+20+42+50	1.23	1.23	1.36	2.87	3.41	10.10 (3.90-10.90)	3.650 (0.810-3.940)	16.03	99
18+18+20+42+60	1.15	1.15	1.28	2.68	3.84	10.10 (3.90-10.90)	3.620 (0.810-3.930)	15.90	99
18+18+20+42+71	1.08	1.08	1.20	2.51	4.24	10.10 (3.90-10.90)	3.600 (0.810-3.920)	15.81	99
18+18+20+50+50	1.17	1.17	1.29	3.24	3.24	10.10 (3.90-10.90)	3.640 (0.810-3.930)	15.99	99
18+18+20+50+60	1.10	1.10	1.22	3.04	3.65	10.10 (3.90-10.90)	3.610 (0.810-3.920)	15.85	99
18+18+22+22+22	1.80	1.80	2.20	2.20	2.20	10.20 (3.90-11.00)	3.840 (0.780-4.000)	16.86	99
18+18+22+22+25	1.75	1.75	2.14	2.14	2.43	10.20 (3.90-11.00)	3.840 (0.780-4.000)	16.86	99
18+18+22+22+35	1.60	1.60	1.95	1.95	3.10	10.20 (3.90-11.00)	3.840 (0.780-4.000)	16.86	99
18+18+22+22+42	1.50	1.50	1.84	1.84	3.51	10.20 (3.90-11.00)	3.820 (0.780-3.990)	16.78	99
18+18+22+22+50	1.41	1.41	1.73	1.73	3.92	10.20 (3.90-11.00)	3.810 (0.780-3.980)	16.73	99
18+18+22+22+60	1.31	1.31	1.60	1.60	4.37	10.20 (3.90-11.00)	3.780 (0.780-3.970)	16.60	99

MXZ-5D102VA COOLING

Indoor units combination	Cooling capacity (kW)						Outdoor unit power consumption(kW)	Current (A)	Power factor(%)
	Unit A	Unit B	Unit C	Unit D	Unit E	Total			
18+18+22+22+71	1.22	1.22	1.49	1.49	4.80	10.20 (3.90-11.00)	3.760 (0.780-3.960)	16.51	99
18+18+22+25+25	1.70	1.70	2.08	2.36	2.36	10.20 (3.90-11.00)	3.840 (0.780-4.000)	16.86	99
18+18+22+25+35	1.56	1.56	1.90	2.16	3.03	10.20 (3.90-11.00)	3.840 (0.780-4.000)	16.86	99
18+18+22+25+42	1.47	1.47	1.80	2.04	3.43	10.20 (3.90-11.00)	3.820 (0.780-3.990)	16.78	99
18+18+22+25+50	1.38	1.38	1.69	1.92	3.83	10.20 (3.90-11.00)	3.810 (0.780-3.980)	16.73	99
18+18+22+25+60	1.28	1.28	1.57	1.78	4.28	10.20 (3.90-11.00)	3.780 (0.780-3.970)	16.60	99
18+18+22+25+71	1.19	1.19	1.46	1.66	4.70	10.20 (3.90-11.00)	3.760 (0.780-3.960)	16.51	99
18+18+22+35+35	1.43	1.43	1.75	2.79	2.79	10.20 (3.90-11.00)	3.840 (0.780-4.000)	16.86	99
18+18+22+35+42	1.36	1.36	1.66	2.64	3.17	10.20 (3.90-11.00)	3.820 (0.780-3.990)	16.78	99
18+18+22+35+50	1.28	1.28	1.57	2.50	3.57	10.20 (3.90-11.00)	3.810 (0.780-3.980)	16.73	99
18+18+22+35+60	1.20	1.20	1.47	2.33	4.00	10.20 (3.90-11.00)	3.780 (0.780-3.970)	16.60	99
18+18+22+35+71	1.12	1.12	1.37	2.18	4.42	10.20 (3.90-11.00)	3.760 (0.780-3.960)	16.51	99
18+18+22+42+42	1.29	1.29	1.58	3.02	3.02	10.20 (3.90-11.00)	3.800 (0.780-3.980)	16.69	99
18+18+22+42+50	1.22	1.22	1.50	2.86	3.40	10.20 (3.90-11.00)	3.790 (0.780-3.970)	16.64	99
18+18+22+42+60	1.15	1.15	1.40	2.68	3.83	10.20 (3.90-11.00)	3.760 (0.780-3.960)	16.51	99
18+18+22+42+71	1.07	1.07	1.31	2.51	4.24	10.20 (3.90-11.00)	3.740 (0.780-3.950)	16.43	99
18+18+22+50+50	1.16	1.16	1.42	3.23	3.23	10.20 (3.90-11.00)	3.780 (0.780-3.960)	16.60	99
18+18+22+50+60	1.09	1.09	1.34	3.04	3.64	10.20 (3.90-11.00)	3.750 (0.780-3.950)	16.47	99
18+18+25+25+25	1.65	1.65	2.30	2.30	2.30	10.20 (3.90-11.00)	3.840 (0.780-4.000)	16.86	99
18+18+25+25+35	1.52	1.52	2.11	2.11	2.95	10.20 (3.90-11.00)	3.840 (0.780-4.000)	16.86	99
18+18+25+25+42	1.43	1.43	1.99	1.99	3.35	10.20 (3.90-11.00)	3.820 (0.780-3.990)	16.78	99
18+18+25+25+50	1.35	1.35	1.88	1.88	3.75	10.20 (3.90-11.00)	3.810 (0.780-3.980)	16.73	99
18+18+25+25+60	1.26	1.26	1.75	1.75	4.19	10.20 (3.90-11.00)	3.780 (0.780-3.970)	16.60	99
18+18+25+25+71	1.17	1.17	1.62	1.62	4.61	10.20 (3.90-11.00)	3.760 (0.780-3.960)	16.51	99
18+18+25+35+35	1.40	1.40	1.95	2.73	2.73	10.20 (3.90-11.00)	3.840 (0.780-4.000)	16.86	99
18+18+25+35+42	1.33	1.33	1.85	2.59	3.10	10.20 (3.90-11.00)	3.820 (0.780-3.990)	16.78	99
18+18+25+35+50	1.26	1.26	1.75	2.45	3.49	10.20 (3.90-11.00)	3.810 (0.780-3.980)	16.73	99
18+18+25+35+60	1.18	1.18	1.63	2.29	3.92	10.20 (3.90-11.00)	3.780 (0.780-3.970)	16.60	99
18+18+25+35+71	1.10	1.10	1.53	2.14	4.34	10.20 (3.90-11.00)	3.760 (0.780-3.960)	16.51	99
18+18+25+42+42	1.27	1.27	1.76	2.95	2.95	10.20 (3.90-11.00)	3.800 (0.780-3.980)	16.69	99
18+18+25+42+50	1.20	1.20	1.67	2.80	3.33	10.20 (3.90-11.00)	3.790 (0.780-3.970)	16.64	99
18+18+25+42+60	1.13	1.13	1.56	2.63	3.75	10.20 (3.90-11.00)	3.760 (0.780-3.960)	16.51	99
18+18+25+50+50	1.14	1.14	1.58	3.17	3.17	10.20 (3.90-11.00)	3.780 (0.780-3.960)	16.60	99
18+18+25+50+60	1.07	1.07	1.49	2.98	3.58	10.20 (3.90-11.00)	3.750 (0.780-3.950)	16.47	99
18+18+35+35+35	1.30	1.30	2.53	2.53	2.53	10.20 (3.90-11.00)	3.840 (0.780-4.000)	16.86	99
18+18+35+35+42	1.24	1.24	2.41	2.41	2.89	10.20 (3.90-11.00)	3.820 (0.780-3.990)	16.78	99
18+18+35+35+50	1.18	1.18	2.29	2.29	3.27	10.20 (3.90-11.00)	3.810 (0.780-3.980)	16.73	99
18+18+35+35+60	1.11	1.11	2.15	2.15	3.69	10.20 (3.90-11.00)	3.780 (0.780-3.970)	16.60	99
18+18+35+42+42	1.18	1.18	2.30	2.76	2.76	10.20 (3.90-11.00)	3.800 (0.780-3.980)	16.69	99
18+18+35+42+50	1.13	1.13	2.19	2.63	3.13	10.20 (3.90-11.00)	3.790 (0.780-3.970)	16.64	99
18+18+35+50+50	1.07	1.07	2.09	2.98	2.98	10.20 (3.90-11.00)	3.780 (0.780-3.960)	16.60	99

MXZ-5D102VA COOLING

Indoor units combination	Cooling capacity (kW)						Outdoor unit power consumption(kW)	Current (A)	Power factor(%)
	Unit A	Unit B	Unit C	Unit D	Unit E	Total			
18+18+42+42+42	1.13	1.13	2.64	2.64	2.64	10.20 (3.90-11.00)	3.780 (0.780-3.970)	16.60	99
18+18+42+42+50	1.08	1.08	2.52	2.52	3.00	10.20 (3.90-11.00)	3.770 (0.780-3.960)	16.56	99
18+20+20+20+20	1.73	1.92	1.92	1.92	1.92	9.40 (3.90-10.60)	3.130 (0.900-3.880)	13.75	99
18+20+20+20+22	1.75	1.94	1.94	1.94	2.13	9.70 (3.90-10.70)	3.345 (0.870-3.910)	14.69	99
18+20+20+20+25	1.73	1.92	1.92	1.92	2.40	9.90 (3.90-10.70)	3.420 (0.870-3.910)	15.02	99
18+20+20+20+35	1.58	1.75	1.75	1.75	3.07	9.90 (3.90-10.70)	3.420 (0.870-3.910)	15.02	99
18+20+20+20+42	1.49	1.65	1.65	1.65	3.47	9.90 (3.90-10.70)	3.400 (0.870-3.900)	14.93	99
18+20+20+20+50	1.39	1.55	1.55	1.55	3.87	9.90 (3.90-10.70)	3.390 (0.870-3.890)	14.89	99
18+20+20+20+60	1.29	1.43	1.43	1.43	4.30	9.90 (3.90-10.70)	3.360 (0.870-3.880)	14.76	99
18+20+20+20+71	1.20	1.33	1.33	1.33	4.72	9.90 (3.90-10.70)	3.340 (0.870-3.870)	14.67	99
18+20+20+22+25	1.71	1.90	1.90	2.10	2.38	10.00 (3.90-10.80)	3.560 (0.840-3.940)	15.63	99
18+20+20+22+35	1.57	1.74	1.74	1.91	3.04	10.00 (3.90-10.80)	3.560 (0.840-3.940)	15.63	99
18+20+20+22+42	1.48	1.64	1.64	1.80	3.44	10.00 (3.90-10.80)	3.540 (0.840-3.930)	15.55	99
18+20+20+22+50	1.38	1.54	1.54	1.69	3.85	10.00 (3.90-10.80)	3.530 (0.840-3.920)	15.50	99
18+20+20+22+60	1.29	1.43	1.43	1.57	4.29	10.00 (3.90-10.80)	3.500 (0.840-3.910)	15.37	99
18+20+20+22+71	1.19	1.32	1.32	1.46	4.70	10.00 (3.90-10.80)	3.480 (0.840-3.900)	15.28	99
18+20+20+25+25	1.67	1.85	1.85	2.31	2.31	10.00 (3.90-10.80)	3.560 (0.840-3.940)	15.63	99
18+20+20+25+35	1.53	1.69	1.69	2.12	2.97	10.00 (3.90-10.80)	3.560 (0.840-3.940)	15.63	99
18+20+20+25+42	1.44	1.60	1.60	2.00	3.36	10.00 (3.90-10.80)	3.540 (0.840-3.930)	15.55	99
18+20+20+25+50	1.35	1.50	1.50	1.88	3.76	10.00 (3.90-10.80)	3.530 (0.840-3.920)	15.50	99
18+20+20+25+60	1.26	1.40	1.40	1.75	4.20	10.00 (3.90-10.80)	3.500 (0.840-3.910)	15.37	99
18+20+20+25+71	1.17	1.30	1.30	1.62	4.61	10.00 (3.90-10.80)	3.480 (0.840-3.900)	15.28	99
18+20+20+35+35	1.41	1.56	1.56	2.73	2.73	10.00 (3.90-10.80)	3.560 (0.840-3.940)	15.63	99
18+20+20+35+42	1.33	1.48	1.48	2.59	3.11	10.00 (3.90-10.80)	3.540 (0.840-3.930)	15.55	99
18+20+20+35+50	1.26	1.40	1.40	2.45	3.50	10.00 (3.90-10.80)	3.530 (0.840-3.920)	15.50	99
18+20+20+35+60	1.18	1.31	1.31	2.29	3.92	10.00 (3.90-10.80)	3.500 (0.840-3.910)	15.37	99
18+20+20+35+71	1.10	1.22	1.22	2.13	4.33	10.00 (3.90-10.80)	3.480 (0.840-3.900)	15.28	99
18+20+20+42+42	1.27	1.41	1.41	2.96	2.96	10.00 (3.90-10.80)	3.520 (0.840-3.920)	15.46	99
18+20+20+42+50	1.20	1.33	1.33	2.80	3.33	10.00 (3.90-10.80)	3.510 (0.840-3.910)	15.42	99
18+20+20+42+60	1.13	1.25	1.25	2.63	3.75	10.00 (3.90-10.80)	3.480 (0.840-3.900)	15.28	99
18+20+20+42+71	1.05	1.17	1.17	2.46	4.15	10.00 (3.90-10.80)	3.460 (0.840-3.890)	15.20	99
18+20+20+50+50	1.14	1.27	1.27	3.16	3.16	10.00 (3.90-10.80)	3.500 (0.840-3.900)	15.37	99
18+20+20+50+60	1.07	1.19	1.19	2.98	3.57	10.00 (3.90-10.80)	3.470 (0.840-3.890)	15.24	99
18+20+22+22+22	1.75	1.94	2.14	2.14	2.14	10.10 (3.90-10.90)	3.700 (0.810-3.970)	16.25	99
18+20+22+22+25	1.70	1.89	2.08	2.08	2.36	10.10 (3.90-10.90)	3.700 (0.810-3.970)	16.25	99
18+20+22+22+35	1.55	1.73	1.90	1.90	3.02	10.10 (3.90-10.90)	3.700 (0.810-3.970)	16.25	99
18+20+22+22+42	1.47	1.63	1.79	1.79	3.42	10.10 (3.90-10.90)	3.680 (0.810-3.960)	16.16	99
18+20+22+22+50	1.38	1.53	1.68	1.68	3.83	10.10 (3.90-10.90)	3.670 (0.810-3.950)	16.12	99
18+20+22+22+60	1.28	1.42	1.56	1.56	4.27	10.10 (3.90-10.90)	3.640 (0.810-3.940)	15.99	99
18+20+22+22+71	1.19	1.32	1.45	1.45	4.69	10.10 (3.90-10.90)	3.620 (0.810-3.930)	15.90	99
18+20+22+25+25	1.65	1.84	2.02	2.30	2.30	10.10 (3.90-10.90)	3.700 (0.810-3.970)	16.25	99

MXZ-5D102VA COOLING

Indoor units combination	Cooling capacity (kW)						Outdoor unit power consumption(kW)	Current (A)	Power factor(%)
	Unit A	Unit B	Unit C	Unit D	Unit E	Total			
18+20+22+25+35	1.52	1.68	1.85	2.10	2.95	10.10 (3.90-10.90)	3.700 (0.810-3.970)	16.25	99
18+20+22+25+42	1.43	1.59	1.75	1.99	3.34	10.10 (3.90-10.90)	3.680 (0.810-3.960)	16.16	99
18+20+22+25+50	1.35	1.50	1.65	1.87	3.74	10.10 (3.90-10.90)	3.670 (0.810-3.950)	16.12	99
18+20+22+25+60	1.25	1.39	1.53	1.74	4.18	10.10 (3.90-10.90)	3.640 (0.810-3.940)	15.99	99
18+20+22+25+71	1.17	1.29	1.42	1.62	4.60	10.10 (3.90-10.90)	3.620 (0.810-3.930)	15.90	99
18+20+22+35+35	1.40	1.55	1.71	2.72	2.72	10.10 (3.90-10.90)	3.700 (0.810-3.970)	16.25	99
18+20+22+35+42	1.33	1.47	1.62	2.58	3.10	10.10 (3.90-10.90)	3.680 (0.810-3.960)	16.16	99
18+20+22+35+50	1.25	1.39	1.53	2.44	3.48	10.10 (3.90-10.90)	3.670 (0.810-3.950)	16.12	99
18+20+22+35+60	1.17	1.30	1.43	2.28	3.91	10.10 (3.90-10.90)	3.640 (0.810-3.940)	15.99	99
18+20+22+35+71	1.10	1.22	1.34	2.13	4.32	10.10 (3.90-10.90)	3.620 (0.810-3.930)	15.90	99
18+20+22+42+42	1.26	1.40	1.54	2.95	2.95	10.10 (3.90-10.90)	3.660 (0.810-3.950)	16.07	99
18+20+22+42+50	1.20	1.33	1.46	2.79	3.32	10.10 (3.90-10.90)	3.650 (0.810-3.940)	16.03	99
18+20+22+42+60	1.12	1.25	1.37	2.62	3.74	10.10 (3.90-10.90)	3.620 (0.810-3.930)	15.90	99
18+20+22+50+50	1.14	1.26	1.39	3.16	3.16	10.10 (3.90-10.90)	3.640 (0.810-3.930)	15.99	99
18+20+22+50+60	1.07	1.19	1.31	2.97	3.56	10.10 (3.90-10.90)	3.610 (0.810-3.920)	15.85	99
18+20+25+25+25	1.61	1.79	2.23	2.23	2.23	10.10 (3.90-10.90)	3.700 (0.810-3.970)	16.25	99
18+20+25+25+35	1.48	1.64	2.05	2.05	2.87	10.10 (3.90-10.90)	3.700 (0.810-3.970)	16.25	99
18+20+25+25+42	1.40	1.55	1.94	1.94	3.26	10.10 (3.90-10.90)	3.680 (0.810-3.960)	16.16	99
18+20+25+25+50	1.32	1.46	1.83	1.83	3.66	10.10 (3.90-10.90)	3.670 (0.810-3.950)	16.12	99
18+20+25+25+60	1.23	1.36	1.71	1.71	4.09	10.10 (3.90-10.90)	3.640 (0.810-3.940)	15.99	99
18+20+25+25+71	1.14	1.27	1.59	1.59	4.51	10.10 (3.90-10.90)	3.620 (0.810-3.930)	15.90	99
18+20+25+35+35	1.37	1.52	1.90	2.66	2.66	10.10 (3.90-10.90)	3.700 (0.810-3.970)	16.25	99
18+20+25+35+42	1.30	1.44	1.80	2.53	3.03	10.10 (3.90-10.90)	3.680 (0.810-3.960)	16.16	99
18+20+25+35+50	1.23	1.36	1.71	2.39	3.41	10.10 (3.90-10.90)	3.670 (0.810-3.950)	16.12	99
18+20+25+35+60	1.15	1.28	1.60	2.24	3.84	10.10 (3.90-10.90)	3.640 (0.810-3.940)	15.99	99
18+20+25+35+71	1.08	1.20	1.49	2.09	4.24	10.10 (3.90-10.90)	3.620 (0.810-3.930)	15.90	99
18+20+25+42+42	1.24	1.37	1.72	2.89	2.89	10.10 (3.90-10.90)	3.660 (0.810-3.950)	16.07	99
18+20+25+42+50	1.17	1.30	1.63	2.74	3.26	10.10 (3.90-10.90)	3.650 (0.810-3.940)	16.03	99
18+20+25+42+60	1.10	1.22	1.53	2.57	3.67	10.10 (3.90-10.90)	3.620 (0.810-3.930)	15.90	99
18+20+25+50+50	1.12	1.24	1.55	3.10	3.10	10.10 (3.90-10.90)	3.640 (0.810-3.930)	15.99	99
18+20+35+35+35	1.27	1.41	2.47	2.47	2.47	10.10 (3.90-10.90)	3.700 (0.810-3.970)	16.25	99
18+20+35+35+42	1.21	1.35	2.36	2.36	2.83	10.10 (3.90-10.90)	3.680 (0.810-3.960)	16.16	99
18+20+35+35+50	1.15	1.28	2.24	2.24	3.20	10.10 (3.90-10.90)	3.670 (0.810-3.950)	16.12	99
18+20+35+35+60	1.08	1.20	2.10	2.10	3.61	10.10 (3.90-10.90)	3.640 (0.810-3.940)	15.99	99
18+20+35+42+42	1.16	1.29	2.25	2.70	2.70	10.10 (3.90-10.90)	3.660 (0.810-3.950)	16.07	99
18+20+35+42+50	1.10	1.22	2.14	2.57	3.06	10.10 (3.90-10.90)	3.650 (0.810-3.940)	16.03	99
18+20+42+42+42	1.11	1.23	2.59	2.59	2.59	10.10 (3.90-10.90)	3.640 (0.810-3.940)	15.99	99
18+20+42+42+50	1.06	1.17	2.47	2.47	2.94	10.10 (3.90-10.90)	3.630 (0.810-3.930)	15.94	99
18+22+22+22+22	1.73	2.12	2.12	2.12	2.12	10.20 (3.90-11.00)	3.840 (0.780-4.000)	16.86	99
18+22+22+22+25	1.68	2.06	2.06	2.06	2.34	10.20 (3.90-11.00)	3.840 (0.780-4.000)	16.86	99
18+22+22+22+35	1.54	1.89	1.89	1.89	3.00	10.20 (3.90-11.00)	3.840 (0.780-4.000)	16.86	99

MXZ-5D102VA COOLING

Indoor units combination	Cooling capacity (kW)						Outdoor unit power consumption(kW)	Current (A)	Power factor(%)
	Unit A	Unit B	Unit C	Unit D	Unit E	Total			
18+22+22+22+42	1.46	1.78	1.78	1.78	3.40	10.20 (3.90-11.00)	3.820 (0.780-3.990)	16.78	99
18+22+22+22+50	1.37	1.67	1.67	1.67	3.81	10.20 (3.90-11.00)	3.810 (0.780-3.980)	16.73	99
18+22+22+22+60	1.28	1.56	1.56	1.56	4.25	10.20 (3.90-11.00)	3.780 (0.780-3.970)	16.60	99
18+22+22+22+71	1.18	1.45	1.45	1.45	4.67	10.20 (3.90-11.00)	3.760 (0.780-3.960)	16.51	99
18+22+22+25+25	1.64	2.00	2.00	2.28	2.28	10.20 (3.90-11.00)	3.840 (0.780-4.000)	16.86	99
18+22+22+25+35	1.50	1.84	1.84	2.09	2.93	10.20 (3.90-11.00)	3.840 (0.780-4.000)	16.86	99
18+22+22+25+42	1.42	1.74	1.74	1.98	3.32	10.20 (3.90-11.00)	3.820 (0.780-3.990)	16.78	99
18+22+22+25+50	1.34	1.64	1.64	1.86	3.72	10.20 (3.90-11.00)	3.810 (0.780-3.980)	16.73	99
18+22+22+25+60	1.25	1.53	1.53	1.73	4.16	10.20 (3.90-11.00)	3.780 (0.780-3.970)	16.60	99
18+22+22+25+71	1.16	1.42	1.42	1.61	4.58	10.20 (3.90-11.00)	3.760 (0.780-3.960)	16.51	99
18+22+22+35+35	1.39	1.70	1.70	2.70	2.70	10.20 (3.90-11.00)	3.840 (0.780-4.000)	16.86	99
18+22+22+35+42	1.32	1.61	1.61	2.57	3.08	10.20 (3.90-11.00)	3.820 (0.780-3.990)	16.78	99
18+22+22+35+50	1.25	1.53	1.53	2.43	3.47	10.20 (3.90-11.00)	3.810 (0.780-3.980)	16.73	99
18+22+22+35+60	1.17	1.43	1.43	2.27	3.90	10.20 (3.90-11.00)	3.780 (0.780-3.970)	16.60	99
18+22+22+35+71	1.09	1.34	1.34	2.13	4.31	10.20 (3.90-11.00)	3.760 (0.780-3.960)	16.51	99
18+22+22+42+42	1.26	1.54	1.54	2.93	2.93	10.20 (3.90-11.00)	3.800 (0.780-3.980)	16.69	99
18+22+22+42+50	1.19	1.46	1.46	2.78	3.31	10.20 (3.90-11.00)	3.790 (0.780-3.970)	16.64	99
18+22+22+42+60	1.12	1.37	1.37	2.61	3.73	10.20 (3.90-11.00)	3.760 (0.780-3.960)	16.51	99
18+22+22+50+50	1.13	1.39	1.39	3.15	3.15	10.20 (3.90-11.00)	3.780 (0.780-3.960)	16.60	99
18+22+22+50+60	1.07	1.30	1.30	2.97	3.56	10.20 (3.90-11.00)	3.750 (0.780-3.950)	16.47	99
18+22+25+25+25	1.60	1.95	2.22	2.22	2.22	10.20 (3.90-11.00)	3.840 (0.780-4.000)	16.86	99
18+22+25+25+35	1.47	1.80	2.04	2.04	2.86	10.20 (3.90-11.00)	3.840 (0.780-4.000)	16.86	99
18+22+25+25+42	1.39	1.70	1.93	1.93	3.25	10.20 (3.90-11.00)	3.820 (0.780-3.990)	16.78	99
18+22+25+25+50	1.31	1.60	1.82	1.82	3.64	10.20 (3.90-11.00)	3.810 (0.780-3.980)	16.73	99
18+22+25+25+60	1.22	1.50	1.70	1.70	4.08	10.20 (3.90-11.00)	3.780 (0.780-3.970)	16.60	99
18+22+25+25+71	1.14	1.39	1.58	1.58	4.50	10.20 (3.90-11.00)	3.760 (0.780-3.960)	16.51	99
18+22+25+35+35	1.36	1.66	1.89	2.64	2.64	10.20 (3.90-11.00)	3.840 (0.780-4.000)	16.86	99
18+22+25+35+42	1.29	1.58	1.80	2.51	3.02	10.20 (3.90-11.00)	3.820 (0.780-3.990)	16.78	99
18+22+25+35+50	1.22	1.50	1.70	2.38	3.40	10.20 (3.90-11.00)	3.810 (0.780-3.980)	16.73	99
18+22+25+35+60	1.15	1.40	1.59	2.23	3.83	10.20 (3.90-11.00)	3.780 (0.780-3.970)	16.60	99
18+22+25+35+71	1.07	1.31	1.49	2.09	4.24	10.20 (3.90-11.00)	3.760 (0.780-3.960)	16.51	99
18+22+25+42+42	1.23	1.51	1.71	2.88	2.88	10.20 (3.90-11.00)	3.800 (0.780-3.980)	16.69	99
18+22+25+42+50	1.17	1.43	1.62	2.73	3.25	10.20 (3.90-11.00)	3.790 (0.780-3.970)	16.64	99
18+22+25+42+60	1.10	1.34	1.53	2.57	3.66	10.20 (3.90-11.00)	3.760 (0.780-3.960)	16.51	99
18+22+25+50+50	1.11	1.36	1.55	3.09	3.09	10.20 (3.90-11.00)	3.780 (0.780-3.960)	16.60	99
18+22+35+35+35	1.27	1.55	2.46	2.46	2.46	10.20 (3.90-11.00)	3.840 (0.780-4.000)	16.86	99
18+22+35+35+42	1.21	1.48	2.35	2.35	2.82	10.20 (3.90-11.00)	3.820 (0.780-3.990)	16.78	99
18+22+35+35+50	1.15	1.40	2.23	2.23	3.19	10.20 (3.90-11.00)	3.810 (0.780-3.980)	16.73	99
18+22+35+35+60	1.08	1.32	2.10	2.10	3.60	10.20 (3.90-11.00)	3.780 (0.780-3.970)	16.60	99
18+22+35+42+42	1.15	1.41	2.25	2.69	2.69	10.20 (3.90-11.00)	3.800 (0.780-3.980)	16.69	99
18+22+35+42+50	1.10	1.34	2.14	2.57	3.05	10.20 (3.90-11.00)	3.790 (0.780-3.970)	16.64	99

MXZ-5D102VA COOLING

Indoor units combination	Cooling capacity (kW)						Outdoor unit power consumption(kW)	Current (A)	Power factor(%)
	Unit A	Unit B	Unit C	Unit D	Unit E	Total			
18+22+42+42+42	1.11	1.35	2.58	2.58	2.58	10.20 (3.90-11.00)	3.780 (0.780-3.970)	16.60	99
18+25+25+25+25	1.56	2.16	2.16	2.16	2.16	10.20 (3.90-11.00)	3.840 (0.780-4.000)	16.86	99
18+25+25+25+35	1.43	1.99	1.99	1.99	2.79	10.20 (3.90-11.00)	3.840 (0.780-4.000)	16.86	99
18+25+25+25+42	1.36	1.89	1.89	1.89	3.17	10.20 (3.90-11.00)	3.820 (0.780-3.990)	16.78	99
18+25+25+25+50	1.28	1.78	1.78	1.78	3.57	10.20 (3.90-11.00)	3.810 (0.780-3.980)	16.73	99
18+25+25+25+60	1.20	1.67	1.67	1.67	4.00	10.20 (3.90-11.00)	3.780 (0.780-3.970)	16.60	99
18+25+25+25+71	1.12	1.55	1.55	1.55	4.42	10.20 (3.90-11.00)	3.760 (0.780-3.960)	16.51	99
18+25+25+35+35	1.33	1.85	1.85	2.59	2.59	10.20 (3.90-11.00)	3.840 (0.780-4.000)	16.86	99
18+25+25+35+42	1.27	1.76	1.76	2.46	2.95	10.20 (3.90-11.00)	3.820 (0.780-3.990)	16.78	99
18+25+25+35+50	1.20	1.67	1.67	2.33	3.33	10.20 (3.90-11.00)	3.810 (0.780-3.980)	16.73	99
18+25+25+35+60	1.13	1.56	1.56	2.19	3.75	10.20 (3.90-11.00)	3.780 (0.780-3.970)	16.60	99
18+25+25+42+42	1.21	1.68	1.68	2.82	2.82	10.20 (3.90-11.00)	3.800 (0.780-3.980)	16.69	99
18+25+25+42+50	1.15	1.59	1.59	2.68	3.19	10.20 (3.90-11.00)	3.790 (0.780-3.970)	16.64	99
18+25+25+42+60	1.08	1.50	1.50	2.52	3.60	10.20 (3.90-11.00)	3.760 (0.780-3.960)	16.51	99
18+25+25+50+50	1.09	1.52	1.52	3.04	3.04	10.20 (3.90-11.00)	3.780 (0.780-3.960)	16.60	99
18+25+35+35+35	1.24	1.72	2.41	2.41	2.41	10.20 (3.90-11.00)	3.840 (0.780-4.000)	16.86	99
18+25+35+35+42	1.18	1.65	2.30	2.30	2.76	10.20 (3.90-11.00)	3.820 (0.780-3.990)	16.78	99
18+25+35+35+50	1.13	1.56	2.19	2.19	3.13	10.20 (3.90-11.00)	3.810 (0.780-3.980)	16.73	99
18+25+35+42+42	1.13	1.57	2.20	2.64	2.64	10.20 (3.90-11.00)	3.800 (0.780-3.980)	16.69	99
18+25+35+42+50	1.08	1.50	2.10	2.52	3.00	10.20 (3.90-11.00)	3.790 (0.780-3.970)	16.64	99
18+25+42+42+42	1.09	1.51	2.53	2.53	2.53	10.20 (3.90-11.00)	3.780 (0.780-3.970)	16.60	99
18+35+35+35+35	1.16	2.26	2.26	2.26	2.26	10.20 (3.90-11.00)	3.840 (0.780-4.000)	16.86	99
18+35+35+35+42	1.11	2.16	2.16	2.16	2.60	10.20 (3.90-11.00)	3.820 (0.780-3.990)	16.78	99
18+35+35+42+42	1.07	2.08	2.08	2.49	2.49	10.20 (3.90-11.00)	3.800 (0.780-3.980)	16.69	99
20+20+20+20+20	1.90	1.90	1.90	1.90	1.90	9.50 (3.90-10.50)	3.065 (0.930-3.850)	13.46	99
20+20+20+20+25	1.87	1.87	1.87	1.87	2.33	9.80 (3.90-10.60)	3.280 (0.900-3.880)	14.40	99
20+20+20+20+35	1.70	1.70	1.70	1.70	2.98	9.80 (3.90-10.60)	3.280 (0.900-3.880)	14.40	99
20+20+20+20+42	1.61	1.61	1.61	1.61	3.37	9.80 (3.90-10.60)	3.260 (0.900-3.870)	14.32	99
20+20+20+20+50	1.51	1.51	1.51	1.51	3.77	9.80 (3.90-10.60)	3.250 (0.900-3.860)	14.27	99
20+20+20+20+60	1.40	1.40	1.40	1.40	4.20	9.80 (3.90-10.60)	3.220 (0.900-3.850)	14.14	99
20+20+20+20+71	1.30	1.30	1.30	1.30	4.61	9.80 (3.90-10.60)	3.200 (0.900-3.840)	14.05	99
20+20+20+22+22	1.90	1.90	1.90	2.09	2.09	9.90 (3.90-10.70)	3.420 (0.870-3.910)	15.02	99
20+20+20+22+25	1.85	1.85	1.85	2.04	2.31	9.90 (3.90-10.70)	3.420 (0.870-3.910)	15.02	99
20+20+20+22+35	1.69	1.69	1.69	1.86	2.96	9.90 (3.90-10.70)	3.420 (0.870-3.910)	15.02	99
20+20+20+22+42	1.60	1.60	1.60	1.76	3.35	9.90 (3.90-10.70)	3.400 (0.870-3.900)	14.93	99
20+20+20+22+50	1.50	1.50	1.50	1.65	3.75	9.90 (3.90-10.70)	3.390 (0.870-3.890)	14.89	99
20+20+20+22+60	1.39	1.39	1.39	1.53	4.18	9.90 (3.90-10.70)	3.360 (0.870-3.880)	14.76	99
20+20+20+22+71	1.29	1.29	1.29	1.42	4.59	9.90 (3.90-10.70)	3.340 (0.870-3.870)	14.67	99
20+20+20+25+25	1.80	1.80	1.80	2.25	2.25	9.90 (3.90-10.70)	3.420 (0.870-3.910)	15.02	99
20+20+20+25+35	1.65	1.65	1.65	2.06	2.89	9.90 (3.90-10.70)	3.420 (0.870-3.910)	15.02	99
20+20+20+25+42	1.56	1.56	1.56	1.95	3.27	9.90 (3.90-10.70)	3.400 (0.870-3.900)	14.93	99

MXZ-5D102VA COOLING

Indoor units combination	Cooling capacity (kW)						Outdoor unit power consumption(kW)	Current (A)	Power factor(%)
	Unit A	Unit B	Unit C	Unit D	Unit E	Total			
20+20+20+25+50	1.47	1.47	1.47	1.83	3.67	9.90 (3.90-10.70)	3.390 (0.870-3.890)	14.89	99
20+20+20+25+60	1.37	1.37	1.37	1.71	4.10	9.90 (3.90-10.70)	3.360 (0.870-3.880)	14.76	99
20+20+20+25+71	1.27	1.27	1.27	1.59	4.51	9.90 (3.90-10.70)	3.340 (0.870-3.870)	14.67	99
20+20+20+35+35	1.52	1.52	1.52	2.67	2.67	9.90 (3.90-10.70)	3.420 (0.870-3.910)	15.02	99
20+20+20+35+42	1.45	1.45	1.45	2.53	3.04	9.90 (3.90-10.70)	3.400 (0.870-3.900)	14.93	99
20+20+20+35+50	1.37	1.37	1.37	2.39	3.41	9.90 (3.90-10.70)	3.390 (0.870-3.890)	14.89	99
20+20+20+35+60	1.28	1.28	1.28	2.24	3.83	9.90 (3.90-10.70)	3.360 (0.870-3.880)	14.76	99
20+20+20+35+71	1.19	1.19	1.19	2.09	4.23	9.90 (3.90-10.70)	3.340 (0.870-3.870)	14.67	99
20+20+20+42+42	1.38	1.38	1.38	2.89	2.89	9.90 (3.90-10.70)	3.380 (0.870-3.890)	14.84	99
20+20+20+42+50	1.30	1.30	1.30	2.74	3.26	9.90 (3.90-10.70)	3.370 (0.870-3.880)	14.80	99
20+20+20+42+60	1.22	1.22	1.22	2.57	3.67	9.90 (3.90-10.70)	3.340 (0.870-3.870)	14.67	99
20+20+20+50+50	1.24	1.24	1.24	3.09	3.09	9.90 (3.90-10.70)	3.360 (0.870-3.870)	14.76	99
20+20+20+50+60	1.16	1.16	1.16	2.91	3.49	9.90 (3.90-10.70)	3.330 (0.870-3.860)	14.62	99
20+20+22+22+22	1.89	1.89	2.08	2.08	2.08	10.00 (3.90-10.80)	3.560 (0.840-3.940)	15.63	99
20+20+22+22+25	1.83	1.83	2.02	2.02	2.29	10.00 (3.90-10.80)	3.560 (0.840-3.940)	15.63	99
20+20+22+22+35	1.68	1.68	1.85	1.85	2.94	10.00 (3.90-10.80)	3.560 (0.840-3.940)	15.63	99
20+20+22+22+42	1.59	1.59	1.75	1.75	3.33	10.00 (3.90-10.80)	3.540 (0.840-3.930)	15.55	99
20+20+22+22+50	1.49	1.49	1.64	1.64	3.73	10.00 (3.90-10.80)	3.530 (0.840-3.920)	15.50	99
20+20+22+22+60	1.39	1.39	1.53	1.53	4.17	10.00 (3.90-10.80)	3.500 (0.840-3.910)	15.37	99
20+20+22+22+71	1.29	1.29	1.42	1.42	4.58	10.00 (3.90-10.80)	3.480 (0.840-3.900)	15.28	99
20+20+22+25+25	1.79	1.79	1.96	2.23	2.23	10.00 (3.90-10.80)	3.560 (0.840-3.940)	15.63	99
20+20+22+25+35	1.64	1.64	1.80	2.05	2.87	10.00 (3.90-10.80)	3.560 (0.840-3.940)	15.63	99
20+20+22+25+42	1.55	1.55	1.71	1.94	3.26	10.00 (3.90-10.80)	3.540 (0.840-3.930)	15.55	99
20+20+22+25+50	1.46	1.46	1.61	1.82	3.65	10.00 (3.90-10.80)	3.530 (0.840-3.920)	15.50	99
20+20+22+25+60	1.36	1.36	1.50	1.70	4.08	10.00 (3.90-10.80)	3.500 (0.840-3.910)	15.37	99
20+20+22+25+71	1.27	1.27	1.39	1.58	4.49	10.00 (3.90-10.80)	3.480 (0.840-3.900)	15.28	99
20+20+22+35+35	1.52	1.52	1.67	2.65	2.65	10.00 (3.90-10.80)	3.560 (0.840-3.940)	15.63	99
20+20+22+35+42	1.44	1.44	1.58	2.52	3.02	10.00 (3.90-10.80)	3.540 (0.840-3.930)	15.55	99
20+20+22+35+50	1.36	1.36	1.50	2.38	3.40	10.00 (3.90-10.80)	3.530 (0.840-3.920)	15.50	99
20+20+22+35+60	1.27	1.27	1.40	2.23	3.82	10.00 (3.90-10.80)	3.500 (0.840-3.910)	15.37	99
20+20+22+35+71	1.19	1.19	1.31	2.08	4.23	10.00 (3.90-10.80)	3.480 (0.840-3.900)	15.28	99
20+20+22+42+42	1.37	1.37	1.51	2.88	2.88	10.00 (3.90-10.80)	3.520 (0.840-3.920)	15.46	99
20+20+22+42+50	1.30	1.30	1.43	2.73	3.25	10.00 (3.90-10.80)	3.510 (0.840-3.910)	15.42	99
20+20+22+42+60	1.22	1.22	1.34	2.56	3.66	10.00 (3.90-10.80)	3.480 (0.840-3.900)	15.28	99
20+20+22+50+50	1.23	1.23	1.36	3.09	3.09	10.00 (3.90-10.80)	3.500 (0.840-3.900)	15.37	99
20+20+22+50+60	1.16	1.16	1.28	2.91	3.49	10.00 (3.90-10.80)	3.470 (0.840-3.890)	15.24	99
20+20+25+25+25	1.74	1.74	2.17	2.17	2.17	10.00 (3.90-10.80)	3.560 (0.840-3.940)	15.63	99
20+20+25+25+35	1.60	1.60	2.00	2.00	2.80	10.00 (3.90-10.80)	3.560 (0.840-3.940)	15.63	99
20+20+25+25+42	1.52	1.52	1.89	1.89	3.18	10.00 (3.90-10.80)	3.540 (0.840-3.930)	15.55	99
20+20+25+25+50	1.43	1.43	1.79	1.79	3.57	10.00 (3.90-10.80)	3.530 (0.840-3.920)	15.50	99
20+20+25+25+60	1.33	1.33	1.67	1.67	4.00	10.00 (3.90-10.80)	3.500 (0.840-3.910)	15.37	99

MXZ-5D102VA COOLING

Indoor units combination	Cooling capacity (kW)					Outdoor unit power consumption(kW)	Current (A)	Power factor(%)	
	Unit A	Unit B	Unit C	Unit D	Unit E				Total
20+20+25+25+71	1.24	1.24	1.55	1.55	4.41	10.00 (3.90-10.80)	3.480 (0.840-3.900)	15.28	99
20+20+25+35+35	1.48	1.48	1.85	2.59	2.59	10.00 (3.90-10.80)	3.560 (0.840-3.940)	15.63	99
20+20+25+35+42	1.41	1.41	1.76	2.46	2.96	10.00 (3.90-10.80)	3.540 (0.840-3.930)	15.55	99
20+20+25+35+50	1.33	1.33	1.67	2.33	3.33	10.00 (3.90-10.80)	3.530 (0.840-3.920)	15.50	99
20+20+25+35+60	1.25	1.25	1.56	2.19	3.75	10.00 (3.90-10.80)	3.500 (0.840-3.910)	15.37	99
20+20+25+35+71	1.17	1.17	1.46	2.05	4.15	10.00 (3.90-10.80)	3.480 (0.840-3.900)	15.28	99
20+20+25+42+42	1.34	1.34	1.68	2.82	2.82	10.00 (3.90-10.80)	3.520 (0.840-3.920)	15.46	99
20+20+25+42+50	1.27	1.27	1.59	2.68	3.18	10.00 (3.90-10.80)	3.510 (0.840-3.910)	15.42	99
20+20+25+42+60	1.20	1.20	1.50	2.51	3.59	10.00 (3.90-10.80)	3.480 (0.840-3.900)	15.28	99
20+20+25+50+50	1.21	1.21	1.52	3.03	3.03	10.00 (3.90-10.80)	3.500 (0.840-3.900)	15.37	99
20+20+35+35+35	1.38	1.38	2.41	2.41	2.41	10.00 (3.90-10.80)	3.560 (0.840-3.940)	15.63	99
20+20+35+35+42	1.32	1.32	2.30	2.30	2.76	10.00 (3.90-10.80)	3.540 (0.840-3.930)	15.55	99
20+20+35+35+50	1.25	1.25	2.19	2.19	3.13	10.00 (3.90-10.80)	3.530 (0.840-3.920)	15.50	99
20+20+35+35+60	1.18	1.18	2.06	2.06	3.53	10.00 (3.90-10.80)	3.500 (0.840-3.910)	15.37	99
20+20+35+42+42	1.26	1.26	2.20	2.64	2.64	10.00 (3.90-10.80)	3.520 (0.840-3.920)	15.46	99
20+20+35+42+50	1.20	1.20	2.10	2.51	2.99	10.00 (3.90-10.80)	3.510 (0.840-3.910)	15.42	99
20+20+42+42+42	1.20	1.20	2.53	2.53	2.53	10.00 (3.90-10.80)	3.500 (0.840-3.910)	15.37	99
20+22+22+22+22	1.87	2.06	2.06	2.06	2.06	10.10 (3.90-10.90)	3.700 (0.810-3.970)	16.25	99
20+22+22+22+25	1.82	2.00	2.00	2.00	2.27	10.10 (3.90-10.90)	3.700 (0.810-3.970)	16.25	99
20+22+22+22+35	1.67	1.84	1.84	1.84	2.92	10.10 (3.90-10.90)	3.700 (0.810-3.970)	16.25	99
20+22+22+22+42	1.58	1.74	1.74	1.74	3.31	10.10 (3.90-10.90)	3.680 (0.810-3.960)	16.16	99
20+22+22+22+50	1.49	1.63	1.63	1.63	3.71	10.10 (3.90-10.90)	3.670 (0.810-3.950)	16.12	99
20+22+22+22+60	1.38	1.52	1.52	1.52	4.15	10.10 (3.90-10.90)	3.640 (0.810-3.940)	15.99	99
20+22+22+22+71	1.29	1.42	1.42	1.42	4.57	10.10 (3.90-10.90)	3.620 (0.810-3.930)	15.90	99
20+22+22+25+25	1.77	1.95	1.95	2.21	2.21	10.10 (3.90-10.90)	3.700 (0.810-3.970)	16.25	99
20+22+22+25+35	1.63	1.79	1.79	2.04	2.85	10.10 (3.90-10.90)	3.700 (0.810-3.970)	16.25	99
20+22+22+25+42	1.54	1.70	1.70	1.93	3.24	10.10 (3.90-10.90)	3.680 (0.810-3.960)	16.16	99
20+22+22+25+50	1.45	1.60	1.60	1.82	3.63	10.10 (3.90-10.90)	3.670 (0.810-3.950)	16.12	99
20+22+22+25+60	1.36	1.49	1.49	1.69	4.07	10.10 (3.90-10.90)	3.640 (0.810-3.940)	15.99	99
20+22+22+25+71	1.26	1.39	1.39	1.58	4.48	10.10 (3.90-10.90)	3.620 (0.810-3.930)	15.90	99
20+22+22+35+35	1.51	1.66	1.66	2.64	2.64	10.10 (3.90-10.90)	3.700 (0.810-3.970)	16.25	99
20+22+22+35+42	1.43	1.58	1.58	2.51	3.01	10.10 (3.90-10.90)	3.680 (0.810-3.960)	16.16	99
20+22+22+35+50	1.36	1.49	1.49	2.37	3.39	10.10 (3.90-10.90)	3.670 (0.810-3.950)	16.12	99
20+22+22+35+60	1.27	1.40	1.40	2.22	3.81	10.10 (3.90-10.90)	3.640 (0.810-3.940)	15.99	99
20+22+22+35+71	1.19	1.31	1.31	2.08	4.22	10.10 (3.90-10.90)	3.620 (0.810-3.930)	15.90	99
20+22+22+42+42	1.36	1.50	1.50	2.87	2.87	10.10 (3.90-10.90)	3.660 (0.810-3.950)	16.07	99
20+22+22+42+50	1.29	1.42	1.42	2.72	3.24	10.10 (3.90-10.90)	3.650 (0.810-3.940)	16.03	99
20+22+22+42+60	1.22	1.34	1.34	2.56	3.65	10.10 (3.90-10.90)	3.620 (0.810-3.930)	15.90	99
20+22+22+50+50	1.23	1.35	1.35	3.08	3.08	10.10 (3.90-10.90)	3.640 (0.810-3.930)	15.99	99
20+22+25+25+25	1.73	1.90	2.16	2.16	2.16	10.10 (3.90-10.90)	3.700 (0.810-3.970)	16.25	99
MXZ+22+25+25+35	1.59	1.75	1.99	1.99	2.78	10.10 (3.90-10.90)	3.700 (0.810-3.970)	16.25	99

MXZ-5D102VA COOLING

Indoor units combination	Cooling capacity (kW)						Outdoor unit power consumption(kW)	Current (A)	Power factor(%)
	Unit A	Unit B	Unit C	Unit D	Unit E	Total			
20+22+25+25+42	1.51	1.66	1.88	1.88	3.17	10.10 (3.90-10.90)	3.680 (0.810-3.960)	16.16	99
20+22+25+25+50	1.42	1.56	1.78	1.78	3.56	10.10 (3.90-10.90)	3.670 (0.810-3.950)	16.12	99
20+22+25+25+60	1.33	1.46	1.66	1.66	3.99	10.10 (3.90-10.90)	3.640 (0.810-3.940)	15.99	99
20+22+25+25+71	1.24	1.36	1.55	1.55	4.40	10.10 (3.90-10.90)	3.620 (0.810-3.930)	15.90	99
20+22+25+35+35	1.47	1.62	1.84	2.58	2.58	10.10 (3.90-10.90)	3.700 (0.810-3.970)	16.25	99
20+22+25+35+42	1.40	1.54	1.75	2.45	2.95	10.10 (3.90-10.90)	3.680 (0.810-3.960)	16.16	99
20+22+25+35+50	1.33	1.46	1.66	2.33	3.32	10.10 (3.90-10.90)	3.670 (0.810-3.950)	16.12	99
20+22+25+35+60	1.25	1.37	1.56	2.18	3.74	10.10 (3.90-10.90)	3.640 (0.810-3.940)	15.99	99
20+22+25+42+42	1.34	1.47	1.67	2.81	2.81	10.10 (3.90-10.90)	3.660 (0.810-3.950)	16.07	99
20+22+25+42+50	1.27	1.40	1.59	2.67	3.18	10.10 (3.90-10.90)	3.650 (0.810-3.940)	16.03	99
20+22+25+42+60	1.20	1.31	1.49	2.51	3.59	10.10 (3.90-10.90)	3.620 (0.810-3.930)	15.90	99
20+22+25+50+50	1.21	1.33	1.51	3.02	3.02	10.10 (3.90-10.90)	3.640 (0.810-3.930)	15.99	99
20+22+35+35+35	1.37	1.51	2.40	2.40	2.40	10.10 (3.90-10.90)	3.700 (0.810-3.970)	16.25	99
20+22+35+35+42	1.31	1.44	2.30	2.30	2.75	10.10 (3.90-10.90)	3.680 (0.810-3.960)	16.16	99
20+22+35+35+50	1.25	1.37	2.18	2.18	3.12	10.10 (3.90-10.90)	3.670 (0.810-3.950)	16.12	99
20+22+35+35+60	1.17	1.29	2.06	2.06	3.52	10.10 (3.90-10.90)	3.640 (0.810-3.940)	15.99	99
20+22+35+42+42	1.25	1.38	2.20	2.63	2.63	10.10 (3.90-10.90)	3.660 (0.810-3.950)	16.07	99
20+22+35+42+50	1.20	1.31	2.09	2.51	2.99	10.10 (3.90-10.90)	3.650 (0.810-3.940)	16.03	99
20+22+42+42+42	1.20	1.32	2.53	2.53	2.53	10.10 (3.90-10.90)	3.640 (0.810-3.940)	15.99	99
20+25+25+25+25	1.68	2.10	2.10	2.10	2.10	10.10 (3.90-10.90)	3.700 (0.810-3.970)	16.25	99
20+25+25+25+35	1.55	1.94	1.94	1.94	2.72	10.10 (3.90-10.90)	3.700 (0.810-3.970)	16.25	99
20+25+25+25+42	1.47	1.84	1.84	1.84	3.10	10.10 (3.90-10.90)	3.680 (0.810-3.960)	16.16	99
20+25+25+25+50	1.39	1.74	1.74	1.74	3.48	10.10 (3.90-10.90)	3.670 (0.810-3.950)	16.12	99
20+25+25+25+60	1.30	1.63	1.63	1.63	3.91	10.10 (3.90-10.90)	3.640 (0.810-3.940)	15.99	99
20+25+25+25+71	1.22	1.52	1.52	1.52	4.32	10.10 (3.90-10.90)	3.620 (0.810-3.930)	15.90	99
20+25+25+35+35	1.44	1.80	1.80	2.53	2.53	10.10 (3.90-10.90)	3.700 (0.810-3.970)	16.25	99
20+25+25+35+42	1.37	1.72	1.72	2.40	2.89	10.10 (3.90-10.90)	3.680 (0.810-3.960)	16.16	99
20+25+25+35+50	1.30	1.63	1.63	2.28	3.26	10.10 (3.90-10.90)	3.670 (0.810-3.950)	16.12	99
20+25+25+35+60	1.22	1.53	1.53	2.14	3.67	10.10 (3.90-10.90)	3.640 (0.810-3.940)	15.99	99
20+25+25+42+42	1.31	1.64	1.64	2.75	2.75	10.10 (3.90-10.90)	3.660 (0.810-3.950)	16.07	99
20+25+25+42+50	1.25	1.56	1.56	2.62	3.12	10.10 (3.90-10.90)	3.650 (0.810-3.940)	16.03	99
20+25+25+42+60	1.17	1.47	1.47	2.47	3.52	10.10 (3.90-10.90)	3.620 (0.810-3.930)	15.90	99
20+25+25+50+50	1.19	1.49	1.49	2.97	2.97	10.10 (3.90-10.90)	3.640 (0.810-3.930)	15.99	99
20+25+35+35+35	1.35	1.68	2.36	2.36	2.36	10.10 (3.90-10.90)	3.700 (0.810-3.970)	16.25	99
20+25+35+35+42	1.29	1.61	2.25	2.25	2.70	10.10 (3.90-10.90)	3.680 (0.810-3.960)	16.16	99
20+25+35+35+50	1.22	1.53	2.14	2.14	3.06	10.10 (3.90-10.90)	3.670 (0.810-3.950)	16.12	99
20+25+35+42+42	1.23	1.54	2.16	2.59	2.59	10.10 (3.90-10.90)	3.660 (0.810-3.950)	16.07	99
20+25+35+42+50	1.17	1.47	2.06	2.47	2.94	10.10 (3.90-10.90)	3.650 (0.810-3.940)	16.03	99
20+25+42+42+42	1.18	1.48	2.48	2.48	2.48	10.10 (3.90-10.90)	3.640 (0.810-3.940)	15.99	99
20+35+35+35+35	1.26	2.21	2.21	2.21	2.21	10.10 (3.90-10.90)	3.700 (0.810-3.970)	16.25	99
20+35+35+35+42	1.21	2.12	2.12	2.12	2.54	10.10 (3.90-10.90)	3.680 (0.810-3.960)	16.16	99

MXZ-5D102VA COOLING

Indoor units combination	Cooling capacity (kW)						Outdoor unit power consumption(kW)	Current (A)	Power factor(%)
	Unit A	Unit B	Unit C	Unit D	Unit E	Total			
22+22+22+22+22	2.04	2.04	2.04	2.04	2.04	10.20 (3.90-11.00)	3.840 (0.780-4.000)	16.86	99
22+22+22+22+25	1.99	1.99	1.99	1.99	2.26	10.20 (3.90-11.00)	3.840 (0.780-4.000)	16.86	99
22+22+22+22+35	1.82	1.82	1.82	1.82	2.90	10.20 (3.90-11.00)	3.840 (0.780-4.000)	16.86	99
22+22+22+22+42	1.73	1.73	1.73	1.73	3.30	10.20 (3.90-11.00)	3.820 (0.780-3.990)	16.78	99
22+22+22+22+50	1.63	1.63	1.63	1.63	3.70	10.20 (3.90-11.00)	3.810 (0.780-3.980)	16.73	99
22+22+22+22+60	1.52	1.52	1.52	1.52	4.14	10.20 (3.90-11.00)	3.780 (0.780-3.970)	16.60	99
22+22+22+22+71	1.41	1.41	1.41	1.41	4.55	10.20 (3.90-11.00)	3.760 (0.780-3.960)	16.51	99
22+22+22+25+25	1.93	1.93	1.93	2.20	2.20	10.20 (3.90-11.00)	3.840 (0.780-4.000)	16.86	99
22+22+22+25+35	1.78	1.78	1.78	2.02	2.83	10.20 (3.90-11.00)	3.840 (0.780-4.000)	16.86	99
22+22+22+25+42	1.69	1.69	1.69	1.92	3.22	10.20 (3.90-11.00)	3.820 (0.780-3.990)	16.78	99
22+22+22+25+50	1.59	1.59	1.59	1.81	3.62	10.20 (3.90-11.00)	3.810 (0.780-3.980)	16.73	99
22+22+22+25+60	1.49	1.49	1.49	1.69	4.05	10.20 (3.90-11.00)	3.780 (0.780-3.970)	16.60	99
22+22+22+25+71	1.39	1.39	1.39	1.57	4.47	10.20 (3.90-11.00)	3.760 (0.780-3.960)	16.51	99
22+22+22+35+35	1.65	1.65	1.65	2.63	2.63	10.20 (3.90-11.00)	3.840 (0.780-4.000)	16.86	99
22+22+22+35+42	1.57	1.57	1.57	2.50	3.00	10.20 (3.90-11.00)	3.820 (0.780-3.990)	16.78	99
22+22+22+35+50	1.49	1.49	1.49	2.36	3.38	10.20 (3.90-11.00)	3.810 (0.780-3.980)	16.73	99
22+22+22+35+60	1.39	1.39	1.39	2.22	3.80	10.20 (3.90-11.00)	3.780 (0.780-3.970)	16.60	99
22+22+22+35+71	1.30	1.30	1.30	2.08	4.21	10.20 (3.90-11.00)	3.760 (0.780-3.960)	16.51	99
22+22+22+42+42	1.50	1.50	1.50	2.86	2.86	10.20 (3.90-11.00)	3.800 (0.780-3.980)	16.69	99
22+22+22+42+50	1.42	1.42	1.42	2.71	3.23	10.20 (3.90-11.00)	3.790 (0.780-3.970)	16.64	99
22+22+22+42+60	1.34	1.34	1.34	2.55	3.64	10.20 (3.90-11.00)	3.760 (0.780-3.960)	16.51	99
22+22+22+50+50	1.35	1.35	1.35	3.07	3.07	10.20 (3.90-11.00)	3.780 (0.780-3.960)	16.60	99
22+22+25+25+25	1.89	1.89	2.14	2.14	2.14	10.20 (3.90-11.00)	3.840 (0.780-4.000)	16.86	99
22+22+25+25+35	1.74	1.74	1.98	1.98	2.77	10.20 (3.90-11.00)	3.840 (0.780-4.000)	16.86	99
22+22+25+25+42	1.65	1.65	1.88	1.88	3.15	10.20 (3.90-11.00)	3.820 (0.780-3.990)	16.78	99
22+22+25+25+50	1.56	1.56	1.77	1.77	3.54	10.20 (3.90-11.00)	3.810 (0.780-3.980)	16.73	99
22+22+25+25+60	1.46	1.46	1.66	1.66	3.97	10.20 (3.90-11.00)	3.780 (0.780-3.970)	16.60	99
22+22+25+25+71	1.36	1.36	1.55	1.55	4.39	10.20 (3.90-11.00)	3.760 (0.780-3.960)	16.51	99
22+22+25+35+35	1.61	1.61	1.83	2.57	2.57	10.20 (3.90-11.00)	3.840 (0.780-4.000)	16.86	99
22+22+25+35+42	1.54	1.54	1.75	2.45	2.93	10.20 (3.90-11.00)	3.820 (0.780-3.990)	16.78	99
22+22+25+35+50	1.46	1.46	1.66	2.32	3.31	10.20 (3.90-11.00)	3.810 (0.780-3.980)	16.73	99
22+22+25+35+60	1.37	1.37	1.55	2.18	3.73	10.20 (3.90-11.00)	3.780 (0.780-3.970)	16.60	99
22+22+25+42+42	1.47	1.47	1.67	2.80	2.80	10.20 (3.90-11.00)	3.800 (0.780-3.980)	16.69	99
22+22+25+42+50	1.39	1.39	1.58	2.66	3.17	10.20 (3.90-11.00)	3.790 (0.780-3.970)	16.64	99
22+22+25+42+60	1.31	1.31	1.49	2.51	3.58	10.20 (3.90-11.00)	3.760 (0.780-3.960)	16.51	99
22+22+25+50+50	1.33	1.33	1.51	3.02	3.02	10.20 (3.90-11.00)	3.780 (0.780-3.960)	16.60	99
22+22+35+35+35	1.51	1.51	2.40	2.40	2.40	10.20 (3.90-11.00)	3.840 (0.780-4.000)	16.86	99
22+22+35+35+42	1.44	1.44	2.29	2.29	2.75	10.20 (3.90-11.00)	3.820 (0.780-3.990)	16.78	99
22+22+35+35+50	1.37	1.37	2.18	2.18	3.11	10.20 (3.90-11.00)	3.810 (0.780-3.980)	16.73	99
22+22+35+42+42	1.38	1.38	2.19	2.63	2.63	10.20 (3.90-11.00)	3.800 (0.780-3.980)	16.69	99
22+22+35+42+50	1.31	1.31	2.09	2.51	2.98	10.20 (3.90-11.00)	3.790 (0.780-3.970)	16.64	99

MXZ-5D102VA COOLING

Indoor units combination	Cooling capacity (kW)						Outdoor unit power consumption(kW)	Current (A)	Power factor(%)
	Unit A	Unit B	Unit C	Unit D	Unit E	Total			
22+22+42+42+42	1.32	1.32	2.52	2.52	2.52	10.20 (3.90-11.00)	3.780 (0.780-3.970)	16.60	99
22+25+25+25+25	1.84	2.09	2.09	2.09	2.09	10.20 (3.90-11.00)	3.840 (0.780-4.000)	16.86	99
22+25+25+25+35	1.70	1.93	1.93	1.93	2.70	10.20 (3.90-11.00)	3.840 (0.780-4.000)	16.86	99
22+25+25+25+42	1.61	1.83	1.83	1.83	3.08	10.20 (3.90-11.00)	3.820 (0.780-3.990)	16.78	99
22+25+25+25+50	1.53	1.73	1.73	1.73	3.47	10.20 (3.90-11.00)	3.810 (0.780-3.980)	16.73	99
22+25+25+25+60	1.43	1.62	1.62	1.62	3.90	10.20 (3.90-11.00)	3.780 (0.780-3.970)	16.60	99
22+25+25+25+71	1.34	1.52	1.52	1.52	4.31	10.20 (3.90-11.00)	3.760 (0.780-3.960)	16.51	99
22+25+25+35+35	1.58	1.80	1.80	2.51	2.51	10.20 (3.90-11.00)	3.840 (0.780-4.000)	16.86	99
22+25+25+35+42	1.51	1.71	1.71	2.40	2.88	10.20 (3.90-11.00)	3.820 (0.780-3.990)	16.78	99
22+25+25+35+50	1.43	1.62	1.62	2.27	3.25	10.20 (3.90-11.00)	3.810 (0.780-3.980)	16.73	99
22+25+25+35+60	1.34	1.53	1.53	2.14	3.66	10.20 (3.90-11.00)	3.780 (0.780-3.970)	16.60	99
22+25+25+42+42	1.44	1.63	1.63	2.75	2.75	10.20 (3.90-11.00)	3.800 (0.780-3.980)	16.69	99
22+25+25+42+50	1.37	1.55	1.55	2.61	3.11	10.20 (3.90-11.00)	3.790 (0.780-3.970)	16.64	99
22+25+25+50+50	1.30	1.48	1.48	2.97	2.97	10.20 (3.90-11.00)	3.780 (0.780-3.960)	16.60	99
22+25+35+35+35	1.48	1.68	2.35	2.35	2.35	10.20 (3.90-11.00)	3.840 (0.780-4.000)	16.86	99
22+25+35+35+42	1.41	1.60	2.25	2.25	2.69	10.20 (3.90-11.00)	3.820 (0.780-3.990)	16.78	99
22+25+35+35+50	1.34	1.53	2.14	2.14	3.05	10.20 (3.90-11.00)	3.810 (0.780-3.980)	16.73	99
22+25+35+42+42	1.35	1.54	2.15	2.58	2.58	10.20 (3.90-11.00)	3.800 (0.780-3.980)	16.69	99
22+35+35+35+35	1.39	2.20	2.20	2.20	2.20	10.20 (3.90-11.00)	3.840 (0.780-4.000)	16.86	99
22+35+35+35+42	1.33	2.11	2.11	2.11	2.53	10.20 (3.90-11.00)	3.820 (0.780-3.990)	16.78	99
25+25+25+25+25	2.04	2.04	2.04	2.04	2.04	10.20 (3.90-11.00)	3.840 (0.780-4.000)	16.86	99
25+25+25+25+35	1.89	1.89	1.89	1.89	2.64	10.20 (3.90-11.00)	3.840 (0.780-4.000)	16.86	99
25+25+25+25+42	1.80	1.80	1.80	1.80	3.02	10.20 (3.90-11.00)	3.820 (0.780-3.990)	16.78	99
25+25+25+25+50	1.70	1.70	1.70	1.70	3.40	10.20 (3.90-11.00)	3.810 (0.780-3.980)	16.73	99
25+25+25+25+60	1.59	1.59	1.59	1.59	3.83	10.20 (3.90-11.00)	3.780 (0.780-3.970)	16.60	99
25+25+25+25+71	1.49	1.49	1.49	1.49	4.24	10.20 (3.90-11.00)	3.760 (0.780-3.960)	16.51	99
25+25+25+35+35	1.76	1.76	1.76	2.46	2.46	10.20 (3.90-11.00)	3.840 (0.780-4.000)	16.86	99
25+25+25+35+42	1.68	1.68	1.68	2.35	2.82	10.20 (3.90-11.00)	3.820 (0.780-3.990)	16.78	99
25+25+25+35+50	1.59	1.59	1.59	2.23	3.19	10.20 (3.90-11.00)	3.810 (0.780-3.980)	16.73	99
25+25+25+35+60	1.50	1.50	1.50	2.10	3.60	10.20 (3.90-11.00)	3.780 (0.780-3.970)	16.60	99
25+25+25+42+42	1.60	1.60	1.60	2.69	2.69	10.20 (3.90-11.00)	3.800 (0.780-3.980)	16.69	99
25+25+25+42+50	1.53	1.53	1.53	2.57	3.05	10.20 (3.90-11.00)	3.790 (0.780-3.970)	16.64	99
25+25+35+35+35	1.65	1.65	2.30	2.30	2.30	10.20 (3.90-11.00)	3.840 (0.780-4.000)	16.86	99
25+25+35+35+42	1.57	1.57	2.20	2.20	2.64	10.20 (3.90-11.00)	3.820 (0.780-3.990)	16.78	99
25+25+35+35+50	1.50	1.50	2.10	2.10	3.00	10.20 (3.90-11.00)	3.810 (0.780-3.980)	16.73	99
25+25+35+42+42	1.51	1.51	2.11	2.53	2.53	10.20 (3.90-11.00)	3.800 (0.780-3.980)	16.69	99
25+35+35+35+35	1.55	2.16	2.16	2.16	2.16	10.20 (3.90-11.00)	3.840 (0.780-4.000)	16.86	99
25+35+35+35+42	1.48	2.08	2.08	2.08	2.49	10.20 (3.90-11.00)	3.820 (0.780-3.990)	16.78	99

MXZ-5D102VA HEATING

Indoor units combination	Heating capacity (kW)						Outdoor unit power consumption(kW)	Current (A)	Power factor(%)
	Unit A	Unit B	Unit C	Unit D	Unit E	Total			
15	1.70	-	-	-	-	1.70 (1.20-3.00)	0.650 (0.540-1.670)	2.85	99
18	3.30	-	-	-	-	3.30 (1.20-4.20)	0.890 (0.340-1.590)	3.91	99
20	2.20	-	-	-	-	2.20 (1.20-3.90)	0.830 (0.540-2.170)	3.65	99
22	3.30	-	-	-	-	3.30 (1.20-4.20)	0.890 (0.340-1.590)	3.91	99
25	3.60	-	-	-	-	3.60 (1.20-4.50)	0.990 (0.340-1.740)	4.35	99
35	4.00	-	-	-	-	4.00 (1.20-5.50)	1.140 (0.330-1.810)	5.01	99
42	5.40	-	-	-	-	5.40 (1.30-6.50)	1.610 (0.330-2.260)	7.07	99
50	7.20	-	-	-	-	7.20 (1.40-7.70)	2.270 (0.330-2.710)	9.97	99
60	7.90	-	-	-	-	7.90 (1.40-8.60)	2.270 (0.330-3.060)	9.97	99
71	8.60	-	-	-	-	8.60 (1.60-9.20)	2.410 (0.360-3.520)	10.58	99
15+15	1.70	1.70	-	-	-	3.40 (1.80-5.00)	0.810 (0.520-2.800)	3.56	99
15+18	1.70	3.30	-	-	-	5.00 (1.80-6.10)	1.190 (0.500-2.780)	5.23	99
15+20	1.70	2.20	-	-	-	3.90 (1.80-5.80)	0.960 (0.490-2.775)	4.22	99
15+22	1.70	3.30	-	-	-	5.00 (1.80-6.10)	1.190 (0.490-3.000)	5.23	99
15+25	1.60	3.40	-	-	-	5.00 (1.80-6.10)	1.190 (0.520-3.680)	5.23	99
15+35	1.67	3.93	-	-	-	5.60 (1.80-7.70)	1.380 (0.480-3.150)	6.06	99
15+42	1.41	4.49	-	-	-	5.90 (1.80-8.20)	1.499 (0.480-3.275)	6.58	99
15+50	1.18	5.02	-	-	-	6.20 (1.80-8.60)	1.605 (0.480-3.320)	7.05	99
15+60	1.29	6.01	-	-	-	7.30 (1.80-9.10)	2.021 (0.470-3.405)	8.88	99
15+71	1.58	7.32	-	-	-	8.90 (1.80-9.90)	2.660 (0.460-3.560)	11.68	99
18+18	3.30	3.30	-	-	-	6.60 (1.80-7.20)	1.570 (0.480-2.760)	6.90	99
18+20	3.30	2.20	-	-	-	5.50 (1.80-6.90)	1.340 (0.500-3.215)	5.88	99
18+22	3.30	3.30	-	-	-	6.60 (1.80-7.20)	1.570 (0.520-3.670)	6.90	99
18+25	3.16	3.44	-	-	-	6.60 (1.80-7.20)	1.570 (0.490-2.990)	6.90	99
18+35	3.30	4.00	-	-	-	7.30 (1.80-9.00)	1.811 (0.480-3.195)	7.95	99
18+42	2.88	4.72	-	-	-	7.60 (1.80-9.50)	1.930 (0.480-3.320)	8.48	99
18+50	2.48	5.42	-	-	-	7.90 (1.80-9.70)	2.024 (0.480-3.310)	8.89	99
18+60	2.77	6.63	-	-	-	9.40 (1.80-10.50)	2.617 (0.470-3.450)	11.49	99
18+71	3.09	7.41	-	-	-	10.50 (1.80-11.00)	3.040 (0.460-3.550)	13.35	99
20+20	2.20	2.20	-	-	-	4.40 (1.80-6.60)	1.110 (0.520-3.670)	4.87	99
20+22	2.20	3.30	-	-	-	5.50 (1.80-6.90)	1.340 (0.500-3.215)	5.88	99
20+25	2.12	3.48	-	-	-	5.60 (1.80-7.20)	1.372 (0.480-2.825)	6.03	99
20+35	2.20	4.00	-	-	-	6.20 (1.80-8.90)	1.615 (0.480-3.230)	7.09	99
20+42	1.91	4.69	-	-	-	6.60 (1.80-9.30)	1.726 (0.480-3.320)	7.58	99
20+50	1.61	5.29	-	-	-	6.90 (1.80-9.50)	1.820 (0.480-3.310)	7.99	99
20+60	1.90	6.80	-	-	-	8.70 (1.80-10.40)	2.531 (0.470-3.485)	11.12	99
20+71	2.05	7.35	-	-	-	9.40 (1.80-10.70)	2.810 (0.460-3.550)	12.34	99
22+22	3.30	3.30	-	-	-	6.60 (1.80-7.20)	1.570 (0.480-2.760)	6.90	99
22+25	3.30	3.60	-	-	-	6.90 (1.80-8.00)	1.665 (0.480-2.950)	7.31	99
22+35	3.30	4.00	-	-	-	7.30 (1.80-9.30)	1.879 (0.480-3.265)	8.25	99
22+42	2.96	4.84	-	-	-	7.80 (1.80-9.60)	1.982 (0.480-3.320)	8.70	99

MXZ-5D102VA HEATING

Indoor units combination	Heating capacity (kW)						Outdoor unit power consumption(kW)	Current (A)	Power factor(%)
	Unit A	Unit B	Unit C	Unit D	Unit E	Total			
22+50	2.64	5.76	-	-	-	8.40 (1.80-10.00)	2.194 (0.480-3.345)	9.64	99
22+60	2.98	7.12	-	-	-	10.10 (1.80-10.80)	2.906 (0.460-3.525)	12.76	99
22+71	3.09	7.41	-	-	-	10.50 (1.80-11.00)	3.040 (0.460-3.550)	13.35	99
25+25	3.60	3.60	-	-	-	7.20 (1.80-8.80)	1.760 (0.480-3.140)	7.73	99
25+35	3.60	4.00	-	-	-	7.60 (1.80-9.50)	1.930 (0.480-3.320)	8.48	99
25+42	3.16	4.74	-	-	-	7.90 (1.80-9.70)	2.021 (0.480-3.320)	8.88	99
25+50	2.97	5.93	-	-	-	8.90 (1.80-10.20)	2.411 (0.470-3.405)	10.59	99
25+60	3.29	7.21	-	-	-	10.50 (1.80-11.00)	3.050 (0.460-3.560)	13.39	99
25+71	3.29	7.21	-	-	-	10.50 (1.80-11.00)	3.040 (0.460-3.550)	13.35	99
35+35	4.00	4.00	-	-	-	8.00 (1.80-9.80)	2.060 (0.480-3.320)	9.05	99
35+42	3.96	5.34	-	-	-	9.30 (1.80-10.40)	2.565 (0.470-3.450)	11.26	99
35+50	3.75	6.75	-	-	-	10.50 (1.80-11.00)	3.060 (0.460-3.570)	13.44	99
35+60	3.53	6.97	-	-	-	10.50 (1.80-11.00)	3.050 (0.460-3.560)	13.39	99
35+71	3.53	6.97	-	-	-	10.50 (1.80-11.00)	3.040 (0.460-3.550)	13.35	99
42+42	5.25	5.25	-	-	-	10.50 (1.80-11.00)	3.070 (0.460-3.580)	13.48	99
42+50	4.50	6.00	-	-	-	10.50 (1.80-11.00)	3.060 (0.460-3.570)	13.44	99
42+71	4.26	6.24	-	-	-	10.50 (1.80-11.00)	3.040 (0.460-3.550)	13.35	99
50+50	5.25	5.25	-	-	-	10.50 (1.80-11.00)	3.050 (0.460-3.560)	13.39	99
50+60	5.01	5.49	-	-	-	10.50 (1.80-11.00)	3.040 (0.460-3.550)	13.35	99
50+71	5.01	5.49	-	-	-	10.50 (1.80-11.00)	3.030 (0.460-3.540)	13.31	99
60+60	5.25	5.25	-	-	-	10.50 (1.80-11.00)	3.030 (0.460-3.540)	13.31	99
60+71	5.25	5.25	-	-	-	10.50 (1.80-11.00)	3.020 (0.460-3.530)	13.26	99
71+71	5.25	5.25	-	-	-	10.50 (1.80-11.00)	3.010 (0.460-3.520)	13.22	99
15+15+15	1.70	1.70	1.70	-	-	5.10 (2.60-8.50)	1.150 (0.650-4.100)	5.05	99
15+15+18	1.60	1.60	3.10	-	-	6.30 (2.60-9.20)	1.420 (0.610-3.755)	6.24	99
15+15+20	1.70	1.70	2.20	-	-	5.60 (2.60-8.90)	1.310 (0.650-3.520)	5.75	99
15+15+22	1.60	1.60	3.10	-	-	6.30 (2.60-9.20)	1.420 (0.610-3.290)	6.24	99
15+15+25	1.53	1.53	3.24	-	-	6.30 (2.60-9.20)	1.420 (0.610-3.235)	6.24	99
15+15+35	1.45	1.45	3.41	-	-	6.30 (2.60-9.20)	1.420 (0.610-3.235)	6.24	99
15+15+42	1.26	1.26	3.99	-	-	6.50 (2.60-9.90)	1.473 (0.610-3.300)	6.47	99
15+15+50	1.09	1.09	4.62	-	-	6.80 (2.60-10.40)	1.665 (0.640-3.520)	7.31	99
15+15+60	1.07	1.07	4.96	-	-	7.10 (2.60-10.70)	1.985 (0.690-3.705)	8.72	99
15+15+71	1.13	1.13	5.24	-	-	7.50 (2.60-11.10)	2.338 (0.740-3.910)	10.27	99
15+18+18	1.54	2.98	2.98	-	-	7.50 (2.60-9.90)	1.690 (0.570-3.405)	7.42	99
15+18+20	1.61	3.12	2.08	-	-	6.80 (2.60-9.60)	1.580 (0.610-3.175)	6.94	99
15+18+22	1.54	2.98	2.98	-	-	7.50 (2.60-9.90)	1.690 (0.570-3.235)	7.42	99
15+18+25	1.48	2.88	3.14	-	-	7.50 (2.60-9.90)	1.690 (0.570-3.755)	7.42	99
15+18+35	1.44	2.79	3.38	-	-	7.60 (2.60-10.10)	1.708 (0.570-3.140)	7.50	99
15+18+42	1.28	2.48	4.05	-	-	7.80 (2.60-10.90)	1.770 (0.570-3.420)	7.77	99
15+18+50	1.13	2.19	4.78	-	-	8.10 (2.60-11.20)	2.034 (0.610-3.575)	8.93	99
15+18+60	1.11	2.15	5.14	-	-	8.40 (2.60-11.50)	2.354 (0.660-3.765)	10.34	99

MXZ-5D102VA HEATING

Indoor units combination	Heating capacity (kW)						Outdoor unit power consumption(kW)	Current (A)	Power factor(%)
	Unit A	Unit B	Unit C	Unit D	Unit E	Total			
15+18+71	1.16	2.25	5.39	-	-	8.80 (2.60-11.90)	2.707 (0.720-3.970)	11.89	99
15+20+20	1.70	2.20	2.20	-	-	6.10 (2.60-9.30)	1.470 (0.650-3.235)	6.46	99
15+20+22	1.61	2.08	3.12	-	-	6.80 (2.60-9.60)	1.580 (0.610-3.580)	6.94	99
15+20+25	1.54	1.99	3.26	-	-	6.80 (2.60-9.60)	1.580 (0.610-4.100)	6.94	99
15+20+35	1.48	1.92	3.49	-	-	6.90 (2.60-10.00)	1.616 (0.610-3.220)	7.10	99
15+20+42	1.32	1.70	4.18	-	-	7.20 (2.60-10.70)	1.726 (0.620-3.460)	7.58	99
15+20+50	1.13	1.47	4.80	-	-	7.40 (2.60-10.90)	1.990 (0.660-3.615)	8.74	99
15+20+60	1.12	1.45	5.22	-	-	7.80 (2.60-11.30)	2.310 (0.710-3.805)	10.14	99
15+20+71	1.17	1.51	5.42	-	-	8.10 (2.60-11.60)	2.638 (0.760-3.990)	11.59	99
15+22+22	1.54	2.98	2.98	-	-	7.50 (2.60-9.90)	1.690 (0.570-3.925)	7.42	99
15+22+25	1.48	2.88	3.14	-	-	7.50 (2.60-9.90)	1.690 (0.570-3.755)	7.42	99
15+22+35	1.45	2.82	3.42	-	-	7.70 (2.60-10.60)	1.743 (0.570-3.300)	7.65	99
15+22+42	1.29	2.51	4.10	-	-	7.90 (2.60-11.00)	1.902 (0.590-3.500)	8.35	99
15+22+50	1.14	2.22	4.84	-	-	8.20 (2.60-11.30)	2.166 (0.630-3.655)	9.51	99
15+22+60	1.12	2.17	5.21	-	-	8.50 (2.60-11.60)	2.486 (0.680-3.845)	10.92	99
15+22+71	1.17	2.28	5.45	-	-	8.90 (2.60-11.90)	2.763 (0.720-3.990)	12.13	99
15+25+25	1.43	3.03	3.03	-	-	7.50 (2.60-9.90)	1.690 (0.570-3.235)	7.42	99
15+25+35	1.43	3.02	3.35	-	-	7.80 (2.60-10.90)	1.770 (0.570-3.420)	7.77	99
15+25+42	1.27	2.69	4.04	-	-	8.00 (2.60-11.10)	2.001 (0.610-3.560)	8.79	99
15+25+50	1.13	2.39	4.78	-	-	8.30 (2.60-11.40)	2.265 (0.650-3.715)	9.95	99
15+25+60	1.11	2.35	5.15	-	-	8.60 (2.60-11.70)	2.585 (0.700-3.900)	11.35	99
15+25+71	1.15	2.43	5.33	-	-	8.90 (2.60-11.90)	2.786 (0.720-3.990)	12.24	99
15+35+35	1.42	3.34	3.34	-	-	8.10 (2.60-11.20)	2.100 (0.620-3.615)	9.22	99
15+35+42	1.29	3.03	4.09	-	-	8.40 (2.60-11.50)	2.331 (0.660-3.755)	10.24	99
15+35+50	1.13	2.67	4.80	-	-	8.60 (2.60-11.70)	2.595 (0.700-3.910)	11.40	99
15+35+60	1.11	2.62	5.17	-	-	8.90 (2.60-11.90)	2.788 (0.720-4.000)	12.24	99
15+35+71	1.15	2.71	5.34	-	-	9.20 (2.70-11.90)	2.862 (0.720-3.990)	12.57	99
15+42+42	1.17	3.72	3.72	-	-	8.60 (2.60-11.70)	2.562 (0.690-3.890)	11.25	99
15+42+50	1.05	3.32	4.43	-	-	8.80 (2.60-11.90)	2.775 (0.720-4.010)	12.19	99
15+42+60	1.03	3.28	4.79	-	-	9.10 (2.70-11.90)	2.841 (0.720-4.000)	12.48	99
15+42+71	1.05	3.35	4.90	-	-	9.30 (2.70-11.90)	2.900 (0.720-3.990)	12.74	99
15+50+50	0.95	4.02	4.02	-	-	9.00 (2.60-11.90)	2.836 (0.720-4.010)	12.45	99
15+50+60	0.94	3.99	4.37	-	-	9.30 (2.70-11.90)	2.902 (0.720-4.000)	12.74	99
15+50+71	0.94	3.99	4.37	-	-	9.30 (2.70-11.90)	2.900 (0.720-3.990)	12.74	99
15+60+60	0.90	4.20	4.20	-	-	9.30 (2.70-11.90)	2.900 (0.720-3.990)	12.74	99
15+60+71	0.90	4.20	4.20	-	-	9.30 (2.70-11.90)	2.890 (0.720-3.980)	12.69	99
15+71+71	0.90	4.20	4.20	-	-	9.30 (2.70-11.90)	2.880 (0.720-3.970)	12.65	99
18+18+18	2.90	2.90	2.90	-	-	8.70 (2.60-10.60)	1.960 (0.530-3.060)	8.61	99
18+18+20	3.00	3.00	2.00	-	-	8.00 (2.60-10.30)	1.850 (0.570-3.405)	8.12	99
18+18+22	2.90	2.90	2.90	-	-	8.70 (2.60-10.60)	1.960 (0.530-3.755)	8.61	99
18+18+25	2.81	2.81	3.07	-	-	8.70 (2.60-10.60)	1.960 (0.530-3.925)	8.61	99

MXZ-5D102VA HEATING

Indoor units combination	Heating capacity (kW)					Outdoor unit power consumption(kW)	Current (A)	Power factor(%)	
	Unit A	Unit B	Unit C	Unit D	Unit E				Total
18+18+35	2.77	2.77	3.36	-	-	8.90 (2.60-11.20)	2.004 (0.530-3.260)	8.80	99
18+18+42	2.50	2.50	4.10	-	-	9.10 (2.60-11.70)	2.139 (0.550-3.480)	9.39	99
18+18+50	2.25	2.25	4.90	-	-	9.40 (2.60-12.00)	2.403 (0.590-3.635)	10.55	99
18+18+60	2.21	2.21	5.28	-	-	9.70 (2.60-12.30)	2.723 (0.640-3.825)	11.96	99
18+18+71	2.28	2.28	5.45	-	-	10.00 (2.60-12.60)	3.025 (0.680-3.990)	13.29	99
18+20+20	3.13	2.09	2.09	-	-	7.30 (2.60-10.00)	1.740 (0.610-3.755)	7.64	99
18+20+22	3.00	2.00	3.00	-	-	8.00 (2.60-10.30)	1.850 (0.570-4.100)	8.12	99
18+20+25	2.90	1.93	3.16	-	-	8.00 (2.60-10.30)	1.850 (0.570-3.580)	8.12	99
18+20+35	2.85	1.90	3.45	-	-	8.20 (2.60-11.10)	1.912 (0.570-3.340)	8.40	99
18+20+42	2.57	1.72	4.21	-	-	8.50 (2.60-11.50)	2.095 (0.600-3.520)	9.20	99
18+20+50	2.26	1.51	4.93	-	-	8.70 (2.60-11.70)	2.359 (0.640-3.675)	10.36	99
18+20+60	2.24	1.49	5.36	-	-	9.10 (2.60-12.10)	2.679 (0.690-3.860)	11.77	99
18+20+71	2.31	1.54	5.54	-	-	9.40 (2.60-12.30)	2.930 (0.720-3.990)	12.87	99
18+22+22	2.90	2.90	2.90	-	-	8.70 (2.60-10.60)	1.960 (0.530-3.755)	8.61	99
18+22+25	2.81	2.81	3.07	-	-	8.70 (2.60-10.60)	1.960 (0.530-3.235)	8.61	99
18+22+35	2.80	2.80	3.40	-	-	9.00 (2.60-11.60)	2.040 (0.530-3.420)	8.96	99
18+22+42	2.53	2.53	4.14	-	-	9.20 (2.60-11.80)	2.271 (0.570-3.560)	9.97	99
18+22+50	2.27	2.27	4.96	-	-	9.50 (2.60-12.10)	2.535 (0.610-3.715)	11.13	99
18+22+60	2.23	2.23	5.34	-	-	9.80 (2.60-12.40)	2.855 (0.660-3.900)	12.54	99
18+22+71	2.30	2.30	5.50	-	-	10.10 (2.60-12.60)	3.056 (0.680-3.990)	13.42	99
18+25+25	2.77	3.02	3.02	-	-	8.80 (2.60-10.80)	1.978 (0.530-3.140)	8.69	99
18+25+35	2.76	3.01	3.34	-	-	9.10 (2.60-11.70)	2.139 (0.550-3.480)	9.39	99
18+25+42	2.50	2.72	4.08	-	-	9.30 (2.60-11.90)	2.370 (0.580-3.615)	10.41	99
18+25+50	2.25	2.45	4.90	-	-	9.60 (2.60-12.20)	2.634 (0.620-3.775)	11.57	99
18+25+60	2.21	2.41	5.28	-	-	9.90 (2.60-12.50)	2.954 (0.670-3.960)	12.97	99
18+25+71	2.27	2.48	5.44	-	-	10.20 (2.60-12.60)	3.079 (0.680-3.990)	13.52	99
18+35+35	2.75	3.33	3.33	-	-	9.40 (2.60-12.00)	2.469 (0.600-3.675)	10.84	99
18+35+42	2.52	3.06	4.12	-	-	9.70 (2.60-12.30)	2.700 (0.630-3.815)	11.86	99
18+35+50	2.25	2.73	4.92	-	-	9.90 (2.60-12.50)	2.964 (0.670-3.970)	13.02	99
18+35+60	2.21	2.68	5.30	-	-	10.20 (2.60-12.60)	3.081 (0.680-4.000)	13.53	99
18+35+71	2.28	2.76	5.46	-	-	10.50 (2.70-12.60)	3.155 (0.680-3.990)	13.86	99
18+42+50	2.10	3.43	4.57	-	-	10.10 (2.60-12.60)	3.068 (0.680-4.010)	13.47	99
18+42+60	2.07	3.38	4.95	-	-	10.40 (2.70-12.60)	3.134 (0.680-4.000)	13.76	99
18+42+71	2.09	3.42	5.00	-	-	10.50 (2.70-12.60)	3.170 (0.680-3.990)	13.92	99
18+50+50	1.92	4.19	4.19	-	-	10.30 (2.70-12.60)	3.129 (0.680-4.010)	13.74	99
18+50+60	1.88	4.11	4.51	-	-	10.50 (2.70-12.60)	3.180 (0.680-4.000)	13.97	99
18+50+71	1.88	4.11	4.51	-	-	10.50 (2.70-12.60)	3.170 (0.680-3.990)	13.92	99
18+60+60	1.81	4.34	4.34	-	-	10.50 (2.70-12.60)	3.170 (0.680-3.990)	13.92	99
18+60+71	1.81	4.34	4.34	-	-	10.50 (2.70-12.60)	3.160 (0.680-3.980)	13.88	99
18+71+71	1.81	4.34	4.34	-	-	10.50 (2.70-12.60)	3.150 (0.680-3.970)	13.83	99
20+20+20	2.20	2.20	2.20	-	-	6.60 (2.60-9.70)	1.630 (0.650-4.100)	7.16	99

MXZ-5D102VA HEATING

Indoor units combination	Heating capacity (kW)						Outdoor unit power consumption(kW)	Current (A)	Power factor(%)
	Unit A	Unit B	Unit C	Unit D	Unit E	Total			
20+20+22	2.09	2.09	3.13	-	-	7.30 (2.60-10.00)	1.740 (0.610-3.755)	7.64	99
20+20+25	2.01	2.01	3.29	-	-	7.30 (2.60-10.00)	1.740 (0.610-3.235)	7.64	99
20+20+35	1.99	1.99	3.62	-	-	7.60 (2.60-11.00)	1.820 (0.610-3.420)	7.99	99
20+20+42	1.75	1.75	4.30	-	-	7.80 (2.60-11.20)	2.051 (0.650-3.560)	9.01	99
20+20+50	1.54	1.54	5.03	-	-	8.10 (2.60-11.50)	2.315 (0.690-3.715)	10.17	99
20+20+60	1.50	1.50	5.40	-	-	8.40 (2.60-11.80)	2.635 (0.740-3.900)	11.57	99
20+20+71	1.56	1.56	5.59	-	-	8.70 (2.60-12.00)	2.836 (0.760-3.990)	12.45	99
20+22+22	2.00	3.00	3.00	-	-	8.00 (2.60-10.30)	1.850 (0.570-3.405)	8.12	99
20+22+25	1.93	2.90	3.16	-	-	8.00 (2.60-10.40)	1.859 (0.570-3.100)	8.16	99
20+22+35	1.95	2.92	3.54	-	-	8.40 (2.60-11.40)	1.996 (0.580-3.460)	8.77	99
20+22+42	1.74	2.60	4.26	-	-	8.60 (2.60-11.60)	2.227 (0.620-3.595)	9.78	99
20+22+50	1.54	2.31	5.05	-	-	8.90 (2.60-11.90)	2.491 (0.660-3.755)	10.94	99
20+22+71	1.56	2.34	5.60	-	-	9.50 (2.60-12.30)	2.961 (0.720-3.990)	13.00	99
20+25+25	1.90	3.10	3.10	-	-	8.10 (2.60-10.70)	1.886 (0.570-3.220)	8.28	99
20+25+35	1.91	3.12	3.47	-	-	8.50 (2.60-11.50)	2.095 (0.600-3.520)	9.20	99
20+25+42	1.71	2.80	4.19	-	-	8.70 (2.60-11.70)	2.326 (0.630-3.655)	10.22	99
20+25+50	1.52	2.49	4.98	-	-	9.00 (2.60-12.00)	2.590 (0.670-3.815)	11.37	99
20+25+60	1.49	2.44	5.36	-	-	9.30 (2.60-12.30)	2.910 (0.720-4.000)	12.78	99
20+25+71	1.54	2.52	5.54	-	-	9.60 (2.70-12.30)	2.984 (0.720-3.990)	13.10	99
20+35+35	1.90	3.45	3.45	-	-	8.80 (2.60-11.80)	2.425 (0.650-3.715)	10.65	99
20+35+42	1.71	3.10	4.19	-	-	9.00 (2.60-12.00)	2.656 (0.680-3.855)	11.66	99
20+35+50	1.53	2.78	5.00	-	-	9.30 (2.60-12.30)	2.920 (0.720-4.010)	12.82	99
20+35+60	1.48	2.70	5.32	-	-	9.50 (2.60-12.30)	2.986 (0.720-4.000)	13.11	99
20+35+71	1.53	2.78	5.49	-	-	9.80 (2.70-12.30)	3.060 (0.720-3.990)	13.44	99
20+42+42	1.57	3.86	3.86	-	-	9.30 (2.60-12.30)	2.887 (0.720-3.990)	12.68	99
20+42+50	1.41	3.47	4.62	-	-	9.50 (2.60-12.30)	2.973 (0.720-4.010)	13.06	99
20+42+60	1.38	3.38	4.94	-	-	9.70 (2.70-12.30)	3.040 (0.720-4.000)	13.35	99
20+42+71	1.39	3.41	4.99	-	-	9.80 (2.70-12.30)	3.060 (0.720-3.990)	13.44	99
20+50+50	1.29	4.21	4.21	-	-	9.70 (2.70-12.30)	3.034 (0.720-4.010)	13.32	99
20+50+60	1.25	4.08	4.48	-	-	9.80 (2.70-12.30)	3.070 (0.720-4.000)	13.48	99
20+50+71	1.25	4.08	4.48	-	-	9.80 (2.70-12.30)	3.060 (0.720-3.990)	13.44	99
20+60+60	1.20	4.30	4.30	-	-	9.80 (2.70-12.30)	3.060 (0.720-3.990)	13.44	99
20+60+71	1.20	4.30	4.30	-	-	9.80 (2.70-12.30)	3.050 (0.720-3.980)	13.39	99
20+71+71	1.20	4.30	4.30	-	-	9.80 (2.70-12.30)	3.040 (0.720-3.970)	13.35	99
22+22+22	2.90	2.90	2.90	-	-	8.70 (2.60-10.60)	1.960 (0.530-3.060)	8.61	99
22+22+25	2.85	2.85	3.11	-	-	8.80 (2.60-10.90)	1.987 (0.530-3.180)	8.73	99
22+22+35	2.83	2.83	3.43	-	-	9.10 (2.60-11.70)	2.172 (0.550-3.500)	9.54	99
22+22+42	2.59	2.59	4.23	-	-	9.40 (2.60-12.00)	2.403 (0.590-3.635)	10.55	99
22+22+50	2.30	2.30	5.01	-	-	9.60 (2.60-12.20)	2.667 (0.630-3.795)	11.71	99
22+22+60	2.28	2.28	5.45	-	-	10.00 (2.60-12.60)	2.987 (0.680-3.980)	13.12	99
22+22+71	2.32	2.32	5.56	-	-	10.20 (2.60-12.60)	3.086 (0.680-3.990)	13.55	99

MXZ-5D102VA HEATING

Indoor units combination	Heating capacity (kW)						Outdoor unit power consumption(kW)	Current (A)	Power factor(%)
	Unit A	Unit B	Unit C	Unit D	Unit E	Total			
22+25+25	2.80	3.05	3.05	-	-	8.90 (2.60-11.30)	2.013 (0.530-3.300)	8.84	99
22+25+35	2.79	3.04	3.38	-	-	9.20 (2.60-11.80)	2.271 (0.570-3.560)	9.97	99
22+25+42	2.55	2.78	4.17	-	-	9.50 (2.60-12.10)	2.502 (0.600-3.695)	10.99	99
22+25+50	2.27	2.48	4.95	-	-	9.70 (2.60-12.30)	2.766 (0.640-3.855)	12.15	99
22+25+60	2.23	2.43	5.34	-	-	10.00 (2.60-12.60)	3.035 (0.680-4.000)	13.33	99
22+25+71	2.30	2.51	5.50	-	-	10.30 (2.70-12.60)	3.109 (0.680-3.990)	13.65	99
22+35+35	2.80	3.40	3.40	-	-	9.60 (2.60-12.20)	2.601 (0.620-3.755)	11.42	99
22+35+42	2.55	3.09	4.17	-	-	9.80 (2.60-12.40)	2.832 (0.650-3.890)	12.44	99
22+35+50	2.28	2.76	4.97	-	-	10.00 (2.60-12.60)	3.045 (0.680-4.010)	13.37	99
22+35+60	2.24	2.71	5.35	-	-	10.30 (2.70-12.60)	3.111 (0.680-4.000)	13.66	99
22+35+71	2.28	2.76	5.46	-	-	10.50 (2.70-12.60)	3.170 (0.680-3.990)	13.92	99
22+42+42	2.34	3.83	3.83	-	-	10.00 (2.60-12.60)	3.038 (0.680-4.010)	13.34	99
22+42+50	2.12	3.46	4.62	-	-	10.20 (2.60-12.60)	3.099 (0.680-4.010)	13.61	99
22+42+60	2.09	3.42	5.00	-	-	10.50 (2.70-12.60)	3.165 (0.680-4.000)	13.90	99
22+42+71	2.09	3.42	5.00	-	-	10.50 (2.70-12.60)	3.170 (0.680-3.990)	13.92	99
22+50+50	1.94	4.23	4.23	-	-	10.40 (2.70-12.60)	3.160 (0.680-4.010)	13.88	99
22+50+60	1.88	4.11	4.51	-	-	10.50 (2.70-12.60)	3.180 (0.680-4.000)	13.97	99
22+50+71	1.88	4.11	4.51	-	-	10.50 (2.70-12.60)	3.170 (0.680-3.990)	13.92	99
22+60+60	1.81	4.34	4.34	-	-	10.50 (2.70-12.60)	3.170 (0.680-3.990)	13.92	99
22+60+71	1.81	4.34	4.34	-	-	10.50 (2.70-12.60)	3.160 (0.680-3.980)	13.88	99
22+71+71	1.81	4.34	4.34	-	-	10.50 (2.70-12.60)	3.150 (0.680-3.970)	13.83	99
25+25+25	3.00	3.00	3.00	-	-	9.00 (2.60-11.60)	2.040 (0.530-3.420)	8.96	99
25+25+35	2.99	2.99	3.32	-	-	9.30 (2.60-11.90)	2.370 (0.580-3.615)	10.41	99
25+25+42	2.74	2.74	4.11	-	-	9.60 (2.60-12.20)	2.601 (0.620-3.755)	11.42	99
25+25+50	2.45	2.45	4.90	-	-	9.80 (2.60-12.40)	2.865 (0.660-3.910)	12.58	99
25+25+60	2.41	2.41	5.28	-	-	10.10 (2.60-12.60)	3.058 (0.680-4.000)	13.43	99
25+25+71	2.48	2.48	5.44	-	-	10.40 (2.70-12.60)	3.132 (0.680-3.990)	13.75	99
25+35+35	3.01	3.34	3.34	-	-	9.70 (2.60-12.30)	2.700 (0.630-3.815)	11.86	99
25+35+50	2.46	2.73	4.91	-	-	10.10 (2.60-12.60)	3.068 (0.680-4.010)	13.47	99
25+35+60	2.42	2.68	5.30	-	-	10.40 (2.70-12.60)	3.134 (0.680-4.000)	13.76	99
25+35+71	2.44	2.71	5.35	-	-	10.50 (2.70-12.60)	3.170 (0.680-3.990)	13.92	99
25+42+42	2.53	3.79	3.79	-	-	10.10 (2.60-12.60)	3.060 (0.680-4.010)	13.44	99
25+42+50	2.29	3.43	4.58	-	-	10.30 (2.70-12.60)	3.121 (0.680-4.010)	13.71	99
25+42+60	2.24	3.36	4.91	-	-	10.50 (2.70-12.60)	3.180 (0.680-4.000)	13.97	99
25+42+71	2.24	3.36	4.91	-	-	10.50 (2.70-12.60)	3.170 (0.680-3.990)	13.92	99
25+50+50	2.10	4.20	4.20	-	-	10.50 (2.70-12.60)	3.182 (0.680-4.010)	13.97	99
25+50+60	2.02	4.04	4.44	-	-	10.50 (2.70-12.60)	3.180 (0.680-4.000)	13.97	99
25+50+71	2.02	4.04	4.44	-	-	10.50 (2.70-12.60)	3.170 (0.680-3.990)	13.92	99
25+60+60	1.95	4.28	4.28	-	-	10.50 (2.70-12.60)	3.170 (0.680-3.990)	13.92	99
25+60+71	1.95	4.28	4.28	-	-	10.50 (2.70-12.60)	3.160 (0.680-3.980)	13.88	99
25+71+71	1.95	4.28	4.28	-	-	10.50 (2.70-12.60)	3.150 (0.680-3.970)	13.83	99

MXZ-5D102VA HEATING

Indoor units combination	Heating capacity (kW)						Outdoor unit power consumption(kW)	Current (A)	Power factor(%)
	Unit A	Unit B	Unit C	Unit D	Unit E	Total			
35+35+35	3.33	3.33	3.33	-	-	10.00 (2.60-12.60)	3.030 (0.680-4.010)	13.31	99
35+35+42	3.04	3.04	4.11	-	-	10.20 (2.60-12.60)	3.083 (0.680-4.010)	13.54	99
35+35+50	2.74	2.74	4.93	-	-	10.40 (2.70-12.60)	3.144 (0.680-4.010)	13.81	99
35+35+60	2.64	2.64	5.22	-	-	10.50 (2.70-12.60)	3.180 (0.680-4.000)	13.97	99
35+35+71	2.64	2.64	5.22	-	-	10.50 (2.70-12.60)	3.170 (0.680-3.990)	13.92	99
35+42+42	2.78	3.76	3.76	-	-	10.30 (2.70-12.60)	3.137 (0.680-4.010)	13.78	99
35+42+50	2.53	3.42	4.55	-	-	10.50 (2.70-12.60)	3.190 (0.680-4.010)	14.01	99
35+42+60	2.43	3.28	4.79	-	-	10.50 (2.70-12.60)	3.180 (0.680-4.000)	13.97	99
35+42+71	2.43	3.28	4.79	-	-	10.50 (2.70-12.60)	3.170 (0.680-3.990)	13.92	99
35+50+50	2.28	4.11	4.11	-	-	10.50 (2.70-12.60)	3.190 (0.680-4.010)	14.01	99
35+50+60	2.20	3.96	4.34	-	-	10.50 (2.70-12.60)	3.180 (0.680-4.000)	13.97	99
35+50+71	2.20	3.96	4.34	-	-	10.50 (2.70-12.60)	3.170 (0.680-3.990)	13.92	99
35+60+60	2.12	4.19	4.19	-	-	10.50 (2.70-12.60)	3.170 (0.680-3.990)	13.92	99
35+60+71	2.12	4.19	4.19	-	-	10.50 (2.70-12.60)	3.160 (0.680-3.980)	13.88	99
42+42+42	3.50	3.50	3.50	-	-	10.50 (2.70-12.60)	3.190 (0.680-4.010)	14.01	99
42+42+50	3.15	3.15	4.20	-	-	10.50 (2.70-12.60)	3.190 (0.680-4.010)	14.01	99
42+42+60	3.03	3.03	4.44	-	-	10.50 (2.70-12.60)	3.180 (0.680-4.000)	13.97	99
42+42+71	3.03	3.03	4.44	-	-	10.50 (2.70-12.60)	3.170 (0.680-3.990)	13.92	99
42+50+50	2.86	3.82	3.82	-	-	10.50 (2.70-12.60)	3.190 (0.680-4.010)	14.01	99
42+50+60	2.77	3.69	4.05	-	-	10.50 (2.70-12.60)	3.180 (0.680-4.000)	13.97	99
42+50+71	2.77	3.69	4.05	-	-	10.50 (2.70-12.60)	3.170 (0.680-3.990)	13.92	99
42+60+60	2.67	3.91	3.91	-	-	10.50 (2.70-12.60)	3.170 (0.680-3.990)	13.92	99
50+50+50	3.50	3.50	3.50	-	-	10.50 (2.70-12.60)	3.190 (0.680-4.010)	14.01	99
50+50+60	3.39	3.39	3.72	-	-	10.50 (2.70-12.60)	3.180 (0.680-4.000)	13.97	99
50+50+71	3.39	3.39	3.72	-	-	10.50 (2.70-12.60)	3.170 (0.680-3.990)	13.92	99
50+60+60	3.29	3.61	3.61	-	-	10.50 (2.70-12.60)	3.170 (0.680-3.990)	13.92	99
15+15+15+15	1.70	1.70	1.70	1.70	-	6.80 (3.40-8.80)	1.532 (0.790-4.100)	6.73	99
15+15+15+18	1.58	1.58	1.58	3.06	-	7.80 (3.40-9.90)	1.811 (0.740-4.055)	7.95	99
15+15+15+20	1.70	1.70	1.70	2.20	-	7.30 (3.40-10.00)	1.737 (0.790-4.025)	7.63	99
15+15+15+22	1.64	1.64	1.64	3.18	-	8.10 (3.40-10.50)	1.922 (0.740-3.995)	8.44	99
15+15+15+25	1.62	1.62	1.62	3.43	-	8.30 (3.40-10.90)	2.006 (0.740-3.950)	8.81	99
15+15+15+35	1.59	1.59	1.59	3.74	-	8.50 (3.40-11.20)	2.062 (0.740-4.100)	9.06	99
15+15+15+42	1.38	1.38	1.38	4.37	-	8.50 (3.40-11.20)	2.062 (0.740-3.945)	9.06	99
15+15+15+50	1.17	1.17	1.17	4.98	-	8.50 (3.40-11.20)	2.062 (0.740-3.910)	9.06	99
15+15+15+60	1.12	1.12	1.12	5.23	-	8.60 (3.40-11.20)	2.092 (0.740-3.890)	9.19	99
15+15+15+71	1.14	1.14	1.14	5.29	-	8.70 (3.40-11.20)	2.170 (0.740-3.880)	9.53	99
15+15+18+18	1.45	1.45	2.81	2.81	-	8.50 (3.40-11.10)	2.090 (0.690-4.010)	9.18	99
15+15+18+20	1.60	1.60	3.11	2.08	-	8.40 (3.40-11.10)	2.015 (0.740-3.980)	8.85	99
15+15+18+22	1.50	1.50	2.90	2.90	-	8.80 (3.40-11.60)	2.201 (0.690-3.950)	9.67	99
15+15+18+25	1.49	1.49	2.88	3.15	-	9.00 (3.40-11.90)	2.257 (0.690-3.945)	9.91	99
15+15+18+35	1.43	1.43	2.78	3.36	-	9.00 (3.40-11.90)	2.257 (0.690-4.035)	9.91	99

MXZ-5D102VA HEATING

Indoor units combination	Heating capacity (kW)						Outdoor unit power consumption(kW)	Current (A)	Power factor(%)
	Unit A	Unit B	Unit C	Unit D	Unit E	Total			
15+15+18+42	1.26	1.26	2.45	4.02	-	9.00 (3.40-11.90)	2.257 (0.690-3.915)	9.91	99
15+15+18+50	1.10	1.10	2.14	4.66	-	9.00 (3.40-11.90)	2.257 (0.690-3.905)	9.91	99
15+15+18+60	1.06	1.06	2.06	4.92	-	9.10 (3.40-11.90)	2.311 (0.690-3.890)	10.15	99
15+15+18+71	1.07	1.07	2.08	4.98	-	9.20 (3.40-11.90)	2.389 (0.690-3.880)	10.49	99
15+15+20+20	1.70	1.70	2.20	2.20	-	7.80 (3.40-11.20)	1.941 (0.790-3.950)	8.52	99
15+15+20+22	1.66	1.66	2.15	3.23	-	8.70 (3.40-11.70)	2.127 (0.740-3.920)	9.34	99
15+15+20+25	1.61	1.61	2.08	3.40	-	8.70 (3.40-11.70)	2.127 (0.740-3.990)	9.34	99
15+15+20+35	1.54	1.54	1.99	3.63	-	8.70 (3.40-11.70)	2.127 (0.740-3.990)	9.34	99
15+15+20+42	1.34	1.34	1.74	4.27	-	8.70 (3.40-11.70)	2.127 (0.740-3.915)	9.34	99
15+15+20+50	1.16	1.16	1.50	4.89	-	8.70 (3.40-11.70)	2.127 (0.740-3.900)	9.34	99
15+15+20+60	1.11	1.11	1.43	5.15	-	8.80 (3.40-11.70)	2.197 (0.740-3.890)	9.65	99
15+15+20+71	1.13	1.13	1.47	5.27	-	9.00 (3.40-11.70)	2.275 (0.740-3.880)	9.99	99
15+15+22+22	1.53	1.53	2.97	2.97	-	9.00 (3.40-11.90)	2.257 (0.690-3.965)	9.91	99
15+15+22+25	1.49	1.49	2.88	3.15	-	9.00 (3.40-11.90)	2.257 (0.690-4.035)	9.91	99
15+15+22+35	1.43	1.43	2.78	3.36	-	9.00 (3.40-11.90)	2.257 (0.690-3.945)	9.91	99
15+15+22+42	1.26	1.26	2.45	4.02	-	9.00 (3.40-11.90)	2.257 (0.690-3.910)	9.91	99
15+15+22+60	1.07	1.07	2.08	4.98	-	9.20 (3.40-11.90)	2.343 (0.690-3.890)	10.29	99
15+15+22+71	1.08	1.08	2.10	5.03	-	9.30 (3.40-11.90)	2.421 (0.690-3.880)	10.63	99
15+15+25+25	1.44	1.44	3.06	3.06	-	9.00 (3.40-11.90)	2.257 (0.690-4.100)	9.91	99
15+15+25+35	1.39	1.39	2.95	3.27	-	9.00 (3.40-11.90)	2.257 (0.690-3.915)	9.91	99
15+15+25+42	1.23	1.23	2.61	3.92	-	9.00 (3.40-11.90)	2.257 (0.690-3.905)	9.91	99
15+15+25+50	1.09	1.09	2.31	4.61	-	9.10 (3.40-11.90)	2.297 (0.690-3.900)	10.09	99
15+15+25+60	1.05	1.05	2.22	4.88	-	9.20 (3.40-11.90)	2.367 (0.690-3.890)	10.40	99
15+15+25+71	1.06	1.06	2.25	4.93	-	9.30 (3.40-11.90)	2.445 (0.690-3.880)	10.74	99
15+15+35+35	1.34	1.34	3.16	3.16	-	9.00 (3.40-11.90)	2.257 (0.690-3.900)	9.91	99
15+15+35+42	1.21	1.21	2.84	3.84	-	9.10 (3.40-11.90)	2.313 (0.690-3.900)	10.16	99
15+15+35+50	1.07	1.07	2.52	4.54	-	9.20 (3.40-11.90)	2.377 (0.690-3.900)	10.44	99
15+15+35+60	1.03	1.03	2.43	4.80	-	9.30 (3.40-11.90)	2.447 (0.690-3.890)	10.75	99
15+15+35+71	1.06	1.06	2.48	4.91	-	9.50 (3.40-11.90)	2.525 (0.690-3.880)	11.09	99
15+15+42+42	1.10	1.10	3.50	3.50	-	9.20 (3.40-11.90)	2.369 (0.690-3.900)	10.40	99
15+15+42+50	0.99	0.99	3.14	4.19	-	9.30 (3.40-11.90)	2.433 (0.690-3.900)	10.69	99
15+15+42+60	0.96	0.96	3.04	4.45	-	9.40 (3.40-11.90)	2.503 (0.690-3.890)	10.99	99
15+15+42+71	0.97	0.97	3.07	4.49	-	9.50 (3.40-11.90)	2.557 (0.690-3.880)	11.23	99
15+15+50+50	0.90	0.90	3.80	3.80	-	9.40 (3.40-11.90)	2.497 (0.690-3.900)	10.97	99
15+15+50+60	0.87	0.87	3.70	4.06	-	9.50 (3.40-11.90)	2.567 (0.690-3.890)	11.27	99
15+15+50+71	0.87	0.87	3.70	4.06	-	9.50 (3.40-11.90)	2.557 (0.690-3.880)	11.23	99
15+15+60+60	0.84	0.84	3.91	3.91	-	9.50 (3.40-11.90)	2.557 (0.690-3.880)	11.23	99
15+15+60+71	0.84	0.84	3.91	3.91	-	9.50 (3.40-11.90)	2.547 (0.690-3.870)	11.19	99
15+15+71+71	0.84	0.84	3.91	3.91	-	9.50 (3.40-11.90)	2.537 (0.690-3.860)	11.14	99
15+18+18+18	1.36	2.65	2.65	2.65	-	9.30 (3.40-12.20)	2.368 (0.640-3.965)	10.40	99
15+18+18+20	1.47	2.86	2.86	1.91	-	9.10 (3.40-12.30)	2.294 (0.690-3.935)	10.07	99

MXZ-5D102VA HEATING

Indoor units combination	Heating capacity (kW)						Outdoor unit power consumption(kW)	Current (A)	Power factor(%)
	Unit A	Unit B	Unit C	Unit D	Unit E	Total			
15+18+18+22	1.39	2.70	2.70	2.70	-	9.50 (3.40-12.60)	2.452 (0.640-3.945)	10.77	99
15+18+18+25	1.36	2.63	2.63	2.87	-	9.50 (3.40-12.60)	2.452 (0.640-4.010)	10.77	99
15+18+18+35	1.31	2.55	2.55	3.09	-	9.50 (3.40-12.60)	2.452 (0.640-3.965)	10.77	99
15+18+18+42	1.18	2.29	2.29	3.74	-	9.50 (3.40-12.60)	2.452 (0.640-3.910)	10.77	99
15+18+18+50	1.04	2.02	2.02	4.41	-	9.50 (3.40-12.60)	2.460 (0.640-3.900)	10.80	99
15+18+18+60	1.01	1.96	1.96	4.68	-	9.60 (3.40-12.60)	2.530 (0.640-3.890)	11.11	99
15+18+18+71	1.03	2.00	2.00	4.78	-	9.80 (3.40-12.60)	2.608 (0.640-3.880)	11.45	99
15+18+20+20	1.61	3.12	2.08	2.08	-	8.90 (3.40-12.20)	2.192 (0.740-3.945)	9.63	99
15+18+20+22	1.49	2.89	1.93	2.89	-	9.20 (3.40-12.40)	2.322 (0.690-3.990)	10.20	99
15+18+20+25	1.45	2.81	1.87	3.07	-	9.20 (3.40-12.40)	2.322 (0.690-4.055)	10.20	99
15+18+20+35	1.40	2.71	1.81	3.29	-	9.20 (3.40-12.40)	2.322 (0.690-3.920)	10.20	99
15+18+20+42	1.24	2.41	1.61	3.94	-	9.20 (3.40-12.40)	2.322 (0.690-3.910)	10.20	99
15+18+20+50	1.09	2.11	1.41	4.60	-	9.20 (3.40-12.40)	2.346 (0.690-3.900)	10.30	99
15+18+20+60	1.06	2.05	1.37	4.92	-	9.40 (3.40-12.40)	2.416 (0.690-3.890)	10.61	99
15+18+20+71	1.07	2.08	1.38	4.97	-	9.50 (3.40-12.40)	2.494 (0.690-3.880)	10.95	99
15+18+22+22	1.39	2.70	2.70	2.70	-	9.50 (3.40-12.60)	2.452 (0.640-4.035)	10.77	99
15+18+22+25	1.36	2.63	2.63	2.87	-	9.50 (3.40-12.60)	2.452 (0.640-4.100)	10.77	99
15+18+22+35	1.31	2.55	2.55	3.09	-	9.50 (3.40-12.60)	2.452 (0.640-3.915)	10.77	99
15+18+22+42	1.18	2.29	2.29	3.74	-	9.50 (3.40-12.60)	2.452 (0.640-3.905)	10.77	99
15+18+22+50	1.05	2.04	2.04	4.46	-	9.60 (3.40-12.60)	2.492 (0.640-3.900)	10.94	99
15+18+22+60	1.02	1.98	1.98	4.73	-	9.70 (3.40-12.60)	2.562 (0.640-3.890)	11.25	99
15+18+22+71	1.03	2.00	2.00	4.78	-	9.80 (3.40-12.60)	2.640 (0.640-3.880)	11.59	99
15+18+25+25	1.32	2.57	2.80	2.80	-	9.50 (3.40-12.60)	2.452 (0.640-4.035)	10.77	99
15+18+25+35	1.28	2.49	2.71	3.02	-	9.50 (3.40-12.60)	2.452 (0.640-3.910)	10.77	99
15+18+25+42	1.15	2.24	2.44	3.66	-	9.50 (3.40-12.60)	2.452 (0.640-3.900)	10.77	99
15+18+25+50	1.03	2.01	2.19	4.37	-	9.60 (3.40-12.60)	2.516 (0.640-3.900)	11.05	99
15+18+25+60	1.00	1.94	2.12	4.64	-	9.70 (3.40-12.60)	2.586 (0.640-3.890)	11.36	99
15+18+25+71	1.02	1.98	2.16	4.74	-	9.90 (3.40-12.60)	2.664 (0.640-3.880)	11.70	99
15+18+35+35	1.24	2.41	2.92	2.92	-	9.50 (3.40-12.60)	2.476 (0.640-3.900)	10.87	99
15+18+35+42	1.13	2.20	2.67	3.60	-	9.60 (3.40-12.60)	2.532 (0.640-3.900)	11.12	99
15+18+35+50	1.02	1.98	2.40	4.31	-	9.70 (3.40-12.60)	2.596 (0.640-3.900)	11.40	99
15+18+35+60	1.00	1.93	2.34	4.63	-	9.90 (3.40-12.60)	2.666 (0.640-3.890)	11.71	99
15+18+35+71	1.01	1.95	2.37	4.67	-	10.00 (3.40-12.60)	2.744 (0.640-3.880)	12.05	99
15+18+42+42	1.04	2.03	3.32	3.32	-	9.70 (3.40-12.60)	2.588 (0.640-3.900)	11.37	99
15+18+42+50	0.95	1.84	3.01	4.01	-	9.80 (3.40-12.60)	2.652 (0.640-3.900)	11.65	99
15+18+42+60	0.92	1.79	2.92	4.27	-	9.90 (3.40-12.60)	2.722 (0.640-3.890)	11.95	99
15+18+42+71	0.93	1.80	2.95	4.32	-	10.00 (3.40-12.60)	2.752 (0.640-3.880)	12.09	99
15+18+50+50	0.87	1.68	3.67	3.67	-	9.90 (3.40-12.60)	2.716 (0.640-3.900)	11.93	99
15+18+50+60	0.85	1.64	3.58	3.93	-	10.00 (3.40-12.60)	2.762 (0.640-3.890)	12.13	99
15+18+50+71	0.85	1.64	3.58	3.93	-	10.00 (3.40-12.60)	2.752 (0.640-3.880)	12.09	99
15+18+60+60	0.82	1.59	3.80	3.80	-	10.00 (3.40-12.60)	2.752 (0.640-3.880)	12.09	99

MXZ-5D102VA HEATING

Indoor units combination	Heating capacity (kW)						Outdoor unit power consumption(kW)	Current (A)	Power factor(%)
	Unit A	Unit B	Unit C	Unit D	Unit E	Total			
15+18+60+71	0.82	1.59	3.80	3.80	-	10.00 (3.40-12.60)	2.742 (0.640-3.870)	12.04	99
15+20+20+20	1.70	2.20	2.20	2.20	-	8.30 (3.40-12.00)	2.062 (0.790-3.990)	9.06	99
15+20+20+22	1.61	2.08	2.08	3.12	-	8.90 (3.40-12.20)	2.192 (0.740-4.035)	9.63	99
15+20+20+25	1.56	2.02	2.02	3.30	-	8.90 (3.40-12.20)	2.192 (0.740-4.100)	9.63	99
15+20+20+35	1.50	1.94	1.94	3.52	-	8.90 (3.40-12.20)	2.192 (0.740-3.915)	9.63	99
15+20+20+42	1.32	1.70	1.70	4.18	-	8.90 (3.40-12.20)	2.192 (0.740-3.905)	9.63	99
15+20+20+50	1.15	1.49	1.49	4.87	-	9.00 (3.40-12.20)	2.232 (0.740-3.900)	9.80	99
15+20+20+60	1.11	1.43	1.43	5.14	-	9.10 (3.40-12.20)	2.302 (0.740-3.890)	10.11	99
15+20+20+71	1.12	1.45	1.45	5.19	-	9.20 (3.40-12.20)	2.380 (0.740-3.880)	10.45	99
15+20+22+22	1.49	1.93	2.89	2.89	-	9.20 (3.40-12.40)	2.322 (0.690-4.080)	10.20	99
15+20+22+25	1.45	1.87	2.81	3.07	-	9.20 (3.40-12.40)	2.322 (0.690-4.055)	10.20	99
15+20+22+35	1.40	1.81	2.71	3.29	-	9.20 (3.40-12.40)	2.322 (0.690-3.915)	10.20	99
15+20+22+42	1.24	1.61	2.41	3.94	-	9.20 (3.40-12.40)	2.322 (0.690-3.900)	10.20	99
15+20+22+50	1.10	1.42	2.13	4.65	-	9.30 (3.40-12.40)	2.378 (0.690-3.900)	10.44	99
15+20+22+60	1.06	1.37	2.05	4.92	-	9.40 (3.40-12.40)	2.448 (0.690-3.890)	10.75	99
15+20+22+71	1.08	1.40	2.10	5.02	-	9.60 (3.40-12.40)	2.526 (0.690-3.880)	11.09	99
15+20+25+25	1.41	1.82	2.98	2.98	-	9.20 (3.40-12.40)	2.322 (0.690-3.990)	10.20	99
15+20+25+35	1.36	1.76	2.88	3.20	-	9.20 (3.40-12.40)	2.322 (0.690-3.910)	10.20	99
15+20+25+50	1.08	1.39	2.28	4.56	-	9.30 (3.40-12.40)	2.402 (0.690-3.900)	10.55	99
15+20+25+60	1.05	1.36	2.22	4.87	-	9.50 (3.40-12.40)	2.472 (0.690-3.890)	10.86	99
15+20+25+71	1.06	1.37	2.24	4.92	-	9.60 (3.40-12.40)	2.550 (0.690-3.880)	11.20	99
15+20+35+35	1.33	1.72	3.13	3.13	-	9.30 (3.40-12.40)	2.362 (0.690-3.900)	10.37	99
15+20+35+42	1.20	1.55	2.83	3.82	-	9.40 (3.40-12.40)	2.418 (0.690-3.900)	10.62	99
15+20+35+50	1.07	1.38	2.52	4.53	-	9.50 (3.40-12.40)	2.482 (0.690-3.900)	10.90	99
15+20+35+60	1.03	1.34	2.43	4.80	-	9.60 (3.40-12.40)	2.552 (0.690-3.890)	11.21	99
15+20+35+71	1.04	1.35	2.46	4.85	-	9.70 (3.40-12.40)	2.622 (0.690-3.880)	11.52	99
15+20+42+42	1.09	1.41	3.45	3.45	-	9.40 (3.40-12.40)	2.474 (0.690-3.900)	10.87	99
15+20+42+50	0.98	1.27	3.11	4.15	-	9.50 (3.40-12.40)	2.538 (0.690-3.900)	11.15	99
15+20+42+60	0.96	1.24	3.05	4.46	-	9.70 (3.40-12.40)	2.608 (0.690-3.890)	11.45	99
15+20+42+71	0.96	1.24	3.05	4.46	-	9.70 (3.40-12.40)	2.622 (0.690-3.880)	11.52	99
15+20+50+50	0.89	1.15	3.78	3.78	-	9.60 (3.40-12.40)	2.602 (0.690-3.900)	11.43	99
15+20+50+60	0.87	1.12	3.68	4.03	-	9.70 (3.40-12.40)	2.632 (0.690-3.890)	11.56	99
15+20+50+71	0.87	1.12	3.68	4.03	-	9.70 (3.40-12.40)	2.622 (0.690-3.880)	11.52	99
15+20+60+60	0.84	1.08	3.89	3.89	-	9.70 (3.40-12.40)	2.622 (0.690-3.880)	11.52	99
15+20+60+71	0.84	1.08	3.89	3.89	-	9.70 (3.40-12.40)	2.612 (0.690-3.870)	11.47	99
15+22+22+22	1.39	2.70	2.70	2.70	-	9.50 (3.40-12.60)	2.452 (0.640-4.080)	10.77	99
15+22+22+25	1.36	2.63	2.63	2.87	-	9.50 (3.40-12.60)	2.452 (0.640-4.010)	10.77	99
15+22+22+35	1.31	2.55	2.55	3.09	-	9.50 (3.40-12.60)	2.452 (0.640-3.910)	10.77	99
15+22+22+42	1.18	2.29	2.29	3.74	-	9.50 (3.40-12.60)	2.460 (0.640-3.900)	10.80	99
15+22+22+50	1.05	2.04	2.04	4.46	-	9.60 (3.40-12.60)	2.524 (0.640-3.900)	11.08	99
15+22+22+60	1.02	1.98	1.98	4.73	-	9.70 (3.40-12.60)	2.594 (0.640-3.890)	11.39	99

MXZ-5D102VA HEATING

Indoor units combination	Heating capacity (kW)						Outdoor unit power consumption(kW)	Current (A)	Power factor(%)
	Unit A	Unit B	Unit C	Unit D	Unit E	Total			
15+22+22+71	1.04	2.02	2.02	4.83	-	9.90 (3.40-12.60)	2.672 (0.640-3.880)	11.73	99
15+22+25+25	1.32	2.57	2.80	2.80	-	9.50 (3.40-12.60)	2.452 (0.640-3.945)	10.77	99
15+22+25+35	1.28	2.49	2.71	3.02	-	9.50 (3.40-12.60)	2.452 (0.640-3.905)	10.77	99
15+22+25+42	1.17	2.26	2.47	3.70	-	9.60 (3.40-12.60)	2.484 (0.640-3.900)	10.91	99
15+22+25+50	1.04	2.03	2.21	4.42	-	9.70 (3.40-12.60)	2.548 (0.640-3.900)	11.19	99
15+22+25+60	1.01	1.96	2.14	4.69	-	9.80 (3.40-12.60)	2.618 (0.640-3.890)	11.50	99
15+22+25+71	1.02	1.98	2.16	4.74	-	9.90 (3.40-12.60)	2.696 (0.640-3.880)	11.84	99
15+22+35+35	1.26	2.44	2.95	2.95	-	9.60 (3.40-12.60)	2.508 (0.640-3.900)	11.01	99
15+22+35+42	1.15	2.22	2.69	3.64	-	9.70 (3.40-12.60)	2.564 (0.640-3.900)	11.26	99
15+22+35+50	1.03	2.00	2.42	4.36	-	9.80 (3.40-12.60)	2.628 (0.640-3.900)	11.54	99
15+22+35+60	1.00	1.93	2.34	4.63	-	9.90 (3.40-12.60)	2.698 (0.640-3.890)	11.85	99
15+22+35+71	1.01	1.95	2.37	4.67	-	10.00 (3.40-12.60)	2.752 (0.640-3.880)	12.09	99
15+22+42+42	1.05	2.05	3.35	3.35	-	9.80 (3.40-12.60)	2.620 (0.640-3.900)	11.51	99
15+22+42+50	0.96	1.86	3.04	4.05	-	9.90 (3.40-12.60)	2.684 (0.640-3.900)	11.79	99
15+22+42+60	0.93	1.80	2.95	4.32	-	10.00 (3.40-12.60)	2.754 (0.640-3.890)	12.09	99
15+22+42+71	0.93	1.80	2.95	4.32	-	10.00 (3.40-12.60)	2.752 (0.640-3.880)	12.09	99
15+22+50+50	0.88	1.70	3.71	3.71	-	10.00 (3.40-12.60)	2.748 (0.640-3.900)	12.07	99
15+22+50+60	0.85	1.64	3.58	3.93	-	10.00 (3.40-12.60)	2.762 (0.640-3.890)	12.13	99
15+22+50+71	0.85	1.64	3.58	3.93	-	10.00 (3.40-12.60)	2.752 (0.640-3.880)	12.09	99
15+22+60+60	0.82	1.59	3.80	3.80	-	10.00 (3.40-12.60)	2.752 (0.640-3.880)	12.09	99
15+22+60+71	0.82	1.59	3.80	3.80	-	10.00 (3.40-12.60)	2.742 (0.640-3.870)	12.04	99
15+25+25+25	1.29	2.74	2.74	2.74	-	9.50 (3.40-12.60)	2.452 (0.640-3.915)	10.77	99
15+25+25+35	1.25	2.65	2.65	2.95	-	9.50 (3.40-12.60)	2.452 (0.640-3.900)	10.77	99
15+25+25+42	1.14	2.42	2.42	3.63	-	9.60 (3.40-12.60)	2.508 (0.640-3.900)	11.01	99
15+25+25+50	1.02	2.17	2.17	4.34	-	9.70 (3.40-12.60)	2.572 (0.640-3.900)	11.30	99
15+25+25+60	0.99	2.10	2.10	4.61	-	9.80 (3.40-12.60)	2.642 (0.640-3.890)	11.60	99
15+25+25+71	1.01	2.14	2.14	4.70	-	10.00 (3.40-12.60)	2.720 (0.640-3.880)	11.95	99
15+25+35+35	1.23	2.60	2.89	2.89	-	9.60 (3.40-12.60)	2.532 (0.640-3.900)	11.12	99
15+25+35+42	1.12	2.38	2.64	3.56	-	9.70 (3.40-12.60)	2.588 (0.640-3.900)	11.37	99
15+25+35+50	1.01	2.14	2.38	4.28	-	9.80 (3.40-12.60)	2.652 (0.640-3.900)	11.65	99
15+25+35+60	0.98	2.07	2.30	4.55	-	9.90 (3.40-12.60)	2.722 (0.640-3.890)	11.95	99
15+25+35+71	0.99	2.09	2.33	4.59	-	10.00 (3.40-12.60)	2.752 (0.640-3.880)	12.09	99
15+25+42+42	1.03	2.19	3.29	3.29	-	9.80 (3.40-12.60)	2.644 (0.640-3.900)	11.61	99
15+25+42+50	0.94	1.99	2.99	3.98	-	9.90 (3.40-12.60)	2.708 (0.640-3.900)	11.89	99
15+25+42+60	0.91	1.94	2.90	4.25	-	10.00 (3.40-12.60)	2.762 (0.640-3.890)	12.13	99
15+25+42+71	0.91	1.94	2.90	4.25	-	10.00 (3.40-12.60)	2.752 (0.640-3.880)	12.09	99
15+25+50+50	0.86	1.83	3.65	3.65	-	10.00 (3.40-12.60)	2.772 (0.640-3.900)	12.17	99
15+25+50+60	0.83	1.76	3.53	3.87	-	10.00 (3.40-12.60)	2.762 (0.640-3.890)	12.13	99
15+25+50+71	0.83	1.76	3.53	3.87	-	10.00 (3.40-12.60)	2.752 (0.640-3.880)	12.09	99
15+25+60+60	0.81	1.71	3.74	3.74	-	10.00 (3.40-12.60)	2.752 (0.640-3.880)	12.09	99
15+25+60+71	0.81	1.71	3.74	3.74	-	10.00 (3.40-12.60)	2.742 (0.640-3.870)	12.04	99

MXZ-5D102VA HEATING

Indoor units combination	Heating capacity (kW)						Outdoor unit power consumption(kW)	Current (A)	Power factor(%)
	Unit A	Unit B	Unit C	Unit D	Unit E	Total			
15+35+35+35	1.22	2.86	2.86	2.86	-	9.80 (3.40-12.60)	2.612 (0.640-3.900)	11.47	99
15+35+35+42	1.10	2.60	2.60	3.50	-	9.80 (3.40-12.60)	2.668 (0.640-3.900)	11.72	99
15+35+35+50	1.00	2.34	2.34	4.22	-	9.90 (3.40-12.60)	2.732 (0.640-3.900)	12.00	99
15+35+35+60	0.97	2.27	2.27	4.49	-	10.00 (3.40-12.60)	2.762 (0.640-3.890)	12.13	99
15+35+35+71	0.97	2.27	2.27	4.49	-	10.00 (3.40-12.60)	2.752 (0.640-3.880)	12.09	99
15+35+42+42	1.02	2.40	3.24	3.24	-	9.90 (3.40-12.60)	2.724 (0.640-3.900)	11.96	99
15+35+42+50	0.93	2.19	2.95	3.93	-	10.00 (3.40-12.60)	2.772 (0.640-3.900)	12.17	99
15+35+42+60	0.89	2.11	2.84	4.16	-	10.00 (3.40-12.60)	2.762 (0.640-3.890)	12.13	99
15+35+42+71	0.89	2.11	2.84	4.16	-	10.00 (3.40-12.60)	2.752 (0.640-3.880)	12.09	99
15+35+50+50	0.85	1.99	3.58	3.58	-	10.00 (3.40-12.60)	2.772 (0.640-3.900)	12.17	99
15+35+50+60	0.82	1.92	3.46	3.80	-	10.00 (3.40-12.60)	2.762 (0.640-3.890)	12.13	99
15+35+50+71	0.82	1.92	3.46	3.80	-	10.00 (3.40-12.60)	2.752 (0.640-3.880)	12.09	99
15+35+60+60	0.79	1.86	3.67	3.67	-	10.00 (3.40-12.60)	2.752 (0.640-3.880)	12.09	99
15+42+42+42	0.95	3.02	3.02	3.02	-	10.00 (3.40-12.60)	2.772 (0.640-3.900)	12.17	99
15+42+42+50	0.86	2.74	2.74	3.65	-	10.00 (3.40-12.60)	2.772 (0.640-3.900)	12.17	99
15+42+42+60	0.83	2.65	2.65	3.87	-	10.00 (3.40-12.60)	2.762 (0.640-3.890)	12.13	99
15+42+42+71	0.83	2.65	2.65	3.87	-	10.00 (3.40-12.60)	2.752 (0.640-3.880)	12.09	99
15+42+50+50	0.79	2.51	3.35	3.35	-	10.00 (3.40-12.60)	2.772 (0.640-3.900)	12.17	99
15+42+50+60	0.77	2.43	3.24	3.56	-	10.00 (3.40-12.60)	2.762 (0.640-3.890)	12.13	99
15+50+50+50	0.73	3.09	3.09	3.09	-	10.00 (3.40-12.60)	2.772 (0.640-3.900)	12.17	99
18+18+18+18	2.50	2.50	2.50	2.50	-	10.00 (3.40-13.30)	2.647 (0.590-3.920)	11.62	99
18+18+18+20	2.65	2.65	2.65	1.76	-	9.70 (3.40-13.10)	2.517 (0.640-3.965)	11.05	99
18+18+18+22	2.50	2.50	2.50	2.50	-	10.00 (3.40-13.30)	2.647 (0.590-4.010)	11.62	99
18+18+18+25	2.44	2.44	2.44	2.67	-	10.00 (3.40-13.30)	2.647 (0.590-4.080)	11.62	99
18+18+18+35	2.37	2.37	2.37	2.88	-	10.00 (3.40-13.30)	2.647 (0.590-3.920)	11.62	99
18+18+18+42	2.16	2.16	2.16	3.53	-	10.00 (3.40-13.30)	2.647 (0.590-3.905)	11.62	99
18+18+18+50	1.95	1.95	1.95	4.25	-	10.10 (3.40-13.30)	2.679 (0.590-3.900)	11.77	99
18+18+18+60	1.89	1.89	1.89	4.53	-	10.20 (3.40-13.30)	2.749 (0.590-3.890)	12.07	99
18+18+18+71	1.91	1.91	1.91	4.57	-	10.30 (3.40-13.30)	2.827 (0.590-3.880)	12.42	99
18+18+20+20	2.82	2.82	1.88	1.88	-	9.40 (3.40-12.90)	2.387 (0.690-4.010)	10.48	99
18+18+20+22	2.65	2.65	1.76	2.65	-	9.70 (3.40-13.10)	2.517 (0.640-4.055)	11.05	99
18+18+20+25	2.58	2.58	1.72	2.82	-	9.70 (3.40-13.10)	2.517 (0.640-4.080)	11.05	99
18+18+20+35	2.50	2.50	1.67	3.03	-	9.70 (3.40-13.10)	2.517 (0.640-3.915)	11.05	99
18+18+20+42	2.25	2.25	1.50	3.69	-	9.70 (3.40-13.10)	2.517 (0.640-3.905)	11.05	99
18+18+20+50	2.02	2.02	1.35	4.41	-	9.80 (3.40-13.10)	2.565 (0.640-3.900)	11.26	99
18+18+20+60	1.96	1.96	1.30	4.68	-	9.90 (3.40-13.10)	2.635 (0.640-3.890)	11.57	99
18+18+20+71	1.98	1.98	1.32	4.73	-	10.00 (3.40-13.10)	2.713 (0.640-3.880)	11.91	99
18+18+22+22	2.50	2.50	2.50	2.50	-	10.00 (3.40-13.30)	2.647 (0.590-4.100)	11.62	99
18+18+22+25	2.44	2.44	2.44	2.67	-	10.00 (3.40-13.30)	2.647 (0.590-4.035)	11.62	99
18+18+22+35	2.37	2.37	2.37	2.88	-	10.00 (3.40-13.30)	2.647 (0.590-3.910)	11.62	99
18+18+22+42	2.16	2.16	2.16	3.53	-	10.00 (3.40-13.30)	2.647 (0.590-3.900)	11.62	99

MXZ-5D102VA HEATING

Indoor units combination	Heating capacity (kW)						Outdoor unit power consumption(kW)	Current (A)	Power factor(%)
	Unit A	Unit B	Unit C	Unit D	Unit E	Total			
18+18+22+50	1.95	1.95	1.95	4.25	-	10.10 (3.40-13.30)	2.711 (0.590-3.900)	11.91	99
18+18+22+60	1.89	1.89	1.89	4.53	-	10.20 (3.40-13.30)	2.781 (0.590-3.890)	12.21	99
18+18+22+71	1.93	1.93	1.93	4.62	-	10.40 (3.40-13.30)	2.859 (0.590-3.880)	12.56	99
18+18+25+25	2.39	2.39	2.61	2.61	-	10.00 (3.40-13.30)	2.647 (0.590-3.965)	11.62	99
18+18+25+35	2.32	2.32	2.54	2.82	-	10.00 (3.40-13.30)	2.647 (0.590-3.905)	11.62	99
18+18+25+42	2.12	2.12	2.31	3.46	-	10.00 (3.40-13.30)	2.671 (0.590-3.900)	11.73	99
18+18+25+50	1.92	1.92	2.09	4.18	-	10.10 (3.40-13.30)	2.735 (0.590-3.900)	12.01	99
18+18+25+60	1.88	1.88	2.05	4.50	-	10.30 (3.40-13.30)	2.805 (0.590-3.890)	12.32	99
18+18+25+71	1.90	1.90	2.07	4.54	-	10.40 (3.40-13.30)	2.883 (0.590-3.880)	12.66	99
18+18+35+35	2.28	2.28	2.77	2.77	-	10.10 (3.40-13.30)	2.695 (0.590-3.900)	11.84	99
18+18+35+42	2.10	2.10	2.55	3.44	-	10.20 (3.40-13.30)	2.751 (0.590-3.900)	12.08	99
18+18+35+50	1.91	1.91	2.31	4.17	-	10.30 (3.40-13.30)	2.815 (0.590-3.900)	12.36	99
18+18+35+60	1.86	1.86	2.25	4.44	-	10.40 (3.40-13.30)	2.885 (0.590-3.890)	12.67	99
18+18+35+71	1.87	1.87	2.27	4.48	-	10.50 (3.40-13.30)	2.947 (0.590-3.880)	12.94	99
18+18+42+42	1.95	1.95	3.20	3.20	-	10.30 (3.40-13.30)	2.807 (0.590-3.900)	12.33	99
18+18+42+50	1.79	1.79	2.93	3.90	-	10.40 (3.40-13.30)	2.871 (0.590-3.900)	12.61	99
18+18+42+60	1.74	1.74	2.85	4.17	-	10.50 (3.40-13.30)	2.941 (0.590-3.890)	12.92	99
18+18+42+71	1.74	1.74	2.85	4.17	-	10.50 (3.40-13.30)	2.947 (0.590-3.880)	12.94	99
18+18+50+50	1.65	1.65	3.60	3.60	-	10.50 (3.40-13.30)	2.935 (0.590-3.900)	12.89	99
18+18+50+60	1.60	1.60	3.48	3.82	-	10.50 (3.40-13.30)	2.957 (0.590-3.890)	12.99	99
18+18+50+71	1.60	1.60	3.48	3.82	-	10.50 (3.40-13.30)	2.947 (0.590-3.880)	12.94	99
18+18+60+60	1.55	1.55	3.70	3.70	-	10.50 (3.40-13.30)	2.947 (0.590-3.880)	12.94	99
18+18+60+71	1.55	1.55	3.70	3.70	-	10.50 (3.40-13.30)	2.937 (0.590-3.870)	12.90	99
18+20+20+20	3.03	2.02	2.02	2.02	-	9.10 (3.40-12.70)	2.257 (0.740-4.055)	9.91	99
18+20+20+22	2.82	1.88	1.88	2.82	-	9.40 (3.40-12.90)	2.387 (0.690-4.100)	10.48	99
18+20+20+25	2.75	1.83	1.83	2.99	-	9.40 (3.40-12.90)	2.387 (0.690-4.035)	10.48	99
18+20+20+35	2.65	1.77	1.77	3.21	-	9.40 (3.40-12.90)	2.387 (0.690-3.910)	10.48	99
18+20+20+42	2.37	1.58	1.58	3.87	-	9.40 (3.40-12.90)	2.387 (0.690-3.900)	10.48	99
18+20+20+50	2.10	1.40	1.40	4.59	-	9.50 (3.40-12.90)	2.451 (0.690-3.900)	10.76	99
18+20+20+60	2.03	1.35	1.35	4.86	-	9.60 (3.40-12.90)	2.521 (0.690-3.890)	11.07	99
18+20+20+71	2.07	1.38	1.38	4.96	-	9.80 (3.40-12.90)	2.599 (0.690-3.880)	11.41	99
18+20+22+22	2.65	1.76	2.65	2.65	-	9.70 (3.40-13.10)	2.517 (0.640-4.055)	11.05	99
18+20+22+25	2.58	1.72	2.58	2.82	-	9.70 (3.40-13.10)	2.517 (0.640-3.990)	11.05	99
18+20+22+35	2.50	1.67	2.50	3.03	-	9.70 (3.40-13.10)	2.517 (0.640-3.910)	11.05	99
18+20+22+50	2.02	1.35	2.02	4.41	-	9.80 (3.40-13.10)	2.597 (0.640-3.900)	11.41	99
18+20+22+60	1.98	1.32	1.98	4.73	-	10.00 (3.40-13.10)	2.667 (0.640-3.890)	11.71	99
18+20+22+71	2.00	1.33	2.00	4.78	-	10.10 (3.40-13.10)	2.745 (0.640-3.880)	12.06	99
18+20+25+25	2.52	1.68	2.75	2.75	-	9.70 (3.40-13.10)	2.517 (0.640-3.920)	11.05	99
18+20+25+35	2.44	1.63	2.67	2.96	-	9.70 (3.40-13.10)	2.517 (0.640-3.905)	11.05	99
18+20+25+42	2.23	1.49	2.43	3.65	-	9.80 (3.40-13.10)	2.557 (0.640-3.900)	11.23	99
18+20+25+50	2.00	1.34	2.19	4.37	-	9.90 (3.40-13.10)	2.621 (0.640-3.900)	11.51	99

MXZ-5D102VA HEATING

Indoor units combination	Heating capacity (kW)						Outdoor unit power consumption(kW)	Current (A)	Power factor(%)
	Unit A	Unit B	Unit C	Unit D	Unit E	Total			
18+20+25+60	1.94	1.29	2.12	4.65	-	10.00 (3.40-13.10)	2.691 (0.640-3.890)	11.82	99
18+20+25+71	1.96	1.31	2.14	4.69	-	10.10 (3.40-13.10)	2.769 (0.640-3.880)	12.16	99
18+20+35+35	2.40	1.60	2.90	2.90	-	9.80 (3.40-13.10)	2.581 (0.640-3.900)	11.34	99
18+20+35+42	2.19	1.46	2.66	3.59	-	9.90 (3.40-13.10)	2.637 (0.640-3.900)	11.58	99
18+20+35+50	1.98	1.32	2.40	4.31	-	10.00 (3.40-13.10)	2.701 (0.640-3.900)	11.86	99
18+20+35+60	1.92	1.28	2.32	4.59	-	10.10 (3.40-13.10)	2.771 (0.640-3.890)	12.17	99
18+20+35+71	1.93	1.29	2.34	4.63	-	10.20 (3.40-13.10)	2.817 (0.640-3.880)	12.37	99
18+20+42+42	2.02	1.35	3.31	3.31	-	10.00 (3.40-13.10)	2.693 (0.640-3.900)	11.83	99
18+20+42+50	1.84	1.23	3.01	4.02	-	10.10 (3.40-13.10)	2.757 (0.640-3.900)	12.11	99
18+20+42+60	1.79	1.19	2.93	4.29	-	10.20 (3.40-13.10)	2.827 (0.640-3.890)	12.42	99
18+20+42+71	1.79	1.19	2.93	4.29	-	10.20 (3.40-13.10)	2.817 (0.640-3.880)	12.37	99
18+20+50+50	1.69	1.13	3.69	3.69	-	10.20 (3.40-13.10)	2.821 (0.640-3.900)	12.39	99
18+20+50+60	1.63	1.09	3.57	3.91	-	10.20 (3.40-13.10)	2.827 (0.640-3.890)	12.42	99
18+20+50+71	1.63	1.09	3.57	3.91	-	10.20 (3.40-13.10)	2.817 (0.640-3.880)	12.37	99
18+20+60+60	1.58	1.05	3.78	3.78	-	10.20 (3.40-13.10)	2.817 (0.640-3.880)	12.37	99
18+20+60+71	1.58	1.05	3.78	3.78	-	10.20 (3.40-13.10)	2.807 (0.640-3.870)	12.33	99
18+22+22+22	2.50	2.50	2.50	2.50	-	10.00 (3.40-13.30)	2.647 (0.590-4.010)	11.62	99
18+22+22+25	2.44	2.44	2.44	2.67	-	10.00 (3.40-13.30)	2.647 (0.590-3.945)	11.62	99
18+22+22+35	2.37	2.37	2.37	2.88	-	10.00 (3.40-13.30)	2.647 (0.590-3.905)	11.62	99
18+22+22+42	2.18	2.18	2.18	3.56	-	10.10 (3.40-13.30)	2.679 (0.590-3.900)	11.77	99
18+22+22+50	1.97	1.97	1.97	4.29	-	10.20 (3.40-13.30)	2.743 (0.590-3.900)	12.05	99
18+22+22+60	1.91	1.91	1.91	4.57	-	10.30 (3.40-13.30)	2.813 (0.590-3.890)	12.35	99
18+22+22+71	1.93	1.93	1.93	4.62	-	10.40 (3.40-13.30)	2.891 (0.590-3.880)	12.70	99
18+22+25+25	2.39	2.39	2.61	2.61	-	10.00 (3.40-13.30)	2.647 (0.590-3.915)	11.62	99
18+22+25+35	2.32	2.32	2.54	2.82	-	10.00 (3.40-13.30)	2.647 (0.590-3.900)	11.62	99
18+22+25+42	2.14	2.14	2.33	3.50	-	10.10 (3.40-13.30)	2.703 (0.590-3.900)	11.87	99
18+22+25+50	1.93	1.93	2.11	4.22	-	10.20 (3.40-13.30)	2.767 (0.590-3.900)	12.15	99
18+22+25+60	1.88	1.88	2.05	4.50	-	10.30 (3.40-13.30)	2.837 (0.590-3.890)	12.46	99
18+22+25+71	1.91	1.91	2.09	4.58	-	10.50 (3.40-13.30)	2.915 (0.590-3.880)	12.80	99
18+22+35+35	2.28	2.28	2.77	2.77	-	10.10 (3.40-13.30)	2.727 (0.590-3.900)	11.98	99
18+22+35+42	2.10	2.10	2.55	3.44	-	10.20 (3.40-13.30)	2.783 (0.590-3.900)	12.22	99
18+22+35+50	1.91	1.91	2.31	4.17	-	10.30 (3.40-13.30)	2.847 (0.590-3.900)	12.50	99
18+22+35+60	1.86	1.86	2.25	4.44	-	10.40 (3.40-13.30)	2.917 (0.590-3.890)	12.81	99
18+22+35+71	1.87	1.87	2.27	4.48	-	10.50 (3.40-13.30)	2.947 (0.590-3.880)	12.94	99
18+22+42+42	1.95	1.95	3.20	3.20	-	10.30 (3.40-13.30)	2.839 (0.590-3.900)	12.47	99
18+22+42+50	1.79	1.79	2.93	3.90	-	10.40 (3.40-13.30)	2.903 (0.590-3.900)	12.75	99
18+22+42+60	1.74	1.74	2.85	4.17	-	10.50 (3.40-13.30)	2.957 (0.590-3.890)	12.99	99
18+22+42+71	1.74	1.74	2.85	4.17	-	10.50 (3.40-13.30)	2.947 (0.590-3.880)	12.94	99
18+22+50+50	1.65	1.65	3.60	3.60	-	10.50 (3.40-13.30)	2.967 (0.590-3.900)	13.03	99
18+22+50+60	1.60	1.60	3.48	3.82	-	10.50 (3.40-13.30)	2.957 (0.590-3.890)	12.99	99
18+22+50+71	1.60	1.60	3.48	3.82	-	10.50 (3.40-13.30)	2.947 (0.590-3.880)	12.94	99

MXZ-5D102VA HEATING

Indoor units combination	Heating capacity (kW)						Outdoor unit power consumption(kW)	Current (A)	Power factor(%)
	Unit A	Unit B	Unit C	Unit D	Unit E	Total			
18+22+60+60	1.55	1.55	3.70	3.70	-	10.50 (3.40-13.30)	2.947 (0.590-3.880)	12.94	99
18+22+60+71	1.55	1.55	3.70	3.70	-	10.50 (3.40-13.30)	2.937 (0.590-3.870)	12.90	99
18+25+25+25	2.34	2.55	2.55	2.55	-	10.00 (3.40-13.30)	2.647 (0.590-3.910)	11.62	99
18+25+25+35	2.28	2.48	2.48	2.76	-	10.00 (3.40-13.30)	2.671 (0.590-3.900)	11.73	99
18+25+25+42	2.10	2.29	2.29	3.43	-	10.10 (3.40-13.30)	2.727 (0.590-3.900)	11.98	99
18+25+25+50	1.90	2.07	2.07	4.15	-	10.20 (3.40-13.30)	2.791 (0.590-3.900)	12.26	99
18+25+25+60	1.87	2.03	2.03	4.47	-	10.40 (3.40-13.30)	2.861 (0.590-3.890)	12.56	99
18+25+25+71	1.88	2.05	2.05	4.51	-	10.50 (3.40-13.30)	2.939 (0.590-3.880)	12.91	99
18+25+35+35	2.26	2.46	2.74	2.74	-	10.20 (3.40-13.30)	2.751 (0.590-3.900)	12.08	99
18+25+35+42	2.09	2.27	2.53	3.41	-	10.30 (3.40-13.30)	2.807 (0.590-3.900)	12.33	99
18+25+35+50	1.90	2.07	2.30	4.14	-	10.40 (3.40-13.30)	2.871 (0.590-3.900)	12.61	99
18+25+35+60	1.84	2.01	2.23	4.41	-	10.50 (3.40-13.30)	2.941 (0.590-3.890)	12.92	99
18+25+35+71	1.84	2.01	2.23	4.41	-	10.50 (3.40-13.30)	2.947 (0.590-3.880)	12.94	99
18+25+42+42	1.92	2.09	3.14	3.14	-	10.30 (3.40-13.30)	2.863 (0.590-3.900)	12.57	99
18+25+42+50	1.76	1.92	2.88	3.84	-	10.40 (3.40-13.30)	2.927 (0.590-3.900)	12.85	99
18+25+42+60	1.72	1.87	2.81	4.11	-	10.50 (3.40-13.30)	2.957 (0.590-3.890)	12.99	99
18+25+42+71	1.72	1.87	2.81	4.11	-	10.50 (3.40-13.30)	2.947 (0.590-3.880)	12.94	99
18+25+50+50	1.63	1.77	3.55	3.55	-	10.50 (3.40-13.30)	2.967 (0.590-3.900)	13.03	99
18+25+50+60	1.58	1.72	3.44	3.77	-	10.50 (3.40-13.30)	2.957 (0.590-3.890)	12.99	99
18+25+50+71	1.58	1.72	3.44	3.77	-	10.50 (3.40-13.30)	2.947 (0.590-3.880)	12.94	99
18+25+60+60	1.53	1.67	3.65	3.65	-	10.50 (3.40-13.30)	2.947 (0.590-3.880)	12.94	99
18+35+35+35	2.22	2.69	2.69	2.69	-	10.30 (3.40-13.30)	2.831 (0.590-3.900)	12.43	99
18+35+35+42	2.06	2.49	2.49	3.36	-	10.40 (3.40-13.30)	2.887 (0.590-3.900)	12.68	99
18+35+35+50	1.87	2.27	2.27	4.09	-	10.50 (3.40-13.30)	2.951 (0.590-3.900)	12.96	99
18+35+35+60	1.80	2.19	2.19	4.32	-	10.50 (3.40-13.30)	2.957 (0.590-3.890)	12.99	99
18+35+35+71	1.80	2.19	2.19	4.32	-	10.50 (3.40-13.30)	2.947 (0.590-3.880)	12.94	99
18+35+42+42	1.91	2.32	3.13	3.13	-	10.50 (3.40-13.30)	2.943 (0.590-3.900)	12.92	99
18+35+42+50	1.74	2.11	2.85	3.80	-	10.50 (3.40-13.30)	2.967 (0.590-3.900)	13.03	99
18+35+42+60	1.68	2.04	2.75	4.03	-	10.50 (3.40-13.30)	2.957 (0.590-3.890)	12.99	99
18+35+42+71	1.68	2.04	2.75	4.03	-	10.50 (3.40-13.30)	2.947 (0.590-3.880)	12.94	99
18+35+50+50	1.60	1.94	3.48	3.48	-	10.50 (3.40-13.30)	2.967 (0.590-3.900)	13.03	99
18+35+50+60	1.55	1.88	3.38	3.70	-	10.50 (3.40-13.30)	2.957 (0.590-3.890)	12.99	99
18+42+42+42	1.78	2.91	2.91	2.91	-	10.50 (3.40-13.30)	2.967 (0.590-3.900)	13.03	99
18+42+42+50	1.63	2.66	2.66	3.55	-	10.50 (3.40-13.30)	2.967 (0.590-3.900)	13.03	99
18+42+42+60	1.58	2.58	2.58	3.77	-	10.50 (3.40-13.30)	2.957 (0.590-3.890)	12.99	99
18+42+50+50	1.50	2.45	3.27	3.27	-	10.50 (3.40-13.30)	2.967 (0.590-3.900)	13.03	99
18+42+50+60	1.46	2.38	3.18	3.49	-	10.50 (3.40-13.30)	2.957 (0.590-3.890)	12.99	99
18+50+50+50	1.39	3.04	3.04	3.04	-	10.50 (3.40-13.30)	2.967 (0.590-3.900)	13.03	99
20+20+20+20	2.20	2.20	2.20	2.20	-	8.80 (3.40-12.50)	2.127 (0.790-4.100)	9.34	99
20+20+20+22	2.02	2.02	2.02	3.03	-	9.10 (3.40-12.70)	2.257 (0.740-4.055)	9.91	99
20+20+20+25	1.96	1.96	1.96	3.21	-	9.10 (3.40-12.70)	2.257 (0.740-3.990)	9.91	99

MXZ-5D102VA HEATING

Indoor units combination	Heating capacity (kW)						Outdoor unit power consumption(kW)	Current (A)	Power factor(%)
	Unit A	Unit B	Unit C	Unit D	Unit E	Total			
20+20+20+35	1.89	1.89	1.89	3.43	-	9.10 (3.40-12.70)	2.257 (0.740-3.910)	9.91	99
20+20+20+50	1.47	1.47	1.47	4.80	-	9.20 (3.40-12.70)	2.337 (0.740-3.900)	10.26	99
20+20+20+60	1.43	1.43	1.43	5.12	-	9.40 (3.40-12.70)	2.407 (0.740-3.890)	10.57	99
20+20+20+71	1.44	1.44	1.44	5.18	-	9.50 (3.40-12.70)	2.485 (0.740-3.880)	10.91	99
20+20+22+22	1.88	1.88	2.82	2.82	-	9.40 (3.40-12.90)	2.387 (0.690-4.010)	10.48	99
20+20+22+25	1.83	1.83	2.75	2.99	-	9.40 (3.40-12.90)	2.387 (0.690-3.945)	10.48	99
20+20+22+35	1.77	1.77	2.65	3.21	-	9.40 (3.40-12.90)	2.387 (0.690-3.905)	10.48	99
20+20+22+42	1.60	1.60	2.39	3.92	-	9.50 (3.40-12.90)	2.419 (0.690-3.900)	10.62	99
20+20+22+50	1.42	1.42	2.13	4.64	-	9.60 (3.40-12.90)	2.483 (0.690-3.900)	10.90	99
20+20+22+60	1.37	1.37	2.05	4.91	-	9.70 (3.40-12.90)	2.553 (0.690-3.890)	11.21	99
20+20+22+71	1.38	1.38	2.07	4.96	-	9.80 (3.40-12.90)	2.631 (0.690-3.880)	11.55	99
20+20+25+25	1.78	1.78	2.92	2.92	-	9.40 (3.40-12.90)	2.387 (0.690-3.915)	10.48	99
20+20+25+35	1.72	1.72	2.82	3.13	-	9.40 (3.40-12.90)	2.387 (0.690-3.900)	10.48	99
20+20+25+42	1.56	1.56	2.55	3.83	-	9.50 (3.40-12.90)	2.443 (0.690-3.900)	10.73	99
20+20+25+50	1.39	1.39	2.27	4.55	-	9.60 (3.40-12.90)	2.507 (0.690-3.900)	11.01	99
20+20+25+60	1.34	1.34	2.20	4.82	-	9.70 (3.40-12.90)	2.577 (0.690-3.890)	11.32	99
20+20+25+71	1.37	1.37	2.24	4.92	-	9.90 (3.40-12.90)	2.655 (0.690-3.880)	11.66	99
20+20+35+35	1.69	1.69	3.06	3.06	-	9.50 (3.40-12.90)	2.467 (0.690-3.900)	10.83	99
20+20+35+42	1.53	1.53	2.78	3.76	-	9.60 (3.40-12.90)	2.523 (0.690-3.900)	11.08	99
20+20+35+50	1.37	1.37	2.49	4.48	-	9.70 (3.40-12.90)	2.587 (0.690-3.900)	11.36	99
20+20+35+60	1.32	1.32	2.40	4.75	-	9.80 (3.40-12.90)	2.657 (0.690-3.890)	11.67	99
20+20+35+71	1.34	1.34	2.43	4.80	-	9.90 (3.40-12.90)	2.687 (0.690-3.880)	11.80	99
20+20+42+42	1.40	1.40	3.45	3.45	-	9.70 (3.40-12.90)	2.579 (0.690-3.900)	11.33	99
20+20+42+50	1.27	1.27	3.11	4.15	-	9.80 (3.40-12.90)	2.643 (0.690-3.900)	11.61	99
20+20+42+60	1.23	1.23	3.02	4.42	-	9.90 (3.40-12.90)	2.697 (0.690-3.890)	11.84	99
20+20+42+71	1.23	1.23	3.02	4.42	-	9.90 (3.40-12.90)	2.687 (0.690-3.880)	11.80	99
20+20+50+50	1.16	1.16	3.79	3.79	-	9.90 (3.40-12.90)	2.707 (0.690-3.900)	11.89	99
20+20+50+60	1.12	1.12	3.66	4.01	-	9.90 (3.40-12.90)	2.697 (0.690-3.890)	11.84	99
20+20+50+71	1.12	1.12	3.66	4.01	-	9.90 (3.40-12.90)	2.687 (0.690-3.880)	11.80	99
20+20+60+60	1.08	1.08	3.87	3.87	-	9.90 (3.40-12.90)	2.687 (0.690-3.880)	11.80	99
20+20+60+71	1.08	1.08	3.87	3.87	-	9.90 (3.40-12.90)	2.677 (0.690-3.870)	11.76	99
20+22+22+22	1.76	2.65	2.65	2.65	-	9.70 (3.40-13.10)	2.517 (0.640-3.965)	11.05	99
20+22+22+25	1.72	2.58	2.58	2.82	-	9.70 (3.40-13.10)	2.517 (0.640-3.920)	11.05	99
20+22+22+35	1.67	2.50	2.50	3.03	-	9.70 (3.40-13.10)	2.517 (0.640-3.900)	11.05	99
20+22+22+42	1.52	2.28	2.28	3.73	-	9.80 (3.40-13.10)	2.565 (0.640-3.900)	11.26	99
20+22+22+50	1.36	2.04	2.04	4.46	-	9.90 (3.40-13.10)	2.629 (0.640-3.900)	11.55	99
20+22+22+60	1.32	1.98	1.98	4.73	-	10.00 (3.40-13.10)	2.699 (0.640-3.890)	11.85	99
20+22+22+71	1.33	2.00	2.00	4.78	-	10.10 (3.40-13.10)	2.777 (0.640-3.880)	12.20	99
20+22+25+25	1.68	2.52	2.75	2.75	-	9.70 (3.40-13.10)	2.517 (0.640-3.915)	11.05	99
20+22+25+42	1.49	2.23	2.43	3.65	-	9.80 (3.40-13.10)	2.589 (0.640-3.900)	11.37	99
20+22+25+50	1.34	2.00	2.19	4.37	-	9.90 (3.40-13.10)	2.653 (0.640-3.900)	11.65	99

MXZ-5D102VA HEATING

Indoor units combination	Heating capacity (kW)						Outdoor unit power consumption(kW)	Current (A)	Power factor(%)
	Unit A	Unit B	Unit C	Unit D	Unit E	Total			
20+22+25+60	1.29	1.94	2.12	4.65	-	10.00 (3.40-13.10)	2.723 (0.640-3.890)	11.96	99
20+22+25+71	1.32	1.98	2.16	4.74	-	10.20 (3.40-13.10)	2.801 (0.640-3.880)	12.30	99
20+22+35+35	1.61	2.42	2.93	2.93	-	9.90 (3.40-13.10)	2.613 (0.640-3.900)	11.48	99
20+22+35+42	1.46	2.19	2.66	3.59	-	9.90 (3.40-13.10)	2.669 (0.640-3.900)	11.72	99
20+22+35+50	1.32	1.98	2.40	4.31	-	10.00 (3.40-13.10)	2.733 (0.640-3.900)	12.00	99
20+22+35+60	1.29	1.93	2.34	4.63	-	10.20 (3.40-13.10)	2.803 (0.640-3.890)	12.31	99
20+22+35+71	1.29	1.93	2.34	4.63	-	10.20 (3.40-13.10)	2.817 (0.640-3.880)	12.37	99
20+22+42+42	1.35	2.02	3.31	3.31	-	10.00 (3.40-13.10)	2.725 (0.640-3.900)	11.97	99
20+22+42+50	1.23	1.84	3.01	4.02	-	10.10 (3.40-13.10)	2.789 (0.640-3.900)	12.25	99
20+22+42+60	1.19	1.79	2.93	4.29	-	10.20 (3.40-13.10)	2.827 (0.640-3.890)	12.42	99
20+22+42+71	1.19	1.79	2.93	4.29	-	10.20 (3.40-13.10)	2.817 (0.640-3.880)	12.37	99
20+22+50+50	1.13	1.69	3.69	3.69	-	10.20 (3.40-13.10)	2.837 (0.640-3.900)	12.46	99
20+22+50+60	1.09	1.63	3.57	3.91	-	10.20 (3.40-13.10)	2.827 (0.640-3.890)	12.42	99
20+22+50+71	1.09	1.63	3.57	3.91	-	10.20 (3.40-13.10)	2.817 (0.640-3.880)	12.37	99
20+22+60+60	1.05	1.58	3.78	3.78	-	10.20 (3.40-13.10)	2.817 (0.640-3.880)	12.37	99
20+25+25+25	1.64	2.69	2.69	2.69	-	9.70 (3.40-13.10)	2.517 (0.640-3.910)	11.05	99
20+25+25+35	1.61	2.63	2.63	2.93	-	9.80 (3.40-13.10)	2.557 (0.640-3.900)	11.23	99
20+25+25+42	1.47	2.41	2.41	3.61	-	9.90 (3.40-13.10)	2.613 (0.640-3.900)	11.48	99
20+25+25+50	1.33	2.17	2.17	4.34	-	10.00 (3.40-13.10)	2.677 (0.640-3.900)	11.76	99
20+25+25+60	1.28	2.10	2.10	4.61	-	10.10 (3.40-13.10)	2.747 (0.640-3.890)	12.06	99
20+25+25+71	1.30	2.12	2.12	4.66	-	10.20 (3.40-13.10)	2.817 (0.640-3.880)	12.37	99
20+25+35+35	1.58	2.58	2.87	2.87	-	9.90 (3.40-13.10)	2.637 (0.640-3.900)	11.58	99
20+25+35+42	1.45	2.37	2.63	3.55	-	10.00 (3.40-13.10)	2.693 (0.640-3.900)	11.83	99
20+25+35+50	1.31	2.14	2.38	4.28	-	10.10 (3.40-13.10)	2.757 (0.640-3.900)	12.11	99
20+25+35+60	1.27	2.07	2.31	4.55	-	10.20 (3.40-13.10)	2.827 (0.640-3.890)	12.42	99
20+25+35+71	1.27	2.07	2.31	4.55	-	10.20 (3.40-13.10)	2.817 (0.640-3.880)	12.37	99
20+25+42+42	1.34	2.19	3.29	3.29	-	10.10 (3.40-13.10)	2.749 (0.640-3.900)	12.07	99
20+25+42+50	1.22	2.00	2.99	3.99	-	10.20 (3.40-13.10)	2.813 (0.640-3.900)	12.35	99
20+25+42+60	1.17	1.92	2.88	4.22	-	10.20 (3.40-13.10)	2.827 (0.640-3.890)	12.42	99
20+25+42+71	1.17	1.92	2.88	4.22	-	10.20 (3.40-13.10)	2.817 (0.640-3.880)	12.37	99
20+25+50+50	1.11	1.82	3.64	3.64	-	10.20 (3.40-13.10)	2.837 (0.640-3.900)	12.46	99
20+25+50+60	1.07	1.76	3.51	3.86	-	10.20 (3.40-13.10)	2.827 (0.640-3.890)	12.42	99
20+25+50+71	1.07	1.76	3.51	3.86	-	10.20 (3.40-13.10)	2.817 (0.640-3.880)	12.37	99
20+25+60+60	1.04	1.70	3.73	3.73	-	10.20 (3.40-13.10)	2.817 (0.640-3.880)	12.37	99
20+35+35+35	1.55	2.82	2.82	2.82	-	10.00 (3.40-13.10)	2.717 (0.640-3.900)	11.93	99
20+35+35+42	1.42	2.59	2.59	3.50	-	10.10 (3.40-13.10)	2.773 (0.640-3.900)	12.18	99
20+35+35+50	1.29	2.34	2.34	4.22	-	10.20 (3.40-13.10)	2.837 (0.640-3.900)	12.46	99
20+35+35+60	1.24	2.25	2.25	4.45	-	10.20 (3.40-13.10)	2.827 (0.640-3.890)	12.42	99
20+35+35+71	1.24	2.25	2.25	4.45	-	10.20 (3.40-13.10)	2.817 (0.640-3.880)	12.37	99
20+35+42+42	1.32	2.40	3.24	3.24	-	10.20 (3.40-13.10)	2.829 (0.640-3.900)	12.42	99
20+35+42+50	1.19	2.17	2.93	3.91	-	10.20 (3.40-13.10)	2.837 (0.640-3.900)	12.46	99

MXZ-5D102VA HEATING

Indoor units combination	Heating capacity (kW)						Outdoor unit power consumption(kW)	Current (A)	Power factor(%)
	Unit A	Unit B	Unit C	Unit D	Unit E	Total			
20+35+42+60	1.15	2.09	2.82	4.13	-	10.20 (3.40-13.10)	2.827 (0.640-3.890)	12.42	99
20+35+42+71	1.15	2.09	2.82	4.13	-	10.20 (3.40-13.10)	2.817 (0.640-3.880)	12.37	99
20+35+50+50	1.09	1.98	3.57	3.57	-	10.20 (3.40-13.10)	2.837 (0.640-3.900)	12.46	99
20+35+50+60	1.05	1.92	3.45	3.78	-	10.20 (3.40-13.10)	2.827 (0.640-3.890)	12.42	99
20+42+42+42	1.22	2.99	2.99	2.99	-	10.20 (3.40-13.10)	2.837 (0.640-3.900)	12.46	99
20+42+42+50	1.11	2.73	2.73	3.64	-	10.20 (3.40-13.10)	2.837 (0.640-3.900)	12.46	99
20+42+42+60	1.07	2.64	2.64	3.86	-	10.20 (3.40-13.10)	2.827 (0.640-3.890)	12.42	99
20+42+50+50	1.02	2.50	3.34	3.34	-	10.20 (3.40-13.10)	2.837 (0.640-3.900)	12.46	99
20+42+50+60	0.99	2.43	3.24	3.55	-	10.20 (3.40-13.10)	2.827 (0.640-3.890)	12.42	99
20+50+50+50	0.94	3.09	3.09	3.09	-	10.20 (3.40-13.10)	2.837 (0.640-3.900)	12.46	99
22+22+22+22	2.50	2.50	2.50	2.50	-	10.00 (3.40-13.30)	2.647 (0.590-3.920)	11.62	99
22+22+22+25	2.44	2.44	2.44	2.67	-	10.00 (3.40-13.30)	2.647 (0.590-3.915)	11.62	99
22+22+22+35	2.37	2.37	2.37	2.88	-	10.00 (3.40-13.30)	2.655 (0.590-3.900)	11.66	99
22+22+22+42	2.18	2.18	2.18	3.56	-	10.10 (3.40-13.30)	2.711 (0.590-3.900)	11.91	99
22+22+22+50	1.97	1.97	1.97	4.29	-	10.20 (3.40-13.30)	2.775 (0.590-3.900)	12.19	99
22+22+22+60	1.91	1.91	1.91	4.57	-	10.30 (3.40-13.30)	2.845 (0.590-3.890)	12.49	99
22+22+22+71	1.95	1.95	1.95	4.66	-	10.50 (3.40-13.30)	2.923 (0.590-3.880)	12.84	99
22+22+25+25	2.39	2.39	2.61	2.61	-	10.00 (3.40-13.30)	2.647 (0.590-3.910)	11.62	99
22+22+25+35	2.35	2.35	2.56	2.85	-	10.10 (3.40-13.30)	2.679 (0.590-3.900)	11.77	99
22+22+25+42	2.14	2.14	2.33	3.50	-	10.10 (3.40-13.30)	2.735 (0.590-3.900)	12.01	99
22+22+25+50	1.93	1.93	2.11	4.22	-	10.20 (3.40-13.30)	2.799 (0.590-3.900)	12.29	99
22+22+25+60	1.90	1.90	2.07	4.54	-	10.40 (3.40-13.30)	2.869 (0.590-3.890)	12.60	99
22+22+25+71	1.91	1.91	2.09	4.58	-	10.50 (3.40-13.30)	2.947 (0.590-3.880)	12.94	99
22+22+35+35	2.31	2.31	2.79	2.79	-	10.20 (3.40-13.30)	2.759 (0.590-3.900)	12.12	99
22+22+35+42	2.12	2.12	2.58	3.48	-	10.30 (3.40-13.30)	2.815 (0.590-3.900)	12.36	99
22+22+35+50	1.93	1.93	2.34	4.21	-	10.40 (3.40-13.30)	2.879 (0.590-3.900)	12.64	99
22+22+35+60	1.87	1.87	2.27	4.48	-	10.50 (3.40-13.30)	2.949 (0.590-3.890)	12.95	99
22+22+35+71	1.87	1.87	2.27	4.48	-	10.50 (3.40-13.30)	2.947 (0.590-3.880)	12.94	99
22+22+42+42	1.97	1.97	3.23	3.23	-	10.40 (3.40-13.30)	2.871 (0.590-3.900)	12.61	99
22+22+42+50	1.80	1.80	2.95	3.94	-	10.50 (3.40-13.30)	2.935 (0.590-3.900)	12.89	99
22+22+42+60	1.74	1.74	2.85	4.17	-	10.50 (3.40-13.30)	2.957 (0.590-3.890)	12.99	99
22+22+42+71	1.74	1.74	2.85	4.17	-	10.50 (3.40-13.30)	2.947 (0.590-3.880)	12.94	99
22+22+50+50	1.65	1.65	3.60	3.60	-	10.50 (3.40-13.30)	2.967 (0.590-3.900)	13.03	99
22+22+50+60	1.60	1.60	3.48	3.82	-	10.50 (3.40-13.30)	2.957 (0.590-3.890)	12.99	99
22+22+50+71	1.60	1.60	3.48	3.82	-	10.50 (3.40-13.30)	2.947 (0.590-3.880)	12.94	99
22+22+60+60	1.55	1.55	3.70	3.70	-	10.50 (3.40-13.30)	2.947 (0.590-3.880)	12.94	99
22+25+25+25	2.34	2.55	2.55	2.55	-	10.00 (3.40-13.30)	2.647 (0.590-3.905)	11.62	99
22+25+25+35	2.30	2.51	2.51	2.79	-	10.10 (3.40-13.30)	2.703 (0.590-3.900)	11.87	99
22+25+25+42	2.12	2.31	2.31	3.46	-	10.20 (3.40-13.30)	2.759 (0.590-3.900)	12.12	99
22+25+25+50	1.92	2.09	2.09	4.19	-	10.30 (3.40-13.30)	2.823 (0.590-3.900)	12.40	99
22+25+25+60	1.87	2.03	2.03	4.47	-	10.40 (3.40-13.30)	2.893 (0.590-3.890)	12.71	99

MXZ-5D102VA HEATING

Indoor units combination	Heating capacity (kW)						Outdoor unit power consumption(kW)	Current (A)	Power factor(%)
	Unit A	Unit B	Unit C	Unit D	Unit E	Total			
22+25+25+71	1.88	2.05	2.05	4.51	-	10.50 (3.40-13.30)	2.947 (0.590-3.880)	12.94	99
22+25+35+35	2.26	2.46	2.74	2.74	-	10.20 (3.40-13.30)	2.783 (0.590-3.900)	12.22	99
22+25+35+42	2.09	2.27	2.53	3.41	-	10.30 (3.40-13.30)	2.839 (0.590-3.900)	12.47	99
22+25+35+50	1.90	2.07	2.30	4.14	-	10.40 (3.40-13.30)	2.903 (0.590-3.900)	12.75	99
22+25+35+60	1.84	2.01	2.23	4.41	-	10.50 (3.40-13.30)	2.957 (0.590-3.890)	12.99	99
22+25+35+71	1.84	2.01	2.23	4.41	-	10.50 (3.40-13.30)	2.947 (0.590-3.880)	12.94	99
22+25+42+42	1.94	2.12	3.17	3.17	-	10.40 (3.40-13.30)	2.895 (0.590-3.900)	12.71	99
22+25+42+50	1.78	1.94	2.91	3.88	-	10.50 (3.40-13.30)	2.959 (0.590-3.900)	13.00	99
22+25+42+60	1.72	1.87	2.81	4.11	-	10.50 (3.40-13.30)	2.957 (0.590-3.890)	12.99	99
22+25+42+71	1.72	1.87	2.81	4.11	-	10.50 (3.40-13.30)	2.947 (0.590-3.880)	12.94	99
22+25+50+50	1.63	1.77	3.55	3.55	-	10.50 (3.40-13.30)	2.967 (0.590-3.900)	13.03	99
22+25+50+60	1.58	1.72	3.44	3.77	-	10.50 (3.40-13.30)	2.957 (0.590-3.890)	12.99	99
22+25+50+71	1.58	1.72	3.44	3.77	-	10.50 (3.40-13.30)	2.947 (0.590-3.880)	12.94	99
22+25+60+60	1.53	1.67	3.65	3.65	-	10.50 (3.40-13.30)	2.947 (0.590-3.880)	12.94	99
22+35+35+35	2.22	2.69	2.69	2.69	-	10.30 (3.40-13.30)	2.863 (0.590-3.900)	12.57	99
22+35+35+42	2.06	2.49	2.49	3.36	-	10.40 (3.40-13.30)	2.919 (0.590-3.900)	12.82	99
22+35+35+50	1.87	2.27	2.27	4.09	-	10.50 (3.40-13.30)	2.967 (0.590-3.900)	13.03	99
22+35+35+60	1.80	2.19	2.19	4.32	-	10.50 (3.40-13.30)	2.957 (0.590-3.890)	12.99	99
22+35+35+71	1.80	2.19	2.19	4.32	-	10.50 (3.40-13.30)	2.947 (0.590-3.880)	12.94	99
22+35+42+42	1.91	2.32	3.13	3.13	-	10.50 (3.40-13.30)	2.967 (0.590-3.900)	13.03	99
22+35+42+50	1.74	2.11	2.85	3.80	-	10.50 (3.40-13.30)	2.967 (0.590-3.900)	13.03	99
22+35+42+60	1.68	2.04	2.75	4.03	-	10.50 (3.40-13.30)	2.957 (0.590-3.890)	12.99	99
22+35+42+71	1.68	2.04	2.75	4.03	-	10.50 (3.40-13.30)	2.947 (0.590-3.880)	12.94	99
22+35+50+50	1.60	1.94	3.48	3.48	-	10.50 (3.40-13.30)	2.967 (0.590-3.900)	13.03	99
22+35+50+60	1.55	1.88	3.38	3.70	-	10.50 (3.40-13.30)	2.957 (0.590-3.890)	12.99	99
22+42+42+42	1.78	2.91	2.91	2.91	-	10.50 (3.40-13.30)	2.967 (0.590-3.900)	13.03	99
22+42+42+50	1.63	2.66	2.66	3.55	-	10.50 (3.40-13.30)	2.967 (0.590-3.900)	13.03	99
22+42+42+60	1.58	2.58	2.58	3.77	-	10.50 (3.40-13.30)	2.957 (0.590-3.890)	12.99	99
22+42+50+50	1.50	2.45	3.27	3.27	-	10.50 (3.40-13.30)	2.967 (0.590-3.900)	13.03	99
22+50+50+50	1.39	3.04	3.04	3.04	-	10.50 (3.40-13.30)	2.967 (0.590-3.900)	13.03	99
25+25+25+25	2.50	2.50	2.50	2.50	-	10.00 (3.40-13.30)	2.647 (0.590-3.900)	11.62	99
25+25+25+35	2.46	2.46	2.46	2.73	-	10.10 (3.40-13.30)	2.727 (0.590-3.900)	11.98	99
25+25+25+42	2.27	2.27	2.27	3.40	-	10.20 (3.40-13.30)	2.783 (0.590-3.900)	12.22	99
25+25+25+50	2.06	2.06	2.06	4.12	-	10.30 (3.40-13.30)	2.847 (0.590-3.900)	12.50	99
25+25+25+60	2.00	2.00	2.00	4.39	-	10.40 (3.40-13.30)	2.917 (0.590-3.890)	12.81	99
25+25+25+71	2.02	2.02	2.02	4.44	-	10.50 (3.40-13.30)	2.947 (0.590-3.880)	12.94	99
25+25+35+35	2.44	2.44	2.71	2.71	-	10.30 (3.40-13.30)	2.807 (0.590-3.900)	12.33	99
25+25+35+42	2.23	2.23	2.48	3.35	-	10.30 (3.40-13.30)	2.863 (0.590-3.900)	12.57	99
25+25+35+50	2.03	2.03	2.26	4.07	-	10.40 (3.40-13.30)	2.927 (0.590-3.900)	12.85	99
25+25+35+60	1.98	1.98	2.20	4.34	-	10.50 (3.40-13.30)	2.957 (0.590-3.890)	12.99	99
25+25+35+71	1.98	1.98	2.20	4.34	-	10.50 (3.40-13.30)	2.947 (0.590-3.880)	12.94	99

MXZ-5D102VA HEATING

Indoor units combination	Heating capacity (kW)						Outdoor unit power consumption(kW)	Current (A)	Power factor(%)
	Unit A	Unit B	Unit C	Unit D	Unit E	Total			
25+25+42+42	2.08	2.08	3.12	3.12	-	10.40 (3.40-13.30)	2.919 (0.590-3.900)	12.82	99
25+25+42+50	1.91	1.91	2.86	3.82	-	10.50 (3.40-13.30)	2.967 (0.590-3.900)	13.03	99
25+25+42+60	1.84	1.84	2.77	4.05	-	10.50 (3.40-13.30)	2.957 (0.590-3.890)	12.99	99
25+25+42+71	1.84	1.84	2.77	4.05	-	10.50 (3.40-13.30)	2.947 (0.590-3.880)	12.94	99
25+25+50+50	1.75	1.75	3.50	3.50	-	10.50 (3.40-13.30)	2.967 (0.590-3.900)	13.03	99
25+25+50+60	1.70	1.70	3.39	3.72	-	10.50 (3.40-13.30)	2.957 (0.590-3.890)	12.99	99
25+25+50+71	1.70	1.70	3.39	3.72	-	10.50 (3.40-13.30)	2.947 (0.590-3.880)	12.94	99
25+25+60+60	1.64	1.64	3.61	3.61	-	10.50 (3.40-13.30)	2.947 (0.590-3.880)	12.94	99
25+35+35+35	2.40	2.67	2.67	2.67	-	10.40 (3.40-13.30)	2.887 (0.590-3.900)	12.68	99
25+35+35+42	2.22	2.47	2.47	3.34	-	10.50 (3.40-13.30)	2.943 (0.590-3.900)	12.92	99
25+35+35+50	2.01	2.23	2.23	4.02	-	10.50 (3.40-13.30)	2.967 (0.590-3.900)	13.03	99
25+35+35+60	1.94	2.15	2.15	4.25	-	10.50 (3.40-13.30)	2.957 (0.590-3.890)	12.99	99
25+35+35+71	1.94	2.15	2.15	4.25	-	10.50 (3.40-13.30)	2.947 (0.590-3.880)	12.94	99
25+35+42+42	2.05	2.28	3.08	3.08	-	10.50 (3.40-13.30)	2.967 (0.590-3.900)	13.03	99
25+35+42+50	1.87	2.08	2.81	3.74	-	10.50 (3.40-13.30)	2.967 (0.590-3.900)	13.03	99
25+35+42+60	1.81	2.01	2.71	3.97	-	10.50 (3.40-13.30)	2.957 (0.590-3.890)	12.99	99
25+35+50+50	1.72	1.91	3.44	3.44	-	10.50 (3.40-13.30)	2.967 (0.590-3.900)	13.03	99
25+35+50+60	1.67	1.85	3.33	3.65	-	10.50 (3.40-13.30)	2.957 (0.590-3.890)	12.99	99
25+42+42+42	1.91	2.86	2.86	2.86	-	10.50 (3.40-13.30)	2.967 (0.590-3.900)	13.03	99
25+42+42+50	1.75	2.63	2.63	3.50	-	10.50 (3.40-13.30)	2.967 (0.590-3.900)	13.03	99
25+42+42+60	1.70	2.54	2.54	3.72	-	10.50 (3.40-13.30)	2.957 (0.590-3.890)	12.99	99
25+42+50+50	1.62	2.42	3.23	3.23	-	10.50 (3.40-13.30)	2.967 (0.590-3.900)	13.03	99
35+35+35+35	2.63	2.63	2.63	2.63	-	10.50 (3.40-13.30)	2.967 (0.590-3.900)	13.03	99
35+35+35+42	2.41	2.41	2.41	3.26	-	10.50 (3.40-13.30)	2.967 (0.590-3.900)	13.03	99
35+35+35+50	2.19	2.19	2.19	3.94	-	10.50 (3.40-13.30)	2.967 (0.590-3.900)	13.03	99
35+35+35+60	2.11	2.11	2.11	4.17	-	10.50 (3.40-13.30)	2.957 (0.590-3.890)	12.99	99
35+35+42+42	2.23	2.23	3.02	3.02	-	10.50 (3.40-13.30)	2.967 (0.590-3.900)	13.03	99
35+35+42+50	2.04	2.04	2.75	3.67	-	10.50 (3.40-13.30)	2.967 (0.590-3.900)	13.03	99
35+35+42+60	1.97	1.97	2.66	3.89	-	10.50 (3.40-13.30)	2.957 (0.590-3.890)	12.99	99
35+35+50+50	1.88	1.88	3.38	3.38	-	10.50 (3.40-13.30)	2.967 (0.590-3.900)	13.03	99
35+42+42+42	2.08	2.81	2.81	2.81	-	10.50 (3.40-13.30)	2.967 (0.590-3.900)	13.03	99
35+42+42+50	1.91	2.58	2.58	3.44	-	10.50 (3.40-13.30)	2.967 (0.590-3.900)	13.03	99
42+42+42+42	2.63	2.63	2.63	2.63	-	10.50 (3.40-13.30)	2.967 (0.590-3.900)	13.03	99
15+15+15+15+15	1.70	1.70	1.70	1.70	1.70	8.50 (4.10-10.50)	1.915 (0.880-4.100)	8.41	99
15+15+15+15+18	1.50	1.50	1.50	1.50	2.91	8.90 (4.10-11.20)	2.085 (0.860-4.100)	9.16	99
15+15+15+15+20	1.66	1.66	1.66	1.66	2.15	8.80 (4.10-11.10)	2.125 (0.880-4.100)	9.33	99
15+15+15+15+22	1.50	1.50	1.50	1.50	2.91	8.90 (4.10-11.50)	2.085 (0.860-4.100)	9.16	99
15+15+15+15+25	1.45	1.45	1.45	1.45	3.08	8.90 (4.10-11.70)	2.085 (0.860-4.100)	9.16	99
15+15+15+15+35	1.40	1.40	1.40	1.40	3.30	8.90 (4.10-12.00)	2.085 (0.860-4.100)	9.16	99
15+15+15+15+50	1.08	1.08	1.08	1.08	4.58	8.90 (4.10-12.00)	2.085 (0.860-4.100)	9.16	99
15+15+15+15+60	1.03	1.03	1.03	1.03	4.78	8.90 (4.10-12.00)	2.075 (0.860-4.090)	9.11	99

MXZ-5D102VA HEATING

Indoor units combination	Heating capacity (kW)						Outdoor unit power consumption(kW)	Current (A)	Power factor(%)
	Unit A	Unit B	Unit C	Unit D	Unit E	Total			
15+15+15+15+71	1.03	1.03	1.03	1.03	4.78	8.90 (4.10-12.00)	2.065 (0.860-4.080)	9.07	99
15+15+15+18+18	1.35	1.35	1.35	2.62	2.62	9.30 (4.10-11.90)	2.255 (0.840-4.100)	9.90	99
15+15+15+18+20	1.48	1.48	1.48	2.86	1.91	9.20 (4.10-11.80)	2.295 (0.860-4.100)	10.08	99
15+15+15+18+22	1.35	1.35	1.35	2.62	2.62	9.30 (4.10-12.20)	2.255 (0.840-4.100)	9.90	99
15+15+15+18+25	1.32	1.32	1.32	2.56	2.79	9.30 (4.10-12.40)	2.255 (0.840-4.100)	9.90	99
15+15+15+18+35	1.28	1.28	1.28	2.48	3.00	9.30 (4.10-12.50)	2.255 (0.840-4.100)	9.90	99
15+15+15+18+42	1.15	1.15	1.15	2.22	3.64	9.30 (4.10-12.50)	2.255 (0.840-4.100)	9.90	99
15+15+15+18+50	1.01	1.01	1.01	1.97	4.29	9.30 (4.10-12.50)	2.255 (0.840-4.100)	9.90	99
15+15+15+18+60	0.97	0.97	0.97	1.88	4.51	9.30 (4.10-12.50)	2.245 (0.840-4.090)	9.86	99
15+15+15+18+71	0.97	0.97	0.97	1.88	4.51	9.30 (4.10-12.50)	2.235 (0.840-4.080)	9.82	99
15+15+15+20+20	1.63	1.63	1.63	2.11	2.11	9.10 (4.10-11.80)	2.335 (0.880-4.100)	10.25	99
15+15+15+20+22	1.48	1.48	1.48	1.91	2.86	9.20 (4.10-12.10)	2.295 (0.860-4.100)	10.08	99
15+15+15+20+25	1.43	1.43	1.43	1.86	3.04	9.20 (4.10-12.30)	2.295 (0.860-4.100)	10.08	99
15+15+15+20+35	1.38	1.38	1.38	1.79	3.26	9.20 (4.10-12.30)	2.295 (0.860-4.100)	10.08	99
15+15+15+20+42	1.23	1.23	1.23	1.59	3.91	9.20 (4.10-12.30)	2.295 (0.860-4.100)	10.08	99
15+15+15+20+50	1.08	1.08	1.08	1.40	4.57	9.20 (4.10-12.30)	2.295 (0.860-4.100)	10.08	99
15+15+15+20+60	1.03	1.03	1.03	1.33	4.78	9.20 (4.10-12.30)	2.285 (0.860-4.090)	10.04	99
15+15+15+20+71	1.03	1.03	1.03	1.33	4.78	9.20 (4.10-12.30)	2.275 (0.860-4.080)	9.99	99
15+15+15+22+22	1.35	1.35	1.35	2.62	2.62	9.30 (4.10-12.40)	2.255 (0.840-4.100)	9.90	99
15+15+15+22+25	1.32	1.32	1.32	2.56	2.79	9.30 (4.10-12.50)	2.255 (0.840-4.100)	9.90	99
15+15+15+22+42	1.15	1.15	1.15	2.22	3.64	9.30 (4.10-12.50)	2.255 (0.840-4.100)	9.90	99
15+15+15+22+50	1.01	1.01	1.01	1.97	4.29	9.30 (4.10-12.50)	2.255 (0.840-4.100)	9.90	99
15+15+15+22+60	0.97	0.97	0.97	1.88	4.51	9.30 (4.10-12.50)	2.245 (0.840-4.090)	9.86	99
15+15+15+22+71	0.97	0.97	0.97	1.88	4.51	9.30 (4.10-12.50)	2.235 (0.840-4.080)	9.82	99
15+15+15+25+25	1.29	1.29	1.29	2.72	2.72	9.30 (4.10-12.50)	2.255 (0.840-4.100)	9.90	99
15+15+15+25+35	1.24	1.24	1.24	2.64	2.93	9.30 (4.10-12.50)	2.255 (0.840-4.100)	9.90	99
15+15+15+25+42	1.12	1.12	1.12	2.37	3.56	9.30 (4.10-12.50)	2.255 (0.840-4.100)	9.90	99
15+15+15+25+50	0.99	0.99	0.99	2.11	4.21	9.30 (4.10-12.50)	2.255 (0.840-4.100)	9.90	99
15+15+15+25+60	0.95	0.95	0.95	2.02	4.43	9.30 (4.10-12.50)	2.245 (0.840-4.090)	9.86	99
15+15+15+25+71	0.95	0.95	0.95	2.02	4.43	9.30 (4.10-12.50)	2.235 (0.840-4.080)	9.82	99
15+15+15+35+35	1.21	1.21	1.21	2.84	2.84	9.30 (4.10-12.50)	2.255 (0.840-4.100)	9.90	99
15+15+15+35+42	1.09	1.09	1.09	2.57	3.46	9.30 (4.10-12.50)	2.255 (0.840-4.100)	9.90	99
15+15+15+35+50	0.97	0.97	0.97	2.28	4.11	9.30 (4.10-12.50)	2.255 (0.840-4.100)	9.90	99
15+15+15+35+60	0.93	0.93	0.93	2.19	4.32	9.30 (4.10-12.50)	2.245 (0.840-4.090)	9.86	99
15+15+15+35+71	0.93	0.93	0.93	2.19	4.32	9.30 (4.10-12.50)	2.235 (0.840-4.080)	9.82	99
15+15+15+42+42	0.99	0.99	0.99	3.16	3.16	9.30 (4.10-12.50)	2.255 (0.840-4.100)	9.90	99
15+15+15+42+50	0.89	0.89	0.89	2.84	3.78	9.30 (4.10-12.50)	2.255 (0.840-4.100)	9.90	99
15+15+15+42+60	0.86	0.86	0.86	2.73	3.99	9.30 (4.10-12.50)	2.245 (0.840-4.090)	9.86	99
15+15+15+42+71	0.86	0.86	0.86	2.73	3.99	9.30 (4.10-12.50)	2.235 (0.840-4.080)	9.82	99
15+15+15+50+50	0.81	0.81	0.81	3.43	3.43	9.30 (4.10-12.50)	2.255 (0.840-4.100)	9.90	99
15+15+15+50+60	0.78	0.78	0.78	3.31	3.64	9.30 (4.10-12.50)	2.245 (0.840-4.090)	9.86	99

MXZ-5D102VA HEATING

Indoor units combination	Heating capacity (kW)						Outdoor unit power consumption(kW)	Current (A)	Power factor(%)
	Unit A	Unit B	Unit C	Unit D	Unit E	Total			
15+15+15+50+71	0.78	0.78	0.78	3.31	3.64	9.30 (4.10-12.50)	2.235 (0.840-4.080)	9.82	99
15+15+15+60+60	0.76	0.76	0.76	3.52	3.52	9.30 (4.10-12.50)	2.235 (0.840-4.080)	9.82	99
15+15+18+18+18	1.24	1.24	2.41	2.41	2.41	9.70 (4.10-12.60)	2.425 (0.820-4.100)	10.65	99
15+15+18+18+20	1.34	1.34	2.60	2.60	1.73	9.60 (4.10-12.50)	2.465 (0.840-4.100)	10.83	99
15+15+18+18+22	1.24	1.24	2.41	2.41	2.41	9.70 (4.10-12.90)	2.425 (0.820-4.100)	10.65	99
15+15+18+18+25	1.21	1.21	2.35	2.35	2.57	9.70 (4.10-13.00)	2.425 (0.820-4.100)	10.65	99
15+15+18+18+35	1.18	1.18	2.29	2.29	2.77	9.70 (4.10-13.00)	2.425 (0.820-4.100)	10.65	99
15+15+18+18+42	1.07	1.07	2.08	2.08	3.40	9.70 (4.10-13.00)	2.425 (0.820-4.100)	10.65	99
15+15+18+18+50	0.96	0.96	1.86	1.86	4.06	9.70 (4.10-13.00)	2.425 (0.820-4.100)	10.65	99
15+15+18+18+60	0.92	0.92	1.79	1.79	4.28	9.70 (4.10-13.00)	2.415 (0.820-4.090)	10.61	99
15+15+18+18+71	0.92	0.92	1.79	1.79	4.28	9.70 (4.10-13.00)	2.405 (0.820-4.080)	10.56	99
15+15+18+20+20	1.45	1.45	2.82	1.88	1.88	9.50 (4.10-12.50)	2.505 (0.860-4.100)	11.00	99
15+15+18+20+22	1.34	1.34	2.60	1.73	2.60	9.60 (4.10-12.80)	2.465 (0.840-4.100)	10.83	99
15+15+18+20+25	1.31	1.31	2.53	1.69	2.76	9.60 (4.10-12.80)	2.465 (0.840-4.100)	10.83	99
15+15+18+20+35	1.27	1.27	2.46	1.64	2.98	9.60 (4.10-12.80)	2.465 (0.840-4.100)	10.83	99
15+15+18+20+42	1.14	1.14	2.22	1.48	3.63	9.60 (4.10-12.80)	2.465 (0.840-4.100)	10.83	99
15+15+18+20+50	1.01	1.01	1.97	1.31	4.29	9.60 (4.10-12.80)	2.465 (0.840-4.100)	10.83	99
15+15+18+20+60	0.97	0.97	1.89	1.26	4.51	9.60 (4.10-12.80)	2.455 (0.840-4.090)	10.78	99
15+15+18+20+71	0.97	0.97	1.89	1.26	4.51	9.60 (4.10-12.80)	2.445 (0.840-4.080)	10.74	99
15+15+18+22+22	1.24	1.24	2.41	2.41	2.41	9.70 (4.10-13.00)	2.425 (0.820-4.100)	10.65	99
15+15+18+22+25	1.21	1.21	2.35	2.35	2.57	9.70 (4.10-13.00)	2.425 (0.820-4.100)	10.65	99
15+15+18+22+35	1.18	1.18	2.29	2.29	2.77	9.70 (4.10-13.00)	2.425 (0.820-4.100)	10.65	99
15+15+18+22+42	1.07	1.07	2.08	2.08	3.40	9.70 (4.10-13.00)	2.425 (0.820-4.100)	10.65	99
15+15+18+22+50	0.96	0.96	1.86	1.86	4.06	9.70 (4.10-13.00)	2.425 (0.820-4.100)	10.65	99
15+15+18+22+60	0.92	0.92	1.79	1.79	4.28	9.70 (4.10-13.00)	2.415 (0.820-4.090)	10.61	99
15+15+18+22+71	0.92	0.92	1.79	1.79	4.28	9.70 (4.10-13.00)	2.405 (0.820-4.080)	10.56	99
15+15+18+25+25	1.19	1.19	2.30	2.51	2.51	9.70 (4.10-13.00)	2.425 (0.820-4.100)	10.65	99
15+15+18+25+35	1.15	1.15	2.24	2.44	2.71	9.70 (4.10-13.00)	2.425 (0.820-4.100)	10.65	99
15+15+18+25+42	1.05	1.05	2.04	2.22	3.34	9.70 (4.10-13.00)	2.425 (0.820-4.100)	10.65	99
15+15+18+25+50	0.94	0.94	1.83	2.00	3.99	9.70 (4.10-13.00)	2.425 (0.820-4.100)	10.65	99
15+15+18+25+60	0.91	0.91	1.76	1.92	4.21	9.70 (4.10-13.00)	2.415 (0.820-4.090)	10.61	99
15+15+18+25+71	0.91	0.91	1.76	1.92	4.21	9.70 (4.10-13.00)	2.405 (0.820-4.080)	10.56	99
15+15+18+35+35	1.12	1.12	2.18	2.64	2.64	9.70 (4.10-13.00)	2.425 (0.820-4.100)	10.65	99
15+15+18+35+42	1.02	1.02	1.99	2.41	3.25	9.70 (4.10-13.00)	2.425 (0.820-4.100)	10.65	99
15+15+18+35+50	0.92	0.92	1.79	2.17	3.90	9.70 (4.10-13.00)	2.425 (0.820-4.100)	10.65	99
15+15+18+35+60	0.89	0.89	1.72	2.09	4.12	9.70 (4.10-13.00)	2.415 (0.820-4.090)	10.61	99
15+15+18+35+71	0.89	0.89	1.72	2.09	4.12	9.70 (4.10-13.00)	2.405 (0.820-4.080)	10.56	99
15+15+18+42+42	0.94	0.94	1.83	2.99	2.99	9.70 (4.10-13.00)	2.425 (0.820-4.100)	10.65	99
15+15+18+42+50	0.85	0.85	1.66	2.71	3.62	9.70 (4.10-13.00)	2.425 (0.820-4.100)	10.65	99
15+15+18+42+60	0.82	0.82	1.60	2.62	3.83	9.70 (4.10-13.00)	2.415 (0.820-4.090)	10.61	99
15+15+18+42+71	0.82	0.82	1.60	2.62	3.83	9.70 (4.10-13.00)	2.405 (0.820-4.080)	10.56	99

MXZ-5D102VA HEATING

Indoor units combination	Heating capacity (kW)						Outdoor unit power consumption(kW)	Current (A)	Power factor(%)
	Unit A	Unit B	Unit C	Unit D	Unit E	Total			
15+15+18+50+50	0.78	0.78	1.52	3.31	3.31	9.70 (4.10-13.00)	2.425 (0.820-4.100)	10.65	99
15+15+18+50+60	0.76	0.76	1.47	3.20	3.52	9.70 (4.10-13.00)	2.415 (0.820-4.090)	10.61	99
15+15+18+50+71	0.76	0.76	1.47	3.20	3.52	9.70 (4.10-13.00)	2.405 (0.820-4.080)	10.56	99
15+15+18+60+60	0.73	0.73	1.42	3.41	3.41	9.70 (4.10-13.00)	2.405 (0.820-4.080)	10.56	99
15+15+20+20+20	1.60	1.60	2.07	2.07	2.07	9.40 (4.10-12.40)	2.545 (0.880-4.100)	11.18	99
15+15+20+20+22	1.45	1.45	1.88	1.88	2.82	9.50 (4.10-12.60)	2.505 (0.860-4.100)	11.00	99
15+15+20+20+25	1.42	1.42	1.83	1.83	3.00	9.50 (4.10-12.60)	2.505 (0.860-4.100)	11.00	99
15+15+20+20+35	1.37	1.37	1.77	1.77	3.22	9.50 (4.10-12.60)	2.505 (0.860-4.100)	11.00	99
15+15+20+20+42	1.22	1.22	1.58	1.58	3.89	9.50 (4.10-12.60)	2.505 (0.860-4.100)	11.00	99
15+15+20+20+50	1.08	1.08	1.39	1.39	4.56	9.50 (4.10-12.60)	2.505 (0.860-4.100)	11.00	99
15+15+20+20+60	1.03	1.03	1.33	1.33	4.78	9.50 (4.10-12.60)	2.495 (0.860-4.090)	10.96	99
15+15+20+20+71	1.03	1.03	1.33	1.33	4.78	9.50 (4.10-12.60)	2.485 (0.860-4.080)	10.91	99
15+15+20+22+22	1.34	1.34	1.73	2.60	2.60	9.60 (4.10-12.80)	2.465 (0.840-4.100)	10.83	99
15+15+20+22+25	1.31	1.31	1.69	2.53	2.76	9.60 (4.10-12.80)	2.465 (0.840-4.100)	10.83	99
15+15+20+22+35	1.27	1.27	1.64	2.46	2.98	9.60 (4.10-12.80)	2.465 (0.840-4.100)	10.83	99
15+15+20+22+42	1.14	1.14	1.48	2.22	3.63	9.60 (4.10-12.80)	2.465 (0.840-4.100)	10.83	99
15+15+20+22+50	1.01	1.01	1.31	1.97	4.29	9.60 (4.10-12.80)	2.465 (0.840-4.100)	10.83	99
15+15+20+22+60	0.97	0.97	1.26	1.89	4.51	9.60 (4.10-12.80)	2.455 (0.840-4.090)	10.78	99
15+15+20+22+71	0.97	0.97	1.26	1.89	4.51	9.60 (4.10-12.80)	2.445 (0.840-4.080)	10.74	99
15+15+20+25+25	1.28	1.28	1.65	2.70	2.70	9.60 (4.10-12.80)	2.465 (0.840-4.100)	10.83	99
15+15+20+25+35	1.24	1.24	1.60	2.62	2.91	9.60 (4.10-12.80)	2.465 (0.840-4.100)	10.83	99
15+15+20+25+42	1.12	1.12	1.45	2.37	3.55	9.60 (4.10-12.80)	2.465 (0.840-4.100)	10.83	99
15+15+20+25+50	1.00	1.00	1.29	2.11	4.21	9.60 (4.10-12.80)	2.465 (0.840-4.100)	10.83	99
15+15+20+25+60	0.95	0.95	1.24	2.02	4.44	9.60 (4.10-12.80)	2.455 (0.840-4.090)	10.78	99
15+15+20+25+71	0.95	0.95	1.24	2.02	4.44	9.60 (4.10-12.80)	2.445 (0.840-4.080)	10.74	99
15+15+20+35+35	1.20	1.20	1.55	2.82	2.82	9.60 (4.10-12.80)	2.465 (0.840-4.100)	10.83	99
15+15+20+35+42	1.09	1.09	1.41	2.56	3.46	9.60 (4.10-12.80)	2.465 (0.840-4.100)	10.83	99
15+15+20+35+50	0.97	0.97	1.26	2.29	4.11	9.60 (4.10-12.80)	2.465 (0.840-4.100)	10.83	99
15+15+20+35+60	0.93	0.93	1.21	2.19	4.33	9.60 (4.10-12.80)	2.455 (0.840-4.090)	10.78	99
15+15+20+35+71	0.93	0.93	1.21	2.19	4.33	9.60 (4.10-12.80)	2.445 (0.840-4.080)	10.74	99
15+15+20+42+42	1.00	1.00	1.29	3.16	3.16	9.60 (4.10-12.80)	2.465 (0.840-4.100)	10.83	99
15+15+20+42+50	0.90	0.90	1.16	2.85	3.80	9.60 (4.10-12.80)	2.465 (0.840-4.100)	10.83	99
15+15+20+42+60	0.86	0.86	1.12	2.74	4.01	9.60 (4.10-12.80)	2.455 (0.840-4.090)	10.78	99
15+15+20+42+71	0.86	0.86	1.12	2.74	4.01	9.60 (4.10-12.80)	2.445 (0.840-4.080)	10.74	99
15+15+20+50+50	0.82	0.82	1.06	3.46	3.46	9.60 (4.10-12.80)	2.465 (0.840-4.100)	10.83	99
15+15+20+50+60	0.79	0.79	1.02	3.34	3.66	9.60 (4.10-12.80)	2.455 (0.840-4.090)	10.78	99
15+15+20+50+71	0.79	0.79	1.02	3.34	3.66	9.60 (4.10-12.80)	2.445 (0.840-4.080)	10.74	99
15+15+20+60+60	0.76	0.76	0.99	3.54	3.54	9.60 (4.10-12.80)	2.445 (0.840-4.080)	10.74	99
15+15+22+22+22	1.24	1.24	2.41	2.41	2.41	9.70 (4.10-13.00)	2.425 (0.820-4.100)	10.65	99
15+15+22+22+25	1.21	1.21	2.35	2.35	2.57	9.70 (4.10-13.00)	2.425 (0.820-4.100)	10.65	99
15+15+22+22+35	1.18	1.18	2.29	2.29	2.77	9.70 (4.10-13.00)	2.425 (0.820-4.100)	10.65	99

MXZ-5D102VA HEATING

Indoor units combination	Heating capacity (kW)						Outdoor unit power consumption(kW)	Current (A)	Power factor(%)
	Unit A	Unit B	Unit C	Unit D	Unit E	Total			
15+15+22+22+42	1.07	1.07	2.08	2.08	3.40	9.70 (4.10-13.00)	2.425 (0.820-4.100)	10.65	99
15+15+22+22+50	0.96	0.96	1.86	1.86	4.06	9.70 (4.10-13.00)	2.425 (0.820-4.100)	10.65	99
15+15+22+22+60	0.92	0.92	1.79	1.79	4.28	9.70 (4.10-13.00)	2.415 (0.820-4.090)	10.61	99
15+15+22+22+71	0.92	0.92	1.79	1.79	4.28	9.70 (4.10-13.00)	2.405 (0.820-4.080)	10.56	99
15+15+22+25+35	1.15	1.15	2.24	2.44	2.71	9.70 (4.10-13.00)	2.425 (0.820-4.100)	10.65	99
15+15+22+25+42	1.05	1.05	2.04	2.22	3.34	9.70 (4.10-13.00)	2.425 (0.820-4.100)	10.65	99
15+15+22+25+50	0.94	0.94	1.83	2.00	3.99	9.70 (4.10-13.00)	2.425 (0.820-4.100)	10.65	99
15+15+22+25+60	0.91	0.91	1.76	1.92	4.21	9.70 (4.10-13.00)	2.415 (0.820-4.090)	10.61	99
15+15+22+25+71	0.91	0.91	1.76	1.92	4.21	9.70 (4.10-13.00)	2.405 (0.820-4.080)	10.56	99
15+15+22+35+35	1.12	1.12	2.18	2.64	2.64	9.70 (4.10-13.00)	2.425 (0.820-4.100)	10.65	99
15+15+22+35+42	1.02	1.02	1.99	2.41	3.25	9.70 (4.10-13.00)	2.425 (0.820-4.100)	10.65	99
15+15+22+35+50	0.92	0.92	1.79	2.17	3.90	9.70 (4.10-13.00)	2.425 (0.820-4.100)	10.65	99
15+15+22+35+60	0.89	0.89	1.72	2.09	4.12	9.70 (4.10-13.00)	2.415 (0.820-4.090)	10.61	99
15+15+22+35+71	0.89	0.89	1.72	2.09	4.12	9.70 (4.10-13.00)	2.405 (0.820-4.080)	10.56	99
15+15+22+42+42	0.94	0.94	1.83	2.99	2.99	9.70 (4.10-13.00)	2.425 (0.820-4.100)	10.65	99
15+15+22+42+50	0.85	0.85	1.66	2.71	3.62	9.70 (4.10-13.00)	2.425 (0.820-4.100)	10.65	99
15+15+22+42+60	0.82	0.82	1.60	2.62	3.83	9.70 (4.10-13.00)	2.415 (0.820-4.090)	10.61	99
15+15+22+42+71	0.82	0.82	1.60	2.62	3.83	9.70 (4.10-13.00)	2.405 (0.820-4.080)	10.56	99
15+15+22+50+50	0.78	0.78	1.52	3.31	3.31	9.70 (4.10-13.00)	2.425 (0.820-4.100)	10.65	99
15+15+22+50+60	0.76	0.76	1.47	3.20	3.52	9.70 (4.10-13.00)	2.415 (0.820-4.090)	10.61	99
15+15+22+60+60	0.73	0.73	1.42	3.41	3.41	9.70 (4.10-13.00)	2.405 (0.820-4.080)	10.56	99
15+15+25+25+25	1.16	1.16	2.46	2.46	2.46	9.70 (4.10-13.00)	2.425 (0.820-4.100)	10.65	99
15+15+25+25+35	1.13	1.13	2.39	2.39	2.66	9.70 (4.10-13.00)	2.425 (0.820-4.100)	10.65	99
15+15+25+25+42	1.03	1.03	2.18	2.18	3.27	9.70 (4.10-13.00)	2.425 (0.820-4.100)	10.65	99
15+15+25+25+50	0.93	0.93	1.96	1.96	3.92	9.70 (4.10-13.00)	2.425 (0.820-4.100)	10.65	99
15+15+25+25+60	0.89	0.89	1.89	1.89	4.14	9.70 (4.10-13.00)	2.415 (0.820-4.090)	10.61	99
15+15+25+25+71	0.89	0.89	1.89	1.89	4.14	9.70 (4.10-13.00)	2.405 (0.820-4.080)	10.56	99
15+15+25+35+35	1.10	1.10	2.33	2.59	2.59	9.70 (4.10-13.00)	2.425 (0.820-4.100)	10.65	99
15+15+25+35+42	1.01	1.01	2.13	2.37	3.19	9.70 (4.10-13.00)	2.425 (0.820-4.100)	10.65	99
15+15+25+35+50	0.91	0.91	1.92	2.13	3.84	9.70 (4.10-13.00)	2.425 (0.820-4.100)	10.65	99
15+15+25+35+60	0.87	0.87	1.85	2.05	4.05	9.70 (4.10-13.00)	2.415 (0.820-4.090)	10.61	99
15+15+25+35+71	0.87	0.87	1.85	2.05	4.05	9.70 (4.10-13.00)	2.405 (0.820-4.080)	10.56	99
15+15+25+42+42	0.93	0.93	1.96	2.94	2.94	9.70 (4.10-13.00)	2.425 (0.820-4.100)	10.65	99
15+15+25+42+50	0.84	0.84	1.78	2.67	3.56	9.70 (4.10-13.00)	2.425 (0.820-4.100)	10.65	99
15+15+25+42+60	0.81	0.81	1.72	2.58	3.77	9.70 (4.10-13.00)	2.415 (0.820-4.090)	10.61	99
15+15+25+42+71	0.81	0.81	1.72	2.58	3.77	9.70 (4.10-13.00)	2.405 (0.820-4.080)	10.56	99
15+15+25+50+50	0.77	0.77	1.63	3.26	3.26	9.70 (4.10-13.00)	2.425 (0.820-4.100)	10.65	99
15+15+25+50+60	0.75	0.75	1.58	3.16	3.47	9.70 (4.10-13.00)	2.415 (0.820-4.090)	10.61	99
15+15+35+35+35	1.07	1.07	2.52	2.52	2.52	9.70 (4.10-13.00)	2.425 (0.820-4.100)	10.65	99
15+15+35+35+42	0.98	0.98	2.31	2.31	3.12	9.70 (4.10-13.00)	2.425 (0.820-4.100)	10.65	99
15+15+35+35+50	0.89	0.89	2.09	2.09	3.75	9.70 (4.10-13.00)	2.425 (0.820-4.100)	10.65	99

MXZ-5D102VA HEATING

Indoor units combination	Heating capacity (kW)						Outdoor unit power consumption(kW)	Current (A)	Power factor(%)
	Unit A	Unit B	Unit C	Unit D	Unit E	Total			
15+15+35+35+60	0.85	0.85	2.01	2.01	3.97	9.70 (4.10-13.00)	2.415 (0.820-4.090)	10.61	99
15+15+35+35+71	0.85	0.85	2.01	2.01	3.97	9.70 (4.10-13.00)	2.405 (0.820-4.080)	10.56	99
15+15+35+42+42	0.91	0.91	2.13	2.88	2.88	9.70 (4.10-13.00)	2.425 (0.820-4.100)	10.65	99
15+15+35+42+50	0.82	0.82	1.94	2.62	3.49	9.70 (4.10-13.00)	2.425 (0.820-4.100)	10.65	99
15+15+35+42+60	0.80	0.80	1.87	2.53	3.70	9.70 (4.10-13.00)	2.415 (0.820-4.090)	10.61	99
15+15+35+50+50	0.76	0.76	1.78	3.20	3.20	9.70 (4.10-13.00)	2.425 (0.820-4.100)	10.65	99
15+15+42+42+42	0.84	0.84	2.67	2.67	2.67	9.70 (4.10-13.00)	2.425 (0.820-4.100)	10.65	99
15+15+42+42+50	0.77	0.77	2.45	2.45	3.26	9.70 (4.10-13.00)	2.425 (0.820-4.100)	10.65	99
15+15+42+50+50	0.71	0.71	2.26	3.01	3.01	9.70 (4.10-13.00)	2.425 (0.820-4.100)	10.65	99
15+18+18+18+18	1.15	2.24	2.24	2.24	2.24	10.10 (4.10-13.30)	2.595 (0.800-4.100)	11.40	99
15+18+18+18+20	1.23	2.39	2.39	2.39	1.59	10.00 (4.10-13.20)	2.635 (0.820-4.100)	11.57	99
15+18+18+18+22	1.15	2.24	2.24	2.24	2.24	10.10 (4.10-13.50)	2.595 (0.800-4.100)	11.40	99
15+18+18+18+25	1.13	2.19	2.19	2.19	2.39	10.10 (4.10-13.50)	2.595 (0.800-4.100)	11.40	99
15+18+18+18+35	1.10	2.14	2.14	2.14	2.59	10.10 (4.10-13.50)	2.595 (0.800-4.100)	11.40	99
15+18+18+18+42	1.01	1.96	1.96	1.96	3.21	10.10 (4.10-13.50)	2.595 (0.800-4.100)	11.40	99
15+18+18+18+50	0.91	1.77	1.77	1.77	3.87	10.10 (4.10-13.50)	2.595 (0.800-4.100)	11.40	99
15+18+18+18+60	0.88	1.71	1.71	1.71	4.09	10.10 (4.10-13.50)	2.585 (0.800-4.090)	11.35	99
15+18+18+18+71	0.88	1.71	1.71	1.71	4.09	10.10 (4.10-13.50)	2.575 (0.800-4.080)	11.31	99
15+18+18+20+20	1.33	2.57	2.57	1.71	1.71	9.90 (4.10-13.10)	2.675 (0.840-4.100)	11.75	99
15+18+18+20+22	1.23	2.39	2.39	1.59	2.39	10.00 (4.10-13.30)	2.635 (0.820-4.100)	11.57	99
15+18+18+20+25	1.21	2.34	2.34	1.56	2.55	10.00 (4.10-13.30)	2.635 (0.820-4.100)	11.57	99
15+18+18+20+35	1.17	2.28	2.28	1.52	2.76	10.00 (4.10-13.30)	2.635 (0.820-4.100)	11.57	99
15+18+18+20+42	1.07	2.08	2.08	1.38	3.40	10.00 (4.10-13.30)	2.635 (0.820-4.100)	11.57	99
15+18+18+20+50	0.96	1.86	1.86	1.24	4.07	10.00 (4.10-13.30)	2.635 (0.820-4.100)	11.57	99
15+18+18+20+60	0.92	1.79	1.79	1.20	4.29	10.00 (4.10-13.30)	2.625 (0.820-4.090)	11.53	99
15+18+18+20+71	0.92	1.79	1.79	1.20	4.29	10.00 (4.10-13.30)	2.615 (0.820-4.080)	11.48	99
15+18+18+22+22	1.15	2.24	2.24	2.24	2.24	10.10 (4.10-13.50)	2.595 (0.800-4.100)	11.40	99
15+18+18+22+25	1.13	2.19	2.19	2.19	2.39	10.10 (4.10-13.50)	2.595 (0.800-4.100)	11.40	99
15+18+18+22+35	1.10	2.14	2.14	2.14	2.59	10.10 (4.10-13.50)	2.595 (0.800-4.100)	11.40	99
15+18+18+22+42	1.01	1.96	1.96	1.96	3.21	10.10 (4.10-13.50)	2.595 (0.800-4.100)	11.40	99
15+18+18+22+50	0.91	1.77	1.77	1.77	3.87	10.10 (4.10-13.50)	2.595 (0.800-4.100)	11.40	99
15+18+18+22+60	0.88	1.71	1.71	1.71	4.09	10.10 (4.10-13.50)	2.585 (0.800-4.090)	11.35	99
15+18+18+22+71	0.88	1.71	1.71	1.71	4.09	10.10 (4.10-13.50)	2.575 (0.800-4.080)	11.31	99
15+18+18+25+25	1.11	2.15	2.15	2.35	2.35	10.10 (4.10-13.50)	2.595 (0.800-4.100)	11.40	99
15+18+18+25+35	1.08	2.10	2.10	2.29	2.54	10.10 (4.10-13.50)	2.595 (0.800-4.100)	11.40	99
15+18+18+25+42	0.99	1.93	1.93	2.10	3.15	10.10 (4.10-13.50)	2.595 (0.800-4.100)	11.40	99
15+18+18+25+50	0.90	1.75	1.75	1.90	3.81	10.10 (4.10-13.50)	2.595 (0.800-4.100)	11.40	99
15+18+18+25+60	0.87	1.68	1.68	1.84	4.03	10.10 (4.10-13.50)	2.585 (0.800-4.090)	11.35	99
15+18+18+25+71	0.87	1.68	1.68	1.84	4.03	10.10 (4.10-13.50)	2.575 (0.800-4.080)	11.31	99
15+18+18+35+35	1.05	2.04	2.04	2.48	2.48	10.10 (4.10-13.50)	2.595 (0.800-4.100)	11.40	99
15+18+18+35+42	0.97	1.88	1.88	2.28	3.08	10.10 (4.10-13.50)	2.595 (0.800-4.100)	11.40	99

MXZ-5D102VA HEATING

Indoor units combination	Heating capacity (kW)						Outdoor unit power consumption(kW)	Current (A)	Power factor(%)
	Unit A	Unit B	Unit C	Unit D	Unit E	Total			
15+18+18+35+50	0.88	1.71	1.71	2.07	3.73	10.10 (4.10-13.50)	2.595 (0.800-4.100)	11.40	99
15+18+18+35+60	0.85	1.65	1.65	2.00	3.95	10.10 (4.10-13.50)	2.585 (0.800-4.090)	11.35	99
15+18+18+35+71	0.85	1.65	1.65	2.00	3.95	10.10 (4.10-13.50)	2.575 (0.800-4.080)	11.31	99
15+18+18+42+42	0.90	1.75	1.75	2.86	2.86	10.10 (4.10-13.50)	2.595 (0.800-4.100)	11.40	99
15+18+18+42+50	0.82	1.59	1.59	2.61	3.48	10.10 (4.10-13.50)	2.595 (0.800-4.100)	11.40	99
15+18+18+42+60	0.79	1.54	1.54	2.53	3.69	10.10 (4.10-13.50)	2.585 (0.800-4.090)	11.35	99
15+18+18+42+71	0.79	1.54	1.54	2.53	3.69	10.10 (4.10-13.50)	2.575 (0.800-4.080)	11.31	99
15+18+18+50+50	0.76	1.47	1.47	3.20	3.20	10.10 (4.10-13.50)	2.595 (0.800-4.100)	11.40	99
15+18+18+50+60	0.73	1.42	1.42	3.11	3.41	10.10 (4.10-13.50)	2.585 (0.800-4.090)	11.35	99
15+18+18+50+71	0.73	1.42	1.42	3.11	3.41	10.10 (4.10-13.50)	2.575 (0.800-4.080)	11.31	99
15+18+18+60+60	0.71	1.38	1.38	3.31	3.31	10.10 (4.10-13.50)	2.575 (0.800-4.080)	11.31	99
15+18+20+20+20	1.44	2.79	1.86	1.86	1.86	9.80 (4.10-12.90)	2.715 (0.860-4.100)	11.92	99
15+18+20+20+22	1.33	2.57	1.71	1.71	2.57	9.90 (4.10-13.10)	2.675 (0.840-4.100)	11.75	99
15+18+20+20+25	1.29	2.51	1.68	1.68	2.74	9.90 (4.10-13.10)	2.675 (0.840-4.100)	11.75	99
15+18+20+20+35	1.26	2.44	1.63	1.63	2.96	9.90 (4.10-13.10)	2.675 (0.840-4.100)	11.75	99
15+18+20+20+42	1.14	2.21	1.47	1.47	3.61	9.90 (4.10-13.10)	2.675 (0.840-4.100)	11.75	99
15+18+20+20+50	1.01	1.97	1.31	1.31	4.29	9.90 (4.10-13.10)	2.675 (0.840-4.100)	11.75	99
15+18+20+20+60	0.97	1.89	1.26	1.26	4.52	9.90 (4.10-13.10)	2.665 (0.840-4.090)	11.70	99
15+18+20+20+71	0.97	1.89	1.26	1.26	4.52	9.90 (4.10-13.10)	2.655 (0.840-4.080)	11.66	99
15+18+20+22+22	1.23	2.39	1.59	2.39	2.39	10.00 (4.10-13.30)	2.635 (0.820-4.100)	11.57	99
15+18+20+22+25	1.21	2.34	1.56	2.34	2.55	10.00 (4.10-13.30)	2.635 (0.820-4.100)	11.57	99
15+18+20+22+35	1.17	2.28	1.52	2.28	2.76	10.00 (4.10-13.30)	2.635 (0.820-4.100)	11.57	99
15+18+20+22+42	1.07	2.08	1.38	2.08	3.40	10.00 (4.10-13.30)	2.635 (0.820-4.100)	11.57	99
15+18+20+22+50	0.96	1.86	1.24	1.86	4.07	10.00 (4.10-13.30)	2.635 (0.820-4.100)	11.57	99
15+18+20+22+60	0.92	1.79	1.20	1.79	4.29	10.00 (4.10-13.30)	2.625 (0.820-4.090)	11.53	99
15+18+20+22+71	0.92	1.79	1.20	1.79	4.29	10.00 (4.10-13.30)	2.615 (0.820-4.080)	11.48	99
15+18+20+25+25	1.18	2.29	1.53	2.50	2.50	10.00 (4.10-13.30)	2.635 (0.820-4.100)	11.57	99
15+18+20+25+35	1.15	2.23	1.49	2.43	2.70	10.00 (4.10-13.30)	2.635 (0.820-4.100)	11.57	99
15+18+20+25+42	1.05	2.04	1.36	2.22	3.33	10.00 (4.10-13.30)	2.635 (0.820-4.100)	11.57	99
15+18+20+25+50	0.94	1.83	1.22	2.00	4.00	10.00 (4.10-13.30)	2.635 (0.820-4.100)	11.57	99
15+18+20+25+60	0.91	1.76	1.18	1.93	4.22	10.00 (4.10-13.30)	2.625 (0.820-4.090)	11.53	99
15+18+20+25+71	0.91	1.76	1.18	1.93	4.22	10.00 (4.10-13.30)	2.615 (0.820-4.080)	11.48	99
15+18+20+35+35	1.12	2.17	1.45	2.63	2.63	10.00 (4.10-13.30)	2.635 (0.820-4.100)	11.57	99
15+18+20+35+42	1.02	1.99	1.33	2.41	3.25	10.00 (4.10-13.30)	2.635 (0.820-4.100)	11.57	99
15+18+20+35+50	0.92	1.79	1.20	2.17	3.91	10.00 (4.10-13.30)	2.635 (0.820-4.100)	11.57	99
15+18+20+35+60	0.89	1.73	1.15	2.09	4.14	10.00 (4.10-13.30)	2.625 (0.820-4.090)	11.53	99
15+18+20+35+71	0.89	1.73	1.15	2.09	4.14	10.00 (4.10-13.30)	2.615 (0.820-4.080)	11.48	99
15+18+20+42+42	0.94	1.83	1.22	3.00	3.00	10.00 (4.10-13.30)	2.635 (0.820-4.100)	11.57	99
15+18+20+42+50	0.86	1.67	1.11	2.73	3.64	10.00 (4.10-13.30)	2.635 (0.820-4.100)	11.57	99
15+18+20+42+60	0.83	1.61	1.07	2.63	3.85	10.00 (4.10-13.30)	2.625 (0.820-4.090)	11.53	99
15+18+20+42+71	0.83	1.61	1.07	2.63	3.85	10.00 (4.10-13.30)	2.615 (0.820-4.080)	11.48	99

MXZ-5D102VA HEATING

Indoor units combination	Heating capacity (kW)						Outdoor unit power consumption(kW)	Current (A)	Power factor(%)
	Unit A	Unit B	Unit C	Unit D	Unit E	Total			
15+18+20+50+50	0.79	1.53	1.02	3.33	3.33	10.00 (4.10-13.30)	2.635 (0.820-4.100)	11.57	99
15+18+20+50+60	0.76	1.48	0.99	3.23	3.54	10.00 (4.10-13.30)	2.625 (0.820-4.090)	11.53	99
15+18+22+22+22	1.15	2.24	2.24	2.24	2.24	10.10 (4.10-13.50)	2.595 (0.800-4.100)	11.40	99
15+18+22+22+35	1.10	2.14	2.14	2.14	2.59	10.10 (4.10-13.50)	2.595 (0.800-4.100)	11.40	99
15+18+22+22+42	1.01	1.96	1.96	1.96	3.21	10.10 (4.10-13.50)	2.595 (0.800-4.100)	11.40	99
15+18+22+22+50	0.91	1.77	1.77	1.77	3.87	10.10 (4.10-13.50)	2.595 (0.800-4.100)	11.40	99
15+18+22+22+60	0.88	1.71	1.71	1.71	4.09	10.10 (4.10-13.50)	2.585 (0.800-4.090)	11.35	99
15+18+22+22+71	0.88	1.71	1.71	1.71	4.09	10.10 (4.10-13.50)	2.575 (0.800-4.080)	11.31	99
15+18+22+25+25	1.11	2.15	2.15	2.35	2.35	10.10 (4.10-13.50)	2.595 (0.800-4.100)	11.40	99
15+18+22+25+35	1.08	2.10	2.10	2.29	2.54	10.10 (4.10-13.50)	2.595 (0.800-4.100)	11.40	99
15+18+22+25+42	0.99	1.93	1.93	2.10	3.15	10.10 (4.10-13.50)	2.595 (0.800-4.100)	11.40	99
15+18+22+25+50	0.90	1.75	1.75	1.90	3.81	10.10 (4.10-13.50)	2.595 (0.800-4.100)	11.40	99
15+18+22+25+60	0.87	1.68	1.68	1.84	4.03	10.10 (4.10-13.50)	2.585 (0.800-4.090)	11.35	99
15+18+22+25+71	0.87	1.68	1.68	1.84	4.03	10.10 (4.10-13.50)	2.575 (0.800-4.080)	11.31	99
15+18+22+35+35	1.05	2.04	2.04	2.48	2.48	10.10 (4.10-13.50)	2.595 (0.800-4.100)	11.40	99
15+18+22+35+42	0.97	1.88	1.88	2.28	3.08	10.10 (4.10-13.50)	2.595 (0.800-4.100)	11.40	99
15+18+22+35+50	0.88	1.71	1.71	2.07	3.73	10.10 (4.10-13.50)	2.595 (0.800-4.100)	11.40	99
15+18+22+35+60	0.85	1.65	1.65	2.00	3.95	10.10 (4.10-13.50)	2.585 (0.800-4.090)	11.35	99
15+18+22+35+71	0.85	1.65	1.65	2.00	3.95	10.10 (4.10-13.50)	2.575 (0.800-4.080)	11.31	99
15+18+22+42+42	0.90	1.75	1.75	2.86	2.86	10.10 (4.10-13.50)	2.595 (0.800-4.100)	11.40	99
15+18+22+42+50	0.82	1.59	1.59	2.61	3.48	10.10 (4.10-13.50)	2.595 (0.800-4.100)	11.40	99
15+18+22+42+60	0.79	1.54	1.54	2.53	3.69	10.10 (4.10-13.50)	2.585 (0.800-4.090)	11.35	99
15+18+22+42+71	0.79	1.54	1.54	2.53	3.69	10.10 (4.10-13.50)	2.575 (0.800-4.080)	11.31	99
15+18+22+50+50	0.76	1.47	1.47	3.20	3.20	10.10 (4.10-13.50)	2.595 (0.800-4.100)	11.40	99
15+18+22+50+60	0.73	1.42	1.42	3.11	3.41	10.10 (4.10-13.50)	2.585 (0.800-4.090)	11.35	99
15+18+25+25+25	1.09	2.11	2.30	2.30	2.30	10.10 (4.10-13.50)	2.595 (0.800-4.100)	11.40	99
15+18+25+25+35	1.06	2.06	2.24	2.24	2.49	10.10 (4.10-13.50)	2.595 (0.800-4.100)	11.40	99
15+18+25+25+42	0.98	1.89	2.07	2.07	3.10	10.10 (4.10-13.50)	2.595 (0.800-4.100)	11.40	99
15+18+25+25+50	0.89	1.72	1.87	1.87	3.75	10.10 (4.10-13.50)	2.595 (0.800-4.100)	11.40	99
15+18+25+25+60	0.85	1.66	1.81	1.81	3.97	10.10 (4.10-13.50)	2.585 (0.800-4.090)	11.35	99
15+18+25+25+71	0.85	1.66	1.81	1.81	3.97	10.10 (4.10-13.50)	2.575 (0.800-4.080)	11.31	99
15+18+25+35+35	1.03	2.01	2.19	2.43	2.43	10.10 (4.10-13.50)	2.595 (0.800-4.100)	11.40	99
15+18+25+35+42	0.95	1.85	2.02	2.24	3.03	10.10 (4.10-13.50)	2.595 (0.800-4.100)	11.40	99
15+18+25+35+50	0.87	1.68	1.84	2.04	3.67	10.10 (4.10-13.50)	2.595 (0.800-4.100)	11.40	99
15+18+25+35+60	0.84	1.63	1.77	1.97	3.89	10.10 (4.10-13.50)	2.585 (0.800-4.090)	11.35	99
15+18+25+35+71	0.84	1.63	1.77	1.97	3.89	10.10 (4.10-13.50)	2.575 (0.800-4.080)	11.31	99
15+18+25+42+42	0.89	1.72	1.87	2.81	2.81	10.10 (4.10-13.50)	2.595 (0.800-4.100)	11.40	99
15+18+25+42+50	0.81	1.57	1.72	2.57	3.43	10.10 (4.10-13.50)	2.595 (0.800-4.100)	11.40	99
15+18+25+42+60	0.78	1.52	1.66	2.49	3.64	10.10 (4.10-13.50)	2.585 (0.800-4.090)	11.35	99
15+18+25+42+71	0.78	1.52	1.66	2.49	3.64	10.10 (4.10-13.50)	2.575 (0.800-4.080)	11.31	99
15+18+25+50+50	0.75	1.45	1.58	3.16	3.16	10.10 (4.10-13.50)	2.595 (0.800-4.100)	11.40	99

MXZ-5D102VA HEATING

Indoor units combination	Heating capacity (kW)						Outdoor unit power consumption(kW)	Current (A)	Power factor(%)
	Unit A	Unit B	Unit C	Unit D	Unit E	Total			
15+18+25+50+60	0.72	1.41	1.53	3.07	3.37	10.10 (4.10-13.50)	2.585 (0.800-4.090)	11.35	99
15+18+35+35+35	1.01	1.96	2.38	2.38	2.38	10.10 (4.10-13.50)	2.595 (0.800-4.100)	11.40	99
15+18+35+35+42	0.93	1.81	2.20	2.20	2.96	10.10 (4.10-13.50)	2.595 (0.800-4.100)	11.40	99
15+18+35+35+50	0.85	1.65	2.00	2.00	3.60	10.10 (4.10-13.50)	2.595 (0.800-4.100)	11.40	99
15+18+35+35+60	0.82	1.59	1.93	1.93	3.82	10.10 (4.10-13.50)	2.585 (0.800-4.090)	11.35	99
15+18+35+42+42	0.87	1.68	2.04	2.75	2.75	10.10 (4.10-13.50)	2.595 (0.800-4.100)	11.40	99
15+18+35+42+50	0.79	1.54	1.87	2.53	3.37	10.10 (4.10-13.50)	2.595 (0.800-4.100)	11.40	99
15+18+35+42+60	0.77	1.49	1.81	2.45	3.58	10.10 (4.10-13.50)	2.585 (0.800-4.090)	11.35	99
15+18+35+50+50	0.73	1.42	1.73	3.11	3.11	10.10 (4.10-13.50)	2.595 (0.800-4.100)	11.40	99
15+18+42+42+42	0.81	1.57	2.57	2.57	2.57	10.10 (4.10-13.50)	2.595 (0.800-4.100)	11.40	99
15+18+42+42+50	0.75	1.45	2.37	2.37	3.16	10.10 (4.10-13.50)	2.595 (0.800-4.100)	11.40	99
15+20+20+20+20	1.57	2.03	2.03	2.03	2.03	9.70 (4.10-12.70)	2.755 (0.880-4.100)	12.10	99
15+20+20+20+22	1.44	1.86	1.86	1.86	2.79	9.80 (4.10-12.90)	2.715 (0.860-4.100)	11.92	99
15+20+20+20+25	1.40	1.81	1.81	1.81	2.96	9.80 (4.10-12.90)	2.715 (0.860-4.100)	11.92	99
15+20+20+20+35	1.35	1.75	1.75	1.75	3.19	9.80 (4.10-12.90)	2.715 (0.860-4.100)	11.92	99
15+20+20+20+42	1.22	1.57	1.57	1.57	3.86	9.80 (4.10-12.90)	2.715 (0.860-4.100)	11.92	99
15+20+20+20+50	1.07	1.39	1.39	1.39	4.55	9.80 (4.10-12.90)	2.715 (0.860-4.100)	11.92	99
15+20+20+20+60	1.03	1.33	1.33	1.33	4.78	9.80 (4.10-12.90)	2.705 (0.860-4.090)	11.88	99
15+20+20+20+71	1.03	1.33	1.33	1.33	4.78	9.80 (4.10-12.90)	2.695 (0.860-4.080)	11.84	99
15+20+20+22+22	1.33	1.71	1.71	2.57	2.57	9.90 (4.10-13.10)	2.675 (0.840-4.100)	11.75	99
15+20+20+22+35	1.26	1.63	1.63	2.44	2.96	9.90 (4.10-13.10)	2.675 (0.840-4.100)	11.75	99
15+20+20+22+42	1.14	1.47	1.47	2.21	3.61	9.90 (4.10-13.10)	2.675 (0.840-4.100)	11.75	99
15+20+20+22+50	1.01	1.31	1.31	1.97	4.29	9.90 (4.10-13.10)	2.675 (0.840-4.100)	11.75	99
15+20+20+22+60	0.97	1.26	1.26	1.89	4.52	9.90 (4.10-13.10)	2.665 (0.840-4.090)	11.70	99
15+20+20+22+71	0.97	1.26	1.26	1.89	4.52	9.90 (4.10-13.10)	2.655 (0.840-4.080)	11.66	99
15+20+20+25+25	1.27	1.64	1.64	2.68	2.68	9.90 (4.10-13.10)	2.675 (0.840-4.100)	11.75	99
15+20+20+25+35	1.23	1.59	1.59	2.60	2.89	9.90 (4.10-13.10)	2.675 (0.840-4.100)	11.75	99
15+20+20+25+42	1.11	1.44	1.44	2.36	3.54	9.90 (4.10-13.10)	2.675 (0.840-4.100)	11.75	99
15+20+20+25+50	1.00	1.29	1.29	2.11	4.22	9.90 (4.10-13.10)	2.675 (0.840-4.100)	11.75	99
15+20+20+25+60	0.96	1.24	1.24	2.03	4.44	9.90 (4.10-13.10)	2.665 (0.840-4.090)	11.70	99
15+20+20+25+71	0.96	1.24	1.24	2.03	4.44	9.90 (4.10-13.10)	2.655 (0.840-4.080)	11.66	99
15+20+20+35+35	1.19	1.54	1.54	2.81	2.81	9.90 (4.10-13.10)	2.675 (0.840-4.100)	11.75	99
15+20+20+35+42	1.09	1.41	1.41	2.55	3.45	9.90 (4.10-13.10)	2.675 (0.840-4.100)	11.75	99
15+20+20+35+50	0.97	1.26	1.26	2.29	4.12	9.90 (4.10-13.10)	2.675 (0.840-4.100)	11.75	99
15+20+20+35+60	0.94	1.21	1.21	2.20	4.35	9.90 (4.10-13.10)	2.665 (0.840-4.090)	11.70	99
15+20+20+35+71	0.94	1.21	1.21	2.20	4.35	9.90 (4.10-13.10)	2.655 (0.840-4.080)	11.66	99
15+20+20+42+42	1.00	1.29	1.29	3.16	3.16	9.90 (4.10-13.10)	2.675 (0.840-4.100)	11.75	99
15+20+20+42+50	0.90	1.16	1.16	2.86	3.81	9.90 (4.10-13.10)	2.675 (0.840-4.100)	11.75	99
15+20+20+42+60	0.87	1.12	1.12	2.76	4.03	9.90 (4.10-13.10)	2.665 (0.840-4.090)	11.70	99
15+20+20+42+71	0.87	1.12	1.12	2.76	4.03	9.90 (4.10-13.10)	2.655 (0.840-4.080)	11.66	99
15+20+20+50+50	0.82	1.06	1.06	3.48	3.48	9.90 (4.10-13.10)	2.675 (0.840-4.100)	11.75	99

MXZ-5D102VA HEATING

Indoor units combination	Heating capacity (kW)						Outdoor unit power consumption(kW)	Current (A)	Power factor(%)
	Unit A	Unit B	Unit C	Unit D	Unit E	Total			
15+20+20+50+60	0.79	1.03	1.03	3.36	3.69	9.90 (4.10-13.10)	2.665 (0.840-4.090)	11.70	99
15+20+22+22+22	1.23	1.59	2.39	2.39	2.39	10.00 (4.10-13.30)	2.635 (0.820-4.100)	11.57	99
15+20+22+22+25	1.21	1.56	2.34	2.34	2.55	10.00 (4.10-13.30)	2.635 (0.820-4.100)	11.57	99
15+20+22+22+35	1.17	1.52	2.28	2.28	2.76	10.00 (4.10-13.30)	2.635 (0.820-4.100)	11.57	99
15+20+22+22+42	1.07	1.38	2.08	2.08	3.40	10.00 (4.10-13.30)	2.635 (0.820-4.100)	11.57	99
15+20+22+22+50	0.96	1.24	1.86	1.86	4.07	10.00 (4.10-13.30)	2.635 (0.820-4.100)	11.57	99
15+20+22+22+60	0.92	1.20	1.79	1.79	4.29	10.00 (4.10-13.30)	2.625 (0.820-4.090)	11.53	99
15+20+22+22+71	0.92	1.20	1.79	1.79	4.29	10.00 (4.10-13.30)	2.615 (0.820-4.080)	11.48	99
15+20+22+25+25	1.18	1.53	2.29	2.50	2.50	10.00 (4.10-13.30)	2.635 (0.820-4.100)	11.57	99
15+20+22+25+35	1.15	1.49	2.23	2.43	2.70	10.00 (4.10-13.30)	2.635 (0.820-4.100)	11.57	99
15+20+22+25+42	1.05	1.36	2.04	2.22	3.33	10.00 (4.10-13.30)	2.635 (0.820-4.100)	11.57	99
15+20+22+25+50	0.94	1.22	1.83	2.00	4.00	10.00 (4.10-13.30)	2.635 (0.820-4.100)	11.57	99
15+20+22+25+60	0.91	1.18	1.76	1.93	4.22	10.00 (4.10-13.30)	2.625 (0.820-4.090)	11.53	99
15+20+22+25+71	0.91	1.18	1.76	1.93	4.22	10.00 (4.10-13.30)	2.615 (0.820-4.080)	11.48	99
15+20+22+35+35	1.12	1.45	2.17	2.63	2.63	10.00 (4.10-13.30)	2.635 (0.820-4.100)	11.57	99
15+20+22+35+42	1.02	1.33	1.99	2.41	3.25	10.00 (4.10-13.30)	2.635 (0.820-4.100)	11.57	99
15+20+22+35+50	0.92	1.20	1.79	2.17	3.91	10.00 (4.10-13.30)	2.635 (0.820-4.100)	11.57	99
15+20+22+35+60	0.89	1.15	1.73	2.09	4.14	10.00 (4.10-13.30)	2.625 (0.820-4.090)	11.53	99
15+20+22+35+71	0.89	1.15	1.73	2.09	4.14	10.00 (4.10-13.30)	2.615 (0.820-4.080)	11.48	99
15+20+22+42+42	0.94	1.22	1.83	3.00	3.00	10.00 (4.10-13.30)	2.635 (0.820-4.100)	11.57	99
15+20+22+42+50	0.86	1.11	1.67	2.73	3.64	10.00 (4.10-13.30)	2.635 (0.820-4.100)	11.57	99
15+20+22+42+60	0.83	1.07	1.61	2.63	3.85	10.00 (4.10-13.30)	2.625 (0.820-4.090)	11.53	99
15+20+22+42+71	0.83	1.07	1.61	2.63	3.85	10.00 (4.10-13.30)	2.615 (0.820-4.080)	11.48	99
15+20+22+50+50	0.79	1.02	1.53	3.33	3.33	10.00 (4.10-13.30)	2.635 (0.820-4.100)	11.57	99
15+20+22+50+60	0.76	0.99	1.48	3.23	3.54	10.00 (4.10-13.30)	2.625 (0.820-4.090)	11.53	99
15+20+25+25+25	1.16	1.50	2.45	2.45	2.45	10.00 (4.10-13.30)	2.635 (0.820-4.100)	11.57	99
15+20+25+25+35	1.13	1.46	2.38	2.38	2.65	10.00 (4.10-13.30)	2.635 (0.820-4.100)	11.57	99
15+20+25+25+42	1.03	1.33	2.18	2.18	3.27	10.00 (4.10-13.30)	2.635 (0.820-4.100)	11.57	99
15+20+25+25+50	0.93	1.20	1.97	1.97	3.93	10.00 (4.10-13.30)	2.635 (0.820-4.100)	11.57	99
15+20+25+25+60	0.89	1.16	1.89	1.89	4.16	10.00 (4.10-13.30)	2.625 (0.820-4.090)	11.53	99
15+20+25+25+71	0.89	1.16	1.89	1.89	4.16	10.00 (4.10-13.30)	2.615 (0.820-4.080)	11.48	99
15+20+25+35+35	1.10	1.42	2.32	2.58	2.58	10.00 (4.10-13.30)	2.635 (0.820-4.100)	11.57	99
15+20+25+35+42	1.01	1.30	2.13	2.37	3.20	10.00 (4.10-13.30)	2.635 (0.820-4.100)	11.57	99
15+20+25+35+50	0.91	1.18	1.93	2.14	3.85	10.00 (4.10-13.30)	2.635 (0.820-4.100)	11.57	99
15+20+25+35+60	0.88	1.13	1.86	2.06	4.07	10.00 (4.10-13.30)	2.625 (0.820-4.090)	11.53	99
15+20+25+35+71	0.88	1.13	1.86	2.06	4.07	10.00 (4.10-13.30)	2.615 (0.820-4.080)	11.48	99
15+20+25+42+42	0.93	1.20	1.97	2.95	2.95	10.00 (4.10-13.30)	2.635 (0.820-4.100)	11.57	99
15+20+25+42+50	0.85	1.09	1.79	2.69	3.58	10.00 (4.10-13.30)	2.635 (0.820-4.100)	11.57	99
15+20+25+42+60	0.82	1.06	1.73	2.60	3.80	10.00 (4.10-13.30)	2.625 (0.820-4.090)	11.53	99
15+20+25+50+50	0.78	1.00	1.64	3.29	3.29	10.00 (4.10-13.30)	2.635 (0.820-4.100)	11.57	99
15+20+25+50+60	0.75	0.97	1.59	3.19	3.50	10.00 (4.10-13.30)	2.625 (0.820-4.090)	11.53	99

MXZ-5D102VA HEATING

Indoor units combination	Heating capacity (kW)						Outdoor unit power consumption(kW)	Current (A)	Power factor(%)
	Unit A	Unit B	Unit C	Unit D	Unit E	Total			
15+20+35+35+35	1.07	1.38	2.52	2.52	2.52	10.00 (4.10-13.30)	2.635 (0.820-4.100)	11.57	99
15+20+35+35+42	0.98	1.27	2.31	2.31	3.12	10.00 (4.10-13.30)	2.635 (0.820-4.100)	11.57	99
15+20+35+35+50	0.89	1.15	2.09	2.09	3.77	10.00 (4.10-13.30)	2.635 (0.820-4.100)	11.57	99
15+20+35+35+60	0.86	1.11	2.02	2.02	3.99	10.00 (4.10-13.30)	2.625 (0.820-4.090)	11.53	99
15+20+35+42+42	0.91	1.18	2.14	2.89	2.89	10.00 (4.10-13.30)	2.635 (0.820-4.100)	11.57	99
15+20+35+42+50	0.83	1.07	1.95	2.63	3.51	10.00 (4.10-13.30)	2.635 (0.820-4.100)	11.57	99
15+20+35+42+60	0.80	1.04	1.89	2.55	3.73	10.00 (4.10-13.30)	2.625 (0.820-4.090)	11.53	99
15+20+35+50+50	0.76	0.99	1.79	3.23	3.23	10.00 (4.10-13.30)	2.635 (0.820-4.100)	11.57	99
15+20+42+42+42	0.85	1.09	2.69	2.69	2.69	10.00 (4.10-13.30)	2.635 (0.820-4.100)	11.57	99
15+20+42+42+50	0.78	1.00	2.47	2.47	3.29	10.00 (4.10-13.30)	2.635 (0.820-4.100)	11.57	99
15+22+22+22+22	1.15	2.24	2.24	2.24	2.24	10.10 (4.10-13.50)	2.595 (0.800-4.100)	11.40	99
15+22+22+22+25	1.13	2.19	2.19	2.19	2.39	10.10 (4.10-13.50)	2.595 (0.800-4.100)	11.40	99
15+22+22+22+35	1.10	2.14	2.14	2.14	2.59	10.10 (4.10-13.50)	2.595 (0.800-4.100)	11.40	99
15+22+22+22+42	1.01	1.96	1.96	1.96	3.21	10.10 (4.10-13.50)	2.595 (0.800-4.100)	11.40	99
15+22+22+22+50	0.91	1.77	1.77	1.77	3.87	10.10 (4.10-13.50)	2.595 (0.800-4.100)	11.40	99
15+22+22+22+60	0.88	1.71	1.71	1.71	4.09	10.10 (4.10-13.50)	2.585 (0.800-4.090)	11.35	99
15+22+22+22+71	0.88	1.71	1.71	1.71	4.09	10.10 (4.10-13.50)	2.575 (0.800-4.080)	11.31	99
15+22+22+25+25	1.11	2.15	2.15	2.35	2.35	10.10 (4.10-13.50)	2.595 (0.800-4.100)	11.40	99
15+22+22+25+35	1.08	2.10	2.10	2.29	2.54	10.10 (4.10-13.50)	2.595 (0.800-4.100)	11.40	99
15+22+22+25+42	0.99	1.93	1.93	2.10	3.15	10.10 (4.10-13.50)	2.595 (0.800-4.100)	11.40	99
15+22+22+25+50	0.90	1.75	1.75	1.90	3.81	10.10 (4.10-13.50)	2.595 (0.800-4.100)	11.40	99
15+22+22+25+60	0.87	1.68	1.68	1.84	4.03	10.10 (4.10-13.50)	2.585 (0.800-4.090)	11.35	99
15+22+22+25+71	0.87	1.68	1.68	1.84	4.03	10.10 (4.10-13.50)	2.575 (0.800-4.080)	11.31	99
15+22+22+35+35	1.05	2.04	2.04	2.48	2.48	10.10 (4.10-13.50)	2.595 (0.800-4.100)	11.40	99
15+22+22+35+42	0.97	1.88	1.88	2.28	3.08	10.10 (4.10-13.50)	2.595 (0.800-4.100)	11.40	99
15+22+22+35+50	0.88	1.71	1.71	2.07	3.73	10.10 (4.10-13.50)	2.595 (0.800-4.100)	11.40	99
15+22+22+35+60	0.85	1.65	1.65	2.00	3.95	10.10 (4.10-13.50)	2.585 (0.800-4.090)	11.35	99
15+22+22+35+71	0.85	1.65	1.65	2.00	3.95	10.10 (4.10-13.50)	2.575 (0.800-4.080)	11.31	99
15+22+22+42+42	0.90	1.75	1.75	2.86	2.86	10.10 (4.10-13.50)	2.595 (0.800-4.100)	11.40	99
15+22+22+42+50	0.82	1.59	1.59	2.61	3.48	10.10 (4.10-13.50)	2.595 (0.800-4.100)	11.40	99
15+22+22+42+60	0.79	1.54	1.54	2.53	3.69	10.10 (4.10-13.50)	2.585 (0.800-4.090)	11.35	99
15+22+22+42+71	0.79	1.54	1.54	2.53	3.69	10.10 (4.10-13.50)	2.575 (0.800-4.080)	11.31	99
15+22+22+50+50	0.76	1.47	1.47	3.20	3.20	10.10 (4.10-13.50)	2.595 (0.800-4.100)	11.40	99
15+22+22+50+60	0.73	1.42	1.42	3.11	3.41	10.10 (4.10-13.50)	2.585 (0.800-4.090)	11.35	99
15+22+25+25+25	1.09	2.11	2.30	2.30	2.30	10.10 (4.10-13.50)	2.595 (0.800-4.100)	11.40	99
15+22+25+25+35	1.06	2.06	2.24	2.24	2.49	10.10 (4.10-13.50)	2.595 (0.800-4.100)	11.40	99
15+22+25+25+42	0.98	1.89	2.07	2.07	3.10	10.10 (4.10-13.50)	2.595 (0.800-4.100)	11.40	99
15+22+25+25+50	0.89	1.72	1.87	1.87	3.75	10.10 (4.10-13.50)	2.595 (0.800-4.100)	11.40	99
15+22+25+25+60	0.85	1.66	1.81	1.81	3.97	10.10 (4.10-13.50)	2.585 (0.800-4.090)	11.35	99
15+22+25+25+71	0.85	1.66	1.81	1.81	3.97	10.10 (4.10-13.50)	2.575 (0.800-4.080)	11.31	99
15+22+25+35+35	1.03	2.01	2.19	2.43	2.43	10.10 (4.10-13.50)	2.595 (0.800-4.100)	11.40	99

MXZ-5D102VA HEATING

Indoor units combination	Heating capacity (kW)						Outdoor unit power consumption(kW)	Current (A)	Power factor(%)
	Unit A	Unit B	Unit C	Unit D	Unit E	Total			
15+22+25+35+42	0.95	1.85	2.02	2.24	3.03	10.10 (4.10-13.50)	2.595 (0.800-4.100)	11.40	99
15+22+25+35+50	0.87	1.68	1.84	2.04	3.67	10.10 (4.10-13.50)	2.595 (0.800-4.100)	11.40	99
15+22+25+35+60	0.84	1.63	1.77	1.97	3.89	10.10 (4.10-13.50)	2.585 (0.800-4.090)	11.35	99
15+22+25+35+71	0.84	1.63	1.77	1.97	3.89	10.10 (4.10-13.50)	2.575 (0.800-4.080)	11.31	99
15+22+25+42+42	0.89	1.72	1.87	2.81	2.81	10.10 (4.10-13.50)	2.595 (0.800-4.100)	11.40	99
15+22+25+42+50	0.81	1.57	1.72	2.57	3.43	10.10 (4.10-13.50)	2.595 (0.800-4.100)	11.40	99
15+22+25+42+60	0.78	1.52	1.66	2.49	3.64	10.10 (4.10-13.50)	2.585 (0.800-4.090)	11.35	99
15+22+25+50+50	0.75	1.45	1.58	3.16	3.16	10.10 (4.10-13.50)	2.595 (0.800-4.100)	11.40	99
15+22+25+50+60	0.72	1.41	1.53	3.07	3.37	10.10 (4.10-13.50)	2.585 (0.800-4.090)	11.35	99
15+22+35+35+35	1.01	1.96	2.38	2.38	2.38	10.10 (4.10-13.50)	2.595 (0.800-4.100)	11.40	99
15+22+35+35+42	0.93	1.81	2.20	2.20	2.96	10.10 (4.10-13.50)	2.595 (0.800-4.100)	11.40	99
15+22+35+35+50	0.85	1.65	2.00	2.00	3.60	10.10 (4.10-13.50)	2.595 (0.800-4.100)	11.40	99
15+22+35+35+60	0.82	1.59	1.93	1.93	3.82	10.10 (4.10-13.50)	2.585 (0.800-4.090)	11.35	99
15+22+35+42+42	0.87	1.68	2.04	2.75	2.75	10.10 (4.10-13.50)	2.595 (0.800-4.100)	11.40	99
15+22+35+42+50	0.79	1.54	1.87	2.53	3.37	10.10 (4.10-13.50)	2.595 (0.800-4.100)	11.40	99
15+22+35+50+50	0.73	1.42	1.73	3.11	3.11	10.10 (4.10-13.50)	2.595 (0.800-4.100)	11.40	99
15+22+42+42+42	0.81	1.57	2.57	2.57	2.57	10.10 (4.10-13.50)	2.595 (0.800-4.100)	11.40	99
15+22+42+42+50	0.75	1.45	2.37	2.37	3.16	10.10 (4.10-13.50)	2.595 (0.800-4.100)	11.40	99
15+25+25+25+25	1.07	2.26	2.26	2.26	2.26	10.10 (4.10-13.50)	2.595 (0.800-4.100)	11.40	99
15+25+25+25+35	1.04	2.20	2.20	2.20	2.45	10.10 (4.10-13.50)	2.595 (0.800-4.100)	11.40	99
15+25+25+25+42	0.96	2.03	2.03	2.03	3.05	10.10 (4.10-13.50)	2.595 (0.800-4.100)	11.40	99
15+25+25+25+50	0.87	1.85	1.85	1.85	3.69	10.10 (4.10-13.50)	2.595 (0.800-4.100)	11.40	99
15+25+25+25+60	0.84	1.78	1.78	1.78	3.91	10.10 (4.10-13.50)	2.585 (0.800-4.090)	11.35	99
15+25+25+25+71	0.84	1.78	1.78	1.78	3.91	10.10 (4.10-13.50)	2.575 (0.800-4.080)	11.31	99
15+25+25+35+35	1.02	2.15	2.15	2.39	2.39	10.10 (4.10-13.50)	2.595 (0.800-4.100)	11.40	99
15+25+25+35+42	0.94	1.99	1.99	2.21	2.98	10.10 (4.10-13.50)	2.595 (0.800-4.100)	11.40	99
15+25+25+35+50	0.85	1.81	1.81	2.01	3.62	10.10 (4.10-13.50)	2.595 (0.800-4.100)	11.40	99
15+25+25+35+60	0.83	1.75	1.75	1.94	3.84	10.10 (4.10-13.50)	2.585 (0.800-4.090)	11.35	99
15+25+25+35+71	0.83	1.75	1.75	1.94	3.84	10.10 (4.10-13.50)	2.575 (0.800-4.080)	11.31	99
15+25+25+42+42	0.87	1.85	1.85	2.77	2.77	10.10 (4.10-13.50)	2.595 (0.800-4.100)	11.40	99
15+25+25+42+50	0.80	1.69	1.69	2.54	3.38	10.10 (4.10-13.50)	2.595 (0.800-4.100)	11.40	99
15+25+25+42+60	0.77	1.64	1.64	2.46	3.59	10.10 (4.10-13.50)	2.585 (0.800-4.090)	11.35	99
15+25+25+50+50	0.74	1.56	1.56	3.12	3.12	10.10 (4.10-13.50)	2.595 (0.800-4.100)	11.40	99
15+25+35+35+35	0.99	2.10	2.34	2.34	2.34	10.10 (4.10-13.50)	2.595 (0.800-4.100)	11.40	99
15+25+35+35+42	0.92	1.94	2.16	2.16	2.92	10.10 (4.10-13.50)	2.595 (0.800-4.100)	11.40	99
15+25+35+35+50	0.84	1.77	1.97	1.97	3.55	10.10 (4.10-13.50)	2.595 (0.800-4.100)	11.40	99
15+25+35+35+60	0.81	1.72	1.91	1.91	3.76	10.10 (4.10-13.50)	2.585 (0.800-4.090)	11.35	99
15+25+35+42+42	0.85	1.81	2.01	2.71	2.71	10.10 (4.10-13.50)	2.595 (0.800-4.100)	11.40	99
15+25+35+42+50	0.78	1.66	1.84	2.49	3.32	10.10 (4.10-13.50)	2.595 (0.800-4.100)	11.40	99
15+25+42+42+42	0.80	1.69	2.54	2.54	2.54	10.10 (4.10-13.50)	2.595 (0.800-4.100)	11.40	99
15+35+35+35+35	0.97	2.28	2.28	2.28	2.28	10.10 (4.10-13.50)	2.595 (0.800-4.100)	11.40	99

MXZ-5D102VA HEATING

Indoor units combination	Heating capacity (kW)						Outdoor unit power consumption(kW)	Current (A)	Power factor(%)
	Unit A	Unit B	Unit C	Unit D	Unit E	Total			
15+35+35+35+42	0.90	2.12	2.12	2.12	2.86	10.10 (4.10-13.50)	2.595 (0.800-4.100)	11.40	99
15+35+35+35+50	0.82	1.93	1.93	1.93	3.48	10.10 (4.10-13.50)	2.595 (0.800-4.100)	11.40	99
15+35+35+42+42	0.84	1.97	1.97	2.66	2.66	10.10 (4.10-13.50)	2.595 (0.800-4.100)	11.40	99
18+18+18+18+18	2.10	2.10	2.10	2.10	2.10	10.50 (4.10-14.00)	2.765 (0.780-4.100)	12.14	99
18+18+18+18+20	2.23	2.23	2.23	2.23	1.49	10.40 (4.10-13.80)	2.805 (0.800-4.100)	12.32	99
18+18+18+18+22	2.10	2.10	2.10	2.10	2.10	10.50 (4.10-14.00)	2.765 (0.780-4.100)	12.14	99
18+18+18+18+25	2.06	2.06	2.06	2.06	2.25	10.50 (4.10-14.00)	2.765 (0.780-4.100)	12.14	99
18+18+18+18+35	2.01	2.01	2.01	2.01	2.44	10.50 (4.10-14.00)	2.765 (0.780-4.100)	12.14	99
18+18+18+18+42	1.86	1.86	1.86	1.86	3.05	10.50 (4.10-14.00)	2.765 (0.780-4.100)	12.14	99
18+18+18+18+50	1.70	1.70	1.70	1.70	3.71	10.50 (4.10-14.00)	2.765 (0.780-4.100)	12.14	99
18+18+18+18+60	1.64	1.64	1.64	1.64	3.93	10.50 (4.10-14.00)	2.755 (0.780-4.090)	12.10	99
18+18+18+18+71	1.64	1.64	1.64	1.64	3.93	10.50 (4.10-14.00)	2.745 (0.780-4.080)	12.06	99
18+18+18+20+20	2.38	2.38	2.38	1.58	1.58	10.30 (4.10-13.60)	2.845 (0.820-4.100)	12.49	99
18+18+18+20+22	2.23	2.23	2.23	1.49	2.23	10.40 (4.10-13.80)	2.805 (0.800-4.100)	12.32	99
18+18+18+20+25	2.19	2.19	2.19	1.46	2.38	10.40 (4.10-13.80)	2.805 (0.800-4.100)	12.32	99
18+18+18+20+35	2.13	2.13	2.13	1.42	2.58	10.40 (4.10-13.80)	2.805 (0.800-4.100)	12.32	99
18+18+18+20+42	1.96	1.96	1.96	1.31	3.21	10.40 (4.10-13.80)	2.805 (0.800-4.100)	12.32	99
18+18+18+20+50	1.78	1.78	1.78	1.19	3.88	10.40 (4.10-13.80)	2.805 (0.800-4.100)	12.32	99
18+18+18+20+60	1.72	1.72	1.72	1.14	4.11	10.40 (4.10-13.80)	2.795 (0.800-4.090)	12.27	99
18+18+18+20+71	1.72	1.72	1.72	1.14	4.11	10.40 (4.10-13.80)	2.785 (0.800-4.080)	12.23	99
18+18+18+22+22	2.10	2.10	2.10	2.10	2.10	10.50 (4.10-14.00)	2.765 (0.780-4.100)	12.14	99
18+18+18+22+25	2.06	2.06	2.06	2.06	2.25	10.50 (4.10-14.00)	2.765 (0.780-4.100)	12.14	99
18+18+18+22+35	2.01	2.01	2.01	2.01	2.44	10.50 (4.10-14.00)	2.765 (0.780-4.100)	12.14	99
18+18+18+22+42	1.86	1.86	1.86	1.86	3.05	10.50 (4.10-14.00)	2.765 (0.780-4.100)	12.14	99
18+18+18+22+50	1.70	1.70	1.70	1.70	3.71	10.50 (4.10-14.00)	2.765 (0.780-4.100)	12.14	99
18+18+18+22+60	1.64	1.64	1.64	1.64	3.93	10.50 (4.10-14.00)	2.755 (0.780-4.090)	12.10	99
18+18+18+22+71	1.64	1.64	1.64	1.64	3.93	10.50 (4.10-14.00)	2.745 (0.780-4.080)	12.06	99
18+18+18+25+25	2.03	2.03	2.03	2.21	2.21	10.50 (4.10-14.00)	2.765 (0.780-4.100)	12.14	99
18+18+18+25+35	1.98	1.98	1.98	2.16	2.40	10.50 (4.10-14.00)	2.765 (0.780-4.100)	12.14	99
18+18+18+25+42	1.83	1.83	1.83	2.00	3.00	10.50 (4.10-14.00)	2.765 (0.780-4.100)	12.14	99
18+18+18+25+50	1.67	1.67	1.67	1.83	3.65	10.50 (4.10-14.00)	2.765 (0.780-4.100)	12.14	99
18+18+18+25+60	1.62	1.62	1.62	1.77	3.88	10.50 (4.10-14.00)	2.755 (0.780-4.090)	12.10	99
18+18+18+25+71	1.62	1.62	1.62	1.77	3.88	10.50 (4.10-14.00)	2.745 (0.780-4.080)	12.06	99
18+18+18+35+35	1.94	1.94	1.94	2.35	2.35	10.50 (4.10-14.00)	2.765 (0.780-4.100)	12.14	99
18+18+18+35+42	1.80	1.80	1.80	2.18	2.94	10.50 (4.10-14.00)	2.765 (0.780-4.100)	12.14	99
18+18+18+35+50	1.64	1.64	1.64	1.99	3.58	10.50 (4.10-14.00)	2.765 (0.780-4.100)	12.14	99
18+18+18+35+60	1.59	1.59	1.59	1.93	3.81	10.50 (4.10-14.00)	2.755 (0.780-4.090)	12.10	99
18+18+18+35+71	1.59	1.59	1.59	1.93	3.81	10.50 (4.10-14.00)	2.745 (0.780-4.080)	12.06	99
18+18+18+42+42	1.67	1.67	1.67	2.74	2.74	10.50 (4.10-14.00)	2.765 (0.780-4.100)	12.14	99
18+18+18+42+50	1.54	1.54	1.54	2.52	3.36	10.50 (4.10-14.00)	2.765 (0.780-4.100)	12.14	99
18+18+18+42+60	1.49	1.49	1.49	2.44	3.58	10.50 (4.10-14.00)	2.755 (0.780-4.090)	12.10	99

MXZ-5D102VA HEATING

Indoor units combination	Heating capacity (kW)						Outdoor unit power consumption(kW)	Current (A)	Power factor(%)
	Unit A	Unit B	Unit C	Unit D	Unit E	Total			
18+18+18+42+71	1.49	1.49	1.49	2.44	3.58	10.50 (4.10-14.00)	2.745 (0.780-4.080)	12.06	99
18+18+18+50+50	1.43	1.43	1.43	3.11	3.11	10.50 (4.10-14.00)	2.765 (0.780-4.100)	12.14	99
18+18+18+50+60	1.39	1.39	1.39	3.02	3.32	10.50 (4.10-14.00)	2.755 (0.780-4.090)	12.10	99
18+18+20+20+20	2.55	2.55	1.70	1.70	1.70	10.20 (4.10-13.40)	2.885 (0.840-4.100)	12.67	99
18+18+20+20+22	2.38	2.38	1.58	1.58	2.38	10.30 (4.10-13.60)	2.845 (0.820-4.100)	12.49	99
18+18+20+20+25	2.33	2.33	1.55	1.55	2.54	10.30 (4.10-13.60)	2.845 (0.820-4.100)	12.49	99
18+18+20+20+35	2.27	2.27	1.51	1.51	2.75	10.30 (4.10-13.60)	2.845 (0.820-4.100)	12.49	99
18+18+20+20+42	2.07	2.07	1.38	1.38	3.39	10.30 (4.10-13.60)	2.845 (0.820-4.100)	12.49	99
18+18+20+20+50	1.87	1.87	1.25	1.25	4.07	10.30 (4.10-13.60)	2.845 (0.820-4.100)	12.49	99
18+18+20+20+60	1.80	1.80	1.20	1.20	4.31	10.30 (4.10-13.60)	2.835 (0.820-4.090)	12.45	99
18+18+20+20+71	1.80	1.80	1.20	1.20	4.31	10.30 (4.10-13.60)	2.825 (0.820-4.080)	12.41	99
18+18+20+22+22	2.23	2.23	1.49	2.23	2.23	10.40 (4.10-13.80)	2.805 (0.800-4.100)	12.32	99
18+18+20+22+25	2.19	2.19	1.46	2.19	2.38	10.40 (4.10-13.80)	2.805 (0.800-4.100)	12.32	99
18+18+20+22+35	2.13	2.13	1.42	2.13	2.58	10.40 (4.10-13.80)	2.805 (0.800-4.100)	12.32	99
18+18+20+22+42	1.96	1.96	1.31	1.96	3.21	10.40 (4.10-13.80)	2.805 (0.800-4.100)	12.32	99
18+18+20+22+50	1.78	1.78	1.19	1.78	3.88	10.40 (4.10-13.80)	2.805 (0.800-4.100)	12.32	99
18+18+20+22+60	1.72	1.72	1.14	1.72	4.11	10.40 (4.10-13.80)	2.795 (0.800-4.090)	12.27	99
18+18+20+22+71	1.72	1.72	1.14	1.72	4.11	10.40 (4.10-13.80)	2.785 (0.800-4.080)	12.23	99
18+18+20+25+25	2.15	2.15	1.43	2.34	2.34	10.40 (4.10-13.80)	2.805 (0.800-4.100)	12.32	99
18+18+20+25+35	2.09	2.09	1.40	2.28	2.54	10.40 (4.10-13.80)	2.805 (0.800-4.100)	12.32	99
18+18+20+25+42	1.93	1.93	1.29	2.10	3.16	10.40 (4.10-13.80)	2.805 (0.800-4.100)	12.32	99
18+18+20+25+50	1.75	1.75	1.17	1.91	3.82	10.40 (4.10-13.80)	2.805 (0.800-4.100)	12.32	99
18+18+20+25+60	1.69	1.69	1.13	1.84	4.05	10.40 (4.10-13.80)	2.795 (0.800-4.090)	12.27	99
18+18+20+25+71	1.69	1.69	1.13	1.84	4.05	10.40 (4.10-13.80)	2.785 (0.800-4.080)	12.23	99
18+18+20+35+35	2.04	2.04	1.36	2.48	2.48	10.40 (4.10-13.80)	2.805 (0.800-4.100)	12.32	99
18+18+20+35+42	1.89	1.89	1.26	2.29	3.09	10.40 (4.10-13.80)	2.805 (0.800-4.100)	12.32	99
18+18+20+35+50	1.72	1.72	1.14	2.08	3.74	10.40 (4.10-13.80)	2.805 (0.800-4.100)	12.32	99
18+18+20+35+60	1.66	1.66	1.11	2.01	3.97	10.40 (4.10-13.80)	2.795 (0.800-4.090)	12.27	99
18+18+20+35+71	1.66	1.66	1.11	2.01	3.97	10.40 (4.10-13.80)	2.785 (0.800-4.080)	12.23	99
18+18+20+42+42	1.75	1.75	1.17	2.87	2.87	10.40 (4.10-13.80)	2.805 (0.800-4.100)	12.32	99
18+18+20+42+50	1.60	1.60	1.07	2.62	3.50	10.40 (4.10-13.80)	2.805 (0.800-4.100)	12.32	99
18+18+20+42+60	1.55	1.55	1.04	2.54	3.72	10.40 (4.10-13.80)	2.795 (0.800-4.090)	12.27	99
18+18+20+42+71	1.55	1.55	1.04	2.54	3.72	10.40 (4.10-13.80)	2.785 (0.800-4.080)	12.23	99
18+18+20+50+50	1.48	1.48	0.99	3.23	3.23	10.40 (4.10-13.80)	2.805 (0.800-4.100)	12.32	99
18+18+20+50+60	1.44	1.44	0.96	3.13	3.44	10.40 (4.10-13.80)	2.795 (0.800-4.090)	12.27	99
18+18+22+22+22	2.10	2.10	2.10	2.10	2.10	10.50 (4.10-14.00)	2.765 (0.780-4.100)	12.14	99
18+18+22+22+25	2.06	2.06	2.06	2.06	2.25	10.50 (4.10-14.00)	2.765 (0.780-4.100)	12.14	99
18+18+22+22+35	2.01	2.01	2.01	2.01	2.44	10.50 (4.10-14.00)	2.765 (0.780-4.100)	12.14	99
18+18+22+22+42	1.86	1.86	1.86	1.86	3.05	10.50 (4.10-14.00)	2.765 (0.780-4.100)	12.14	99
18+18+22+22+50	1.70	1.70	1.70	1.70	3.71	10.50 (4.10-14.00)	2.765 (0.780-4.100)	12.14	99
18+18+22+22+60	1.64	1.64	1.64	1.64	3.93	10.50 (4.10-14.00)	2.755 (0.780-4.090)	12.10	99

MXZ-5D102VA HEATING

Indoor units combination	Heating capacity (kW)						Outdoor unit power consumption(kW)	Current (A)	Power factor(%)
	Unit A	Unit B	Unit C	Unit D	Unit E	Total			
18+18+22+22+71	1.64	1.64	1.64	1.64	3.93	10.50 (4.10-14.00)	2.745 (0.780-4.080)	12.06	99
18+18+22+25+25	2.03	2.03	2.03	2.21	2.21	10.50 (4.10-14.00)	2.765 (0.780-4.100)	12.14	99
18+18+22+25+35	1.98	1.98	1.98	2.16	2.40	10.50 (4.10-14.00)	2.765 (0.780-4.100)	12.14	99
18+18+22+25+42	1.83	1.83	1.83	2.00	3.00	10.50 (4.10-14.00)	2.765 (0.780-4.100)	12.14	99
18+18+22+25+50	1.67	1.67	1.67	1.83	3.65	10.50 (4.10-14.00)	2.765 (0.780-4.100)	12.14	99
18+18+22+25+60	1.62	1.62	1.62	1.77	3.88	10.50 (4.10-14.00)	2.755 (0.780-4.090)	12.10	99
18+18+22+25+71	1.62	1.62	1.62	1.77	3.88	10.50 (4.10-14.00)	2.745 (0.780-4.080)	12.06	99
18+18+22+35+35	1.94	1.94	1.94	2.35	2.35	10.50 (4.10-14.00)	2.765 (0.780-4.100)	12.14	99
18+18+22+35+42	1.80	1.80	1.80	2.18	2.94	10.50 (4.10-14.00)	2.765 (0.780-4.100)	12.14	99
18+18+22+35+50	1.64	1.64	1.64	1.99	3.58	10.50 (4.10-14.00)	2.765 (0.780-4.100)	12.14	99
18+18+22+35+60	1.59	1.59	1.59	1.93	3.81	10.50 (4.10-14.00)	2.755 (0.780-4.090)	12.10	99
18+18+22+35+71	1.59	1.59	1.59	1.93	3.81	10.50 (4.10-14.00)	2.745 (0.780-4.080)	12.06	99
18+18+22+42+42	1.67	1.67	1.67	2.74	2.74	10.50 (4.10-14.00)	2.765 (0.780-4.100)	12.14	99
18+18+22+42+50	1.54	1.54	1.54	2.52	3.36	10.50 (4.10-14.00)	2.765 (0.780-4.100)	12.14	99
18+18+22+42+60	1.49	1.49	1.49	2.44	3.58	10.50 (4.10-14.00)	2.755 (0.780-4.090)	12.10	99
18+18+22+42+71	1.49	1.49	1.49	2.44	3.58	10.50 (4.10-14.00)	2.745 (0.780-4.080)	12.06	99
18+18+22+50+50	1.43	1.43	1.43	3.11	3.11	10.50 (4.10-14.00)	2.765 (0.780-4.100)	12.14	99
18+18+22+50+60	1.39	1.39	1.39	3.02	3.32	10.50 (4.10-14.00)	2.755 (0.780-4.090)	12.10	99
18+18+25+25+25	1.99	1.99	2.17	2.17	2.17	10.50 (4.10-14.00)	2.765 (0.780-4.100)	12.14	99
18+18+25+25+35	1.95	1.95	2.12	2.12	2.36	10.50 (4.10-14.00)	2.765 (0.780-4.100)	12.14	99
18+18+25+25+42	1.80	1.80	1.97	1.97	2.95	10.50 (4.10-14.00)	2.765 (0.780-4.100)	12.14	99
18+18+25+25+50	1.65	1.65	1.80	1.80	3.60	10.50 (4.10-14.00)	2.765 (0.780-4.100)	12.14	99
18+18+25+25+60	1.60	1.60	1.74	1.74	3.82	10.50 (4.10-14.00)	2.755 (0.780-4.090)	12.10	99
18+18+25+25+71	1.60	1.60	1.74	1.74	3.82	10.50 (4.10-14.00)	2.745 (0.780-4.080)	12.06	99
18+18+25+35+35	1.90	1.90	2.08	2.31	2.31	10.50 (4.10-14.00)	2.765 (0.780-4.100)	12.14	99
18+18+25+35+42	1.77	1.77	1.93	2.14	2.89	10.50 (4.10-14.00)	2.765 (0.780-4.100)	12.14	99
18+18+25+35+50	1.62	1.62	1.77	1.96	3.53	10.50 (4.10-14.00)	2.765 (0.780-4.100)	12.14	99
18+18+25+35+60	1.57	1.57	1.71	1.90	3.75	10.50 (4.10-14.00)	2.755 (0.780-4.090)	12.10	99
18+18+25+35+71	1.57	1.57	1.71	1.90	3.75	10.50 (4.10-14.00)	2.745 (0.780-4.080)	12.06	99
18+18+25+42+42	1.65	1.65	1.80	2.70	2.70	10.50 (4.10-14.00)	2.765 (0.780-4.100)	12.14	99
18+18+25+42+50	1.52	1.52	1.66	2.49	3.32	10.50 (4.10-14.00)	2.765 (0.780-4.100)	12.14	99
18+18+25+42+60	1.47	1.47	1.61	2.41	3.53	10.50 (4.10-14.00)	2.755 (0.780-4.090)	12.10	99
18+18+25+50+50	1.41	1.41	1.54	3.07	3.07	10.50 (4.10-14.00)	2.765 (0.780-4.100)	12.14	99
18+18+25+50+60	1.37	1.37	1.49	2.99	3.28	10.50 (4.10-14.00)	2.755 (0.780-4.090)	12.10	99
18+18+35+35+35	1.86	1.86	2.26	2.26	2.26	10.50 (4.10-14.00)	2.765 (0.780-4.100)	12.14	99
18+18+35+35+42	1.73	1.73	2.10	2.10	2.84	10.50 (4.10-14.00)	2.765 (0.780-4.100)	12.14	99
18+18+35+35+50	1.59	1.59	1.93	1.93	3.47	10.50 (4.10-14.00)	2.765 (0.780-4.100)	12.14	99
18+18+35+35+60	1.54	1.54	1.87	1.87	3.69	10.50 (4.10-14.00)	2.755 (0.780-4.090)	12.10	99
18+18+35+42+42	1.62	1.62	1.96	2.65	2.65	10.50 (4.10-14.00)	2.765 (0.780-4.100)	12.14	99
18+18+35+42+50	1.49	1.49	1.81	2.44	3.26	10.50 (4.10-14.00)	2.765 (0.780-4.100)	12.14	99
18+18+35+50+50	1.39	1.39	1.68	3.02	3.02	10.50 (4.10-14.00)	2.765 (0.780-4.100)	12.14	99

MXZ-5D102VA HEATING

Indoor units combination	Heating capacity (kW)						Outdoor unit power consumption(kW)	Current (A)	Power factor(%)
	Unit A	Unit B	Unit C	Unit D	Unit E	Total			
18+18+42+42+42	1.52	1.52	2.49	2.49	2.49	10.50 (4.10-14.00)	2.765 (0.780-4.100)	12.14	99
18+18+42+42+50	1.41	1.41	2.30	2.30	3.07	10.50 (4.10-14.00)	2.765 (0.780-4.100)	12.14	99
18+20+20+20+20	2.75	1.84	1.84	1.84	1.84	10.10 (4.10-13.20)	2.925 (0.860-4.100)	12.85	99
18+20+20+20+22	2.55	1.70	1.70	1.70	2.55	10.20 (4.10-13.40)	2.885 (0.840-4.100)	12.67	99
18+20+20+20+25	2.49	1.66	1.66	1.66	2.72	10.20 (4.10-13.40)	2.885 (0.840-4.100)	12.67	99
18+20+20+20+35	2.42	1.61	1.61	1.61	2.94	10.20 (4.10-13.40)	2.885 (0.840-4.100)	12.67	99
18+20+20+20+42	2.20	1.47	1.47	1.47	3.60	10.20 (4.10-13.40)	2.885 (0.840-4.100)	12.67	99
18+20+20+20+50	1.97	1.31	1.31	1.31	4.29	10.20 (4.10-13.40)	2.885 (0.840-4.100)	12.67	99
18+20+20+20+60	1.89	1.26	1.26	1.26	4.53	10.20 (4.10-13.40)	2.875 (0.840-4.090)	12.63	99
18+20+20+20+71	1.89	1.26	1.26	1.26	4.53	10.20 (4.10-13.40)	2.865 (0.840-4.080)	12.58	99
18+20+20+22+25	2.33	1.55	1.55	2.33	2.54	10.30 (4.10-13.60)	2.845 (0.820-4.100)	12.49	99
18+20+20+22+35	2.27	1.51	1.51	2.27	2.75	10.30 (4.10-13.60)	2.845 (0.820-4.100)	12.49	99
18+20+20+22+42	2.07	1.38	1.38	2.07	3.39	10.30 (4.10-13.60)	2.845 (0.820-4.100)	12.49	99
18+20+20+22+50	1.87	1.25	1.25	1.87	4.07	10.30 (4.10-13.60)	2.845 (0.820-4.100)	12.49	99
18+20+20+22+60	1.80	1.20	1.20	1.80	4.31	10.30 (4.10-13.60)	2.835 (0.820-4.090)	12.45	99
18+20+20+22+71	1.80	1.20	1.20	1.80	4.31	10.30 (4.10-13.60)	2.825 (0.820-4.080)	12.41	99
18+20+20+25+25	2.28	1.52	1.52	2.49	2.49	10.30 (4.10-13.60)	2.845 (0.820-4.100)	12.49	99
18+20+20+25+35	2.22	1.48	1.48	2.42	2.69	10.30 (4.10-13.60)	2.845 (0.820-4.100)	12.49	99
18+20+20+25+42	2.04	1.36	1.36	2.22	3.33	10.30 (4.10-13.60)	2.845 (0.820-4.100)	12.49	99
18+20+20+25+50	1.84	1.22	1.22	2.00	4.01	10.30 (4.10-13.60)	2.845 (0.820-4.100)	12.49	99
18+20+20+25+60	1.77	1.18	1.18	1.93	4.24	10.30 (4.10-13.60)	2.835 (0.820-4.090)	12.45	99
18+20+20+25+71	1.77	1.18	1.18	1.93	4.24	10.30 (4.10-13.60)	2.825 (0.820-4.080)	12.41	99
18+20+20+35+35	2.16	1.44	1.44	2.62	2.62	10.30 (4.10-13.60)	2.845 (0.820-4.100)	12.49	99
18+20+20+35+42	1.99	1.33	1.33	2.41	3.25	10.30 (4.10-13.60)	2.845 (0.820-4.100)	12.49	99
18+20+20+35+50	1.80	1.20	1.20	2.18	3.92	10.30 (4.10-13.60)	2.845 (0.820-4.100)	12.49	99
18+20+20+35+60	1.73	1.16	1.16	2.10	4.15	10.30 (4.10-13.60)	2.835 (0.820-4.090)	12.45	99
18+20+20+35+71	1.73	1.16	1.16	2.10	4.15	10.30 (4.10-13.60)	2.825 (0.820-4.080)	12.41	99
18+20+20+42+42	1.84	1.22	1.22	3.01	3.01	10.30 (4.10-13.60)	2.845 (0.820-4.100)	12.49	99
18+20+20+42+50	1.67	1.12	1.12	2.74	3.65	10.30 (4.10-13.60)	2.845 (0.820-4.100)	12.49	99
18+20+20+42+60	1.62	1.08	1.08	2.65	3.87	10.30 (4.10-13.60)	2.835 (0.820-4.090)	12.45	99
18+20+20+42+71	1.62	1.08	1.08	2.65	3.87	10.30 (4.10-13.60)	2.825 (0.820-4.080)	12.41	99
18+20+20+50+50	1.54	1.03	1.03	3.36	3.36	10.30 (4.10-13.60)	2.845 (0.820-4.100)	12.49	99
18+20+20+50+60	1.49	0.99	0.99	3.25	3.57	10.30 (4.10-13.60)	2.835 (0.820-4.090)	12.45	99
18+20+22+22+22	2.23	1.49	2.23	2.23	2.23	10.40 (4.10-13.80)	2.805 (0.800-4.100)	12.32	99
18+20+22+22+25	2.19	1.46	2.19	2.19	2.38	10.40 (4.10-13.80)	2.805 (0.800-4.100)	12.32	99
18+20+22+22+35	2.13	1.42	2.13	2.13	2.58	10.40 (4.10-13.80)	2.805 (0.800-4.100)	12.32	99
18+20+22+22+42	1.96	1.31	1.96	1.96	3.21	10.40 (4.10-13.80)	2.805 (0.800-4.100)	12.32	99
18+20+22+22+50	1.78	1.19	1.78	1.78	3.88	10.40 (4.10-13.80)	2.805 (0.800-4.100)	12.32	99
18+20+22+22+60	1.72	1.14	1.72	1.72	4.11	10.40 (4.10-13.80)	2.795 (0.800-4.090)	12.27	99
18+20+22+22+71	1.72	1.14	1.72	1.72	4.11	10.40 (4.10-13.80)	2.785 (0.800-4.080)	12.23	99
18+20+22+25+25	2.15	1.43	2.15	2.34	2.34	10.40 (4.10-13.80)	2.805 (0.800-4.100)	12.32	99

MXZ-5D102VA HEATING

Indoor units combination	Heating capacity (kW)						Outdoor unit power consumption(kW)	Current (A)	Power factor(%)
	Unit A	Unit B	Unit C	Unit D	Unit E	Total			
18+20+22+25+35	2.09	1.40	2.09	2.28	2.54	10.40 (4.10-13.80)	2.805 (0.800-4.100)	12.32	99
18+20+22+25+42	1.93	1.29	1.93	2.10	3.16	10.40 (4.10-13.80)	2.805 (0.800-4.100)	12.32	99
18+20+22+25+50	1.75	1.17	1.75	1.91	3.82	10.40 (4.10-13.80)	2.805 (0.800-4.100)	12.32	99
18+20+22+25+60	1.69	1.13	1.69	1.84	4.05	10.40 (4.10-13.80)	2.795 (0.800-4.090)	12.27	99
18+20+22+25+71	1.69	1.13	1.69	1.84	4.05	10.40 (4.10-13.80)	2.785 (0.800-4.080)	12.23	99
18+20+22+35+35	2.04	1.36	2.04	2.48	2.48	10.40 (4.10-13.80)	2.805 (0.800-4.100)	12.32	99
18+20+22+35+42	1.89	1.26	1.89	2.29	3.09	10.40 (4.10-13.80)	2.805 (0.800-4.100)	12.32	99
18+20+22+35+50	1.72	1.14	1.72	2.08	3.74	10.40 (4.10-13.80)	2.805 (0.800-4.100)	12.32	99
18+20+22+35+60	1.66	1.11	1.66	2.01	3.97	10.40 (4.10-13.80)	2.795 (0.800-4.090)	12.27	99
18+20+22+35+71	1.66	1.11	1.66	2.01	3.97	10.40 (4.10-13.80)	2.785 (0.800-4.080)	12.23	99
18+20+22+42+42	1.75	1.17	1.75	2.87	2.87	10.40 (4.10-13.80)	2.805 (0.800-4.100)	12.32	99
18+20+22+42+50	1.60	1.07	1.60	2.62	3.50	10.40 (4.10-13.80)	2.805 (0.800-4.100)	12.32	99
18+20+22+42+60	1.55	1.04	1.55	2.54	3.72	10.40 (4.10-13.80)	2.795 (0.800-4.090)	12.27	99
18+20+22+50+50	1.48	0.99	1.48	3.23	3.23	10.40 (4.10-13.80)	2.805 (0.800-4.100)	12.32	99
18+20+22+50+60	1.44	0.96	1.44	3.13	3.44	10.40 (4.10-13.80)	2.795 (0.800-4.090)	12.27	99
18+20+25+25+25	2.11	1.40	2.30	2.30	2.30	10.40 (4.10-13.80)	2.805 (0.800-4.100)	12.32	99
18+20+25+25+35	2.06	1.37	2.24	2.24	2.49	10.40 (4.10-13.80)	2.805 (0.800-4.100)	12.32	99
18+20+25+25+42	1.90	1.26	2.07	2.07	3.10	10.40 (4.10-13.80)	2.805 (0.800-4.100)	12.32	99
18+20+25+25+50	1.72	1.15	1.88	1.88	3.76	10.40 (4.10-13.80)	2.805 (0.800-4.100)	12.32	99
18+20+25+25+60	1.67	1.11	1.82	1.82	3.99	10.40 (4.10-13.80)	2.795 (0.800-4.090)	12.27	99
18+20+25+25+71	1.67	1.11	1.82	1.82	3.99	10.40 (4.10-13.80)	2.785 (0.800-4.080)	12.23	99
18+20+25+35+35	2.01	1.34	2.19	2.43	2.43	10.40 (4.10-13.80)	2.805 (0.800-4.100)	12.32	99
18+20+25+35+42	1.86	1.24	2.02	2.25	3.04	10.40 (4.10-13.80)	2.805 (0.800-4.100)	12.32	99
18+20+25+35+50	1.69	1.13	1.84	2.05	3.69	10.40 (4.10-13.80)	2.805 (0.800-4.100)	12.32	99
18+20+25+35+60	1.63	1.09	1.78	1.98	3.91	10.40 (4.10-13.80)	2.795 (0.800-4.090)	12.27	99
18+20+25+35+71	1.63	1.09	1.78	1.98	3.91	10.40 (4.10-13.80)	2.785 (0.800-4.080)	12.23	99
18+20+25+42+42	1.72	1.15	1.88	2.82	2.82	10.40 (4.10-13.80)	2.805 (0.800-4.100)	12.32	99
18+20+25+42+50	1.58	1.05	1.73	2.59	3.45	10.40 (4.10-13.80)	2.805 (0.800-4.100)	12.32	99
18+20+25+42+60	1.53	1.02	1.67	2.51	3.67	10.40 (4.10-13.80)	2.795 (0.800-4.090)	12.27	99
18+20+25+50+50	1.46	0.97	1.59	3.19	3.19	10.40 (4.10-13.80)	2.805 (0.800-4.100)	12.32	99
18+20+35+35+35	1.96	1.31	2.38	2.38	2.38	10.40 (4.10-13.80)	2.805 (0.800-4.100)	12.32	99
18+20+35+35+42	1.82	1.21	2.20	2.20	2.97	10.40 (4.10-13.80)	2.805 (0.800-4.100)	12.32	99
18+20+35+35+50	1.66	1.11	2.01	2.01	3.62	10.40 (4.10-13.80)	2.805 (0.800-4.100)	12.32	99
18+20+35+35+60	1.60	1.07	1.94	1.94	3.84	10.40 (4.10-13.80)	2.795 (0.800-4.090)	12.27	99
18+20+35+42+42	1.69	1.13	2.05	2.77	2.77	10.40 (4.10-13.80)	2.805 (0.800-4.100)	12.32	99
18+20+35+42+50	1.55	1.04	1.88	2.54	3.39	10.40 (4.10-13.80)	2.805 (0.800-4.100)	12.32	99
18+20+42+42+42	1.58	1.05	2.59	2.59	2.59	10.40 (4.10-13.80)	2.805 (0.800-4.100)	12.32	99
18+20+42+42+50	1.46	0.97	2.39	2.39	3.19	10.40 (4.10-13.80)	2.805 (0.800-4.100)	12.32	99
18+22+22+22+22	2.10	2.10	2.10	2.10	2.10	10.50 (4.10-14.00)	2.765 (0.780-4.100)	12.14	99
18+22+22+22+25	2.06	2.06	2.06	2.06	2.25	10.50 (4.10-14.00)	2.765 (0.780-4.100)	12.14	99
18+22+22+22+35	2.01	2.01	2.01	2.01	2.44	10.50 (4.10-14.00)	2.765 (0.780-4.100)	12.14	99

MXZ-5D102VA HEATING

Indoor units combination	Heating capacity (kW)						Outdoor unit power consumption(kW)	Current (A)	Power factor(%)
	Unit A	Unit B	Unit C	Unit D	Unit E	Total			
18+22+22+22+42	1.86	1.86	1.86	1.86	3.05	10.50 (4.10-14.00)	2.765 (0.780-4.100)	12.14	99
18+22+22+22+50	1.70	1.70	1.70	1.70	3.71	10.50 (4.10-14.00)	2.765 (0.780-4.100)	12.14	99
18+22+22+22+60	1.64	1.64	1.64	1.64	3.93	10.50 (4.10-14.00)	2.755 (0.780-4.090)	12.10	99
18+22+22+22+71	1.64	1.64	1.64	1.64	3.93	10.50 (4.10-14.00)	2.745 (0.780-4.080)	12.06	99
18+22+22+25+25	2.03	2.03	2.03	2.21	2.21	10.50 (4.10-14.00)	2.765 (0.780-4.100)	12.14	99
18+22+22+25+35	1.98	1.98	1.98	2.16	2.40	10.50 (4.10-14.00)	2.765 (0.780-4.100)	12.14	99
18+22+22+25+42	1.83	1.83	1.83	2.00	3.00	10.50 (4.10-14.00)	2.765 (0.780-4.100)	12.14	99
18+22+22+25+50	1.67	1.67	1.67	1.83	3.65	10.50 (4.10-14.00)	2.765 (0.780-4.100)	12.14	99
18+22+22+25+60	1.62	1.62	1.62	1.77	3.88	10.50 (4.10-14.00)	2.755 (0.780-4.090)	12.10	99
18+22+22+25+71	1.62	1.62	1.62	1.77	3.88	10.50 (4.10-14.00)	2.745 (0.780-4.080)	12.06	99
18+22+22+35+35	1.94	1.94	1.94	2.35	2.35	10.50 (4.10-14.00)	2.765 (0.780-4.100)	12.14	99
18+22+22+35+42	1.80	1.80	1.80	2.18	2.94	10.50 (4.10-14.00)	2.765 (0.780-4.100)	12.14	99
18+22+22+35+50	1.64	1.64	1.64	1.99	3.58	10.50 (4.10-14.00)	2.765 (0.780-4.100)	12.14	99
18+22+22+35+60	1.59	1.59	1.59	1.93	3.81	10.50 (4.10-14.00)	2.755 (0.780-4.090)	12.10	99
18+22+22+35+71	1.59	1.59	1.59	1.93	3.81	10.50 (4.10-14.00)	2.745 (0.780-4.080)	12.06	99
18+22+22+42+42	1.67	1.67	1.67	2.74	2.74	10.50 (4.10-14.00)	2.765 (0.780-4.100)	12.14	99
18+22+22+42+50	1.54	1.54	1.54	2.52	3.36	10.50 (4.10-14.00)	2.765 (0.780-4.100)	12.14	99
18+22+22+42+60	1.49	1.49	1.49	2.44	3.58	10.50 (4.10-14.00)	2.755 (0.780-4.090)	12.10	99
18+22+22+50+50	1.43	1.43	1.43	3.11	3.11	10.50 (4.10-14.00)	2.765 (0.780-4.100)	12.14	99
18+22+22+50+60	1.39	1.39	1.39	3.02	3.32	10.50 (4.10-14.00)	2.755 (0.780-4.090)	12.10	99
18+22+25+25+25	1.99	1.99	2.17	2.17	2.17	10.50 (4.10-14.00)	2.765 (0.780-4.100)	12.14	99
18+22+25+25+35	1.95	1.95	2.12	2.12	2.36	10.50 (4.10-14.00)	2.765 (0.780-4.100)	12.14	99
18+22+25+25+42	1.80	1.80	1.97	1.97	2.95	10.50 (4.10-14.00)	2.765 (0.780-4.100)	12.14	99
18+22+25+25+50	1.65	1.65	1.80	1.80	3.60	10.50 (4.10-14.00)	2.765 (0.780-4.100)	12.14	99
18+22+25+25+60	1.60	1.60	1.74	1.74	3.82	10.50 (4.10-14.00)	2.755 (0.780-4.090)	12.10	99
18+22+25+25+71	1.60	1.60	1.74	1.74	3.82	10.50 (4.10-14.00)	2.745 (0.780-4.080)	12.06	99
18+22+25+35+35	1.90	1.90	2.08	2.31	2.31	10.50 (4.10-14.00)	2.765 (0.780-4.100)	12.14	99
18+22+25+35+42	1.77	1.77	1.93	2.14	2.89	10.50 (4.10-14.00)	2.765 (0.780-4.100)	12.14	99
18+22+25+35+50	1.62	1.62	1.77	1.96	3.53	10.50 (4.10-14.00)	2.765 (0.780-4.100)	12.14	99
18+22+25+35+60	1.57	1.57	1.71	1.90	3.75	10.50 (4.10-14.00)	2.755 (0.780-4.090)	12.10	99
18+22+25+35+71	1.57	1.57	1.71	1.90	3.75	10.50 (4.10-14.00)	2.745 (0.780-4.080)	12.06	99
18+22+25+42+42	1.65	1.65	1.80	2.70	2.70	10.50 (4.10-14.00)	2.765 (0.780-4.100)	12.14	99
18+22+25+42+50	1.52	1.52	1.66	2.49	3.32	10.50 (4.10-14.00)	2.765 (0.780-4.100)	12.14	99
18+22+25+42+60	1.47	1.47	1.61	2.41	3.53	10.50 (4.10-14.00)	2.755 (0.780-4.090)	12.10	99
18+22+25+50+50	1.41	1.41	1.54	3.07	3.07	10.50 (4.10-14.00)	2.765 (0.780-4.100)	12.14	99
18+22+35+35+35	1.86	1.86	2.26	2.26	2.26	10.50 (4.10-14.00)	2.765 (0.780-4.100)	12.14	99
18+22+35+35+42	1.73	1.73	2.10	2.10	2.84	10.50 (4.10-14.00)	2.765 (0.780-4.100)	12.14	99
18+22+35+35+50	1.59	1.59	1.93	1.93	3.47	10.50 (4.10-14.00)	2.765 (0.780-4.100)	12.14	99
18+22+35+35+60	1.54	1.54	1.87	1.87	3.69	10.50 (4.10-14.00)	2.755 (0.780-4.090)	12.10	99
18+22+35+42+42	1.62	1.62	1.96	2.65	2.65	10.50 (4.10-14.00)	2.765 (0.780-4.100)	12.14	99
18+22+35+42+50	1.49	1.49	1.81	2.44	3.26	10.50 (4.10-14.00)	2.765 (0.780-4.100)	12.14	99

MXZ-5D102VA HEATING

Indoor units combination	Heating capacity (kW)						Outdoor unit power consumption(kW)	Current (A)	Power factor(%)
	Unit A	Unit B	Unit C	Unit D	Unit E	Total			
18+22+42+42+42	1.52	1.52	2.49	2.49	2.49	10.50 (4.10-14.00)	2.765 (0.780-4.100)	12.14	99
18+25+25+25+25	1.96	2.14	2.14	2.14	2.14	10.50 (4.10-14.00)	2.765 (0.780-4.100)	12.14	99
18+25+25+25+35	1.91	2.09	2.09	2.09	2.32	10.50 (4.10-14.00)	2.765 (0.780-4.100)	12.14	99
18+25+25+25+42	1.78	1.94	1.94	1.94	2.91	10.50 (4.10-14.00)	2.765 (0.780-4.100)	12.14	99
18+25+25+25+50	1.63	1.77	1.77	1.77	3.55	10.50 (4.10-14.00)	2.765 (0.780-4.100)	12.14	99
18+25+25+25+60	1.58	1.72	1.72	1.72	3.77	10.50 (4.10-14.00)	2.755 (0.780-4.090)	12.10	99
18+25+25+25+71	1.58	1.72	1.72	1.72	3.77	10.50 (4.10-14.00)	2.745 (0.780-4.080)	12.06	99
18+25+25+35+35	1.87	2.04	2.04	2.27	2.27	10.50 (4.10-14.00)	2.765 (0.780-4.100)	12.14	99
18+25+25+35+42	1.74	1.90	1.90	2.11	2.85	10.50 (4.10-14.00)	2.765 (0.780-4.100)	12.14	99
18+25+25+35+50	1.60	1.74	1.74	1.94	3.48	10.50 (4.10-14.00)	2.765 (0.780-4.100)	12.14	99
18+25+25+35+60	1.55	1.69	1.69	1.88	3.70	10.50 (4.10-14.00)	2.755 (0.780-4.090)	12.10	99
18+25+25+42+42	1.63	1.77	1.77	2.66	2.66	10.50 (4.10-14.00)	2.765 (0.780-4.100)	12.14	99
18+25+25+42+50	1.50	1.64	1.64	2.45	3.27	10.50 (4.10-14.00)	2.765 (0.780-4.100)	12.14	99
18+25+25+42+60	1.46	1.59	1.59	2.38	3.49	10.50 (4.10-14.00)	2.755 (0.780-4.090)	12.10	99
18+25+25+50+50	1.39	1.52	1.52	3.04	3.04	10.50 (4.10-14.00)	2.765 (0.780-4.100)	12.14	99
18+25+35+35+35	1.83	2.00	2.22	2.22	2.22	10.50 (4.10-14.00)	2.765 (0.780-4.100)	12.14	99
18+25+35+35+42	1.71	1.86	2.07	2.07	2.79	10.50 (4.10-14.00)	2.765 (0.780-4.100)	12.14	99
18+25+35+35+50	1.57	1.71	1.90	1.90	3.42	10.50 (4.10-14.00)	2.765 (0.780-4.100)	12.14	99
18+25+35+42+42	1.60	1.74	1.94	2.61	2.61	10.50 (4.10-14.00)	2.765 (0.780-4.100)	12.14	99
18+25+35+42+50	1.47	1.61	1.79	2.41	3.22	10.50 (4.10-14.00)	2.765 (0.780-4.100)	12.14	99
18+25+42+42+42	1.50	1.64	2.45	2.45	2.45	10.50 (4.10-14.00)	2.765 (0.780-4.100)	12.14	99
18+35+35+35+35	1.80	2.18	2.18	2.18	2.18	10.50 (4.10-14.00)	2.765 (0.780-4.100)	12.14	99
18+35+35+35+42	1.67	2.03	2.03	2.03	2.74	10.50 (4.10-14.00)	2.765 (0.780-4.100)	12.14	99
18+35+35+42+42	1.57	1.90	1.90	2.57	2.57	10.50 (4.10-14.00)	2.765 (0.780-4.100)	12.14	99
20+20+20+20+20	2.00	2.00	2.00	2.00	2.00	10.00 (4.10-13.00)	2.965 (0.880-4.100)	13.02	99
20+20+20+20+25	1.79	1.79	1.79	1.79	2.93	10.10 (4.10-13.20)	2.925 (0.860-4.100)	12.85	99
20+20+20+20+35	1.74	1.74	1.74	1.74	3.16	10.10 (4.10-13.20)	2.925 (0.860-4.100)	12.85	99
20+20+20+20+42	1.56	1.56	1.56	1.56	3.84	10.10 (4.10-13.20)	2.925 (0.860-4.100)	12.85	99
20+20+20+20+50	1.39	1.39	1.39	1.39	4.55	10.10 (4.10-13.20)	2.925 (0.860-4.100)	12.85	99
20+20+20+20+60	1.33	1.33	1.33	1.33	4.78	10.10 (4.10-13.20)	2.915 (0.860-4.090)	12.80	99
20+20+20+20+71	1.33	1.33	1.33	1.33	4.78	10.10 (4.10-13.20)	2.905 (0.860-4.080)	12.76	99
20+20+20+22+22	1.70	1.70	1.70	2.55	2.55	10.20 (4.10-13.40)	2.885 (0.840-4.100)	12.67	99
20+20+20+22+25	1.66	1.66	1.66	2.49	2.72	10.20 (4.10-13.40)	2.885 (0.840-4.100)	12.67	99
20+20+20+22+35	1.61	1.61	1.61	2.42	2.94	10.20 (4.10-13.40)	2.885 (0.840-4.100)	12.67	99
20+20+20+22+42	1.47	1.47	1.47	2.20	3.60	10.20 (4.10-13.40)	2.885 (0.840-4.100)	12.67	99
20+20+20+22+50	1.31	1.31	1.31	1.97	4.29	10.20 (4.10-13.40)	2.885 (0.840-4.100)	12.67	99
20+20+20+22+60	1.26	1.26	1.26	1.89	4.53	10.20 (4.10-13.40)	2.875 (0.840-4.090)	12.63	99
20+20+20+22+71	1.26	1.26	1.26	1.89	4.53	10.20 (4.10-13.40)	2.865 (0.840-4.080)	12.58	99
20+20+20+25+25	1.63	1.63	1.63	2.66	2.66	10.20 (4.10-13.40)	2.885 (0.840-4.100)	12.67	99
20+20+20+25+35	1.58	1.58	1.58	2.59	2.87	10.20 (4.10-13.40)	2.885 (0.840-4.100)	12.67	99
20+20+20+25+42	1.44	1.44	1.44	2.35	3.53	10.20 (4.10-13.40)	2.885 (0.840-4.100)	12.67	99

MXZ-5D102VA HEATING

Indoor units combination	Heating capacity (kW)						Outdoor unit power consumption(kW)	Current (A)	Power factor(%)
	Unit A	Unit B	Unit C	Unit D	Unit E	Total			
20+20+20+25+50	1.29	1.29	1.29	2.11	4.22	10.20 (4.10-13.40)	2.885 (0.840-4.100)	12.67	99
20+20+20+25+60	1.24	1.24	1.24	2.03	4.45	10.20 (4.10-13.40)	2.875 (0.840-4.090)	12.63	99
20+20+20+25+71	1.24	1.24	1.24	2.03	4.45	10.20 (4.10-13.40)	2.865 (0.840-4.080)	12.58	99
20+20+20+35+35	1.54	1.54	1.54	2.79	2.79	10.20 (4.10-13.40)	2.885 (0.840-4.100)	12.67	99
20+20+20+35+42	1.40	1.40	1.40	2.55	3.44	10.20 (4.10-13.40)	2.885 (0.840-4.100)	12.67	99
20+20+20+35+50	1.26	1.26	1.26	2.29	4.13	10.20 (4.10-13.40)	2.885 (0.840-4.100)	12.67	99
20+20+20+35+60	1.21	1.21	1.21	2.21	4.36	10.20 (4.10-13.40)	2.875 (0.840-4.090)	12.63	99
20+20+20+35+71	1.21	1.21	1.21	2.21	4.36	10.20 (4.10-13.40)	2.865 (0.840-4.080)	12.58	99
20+20+20+42+42	1.29	1.29	1.29	3.17	3.17	10.20 (4.10-13.40)	2.885 (0.840-4.100)	12.67	99
20+20+20+42+50	1.17	1.17	1.17	2.87	3.83	10.20 (4.10-13.40)	2.885 (0.840-4.100)	12.67	99
20+20+20+42+60	1.13	1.13	1.13	2.77	4.05	10.20 (4.10-13.40)	2.875 (0.840-4.090)	12.63	99
20+20+20+50+50	1.07	1.07	1.07	3.50	3.50	10.20 (4.10-13.40)	2.885 (0.840-4.100)	12.67	99
20+20+20+50+60	1.03	1.03	1.03	3.38	3.71	10.20 (4.10-13.40)	2.875 (0.840-4.090)	12.63	99
20+20+22+22+22	1.58	1.58	2.38	2.38	2.38	10.30 (4.10-13.60)	2.845 (0.820-4.100)	12.49	99
20+20+22+22+25	1.55	1.55	2.33	2.33	2.54	10.30 (4.10-13.60)	2.845 (0.820-4.100)	12.49	99
20+20+22+22+35	1.51	1.51	2.27	2.27	2.75	10.30 (4.10-13.60)	2.845 (0.820-4.100)	12.49	99
20+20+22+22+42	1.38	1.38	2.07	2.07	3.39	10.30 (4.10-13.60)	2.845 (0.820-4.100)	12.49	99
20+20+22+22+50	1.25	1.25	1.87	1.87	4.07	10.30 (4.10-13.60)	2.845 (0.820-4.100)	12.49	99
20+20+22+22+60	1.20	1.20	1.80	1.80	4.31	10.30 (4.10-13.60)	2.835 (0.820-4.090)	12.45	99
20+20+22+22+71	1.20	1.20	1.80	1.80	4.31	10.30 (4.10-13.60)	2.825 (0.820-4.080)	12.41	99
20+20+22+25+25	1.52	1.52	2.28	2.49	2.49	10.30 (4.10-13.60)	2.845 (0.820-4.100)	12.49	99
20+20+22+25+35	1.48	1.48	2.22	2.42	2.69	10.30 (4.10-13.60)	2.845 (0.820-4.100)	12.49	99
20+20+22+25+42	1.36	1.36	2.04	2.22	3.33	10.30 (4.10-13.60)	2.845 (0.820-4.100)	12.49	99
20+20+22+25+50	1.22	1.22	1.84	2.00	4.01	10.30 (4.10-13.60)	2.845 (0.820-4.100)	12.49	99
20+20+22+25+60	1.18	1.18	1.77	1.93	4.24	10.30 (4.10-13.60)	2.835 (0.820-4.090)	12.45	99
20+20+22+25+71	1.18	1.18	1.77	1.93	4.24	10.30 (4.10-13.60)	2.825 (0.820-4.080)	12.41	99
20+20+22+35+35	1.44	1.44	2.16	2.62	2.62	10.30 (4.10-13.60)	2.845 (0.820-4.100)	12.49	99
20+20+22+35+42	1.33	1.33	1.99	2.41	3.25	10.30 (4.10-13.60)	2.845 (0.820-4.100)	12.49	99
20+20+22+35+50	1.20	1.20	1.80	2.18	3.92	10.30 (4.10-13.60)	2.845 (0.820-4.100)	12.49	99
20+20+22+35+60	1.16	1.16	1.73	2.10	4.15	10.30 (4.10-13.60)	2.835 (0.820-4.090)	12.45	99
20+20+22+35+71	1.16	1.16	1.73	2.10	4.15	10.30 (4.10-13.60)	2.825 (0.820-4.080)	12.41	99
20+20+22+42+42	1.22	1.22	1.84	3.01	3.01	10.30 (4.10-13.60)	2.845 (0.820-4.100)	12.49	99
20+20+22+42+50	1.12	1.12	1.67	2.74	3.65	10.30 (4.10-13.60)	2.845 (0.820-4.100)	12.49	99
20+20+22+42+60	1.08	1.08	1.62	2.65	3.87	10.30 (4.10-13.60)	2.835 (0.820-4.090)	12.45	99
20+20+22+50+50	1.03	1.03	1.54	3.36	3.36	10.30 (4.10-13.60)	2.845 (0.820-4.100)	12.49	99
20+20+22+50+60	0.99	0.99	1.49	3.25	3.57	10.30 (4.10-13.60)	2.835 (0.820-4.090)	12.45	99
20+20+25+25+25	1.49	1.49	2.44	2.44	2.44	10.30 (4.10-13.60)	2.845 (0.820-4.100)	12.49	99
20+20+25+25+35	1.45	1.45	2.38	2.38	2.64	10.30 (4.10-13.60)	2.845 (0.820-4.100)	12.49	99
20+20+25+25+42	1.33	1.33	2.18	2.18	3.27	10.30 (4.10-13.60)	2.845 (0.820-4.100)	12.49	99
20+20+25+25+50	1.21	1.21	1.97	1.97	3.94	10.30 (4.10-13.60)	2.845 (0.820-4.100)	12.49	99
20+20+25+25+60	1.16	1.16	1.90	1.90	4.17	10.30 (4.10-13.60)	2.835 (0.820-4.090)	12.45	99

MXZ-5D102VA HEATING

Indoor units combination	Heating capacity (kW)						Outdoor unit power consumption(kW)	Current (A)	Power factor(%)
	Unit A	Unit B	Unit C	Unit D	Unit E	Total			
20+20+25+25+71	1.16	1.16	1.90	1.90	4.17	10.30 (4.10-13.60)	2.825 (0.820-4.080)	12.41	99
20+20+25+35+35	1.42	1.42	2.32	2.58	2.58	10.30 (4.10-13.60)	2.845 (0.820-4.100)	12.49	99
20+20+25+35+42	1.30	1.30	2.13	2.37	3.20	10.30 (4.10-13.60)	2.845 (0.820-4.100)	12.49	99
20+20+25+35+50	1.18	1.18	1.93	2.15	3.86	10.30 (4.10-13.60)	2.845 (0.820-4.100)	12.49	99
20+20+25+35+60	1.14	1.14	1.86	2.07	4.09	10.30 (4.10-13.60)	2.835 (0.820-4.090)	12.45	99
20+20+25+35+71	1.14	1.14	1.86	2.07	4.09	10.30 (4.10-13.60)	2.825 (0.820-4.080)	12.41	99
20+20+25+42+42	1.21	1.21	1.97	2.96	2.96	10.30 (4.10-13.60)	2.845 (0.820-4.100)	12.49	99
20+20+25+42+50	1.10	1.10	1.80	2.70	3.60	10.30 (4.10-13.60)	2.845 (0.820-4.100)	12.49	99
20+20+25+42+60	1.06	1.06	1.74	2.61	3.82	10.30 (4.10-13.60)	2.835 (0.820-4.090)	12.45	99
20+20+25+50+50	1.01	1.01	1.66	3.31	3.31	10.30 (4.10-13.60)	2.845 (0.820-4.100)	12.49	99
20+20+35+35+35	1.38	1.38	2.51	2.51	2.51	10.30 (4.10-13.60)	2.845 (0.820-4.100)	12.49	99
20+20+35+35+42	1.27	1.27	2.31	2.31	3.12	10.30 (4.10-13.60)	2.845 (0.820-4.100)	12.49	99
20+20+35+35+50	1.16	1.16	2.10	2.10	3.78	10.30 (4.10-13.60)	2.845 (0.820-4.100)	12.49	99
20+20+35+35+60	1.12	1.12	2.03	2.03	4.01	10.30 (4.10-13.60)	2.835 (0.820-4.090)	12.45	99
20+20+35+42+42	1.18	1.18	2.15	2.90	2.90	10.30 (4.10-13.60)	2.845 (0.820-4.100)	12.49	99
20+20+35+42+50	1.08	1.08	1.96	2.65	3.53	10.30 (4.10-13.60)	2.845 (0.820-4.100)	12.49	99
20+20+42+42+42	1.10	1.10	2.70	2.70	2.70	10.30 (4.10-13.60)	2.845 (0.820-4.100)	12.49	99
20+22+22+22+22	1.49	2.23	2.23	2.23	2.23	10.40 (4.10-13.80)	2.805 (0.800-4.100)	12.32	99
20+22+22+22+25	1.46	2.19	2.19	2.19	2.38	10.40 (4.10-13.80)	2.805 (0.800-4.100)	12.32	99
20+22+22+22+35	1.42	2.13	2.13	2.13	2.58	10.40 (4.10-13.80)	2.805 (0.800-4.100)	12.32	99
20+22+22+22+42	1.31	1.96	1.96	1.96	3.21	10.40 (4.10-13.80)	2.805 (0.800-4.100)	12.32	99
20+22+22+22+50	1.19	1.78	1.78	1.78	3.88	10.40 (4.10-13.80)	2.805 (0.800-4.100)	12.32	99
20+22+22+22+60	1.14	1.72	1.72	1.72	4.11	10.40 (4.10-13.80)	2.795 (0.800-4.090)	12.27	99
20+22+22+22+71	1.14	1.72	1.72	1.72	4.11	10.40 (4.10-13.80)	2.785 (0.800-4.080)	12.23	99
20+22+22+25+25	1.43	2.15	2.15	2.34	2.34	10.40 (4.10-13.80)	2.805 (0.800-4.100)	12.32	99
20+22+22+25+35	1.40	2.09	2.09	2.28	2.54	10.40 (4.10-13.80)	2.805 (0.800-4.100)	12.32	99
20+22+22+25+42	1.29	1.93	1.93	2.10	3.16	10.40 (4.10-13.80)	2.805 (0.800-4.100)	12.32	99
20+22+22+25+50	1.17	1.75	1.75	1.91	3.82	10.40 (4.10-13.80)	2.805 (0.800-4.100)	12.32	99
20+22+22+25+60	1.13	1.69	1.69	1.84	4.05	10.40 (4.10-13.80)	2.795 (0.800-4.090)	12.27	99
20+22+22+25+71	1.13	1.69	1.69	1.84	4.05	10.40 (4.10-13.80)	2.785 (0.800-4.080)	12.23	99
20+22+22+35+35	1.36	2.04	2.04	2.48	2.48	10.40 (4.10-13.80)	2.805 (0.800-4.100)	12.32	99
20+22+22+35+42	1.26	1.89	1.89	2.29	3.09	10.40 (4.10-13.80)	2.805 (0.800-4.100)	12.32	99
20+22+22+35+50	1.14	1.72	1.72	2.08	3.74	10.40 (4.10-13.80)	2.805 (0.800-4.100)	12.32	99
20+22+22+35+60	1.11	1.66	1.66	2.01	3.97	10.40 (4.10-13.80)	2.795 (0.800-4.090)	12.27	99
20+22+22+35+71	1.11	1.66	1.66	2.01	3.97	10.40 (4.10-13.80)	2.785 (0.800-4.080)	12.23	99
20+22+22+42+42	1.17	1.75	1.75	2.87	2.87	10.40 (4.10-13.80)	2.805 (0.800-4.100)	12.32	99
20+22+22+42+50	1.07	1.60	1.60	2.62	3.50	10.40 (4.10-13.80)	2.805 (0.800-4.100)	12.32	99
20+22+22+42+60	1.04	1.55	1.55	2.54	3.72	10.40 (4.10-13.80)	2.795 (0.800-4.090)	12.27	99
20+22+22+50+50	0.99	1.48	1.48	3.23	3.23	10.40 (4.10-13.80)	2.805 (0.800-4.100)	12.32	99
20+22+25+25+25	1.40	2.11	2.30	2.30	2.30	10.40 (4.10-13.80)	2.805 (0.800-4.100)	12.32	99
20+22+25+25+35	1.37	2.06	2.24	2.24	2.49	10.40 (4.10-13.80)	2.805 (0.800-4.100)	12.32	99

MXZ-5D102VA HEATING

Indoor units combination	Heating capacity (kW)						Outdoor unit power consumption(kW)	Current (A)	Power factor(%)
	Unit A	Unit B	Unit C	Unit D	Unit E	Total			
20+22+25+25+42	1.26	1.90	2.07	2.07	3.10	10.40 (4.10-13.80)	2.805 (0.800-4.100)	12.32	99
20+22+25+25+50	1.15	1.72	1.88	1.88	3.76	10.40 (4.10-13.80)	2.805 (0.800-4.100)	12.32	99
20+22+25+25+60	1.11	1.67	1.82	1.82	3.99	10.40 (4.10-13.80)	2.795 (0.800-4.090)	12.27	99
20+22+25+25+71	1.11	1.67	1.82	1.82	3.99	10.40 (4.10-13.80)	2.785 (0.800-4.080)	12.23	99
20+22+25+35+35	1.34	2.01	2.19	2.43	2.43	10.40 (4.10-13.80)	2.805 (0.800-4.100)	12.32	99
20+22+25+35+42	1.24	1.86	2.02	2.25	3.04	10.40 (4.10-13.80)	2.805 (0.800-4.100)	12.32	99
20+22+25+35+50	1.13	1.69	1.84	2.05	3.69	10.40 (4.10-13.80)	2.805 (0.800-4.100)	12.32	99
20+22+25+35+60	1.09	1.63	1.78	1.98	3.91	10.40 (4.10-13.80)	2.795 (0.800-4.090)	12.27	99
20+22+25+42+42	1.15	1.72	1.88	2.82	2.82	10.40 (4.10-13.80)	2.805 (0.800-4.100)	12.32	99
20+22+25+42+50	1.05	1.58	1.73	2.59	3.45	10.40 (4.10-13.80)	2.805 (0.800-4.100)	12.32	99
20+22+25+42+60	1.02	1.53	1.67	2.51	3.67	10.40 (4.10-13.80)	2.795 (0.800-4.090)	12.27	99
20+22+25+50+50	0.97	1.46	1.59	3.19	3.19	10.40 (4.10-13.80)	2.805 (0.800-4.100)	12.32	99
20+22+35+35+35	1.31	1.96	2.38	2.38	2.38	10.40 (4.10-13.80)	2.805 (0.800-4.100)	12.32	99
20+22+35+35+42	1.21	1.82	2.20	2.20	2.97	10.40 (4.10-13.80)	2.805 (0.800-4.100)	12.32	99
20+22+35+35+50	1.11	1.66	2.01	2.01	3.62	10.40 (4.10-13.80)	2.805 (0.800-4.100)	12.32	99
20+22+35+35+60	1.07	1.60	1.94	1.94	3.84	10.40 (4.10-13.80)	2.795 (0.800-4.090)	12.27	99
20+22+35+42+42	1.13	1.69	2.05	2.77	2.77	10.40 (4.10-13.80)	2.805 (0.800-4.100)	12.32	99
20+22+35+42+50	1.04	1.55	1.88	2.54	3.39	10.40 (4.10-13.80)	2.805 (0.800-4.100)	12.32	99
20+22+42+42+42	1.05	1.58	2.59	2.59	2.59	10.40 (4.10-13.80)	2.805 (0.800-4.100)	12.32	99
20+25+25+25+25	1.38	2.26	2.26	2.26	2.26	10.40 (4.10-13.80)	2.805 (0.800-4.100)	12.32	99
20+25+25+25+35	1.35	2.20	2.20	2.20	2.45	10.40 (4.10-13.80)	2.805 (0.800-4.100)	12.32	99
20+25+25+25+42	1.24	2.03	2.03	2.03	3.05	10.40 (4.10-13.80)	2.805 (0.800-4.100)	12.32	99
20+25+25+25+50	1.13	1.85	1.85	1.85	3.71	10.40 (4.10-13.80)	2.805 (0.800-4.100)	12.32	99
20+25+25+25+60	1.09	1.79	1.79	1.79	3.93	10.40 (4.10-13.80)	2.795 (0.800-4.090)	12.27	99
20+25+25+25+71	1.09	1.79	1.79	1.79	3.93	10.40 (4.10-13.80)	2.785 (0.800-4.080)	12.23	99
20+25+25+35+35	1.31	2.15	2.15	2.39	2.39	10.40 (4.10-13.80)	2.805 (0.800-4.100)	12.32	99
20+25+25+35+42	1.22	1.99	1.99	2.21	2.99	10.40 (4.10-13.80)	2.805 (0.800-4.100)	12.32	99
20+25+25+35+50	1.11	1.82	1.82	2.02	3.63	10.40 (4.10-13.80)	2.805 (0.800-4.100)	12.32	99
20+25+25+35+60	1.07	1.76	1.76	1.95	3.86	10.40 (4.10-13.80)	2.795 (0.800-4.090)	12.27	99
20+25+25+42+42	1.13	1.85	1.85	2.78	2.78	10.40 (4.10-13.80)	2.805 (0.800-4.100)	12.32	99
20+25+25+42+50	1.04	1.70	1.70	2.55	3.40	10.40 (4.10-13.80)	2.805 (0.800-4.100)	12.32	99
20+25+25+42+60	1.01	1.65	1.65	2.47	3.62	10.40 (4.10-13.80)	2.795 (0.800-4.090)	12.27	99
20+25+25+50+50	0.96	1.57	1.57	3.15	3.15	10.40 (4.10-13.80)	2.805 (0.800-4.100)	12.32	99
20+25+35+35+35	1.29	2.10	2.34	2.34	2.34	10.40 (4.10-13.80)	2.805 (0.800-4.100)	12.32	99
20+25+35+35+42	1.19	1.95	2.17	2.17	2.93	10.40 (4.10-13.80)	2.805 (0.800-4.100)	12.32	99
20+25+35+35+50	1.09	1.78	1.98	1.98	3.57	10.40 (4.10-13.80)	2.805 (0.800-4.100)	12.32	99
20+25+35+42+42	1.11	1.82	2.02	2.73	2.73	10.40 (4.10-13.80)	2.805 (0.800-4.100)	12.32	99
20+25+35+42+50	1.02	1.67	1.86	2.51	3.34	10.40 (4.10-13.80)	2.805 (0.800-4.100)	12.32	99
20+25+42+42+42	1.04	1.70	2.55	2.55	2.55	10.40 (4.10-13.80)	2.805 (0.800-4.100)	12.32	99
20+35+35+35+35	1.26	2.29	2.29	2.29	2.29	10.40 (4.10-13.80)	2.805 (0.800-4.100)	12.32	99
20+35+35+35+42	1.17	2.12	2.12	2.12	2.87	10.40 (4.10-13.80)	2.805 (0.800-4.100)	12.32	99

MXZ-5D102VA HEATING

Indoor units combination	Heating capacity (kW)						Outdoor unit power consumption(kW)	Current (A)	Power factor(%)
	Unit A	Unit B	Unit C	Unit D	Unit E	Total			
22+22+22+22+22	2.10	2.10	2.10	2.10	2.10	10.50 (4.10-14.00)	2.765 (0.780-4.100)	12.14	99
22+22+22+22+25	2.06	2.06	2.06	2.06	2.25	10.50 (4.10-14.00)	2.765 (0.780-4.100)	12.14	99
22+22+22+22+35	2.01	2.01	2.01	2.01	2.44	10.50 (4.10-14.00)	2.765 (0.780-4.100)	12.14	99
22+22+22+22+42	1.86	1.86	1.86	1.86	3.05	10.50 (4.10-14.00)	2.765 (0.780-4.100)	12.14	99
22+22+22+22+50	1.70	1.70	1.70	1.70	3.71	10.50 (4.10-14.00)	2.765 (0.780-4.100)	12.14	99
22+22+22+22+60	1.64	1.64	1.64	1.64	3.93	10.50 (4.10-14.00)	2.755 (0.780-4.090)	12.10	99
22+22+22+22+71	1.64	1.64	1.64	1.64	3.93	10.50 (4.10-14.00)	2.745 (0.780-4.080)	12.06	99
22+22+22+25+25	2.03	2.03	2.03	2.21	2.21	10.50 (4.10-14.00)	2.765 (0.780-4.100)	12.14	99
22+22+22+25+35	1.98	1.98	1.98	2.16	2.40	10.50 (4.10-14.00)	2.765 (0.780-4.100)	12.14	99
22+22+22+25+42	1.83	1.83	1.83	2.00	3.00	10.50 (4.10-14.00)	2.765 (0.780-4.100)	12.14	99
22+22+22+25+50	1.67	1.67	1.67	1.83	3.65	10.50 (4.10-14.00)	2.765 (0.780-4.100)	12.14	99
22+22+22+25+60	1.62	1.62	1.62	1.77	3.88	10.50 (4.10-14.00)	2.755 (0.780-4.090)	12.10	99
22+22+22+25+71	1.62	1.62	1.62	1.77	3.88	10.50 (4.10-14.00)	2.745 (0.780-4.080)	12.06	99
22+22+22+35+35	1.94	1.94	1.94	2.35	2.35	10.50 (4.10-14.00)	2.765 (0.780-4.100)	12.14	99
22+22+22+35+42	1.80	1.80	1.80	2.18	2.94	10.50 (4.10-14.00)	2.765 (0.780-4.100)	12.14	99
22+22+22+35+50	1.64	1.64	1.64	1.99	3.58	10.50 (4.10-14.00)	2.765 (0.780-4.100)	12.14	99
22+22+22+35+60	1.59	1.59	1.59	1.93	3.81	10.50 (4.10-14.00)	2.755 (0.780-4.090)	12.10	99
22+22+22+35+71	1.59	1.59	1.59	1.93	3.81	10.50 (4.10-14.00)	2.745 (0.780-4.080)	12.06	99
22+22+22+42+42	1.67	1.67	1.67	2.74	2.74	10.50 (4.10-14.00)	2.765 (0.780-4.100)	12.14	99
22+22+22+42+50	1.54	1.54	1.54	2.52	3.36	10.50 (4.10-14.00)	2.765 (0.780-4.100)	12.14	99
22+22+22+42+60	1.49	1.49	1.49	2.44	3.58	10.50 (4.10-14.00)	2.755 (0.780-4.090)	12.10	99
22+22+22+50+50	1.43	1.43	1.43	3.11	3.11	10.50 (4.10-14.00)	2.765 (0.780-4.100)	12.14	99
22+22+25+25+25	1.99	1.99	2.17	2.17	2.17	10.50 (4.10-14.00)	2.765 (0.780-4.100)	12.14	99
22+22+25+25+35	1.95	1.95	2.12	2.12	2.36	10.50 (4.10-14.00)	2.765 (0.780-4.100)	12.14	99
22+22+25+25+42	1.80	1.80	1.97	1.97	2.95	10.50 (4.10-14.00)	2.765 (0.780-4.100)	12.14	99
22+22+25+25+50	1.65	1.65	1.80	1.80	3.60	10.50 (4.10-14.00)	2.765 (0.780-4.100)	12.14	99
22+22+25+25+60	1.60	1.60	1.74	1.74	3.82	10.50 (4.10-14.00)	2.755 (0.780-4.090)	12.10	99
22+22+25+25+71	1.60	1.60	1.74	1.74	3.82	10.50 (4.10-14.00)	2.745 (0.780-4.080)	12.06	99
22+22+25+35+35	1.90	1.90	2.08	2.31	2.31	10.50 (4.10-14.00)	2.765 (0.780-4.100)	12.14	99
22+22+25+35+42	1.77	1.77	1.93	2.14	2.89	10.50 (4.10-14.00)	2.765 (0.780-4.100)	12.14	99
22+22+25+35+50	1.62	1.62	1.77	1.96	3.53	10.50 (4.10-14.00)	2.765 (0.780-4.100)	12.14	99
22+22+25+35+60	1.57	1.57	1.71	1.90	3.75	10.50 (4.10-14.00)	2.755 (0.780-4.090)	12.10	99
22+22+25+42+42	1.65	1.65	1.80	2.70	2.70	10.50 (4.10-14.00)	2.765 (0.780-4.100)	12.14	99
22+22+25+42+50	1.52	1.52	1.66	2.49	3.32	10.50 (4.10-14.00)	2.765 (0.780-4.100)	12.14	99
22+22+25+42+60	1.47	1.47	1.61	2.41	3.53	10.50 (4.10-14.00)	2.755 (0.780-4.090)	12.10	99
22+22+25+50+50	1.41	1.41	1.54	3.07	3.07	10.50 (4.10-14.00)	2.765 (0.780-4.100)	12.14	99
22+22+35+35+35	1.86	1.86	2.26	2.26	2.26	10.50 (4.10-14.00)	2.765 (0.780-4.100)	12.14	99
22+22+35+35+42	1.73	1.73	2.10	2.10	2.84	10.50 (4.10-14.00)	2.765 (0.780-4.100)	12.14	99
22+22+35+35+50	1.59	1.59	1.93	1.93	3.47	10.50 (4.10-14.00)	2.765 (0.780-4.100)	12.14	99
22+22+35+42+42	1.62	1.62	1.96	2.65	2.65	10.50 (4.10-14.00)	2.765 (0.780-4.100)	12.14	99
22+22+35+42+50	1.49	1.49	1.81	2.44	3.26	10.50 (4.10-14.00)	2.765 (0.780-4.100)	12.14	99

MXZ-5D102VA HEATING

Indoor units combination	Heating capacity (kW)						Outdoor unit power consumption(kW)	Current (A)	Power factor(%)
	Unit A	Unit B	Unit C	Unit D	Unit E	Total			
22+22+42+42+42	1.52	1.52	2.49	2.49	2.49	10.50 (4.10-14.00)	2.765 (0.780-4.100)	12.14	99
22+25+25+25+25	1.96	2.14	2.14	2.14	2.14	10.50 (4.10-14.00)	2.765 (0.780-4.100)	12.14	99
22+25+25+25+35	1.91	2.09	2.09	2.09	2.32	10.50 (4.10-14.00)	2.765 (0.780-4.100)	12.14	99
22+25+25+25+42	1.78	1.94	1.94	1.94	2.91	10.50 (4.10-14.00)	2.765 (0.780-4.100)	12.14	99
22+25+25+25+50	1.63	1.77	1.77	1.77	3.55	10.50 (4.10-14.00)	2.765 (0.780-4.100)	12.14	99
22+25+25+25+60	1.58	1.72	1.72	1.72	3.77	10.50 (4.10-14.00)	2.755 (0.780-4.090)	12.10	99
22+25+25+25+71	1.58	1.72	1.72	1.72	3.77	10.50 (4.10-14.00)	2.745 (0.780-4.080)	12.06	99
22+25+25+35+35	1.87	2.04	2.04	2.27	2.27	10.50 (4.10-14.00)	2.765 (0.780-4.100)	12.14	99
22+25+25+35+42	1.74	1.90	1.90	2.11	2.85	10.50 (4.10-14.00)	2.765 (0.780-4.100)	12.14	99
22+25+25+35+50	1.60	1.74	1.74	1.94	3.48	10.50 (4.10-14.00)	2.765 (0.780-4.100)	12.14	99
22+25+25+35+60	1.55	1.69	1.69	1.88	3.70	10.50 (4.10-14.00)	2.755 (0.780-4.090)	12.10	99
22+25+25+42+42	1.63	1.77	1.77	2.66	2.66	10.50 (4.10-14.00)	2.765 (0.780-4.100)	12.14	99
22+25+25+42+50	1.50	1.64	1.64	2.45	3.27	10.50 (4.10-14.00)	2.765 (0.780-4.100)	12.14	99
22+25+25+50+50	1.39	1.52	1.52	3.04	3.04	10.50 (4.10-14.00)	2.765 (0.780-4.100)	12.14	99
22+25+35+35+35	1.83	2.00	2.22	2.22	2.22	10.50 (4.10-14.00)	2.765 (0.780-4.100)	12.14	99
22+25+35+35+42	1.71	1.86	2.07	2.07	2.79	10.50 (4.10-14.00)	2.765 (0.780-4.100)	12.14	99
22+25+35+35+50	1.57	1.71	1.90	1.90	3.42	10.50 (4.10-14.00)	2.765 (0.780-4.100)	12.14	99
22+25+35+42+42	1.60	1.74	1.94	2.61	2.61	10.50 (4.10-14.00)	2.765 (0.780-4.100)	12.14	99
22+35+35+35+35	1.80	2.18	2.18	2.18	2.18	10.50 (4.10-14.00)	2.765 (0.780-4.100)	12.14	99
22+35+35+35+42	1.67	2.03	2.03	2.03	2.74	10.50 (4.10-14.00)	2.765 (0.780-4.100)	12.14	99
25+25+25+25+25	2.10	2.10	2.10	2.10	2.10	10.50 (4.10-14.00)	2.765 (0.780-4.100)	12.14	99
25+25+25+25+35	2.05	2.05	2.05	2.05	2.28	10.50 (4.10-14.00)	2.765 (0.780-4.100)	12.14	99
25+25+25+25+42	1.91	1.91	1.91	1.91	2.86	10.50 (4.10-14.00)	2.765 (0.780-4.100)	12.14	99
25+25+25+25+50	1.75	1.75	1.75	1.75	3.50	10.50 (4.10-14.00)	2.765 (0.780-4.100)	12.14	99
25+25+25+25+60	1.70	1.70	1.70	1.70	3.72	10.50 (4.10-14.00)	2.755 (0.780-4.090)	12.10	99
25+25+25+25+71	1.70	1.70	1.70	1.70	3.72	10.50 (4.10-14.00)	2.745 (0.780-4.080)	12.06	99
25+25+25+35+35	2.01	2.01	2.01	2.23	2.23	10.50 (4.10-14.00)	2.765 (0.780-4.100)	12.14	99
25+25+25+35+42	1.87	1.87	1.87	2.08	2.81	10.50 (4.10-14.00)	2.765 (0.780-4.100)	12.14	99
25+25+25+35+50	1.72	1.72	1.72	1.91	3.44	10.50 (4.10-14.00)	2.765 (0.780-4.100)	12.14	99
25+25+25+35+60	1.67	1.67	1.67	1.85	3.65	10.50 (4.10-14.00)	2.755 (0.780-4.090)	12.10	99
25+25+25+42+42	1.75	1.75	1.75	2.63	2.63	10.50 (4.10-14.00)	2.765 (0.780-4.100)	12.14	99
25+25+25+42+50	1.62	1.62	1.62	2.42	3.23	10.50 (4.10-14.00)	2.765 (0.780-4.100)	12.14	99
25+25+35+35+35	1.97	1.97	2.19	2.19	2.19	10.50 (4.10-14.00)	2.765 (0.780-4.100)	12.14	99
25+25+35+35+42	1.83	1.83	2.04	2.04	2.75	10.50 (4.10-14.00)	2.765 (0.780-4.100)	12.14	99
25+25+35+35+50	1.69	1.69	1.88	1.88	3.38	10.50 (4.10-14.00)	2.765 (0.780-4.100)	12.14	99
25+25+35+42+42	1.72	1.72	1.91	2.58	2.58	10.50 (4.10-14.00)	2.765 (0.780-4.100)	12.14	99
25+35+35+35+35	1.93	2.14	2.14	2.14	2.14	10.50 (4.10-14.00)	2.765 (0.780-4.100)	12.14	99
25+35+35+35+42	1.80	2.00	2.00	2.00	2.70	10.50 (4.10-14.00)	2.765 (0.780-4.100)	12.14	99