

OUTDOOR UNIT

SERVICE MANUAL



No. OBH832

Models

MUZ-EF25VG - E1, ET1

MUZ-EF35VG - E1, ET1

MUZ-EF42VG - E1, ET1

MUZ-EF50VG - E1, ET1

MUZ-EF25VGH - E1

MUZ-EF35VGH - E1

Indoor unit service manual
MSZ-EF•VG Series (OBH831)

MUZ-EF25VG
MUZ-EF35VG
MUZ-EF42VG

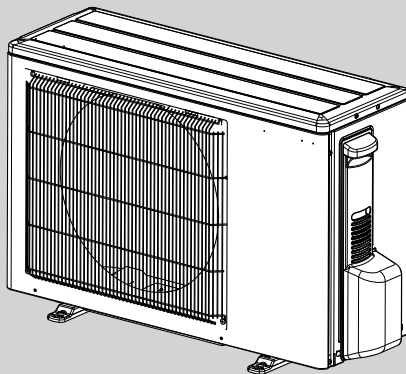

CONTENTS

1. TECHNICAL CHANGES	2
2. SERVICING PRECAUTIONS FOR UNITS USING REFRIGERANT R32.....	3
3. PART NAMES AND FUNCTIONS.....	5
4. SPECIFICATION.....	6
5. NOISE CRITERIA CURVES	8
6. OUTLINES AND DIMENSIONS	9
7. WIRING DIAGRAM.....	10
8. REFRIGERANT SYSTEM DIAGRAM	12
9. PERFORMANCE CURVES	14
10. ACTUATOR CONTROL	28
11. SERVICE FUNCTIONS.....	29
12. TROUBLESHOOTING.....	30
13. DISASSEMBLY INSTRUCTIONS.....	50

PARTS CATALOG (OBB832)

Use the specified refrigerant only

Never use any refrigerant other than that specified.

Doing so may cause a burst, an explosion, or fire when the unit is being used, serviced, or disposed of.

Correct refrigerant is specified in the manuals and on the spec labels provided with our products.

We will not be held responsible for mechanical failure, system malfunction, unit breakdown or accidents caused by failure to follow the instructions.

<Preparation before the repair service>

- Prepare the proper tools.
- Prepare the proper protectors.
- Provide adequate ventilation.
- After stopping the operation of the air conditioner, turn off the power-supply breaker and remove the power plug.
- Discharge the capacitor before the work involving the electric parts.

<Precautions during the repair service>

- Do not perform the work involving the electric parts with wet hands.
- Do not pour water into the electric parts.
- Do not touch the refrigerant.
- Do not touch the hot or cold areas in the refrigeration cycle.
- When the repair or the inspection of the circuit needs to be done without turning off the power, exercise great caution not to touch the live parts.

1

TECHNICAL CHANGES

MUZ-EF25VG - E1, ET1

MUZ-EF35VG - E1, ET1

MUZ-EF42VG - E1, ET1

MUZ-EF50VG - E1, ET1

MUZ-EF25VGH - E1

MUZ-EF35VGH - E1

1. New model

Servicing precautions for units using refrigerant R32

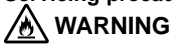

This unit uses a flammable refrigerant.

If refrigerant leaks and comes in contact with fire or heating part, it will create harmful gas and there is risk of fire.

- Do not use means to accelerate the defrosting process or to clean, other than those recommended by the manufacturer.
- The appliance shall be stored in a room without continuously operating ignition sources (for example: open flames, an operating gas appliance or an operating electric heater.)
- Do not pierce or burn.
- Be aware that refrigerants may not contain an odor.
- Pipe-work shall be protected from physical damage.
- The installation of pipe-work shall be kept to a minimum.
- Compliance with national gas regulations shall be observed.
- Keep any required ventilation openings clear of obstruction.
- Servicing shall be performed only as recommended by the manufacturer.
- The appliance shall be stored so as to prevent mechanical damage from occurring.

Basic work procedures are the same as those for conventional units using refrigerant R410A. However, pay careful attention to the following points.

1. Information on servicing
 - ① Checks on the Area

Prior to beginning work on systems containing flammable refrigerants, safety checks are necessary to ensure that the risk of ignition is minimized.
 - ② Work Procedure

Work shall be undertaken under a controlled procedure so as to minimize the risk of a flammable gas or vapor being present while the work is being performed.
 - ③ General Work Area

All maintenance staff and others working in the local area shall be instructed on the nature of work being carried out. Work in confined spaces shall be avoided. The area around the workspace shall be sectioned off. Ensure that the conditions within the area have been made safe by control of flammable material.
 - ④ Checking for Presence of Refrigerant

The area shall be checked with an appropriate refrigerant detector prior to and during work, to ensure the technician is aware of potentially toxic or flammable atmospheres. Ensure that the leak detection equipment being used is suitable for use with all applicable refrigerants, i.e. non-sparking, adequately sealed or intrinsically safe.
 - ⑤ Presence of Fire Extinguisher

If any hot work is to be conducted on the refrigeration equipment or any associated parts, appropriate fire extinguishing equipment shall be available to hand. Have a dry powder or CO2 fire extinguisher adjacent to the charging area.
 - ⑥ No Ignition Sources

No person carrying out work in relation to a refrigeration system which involves exposing any pipe work shall use any sources of ignition in such a manner that it may lead to the risk of fire or explosion. All possible ignition sources, including cigarette smoking, should be kept sufficiently far away from the site of installation, repairing, removing and disposal, during which refrigerant can possibly be released to the surrounding space. Prior to work taking place, the area around the equipment is to be surveyed to make sure that there are no flammable hazards or ignition risks. "No Smoking" signs shall be displayed.
 - ⑦ Ventilated Area

Ensure that the area is in the open or that it is adequately ventilated before breaking into the system or conducting any hot work. A degree of ventilation shall continue during the period that the work is carried out. The ventilation should safely disperse any released refrigerant and preferably expel it externally into the atmosphere.
 - ⑧ Checks on the Refrigeration Equipment

Where electrical components are being changed, they shall be fit for the purpose and to the correct specification. At all times the manufacturer's maintenance and service guidelines shall be followed. If in doubt, consult the manufacturer's technical department for assistance.

The following checks shall be applied to installations using flammable refrigerants:

 - The charge size is in accordance with the room size within which the refrigerant containing parts are installed.
 - The ventilation machinery and outlets are operating adequately and are not obstructed.
 - If an indirect refrigerating circuit is being used, the secondary circuit shall be checked for the presence of refrigerant.
 - Marking to the equipment continues to be visible and legible. Markings and signs that are illegible shall be corrected.
 - Refrigeration pipe or components are installed in a position where they are unlikely to be exposed to any substance which may corrode refrigerant containing components, unless the components are constructed of materials which are inherently resistant to being corroded or are suitably protected against being corroded.
 - ⑨ Checks on Electrical Devices

Repair and maintenance to electrical components shall include initial safety checks and component inspection procedures. If a fault exists that could compromise safety, then no electrical supply shall be connected to the circuit until it is satisfactorily dealt with. If the fault cannot be corrected immediately but it is necessary to continue operation, an adequate temporary solution shall be used. This shall be reported to the owner of the equipment so all parties are advised.

Initial safety checks shall include that:

 - capacitors are discharged: this shall be done in a safe manner to avoid possibility of sparking;
 - no live electrical components and wiring are exposed while charging, recovering or purging the system;
 - there is continuity of earth bonding
2. Repairs to Sealed Components
 - ① During repairs to sealed components, all electrical supplies shall be disconnected from the equipment being worked upon prior to any removal of sealed covers, etc. If it is absolutely necessary to have an electrical supply to equipment during servicing, then a permanently operating form of leak detection shall be located at the most critical point to warn of a potentially hazardous situation.
 - ② Particular attention shall be paid to the following to ensure that by working on electrical components, the casing is not altered in such a way that the level of protection is affected. This shall include damage to cables, excessive number of connections, terminals not made to original specification, damage to seals, incorrect fitting of glands, etc.

Ensure that the apparatus is mounted securely.

Ensure that seals or sealing materials have not degraded to the point that they no longer serve the purpose of preventing the ingress of flammable atmospheres. Replacement parts shall be in accordance with the manufacturer's specifications.
3. Repair to Intrinsic Safe Components

Do not apply any permanent inductive or capacitance loads to the circuit without ensuring that this will not exceed the permissible voltage and current permitted for the equipment in use.

Intrinsic safe components are the only types that can be worked on while live in the presence of a flammable atmosphere. The test apparatus shall be at the correct rating.

Replace components only with parts specified by the manufacturer. Other parts may result in the ignition of refrigerant in the atmosphere from a leak.
4. Cabling

Check that cabling will not be subject to wear, corrosion, excessive pressure, vibration, sharp edges or any other adverse environmental effects. The check shall also take into account the effects of aging or continual vibration from sources such as compressors or fans.

5. Detection of Flammable Refrigerants

Under no circumstances shall potential sources of ignition be used in the searching for or detection of refrigerant leaks. A halide torch (or any other detector using a naked flame) shall not be used.

6. Leak Detection Methods

Electronic leak detectors may be used to detect refrigerant leaks but, in the case of flammable refrigerants, the sensitivity may not be adequate, or may need re-calibration. (Detection equipment shall be calibrated in a refrigerant-free area.) Ensure that the detector is not a potential source of ignition and is suitable for the refrigerant used. Leak detection equipment shall be set at a percentage of the LFL of the refrigerant and shall be calibrated to the refrigerant employed, and the appropriate percentage of gas (25 % maximum) is confirmed.

Leak detection fluids are suitable for use with most refrigerants but the use of detergents containing chlorine shall be avoided as the chlorine may react with the refrigerant and corrode the copper pipe-work.

If a leak is suspected, all naked flames shall be removed/extinguished.

If a leakage of refrigerant is found which requires brazing, all of the refrigerant shall be recovered from the system, or isolated (by means of shut off valves) in a part of the system remote from the leak. For appliances containing flammable refrigerants, oxygen free nitrogen (OFN) shall then be purged through the system both before and during the brazing process.

7. Removal and Evacuation

When breaking into the refrigerant circuit to make repairs - or for any other purpose conventional procedures shall be used. However, for flammable refrigerants it is important that best practice is followed since flammability is a consideration. The following procedure shall be adhered to:

- remove refrigerant
- purge the circuit with inert gas
- evacuate
- purge again with inert gas
- open the circuit by cutting or brazing.

The refrigerant charge shall be recovered into the correct recovery cylinders. For appliances containing flammable refrigerants, the system shall be "flushed" with OFN to render the unit safe. This process may need to be repeated several times. Compressed air or oxygen shall not be used for purging refrigerant systems.

For appliances containing flammable refrigerants, flushing shall be achieved by breaking the vacuum in the system with OFN and continuing to fill until the working pressure is achieved, then venting to atmosphere, and finally pulling down to a vacuum. This process shall be repeated until no refrigerant is within the system. When the final OFN charge is used, the system shall be vented down to atmospheric pressure to enable work to take place. This operation is absolutely vital if brazing operations on the pipe-work are to take place.

Ensure that the outlet for the vacuum pump is not close to any ignition sources and that ventilation is available.

8. Charging Procedures

In addition to conventional charging procedures, the following requirements shall be followed:

- Ensure that contamination of different refrigerants does not occur when using charging equipment. Hoses or lines shall be as short as possible to minimize the amount of refrigerant contained in them.
- Cylinders shall be kept upright.
- Ensure that the refrigeration system is earthed prior to charging the system with refrigerant.
- Label the system when charging is complete (if not already).
- Extreme care shall be taken not to overfill the refrigeration system.

Prior to recharging the system, it shall be pressure-tested with the appropriate purging gas. The system shall be leak-tested on completion of charging but prior to commissioning. A follow up leak test shall be carried out prior to leaving the site.

9. Decommissioning

Before carrying out this procedure, it is essential that the technician is completely familiar with the equipment and all its detail. It is recommended good practice that all refrigerants are recovered safely. Prior to the task being carried out, an oil and refrigerant sample shall be taken in case analysis is required prior to re-use of reclaimed refrigerant. It is essential that electrical power is available before the task is commenced.

- a) Become familiar with the equipment and its operation.
- b) Isolate system electrically.
- c) Before attempting the procedure, ensure that:
 - mechanical handling equipment is available, if required, for handling refrigerant cylinders;
 - all personal protective equipment is available and being used correctly;
 - the recovery process is supervised at all times by a competent person;
 - recovery equipment and cylinders conform to the appropriate standards.
- d) Pump down refrigerant system, if possible.
- e) If a vacuum is not possible, make a manifold so that refrigerant can be removed from various parts of the system.
- f) Make sure that cylinder is situated on the scales before recovery takes place.
- g) Start the recovery machine and operate in accordance with manufacturer's instructions.
- h) Do not overfill cylinders. (no more than 80 % volume liquid charge).
- i) Do not exceed the maximum working pressure of the cylinder, even temporarily.
- j) When the cylinders have been filled correctly and the process completed, make sure that the cylinders and the equipment are removed from site promptly and all isolation valves on the equipment are closed off.
- k) Recovered refrigerant shall not be charged into another refrigeration system unless it has been cleaned and checked.

10. Labeling

Equipment shall be labeled stating that it has been de-commissioned and emptied of refrigerant. The label shall be dated and signed. For appliances containing flammable refrigerants, ensure that there are labels on the equipment stating the equipment contains flammable refrigerant.

11. Recovery

When removing refrigerant from a system, either for servicing or decommissioning, it is recommended good practice that all refrigerants are removed safely.

When transferring refrigerant into cylinders, ensure that only appropriate refrigerant recovery cylinders are employed. Ensure that the correct number of cylinders for holding the total system charge are available. All cylinders to be used are designated for the recovered refrigerant and labeled for that refrigerant (i.e. special cylinders for the recovery of refrigerant). Cylinders shall be complete with pressure-relief valve and associated shut-off valves in good working order. Empty recovery cylinders are evacuated and, if possible, cooled before recovery occurs.

The recovery equipment shall be in good working order with a set of instructions concerning the equipment that is at hand and shall be suitable for the recovery of all appropriate refrigerants including, when applicable, flammable refrigerants. In addition, a set of calibrated weighing scales shall be available and in good working order. Hoses shall be complete with leak-free disconnect couplings and in good condition. Before using the recovery machine, check that it is in satisfactory working order, has been properly maintained and that any associated electrical components are sealed to prevent ignition in the event of a refrigerant release. Consult manufacturer if in doubt.

The recovered refrigerant shall be returned to the refrigerant supplier in the correct recovery cylinder, and the relevant waste transfer note arranged. Do not mix refrigerants in recovery units and especially not in cylinders.

If compressors or compressor oils are to be removed, ensure that they have been evacuated to an acceptable level to make certain that flammable refrigerant does not remain within the lubricant. The evacuation process shall be carried out prior to returning the compressor to the suppliers. Only electric heating to the compressor body shall be employed to accelerate this process. When oil is drained from a system, it shall be carried out safely.

3

PART NAMES AND FUNCTIONS

MUZ-EF25VG
 MUZ-EF35VG
 MUZ-EF42VG
 MUZ-EF25VGH
 MUZ-EF35VGH

MUZ-EF50VG

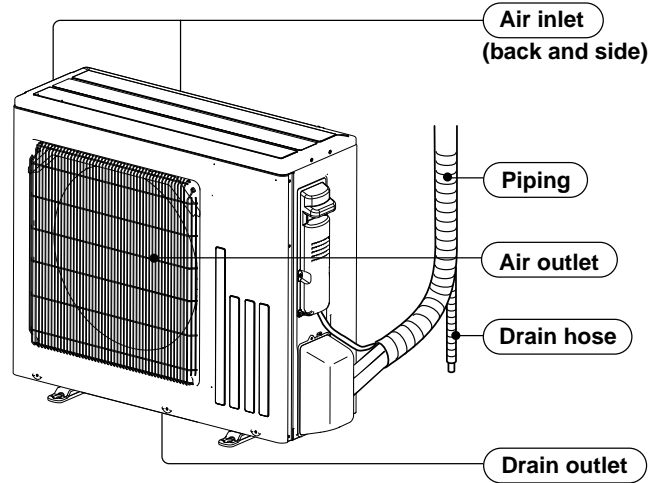
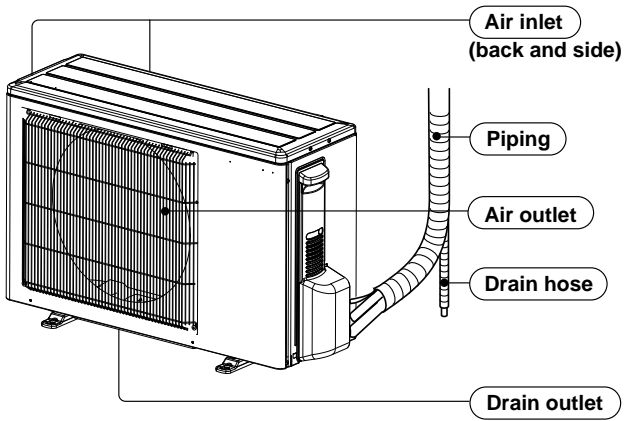

ACCESSORIES

MODELS	MUZ-EF25VG MUZ-EF35VG MUZ-EF42VG MUZ-EF50VG
Drain socket	1

4

SPECIFICATION

*1 Measured under rated operating frequency.

Outdoor model			MUZ-EF25VG MUZ-EF25VGH	MUZ-EF35VG MUZ-EF35VGH	MUZ-EF42VG	MUZ-EF50VG		
Power supply			Single phase, 230 V, 50 Hz					
Capacity Rated frequency (Min.-Max.)	Cooling	kW	2.5 (0.9 - 3.4)	3.5 (1.1 - 4.0)	4.2 (0.9 - 4.6)	5.0 (1.4 - 5.4)		
	Heating		3.2 (1.0 - 4.2)	4.0 (1.3 - 5.1)	5.4 (1.3 - 6.3)	5.8 (1.4 - 7.5)		
Breaker Capacity		A	10		12	16		
Electrical data	Power input *1 (Set)	Cooling	540	910	1,200	1,540		
		Heating	700	950	1,455	1,560		
	Running current *1 (Set)	Cooling	3.0	4.2	5.4	6.9		
		Heating	3.6	4.4	6.5	7.1		
	Power factor *1 (Set)	Cooling	78	94	96	97		
		Heating	84	93	97	95		
Starting current *1 (Set)		A	3.6	4.4	6.5	7.1		
Coefficient of performance (COP) *1 (Set)		Cooling	4.63	3.85	3.50	3.25		
		Heating	4.57	4.21	3.71	3.72		
Compressor			KVB073FYXMC	KVB073FYXMC	SVB130FBBMT	SVB130FBBMT		
Output		W	470	470	900	900		
Current *1	Cooling	A	2.62	3.75	4.96	6.37		
	Heating		3.14	3.88	5.96	6.41		
Refrigeration oil (Model)		L	0.27 (FW68S)		0.35 (FW68S)			
Fan motor			RC0J50-NC			RC0J50-RA		
Current *1	Cooling	A	0.18	0.25	0.22	0.30		
	Heating		0.20	0.23	0.23	0.30		
Dimensions W × H × D		mm	800 × 550 × 285			800 × 714 × 285		
Weight		kg	31	34	35	40		
Special remarks	Dehumidification		Cooling	L/h	0.1	1.0	1.6	2.2
	Air flow *1	Cooling	High	m ³ /h	2,178	2,058	2,058	2,412
			Low		1,038	936	906	1,320
		Heating	High		2,076	1,962	1,962	2,412
			Med.		1,788	1,686	1,686	2,238
			Low		1,452	1,356	1,356	1,704
	Sound level *1		Cooling	dB(A)	47	49	50	52
			Heating		48	50	51	52
	Fan speed	Cooling	High	rpm	940	940	940	840
			Low		470	470	460	490
		Heating	High		900	900	900	840
			Med.		780	780	780	780
			Low		640	640	640	610
Fan speed regulator			3					
Refrigerant filling capacity (R32)		kg	0.62	0.74		1.05		

NOTE: Test conditions are based on ISO 5151.

Cooling: Indoor Dry-bulb temperature 27°C

Wet-bulb temperature 19°C

Outdoor Dry-bulb temperature 35°C

Wet-bulb temperature 24°C

Heating: Indoor Dry-bulb temperature 20°C

Wet-bulb temperature 15°C

Outdoor Dry-bulb temperature 7°C

Wet-bulb temperature 6°C

Refrigerant piping length (one way): 5 m



Specifications and rated conditions of main electric parts

Item \ Model		MUZ- EF25VG	MUZ- EF25VGH	MUZ- EF35VG	MUZ- EF35VGH	MUZ- EF42VG	MUZ- EF50VG	
Smoothing capacitor	(C61)	—				600 μF/ 620 μF 420 V		
	(C62, C63)	600 μF/ 620 μF 420 V						
Diode module	(DB61)	15 A 600 V					25 A 600 V	
Diode module	(DB65)	25 A 600 V						
Fuse	(F61)	25A 250V						
	(F62)	15A 250V						
	(F701, F801, F901)	T3.15AL250V						
Defrost heater	(H)	—	230 V 60W	—	230 V 60W	—	—	
Power module	(IC700)	15 A 600 V				20 A 600 V		
	(IC932)	5 A 600 V						
Expansion valve coil	(LEV)	12 V DC						
Reactor	(L61)	18 mH			23 mH			
Switch power transistor	(Q821)	30/37 A 600 V						
Current-limiting PTC thermistor	(PTC64, PTC65)	33 Ω						
Terminal block	(TB1)	5 P						
Relay	(X63)	3 A 250 V						
	(X64)	20 A 250 V						
	(X66)	—	3 A 250 V	—	3 A 250 V	—	—	
	(X69)	10 A 230 V						
R.V.coil	(21S4)	220 - 240 V AC						
Heater protector	(26H)	—	Open 45°C	—	Open 45°C	—	—	

**MUZ-EF25VG
MUZ-EF25VGH**

FUNCTION	SPL(dB(A))	LINE
COOLING	47	●—●
HEATING	48	○—○

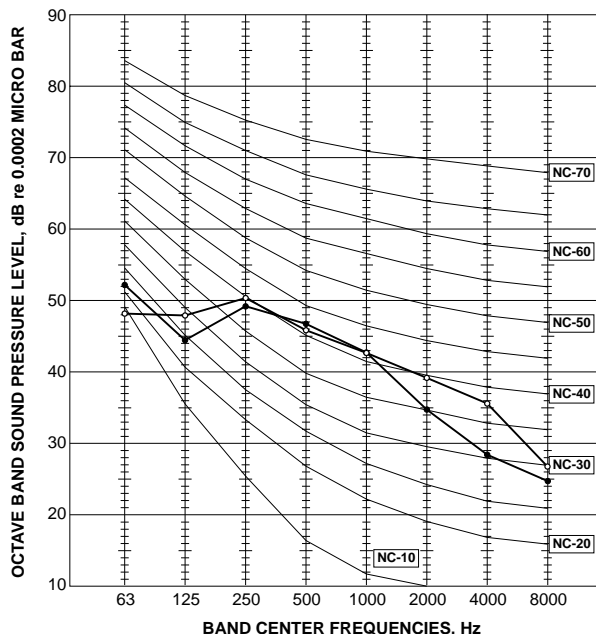

**MUZ-EF35VG
MUZ-EF35VGH**

FUNCTION	SPL(dB(A))	LINE
COOLING	49	●—●
HEATING	50	○—○

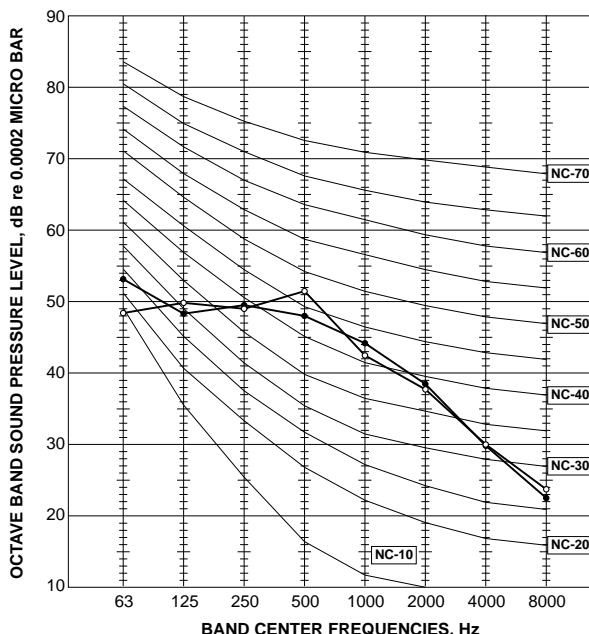

MUZ-EF42VG

FUNCTION	SPL(dB(A))	LINE
COOLING	50	●—●
HEATING	51	○—○

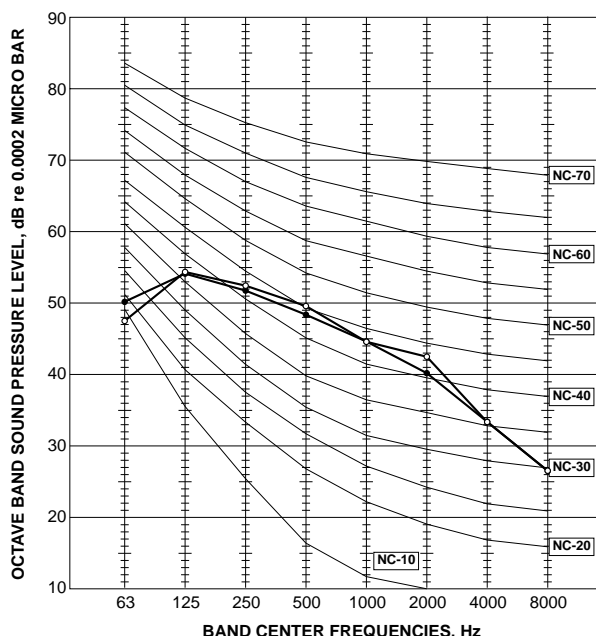

MUZ-EF50VG

FUNCTION	SPL(dB(A))	LINE
COOLING	52	●—●
HEATING	52	○—○

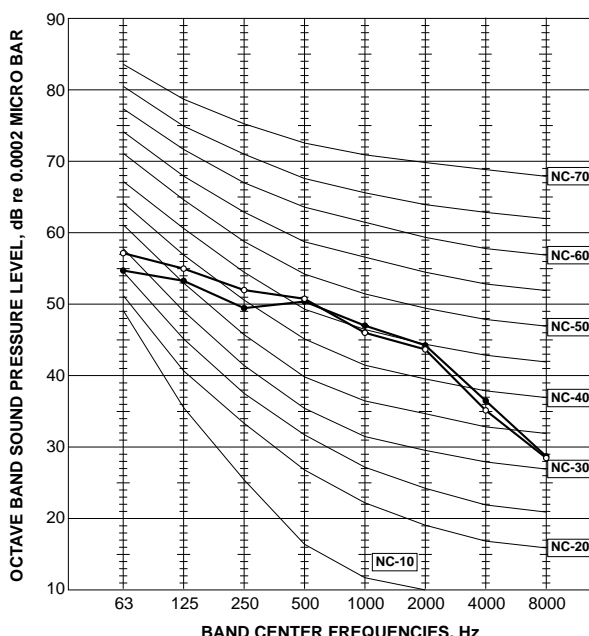

Test conditions

Cooling: Dry-bulb temperature 35°C Wet-bulb temperature 24°C
 Heating: Dry-bulb temperature 7°C Wet-bulb temperature 6°C

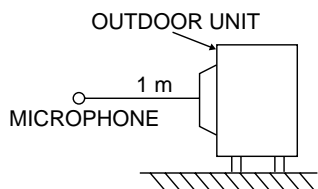

6

OUTLINES AND DIMENSIONS

MUZ-EF25VG MUZ-EF35VG MUZ-EF42VG
 MUZ-EF25VGH MUZ-EF35VGH

Unit: mm

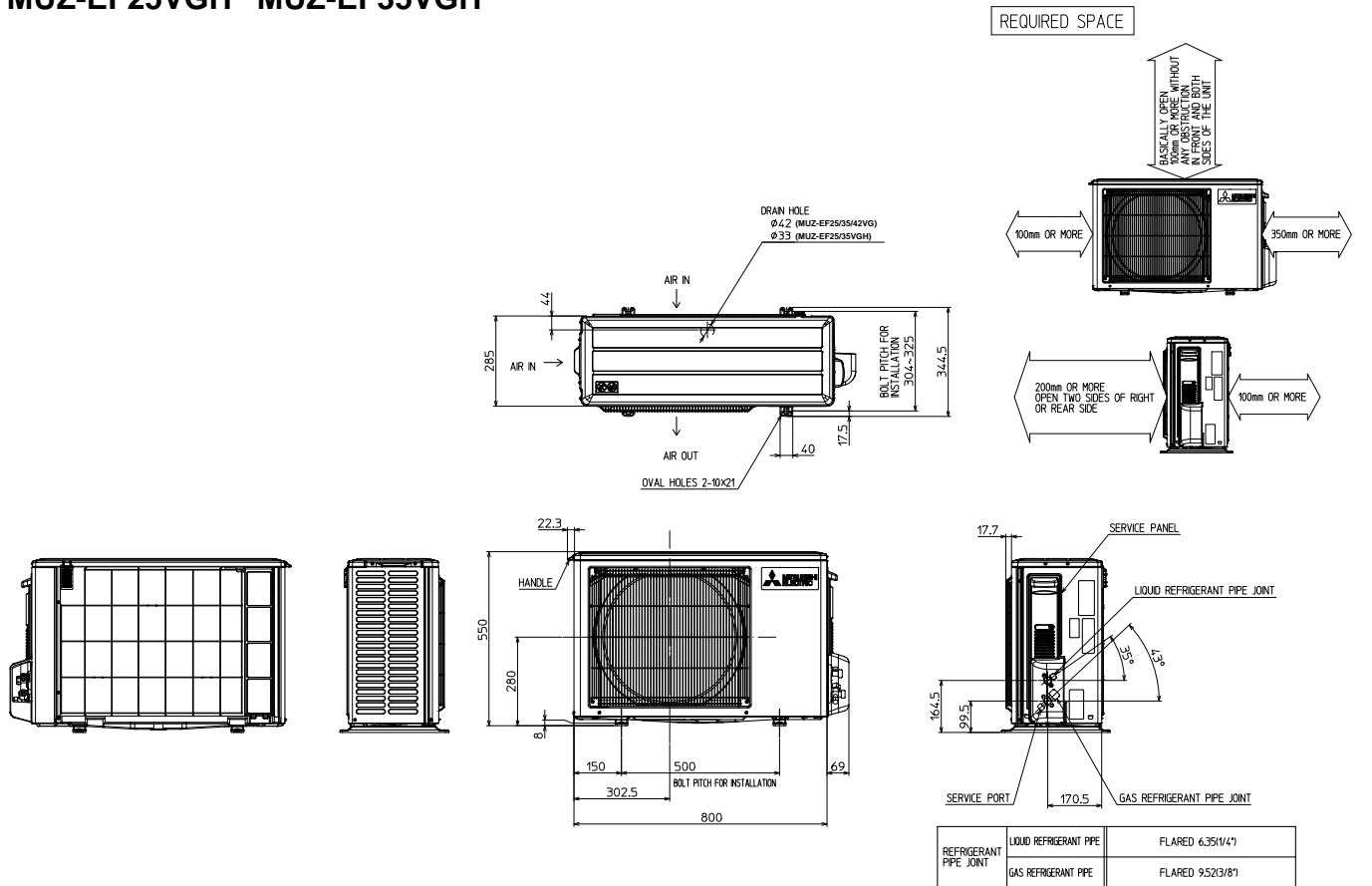

MUZ-EF50VG

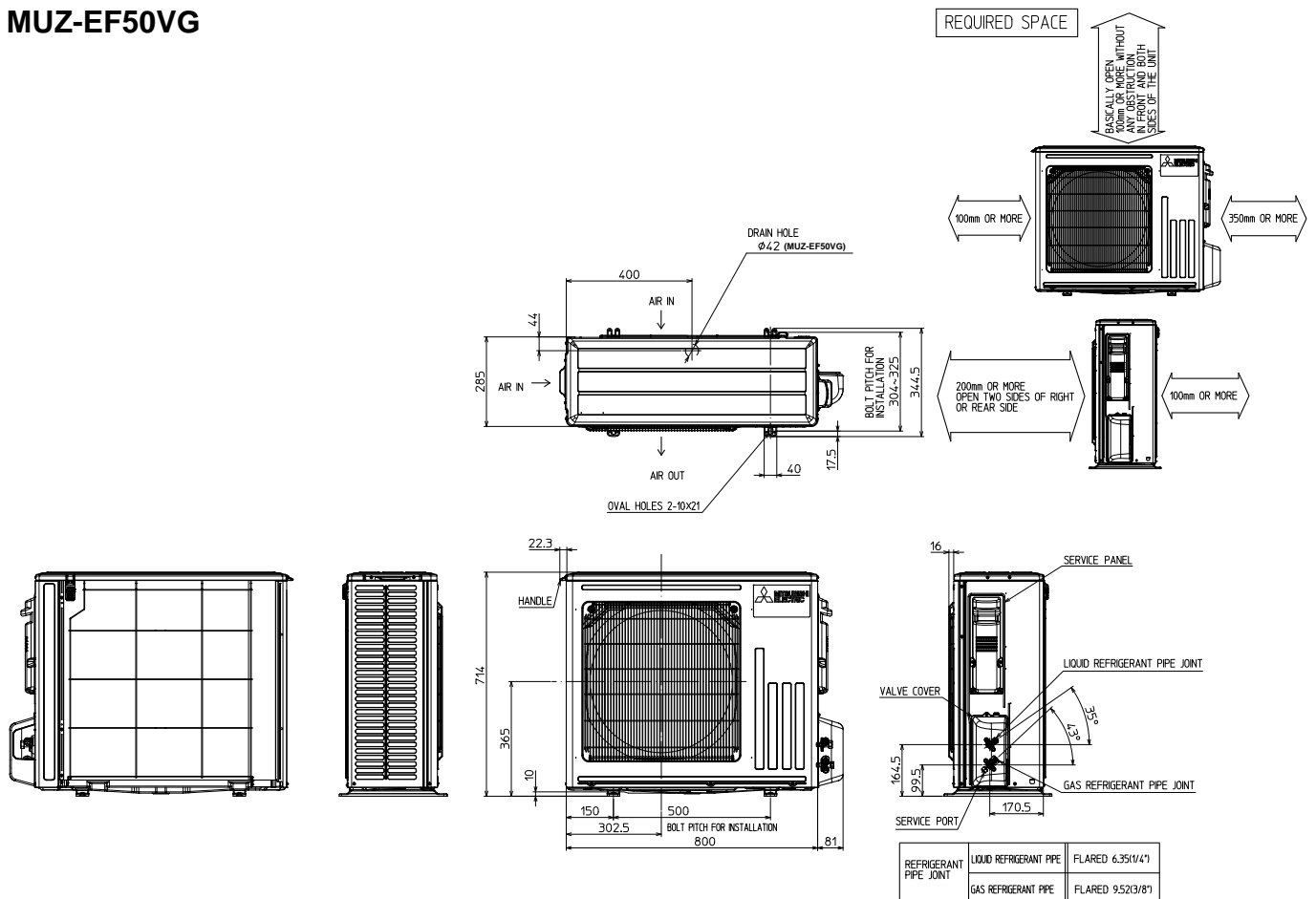

MUZ-EF25VG - [E1, ET1] MUZ-EF35VG - [E1, ET1]

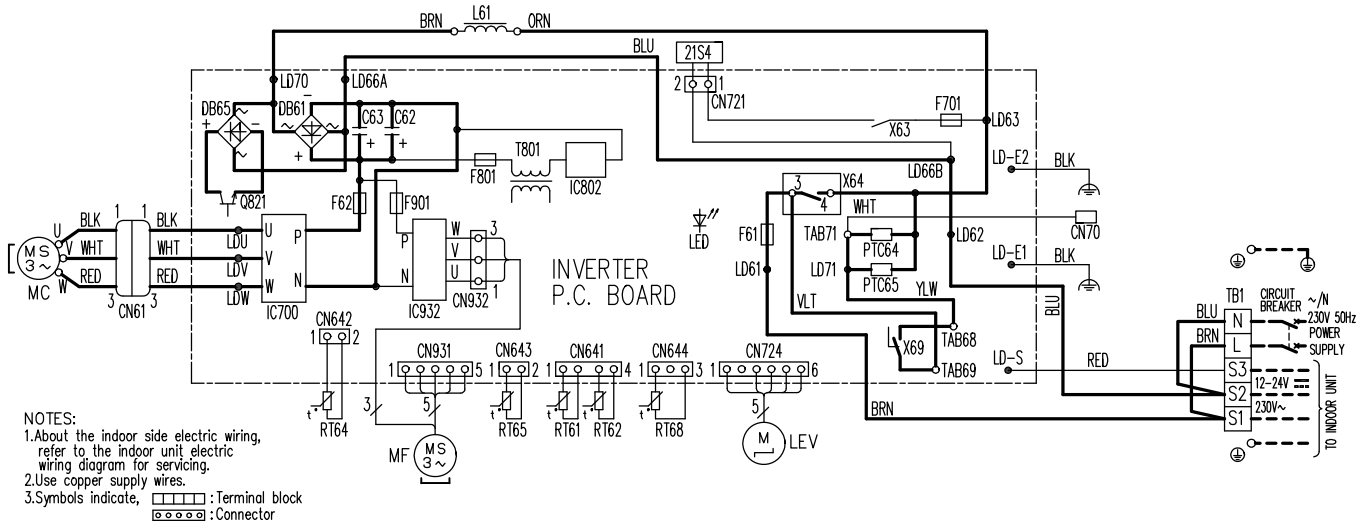

SYMBOL	NAME	SYMBOL	NAME	SYMBOL	NAME
CN61	CONNECTOR	LEV	EXPANSION VALVE COIL	RT65	AMBIENT TEMP. THERMISTOR
C62, C63	SMOOTHING CAPACITOR	L61	REACTOR	RT68	OUTDOOR HEAT EXCHANGER TEMP. THERMISTOR
DB61, DB65	DIODE MODULE	MC	COMPRESSOR	TB1	TERMINAL BLOCK
F61	FUSE (25A 250V)	MF	FAN MOTOR	T801	TRANSFORMER
F62	FUSE (15A 250V)	PTC64, PTC65	CIRCUIT PROTECTION	X63, X64, X69	RELAY
F701, F801, F901	FUSE (T3.15A/250V)	Q821	SWITCHING POWER TRANSISTOR	21S4	REVERSING VALVE COIL
IC700, IC932	POWER MODULE	RT61	DEFROST THERMISTOR		
IC802	POWER DEVICE	RT62	DISCHARGE TEMP. THERMISTOR		
LED	LED	RT64	FIN TEMP. THERMISTOR		

MUZ-EF25VGH - [E1] MUZ-EF35VGH - [E1]

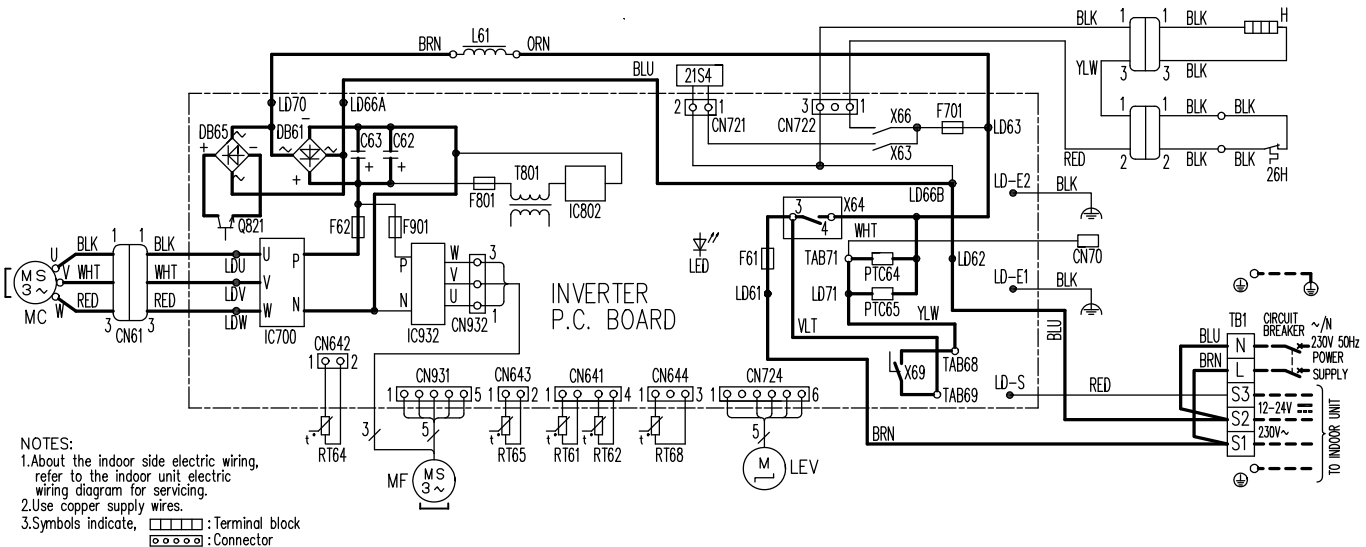

SYMBOL	NAME	SYMBOL	NAME	SYMBOL	NAME
CN61	CONNECTOR	LED	LED	RT64	FIN TEMP. THERMISTOR
C62, C63	SMOOTHING CAPACITOR	LEV	EXPANSION VALVE COIL	RT65	AMBIENT TEMP. THERMISTOR
DB61, DB65	DIODE MODULE	L61	REACTOR	RT68	OUTDOOR HEAT EXCHANGER TEMP. THERMISTOR
F61	FUSE (25A 250V)	MC	COMPRESSOR	TB1	TERMINAL BLOCK
F62	FUSE (15A 250V)	MF	FAN MOTOR	T801	TRANSFORMER
F701, F801, F901	FUSE (T3.15A/250V)	PTC64, PTC65	CIRCUIT PROTECTION	X63, X64, X66, X69	RELAY
H	DEFROST HEATER	Q821	SWITCHING POWER TRANSISTOR	21S4	REVERSING VALVE COIL
IC700, IC932	POWER MODULE	RT61	DEFROST THERMISTOR	26H	HEATER PROTECTOR
IC802	POWER DEVICE	RT62	DISCHARGE TEMP. THERMISTOR		

MUZ-EF42VG - [E1], [ET1]

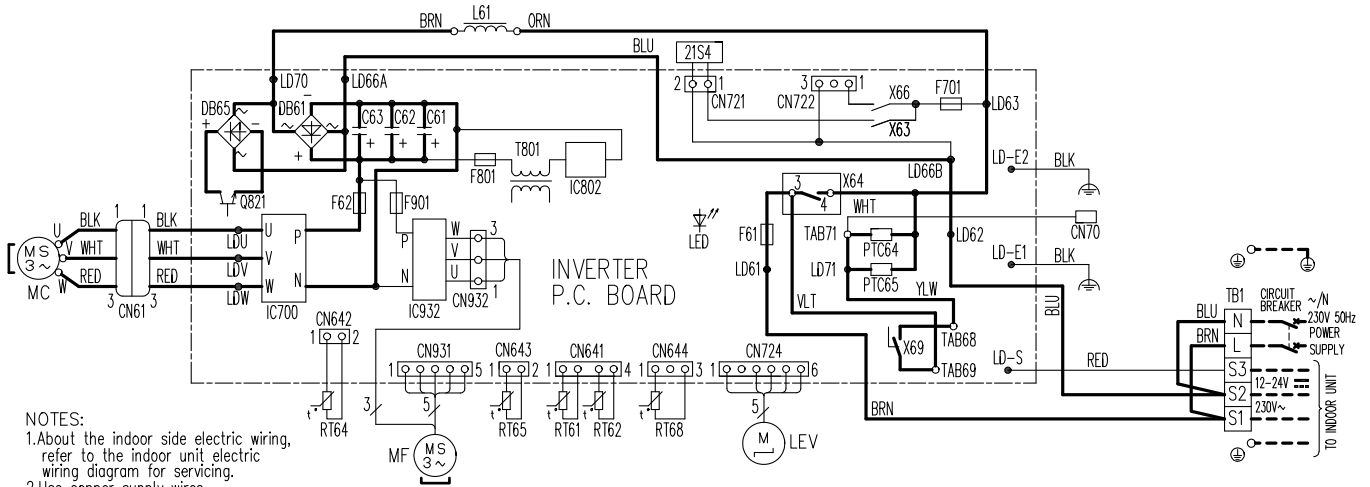

- NOTES:
- About the indoor side electric wiring, refer to the indoor unit electric wiring diagram for servicing.
 - Use copper supply wires.
 - Symbols indicate, : Terminal block
 : Connector

SYMBOL	NAME	SYMBOL	NAME	SYMBOL	NAME
CN61	CONNECTOR	LEV	EXPANSION VALVE COIL	RT65	AMBIENT TEMP. THERMISTOR
C61,C62,C63	SMOOTHING CAPACITOR	L61	REACTOR	RT68	OUTDOOR HEAT EXCHANGER TEMP. THERMISTOR
DB61,DB65	DIODE MODULE	MC	COMPRESSOR	TB1	TERMINAL BLOCK
F61	FUSE (25A 250V)	MF	FAN MOTOR	T801	TRANSFORMER
F62	FUSE (15A 250V)	PTC64,PTC65	CIRCUIT PROTECTION	X63,X64,X66,X69	RELAY
F701,F801,F901	FUSE (T3.15A/250V)	Q821	SWITCHING POWER TRANSISTOR	21S4	REVERSING VALVE COIL
IC700,IC932	POWER MODULE	RT61	DEFROST THERMISTOR		
IC802	POWER DEVICE	RT62	DISCHARGE TEMP. THERMISTOR		
LED	LED	RT64	FIN TEMP. THERMISTOR		

MUZ-EF50VG - [E1], [ET1]

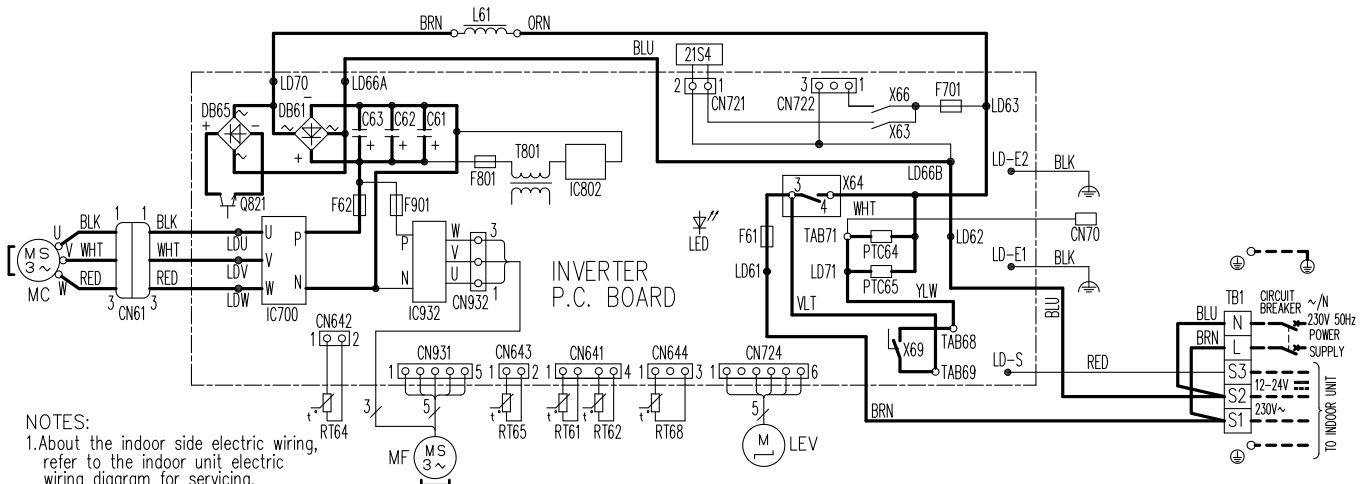

- NOTES:
- About the indoor side electric wiring, refer to the indoor unit electric wiring diagram for servicing.
 - Use copper supply wires.
 - Symbols indicate, : Terminal block
 : Connector

SYMBOL	NAME	SYMBOL	NAME	SYMBOL	NAME
CN61	CONNECTOR	LEV	EXPANSION VALVE COIL	RT65	AMBIENT TEMP. THERMISTOR
C61,C62,C63	SMOOTHING CAPACITOR	L61	REACTOR	RT68	OUTDOOR HEAT EXCHANGER TEMP. THERMISTOR
DB61,DB65	DIODE MODULE	MC	COMPRESSOR	TB1	TERMINAL BLOCK
F61	FUSE (25A 250V)	MF	FAN MOTOR	T801	TRANSFORMER
F62	FUSE (15A 250V)	PTC64,PTC65	CIRCUIT PROTECTION	X63,X64,X66,X69	RELAY
F701,F801,F901	FUSE (T3.15A/250V)	Q821	SWITCHING POWER TRANSISTOR	21S4	REVERSING VALVE COIL
IC700,IC932	POWER MODULE	RT61	DEFROST THERMISTOR		
IC802	POWER DEVICE	RT62	DISCHARGE TEMP. THERMISTOR		
LED	LED	RT64	FIN TEMP. THERMISTOR		

MUZ-EF25VG MUZ-EF35VG
 MUZ-EF25VGH MUZ-EF35VGH

Unit: mm

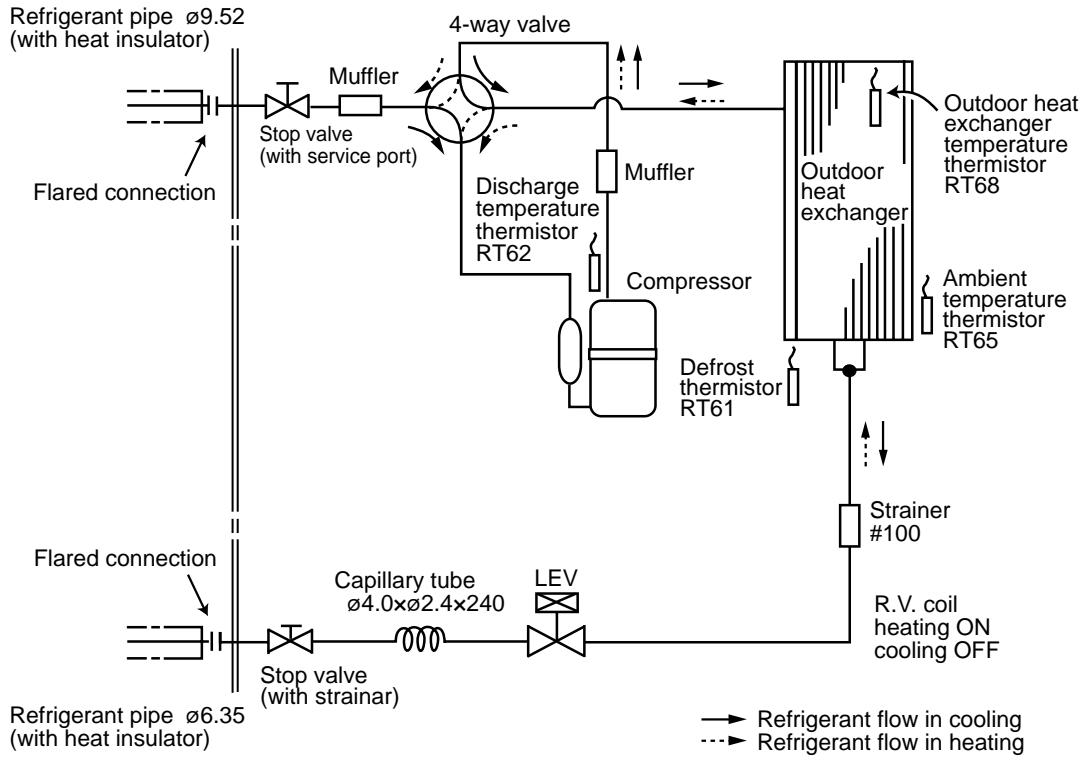

MUZ-EF42VG

Unit: mm

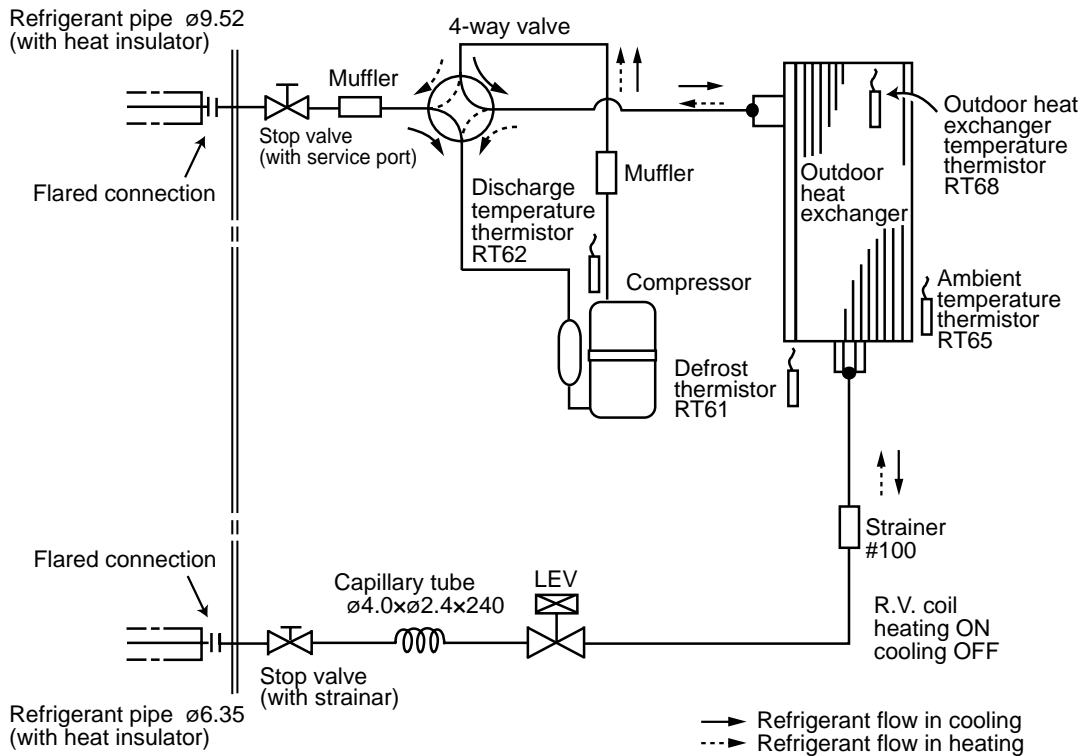



MUZ-EF50VG

Unit: mm

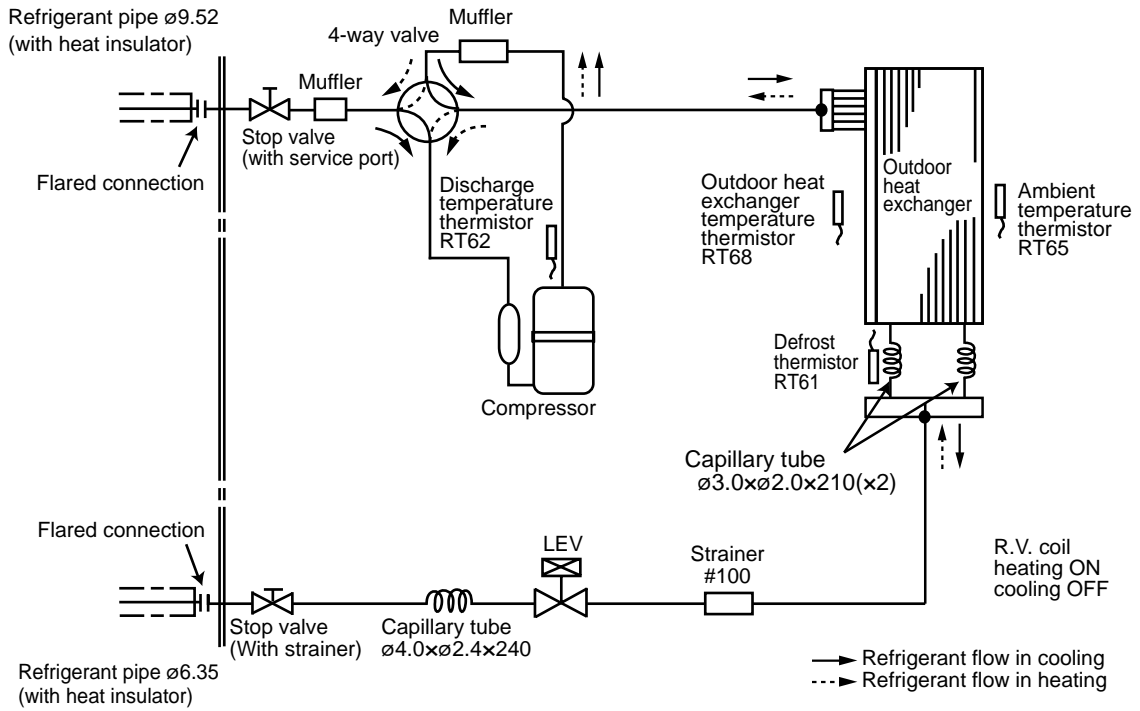

MAX. REFRIGERANT PIPING LENGTH and MAX. HEIGHT DIFFERENCE

Model	Refrigerant piping: m		Piping size O.D: mm	
	Max. Length A	Max. Height difference B	Gas	Liquid
MUZ-EF25/35VG(H) MUZ-EF42VG	20	12	9.52	6.35
MUZ-EF50VG	30	15		

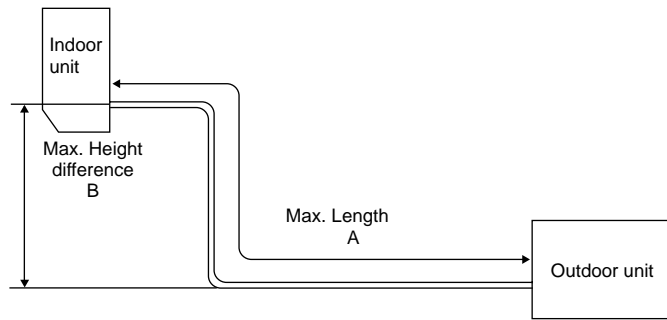

ADDITIONAL REFRIGERANT CHARGE (R32: g)

Model	Outdoor unit precharged	Refrigerant piping length (one way)										
		7 m	8 m	9 m	10 m	11 m	12 m	13 m	14 m	15 m	20 m	30 m
MUZ-EF25VG(H)	620	0	20	40	60	80	100	120	140	160	260	-
MUZ-EF35VG(H)	740											
MUZ-EF42VG	740											
MUZ-EF50VG	1,050											

Calculation: $X \text{ g} = 20 \text{ g/m} \times (\text{Refrigerant piping length (m)} - 7)$

NOTE: Refrigerant piping exceeding 7 m requires additional refrigerant charge according to the calculation.

MUZ-EF25VG MUZ-EF35VG MUZ-EF42VG MUZ-EF50VG
MUZ-EF25VGH MUZ-EF35VGH

The standard specifications apply only to the operation of the air conditioner under normal conditions. Since operating conditions vary according to the areas where these units are installed, the following information has been provided to clarify the operating characteristics of the air conditioner under the conditions indicated by the performance curve.

(1) GUARANTEED VOLTAGE

198 ~ 264 V, 50 Hz

(2) AIR FLOW

Air flow should be set at MAX.

(3) MAIN READINGS

- | | | |
|--|---------|-----------|
| (1) Indoor intake air wet-bulb temperature: | °C [WB] | } Cooling |
| (2) Indoor outlet air wet-bulb temperature: | °C [WB] | |
| (3) Outdoor intake air dry-bulb temperature: | °C [DB] | |
| (4) Total input: | W | } Heating |
| (5) Indoor intake air dry-bulb temperature: | °C [DB] | |
| (6) Outdoor intake air wet-bulb temperature: | °C [WB] | |
| (7) Total input: | W | |

Indoor air wet and dry bulb temperature difference on the left side of the following chart shows the difference between the indoor intake air wet and dry bulb temperature and the indoor outlet air wet and dry bulb temperature for your reference at service.

How to measure the indoor air wet and dry bulb temperature difference

- Attach at least 2 sets of wet and dry bulb thermometers to the indoor air intake as shown in the figure, and at least 2 sets of wet and dry bulb thermometers to the indoor air outlet. The thermometers must be attached to the position where air speed is high.
- Attach at least 2 sets of wet and dry bulb thermometers to the outdoor air intake.
Cover the thermometers to prevent direct rays of the sun.
- Check that the air filter is cleaned.
- Open windows and doors of room.
- Press the EMERGENCY OPERATION switch once (twice) to start the EMERGENCY COOL (HEAT) MODE.
- When system stabilizes after more than 15 minutes, measure temperature and take an average temperature.
- 10 minutes later, measure temperature again and check that the temperature does not change.

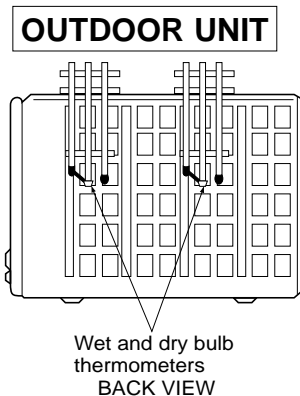
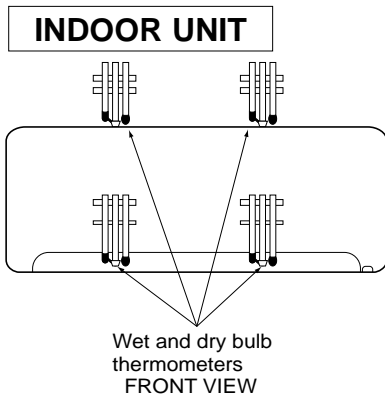

9-1. CAPACITY AND INPUT CURVES

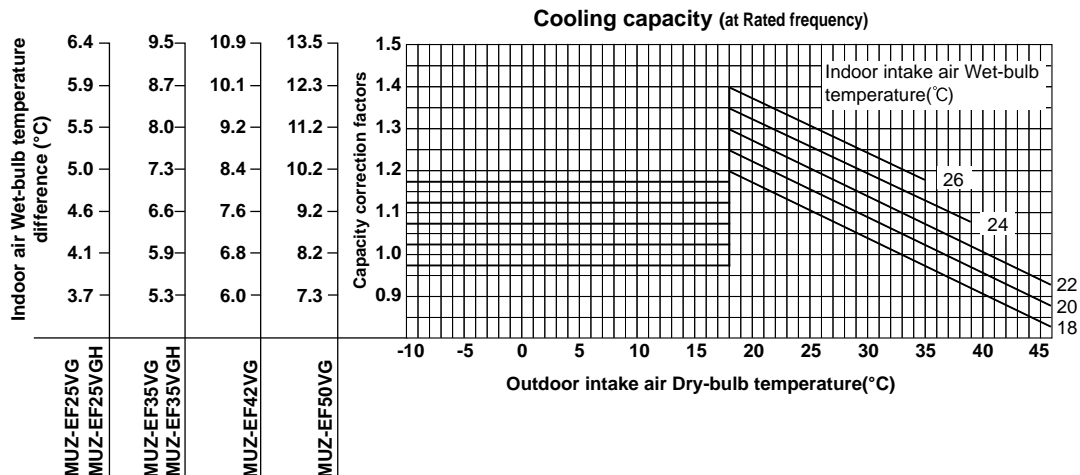

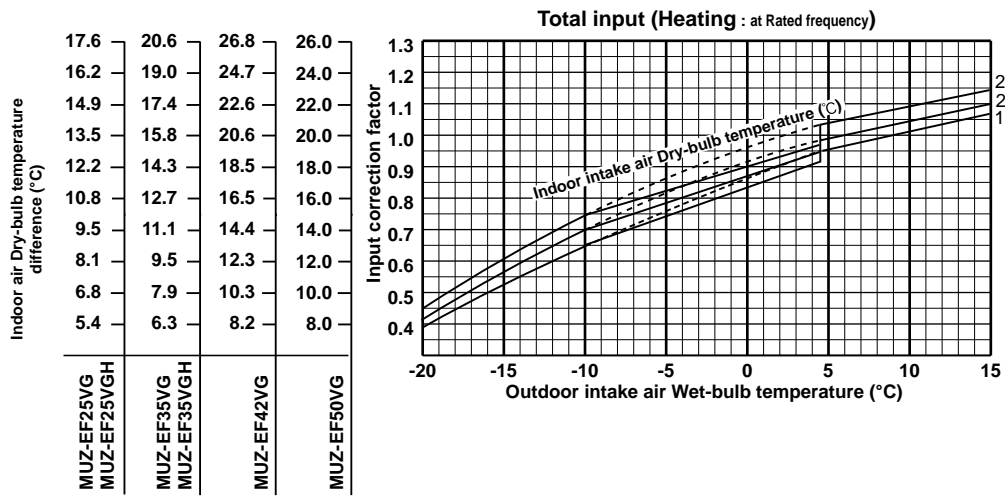
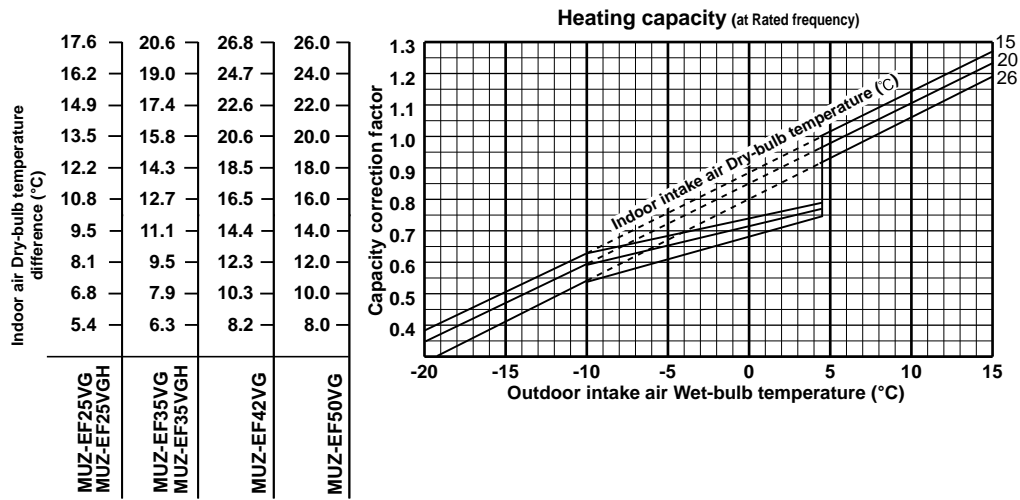
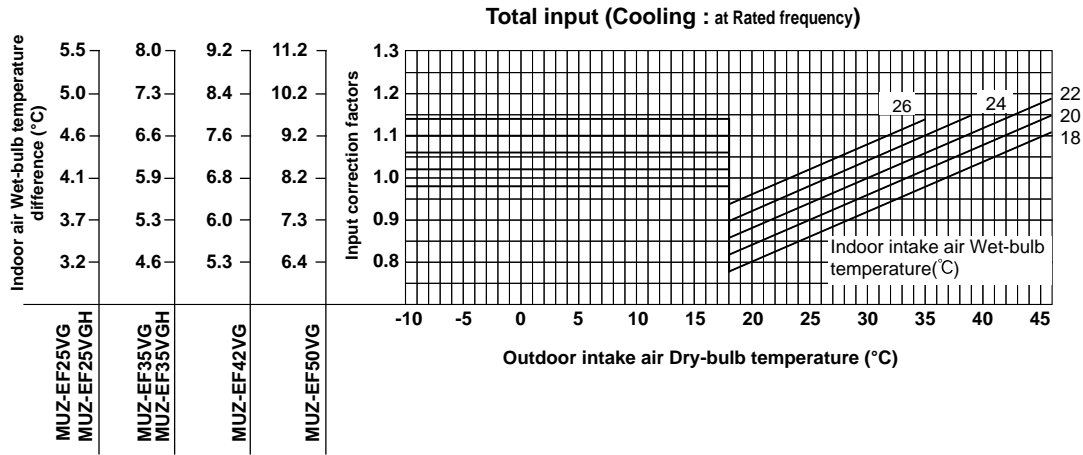

Lower limit of guaranteed operating range in heating
MUZ-EF25/35/42/50VG: -15°C
MUZ-EF25/35VGH: -20°C

NOTE: The above broken lines are for the heating operation without any frost and defrost operation.

9-2. CAPACITY AND INPUT CORRECTION BY OPERATIONAL FREQUENCY OF COMPRESSOR

MUZ-EF25VG MUZ-EF25VGH

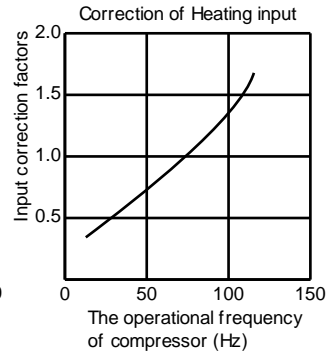
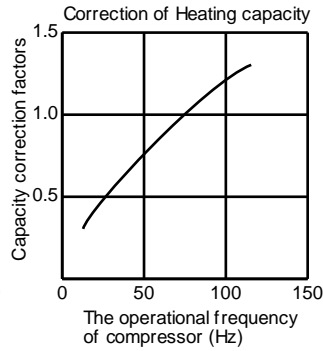
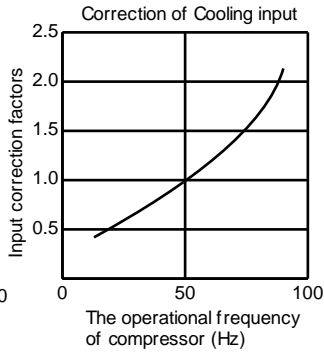
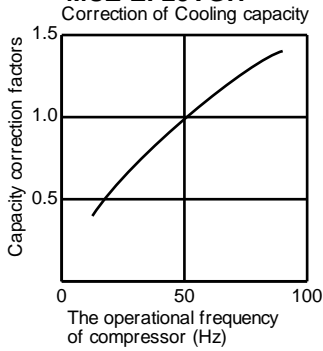

MUZ-EF35VG MUZ-EF35VGH

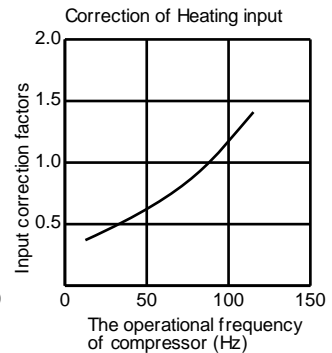
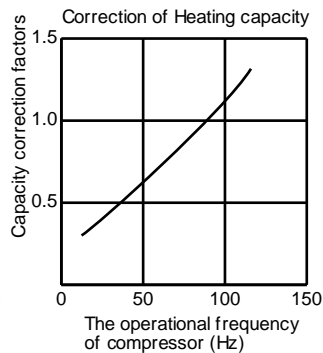
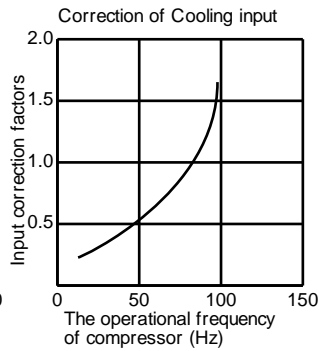
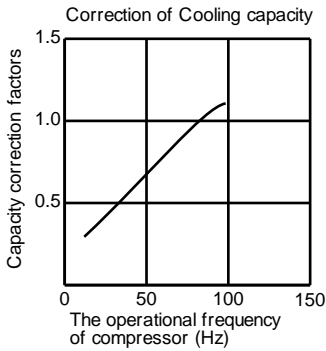

MUZ-EF42VG

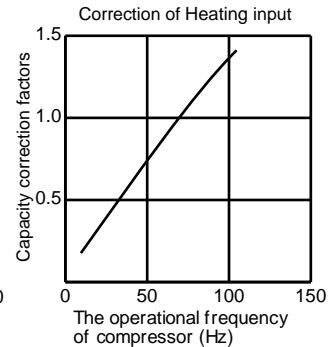
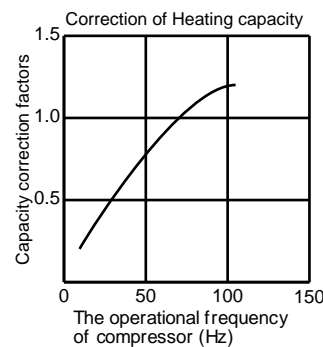
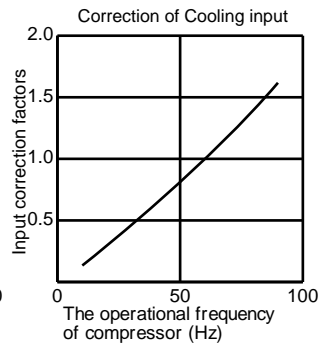
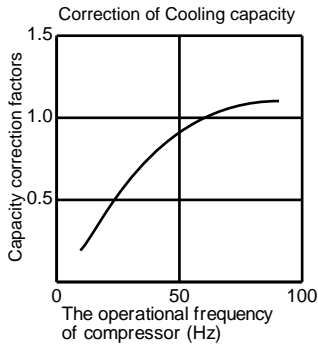

MUZ-EF50VG

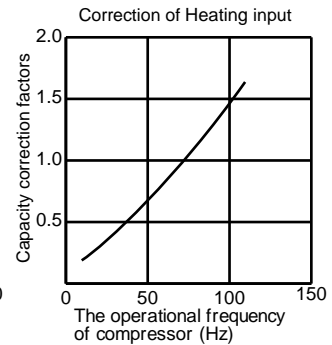
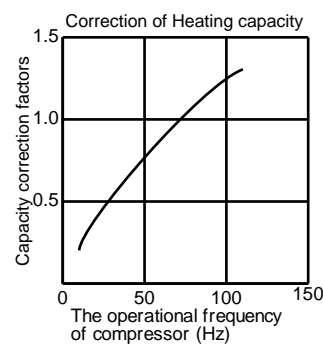
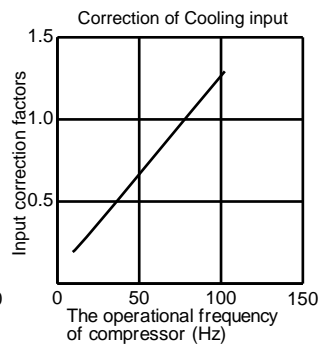
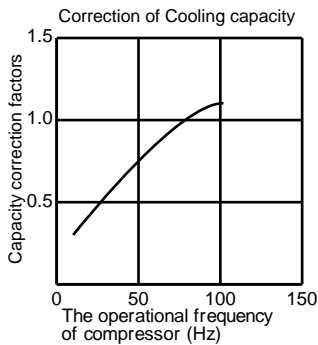

9-3. HOW TO OPERATE FIXED-FREQUENCY OPERATION

<Test run operation>

1. Press EMERGENCY OPERATION switch to start COOL or HEAT mode (COOL: Press once, HEAT: Press twice).
2. Test run operation starts and continues to operate for 30 minutes.
3. Compressor operates at rated frequency in COOL mode or 58 Hz in HEAT mode.
4. Indoor fan operates at High speed.
5. After 30 minutes, test run operation finishes and EMERGENCY OPERATION starts (operation frequency of compressor varies).
6. To cancel test run operation (EMERGENCY OPERATION), press EMERGENCY OPERATION switch or any button on remote controller.

9-4. OUTDOOR LOW PRESSURE AND OUTDOOR UNIT CURRENT

COOL operation

- ① Both indoor and outdoor unit are under the same temperature/humidity condition.
- ② Operation: TEST RUN OPERATION (Refer to 9-3.)

Dry-bulb temperature (°C)	Relative humidity (%)
20	50
25	60
30	70

Outdoor low pressure

**MUZ-EF25VG
MUZ-EF25VGH**

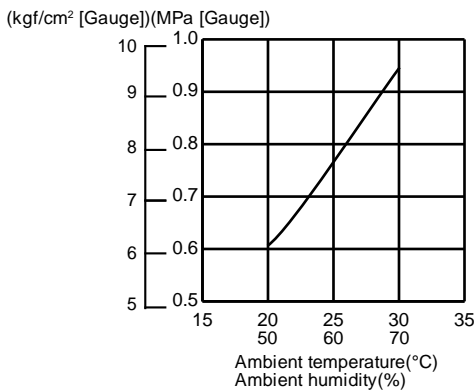

**MUZ-EF35VG
MUZ-EF35VGH**

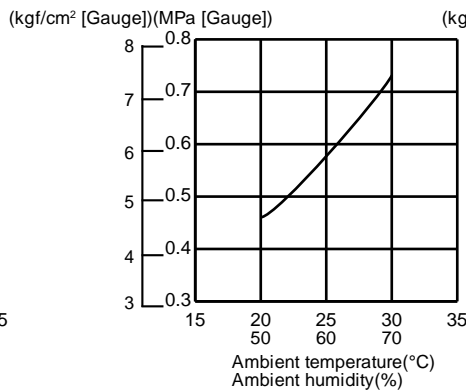

MUZ-EF42VG

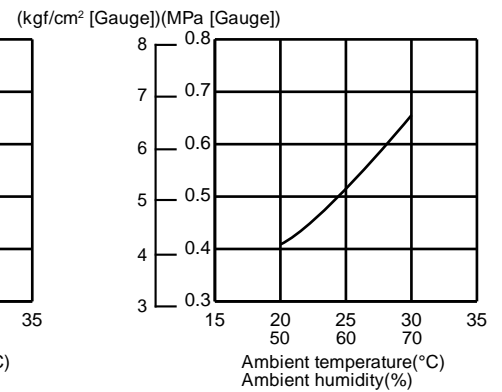

MUZ-EF50VG

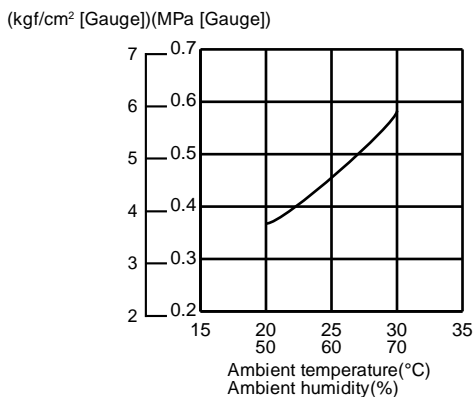

NOTE:

The unit of pressure has been changed to MPa on the international system of units (SI unit system)
The conversion factor is: **1 (MPa [Gauge]) = 10.2 (kgf/cm² [Gauge])**

Outdoor unit current

**MUZ-EF25VG
MUZ-EF25VGH**

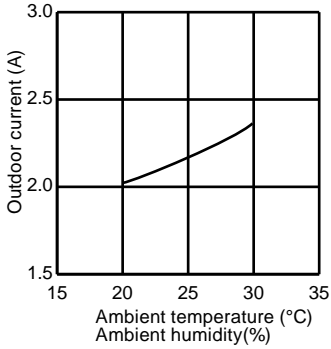

**MUZ-EF35VG
MUZ-EF35VGH**

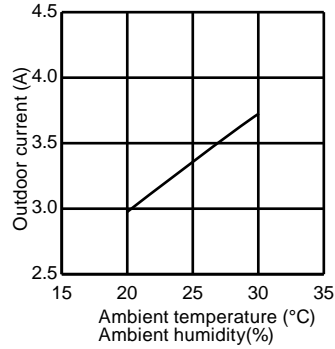

MUZ-EF42VG

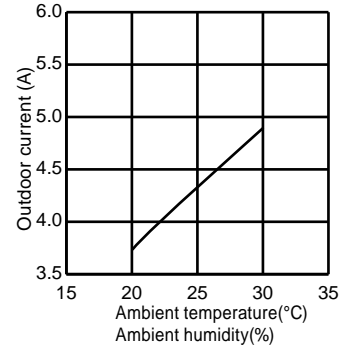

MUZ-EF50VG

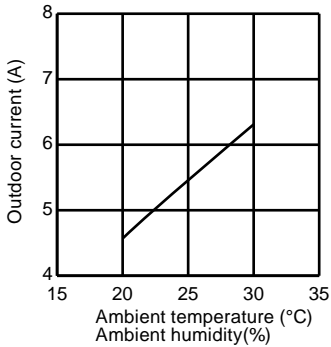

HEAT operation

① Condition:

	Indoor	Outdoor			
Dry bulb temperature (°C)	20.0	2	7	15	20.0
Wet bulb temperature (°C)	14.5	1	6	12	14.5

② Operation: Test run operation (Refer to 9-3.)

Outdoor unit current

**MUZ-EF25VG
MUZ-EF25VGH**

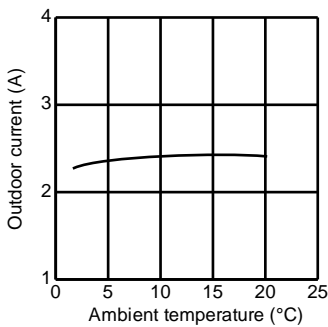

**MUZ-EF35VG
MUZ-EF35VGH**

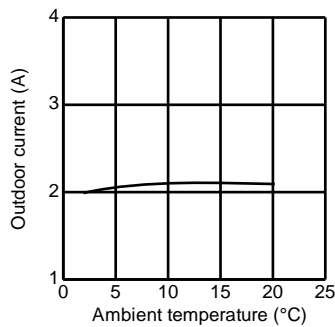

MUZ-EF42VG

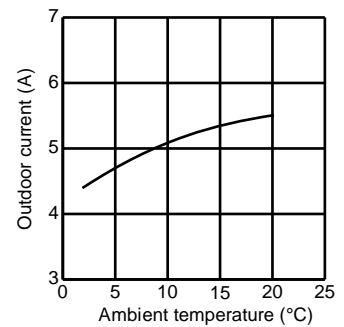

MUZ-EF50VG

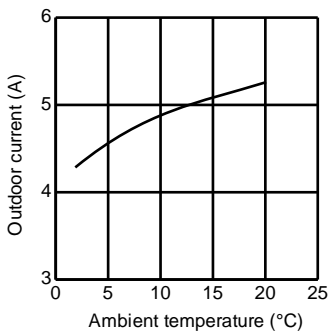

PERFORMANCE DATA COOL operation at Rated frequency

MUZ-EF25VG

MUZ-EF25VGH

CAPACITY: 2.5 kW

SHF: 0.97

INPUT: 540 W

INDOOR DB (°C)	INDOOR WB (°C)	OUTDOOR DB (°C)											
		35				40				46			
		Q	SHC	SHF	INPUT	Q	SHC	SHF	INPUT	Q	SHC	SHF	INPUT
21	18	2.45	1.94	0.79	529	2.25	1.78	0.79	562	2.08	1.64	0.79	583
21	20	2.58	1.73	0.67	551	2.40	1.61	0.67	578	2.23	1.49	0.67	610
22	18	2.45	2.03	0.83	529	2.25	1.87	0.83	562	2.08	1.72	0.83	583
22	20	2.58	1.83	0.71	551	2.40	1.70	0.71	578	2.23	1.58	0.71	610
22	22	2.73	1.61	0.59	572	2.55	1.50	0.59	605	2.38	1.40	0.59	626
23	18	2.45	2.13	0.87	529	2.25	1.96	0.87	562	2.08	1.81	0.87	583
23	20	2.58	1.93	0.75	551	2.40	1.80	0.75	578	2.23	1.67	0.75	610
23	22	2.73	1.72	0.63	572	2.55	1.61	0.63	605	2.38	1.50	0.63	626
24	18	2.45	2.23	0.91	529	2.25	2.05	0.91	562	2.08	1.89	0.91	583
24	20	2.58	2.03	0.79	551	2.40	1.90	0.79	578	2.23	1.76	0.79	610
24	22	2.73	1.83	0.67	572	2.55	1.71	0.67	605	2.38	1.59	0.67	626
24	24	2.88	1.58	0.55	594	2.70	1.49	0.55	621	2.55	1.40	0.55	648
25	18	2.45	2.33	0.95	529	2.25	2.14	0.95	562	2.08	1.97	0.95	583
25	20	2.58	2.14	0.83	551	2.40	1.99	0.83	578	2.23	1.85	0.83	610
25	22	2.73	1.93	0.71	572	2.55	1.81	0.71	605	2.38	1.69	0.71	626
25	24	2.88	1.70	0.59	594	2.70	1.59	0.59	621	2.55	1.50	0.59	648
26	18	2.45	2.43	0.99	529	2.25	2.23	0.99	562	2.08	2.05	0.99	583
26	20	2.58	2.24	0.87	551	2.40	2.09	0.87	578	2.23	1.94	0.87	610
26	22	2.73	2.04	0.75	572	2.55	1.91	0.75	605	2.38	1.78	0.75	626
26	24	2.88	1.81	0.63	594	2.70	1.70	0.63	621	2.55	1.61	0.63	648
26	26	3.03	1.54	0.51	616	2.85	1.45	0.51	643	2.68	1.36	0.51	670
27	18	2.45	2.45	1.00	529	2.25	2.25	1.00	562	2.08	2.08	1.00	583
27	20	2.58	2.34	0.91	551	2.40	2.18	0.91	578	2.23	2.02	0.91	610
27	22	2.73	2.15	0.79	572	2.55	2.01	0.79	605	2.38	1.88	0.79	626
27	24	2.88	1.93	0.67	594	2.70	1.81	0.67	621	2.55	1.71	0.67	648
27	26	3.03	1.66	0.55	616	2.85	1.57	0.55	643	2.68	1.47	0.55	670
28	18	2.45	2.45	1.00	529	2.25	2.25	1.00	562	2.08	2.08	1.00	583
28	20	2.58	2.45	0.95	551	2.40	2.28	0.95	578	2.23	2.11	0.95	610
28	22	2.73	2.26	0.83	572	2.55	2.12	0.83	605	2.38	1.97	0.83	626
28	24	2.88	2.04	0.71	594	2.70	1.92	0.71	621	2.55	1.81	0.71	648
28	26	3.03	1.78	0.59	616	2.85	1.68	0.59	643	2.68	1.58	0.59	670
29	18	2.45	2.45	1.00	529	2.25	2.25	1.00	562	2.08	2.08	1.00	583
29	20	2.58	2.55	0.99	551	2.40	2.38	0.99	578	2.23	2.20	0.99	610
29	22	2.73	2.37	0.87	572	2.55	2.22	0.87	605	2.38	2.07	0.87	626
29	24	2.88	2.16	0.75	594	2.70	2.03	0.75	621	2.55	1.91	0.75	648
29	26	3.03	1.91	0.63	616	2.85	1.80	0.63	643	2.68	1.69	0.63	670
30	18	2.45	2.45	1.00	529	2.25	2.25	1.00	562	2.08	2.08	1.00	583
30	20	2.58	2.58	1.00	551	2.40	2.40	1.00	578	2.23	2.23	1.00	610
30	22	2.73	2.48	0.91	572	2.55	2.32	0.91	605	2.38	2.16	0.91	626
30	24	2.88	2.27	0.79	594	2.70	2.13	0.79	621	2.55	2.01	0.79	648
30	26	3.03	2.03	0.67	616	2.85	1.91	0.67	643	2.68	1.79	0.67	670
31	18	2.45	2.45	1.00	529	2.25	2.25	1.00	562	2.08	2.08	1.00	583
31	20	2.58	2.58	1.00	551	2.40	2.40	1.00	578	2.23	2.23	1.00	610
31	22	2.73	2.59	0.95	572	2.55	2.42	0.95	605	2.38	2.26	0.95	626
31	24	2.88	2.39	0.83	594	2.70	2.24	0.83	621	2.55	2.12	0.83	648
31	26	3.03	2.15	0.71	616	2.85	2.02	0.71	643	2.68	1.90	0.71	670
32	18	2.45	2.45	1.00	529	2.25	2.25	1.00	562	2.08	2.08	1.00	583
32	20	2.58	2.58	1.00	551	2.40	2.40	1.00	578	2.23	2.23	1.00	610
32	22	2.73	2.70	0.99	572	2.55	2.52	0.99	605	2.38	2.35	0.99	626
32	24	2.88	2.50	0.87	594	2.70	2.35	0.87	621	2.55	2.22	0.87	648
32	26	3.03	2.27	0.75	616	2.85	2.14	0.75	643	2.68	2.01	0.75	670

NOTE Q : Total capacity (kW) SHF : Sensible heat factor DB : Dry-bulb temperature
 SHC : Sensible heat capacity (kW) INPUT : Total power input (W) WB : Wet-bulb temperature

PERFORMANCE DATA COOL operation at Rated frequency

**MUZ-EF35VG
MUZ-EF35VGH**

CAPACITY: 3.5 kW

SHF: 0.8

INPUT: 910 W

INDOOR DB (°C)	INDOOR WB (°C)	OUTDOOR DB (°C)											
		35				40				46			
		Q	SHC	SHF	INPUT	Q	SHC	SHF	INPUT	Q	SHC	SHF	INPUT
21	18	3.43	2.13	0.62	892	3.15	1.95	0.62	946	2.91	1.80	0.62	983
21	20	3.61	1.80	0.50	928	3.36	1.68	0.50	974	3.12	1.56	0.50	1028
22	18	3.43	2.26	0.66	892	3.15	2.08	0.66	946	2.91	1.92	0.66	983
22	20	3.61	1.95	0.54	928	3.36	1.81	0.54	974	3.12	1.68	0.54	1028
22	22	3.82	1.60	0.42	965	3.57	1.50	0.42	1019	3.33	1.40	0.42	1056
23	18	3.43	2.40	0.70	892	3.15	2.21	0.70	946	2.91	2.03	0.70	983
23	20	3.61	2.09	0.58	928	3.36	1.95	0.58	974	3.12	1.81	0.58	1028
23	22	3.82	1.75	0.46	965	3.57	1.64	0.46	1019	3.33	1.53	0.46	1056
24	18	3.43	2.54	0.74	892	3.15	2.33	0.74	946	2.91	2.15	0.74	983
24	20	3.61	2.24	0.62	928	3.36	2.08	0.62	974	3.12	1.93	0.62	1028
24	22	3.82	1.91	0.50	965	3.57	1.79	0.50	1019	3.33	1.66	0.50	1056
24	24	4.03	1.53	0.38	1001	3.78	1.44	0.38	1047	3.57	1.36	0.38	1092
25	18	3.43	2.68	0.78	892	3.15	2.46	0.78	946	2.91	2.27	0.78	983
25	20	3.61	2.38	0.66	928	3.36	2.22	0.66	974	3.12	2.06	0.66	1028
25	22	3.82	2.06	0.54	965	3.57	1.93	0.54	1019	3.33	1.80	0.54	1056
25	24	4.03	1.69	0.42	1001	3.78	1.59	0.42	1047	3.57	1.50	0.42	1092
26	18	3.43	2.81	0.82	892	3.15	2.58	0.82	946	2.91	2.38	0.82	983
26	20	3.61	2.52	0.70	928	3.36	2.35	0.70	974	3.12	2.18	0.70	1028
26	22	3.82	2.21	0.58	965	3.57	2.07	0.58	1019	3.33	1.93	0.58	1056
26	24	4.03	1.85	0.46	1001	3.78	1.74	0.46	1047	3.57	1.64	0.46	1092
26	26	4.24	1.44	0.34	1037	3.99	1.36	0.34	1083	3.75	1.27	0.34	1128
27	18	3.43	2.95	0.86	892	3.15	2.71	0.86	946	2.91	2.50	0.86	983
27	20	3.61	2.67	0.74	928	3.36	2.49	0.74	974	3.12	2.31	0.74	1028
27	22	3.82	2.37	0.62	965	3.57	2.21	0.62	1019	3.33	2.06	0.62	1056
27	24	4.03	2.01	0.50	1001	3.78	1.89	0.50	1047	3.57	1.79	0.50	1092
27	26	4.24	1.61	0.38	1037	3.99	1.52	0.38	1083	3.75	1.42	0.38	1128
28	18	3.43	3.09	0.90	892	3.15	2.84	0.90	946	2.91	2.61	0.90	983
28	20	3.61	2.81	0.78	928	3.36	2.62	0.78	974	3.12	2.43	0.78	1028
28	22	3.82	2.52	0.66	965	3.57	2.36	0.66	1019	3.33	2.19	0.66	1056
28	24	4.03	2.17	0.54	1001	3.78	2.04	0.54	1047	3.57	1.93	0.54	1092
28	26	4.24	1.78	0.42	1037	3.99	1.68	0.42	1083	3.75	1.57	0.42	1128
29	18	3.43	3.22	0.94	892	3.15	2.96	0.94	946	2.91	2.73	0.94	983
29	20	3.61	2.96	0.82	928	3.36	2.76	0.82	974	3.12	2.55	0.82	1028
29	22	3.82	2.67	0.70	965	3.57	2.50	0.70	1019	3.33	2.33	0.70	1056
29	24	4.03	2.33	0.58	1001	3.78	2.19	0.58	1047	3.57	2.07	0.58	1092
29	26	4.24	1.95	0.46	1037	3.99	1.84	0.46	1083	3.75	1.72	0.46	1128
30	18	3.43	3.36	0.98	892	3.15	3.09	0.98	946	2.91	2.85	0.98	983
30	20	3.61	3.10	0.86	928	3.36	2.89	0.86	974	3.12	2.68	0.86	1028
30	22	3.82	2.82	0.74	965	3.57	2.64	0.74	1019	3.33	2.46	0.74	1056
30	24	4.03	2.50	0.62	1001	3.78	2.34	0.62	1047	3.57	2.21	0.62	1092
30	26	4.24	2.12	0.50	1037	3.99	2.00	0.50	1083	3.75	1.87	0.50	1128
31	18	3.43	3.43	1.00	892	3.15	3.15	1.00	946	2.91	2.91	1.00	983
31	20	3.61	3.24	0.90	928	3.36	3.02	0.90	974	3.12	2.80	0.90	1028
31	22	3.82	2.98	0.78	965	3.57	2.78	0.78	1019	3.33	2.59	0.78	1056
31	24	4.03	2.66	0.66	1001	3.78	2.49	0.66	1047	3.57	2.36	0.66	1092
31	26	4.24	2.29	0.54	1037	3.99	2.15	0.54	1083	3.75	2.02	0.54	1128
32	18	3.43	3.43	1.00	892	3.15	3.15	1.00	946	2.91	2.91	1.00	983
32	20	3.61	3.39	0.94	928	3.36	3.16	0.94	974	3.12	2.93	0.94	1028
32	22	3.82	3.13	0.82	965	3.57	2.93	0.82	1019	3.33	2.73	0.82	1056
32	24	4.03	2.82	0.70	1001	3.78	2.65	0.70	1047	3.57	2.50	0.70	1092
32	26	4.24	2.46	0.58	1037	3.99	2.31	0.58	1083	3.75	2.17	0.58	1128

NOTE Q : Total capacity (kW) SHF : Sensible heat factor DB : Dry-bulb temperature
SHC : Sensible heat capacity (kW) INPUT : Total power input (W) WB : Wet-bulb temperature

PERFORMANCE DATA COOL operation at Rated frequency
MUZ-EF42VG

CAPACITY: 4.2 kW SHF: 0.74 INPUT: 1200 W

INDOOR DB (°C)	INDOOR WB (°C)	OUTDOOR DB (°C)											
		35				40				46			
		Q	SHC	SHF	INPUT	Q	SHC	SHF	INPUT	Q	SHC	SHF	INPUT
21	18	4.12	2.30	0.56	1176	3.78	2.12	0.56	1248	3.49	1.95	0.56	1296
21	20	4.33	1.90	0.44	1224	4.03	1.77	0.44	1284	3.74	1.64	0.44	1356
22	18	4.12	2.47	0.60	1176	3.78	2.27	0.60	1248	3.49	2.09	0.60	1296
22	20	4.33	2.08	0.48	1224	4.03	1.94	0.48	1284	3.74	1.79	0.48	1356
22	22	4.58	1.65	0.36	1272	4.28	1.54	0.36	1344	3.99	1.44	0.36	1392
23	18	4.12	2.63	0.64	1176	3.78	2.42	0.64	1248	3.49	2.23	0.64	1296
23	20	4.33	2.25	0.52	1224	4.03	2.10	0.52	1284	3.74	1.94	0.52	1356
23	22	4.58	1.83	0.40	1272	4.28	1.71	0.40	1344	3.99	1.60	0.40	1392
24	18	4.12	2.80	0.68	1176	3.78	2.57	0.68	1248	3.49	2.37	0.68	1296
24	20	4.33	2.42	0.56	1224	4.03	2.26	0.56	1284	3.74	2.09	0.56	1356
24	22	4.58	2.01	0.44	1272	4.28	1.88	0.44	1344	3.99	1.76	0.44	1392
24	24	4.83	1.55	0.32	1320	4.54	1.45	0.32	1380	4.28	1.37	0.32	1440
25	18	4.12	2.96	0.72	1176	3.78	2.72	0.72	1248	3.49	2.51	0.72	1296
25	20	4.33	2.60	0.60	1224	4.03	2.42	0.60	1284	3.74	2.24	0.60	1356
25	22	4.58	2.20	0.48	1272	4.28	2.06	0.48	1344	3.99	1.92	0.48	1392
25	24	4.83	1.74	0.36	1320	4.54	1.63	0.36	1380	4.28	1.54	0.36	1440
26	18	4.12	3.13	0.76	1176	3.78	2.87	0.76	1248	3.49	2.65	0.76	1296
26	20	4.33	2.77	0.64	1224	4.03	2.58	0.64	1284	3.74	2.39	0.64	1356
26	22	4.58	2.38	0.52	1272	4.28	2.23	0.52	1344	3.99	2.07	0.52	1392
26	24	4.83	1.93	0.40	1320	4.54	1.81	0.40	1380	4.28	1.71	0.40	1440
26	26	5.08	1.42	0.28	1368	4.79	1.34	0.28	1428	4.49	1.26	0.28	1488
27	18	4.12	3.29	0.80	1176	3.78	3.02	0.80	1248	3.49	2.79	0.80	1296
27	20	4.33	2.94	0.68	1224	4.03	2.74	0.68	1284	3.74	2.54	0.68	1356
27	22	4.58	2.56	0.56	1272	4.28	2.40	0.56	1344	3.99	2.23	0.56	1392
27	24	4.83	2.13	0.44	1320	4.54	2.00	0.44	1380	4.28	1.88	0.44	1440
27	26	5.08	1.63	0.32	1368	4.79	1.53	0.32	1428	4.49	1.44	0.32	1488
28	18	4.12	3.46	0.84	1176	3.78	3.18	0.84	1248	3.49	2.93	0.84	1296
28	20	4.33	3.11	0.72	1224	4.03	2.90	0.72	1284	3.74	2.69	0.72	1356
28	22	4.58	2.75	0.60	1272	4.28	2.57	0.60	1344	3.99	2.39	0.60	1392
28	24	4.83	2.32	0.48	1320	4.54	2.18	0.48	1380	4.28	2.06	0.48	1440
28	26	5.08	1.83	0.36	1368	4.79	1.72	0.36	1428	4.49	1.62	0.36	1488
29	18	4.12	3.62	0.88	1176	3.78	3.33	0.88	1248	3.49	3.07	0.88	1296
29	20	4.33	3.29	0.76	1224	4.03	3.06	0.76	1284	3.74	2.84	0.76	1356
29	22	4.58	2.93	0.64	1272	4.28	2.74	0.64	1344	3.99	2.55	0.64	1392
29	24	4.83	2.51	0.52	1320	4.54	2.36	0.52	1380	4.28	2.23	0.52	1440
29	26	5.08	2.03	0.40	1368	4.79	1.92	0.40	1428	4.49	1.80	0.40	1488
30	18	4.12	3.79	0.92	1176	3.78	3.48	0.92	1248	3.49	3.21	0.92	1296
30	20	4.33	3.46	0.80	1224	4.03	3.23	0.80	1284	3.74	2.99	0.80	1356
30	22	4.58	3.11	0.68	1272	4.28	2.91	0.68	1344	3.99	2.71	0.68	1392
30	24	4.83	2.70	0.56	1320	4.54	2.54	0.56	1380	4.28	2.40	0.56	1440
30	26	5.08	2.24	0.44	1368	4.79	2.11	0.44	1428	4.49	1.98	0.44	1488
31	18	4.12	3.95	0.96	1176	3.78	3.63	0.96	1248	3.49	3.35	0.96	1296
31	20	4.33	3.63	0.84	1224	4.03	3.39	0.84	1284	3.74	3.14	0.84	1356
31	22	4.58	3.30	0.72	1272	4.28	3.08	0.72	1344	3.99	2.87	0.72	1392
31	24	4.83	2.90	0.60	1320	4.54	2.72	0.60	1380	4.28	2.57	0.60	1440
31	26	5.08	2.44	0.48	1368	4.79	2.30	0.48	1428	4.49	2.16	0.48	1488
32	18	4.12	4.12	1.00	1176	3.78	3.78	1.00	1248	3.49	3.49	1.00	1296
32	20	4.33	3.81	0.88	1224	4.03	3.55	0.88	1284	3.74	3.29	0.88	1356
32	22	4.58	3.48	0.76	1272	4.28	3.26	0.76	1344	3.99	3.03	0.76	1392
32	24	4.83	3.09	0.64	1320	4.54	2.90	0.64	1380	4.28	2.74	0.64	1440
32	26	5.08	2.64	0.52	1368	4.79	2.49	0.52	1428	4.49	2.34	0.52	1488

NOTE Q : Total capacity (kW) SHF : Sensible heat factor DB : Dry-bulb temperature
 SHC : Sensible heat capacity (kW) INPUT : Total power input (W) WB : Wet-bulb temperature

PERFORMANCE DATA COOL operation at Rated frequency
MUZ-EF50VG

CAPACITY: 5.0 kW SHF: 0.7 INPUT: 1540 W

INDOOR DB (°C)	INDOOR WB (°C)	OUTDOOR DB (°C)											
		35				40				46			
		Q	SHC	SHF	INPUT	Q	SHC	SHF	INPUT	Q	SHC	SHF	INPUT
21	18	4.90	2.55	0.52	1509	4.50	2.34	0.52	1602	4.15	2.16	0.52	1663
21	20	5.15	2.06	0.40	1571	4.80	1.92	0.40	1648	4.45	1.78	0.40	1740
22	18	4.90	2.74	0.56	1509	4.50	2.52	0.56	1602	4.15	2.32	0.56	1663
22	20	5.15	2.27	0.44	1571	4.80	2.11	0.44	1648	4.45	1.96	0.44	1740
22	22	5.45	1.74	0.32	1632	5.10	1.63	0.32	1725	4.75	1.52	0.32	1786
23	18	4.90	2.94	0.60	1509	4.50	2.70	0.60	1602	4.15	2.49	0.60	1663
23	20	5.15	2.47	0.48	1571	4.80	2.30	0.48	1648	4.45	2.14	0.48	1740
23	22	5.45	1.96	0.36	1632	5.10	1.84	0.36	1725	4.75	1.71	0.36	1786
24	18	4.90	3.14	0.64	1509	4.50	2.88	0.64	1602	4.15	2.66	0.64	1663
24	20	5.15	2.68	0.52	1571	4.80	2.50	0.52	1648	4.45	2.31	0.52	1740
24	22	5.45	2.18	0.40	1632	5.10	2.04	0.40	1725	4.75	1.90	0.40	1786
24	24	5.75	1.61	0.28	1694	5.40	1.51	0.28	1771	5.10	1.43	0.28	1848
25	18	4.90	3.33	0.68	1509	4.50	3.06	0.68	1602	4.15	2.82	0.68	1663
25	20	5.15	2.88	0.56	1571	4.80	2.69	0.56	1648	4.45	2.49	0.56	1740
25	22	5.45	2.40	0.44	1632	5.10	2.24	0.44	1725	4.75	2.09	0.44	1786
25	24	5.75	1.84	0.32	1694	5.40	1.73	0.32	1771	5.10	1.63	0.32	1848
26	18	4.90	3.53	0.72	1509	4.50	3.24	0.72	1602	4.15	2.99	0.72	1663
26	20	5.15	3.09	0.60	1571	4.80	2.88	0.60	1648	4.45	2.67	0.60	1740
26	22	5.45	2.62	0.48	1632	5.10	2.45	0.48	1725	4.75	2.28	0.48	1786
26	24	5.75	2.07	0.36	1694	5.40	1.94	0.36	1771	5.10	1.84	0.36	1848
26	26	6.05	1.45	0.24	1756	5.70	1.37	0.24	1833	5.35	1.28	0.24	1910
27	18	4.90	3.72	0.76	1509	4.50	3.42	0.76	1602	4.15	3.15	0.76	1663
27	20	5.15	3.30	0.64	1571	4.80	3.07	0.64	1648	4.45	2.85	0.64	1740
27	22	5.45	2.83	0.52	1632	5.10	2.65	0.52	1725	4.75	2.47	0.52	1786
27	24	5.75	2.30	0.40	1694	5.40	2.16	0.40	1771	5.10	2.04	0.40	1848
27	26	6.05	1.69	0.28	1756	5.70	1.60	0.28	1833	5.35	1.50	0.28	1910
28	18	4.90	3.92	0.80	1509	4.50	3.60	0.80	1602	4.15	3.32	0.80	1663
28	20	5.15	3.50	0.68	1571	4.80	3.26	0.68	1648	4.45	3.03	0.68	1740
28	22	5.45	3.05	0.56	1632	5.10	2.86	0.56	1725	4.75	2.66	0.56	1786
28	24	5.75	2.53	0.44	1694	5.40	2.38	0.44	1771	5.10	2.24	0.44	1848
28	26	6.05	1.94	0.32	1756	5.70	1.82	0.32	1833	5.35	1.71	0.32	1910
29	18	4.90	4.12	0.84	1509	4.50	3.78	0.84	1602	4.15	3.49	0.84	1663
29	20	5.15	3.71	0.72	1571	4.80	3.46	0.72	1648	4.45	3.20	0.72	1740
29	22	5.45	3.27	0.60	1632	5.10	3.06	0.60	1725	4.75	2.85	0.60	1786
29	24	5.75	2.76	0.48	1694	5.40	2.59	0.48	1771	5.10	2.45	0.48	1848
29	26	6.05	2.18	0.36	1756	5.70	2.05	0.36	1833	5.35	1.93	0.36	1910
30	18	4.90	4.31	0.88	1509	4.50	3.96	0.88	1602	4.15	3.65	0.88	1663
30	20	5.15	3.91	0.76	1571	4.80	3.65	0.76	1648	4.45	3.38	0.76	1740
30	22	5.45	3.49	0.64	1632	5.10	3.26	0.64	1725	4.75	3.04	0.64	1786
30	24	5.75	2.99	0.52	1694	5.40	2.81	0.52	1771	5.10	2.65	0.52	1848
30	26	6.05	2.42	0.40	1756	5.70	2.28	0.40	1833	5.35	2.14	0.40	1910
31	18	4.90	4.51	0.92	1509	4.50	4.14	0.92	1602	4.15	3.82	0.92	1663
31	20	5.15	4.12	0.80	1571	4.80	3.84	0.80	1648	4.45	3.56	0.80	1740
31	22	5.45	3.71	0.68	1632	5.10	3.47	0.68	1725	4.75	3.23	0.68	1786
31	24	5.75	3.22	0.56	1694	5.40	3.02	0.56	1771	5.10	2.86	0.56	1848
31	26	6.05	2.66	0.44	1756	5.70	2.51	0.44	1833	5.35	2.35	0.44	1910
32	18	4.90	4.70	0.96	1509	4.50	4.32	0.96	1602	4.15	3.98	0.96	1663
32	20	5.15	4.33	0.84	1571	4.80	4.03	0.84	1648	4.45	3.74	0.84	1740
32	22	5.45	3.92	0.72	1632	5.10	3.67	0.72	1725	4.75	3.42	0.72	1786
32	24	5.75	3.45	0.60	1694	5.40	3.24	0.60	1771	5.10	3.06	0.60	1848
32	26	6.05	2.90	0.48	1756	5.70	2.74	0.48	1833	5.35	2.57	0.48	1910

NOTE Q : Total capacity (kW) SHF : Sensible heat factor DB : Dry-bulb temperature
 SHC : Sensible heat capacity (kW) INPUT : Total power input (W) WB : Wet-bulb temperature

PERFORMANCE DATA HEAT operation at Rated frequency
MUZ-EF25VG
MUZ-EF25VGH

CAPACITY: 3.2 kW INPUT: 700 W

INDOOR DB (°C)	OUTDOOR WB (°C)													
	-10		-5		0		5		10		15		20	
	Q	INPUT	Q	INPUT	Q	INPUT	Q	INPUT	Q	INPUT	Q	INPUT	Q	INPUT
15	2.02	455	2.43	546	2.85	616	3.26	665	3.68	707	4.06	728	4.48	742
21	1.92	490	2.30	581	2.72	644	3.10	693	3.52	728	3.90	749	4.30	777
26	1.73	525	2.14	616	2.53	679	2.94	728	3.36	763	3.74	784	4.16	805

MUZ-EF35VG
MUZ-EF35VGH

CAPACITY: 4.0 kW INPUT: 950 W

INDOOR DB (°C)	OUTDOOR WB (°C)													
	-10		-5		0		5		10		15		20	
	Q	INPUT	Q	INPUT	Q	INPUT	Q	INPUT	Q	INPUT	Q	INPUT	Q	INPUT
15	2.52	618	3.04	741	3.56	836	4.08	903	4.60	960	5.08	988	5.60	1007
21	2.40	665	2.88	789	3.40	874	3.88	941	4.40	988	4.88	1017	5.38	1055
26	2.16	713	2.68	836	3.16	922	3.68	988	4.20	1036	4.68	1064	5.20	1093

MUZ-EF42VG

CAPACITY: 5.4 kW INPUT: 1455 W

INDOOR DB (°C)	OUTDOOR WB (°C)													
	-10		-5		0		5		10		15		20	
	Q	INPUT	Q	INPUT	Q	INPUT	Q	INPUT	Q	INPUT	Q	INPUT	Q	INPUT
15	3.40	946	4.10	1135	4.81	1280	5.51	1382	6.21	1470	6.86	1513	7.56	1542
21	3.24	1019	3.89	1208	4.59	1339	5.24	1440	5.94	1513	6.59	1557	7.26	1615
26	2.92	1091	3.62	1280	4.27	1411	4.97	1513	5.67	1586	6.32	1630	7.02	1673

MUZ-EF50VG

CAPACITY: 5.8 kW INPUT: 1560 W

INDOOR DB (°C)	OUTDOOR WB (°C)													
	-10		-5		0		5		10		15		20	
	Q	INPUT	Q	INPUT	Q	INPUT	Q	INPUT	Q	INPUT	Q	INPUT	Q	INPUT
15	3.65	1014	4.41	1217	5.16	1373	5.92	1482	6.67	1576	7.37	1622	8.12	1654
21	3.48	1092	4.18	1295	4.93	1435	5.63	1544	6.38	1622	7.08	1669	7.80	1732
26	3.13	1170	3.89	1373	4.58	1513	5.34	1622	6.09	1700	6.79	1747	7.54	1794

NOTE: Q: Total capacity (kW) INPUT : Total power input (W) DB: Dry-bulb temperature WB: Wet-bulb temperature

**MUZ-EF25VG MUZ-EF35VG MUZ-EF42VG MUZ-EF50VG
MUZ-EF25VGH MUZ-EF35VGH**

10-1. OUTDOOR FAN MOTOR CONTROL

The fan motor turns ON/OFF, interlocking with the compressor.

[ON] The fan motor turns ON 5 seconds before the compressor starts up.

[OFF] The fan motor turns OFF 15 seconds after the compressor has stopped running.

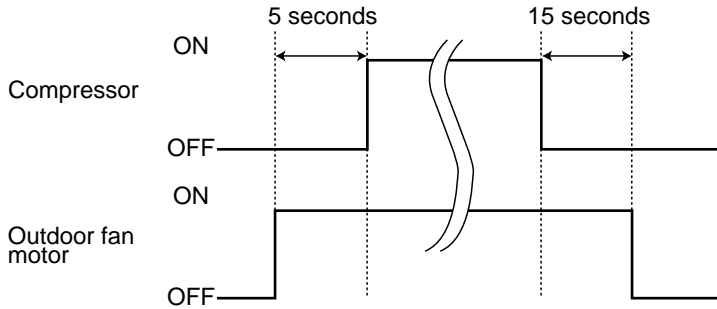

10-2. R.V. COIL CONTROL

Heating ON

Cooling OFF

Dry OFF

NOTE: The 4-way valve reverses for 5 seconds right before start-up of the compressor.

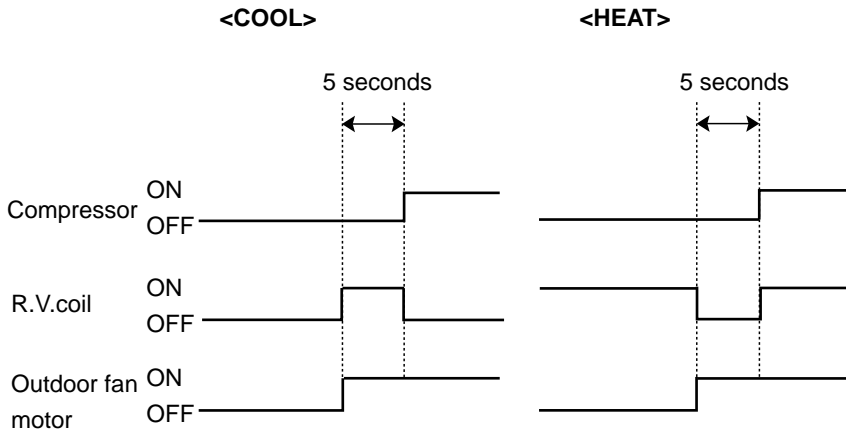

10-3. RELATION BETWEEN MAIN SENSOR AND ACTUATOR

Sensor	Purpose	Actuator					
		Compressor	LEV	Outdoor fan motor	R.V. coil	Indoor fan motor	Defrost heater
Discharge temperature thermistor	Protection	○	○				
Indoor coil temperature thermistor	Cooling: Coil frost prevention	○					
	Heating: High pressure protection	○	○				
Defrost thermistor	Heating: Defrosting	○	○	○	○	○	
Fin temperature thermistor	Protection	○		○			
Ambient temperature thermistor	Cooling: Low ambient temperature operation	○	○	○			
	Heating: Defrosting (Heater)						○
Outdoor heat exchanger temperature thermistor	Cooling: Low ambient temperature operation	○	○	○			
	Cooling: High pressure protection	○	○	○			

MUZ-EF25VG MUZ-EF35VG MUZ-EF42VG MUZ-EF50VG
 MUZ-EF25VGH MUZ-EF35VGH

11-1. CHANGE IN DEFROST SETTING

Changing defrost finish temperature

<JS> To change the defrost finish temperature, cut/solder the JS wire of the outdoor inverter P.C. board.
 (Refer to 12-6-1.)

Jumper wire		Defrost finish temperature (°C)
JS	Soldered (Initial setting)	5
	None (Cut)	10

11-2. PRE-HEAT CONTROL SETTING

PRE-HEAT CONTROL

When moisture gets into the refrigerant cycle, it may interfere the start-up of the compressor at low outside temperature. The pre-heat control prevents this interference. The pre-heat control turns ON when the discharge temperature thermistor is 20°C or below. When the pre-heat control turns ON, the compressor is energized. (About 50 W)

Pre-heat control setting

<JK>

ON: To activate the pre-heat control, cut the JK wire of the inverter P.C. board.

OFF: To deactivate the pre-heat control, solder the JK wire of the inverter P.C. board.

(Refer to 12-6.1)

NOTE: When the inverter P.C. board is replaced, check the jumper wires, and cut/solder them if necessary.

MUZ-EF25VG MUZ-EF35VG MUZ-EF42VG MUZ-EF50VG
 MUZ-EF25VGH MUZ-EF35VGH

12-1. CAUTIONS ON TROUBLESHOOTING

1. Before troubleshooting, check the following

- 1) Check the power supply voltage.
- 2) Check the indoor/outdoor connecting wire for miswiring.

2. Take care of the following during servicing

- 1) Before servicing the air conditioner, be sure to turn OFF the main unit first with the remote controller, and then after confirming the horizontal vane is closed, turn OFF the breaker and/or disconnect the power plug.
- 2) Be sure to turn OFF the power supply before removing the front panel, the cabinet, the top panel, and the electronic control P.C. board.
- 3) When removing the electrical parts, be careful of the residual voltage of smoothing capacitor.
- 4) When removing the electronic control P.C. board, hold the edge of the board with care NOT to apply stress on the components.
- 5) When connecting or disconnecting the connectors, hold the connector housing. DO NOT pull the lead wires.

<Incorrect>

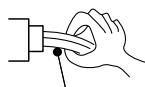

Lead wiring

<Correct>

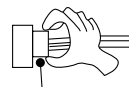

Connector housing

3. Troubleshooting procedure

- 1) Check if the OPERATION INDICATOR lamp on the indoor unit is blinking on and off to indicate an abnormality.
To make sure, check how many times the OPERATION INDICATOR lamp is blinking on and off before starting service work.
- 2) Before servicing, check that the connector and terminal are connected properly.
- 3) When the electronic control P.C. board seems to be defective, check the copper foil pattern for disconnection and the components for bursting and discoloration.
- 4) Refer to 12-2 and 12-3.

12-2. FAILURE MODE RECALL FUNCTION

Outline of the function

This air conditioner can memorize the abnormal condition which has occurred once.

Even though LED indication listed on the troubleshooting check table (12-3.) disappears, the memorized failure details can be recalled.

1. Flow chart of failure mode recall function for the indoor/outdoor unit

MSZ-EF-VG

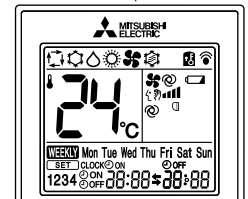
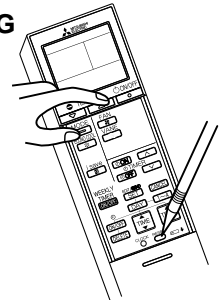

Operational procedure

The cause of abnormality cannot be found because the abnormality does not recur.

Setting up the failure mode recall function

Turn ON the power supply.
 <Preparation of the remote controller>
 ① While pressing OPERATION SELECT button and TEMP ⊕ button on the remote controller at the same time, press RESET button.
 ② First, release RESET button.
 Hold down the other 2 buttons for another 3 seconds. Make sure that the indicators on the LCD screen shown in the right figure are all displayed. Then release the buttons.

Press STOP/OPERATE (OFF/ON) button of the remote controller (the set temperature is displayed) with the remote controller headed towards the indoor unit. ※1

※1. Regardless of normal or abnormal condition, a short beep is emitted once the signal is received.

Does the upper lamp of OPERATION INDICATOR lamp on the indoor unit blink at the interval of 0.5 seconds?
 Blinks: Either indoor or outdoor unit is abnormal. Beep is emitted at the same timing as the blinking of the upper lamp on the indoor unit. ※2

No (OFF) → Indoor unit is normal. But the outdoor unit might be abnormal because there are some abnormalities that cannot be recalled with this way. Check if outdoor unit is abnormal according to the detailed outdoor unit failure mode recall function. (Refer to 12-2.2)

Judgment of indoor/outdoor abnormality

Before blinking, does the upper lamp on the indoor unit stay ON for 3 seconds? When it stays ON for 3 seconds (without beep): The outdoor unit is abnormal.

Yes → The outdoor unit is abnormal. Check the blinking pattern, and identify the abnormal point by referring to the table of outdoor unit failure mode recall function. (Refer to 12-2.3) Make sure to check at least 2 consecutive blinking cycles. ※3

No → The indoor unit is abnormal. Check the blinking pattern, and identify the abnormal point by referring to the table of indoor unit failure mode recall function. (Refer to indoor unit service manual.) Make sure to check at least 2 consecutive blinking cycles. ※2

Releasing the failure mode recall function

Release the failure mode recall function by the following procedures.
 Turn OFF the power supply and turn it ON again.
 Press RESET button of the remote controller.

Repair the failure parts.

Deleting the memorized abnormal condition

① After repairing the unit, recall the failure mode again according to "Setting up the failure mode recall function" mentioned above.
 ② Press STOP/OPERATE (OFF/ON) button of the remote controller (the set temperature is displayed) with the remote controller headed towards the indoor unit.
 ③ Press EMERGENCY OPERATION switch so that the memorized abnormal condition is deleted.
 ④ Release the failure mode recall function according to "Releasing the failure mode recall function" mentioned above.

NOTE: 1. Make sure to release the failure mode recall function after it is set up, otherwise the unit cannot operate properly.
 2. If the abnormal condition is not deleted from the memory, the last abnormal condition is kept memorized.

※2. Blinking pattern when the indoor unit is abnormal:

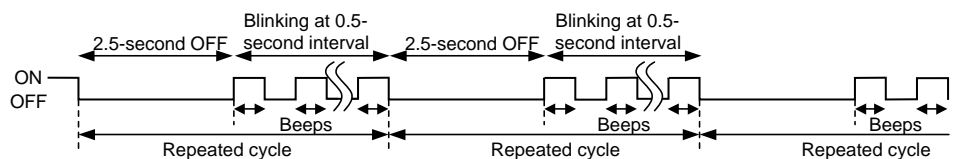

※3. Blinking pattern when the outdoor unit is abnormal:

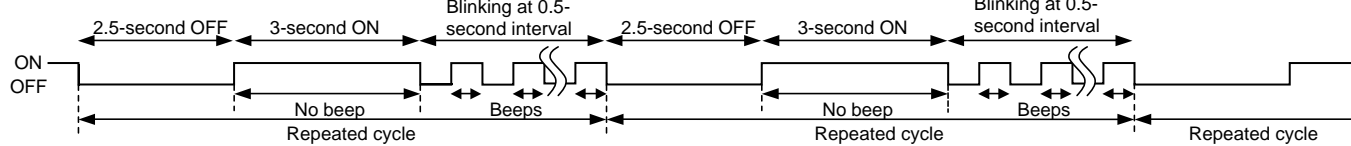

2. Flow chart of the detailed outdoor unit failure mode recall function

Operational procedure

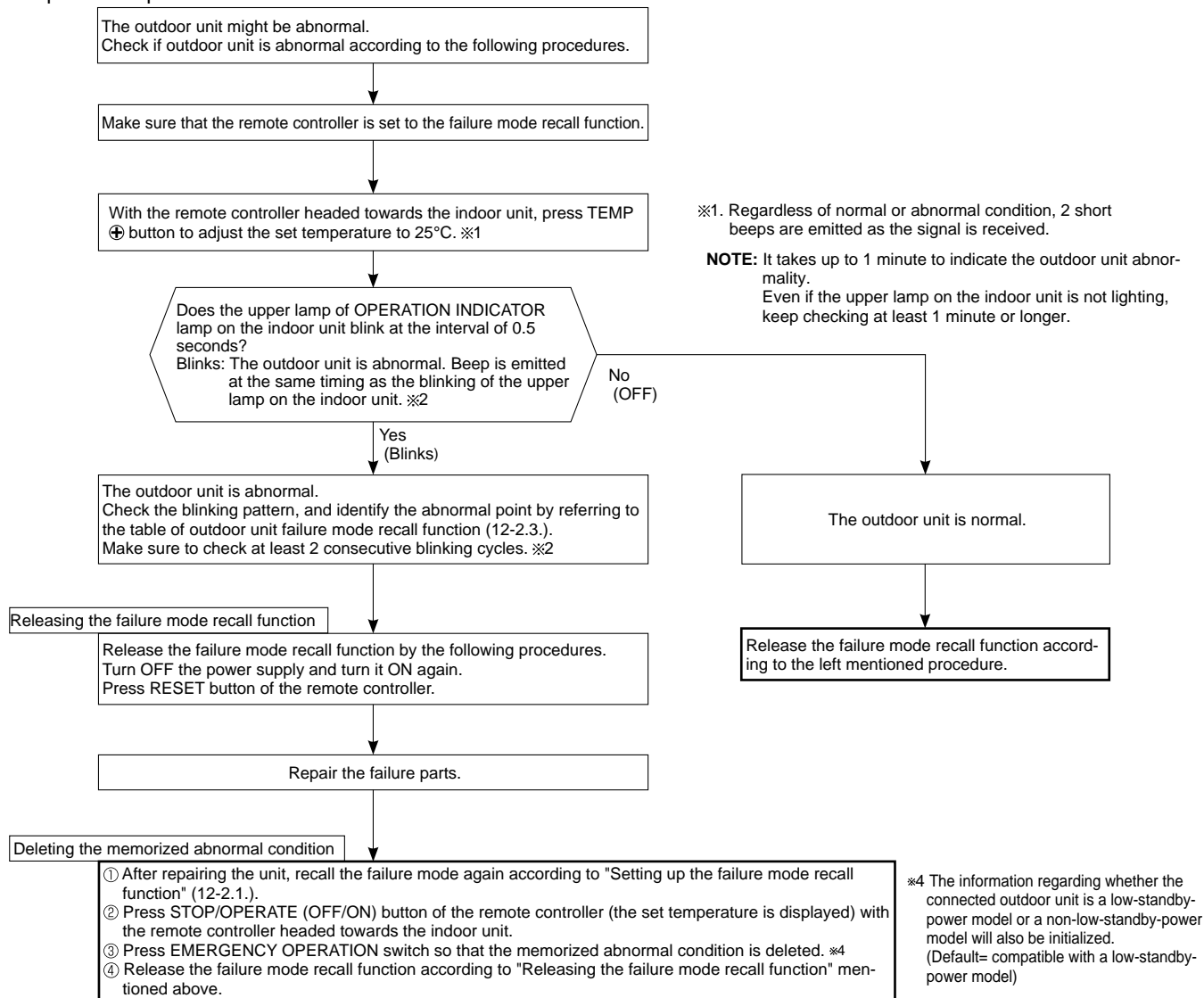

※2. Blinking pattern when outdoor unit is abnormal:

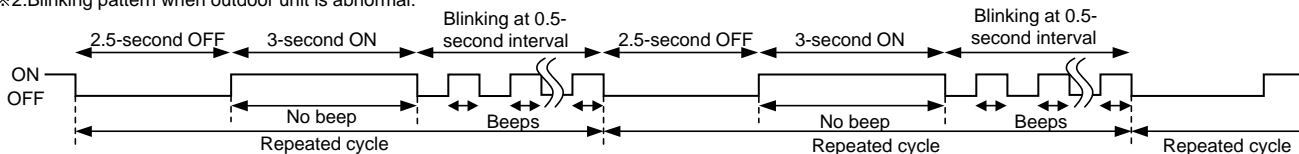



3. Table of outdoor unit failure mode recall function

NOTE: Blinking patterns of this mode differ from the ones of TROUBLESHOOTING CHECK TABLE (12-3.).

Upper lamp (Indoor unit)	Abnormal point (Failure mode/protection)	LED indication (Outdoor P.C. board)	Condition	Remedy	Indoor/outdoor unit failure mode recall function	Outdoor unit failure mode recall function
OFF	None (Normal)	—	—	—	—	—
1-time blink 2.5 seconds OFF	Indoor/outdoor communication, receiving error	—	Any signals from the inverter P.C. board cannot be received normally for 3 minutes.	•Refer to 12-5. ㉔ How to check miswiring and serial signal error.	○	○
	Indoor/outdoor communication, receiving error	—	Although the inverter P.C. board sends signal "0", signal "1" has been received 30 consecutive times.	•Refer to 12-5. ㉔ How to check miswiring and serial signal error.		
2-time blink 2.5 seconds OFF	Outdoor power system	—	Overcurrent protection cut-out operates 3 consecutive times within 1 minute after the compressor gets started.	•Reconnect connectors. •Refer to 12-5. ㉕ How to check inverter/compressor". •Check stop valve.	○	○
3-time blink 2.5 seconds OFF	Discharge temperature thermistor	1-time blink every 2.5 seconds	Thermistor shorts or opens during compressor running.	•Refer to 12-5. ㉖ "Check of outdoor thermistors". Defective outdoor thermistors can be identified by checking the blinking pattern of LED.	○	○
	Defrost thermistor	—				
	Fin temperature thermistor	3-time blink 2.5 seconds OFF				
	P.C. board temperature thermistor	4-time blink 2.5 seconds OFF				
	Ambient temperature thermistor	2-time blink 2.5 seconds OFF				
Outdoor heat exchanger temperature thermistor	—					
4-time blink 2.5 seconds OFF	Overcurrent	11-time blink 2.5 seconds OFF	Large current flows into power module (IC700).	•Reconnect compressor connector. •Refer to 12-5. ㉕ How to check inverter/compressor". •Check stop valve.	—	○
	Compressor synchronous abnormality (Compressor start-up failure protection)	12-time blink 2.5 seconds OFF	Waveform of compressor current is distorted.	•Reconnect compressor connector. •Refer to 12-5. ㉕ How to check inverter/compressor".	—	○
5-time blink 2.5 seconds OFF	Discharge temperature	—	Temperature of discharge temperature thermistor exceeds 116°C, compressor stops. Compressor can restart if discharge temperature thermistor reads 100°C or less 3 minutes later.	•Check refrigerant circuit and refrigerant amount. •Refer to 12-5. ㉗ Check of LEV".	—	○
6-time blink 2.5 seconds OFF	High pressure	—	Temperature of indoor coil thermistor exceeds 70°C in HEAT mode. Temperature of defrost thermistor exceeds 70°C in COOL mode.	•Check refrigerant circuit and refrigerant amount. •Check stop valve.	—	○
7-time blink 2.5 seconds OFF	Fin temperature/P.C. board temperature	7-time blink 2.5 seconds OFF	Temperature of fin temperature thermistor on the inverter P.C. board exceeds 75 ~ 86°C, or temperature of P.C. board temperature thermistor on the inverter P.C. board exceeds 72 ~ 85°C.	•Check around outdoor unit. •Check outdoor unit air passage. •Refer to 12-5. ㉘ Check of outdoor fan motor".	—	○
8-time blink 2.5 seconds OFF	Outdoor fan motor	—	Outdoor fan has stopped 3 times in a row within 30 seconds after outdoor fan startup.	•Refer to 12-5. ㉘ Check of outdoor fan motor". Refer to 12-5. ㉙ Check of inverter P.C. board".	—	○
9-time blink 2.5 seconds OFF	Nonvolatile memory data	5-time blink 2.5 seconds OFF	Nonvolatile memory data cannot be read properly.	•Replace the inverter P.C. board.	○	○
	Power module (IC700)	6-time blink 2.5 seconds OFF	The interface short circuit occurs in the output of the power module (IC700). The compressor winding shorts circuit.	•Refer to 12-5. ㉕ How to check inverter/compressor".		

NOTE: Blinking patterns of this mode differ from the ones of TROUBLESHOOTING CHECK TABLE (12-3.).

Upper lamp (Indoor unit)	Abnormal point (Failure mode/protection)	LED indication (Outdoor P.C. board)	Condition	Remedy	Indoor/outdoor unit failure mode recall function	Outdoor unit failure mode recall function
10-time blink 2.5 seconds OFF	Discharge temperature	—	Temperature of discharge temperature thermistor has been 50°C or less for 20 minutes.	<ul style="list-style-type: none"> Refer to 12-5.⑧"Check of LEV". Check refrigerant circuit and refrigerant amount. 	—	○
11-time blink 2.5 seconds OFF	Bus-bar voltage (DC)	8-time blink 2.5 seconds OFF	Bus-bar voltage of inverter cannot be detected normally.	<ul style="list-style-type: none"> Refer to 12-5.⑨"How to check inverter/compressor". 	—	○
	Each phase current of compressor	9-time blink 2.5 seconds OFF	Each phase current of compressor cannot be detected normally.			
14-time blink or more 2.5 seconds OFF	Stop valve (Closed valve)	14-time blink 2.5 seconds OFF	Closed valve is detected by compressor current.	<ul style="list-style-type: none"> Check stop valve. 	○	○
	4-way valve/ Pipe temperature	16-time blink 2.5 seconds OFF	The 4-way valve does not work properly. The indoor coil thermistor detects an abnormal temperature.	<ul style="list-style-type: none"> Check the 4-way valve. Replace the inverter P.C. board. 		
	Outdoor refrigerant system abnormality	1-time blink 2.5 seconds OFF	A closed valve and air trapped in the refrigerant circuit are detected based on the temperature sensed by the indoor and outdoor thermistors and the current of the compressor.	<ul style="list-style-type: none"> Check for a gas leak in a connecting piping etc. Check the stop valve. Refer to 12-5. ⑩ "Check of outdoor refrigerant circuit". 		

12-3. TROUBLESHOOTING CHECK TABLE

No.	Symptom	LED indication	Abnormal point/ Condition	Condition	Remedy
1	Outdoor unit does not operate.	1-time blink every 2.5 seconds	Outdoor power system	Overcurrent protection cut-out operates 3 consecutive times within 1 minute after the compressor gets started.	<ul style="list-style-type: none"> •Reconnect connector of compressor. •Refer to 12-5.Ⓐ "How to check inverter/compressor". •Check stop valve.
2			Outdoor thermistors	Discharge temperature thermistor, fin temperature thermistor, defrost thermistor, P.C. board temperature thermistor, outdoor heat exchanger temperature thermistor or ambient temperature thermistor shorts or opens during compressor running.	•Refer to 12-5.Ⓒ "Check of outdoor thermistors".
3			Outdoor control system	Nonvolatile memory data cannot be read properly. (Upper lamp of OPERATION INDICATOR lamp on the indoor unit lights up or blinks 7-time.)	•Replace inverter P.C. board.
4	'Outdoor unit stops and restarts 3 minutes later' is repeated.	6-time blink 2.5 seconds OFF	Serial signal	The communication fails between the indoor and outdoor unit for 3 minutes.	•Refer to 12-5.Ⓜ "How to check miswiring and serial signal error.
5		11-time blink 2.5 seconds OFF	Stop valve/ Closed valve	Closed valve is detected by compressor current.	•Check stop valve.
6		14-time blink 2.5 seconds OFF	Outdoor unit (Other abnormality)	Outdoor unit is defective.	•Refer to 12-2.2. "Flow chart of the detailed outdoor unit failure mode recall function".
7		16-time blink 2.5 seconds OFF	4-way valve/ Pipe temperature	The 4-way valve does not work properly. The indoor coil thermistor detects an abnormal temperature.	<ul style="list-style-type: none"> •Refer to 12-5.Ⓢ "Check of R.V. coil". •Replace the inverter P.C. board.
8		17-time blink 2.5 seconds OFF	Outdoor refrigerant system abnormality	A closed valve and air trapped in the refrigerant circuit are detected based on the temperature sensed by the indoor and outdoor thermistors and the current of the compressor.	<ul style="list-style-type: none"> •Check for a gas leak in a connecting piping etc. •Check the stop valve. •Refer to 12-5.Ⓣ "Check of outdoor refrigerant circuit".
9		2-time blink 2.5 seconds OFF	Overcurrent protection	Large current flows into power module (IC700).	<ul style="list-style-type: none"> •Reconnect connector of compressor. •Refer to 12-5.Ⓐ "How to check inverter/compressor". •Check stop valve.
10		3-time blink 2.5 seconds OFF	Discharge temperature overheat protection	Temperature of discharge temperature thermistor exceeds 116°C, compressor stops. Compressor can restart if discharge temperature thermistor reads 100°C or less 3 minutes later.	<ul style="list-style-type: none"> •Check refrigerant circuit and refrigerant amount. •Refer to 12-5.Ⓚ "Check of LEV".
11		4-time blink 2.5 seconds OFF	Fin temperature / P.C. board temperature thermistor overheat protection	Temperature of fin temperature thermistor on the heat sink exceeds 75 ~ 86°C or temperature of P.C. board temperature thermistor on the inverter P.C. board exceeds 72 ~ 85°C.	<ul style="list-style-type: none"> •Check around outdoor unit. •Check outdoor unit air passage. •Refer to 12-5.Ⓛ "Check of outdoor fan motor".
12	5-time blink 2.5 seconds OFF	High pressure protection	Indoor coil thermistor exceeds 70°C in HEAT mode. Defrost thermistor exceeds 70°C in COOL mode.	<ul style="list-style-type: none"> •Check refrigerant circuit and refrigerant amount. •Check stop valve. 	
13	8-time blink 2.5 seconds OFF	Compressor synchronous abnormality	The waveform of compressor current is distorted.	<ul style="list-style-type: none"> •Reconnect connector of compressor. •Refer to 12-5.Ⓐ "How to check inverter/compressor". 	
14	10-time blink 2.5 seconds OFF	Outdoor fan motor	Outdoor fan has stopped 3 times in a row within 30 seconds after outdoor fan start-up.	<ul style="list-style-type: none"> •Refer to 12-5.Ⓛ "Check of outdoor fan motor. •Refer to 12-5.Ⓛ "Check of inverter P.C. board. 	
15	12-time blink 2.5 seconds OFF	Each phase current of compressor	Each phase current of compressor cannot be detected normally.	•Refer to 12-5.Ⓐ "How to check inverter/compressor".	
16	13-time blink 2.5 seconds OFF	Bus-bar voltage (DC)	Bus-bar voltage of inverter cannot be detected normally.	<ul style="list-style-type: none"> •It occurs with following case. Instantaneous power voltage drop. (Short time power failure) (MUZ-EF50VG) •Refer to 12-5.Ⓢ "Check of power supply". (MUZ-EF50VG) •Refer to 12-5.Ⓐ "How to check inverter/compressor". 	
17	Outdoor unit operates.	1-time blink 2.5 seconds OFF	Frequency drop by current protection	When the input current exceeds approximately 10A, compressor frequency lowers.	<ul style="list-style-type: none"> The unit is normal, but check the following. •Check if indoor filters are clogged. •Check if refrigerant is short. •Check if indoor/outdoor unit air circulation is short cycled.
18		3-time blink 2.5 seconds OFF	Frequency drop by high pressure protection	Temperature of indoor coil thermistor exceeds 55°C in HEAT mode, compressor frequency lowers.	
19		Frequency drop by defrosting in COOL mode	Indoor coil thermistor reads 8°C or less in COOL mode, compressor frequency lowers.		
		4-time blink 2.5 seconds OFF	Frequency drop by discharge temperature protection	Temperature of discharge temperature thermistor exceeds 111°C, compressor frequency lowers.	<ul style="list-style-type: none"> •Check refrigerant circuit and refrigerant amount. •Refer to 12-5.Ⓚ "Check of LEV". •Refer to 12-5.Ⓒ "Check of outdoor thermistors".
20	MUZ-EF25/35/42VG 5-time blink 2.5 seconds OFF	Outside temperature thermistor protection	When the outside temperature thermistor shorts or opens, protective operation without that thermistor is performed.	•Refer to 12-5.Ⓒ Check of outdoor thermistors.	



No.	Symptom	LED indication	Abnormal point/ Condition	Condition	Remedy
21	Outdoor unit operates.	7-time blink 2.5 seconds OFF	Low discharge temperature protection	Temperature of discharge temperature thermistor has been 50°C or less for 20 minutes.	<ul style="list-style-type: none"> Refer to 12-5.Ⓢ "Check of LEV". Check refrigerant circuit and refrigerant amount.
22		8-time blink 2.5 seconds OFF	PAM protection PAM: Pulse Amplitude Modulation	The overcurrent flows into PFC (Power factor correction: IC820) or the bus-bar voltage reaches 394 V or more, PAM stops and restarts.	<p>This is not malfunction. PAM protection will be activated in the following cases:</p> <ol style="list-style-type: none"> 1 Instantaneous power voltage drop. (Short time power failure) 2 When the power supply voltage is high.
23		9-time blink 2.5 seconds OFF	Inverter check mode	The connector of compressor is disconnected, inverter check mode starts.	<ul style="list-style-type: none"> Check if the connector of the compressor is correctly connected. Refer to 12-5.ⓐ "How to check inverter/compressor".

NOTE: 1. The location of LED is illustrated at the right figure. Refer to 12-6.1.
2. LED is lit during normal operation.

The blinking frequency shows the number of times the LED blinks after every 2.5-second OFF.
(Example) When the blinking frequency is "2".

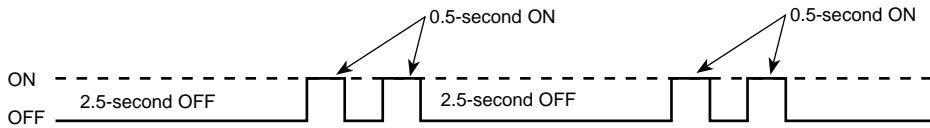

Inverter P.C. board

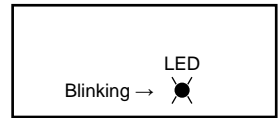

12-4. TROUBLE CRITERION OF MAIN PARTS

Part name	Check method and criterion	Figure														
Defrost thermistor (RT61) Fin temperature thermistor (RT64) Ambient temperature thermistor (RT65) Outdoor heat exchanger temperature thermistor (RT68)	Measure the resistance with a tester. Refer to 12-6. "TEST POINT DIAGRAM AND VOLTAGE", 1. "Inverter P.C. board", for the chart of thermistor.															
Discharge temperature thermistor (RT62)	Measure the resistance with a tester. Before measurement, hold the thermistor with your hands to warm it up. Refer to 12-6. "TEST POINT DIAGRAM AND VOLTAGE", 1. "Inverter P.C. board", for the chart of thermistor.															
Compressor	Measure the resistance between terminals using a tester. (Temperature: -10 ~ 40°C) <table border="1"> <thead> <tr> <th rowspan="2"></th> <th colspan="2">Normal (Ω)</th> </tr> <tr> <th>MUZ-EF25/35VG(H)</th> <th>MUZ-EF42/50VG</th> </tr> </thead> <tbody> <tr> <td>U-V</td> <td></td> <td></td> </tr> <tr> <td>U-W</td> <td>1.59 ~ 2.16</td> <td>0.82 ~ 1.11</td> </tr> <tr> <td>V-W</td> <td></td> <td></td> </tr> </tbody> </table>		Normal (Ω)		MUZ-EF25/35VG(H)	MUZ-EF42/50VG	U-V			U-W	1.59 ~ 2.16	0.82 ~ 1.11	V-W			
	Normal (Ω)															
	MUZ-EF25/35VG(H)	MUZ-EF42/50VG														
U-V																
U-W	1.59 ~ 2.16	0.82 ~ 1.11														
V-W																
Outdoor fan motor	Measure the resistance between lead wires using a tester. (Temperature: -10 ~ 40°C) <table border="1"> <thead> <tr> <th rowspan="2">Color of lead wire</th> <th colspan="2">Normal (Ω)</th> </tr> <tr> <th>MUZ-EF25/35/42VG MUZ-EF25/35VGH</th> <th>MUZ-EF50VG</th> </tr> </thead> <tbody> <tr> <td>RED – BLK</td> <td></td> <td></td> </tr> <tr> <td>BLK – WHT</td> <td>32 ~ 43</td> <td>15 ~ 20</td> </tr> <tr> <td>WHT – RED</td> <td></td> <td></td> </tr> </tbody> </table>	Color of lead wire	Normal (Ω)		MUZ-EF25/35/42VG MUZ-EF25/35VGH	MUZ-EF50VG	RED – BLK			BLK – WHT	32 ~ 43	15 ~ 20	WHT – RED			
Color of lead wire	Normal (Ω)															
	MUZ-EF25/35/42VG MUZ-EF25/35VGH	MUZ-EF50VG														
RED – BLK																
BLK – WHT	32 ~ 43	15 ~ 20														
WHT – RED																
R. V. coil (21S4)	Measure the resistance using a tester. (Temperature: -10 ~ 40°C) <table border="1"> <thead> <tr> <th>Normal (kΩ)</th> </tr> </thead> <tbody> <tr> <td>1.41 ~ 2.00</td> </tr> </tbody> </table>	Normal (kΩ)	1.41 ~ 2.00													
Normal (kΩ)																
1.41 ~ 2.00																
Expansion valve coil (LEV)	Measure the resistance using a tester. (Temperature: -10 ~ 40°C) <table border="1"> <thead> <tr> <th>Color of lead wire</th> <th>Normal (Ω)</th> </tr> </thead> <tbody> <tr> <td>RED – ORN</td> <td rowspan="4">37 ~ 54</td> </tr> <tr> <td>RED – WHT</td> </tr> <tr> <td>RED – BLU</td> </tr> <tr> <td>RED – YLW</td> </tr> </tbody> </table>	Color of lead wire	Normal (Ω)	RED – ORN	37 ~ 54	RED – WHT	RED – BLU	RED – YLW								
Color of lead wire	Normal (Ω)															
RED – ORN	37 ~ 54															
RED – WHT																
RED – BLU																
RED – YLW																
Defrost heater MUZ-EF-VGH	<table border="1"> <thead> <tr> <th>Normal (Ω)</th> </tr> </thead> <tbody> <tr> <td>MUZ-EF25/35VGH</td> </tr> <tr> <td>802 ~ 980</td> </tr> </tbody> </table>	Normal (Ω)	MUZ-EF25/35VGH	802 ~ 980												
Normal (Ω)																
MUZ-EF25/35VGH																
802 ~ 980																



12-5. TROUBLESHOOTING FLOW

A How to check inverter/compressor

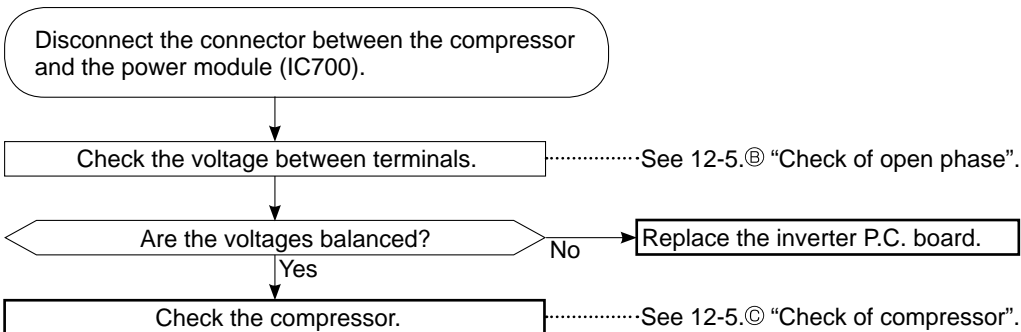

B Check of open phase

- With the connector between the compressor and the power module (IC700) disconnected, activate the inverter and check if the inverter is normal by measuring **the voltage balance** between the terminals.

Output voltage is 50 - 130 V. (The voltage may differ according to the tester.)

< Operation method >

Start cooling or heating operation by pressing EMERGENCY OPERATION switch on the indoor unit. (TEST RUN OPERATION: Refer to 9-3.)

< Measurement point >

At 3 points

BLK (U)-WHT (V)

※ Measure AC voltage between the lead wires at 3 points.

BLK (U)-RED (W)

WHT(V)-RED (W)

NOTE: 1. Output voltage varies according to power supply voltage.

2. Measure the voltage by analog type tester.

3. During this check, LED of the inverter P.C. board blinks 9 times. (Refer to 12-6.1.)

C Check of compressor

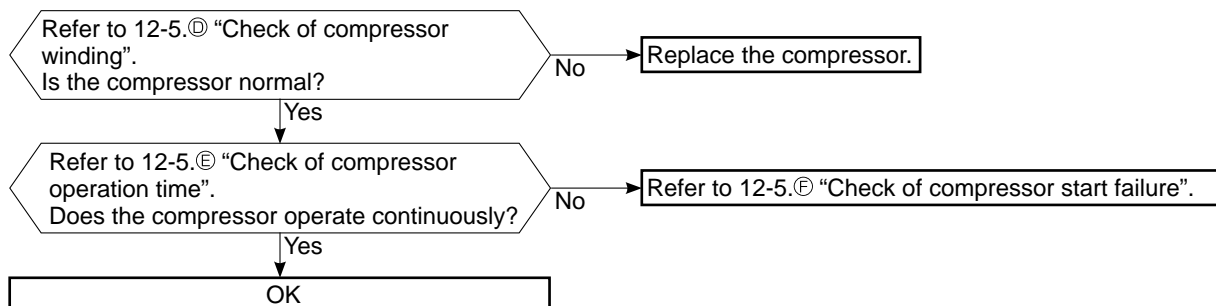

D Check of compressor winding

- Disconnect the connector between the compressor and the power module (IC700), and measure the resistance between the compressor terminals.

<Measurement point>

At 3 points

BLK-WHT

BLK-RED

WHT-RED

※ Measure the resistance between the lead wires at 3 points.

<Judgement>

Refer to 12-4.

0 [Ω]Abnormal [short]

Infinite [Ω]Abnormal [open]

NOTE: Be sure to zero the ohmmeter before measurement.

E Check of compressor operation time

- Connect the compressor and activate the inverter. Then measure the time until the inverter stops due to overcurrent.

<Operation method>

Start heating or cooling operation by pressing EMERGENCY OPERATION switch on the indoor unit. (TEST RUN OPERATION: Refer to 9-3.)

<Measurement>

Measure the time from the start of compressor to the stop of compressor due to overcurrent.

<Judgement>

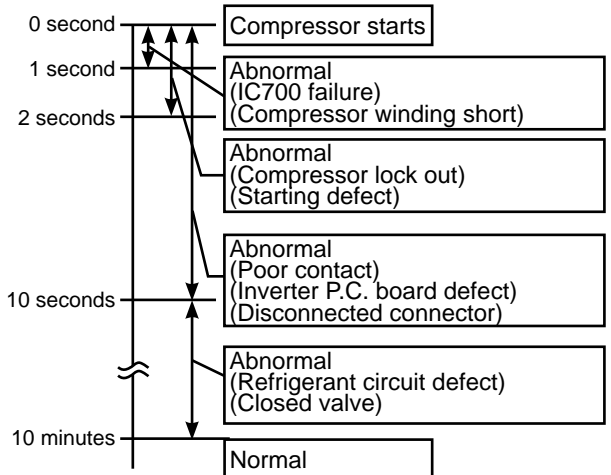

F Check of compressor start failure

Confirm that ①~④ is normal.

- Electrical circuit check

①. Contact of the compressor connector

②. Output voltage of inverter P.C. board and balance of them (See 12-5.⑥)

③. Direct current voltage between DB61(+) and (-) on the inverter P.C. board

④. Voltage between outdoor terminal block S1-S2

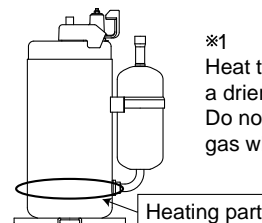
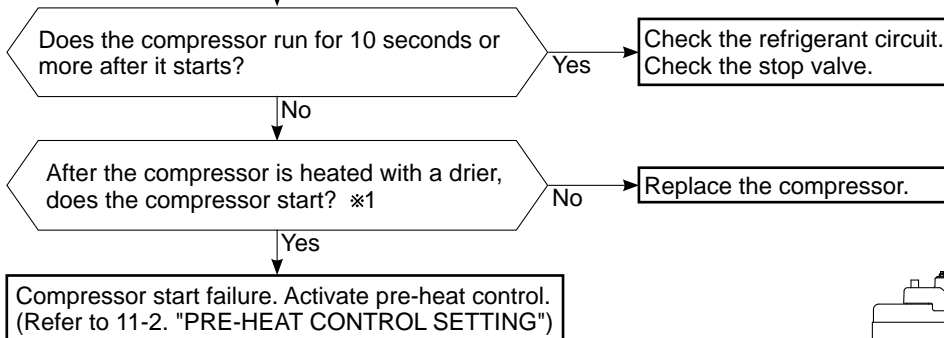

※1 Heat the compressor with a drier for about 20 minutes. Do not recover refrigerant gas while heating.

Ⓒ Check of outdoor thermistors

Disconnect the connector of thermistor in the inverter P.C. board (see below table), and measure the resistance of thermistor.

Is the resistance of thermistor normal?
(Refer to 12-6.1.)

No

Replace the thermistor except RT64.
When RT64 is abnormal, replace the inverter P.C. board.

Yes

Reconnect the connector of thermistor.
Turn ON the power supply and press EMERGENCY OPERATION switch.

Does the unit operate for 10 minutes or more
without showing thermistor abnormality?

No

Replace the inverter P.C. board.

Yes

OK (Cause is poor contact.)

Thermistor	Symbol	Connector, Pin No.	Board
Defrost	RT61	Between CN641 pin1 and pin2	Inverter P.C. board
Discharge temperature	RT62	Between CN641 pin3 and pin4	
Fin temperature	RT64	Between CN642 pin1 and pin2	
Ambient temperature	RT65	Between CN643 pin1 and pin2	
Outdoor heat exchanger temperature	RT68	Between CN644 pin1 and pin3	



H Check of R.V. coil

- ※ First of all, measure the resistance of R.V. coil to check if the coil is defective. Refer to 12-4.
- ※ In case CN721 is disconnected or R.V. coil is open, voltage is generated between the terminal pins of the connector although no signal is being transmitted to R.V. coil.
Check if CN721 is connected.

Unit operates COOL mode even if it is set to HEAT mode.

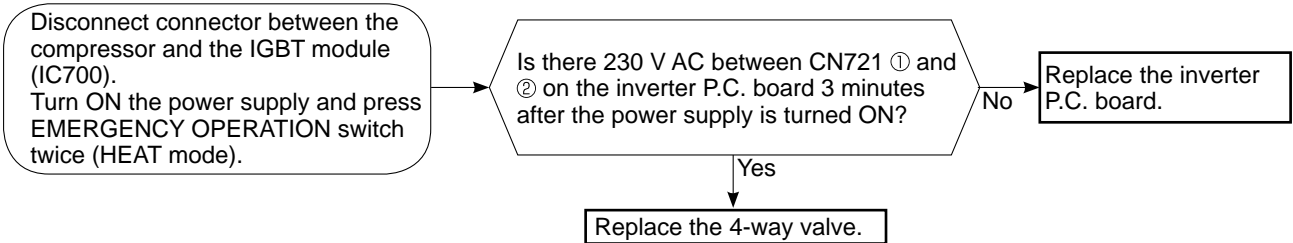

Unit operates HEAT mode even if it is set to COOL mode.

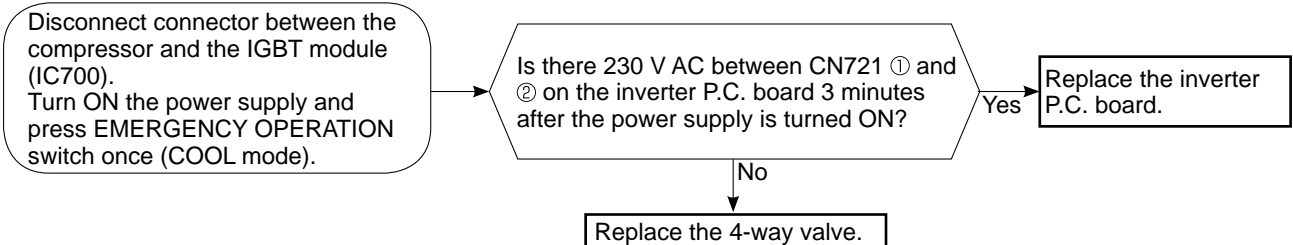



① Check of outdoor fan motor

Disconnect the connectors CN931 and CN932 from the inverter P.C. board.
Check the connection between the connector CN931 and CN932.

Is the resistance between each terminal of outdoor fan motor normal?
(Refer to 12-4.)

Yes

No

Disconnect CN932 from the inverter P.C. board, and turn on the power supply.

Rotate the outdoor fan motor manually and measure the voltage of CN931.
Between 1(+) and 5(-)
Between 2(+) and 5(-)
Between 3(+) and 5(-)

(Fixed to either 5 or 0 V DC)

No

Yes

No

Yes

Replace the outdoor fan motor.

Replace the inverter P.C. board.

J Check of power supply

Disconnect the connector between the compressor and the power module (IC700). Turn ON power supply and press EMERGENCY OPERATION switch.

Does the upper lamp of OPERATION INDICATOR lamp on the indoor unit light up?

Yes

Is there bus-bar voltage 260 - 370 V DC between DB61 (+) and DB61 (-) on the inverter P.C. board? (Refer to 12-6.1.)

No

Check the electric parts in main circuit.

Is there voltage 230 V AC between the indoor terminal block S1 and S2?

Yes

Rectify indoor/outdoor connecting wire.

Replace the indoor electronic control P.C. board.

Does LED on the inverter P.C. board light up or blink? (Refer to 12-6.1.)

No

Replace the inverter P.C. board.

Yes

If lights up, OK.
If blinks, refer to 12-3.

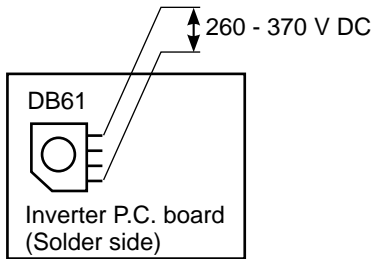

K Check of LEV (Expansion valve)

MSZ-EF-VG

Turn ON the power supply.

<Preparation of the remote controller>

- ① While pressing both OPERATION SELECT button and TEMP \oplus button on the remote controller at the same time, press RESET button.
- ② First, release RESET button.
Hold down the other 2 buttons for another 3 seconds. Make sure that the indicators on the LCD screen shown in the right figure are all displayed. Then release the buttons.

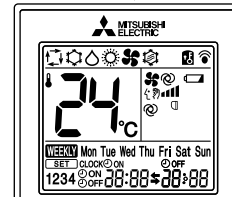
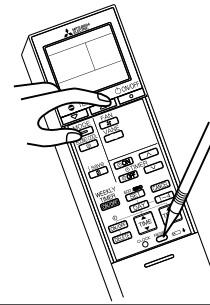

※1. Regardless of normal or abnormal condition, a short beep is emitted once the signal is received.

Press STOP/OPERATE (OFF/ON) button of the remote controller (the set temperature is displayed) with the remote controller headed towards the indoor unit. ※1

Expansion valve operates in full-opening direction.

Do you hear the expansion valve "click, click....." ?
Do you feel the expansion valve vibrate when touching it ?

Yes

OK

No

Is LEV coil properly fixed to the expansion valve?

No

Properly fix the LEV coil to the expansion valve.

Yes

Does the resistance of LEV coil have the characteristics? (Refer to 12-4.)

Yes

Measure each voltage between connector pins of CN724 on the inverter P.C. board.
1. Pin③(-) — Pin①(+)
2. Pin④(-) — Pin①(+)
3. Pin⑤(-) — Pin①(+)
4. Pin⑥(-) — Pin①(+)
Is there about 3 - 5 V AC between each?
NOTE: Measure the voltage by an analog tester.

No

Replace the inverter P.C. board.

No

Replace the LEV coil.

Yes

Replace the expansion valve.

NOTE: After check of LEV, take the following steps.

1. Turn OFF the power supply and turn it ON again.
2. Press RESET button on the remote controller.



L Check of inverter P.C. board

Check the outdoor fan motor.
(Refer to 12-5.①.)

Is the fuse (F901) blown on the in-
verter P.C. board?

Yes

No

Check the connection of the connectors
(CN931, CN932) of the outdoor fan motor.
If the connection is poor, make it correct.

Operate the outdoor unit by starting
EMERGENCY OPERATION.

Check the LED indication on the in-
verter P.C. board.
Does the LED blink 10 times?

No

Check the corresponding parts
following LED indication.
(Refer to 12-3.)

Yes
(10-time blink)

Replace the inverter P.C. board.

M How to check miswiring and serial signal error

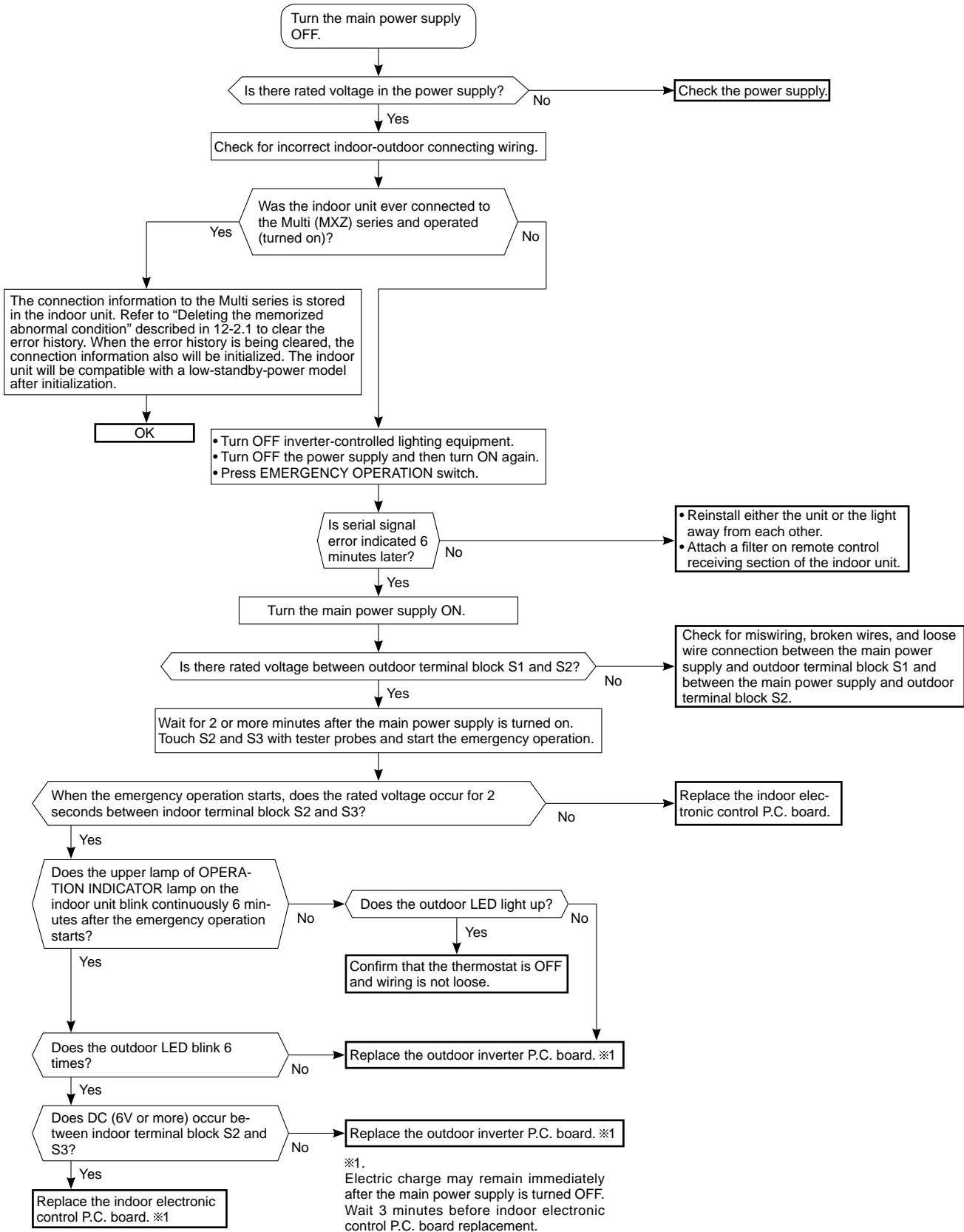



N Check of the outdoor refrigerant circuit

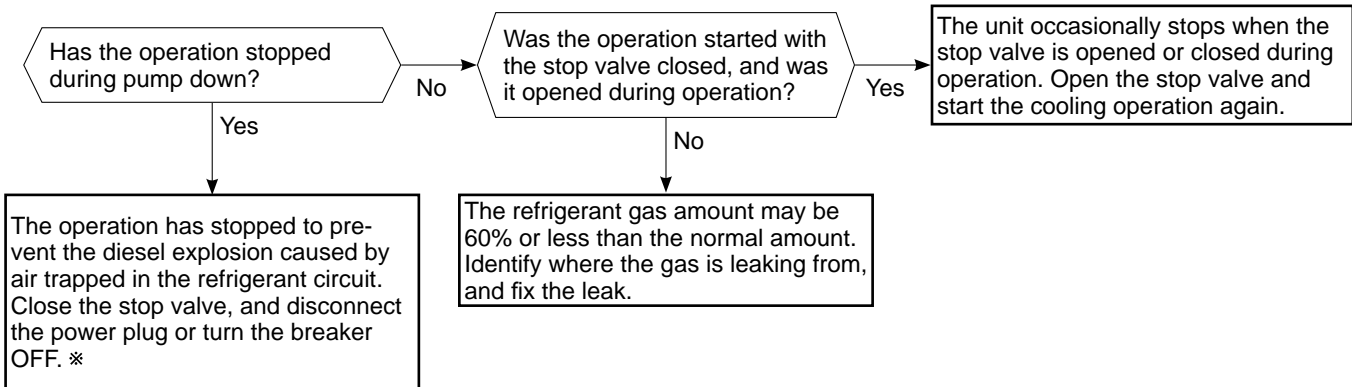

*** CAUTION : Do not start the operation again to prevent hazards.**

⊙ Electromagnetic noise enters into TV sets or radios

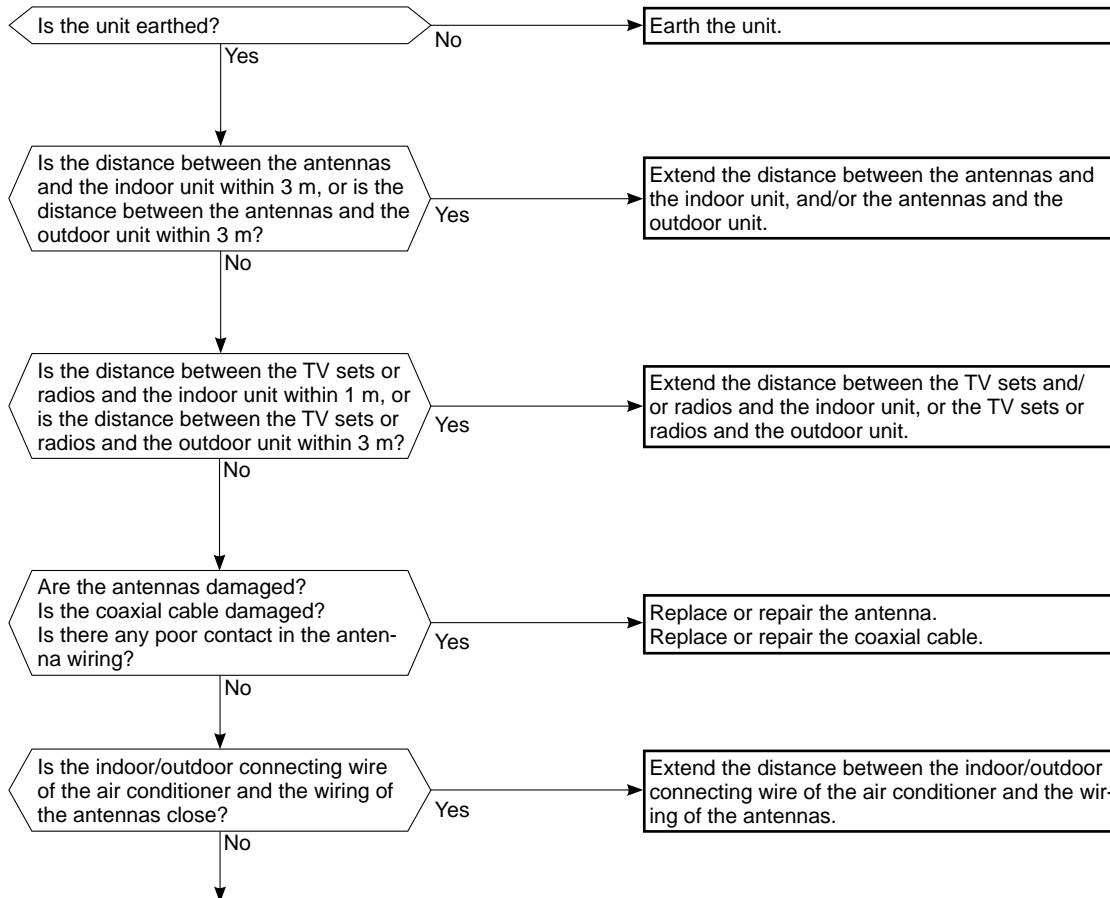

Even if all of the above conditions are fulfilled, the electromagnetic noise may enter, depending on the electric field strength or the installation condition (combination of specific conditions such as antennas or wiring). Check the following before asking for service.

1. Devices affected by the electromagnetic noise
TV sets, radios (FM/AM broadcast, shortwave)
2. Channel, frequency, broadcast station affected by the electromagnetic noise
3. Channel, frequency, broadcast station unaffected by the electromagnetic noise
4. Layout of:
indoor/outdoor unit of the air conditioner, indoor/outdoor wiring, earth wire, antennas, wiring from antennas, receiver
5. Electric field intensity of the broadcast station affected by the electromagnetic noise
6. Presence or absence of amplifier such as booster
7. Operation condition of air conditioner when the electromagnetic noise enters in
 - 1) Turn OFF the power supply once, and then turn ON the power supply. In this situation, check for the electromagnetic noise.
 - 2) Within 3 minutes after turning ON the power supply, press STOP/OPERATE (OFF/ON) button on the remote controller for power ON, and check for the electromagnetic noise.
 - 3) After a short time (3 minutes later after turning ON), the outdoor unit starts running. During operation, check for the electromagnetic noise.
 - 4) Press STOP/OPERATE (OFF/ON) button on the remote controller for power OFF, when the outdoor unit stops but the indoor/outdoor communication still runs on. In this situation, check for the electromagnetic noise.

12-6. TEST POINT DIAGRAM AND VOLTAGE

1. Inverter P.C. board

MUZ-EF25VG MUZ-EF35VG MUZ-EF42VG MUZ-EF50VG
MUZ-EF25VGH MUZ-EF35VGH

Back side of unit

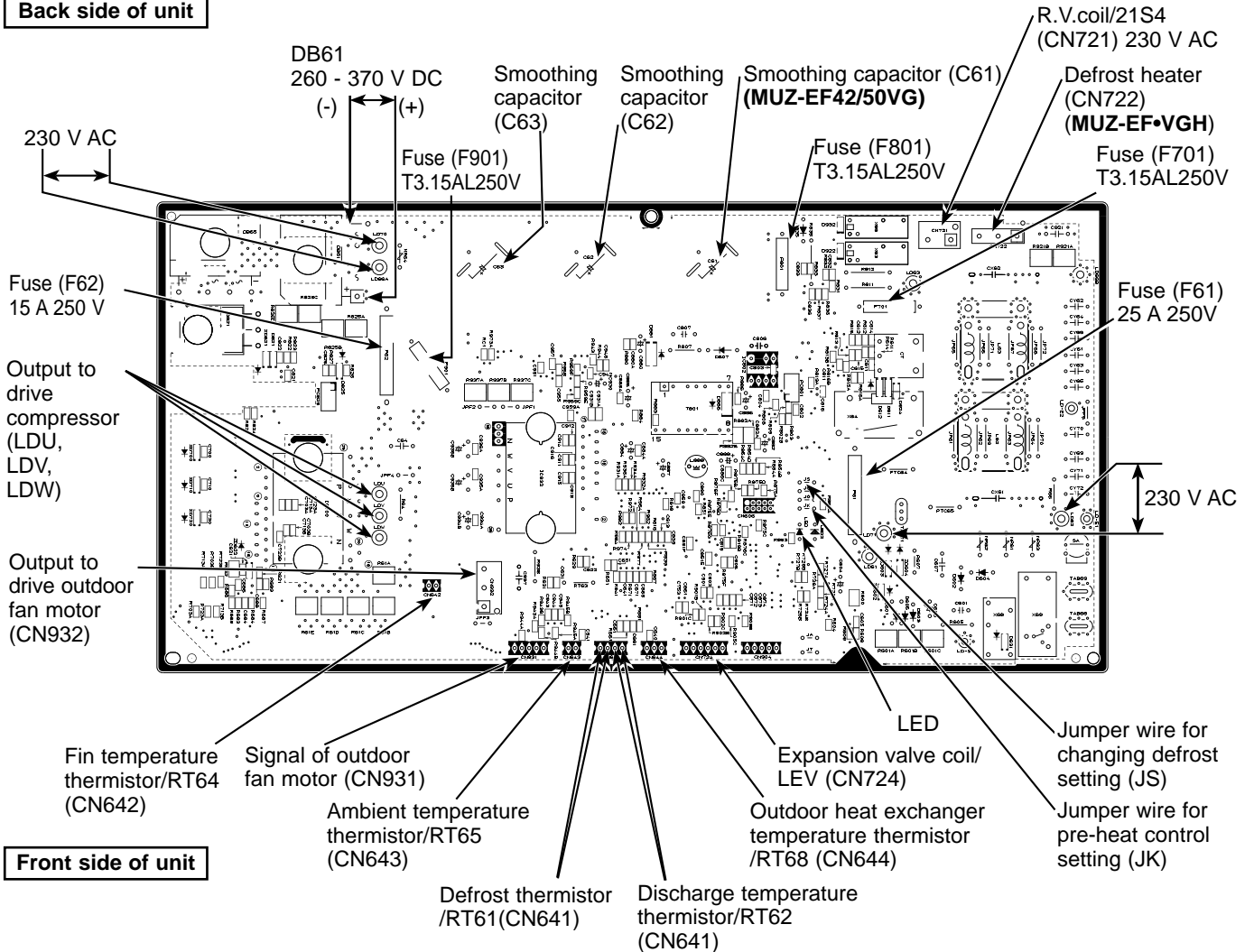

Front side of unit

Defrost thermistor (RT61)
 Ambient temperature thermistor (RT65)
 Outdoor heat exchanger temperature thermistor (RT68)

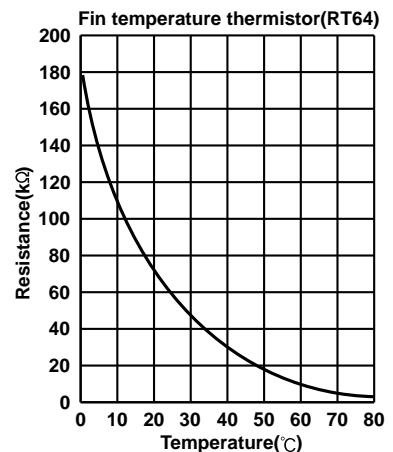
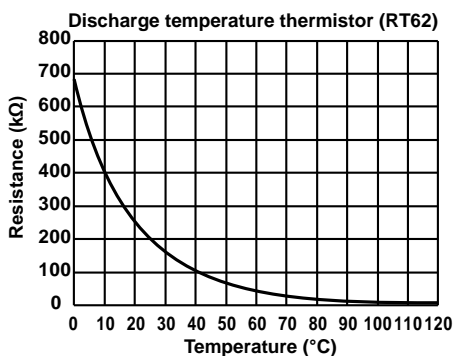
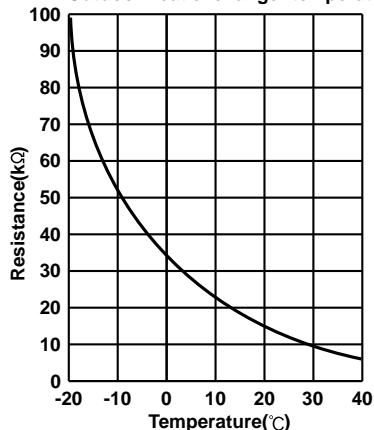

<Detaching method of the terminal with locking mechanism >

The terminal which has the locking mechanism can be detached as shown below.

There are 2 types of the terminals with locking mechanism.

The terminal without locking mechanism can be detached by pulling it out.

Check the shape of the terminal before detaching.

(1) Slide the sleeve and check if there is a locking lever or not.

(2) The terminal with this connector shown below has the locking mechanism.

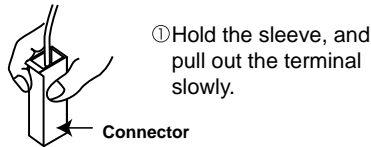
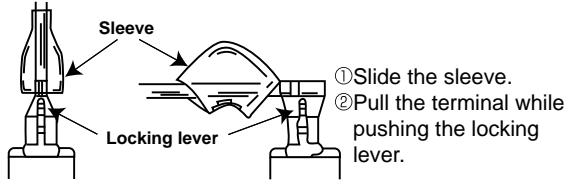

**13-1. MUZ-EF25VG MUZ-EF35VG MUZ-EF42VG
MUZ-EF25VGH MUZ-EF35VGH**

NOTE: Turn OFF the power supply before disassembly.

—>: Indicates the visible parts in the photos/figures.

--->: Indicates the invisible parts in the photos/figures.

Photos: **MUZ-EF42VG**

OPERATING PROCEDURE	PHOTOS/FIGURES
<p>1. Removing the cabinet</p> <p>(1) Remove the screw fixing the service panel. (2) Pull down the service panel and remove it. (3) Disconnect the power supply cord and indoor/outdoor connecting wire. (4) Remove the screws fixing the top panel. (5) Remove the top panel. (6) Remove the screws fixing the cabinet. (7) Remove the cabinet. (8) Remove the screws fixing the back panel. (9) Remove the back panel.</p> <p>Photo 3</p> <p>Screw of the cabinet</p> <p>Screws of the cabinet</p> <p>Hooks of the service panel</p> <p>Direction to remove</p>	<p>Photo 1</p> <p>Screws of the top panel</p> <p>Screws of the top panel</p> <p>Back panel</p> <p>Screw of the service panel</p> <p>Service panel</p> <p>Screws of the cabinet</p> <p>Photo 2</p> <p>Screws of the terminal block support and the back panel</p> <p>Screws of the back panel</p>



OPERATING PROCEDURE

2. Removing the inverter assembly, inverter P.C. board

- (1) Remove the cabinet and panels. (Refer to section 1.)
- (2) Disconnect the lead wire to the reactor and the following connectors:
<Inverter P.C. board>
CN721 (R.V. coil)
CN931, CN932 (Fan motor)
CN641 (Defrost thermistor and discharge temperature thermistor)
CN643 (Ambient temperature thermistor)
CN644 (Outdoor heat exchanger temperature thermistor)
CN724 (LEV)
- (3) Remove the compressor connector (CN61).
- (4) Remove the screws fixing the heat sink support and the separator.
- (5) Remove the fixing screws of the terminal block support and the back panel.
- (6) Remove the inverter assembly.
- (7) Remove the screw of the earth wire and screw of the terminal block support.
- (8) Remove the heat sink support from the P.C. board support.
- (9) Remove the screw of the inverter P.C. board and remove the inverter P.C. board from the P.C. board support.

3. Removing R.V. coil

- (1) Remove the cabinet and panels. (Refer to section 1.)
- (2) Disconnect the following connectors:
<Inverter P.C. board>
CN721 (R.V. coil)
- (3) Remove the R.V. coil.

4. Removing the discharge temperature thermistor, defrost thermistor, outdoor heat exchanger temperature thermistor and ambient temperature thermistor

- (1) Remove the cabinet and panels. (Refer to section 1.)
- (2) Disconnect the lead wire to the reactor and the following connectors:
<Inverter P.C. board>
CN641 (Defrost thermistor and discharge temperature thermistor)
CN643 (Ambient temperature thermistor)
CN644 (Outdoor heat exchanger temperature thermistor)
- (3) Pull out the discharge temperature thermistor from its holder.
- (4) Pull out the defrost thermistor from its holder. (Photo 7)
- (5) Pull out the outdoor heat exchanger temperature thermistor from its holder. (Photo 7)
- (6) Pull out the ambient temperature thermistor from its holder.

PHOTOS/FIGURES

Photo 4

Screws of the heat sink support and the separator Screws of the terminal block support and the back panel



Photo 5 (Inverter assembly)

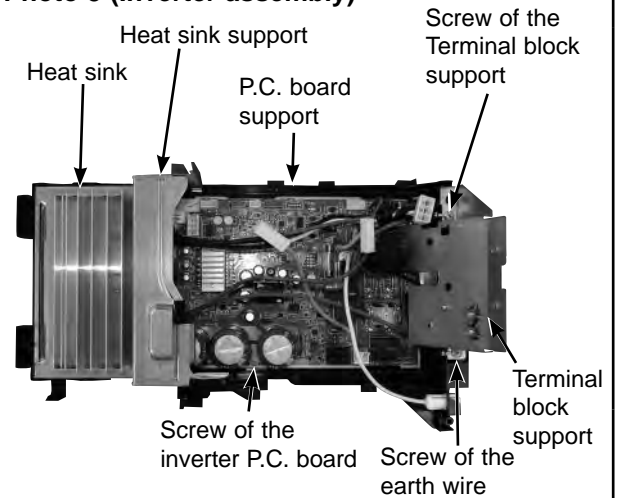
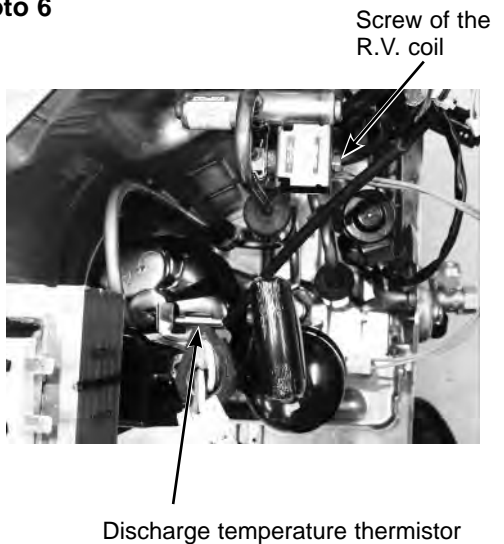

Photo 6



OPERATING PROCEDURE

5. Removing outdoor fan motor

- (1) Remove the cabinet and panels. (Refer to section 1.)
- (2) Disconnect the following connectors:
<Inverter P.C. board>
CN931, CN932 (Fan motor)
- (3) Remove the propeller fan nut.
- (4) Remove the propeller fan.
- (5) Remove the screws fixing the fan motor.
- (6) Remove the fan motor.

6. Removing the compressor and 4-way valve

- (1) Remove the cabinet and panels. (Refer to section 1.)
- (2) Remove the inverter assembly. (Refer to section 2.)
- (3) Recover gas from the refrigerant circuit.
NOTE: Recover gas from the pipes until the pressure gauge shows 0 kg/cm² (0 MPa).
- (4) Detach the brazed part of the suction and the discharge pipe connected with compressor.
- (5) Remove the nuts of compressor legs.
- (6) Remove the compressor.
- (7) Detach the brazed part of pipes connected with 4-way valve.

7. Removing the LEV assembly

- (1) Detaching the brazed part of pipes connected with LEV valve.

Photo 10

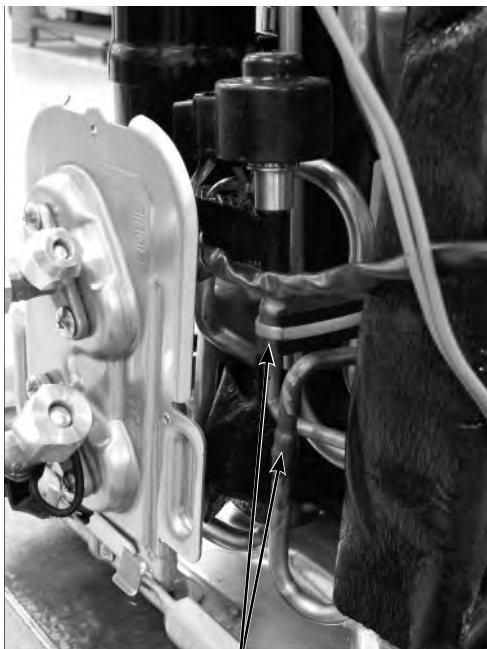

Brazed parts of LEV valve

PHOTOS/FIGURES

Photo 7

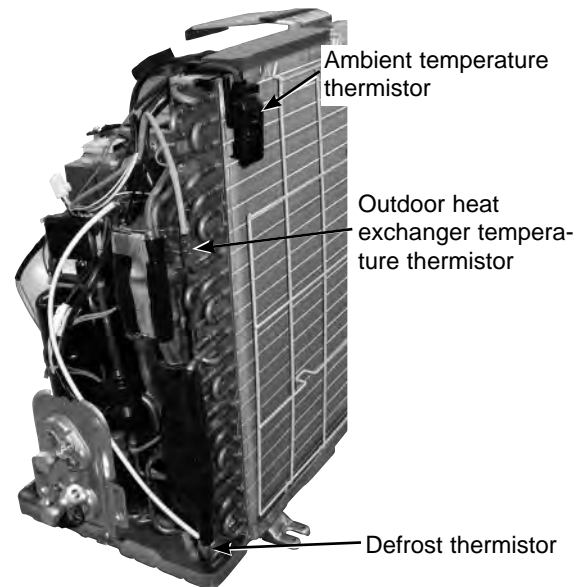

NOTE: MUZ-EF25/35VG are different in the installation position of thermistors.

Screws of the outdoor fan motor

Photo 8



Propeller fan nut

Propeller fan

Photo 9



Brazed parts of 4-way valve

13-2. MUZ-EF50VG

NOTE: Turn OFF the power supply before disassembly.

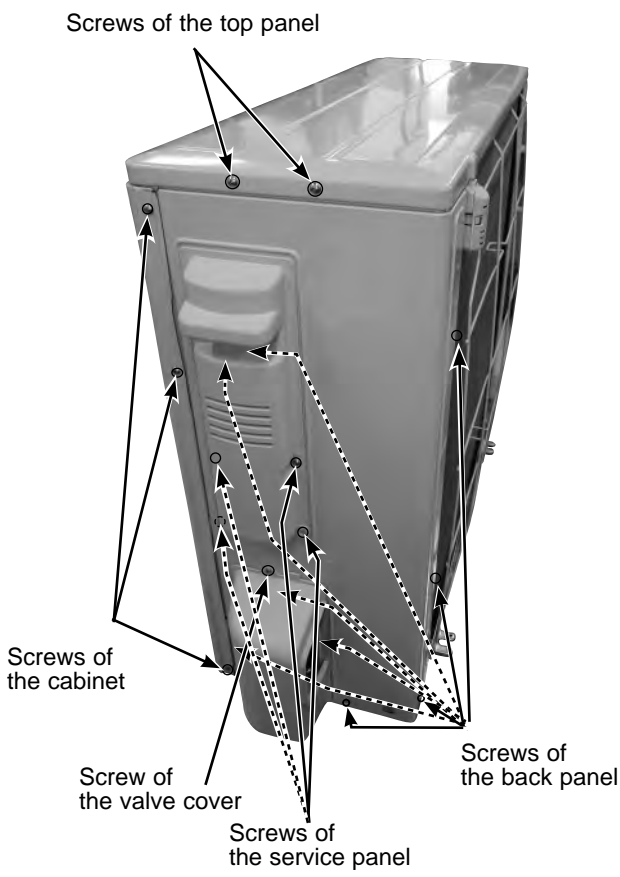
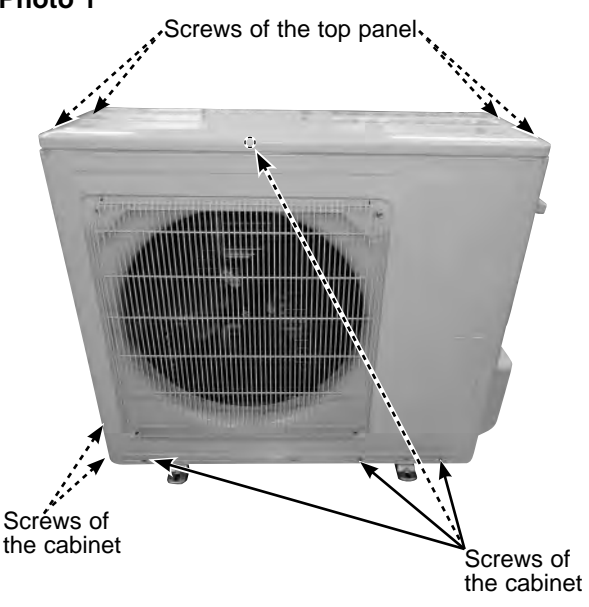
OPERATING PROCEDURE	PHOTOS/FIGURES
<p>1. Removing the cabinet</p> <ol style="list-style-type: none">(1) Remove the screws of the service panel.(2) Remove the screws of the top panel.(3) Remove the screw of the valve cover.(4) Remove the service panel.(5) Remove the top panel.(6) Remove the valve cover.(7) Disconnect the power supply and indoor/outdoor connecting wire.(8) Remove the screws of the cabinet.(9) Remove the cabinet.(10) Remove the screws of the back panel.(11) Remove the back panel. <p>Photo 2</p>  <p>The diagram shows the outdoor unit from a rear-three-quarter perspective. Dashed arrows point to various screw locations: 'Screws of the top panel' at the top edge; 'Screws of the cabinet' along the side and bottom edges; 'Screw of the valve cover' on the front panel; 'Screws of the service panel' on the front panel; and 'Screws of the back panel' along the rear edge.</p>	<p>Photo 1</p>  <p>The photo shows the outdoor unit from a front-three-quarter perspective. Dashed arrows point to 'Screws of the top panel' at the top edge and 'Screws of the cabinet' at the bottom edge.</p>

OPERATING PROCEDURE

2. Removing the inverter assembly and inverter P.C. board

- (1) Remove the cabinet and panels. (Refer to section 1.)
- (2) Disconnect the lead wire to the reactor and the following connectors:
 - <Inverter P.C. board>
 - CN721 (R.V. coil)
 - CN931, CN932 (Fan motor)
 - CN641 (Defrost thermistor and discharge temperature thermistor)
 - CN643 (Ambient temperature thermistor)
 - CN644 (Outdoor heat exchanger temperature thermistor)
 - CN724 (LEV)
- (3) Remove the compressor connector (CN61).
- (4) Remove the screws fixing the heat sink support and the separator.
- (5) Remove the fixing screw of the P.B. support and the separator.
- (6) Remove the fixing screws of the terminal block support and the back panel.
- (7) Remove the inverter assembly.
- (8) Remove the heat sink support from the P.C. board support.
- (9) Remove the screw of the inverter P.C. board and remove the inverter P.C. board from the P.C. board support.

* Connection procedure when attaching the inverter P.C. board (Photo 4)

1. Connect the lead wires of the heat exchanger temperature thermistor, the defrost thermistor and discharge temperature thermistor to the connector on the inverter P.C. board. Pull the lead wires toward you and put them on the right hook on the P.C. board support.
2. Connect the lead wires of the LEV to the connector on the inverter P.C. board. Pull the lead wires toward you and put them on the right hook on the P.C. board support.
3. Connect the lead wires of the ambient temperature thermistor to the connector on the inverter P.C. board. Pull the lead wires toward you and put them on the left hook on the P.C. board support so that the fan motor lead wires are bundled up as shown in Photo 4.

PHOTOS/FIGURES

Photo 3

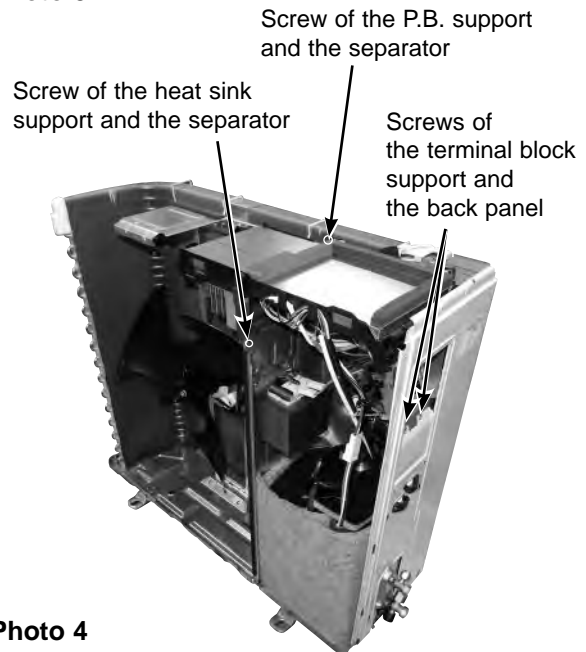

Photo 4

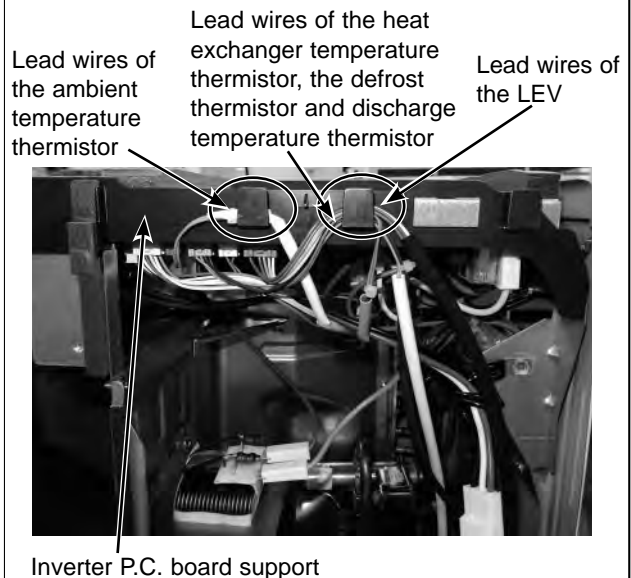
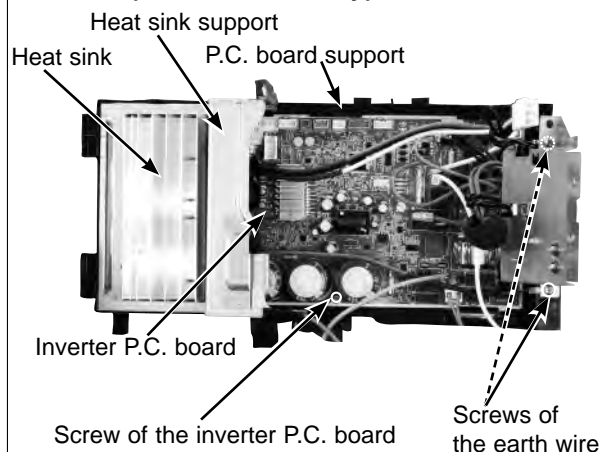

Photo 5 (Inverter assembly)





OPERATING PROCEDURE

3. Removing R. V. coil

- (1) Remove the cabinet and panels. (Refer to section 1.)
- (2) Disconnect the following connectors:
<Inverter P.C. board>
CN721 (R.V. coil)
- (3) Remove the R.V. coil.

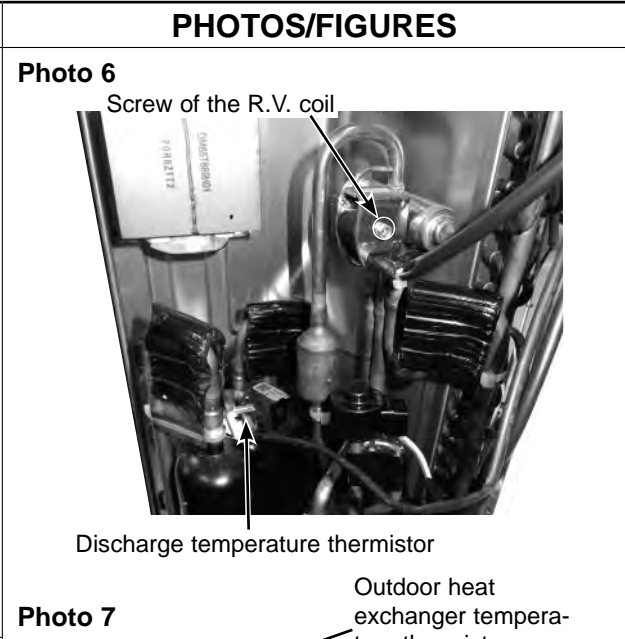

4. Removing the discharge temperature thermistor, defrost thermistor, outdoor heat exchanger temperature thermistor and ambient temperature thermistor

- (1) Remove the cabinet and panels. (Refer to section 1.)
- (2) Disconnect the lead wire to the reactor and the following connectors:
<Inverter P.C. board>
CN641 (Defrost thermistor and discharge temperature thermistor)
CN643 (Ambient temperature thermistor)
CN644 (Outdoor heat exchanger temperature thermistor)
- (3) Pull out the discharge temperature thermistor from its holder.
- (4) Pull out the defrost thermistor from its holder.
- (5) Pull out the outdoor heat exchanger temperature thermistor from its holder.
- (6) Pull out the ambient temperature thermistor from its holder.

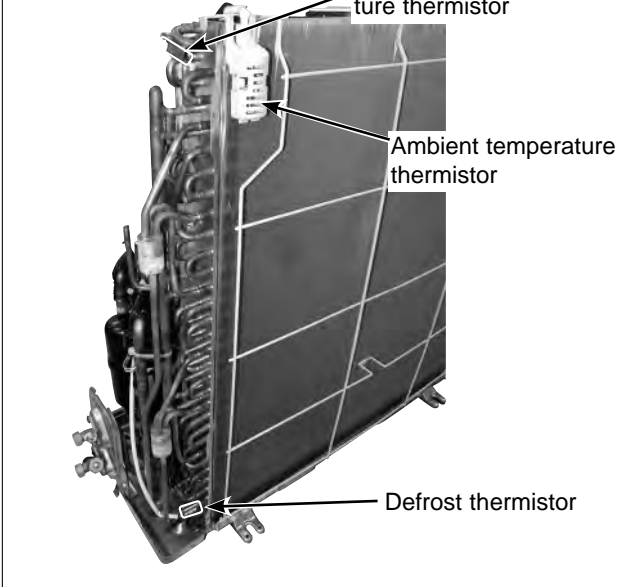

5. Removing outdoor fan motor

- (1) Remove the cabinet and panels. (Refer to section 1.)
- (2) Disconnect the following connectors:
<Inverter P.C. board>
CN931, CN932 (Fan motor)
- (3) Remove the propeller fan nut.
- (4) Remove the propeller fan.
- (5) Remove the screws fixing the fan motor.
- (6) Remove the fan motor.

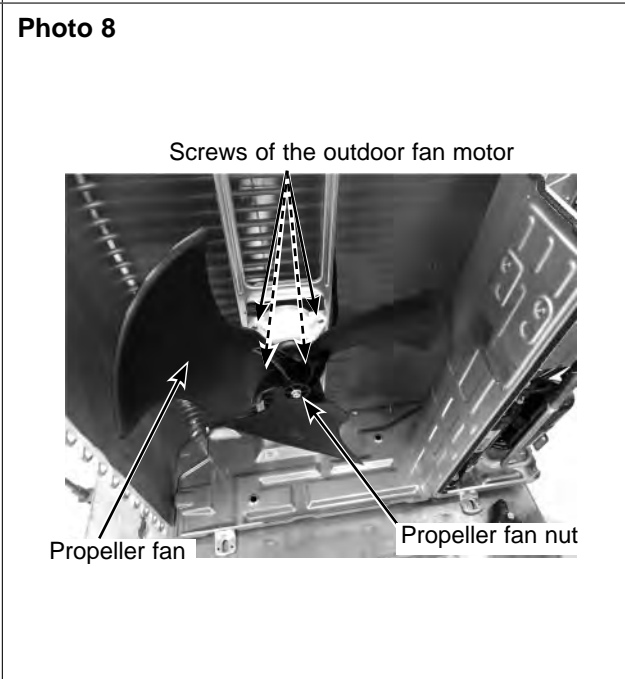

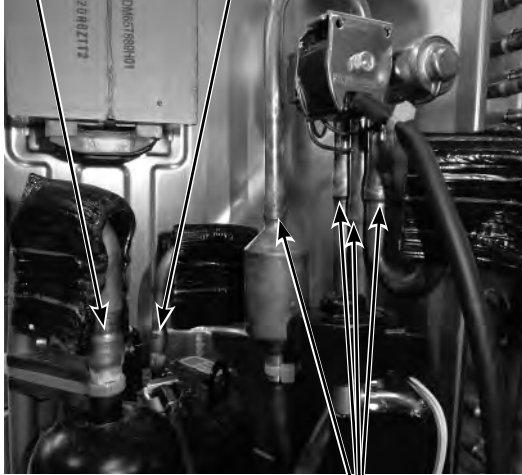

OPERATING PROCEDURE	PHOTOS/FIGURES
<p>6. Removing the compressor and 4-way valve</p> <p>(1) Remove the cabinet and panels. (Refer to section 1.)</p> <p>(2) Remove the inverter assembly. (Refer to section 2.)</p> <p>(3) Recover gas from the refrigerant circuit.</p> <p>NOTE: Recover gas from the pipes until the pressure gauge shows 0 kg/cm² (0 MPa).</p> <p>(4) Detach the brazed part of the suction and the discharge pipe connected with compressor.</p> <p>(5) Remove the compressor nuts.</p> <p>(6) Remove the compressor.</p> <p>(7) Detach the brazed part of pipes connected with 4-way valve.</p>	<p>Photo 9</p> <p>Suction pipe brazed part</p> <p>Discharge pipe brazed part</p>  <p>Brazed parts of 4-way valve</p>

MITSUBISHI ELECTRIC CORPORATION

HEAD OFFICE: TOKYO BUILDING, 2-7-3, MARUNOUCHI, CHIYODA-KU, TOKYO 100-8310, JAPAN

MXZ-2HA40VF COOLING

Indoor units combination	Cooling capacity (kW)			Outdoor unit power consumption(kW)			Current (A)			Power factor(%)
	Unit A	Unit B	Total				220	230	240	
25	2.50	-	2.50	0.90	-	2.90	0.600			94
									2.90	
35	3.40	-	3.40	1.00	-	3.40	0.920			94
									4.45	
25+25	2.00	2.00	4.00	1.54	-	4.30	1.010			94
									4.88	
25+35	1.69	2.31	4.00	1.55	-	4.30	0.970			94
									4.69	

MXZ-2HA40VF HEATING

Indoor units combination	Heating capacity (kW)			Outdoor unit power consumption(kW)			Current (A)			Power factor(%)			
	Unit A	Unit B	Total				220	230	240				
25	3.15	-	3.15	1.00	-	3.50	0.460	-	1.400	6.64	6.35	6.08	87
35	3.60	-	3.60	1.00	-	3.70	0.460	-	1.850	7.52	7.20	6.90	87
25+25	2.15	2.15	4.30	1.00	-	4.70	0.213	-	1.650	4.75	4.55	4.36	87
25+35	2.01	2.29	4.30	1.00	-	4.70	0.213	-	1.650	4.75	4.55	4.36	87

MXZ-2HA50VF COOLING

Indoor units combination	Cooling capacity (kW)			Outdoor unit power consumption(kW)			Current (A)			Power factor(%)			
	Unit A	Unit B	Total				220	230	240				
25	2.50	-	2.50	0.90	-	2.90	0.310	-	0.800	2.87	2.75	2.63	95
35	3.40	-	3.40	1.00	-	3.40	0.310	-	0.920	4.40	4.21	4.04	95
42	4.20	-	4.20	1.30	-	4.50	0.340	-	1.480	5.98	5.72	5.48	95
25+25	2.50	2.50	5.00	1.54	-	5.40	0.360	-	1.930	6.94	6.63	6.36	97
25+35	2.12	2.88	5.00	1.55	-	5.40	0.350	-	1.920	6.94	6.63	6.36	97
25+42	1.87	3.13	5.00	1.56	-	5.40	0.350	-	1.680	6.56	6.28	6.01	97
35+35	2.50	2.50	5.00	1.56	-	5.40	0.340	-	1.750	6.79	6.50	6.23	97

MXZ-2HA50VF HEATING

Indoor units combination	Heating capacity (kW)			Outdoor unit power consumption(kW)			Current (A)			Power factor(%)			
	Unit A	Unit B	Total				220	230	240				
25	3.15	-	3.15	1.00	-	3.50	0.460	-	1.400	6.08	5.81	5.57	95
			-										
35	3.60	-	3.60	1.00	-	3.70	0.460	-	1.850	6.89	6.59	6.32	95
			-										
42	4.70	-	4.70	1.30	-	5.40	0.460	-	1.850	6.56	6.27	6.01	95
			-										
25+25	3.00	3.00	6.00	1.11	-	6.40	0.170	-	2.060	7.03	6.72	6.44	97
			-										
25+35	2.80	3.20	6.00	1.12	-	6.40	0.160	-	2.050	7.03	6.72	6.44	97
			-										
25+42	2.41	3.59	6.00	1.12	-	6.40	0.160	-	1.840	6.37	6.10	5.84	97
			-										
35+35	3.00	3.00	6.00	1.12	-	6.40	0.150	-	1.990	6.84	6.54	6.27	97
			-										

MXZ-3HA50VF COOLING

Indoor units combination	Cooling capacity (kW)				Outdoor unit power consumption(kW)			Current (A)			Power factor(%)
	Unit A	Unit B	Unit C	Total				220	230	240	
25	2.50	-	-	2.50 1.76 - 2.90	0.620 - 0.750	0.490	2.91	2.78	2.66	97	
35	3.40	-	-	3.40 1.78 - 3.40	0.900 - 0.900	0.490	4.22	4.03	3.87	97	
42	4.20	-	-	4.20 1.84 - 4.50	1.110 - 1.360	0.490	5.20	4.98	4.77	97	
50	5.00	-	-	5.00 1.84 - 5.00	1.930 - 1.930	0.490	9.04	8.65	8.29	97	
25+25	2.50	2.50	-	5.00 2.00 - 5.80	1.420 - 2.330	0.460	6.65	6.36	6.10	97	
25+35	2.12	2.88	-	5.00 2.00 - 6.00	1.390 - 2.500	0.450	6.51	6.23	5.97	97	
25+42	1.87	3.13	-	5.00 2.00 - 6.20	1.270 - 2.500	0.450	5.95	5.69	5.46	97	
25+50	1.67	3.33	-	5.00 2.00 - 6.20	1.270 - 2.500	0.440	5.95	5.69	5.46	97	
35+35	2.50	2.50	-	5.00 2.00 - 6.10	1.330 - 2.500	0.440	6.23	5.96	5.71	97	
35+42	2.24	2.76	-	5.00 2.00 - 6.30	1.240 - 2.500	0.440	5.81	5.56	5.33	97	
35+50	2.02	2.98	-	5.00 2.00 - 6.30	1.230 - 2.500	0.430	5.76	5.51	5.28	97	
42+42	2.50	2.50	-	5.00 2.00 - 6.40	1.170 - 2.500	0.430	5.48	5.24	5.03	97	
25+25+25	1.67	1.67	1.67	5.00 2.90 - 6.50	1.210 - 2.500	0.580	5.67	5.42	5.20	97	
25+25+35	1.49	1.49	2.02	5.00 2.90 - 6.50	1.130 - 2.450	0.570	5.30	5.06	4.85	97	

MXZ-3HA50VF HEATING

Indoor units combination	Heating capacity (kW)				Outdoor unit power consumption(kW)			Current (A)			Power factor(%)
	Unit A	Unit B	Unit C	Total				220	230	240	
25	3.15	-	-	3.15 1.00 - 3.50	1.270 0.460 - 1.400	5.95	5.69	5.46	97		
35	3.60	-	-	3.60 1.00 - 3.70	1.440 0.460 - 1.480	6.75	6.45	6.19	97		
42	4.70	-	-	4.70 1.30 - 5.40	1.370 0.460 - 1.550	6.42	6.14	5.88	97		
50	5.40	-	-	5.40 1.40 - 6.50	1.550 0.460 - 2.650	7.26	6.95	6.66	97		
25+25	3.00	3.00	-	6.00 1.50 - 7.00	1.540 0.240 - 2.440	7.22	6.90	6.62	97		
25+35	2.80	3.20	-	6.00 2.19 - 7.20	1.520 0.290 - 2.700	7.12	6.81	6.53	97		
25+42	2.41	3.59	-	6.00 2.20 - 7.40	1.440 0.290 - 2.690	6.75	6.45	6.19	97		
25+50	2.21	3.79	-	6.00 2.20 - 7.40	1.420 0.290 - 2.690	6.65	6.36	6.10	97		
35+35	3.00	3.00	-	6.00 2.19 - 7.30	1.510 0.290 - 2.690	7.08	6.77	6.49	97		
35+42	2.60	3.40	-	6.00 2.20 - 7.40	1.430 0.290 - 2.690	6.70	6.41	6.14	97		
35+50	2.40	3.60	-	6.00 2.20 - 7.50	1.410 0.280 - 2.680	6.61	6.32	6.06	97		
42+42	3.00	3.00	-	6.00 2.22 - 7.50	1.380 0.280 - 2.690	6.47	6.19	5.93	97		
25+25+25	2.00	2.00	2.00	6.00 1.45 - 7.50	1.210 0.220 - 2.120	5.67	5.42	5.20	97		
25+25+35	1.91	1.91	2.18	6.00 1.45 - 7.50	1.200 0.200 - 2.120	5.62	5.38	5.15	97		