

DIRECT EXPANSION COIL UNIT FOR LOSSNAY

**MODELS:**

**GUG-01SL-E**

**GUG-02SL-E**

**GUG-03SL-E**

**Installation Instructions**

# Information for connectable Lossnay unit with Dx-coil unit

## Note:

The Dx-coil unit can only be connected to the Lossnay unit that is manufactured later than June 2016. The serial number is 16060001 or greater. Software version indicated by the stamp printing above DIP SW-2 on PCB of Lossnay unit is "05" or greater.

## Hinweis:

Der Direktverdampfer kann nur an eine Lossnay-Einheit angeschlossen werden, die nach Juni 2016 hergestellt wurde. Die Seriennummer muss 16060001 oder größer sein. Software-Version, die wird angezeigt durch der Stempeldruck oberhalb DIP-SW-2 auf der PCB der Lossnay-Einheit, ist "05" oder höher.

## Remarque:

La batterie DX ne peut être raccordée qu'à une unité Lossnay dont la date de fabrication est ultérieure à juin 2016. Le numéro de série est 16060001 ou supérieur. Version du logiciel indiqué par l'impression de timbre ci-dessus DIP SW-2 sur le circuit imprimé de l'unité Lossnay est "05" ou plus.

## Nota:

La unidad de serpentín Dx solo puede conectarse a la unidad Lossnay que se haya fabricado posteriormente a junio de 2016. Versión de software indicado por estampado por encima de DIP SW-2 en la PCB de la unidad Lossnay es "05" o mayor.

## Nota:

la batteria esp. dir. può essere collegata a unità Lossnay fabbricate dopo giugno 2016. Il numero di serie è 16060001 o superiore. El número de serie es 16060001 o superior. Versione software indicato dalla stampa timbro sopra DIP SW-2 sul PCB dell'unità Lossnay è "05" o superiore.

## Opmerking:

De Dx-spoel kan alleen worden aangesloten op Lossnay-units die zijn vervaardigd na juni 2016. Het serienummer is 16060001 of hoger. Softwareversie aangegeven door de stempel afdruk boven DIP SW-2 op PCB van Lossnay unit is "05" of groter.

## Nota:

A unidade de serpentina Dx só pode ser ligada às unidades Lossnay fabricadas depois de junho de 2016. O número de série é 16060001 ou superior. versão do software indicado pela estampagem acima DIP SW-2 no PCB da unidade Lossnay é "05" ou superior.

## Σημείωση:

Η μονάδα με στοιχείο άμεσης εκτόνωσης (Dx-coil) μπορεί να συνδεθεί μόνο σε μονάδα Lossnay που έχει κατασκευαστεί μετά τον Ιούλιο του 2016. Ο σειριακός αριθμός είναι 16060001 ή μεγαλύτερος. έκδοση λογισμικού υποδεικνύεται από την εκτύπωση σφραγίδας παραπάνω DIP SW-2 στο PCB της μονάδας Lossnay είναι "05" ή μεγαλύτερη.

## Примечание:

Испаритель непосредственного охлаждения может подключаться только к блоку Lossnay, выпущенному после июня 2016 г., с серийным номером 16060001 или далее. Версия программного обеспечения, которая обозначается по штампом выше DIP SW-2 на печатной плате блока Lossnay является "05" или больше.

## Not:

Dx-serpantin ünitesi sadece Haziran 2016'dan sonra üretilen Lossnay ünitesine bağlanabilir. Seri numarası 16060001 veya daha büyüktür. Lossnay ünitesinin PCB üzerindeki DIP SW-2 üzerindeki damga ile belirtilir yazılım sürümü "05" veya daha büyüktür.

## Obs!

Dx-konvektorenheten kan endast anslutas till Lossnay-enheter som har tillverkats från och med juni månad 2016. Serienumret är 16060001 eller högre. Mjukvaruversion som indikeras av stämpel ovan DIP SW-2 på PCB av Lossnay-enheten är "05" eller mer.

## Bemærk:

Dx-spoleenheden kan kun sluttes til Lossnay-enhed, der er fremstillet efter juni 2016. Serienummeret er 16060001 eller derover. Software version, som er angivet med stempler over DIP SW-2 på PCB i Lossnay enhed er "05" eller større.

# DIRECT EXPANSION COIL UNIT FOR LOSSNAY

MODELS:

**GUG-01SL-E**

**GUG-02SL-E**

**GUG-03SL-E**

**R410A only**

## Installation Instructions

(For use by dealer/contractor)

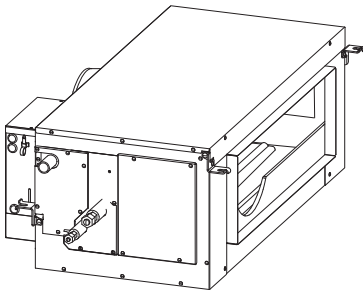

Pay special attention to refrigerant piping work. Prevent substances such as dirt, dust, moisture from entering the coolant circuit.

### Contents

Safety precautions.....	1
System configuration.....	4
Outlines and dimensions.....	6
Installation examples.....	7
Accessory parts.....	8
Installation method.....	9
Drain pipe work.....	10
Refrigerant pipe work.....	11
Electrical installation.....	14
Initial setting.....	17
Remote controller (PZ-01RC).....	20
Check points.....	21
Test run.....	22

This product needs to be installed properly in order to ensure maximum functionality as well as safety.

Please make sure to read this installation manual before starting the installation.





- Installation must be performed by a dealer or installation contractor. Please note that improper installation may cause malfunction or accident.

"Operating Instructions" and this manual must be handed over to the customer after completing the installation.

## Safety precautions

The following signs indicate that death or serious injury may be caused by failure to heed the precautions described below.

### WARNING

 <small>Do not disassemble</small>	<p><b>Do not modify or disassemble.</b> (It could cause fire, electric shock or injury.)</p>
 <small>Prohibition of use in bath or shower room</small>	<p><b>The unit and remote controller should not be installed where it is highly humid, like a bathroom, or other wet place.</b> (It could cause electric shock or power leakage.)</p>
 <small>Connect the grounding wire.</small>	<p><b>Connect the product properly to ground.</b> (Malfunctioning or power leaks can cause electrical shock.)</p>
 <small>The instructions given must be followed.</small>	<p><b>When installing or relocating, or servicing the unit, use only the specified refrigerant (R410A) to charge the refrigerant lines. Do not mix it with any other refrigerant and do not allow air to remain in the lines.</b>  <b>If air is mixed with the refrigerant, then it can be the cause of abnormal high pressure in the refrigerant line, and may result in an explosion and other hazards.</b>  <b>The use of any refrigerant other than that specified for the system will cause mechanical failure or system malfunction or unit breakdown. In the worst case, this could lead to a serious impediment to securing product safety.</b>  <b>Tighten all flare nuts to specification using a torque wrench. If tightened too much, the flare nut can break after an extended period.</b></p>

## Safety precautions (continued)

### **WARNING**

After installation has been completed, check for refrigerant leaks. If refrigerant leaks into the room and comes into contact with the flame of a heater or portable cooking range, poisonous gases will be released.

Ventilate the room if refrigerant leaks during operation. If refrigerant comes into contact with a flame, poisonous gases will be released.

If the supply cord is damaged, it must be replaced by the manufacturer, its service agent or similarly qualified persons in order to avoid a hazard.

Thermal insulation of the refrigerant pipe is necessary to prevent condensation. If the refrigerant pipe is not properly insulated, condensation will be formed.

Place thermal insulation on the pipes to prevent condensation. If the drainpipe is installed incorrectly, water leakage and damage to the ceiling, floor, furniture, or other possessions may result.

If the DX-coil unit is installed in a small room, measures must be taken to prevent the refrigerant concentration in the room from exceeding the safety limit in the event of refrigerant leakage. Should the refrigerant leak and cause the concentration limit to be exceeded, hazards due to lack of oxygen in the room may result.

**Use the specified power supply and voltage.**

(Use of incorrect power supply or voltage could cause fire or electric shock.)

**Select a place with sufficient strength and install the main unit securely.**

(It could cause injury if it falls.)

**Wiring work must be performed by qualified professionals, and be implemented safely and securely in accordance with the engineering standards and the extension wiring rules for electrical equipment.**

(Poor connection or improper wiring work could cause electric shock or fire.)

**Install an all-pole earth leakage isolator at the power supply side as per local electrical regulations. All supply circuits must be disconnected before obtaining access to the terminal devices. Use the specified cable size and connect the cables securely to prevent disconnection when they are pulled.**

(If there is a defect in the connection, there is a possibility of fire.)

**A duct made of steel must be installed with care not to be connected electrically with metal, wire, stainless steel plate, or others.**

(It could cause fire when power leakage occurs.)



The instructions given must be followed.

## Safety precautions (continued)

### CAUTION



Prohibited

**Do not place a burning appliance in a place where it is exposed directly to the air from the unit.**

(It could cause an accident as a result of incomplete combustion.)

**Do not use at a place where it is exposed to high temperatures (40°C or higher), naked flames, or in environment with combustible fumes.**

(It could cause fire.)

**Do not use in an environment such as a chemical factory, where hazardous gases such as acidic gases, alkaline gases, organic solvent fumes, paint fumes, or gases containing corrosive components are generated.**

(It could malfunction.)

**Do not install this product in a place where it is exposed to ultraviolet light.**

(UV may damage covering insulation.)

**Do not connect a commercially available drain pump to the designated drain pipe to drain water.**

(Water may leak due to a drain pump malfunction. This may wet the ceiling, floor, and other important objects.)

**Do not install the end of drain piping immersed in places such as rain gutters.**

(At times of heavy snow, rain gutters freeze and drain water is not discharged. This results in water leaking from the unit.)



The instructions given must be followed.

**Put on gloves during installation.**

(It could cause injury.)

**Make sure the all-pole isolator is turned off when the unit is not used for a long period of time after the installation.**

(It could cause electric shock, power leakage, or fire as a result of deteriorated insulation.)

**Always use the specified suspension bolts, nuts and washers or correctly rated wire / chain hangers.**

(Use of hardware with insufficient strength could result in the product dropping.)

**The control box cover must be closed after the installation.**

(Dust or humidity may cause power leakage or fire.)

**Securely connect the drain pipes according to the Installation Manual. Ensure water drainage. Perform insulation work to prevent dew condensation from forming.**

(Insufficient piping work causes water leaks. This may wet the ceiling, floor and other household belongings.)

**Insulate the SA side duct, system components and drain pipes.**

(Dew condensation forming during air conditioning may cause electrical leakage or damage household belongings.)

**When installing the unit in places such as hospitals or communications service stations, take necessary measures to shield noise generating sources.**

# System configuration

## System pattern X [ One remote controller ]

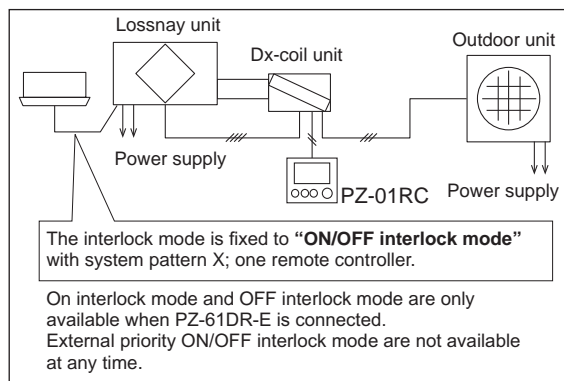
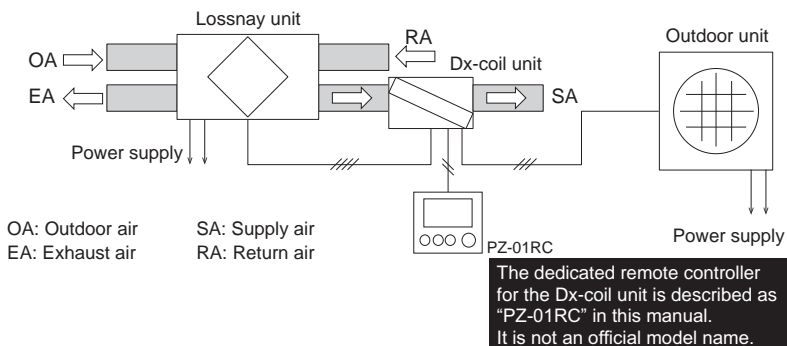

## System pattern Y [ Two remote controllers ]

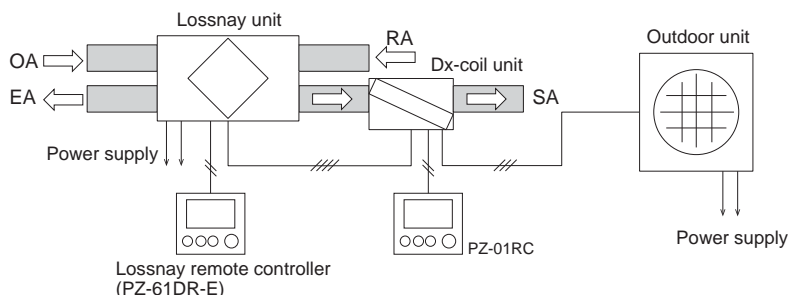

## System pattern Z [ Interlocked with City Multi indoor unit (M-NET connection) ]

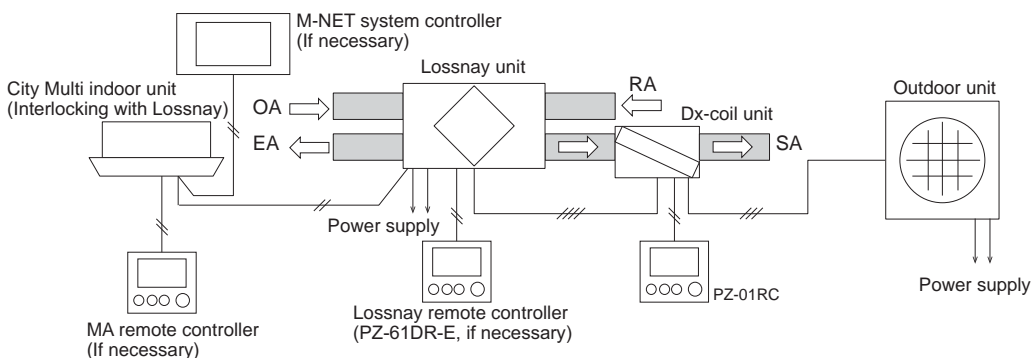

## 1. Operation from remote controllers

	System pattern X	System pattern Y	System pattern Z
ON/OFF	From PZ-01RC	From PZ-01RC or PZ-61DR-E *1	From one of the remote controllers or when the indoor unit is switched ON/OFF *2
Operation mode [Heating/Cooling/Fan]	From PZ-01RC	From PZ-01RC	Only from PZ-01RC *3
Temp. setting	From PZ-01RC	From PZ-01RC	Only from PZ-01RC *3
Fan speed [FS1 / FS2 / FS3 / FS4]	Fixed at FS4 *4	Can be changed from PZ-61DR-E.	Can be changed from PZ-61DR-E, M-NET system controller or MA remote controller (for the indoor unit). The selectable fan speeds depend on the model of remote controller.
Ventilation mode [Heat recovery / Bypass / Auto]	Fixed at automatic mode *5	Can be changed from PZ-61DR-E.	Can be changed from PZ-61DR-E or M-NET system controller.
Remarks	-	-	Dx-coil unit cannot be monitored nor operated from M-NET system controller.

\*1: When one of the two remote controllers is switched ON/OFF, the other remote controller switches ON/OFF synchronously.

\*2: When one of the three remote controllers is switched ON/OFF, the other remote controllers switch ON/OFF synchronously. Or when the indoor unit is switched ON/OFF, the system of the Lossnay unit and Dx-coil unit switches ON/OFF synchronously.

\*3: Cannot be controlled by M-NET system controller nor MA remote controller of the indoor unit.

\*4: Fan speeds can be changed by 0-10VDC input or a volt free contact and can be fixed at the fan speed 3 if necessary.

\*5: The ventilation mode is set to the heat recovery mode during the heating and fan modes.

The ventilation mode can be set to the bypass ventilation mode by a volt-free contact if necessary.

## System configuration (continued)

### 2. Operation ranges

	Lossnay	Dx-coil unit	PZ-01RC
Outdoor air	-15 °C to +40 °C *1	-	-
Return air *2	+40 °C, 80 %RH or less	-	-
Ambient the unit	0 °C to +40 °C, 80 %RH or less	0 °C to +40 °C, 80 %RH or less	0 °C to +40 °C

\*1: -15 °C to -10 °C : Intermittent operation takes 60 min. for ON and 10 min. for OFF.

-15 °C or lower : Intermittent operation takes 55 min. for OFF and 5 min. for ON.

\*2: Air conditioned room air.

Guaranteed operation ranges [Outdoor]	Outdoor unit	
	PUHZ-ZRP35 and 50	PUHZ-ZRP71, 100 and 125
Cooling *3	-15 °C to +46 °C	-15 °C to +46 °C
Heating	-11 °C to +21 °C	-20 °C to +21 °C

\*3: The optional air protection guide is required where the ambient temperature is lower than -5 °C.

### 3. Connectable Lossnay unit and outdoor unit for each function

#### [RA (Return Air) temperature control]

Dx-coil unit	GUG-01SL-E		GUG-02SL-E		GUG-03SL-E		
Connectable Lossnay	LGH-50RVX-E	LGH-65RVX-E	LGH-80RVX-E	LGH-100RVX-E	LGH-150RVX-E LGH-150RVXT-E	LGH-200RVX-E LGH-200RVXT-E	LGH-250RVXT-E
Connectable outdoor unit	PUHZ-ZRP35	PUHZ-ZRP35	PUHZ-ZRP50	PUHZ-ZRP71	PUHZ-ZRP100	PUHZ-ZRP100	PUHZ-ZRP125

#### [SA (Supply Air) temperature control]

Dx-coil unit	GUG-02SL-E		GUG-03SL-E		
Connectable Lossnay	LGH-80RVX-E	LGH-100RVX-E	LGH-150RVX-E LGH-150RVXT-E	LGH-200RVX-E LGH-200RVXT-E	LGH-250RVXT-E
Connectable outdoor unit	PUHZ-ZRP50	PUHZ-ZRP50	PUHZ-ZRP71	PUHZ-ZRP71	PUHZ-ZRP71

Note: GUG-01SL-E cannot be used for the SA temperature control function. Refer to page 12 for pipe size information.

### 4. Technical notes

No.	Item	Contents
1	Fan speed 1 and 2	When Lossnay supply fan is the fan speed 1 or 2, Dx-coil unit always switches thermo-OFF.
2	Night purge	When Lossnay is in Night purge mode, Dx-coil unit always switches thermo-OFF and PZ-01RC is the same as the normal operation screen. PZ-61DR-E or AE-200E is required for the Night-purge function.
3	Heating stops when ambient temp. is 19 °C or higher	[GUG-03SL-E, SA temperature control and heating mode only] When the ambient temperature is 19 °C or higher, Dx-coil unit switches thermo-OFF to protect the compressor of the outdoor unit.
4	Intermittent operation	- When the OA temperature is between -10 °C and -15 °C, Lossnay operates 60 minutes ON and 10 minutes OFF. During the '10 minutes OFF', Dx-coil unit switches thermo-OFF. - When the OA temperature is lower than -15 °C, Lossnay operates 5 minutes ON and 55 minutes OFF. During the '5 minutes ON', Dx-coil unit switches thermo-OFF.
5	Defrost and heating standby mode	During defrost and heating standby mode, Lossnay supply fan stops but exhaust fan continues to run as factory setting.
6	Error indication	During heating or cooling modes, PZ-01RC displays an error code on its screen. During fan mode, PZ-01RC changes to heating mode and displays an error code. If automatic change to heating mode is not required, please set the function No.7 to pattern B. Refer to page 20 for details.
7	Drain pump	The drain pump operates during cooling mode and operates for 6 minutes after Dx-coil unit stops. The drain pump will make a noise while operating.
8	One-to-one connection	For the system, the number of Lossnay unit, Dx-coil unit, PZ-01RC and outdoor unit must be one. Multiple-units connection is prohibited.
9	PZ-43SMF-E PZ-60DR-E	PZ-43SMF-E and PZ-60DR-E are prohibited to use the system of Lossnay and the Dx-coil unit.
10	Interlocking with Mr. Slim indoor unit	Interlocking Mr. Slim indoor unit with Lossnay unit by using CN2L connector is prohibited.
11	One system in one group	If the system is on M-NET, only one system can be used within a group. Multiple systems in one group is prohibited. One system and Lossnay unit(s) in one group is also prohibited.
12	M-NET adapter	Do not use M-NET adapter for the outdoor unit.
13	Apportioned electricity charge function of AE-200E	Not available

# Outlines and dimensions

## GUG-01SL-E, GUG-02SL-E

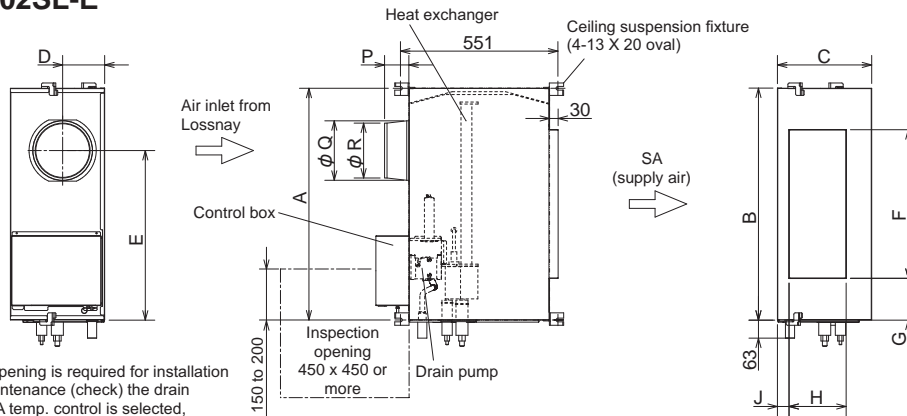

An inspection opening is required for installation and regular maintenance (check) the drain pump. When SA temp. control is selected, another inspection opening may be required in front of the unit for SA thermistor replacement only when an error occurred on the SA thermistor.

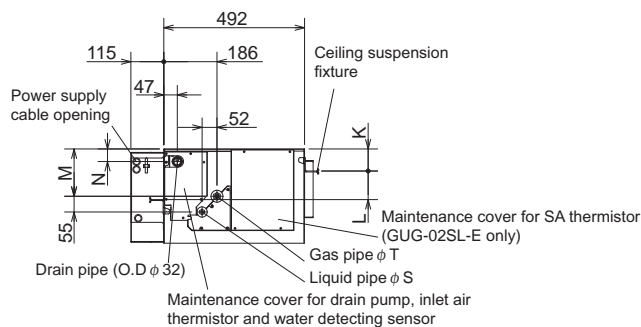

Unit (mm)

Model	A	B	C	D	E	F	G	H	J	K	L	M	N	P	Q	R	S	T	Weight
GUG-01SL-E	811	812	330	147	593	520	146	200	41	77	100	166	44	85	208	192	6.35	12.7	21 kg
GUG-02SL-E	1033	1034	394	170	600	750	132	250	59	56	165	207	86	84	258	242	9.52	15.88	26 kg

## GUG-03SL-E

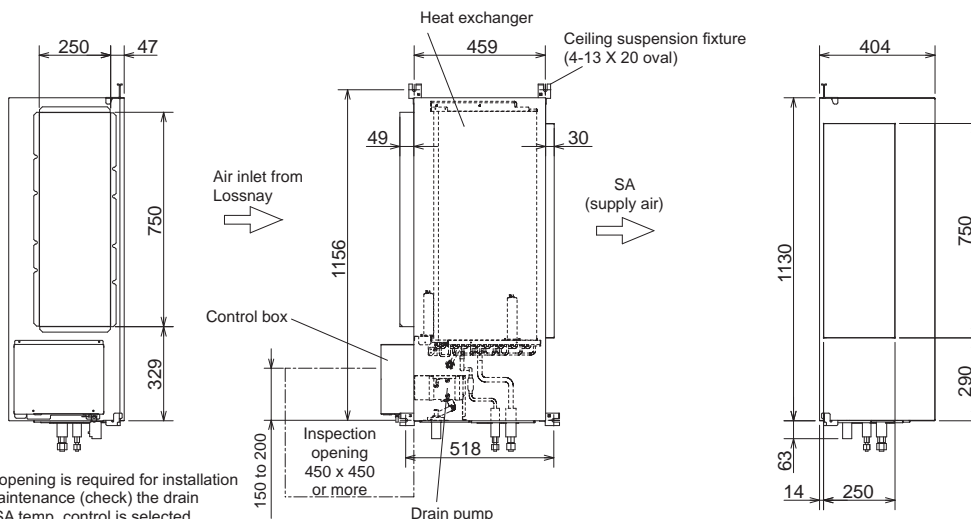

An inspection opening is required for installation and regular maintenance (check) the drain pump. When SA temp. control is selected, another inspection opening may be required in front of the unit for SA thermistor replacement only when an error occurred on the SA thermistor.

Unit (mm)

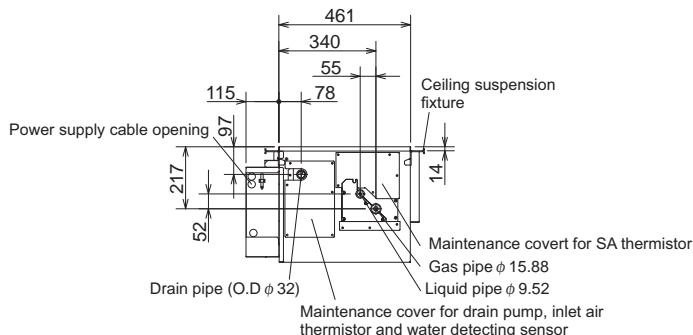

Model	Weight
GUG-03SL-E	28 kg



## Installation examples

### Top view (to install straight duct)

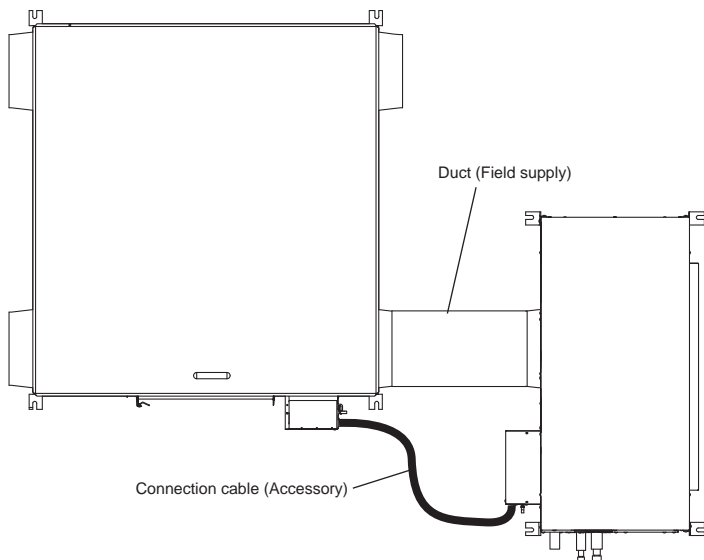

#### Note

- The distance between the Lossnay unit and the Dx-coil unit must be between 25 cm and 5 m when the duct is straight.
- The length of connection cable (accessory) between the two units is about 6 m. Please install the two units so that the cable can be connected.

### Side view (to install with straight duct)

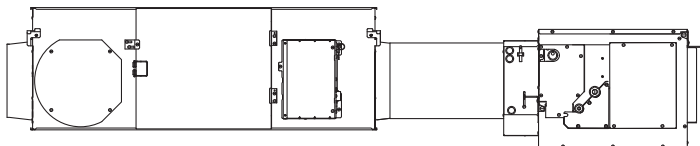

### Side view (to minimize the space with slope duct)

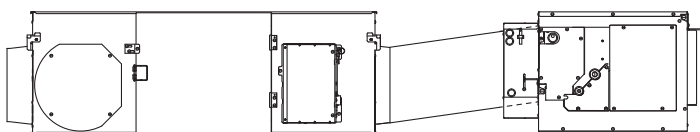

### Top view (to install with bended duct)

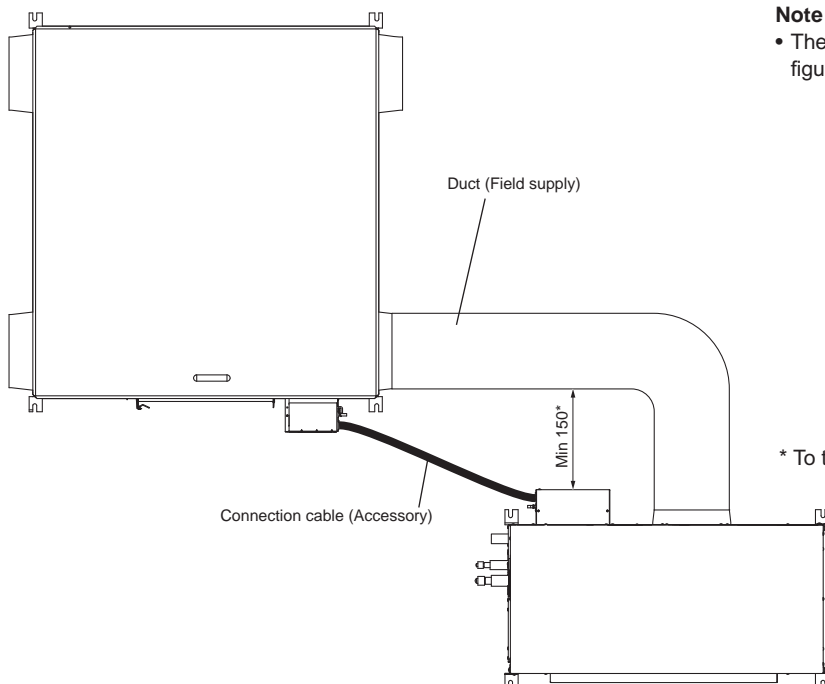



#### Note

- The duct between the two units can be bended like the figure.

\* To take the control cover off.

# Accessory parts

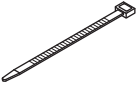
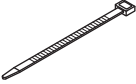
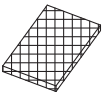
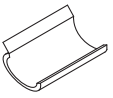
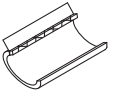
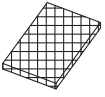
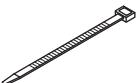
No.	Item	Quantity		Remarks	Figure
		GUG-01/03	GUG-02		
1	Remote controller PZ-01RC	1	1	-	
2	Roundhead cross slot screws M4 x 30	2	2	To install PZ-01RC	
3	Wood screw 4.1 x 16 (For direct wall installation)	2	2		
4	Connection cable (About 6 m)	1	1	To connect between Lossnay unit and Dx-coil unit.	
5	Drain hose	1	1	-	
6	Tie band 200 mm	2	2	-	
7	Tie band 300 mm	2	2	Same as No.17	
8	Glued insulation A	2	2	150 x 60 x 10t	
9	Glued insulation B	1	1	200 x 60 x 10t	
10	Pipe insulation for liquid pipe	1	-	L=180 mm	
11	Pipe insulation for liquid pipe	-	1	L=235 mm	
12	Pipe insulation for gas pipe	1	-	L=160 mm	
13	Pipe insulation for gas pipe	-	1	L=225 mm	
14	Non-glued insulation C	2	-	150 x 100 x 10t	
15	Non-glued insulation D	-	2	165 x 165 x 10t	
16	Non-glued insulation E	-	2	50 x 110 x 10t	
17	Tie band 300 mm	4	4	Same as No.7	

\* No.5 to No.9 are for drain pipe work.

\* No.10 to No.17 are for refrigerant pipe work.

# Installation method

## 1. Preparing the anchor bolts (M12)

Mount the washers (outer diameter of >21 mm for M10, >24 mm for M12) and nuts onto the pre-recessed anchor bolts (M10 or M12), as shown below.

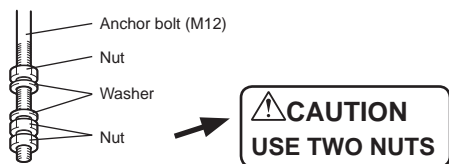

[When using (customer-prepared) vibration isolation rubber]  
When using (customer-prepared) vibration isolation rubber, there is a possibility of this causing a decrease in strength, so we recommend the following construction.

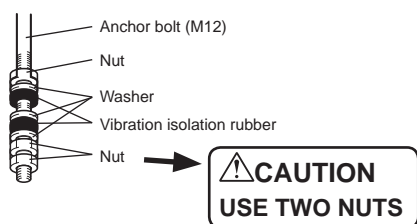

## 2. Mounting Dx-coil unit

- (1) Hang the ceiling suspension fixtures on the anchor bolts.
- (2) Tighten up securely using two nuts.

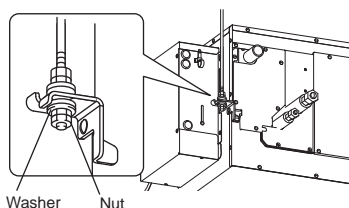

### CAUTION

- When suspending the unit from the ceiling, do not handle it in such a way that force will be applied to the control box.
- Install the anchor bolts to ensure the product's weight or earthquake load. (Correctly rated wire/chain may also be used)
- Install the unit slanted between 0° and 1° and measure the angle like below.
  - To drain water properly, use a spirit level to keep the unit level when suspending. Check that the unit is level by setting the spirit level directly underneath the drain port at the bottom of the unit. After checking, secure the unit and the hanging bolts by firmly tightening the nuts (double nuts for preventing looseness) of the hanging bolts. Maintain the unit ceiling suspension range so that it is level or the drain pipe is below (within 1°).
- If the above installation precautions are not observed, it may cause impurities (such as evaporation residue) in the drainage water due to water not being fully drained and cause water leaks.

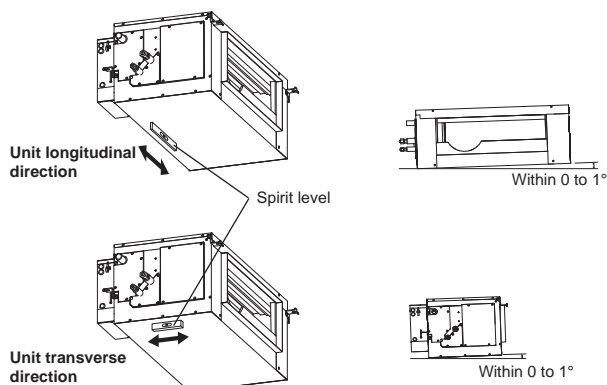

## 3. Connecting duct to Lossnay unit

- (1) The distance between the Lossnay unit and the Dx-coil unit must be between 25 cm and 5 m when the duct is straight. (Refer to page 7)
- (2) Fasten the duct securely to the duct connecting flange, and wrap aluminium tape (field supply) around the joints so that there is no air leakage. Use screw to fix the duct and duct connecting flange not to have air leakage.
- (3) Suspend the ducts from the ceiling so that their weight will not be applied to the Lossnay unit and Dx-coil unit.

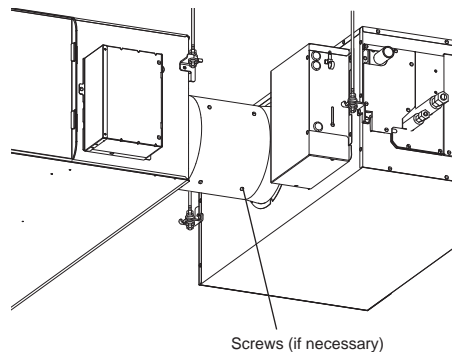

## 4. Connecting the supply duct

- (1) Fasten the duct securely to the duct connecting flange, and wrap aluminium tape (field supply) around the joints so that there is no air leakage.
- (2) Suspend the ducts from the ceiling so that their weight will not be applied to Lossnay unit and Dx-coil unit.
- (3) Supply ducts must be covered with heat insulating material in order to prevent condensation for the surface.

Model	Rectangle duct size
GUG-01SL-E	520 x 200 mm
GUG-02SL-E	750 x 250 mm
GUG-03SL-E	750 x 250 mm

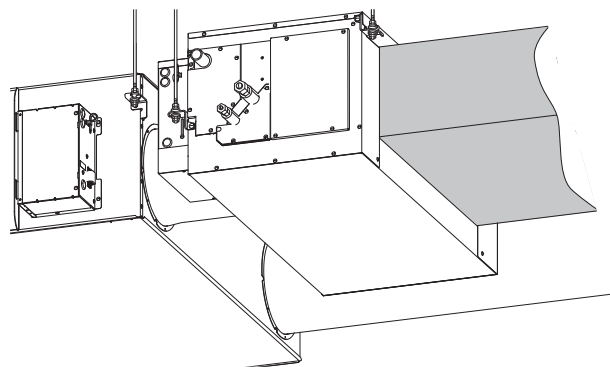

# Drain pipe work

[Fig. 1]

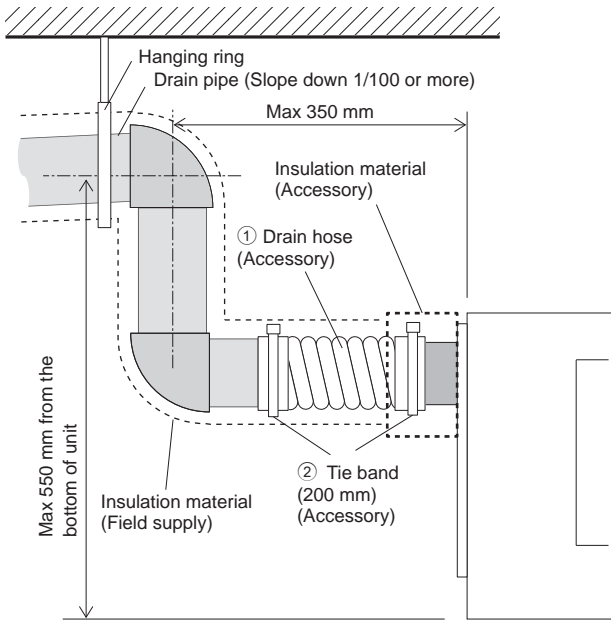

[Fig. ①]

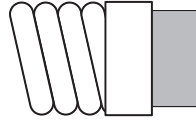

[Fig. ②]

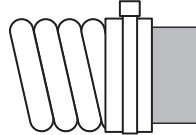

[Fig. ③, ④]

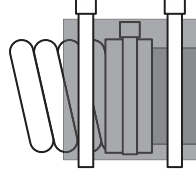

[Fig. ⑤]

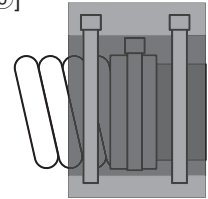

## [Quick step guide]

- ① Insert the drain hose (gray side) into the drain pipe of the unit.
- ② Tighten the drain hose using a tie band (200 mm).
- ③ Wrap the glued insulation A around the drain hose. (Double wound)
- ④ Tighten the glued insulation A using two tie bands (300 mm).
- ⑤ Wrap the glued insulation B around the drain insulation A.

## [Note]

1. Ensure that the drain piping is downward (pitch of more than 1/100) to the outdoor (discharge) side. Do not provide any trap or irregularity on the way.
2. Ensure that any cross-wise drain piping is less than 20 m (excluding the difference of elevation). If the drain piping is long, provide metal braces to prevent it from waving. Never provide any air vent pipe. Otherwise drain may be ejected.
3. Use a hard vinyl chloride pipe (outer diameter 32 mm, field supply) for drain piping.
4. Ensure that collected pipes are 10 cm lower than the unit body's drain port.
5. Do not provide any odor trap at the drain discharge port.
6. Put the end of the drain piping in a position where no odor is generated.
7. Do not put the end of the drain piping in any drain where ionic gases are generated.
8. Insert the drain hose (accessory) into the drain port (insertion margin: 25 mm).  
(The drain hose must not be bent more than 45° to prevent the hose from breaking or clogging.)  
(Attach the hose with glue, and fix it with the band (small, accessory).)
9. Attach the drain pipe. (outer diameter 32 mm, field supply)  
(Attach the pipe with glue, and fix it with the band (small, accessory).)
10. Perform insulation work on the drain pipe and on the socket (including elbow).
11. Check the drainage.
12. Attach the insulating material, and fix it with the band to insulate the drain port.

## [Test run]

Do the test run after electrical installation is complete.

1. Take off the maintenance cover for the drain pump.  
GUG-01, 02SL-E: 7 screws    GUG-03SL-E: 6 screws
2. Put the water (1000 ml) into the drain pan.  
(Please do not pour water into the pump directly.)
3. Switch ON DIP-SW 11-1 of PCB B.
4. Check the drainage.
5. Switch OFF DIP-SW 11-1 of PCB B.
6. Replace the maintenance cover to its original position.

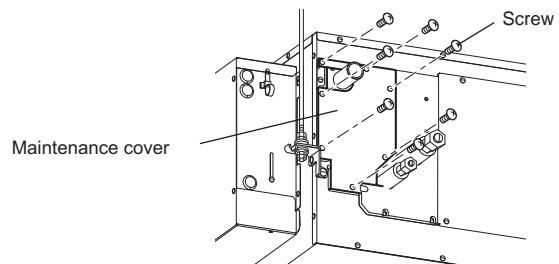

# Refrigerant pipe work

## Precautions

For devices that use R410A refrigerant

- Use ester oil, ether oil or alkylbenzene oil (small amount) as the refrigeration oil applied to the flared sections.
- Use C1220 copper phosphorus for copper and copper alloy seamless pipes, to connect the refrigerant pipes. Use refrigerant pipes with the thicknesses specified in the table below. Make sure the insides of the pipes are clean and do not contain any harmful contaminants such as sulfuric compounds, oxidants, debris, or dust.

### ⚠ WARNING:

When installing or relocating, or servicing the air conditioner, use only the specified refrigerant (R410A) to charge the refrigerant lines. Do not mix it with any other refrigerant and do not allow air to remain in the lines.

If air is mixed with the refrigerant, then it can be the cause of abnormal high pressure in the refrigerant line, and may result in an explosion and other hazards.

The use of any refrigerant other than that specified for the system will cause mechanical failure or system malfunction or unit breakdown. In the worst case, this could lead to a serious impediment to securing product safety.

Pipe size (mm)	φ 6.35	φ 9.52	φ 12.7	φ 15.88
Thickness (mm)	0.8	0.8	0.8	1.0

- Do not use pipes thinner than those specified above.

## Connecting pipes

- When commercially available copper pipes are used, wrap liquid and gas pipes with commercially available insulation materials (heat-resistant to 100 °C or more, thickness of 12 mm or more).
- The indoor parts of the drain pipe should be wrapped with polyethylene foam insulation materials (specific gravity of 0.03, thickness of 9 mm or more).
- Apply thin layer of refrigerant oil to pipe and joint seating surface before tightening flare nut (A).
- Use 2 wrenches to tighten piping connection (B).
- Use refrigerant piping insulation provided to insulate indoor unit connections. Insulate carefully.

### (A) Flare cutting dimensions

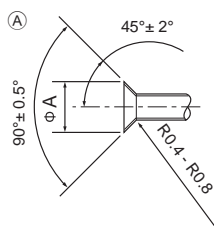

Copper pipe O.D. (mm)	Flare dimensions φ A dimensions (mm)
φ 6.35	8.7 - 9.1
φ 9.52	12.8 - 13.2
φ 12.7	16.2 - 16.6
φ 15.88	19.3 - 19.7
φ 19.05	23.6 - 24.0

### (B) Flare nut tightening torque

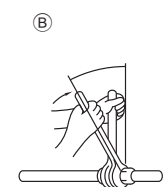

Copper pipe O.D. (mm)	Flare nut O.D. (mm)	Tightening torque (N·m)
φ 6.35	17	14-18
φ 6.35	22	34-42
φ 9.52	22	34-42
φ 12.7	26	49-61
φ 12.7	29	68-82
φ 15.88	29	68-82
φ 15.88	36	100-120
φ 19.05	36	100-120

(C) Apply refrigerating machine oil over the entire flare seat surface.

(D) Use correct flare nuts meeting the pipe size of the outdoor unit.

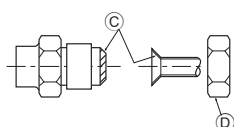

### ⚠ WARNING:

When installing the unit, securely connect the refrigerant pipes before starting the compressor.

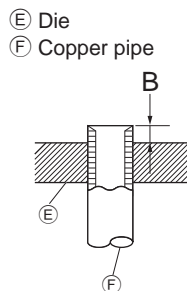

Copper pipe O.D. (mm)	B (mm)	
	Flare tool for R410A	Clutch type
φ 6.35 (1/4")	0 - 0.5	
φ 9.52 (3/8")	0 - 0.5	
φ 12.7 (1/2")	0 - 0.5	
φ 15.88 (5/8")	0 - 0.5	

# Refrigerant pipe work (continued)

## Installation for refrigerant piping

After the refrigerant pipe connection is complete, be sure to apply insulation to the connector (flare connection) using the attached insulated pipe as shown in the following figures.

- Make sure not to leave a gap between the insulated pipe and the indoor units as well as the insulated pipe and the field refrigerant piping.
- Faulty insulation application may cause condensation to form resulting in water leakage.

### Pipe size information

Dx-coil unit	-	GUG-01SL-E	GUG-02SL-E		GUG-03SL-E
Ref. pipe size of unit	A / B	6.35 / 12.7	9.52 / 15.88		9.52 / 15.88
Outdoor unit	-	PUHZ-ZRP35	PUHZ-ZRP50	PUHZ-ZRP71	PUHZ-ZRP71, 100, 125
Ref. pipe size of unit	C / D	6.35 / 12.7	6.35 / 12.7	9.52 / 15.88	9.52 / 15.88
Pipe size between Dx-coil unit and outdoor unit	E / F	6.35 / 12.7	6.35 / 12.7 <sup>*1</sup>	9.52 / 15.88	9.52 / 15.88

\*1: To change the pipe size, PAC-SH30RJ and PAC-SH50RJ need to be installed at Dx-coil unit side.

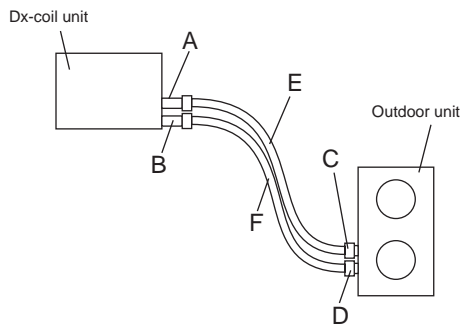

## For GUG-01 and 03SL-E

1. Insert the flare nut in the field refrigerant piping, pull the insulating material when performing flare pipe expansion, and put the insulating material back so that the copper pipe is not exposed.
  - \* Condensation may occur.

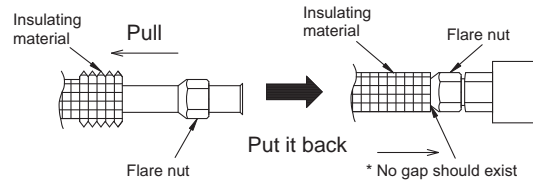

2. Wrap the insulating material around the flare connection and the field refrigerant piping (no gap should exist) and temporarily fix using the tape for piping construction. (It will be clipped by the insulating pipes described in the step 3 to fix.)

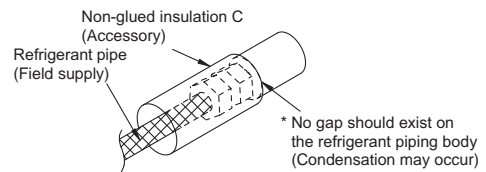

3. Wrap the insulated pipe around the flare area and fix the each insulating pipe with a tie band.
  - \* Be sure to perform construction so as not to leave a gap on the insulated pipe joint area. (Condensation may occur in the flared area.)

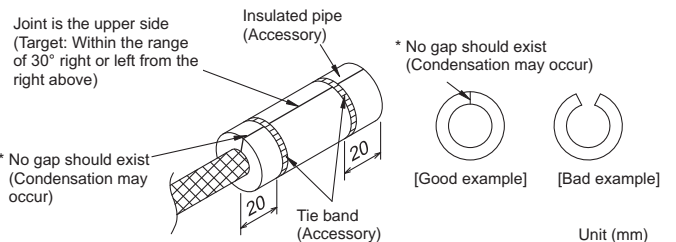
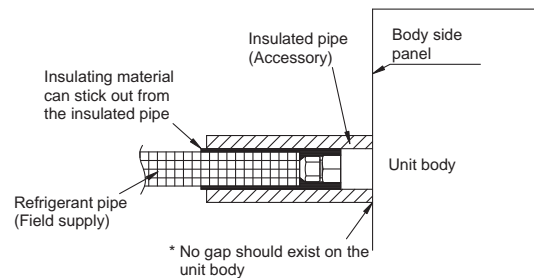

4. Wrap the tape for piping construction around the joint between the insulated pipe and the field refrigerant piping to prevent the insulated joint from being exposed.

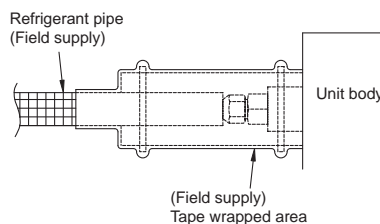

# Refrigerant pipe work (continued)

## For GUG-02SL-E with PUHZ-ZRP71

1. Insert the flare nut in the field refrigerant piping, pull the insulating material when performing flare pipe expansion, and put the insulating material back so that the copper pipe is not exposed.  
\* Condensation may occur.

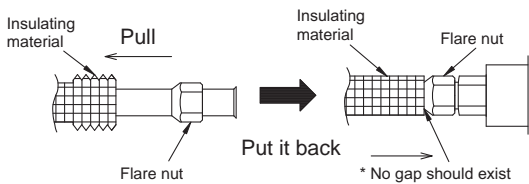

2. Wrap the insulating material around the flare connection and the field refrigerant piping (no gap should exist) and temporarily fix using the tape for piping construction. (It will be clipped by the insulating pipes described in the step 3 to fix.)

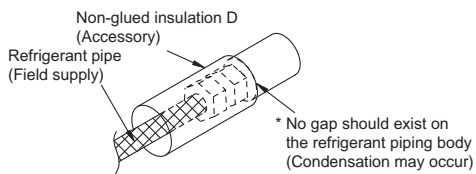

3. Wrap the insulated pipe around the flare area and fix the each insulating pipe with a tie band.  
\* Be sure to perform construction so as not to leave a gap on the insulated pipe joint area. (Condensation may occur in the flared area.)

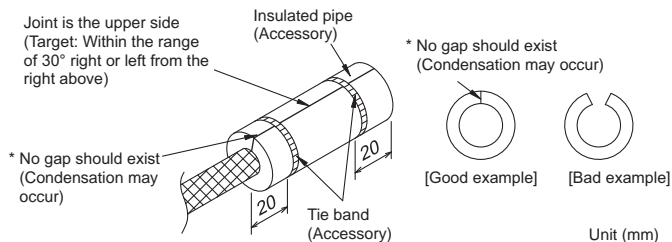
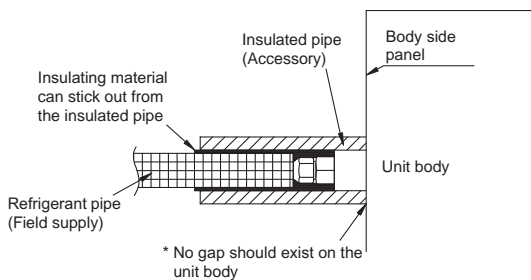

4. Wrap the tape for piping construction around the joint between the insulated pipe and the field refrigerant piping to prevent the insulated joint from being exposed.

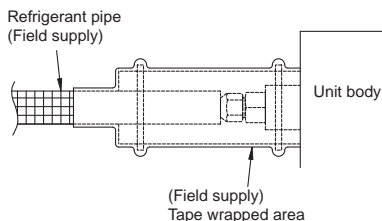

## For GUG-02SL-E with PUHZ-ZRP50

- Use  $\Phi 12.7$  mm for gas pipe and  $\Phi 6.35$  mm for liquid pipe.  
Both PAC-SH30RJ-E and PAC-SH50RJ-E are necessary.
1. Attach PAC-SH30RJ-E and PAC-SH50RJ-E to refrigerant pipes of Dx-coil unit. For details, refer to their manual.
  2. Insert the flare nut in the field refrigerant piping, pull the insulating material when performing flare pipe expansion, and put the insulating material back so that the copper pipe is not exposed.  
\* Condensation may occur.

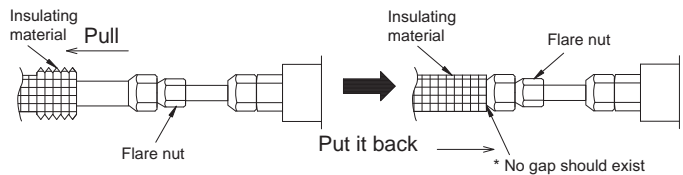

3. Wrap the insulating material E and D around the flare connection and the field refrigerant piping (no gap should exist) and temporarily fix using the tape for piping construction. (It will be clipped by the insulating pipes described in the step 4 to fix.)

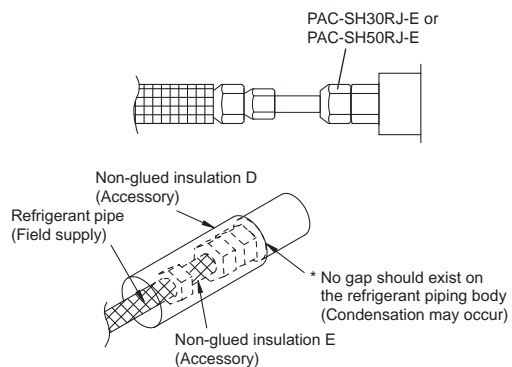

4. See No.3 on the Left.
5. See No.4 on the Left.

# Electrical installation

## Electrical installation

With this product, the wiring installation method will vary according to the design of the system.

Perform electrical installation to meet local electrical regulations.

\* Always use double insulated PVC cable for the transmission cables.

\* Wiring work must be performed by qualified professionals.

\* All supply circuits must be disconnected before obtaining access to the terminal devices.

## Names of components in control box

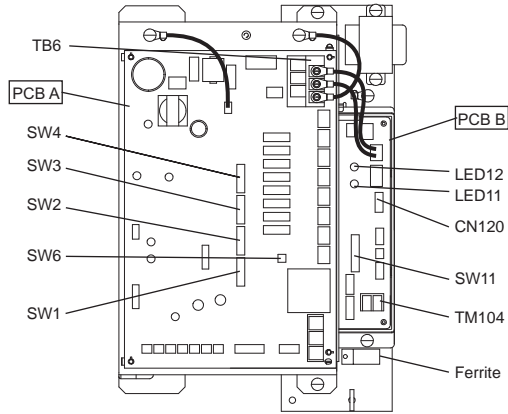

### 1. Remove the black screws and the control box cover

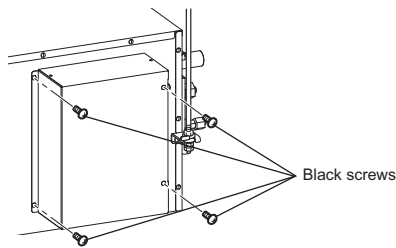

### 2. Connecting the power supply cable

Pass the power supply cable through the bush\* and connect to the TB6 terminal block using the round terminals. Connect the ground wire to the screw and secure tightening the bush. (\* Use an item that can firmly secure the cable such as a PG connector.)

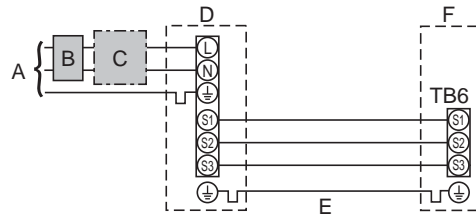
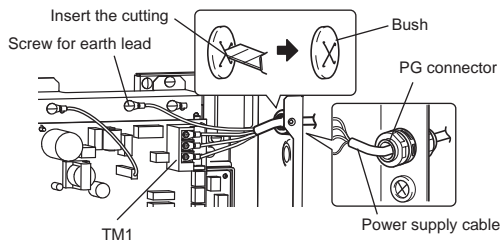

- A Outdoor unit power supply
- B Earth leakage breaker \*1, \*2
- C Wiring circuit breaker or isolating switch
- D Outdoor unit
- E Dx-coil unit/outdoor unit connecting cables
- F Dx-coil unit

- \*1. If the installed earth leakage circuit breaker does not have a function to protect over-current, install a breaker with that function along the same power line.
- \*2. A breaker with at least 3.0 mm contact separation in each pole shall be provided. Use earth leakage breaker (NV).  
The breaker shall be provided to ensure disconnection of all active phase conductors of the supply.

#### Note

In accordance with IEE regulations the circuit breaker/isolating switch located on the outdoor unit should be installed with lockable devices (health and safety).

Wiring Wire No. x size (mm <sup>2</sup> )	Dx-coil unit - Outdoor unit	*3	4 x 0.75 (polar)
	Dx-coil unit - Outdoor unit earth	*3	
Circuit rating	Dx-coil unit - Outdoor unit S1-S2	*4	230 V AC
	Dx-coil unit - Outdoor unit S2-S3	*4	24 V DC

\*3. Max. 45 m

\*4. The values given in the table are not always measured against the ground value.

#### Notes

1. Wiring size must comply with the applicable local and national code.
2. Dx-coil unit/outdoor unit connecting cords shall not be lighter than polychloroprene sheathed flexible cord. (Design 60245 IEC 57)  
Dx-coil unit power supply cords shall not be lighter than polychloroprene sheathed flexible cord. (Design 60227 IEC 53)
3. Install an earth longer than other cables.

#### ⚠ CAUTION

- Always separate the power supply cable and transmission cable by 5 cm or more to prevent malfunctioning of the unit.
- If the length of the stripped Power supply cable is too long, the conductors may touch and short out.
- Do not tighten screws of terminal block with a torque larger than 0.5 Nm. It could damage the PCB.



## Electrical installation (continued)

### 3. Connecting PZ-01RC

Securely connect the transmission cable from the remote controller to the input terminal block (TM104). (No polarity)

Wire type: two-core sheathed cable

Wire diameter: 0.3 mm<sup>2</sup>

Keep the overall length of the transmission cable between Dx-coil unit and the remote controller within 200 m.

#### Note

- Do not tighten screws of terminal block with a torque larger than 0.5 Nm. It could damage the PCB.
- Do not connect the power supply cable.
- Remote controller cable should be rotated 3 times around the ferrite.
- Single wires such as PVC wires cannot be connected.

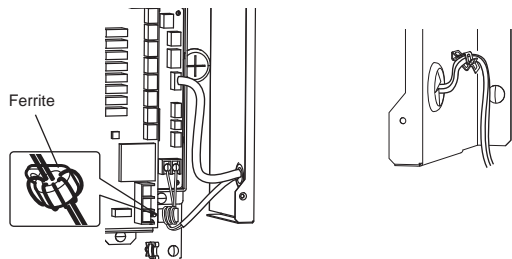

### 4. Connecting the lead wire cable (accessory)

Connect the lead wire cable (accessory) to CN120 (GREEN) on PCB B of Dx-coil unit and CN20 (GREEN) on PCB of Lossnay unit.

#### Dx-coil unit side

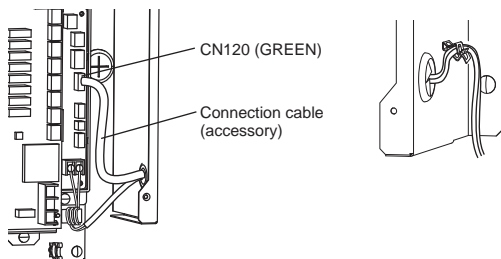

#### Lossnay unit side

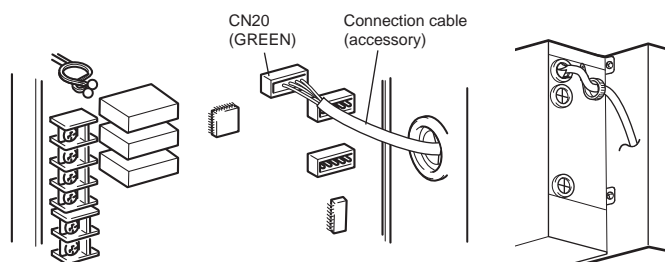

# Electrical installation (continued)

## Wiring diagram

### Note

1. TB6, TM104 and CN120 shown in dotted lines are field work.
2. Make sure to connect the ground wire.
3. Prior to access the electrical parts cut off the power supply (all to Dx-coil unit, Lossnay unit and outdoor unit) more than five minutes.
4. The appliance shall be installed in accordance with national wiring regulations.

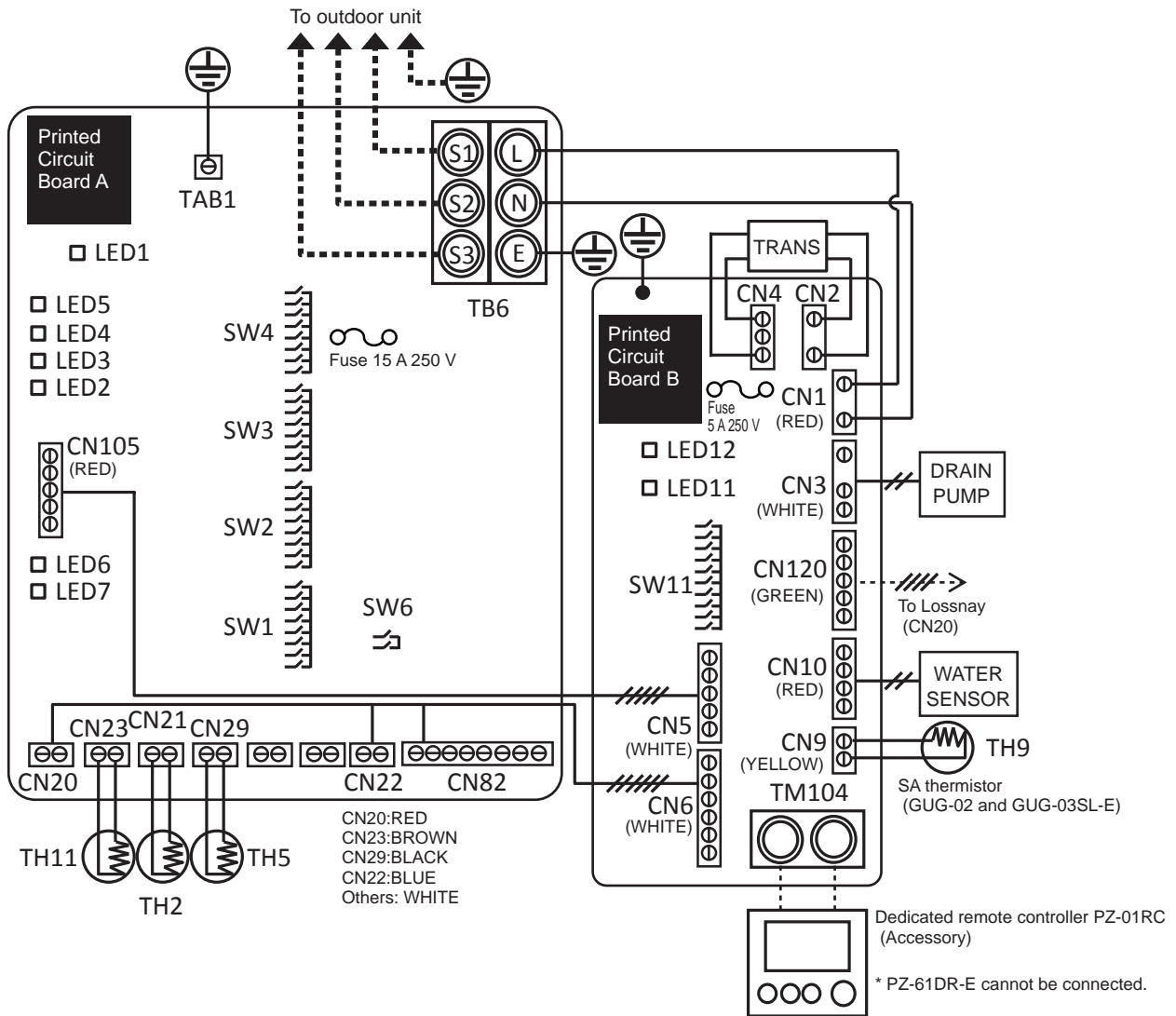

### Definition of symbols

Printed circuit board A	Printed circuit board B
TB6 : Terminal for power supply from the outdoor unit	TM104 : Terminal for remote controller PZ-01RC
TAB1 : Connector (Ground)	SW11 : Switch (Function selection)
SW1-SW4 : Switch (Function selection)	LED11 : Inspection indicator lamp
SW6 : Switch (Function selection)	LED12 : Power supply indicator lamp
LED1 : Power supply indicator lamp	CN1 : Connector (Power supply)
LED2-5 : Operation status	CN2 : Connector (Transformer primary)
LED6, 7 : Reading or writing data to SD card	CN3 : Connector (Drain pump)
CN105 : Connector (IT communication)	CN4 : Connector (Transformer secondary)
CN20 : Connector (TH1, software use)	CN5 : Connector (IT communication)
CN21 : Connector (TH2, liquid pipe temp.)	CN6 : Connector (Output to PCB A)
CN22 : Connector (Remote controller)	CN9 : Connector (TH9, supply air temp.)
CN23 : Connector (TH11, inlet air temp.)	CN10 : Connector (Water sensor)
CN29 : Connector (TH5, gas pipe temp.)	CN120 : Connector (Communication to Lossnay)
CN82 : Connector (Forced comp. OFF)	⊙ : Terminal block
⊙ : Terminal block	⊖ : Connector on PCB
⊖ : Connector on PCB	

# Initial setting

## 1. Select the function switches

No.	Function outline	PCB	Switch No.
1	Selecting of RA temp. control or SA temp. control	PCB A of Dx-coil unit	SW1-7
2	Fixed operation mode		SW2-1, 2-2
3	Fixed set temperature		SW2-3, 2-4, 2-5
4	Thermo OFF point by the inlet air temp. (Only in SA temp. control mode) * For SA temp. control only"		SW3-4, 3-5
5	Test run of the drain pump	PCB B of Dx-coil unit	SW11-1
6	Resetting the operation hour of the drain pump		SW11-2
7	Selecting of the operation when an error occurs		SW11-3
8	Model selection (For PCB replacement)		SW11-9, 11-10
9	Setting about whether or not Dx-coil unit is connected	PCB of Lossnay unit	SW7-1
10	Selecting of the operation mode from "Temp. priority mode" or "Fan speed priority mode"		SW7-2

### No. 1 Selecting of RA temp. control or SA temp. control

Set the SW1-7 as below.

PCB	SW1-7	Setting check	Contents
PCB A of Dx-coil unit	OFF		SA temp. control
	ON (Factory setting)		RA temp. control

#### [RA (Return Air) temperature control (Factory setting)]

The system of the Lossnay unit and Dx-coil unit is designed to maintain the return air temperature close to the setting temperature.

#### [SA (Supply Air) temperature control]

The system of the Lossnay unit and Dx-coil unit is designed to maintain the supply air temperature close to the setting temperature.

GUG-01SL-E cannot be used for SA temperature control.

\* The setting temperature is recommended to be the same as or close to the setting temperature of the air conditioning unit.

### No. 2 Fixed operation mode

Set the SW2-1 and SW2-2 as below.

PCB	SW2-1	SW2-2	Setting check	Contents
PCB A of Dx-coil unit	OFF	OFF		Not fixed (Depending on remote controller) (Factory setting)
	ON	OFF		[Cooling] fixed
	OFF	ON		[Heating] fixed
	ON	ON		Do not set

When the operation mode is fixed, the mode cannot be changed from the remote controller PZ-01RC.

### No. 3 Fixed set temperature

Set the SW2-3, SW2-4 and SW2-5 as below.

PCB	SW2-3	SW2-4	SW2-5	Setting check	Contents
PCB A of Dx-coil unit	OFF	OFF	OFF		Not fixed (Remote controller setting) (Factory setting)
	ON	OFF	OFF		Cooling, Auto 19 °C/ Heating 17 °C fixed
	OFF	ON	OFF		20 °C fixed
	ON	ON	OFF		22 °C fixed
	OFF	OFF	ON		24 °C fixed
	ON	OFF	ON		26 °C fixed
	OFF	ON	ON		28 °C fixed
	ON	ON	ON		Cooling 30 °C/ Heating, Auto 28 °C fixed

When the target temperature is fixed, the setting temp. cannot be changed from the remote controller PZ-01RC.

### No. 4 Thermo OFF point by the inlet air temp. (Only in SA temp. control mode)

This setting is only activate when SA temperature control is selected. The compressor of outdoor unit is forced to stop when the inlet air temp. is close to the setting temp. to reduce frequent ON/OFF cycling under low heating/cooling load conditions.

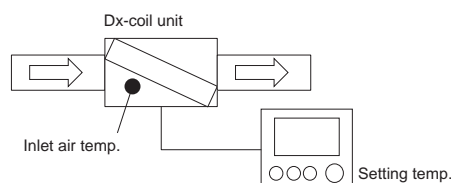

The thermo OFF point can be set by the SW3-4 and SW3-5 as below.

PCB	SW3-4	SW3-5	Setting check	Contents
PCB A of Dx-coil unit	OFF	OFF		1 °C
	OFF	ON		2 °C
	ON	OFF		3 °C (Factory setting)
	ON	ON		4 °C

When the differential is small, Dx-coil unit is likely to be thermo-ON but also the ON/OFF cycling is likely to happen.

## Initial setting (continued)

### No. 5 Test run of the drain pump

See page 10 for the procedure of the test run for the drain pump.

### No. 6 Resetting the operation hour of the drain pump

After 2100 operation hours in the cooling mode, the LED11 will flash (flashes ten times).

If the drain pump is checked or replaced with a new one, please set the SW11-2 to ON and back to OFF to reset the operation hours.

Please refer to the operating manual for more detailed information about the requirement of inspection and replacement.

### No. 7 Selecting of the pattern when an error occurs

Please choose the following pattern. This selection must be done for the system X (one remote controller system).

When the system is OFF (stopping), an error code will NOT be displayed on the remote controller PZ-01RC.

For system Y and Z, an error code will be displayed on PZ-61DR-E and/or M-NET system controller.

PCB	SW11-3	Setting check	Contents
PCB B of Dx-coil unit	OFF (Factory setting)		Pattern A
	ON		Pattern B

#### [Pattern A (Factory setting)]

When Lossnay unit, Dx-coil unit or Outdoor unit has an error during the Fan mode, the remote controller PZ-01RC display will be changed automatically to the Heating mode. Then the error code will be displayed about 3 minutes later.

#### [Pattern B]

Even when Lossnay unit, Dx-coil unit or Outdoor unit has an error during the Fan mode, the error code will NOT be displayed on the remote controller PZ-01RC.

Please prepare the error indicator by the other way.

### No. 8 Model selection (For PCB replacement)

Check the model selection switches.

SW 11-9 and 11-10 on PCB B is to identify the model for PCB. When replacing to a new PCB, use the same setting as old one or an indicated below.

PCB	SW11-9	SW11-10	Setting check	Contents
PCB B of Dx-coil unit	OFF	OFF		New PCB for replacement
	ON	OFF		GUG-01SL-E
	OFF	ON		GUG-02SL-E
	ON	ON		GUG-03SL-E

\* Do not change from factory setting.

If changed, please set as the factory setting.

### No. 9 Setting whether or not the Dx-coil unit is connected

Set the SW7-1 as below.

DIP-SW		Setting check	PZ-61DR-E		Setting check	Contents
SW No.	Setting		Function No.	Setting data		
SW7-1 (PCB of Lossnay unit)	-	-	71	0 (Factory setting)		DIP-SW priority
	OFF (Factory setting)			1		When the Dx-coil unit is NOT connected to Lossnay
	ON			2		When the Dx-coil unit is connected to Lossnay

Please set SW7-1 ON.

This function can also be set from PZ-61DR-E. After setting it from PZ-61DR-E, please power off for more than two minutes. And then power on again.

When SW7-1 is ON but the lead wire cable (accessory) is not connected properly, error code 0206 will be displayed. Please check if the cable is connected properly.

### No. 10 Selection of the operation mode from "Temp. priority mode" or "Fan speed priority mode"

Set the SW7-2 as below.

DIP-SW		Setting check	PZ-61DR-E		Setting check	Contents
SW No.	Setting		Function No.	Setting data		
SW7-2 (PCB of Lossnay unit)	-	-	72	0 (Factory setting)		DIP-SW priority
	OFF (Factory setting)			1		Temp. priority mode
	ON			2		Fan speed priority mode

This function can also be set from PZ-61DR-E.

This function needs to be set when Lossnay unit's fan speed is controlled by an external input (0-10VDC (CN26) or a volt-free contact (CN17)).

#### [Temp. priority mode (Factory setting)]

Only when operation mode is in the Fan mode, the external fan speed control can be used. The Dx-coil unit will keep thermo-ON as much as possible. In heating and cooling mode, the fan speed of Lossnay unit will not become fan speed 1 or 2.

#### [Fan speed priority mode]

External fan speed control is available. The ventilation airflow will be reduced to minimum.

During fan speed 1 or 2, Dx-coil unit is thermo-OFF.

Operation mode	Fan speed order from external input	Actual fan speed	
		Temp. priority mode	Fan speed priority mode
Heating or Cooling	FS4	FS4	FS4
	FS3	FS3	FS3
	FS2	FS3	FS2
	FS1	FS3	FS1
Fan	FS4	FS4	FS4
	FS3	FS3	FS3
	FS2	FS2	FS2
	FS1	FS1	FS1

#### Note

When the indoor negative pressure setting (1 down) is selected, please use Fan speed priority mode.

## Initial setting (continued)

### No. 10 Selection of the operation mode from “Temp. priority mode”, “Fan speed priority mode” or “Fan speed priority mode after temp. priority mode” (Revised)

[Note] This function is only available for the Lossnay unit manufactured later than September 2016, whose serial No. is 16090001 or greater. Software version indicated by the stamp above DIP SW-2 on PCB of Lossnay unit is “06” or greater.

Set the SW7-2, SW7-3 or PZ-61DR-E as below.

DIP-SW		Setting check	PZ-61DR-E		Setting check	Contents
SW No.	Setting		Function No.	Setting data		
SW7-2 SW7-3 (PCB of Lossnay unit)	-	-	72	0 (Factory setting)		DIP-SW priority
	7-2 OFF 7-3 OFF (Factory setting)			1		Temp. priority mode
	7-2 ON 7-3 OFF			2		Fan speed priority mode
	7-2 OFF 7-3 ON			3		Fan speed priority mode after 1 hour temp. priority mode
	-	-		4		Fan speed priority mode after 1.5 hours temp. priority mode
	7-2 ON 7-3 ON			5		Fan speed priority mode after 2 hours temp. priority mode
	-	-		6		Fan speed priority mode after 2.5 hours temp. priority mode
	-	-		7		Fan speed priority mode after 3 hours temp. priority mode
	-	-		8		Fan speed priority mode after 3.5 hours temp. priority mode
	-	-		9		Fan speed priority mode after 4 hours temp. priority mode

#### [Temp. priority mode (Factory setting)] (Not changed)

Only when operation mode is in the Fan mode, the external fan speed control can be used. The Dx-coil unit will keep thermo-ON as much as possible. In heating and cooling mode, the fan speed of Lossnay unit will not become fan speed 1 or 2.

#### [Fan speed priority mode] (Not changed)

External fan speed control is available. The ventilation airflow will be reduced to minimum. During fan speed 1 or 2, Dx-coil unit is thermo-OFF.

#### [Fan speed priority mode after temp. priority mode] (Added)

The Lossnay unit starts with “temp. priority mode” for setting hours, and then changes to “fan speed priority mode” automatically. This automatic change is only available after the system stops for more than 2 hours.

## 2. Check the switches

The DIP-SW below must be set as the factory setting. If changed, please set to the factory setting.

PCB	Switch No.	Setting	
PCB A of Dx-coil unit	SW1-2 SW1-3 SW1-6	Must be ON	
	SW1-1 SW1-4 SW1-5 SW1-8 SW2-6~2-8 SW3-1~3-3 SW3-6~3-8 SW4-1~4-8 SW6-1~6-2	Must be OFF	
	PCB B of Dx-coil unit	SW11-4~11-8	Must be OFF
	PCB of Lossnay unit	SW7-3~7-10	Must be OFF

## 3. Lossnay unit functions

The table below shows the Lossnay unit functions that cannot be used or restricted when the Dx-coil unit is connected.

No.	Function	Remarks
5	Automatic recovery setting after power interruption	Before setting this function, set function No.1 of PZ-01RC as Not available. Refer to page 20 for more details.
6	Indoor negative pressure setting [2 down]	Dx-coil unit can be set to thermo-ON when the supply fan is operating at FS3 or FS4. If “2 down” is activated, Dx-coil unit will NOT thermo-ON.
15	Interlock mode setting	“External input given priority” is prohibited to use.
38	Calculated supply air temperature display setting	“Calculated supply air temperature” will be different from the supply air temperature from Dx-coil unit.
51	Automatic ventilation mode	Even when an indoor unit is interlocked with Lossnay unit, Lossnay unit uses the conditions of setting temp. and mode (cooling/heating/fan) of Dx-coil unit for automatic ventilation mode.
57	Prohibition of use of after-heater	By using the operation monitor output, Lossnay unit can be connected to after-heater. However, use of after-heater in conjunction with Dx-coil unit is prohibited.

\* No. in the table shows the function setting No. in Lossnay unit installation manual and the technical manual.

# Remote controller (PZ-01RC)

## Note

Lossnay remote controller is not described in this section. Please refer to its installation manual and instruction book.

## 1. Installation

For the contents below, refer to the appendix of this installation manual.

No.	Contents	Refer to appendix
1	Safety precautions	page 1
2	System requirements	page 3
3	Component names and supplied parts	page 3
4	Field-supplied parts/Required tools	page 4
5	Selecting an installation site	page 4
6	Installation/Wiring work	page 5
7	Important	page 8
8	Remote controller button functions	page 9
9	Turning on the power	page 10
10	Test run	page 10
11	Initial settings (Remote controller settings)	page 10
12	Service menu	page 13
13	Remote controller check	page 16

## 2. Menu list

The table below shows the function menu that can be used.

Main menu		Remarks
Vane/Louvre/Vent. (Lossnay)	Not available	-
High power	Not available	-
Timer		
On/Off timer	Available	*4
Auto-Off timer	Available	*4
Weekly timer	Available	*4
OU silent mode	Not available	-
Restriction		
Temp. range	Available	*5
Operation locked	Available	*5
Energy saving		
Auto return	Available	*5
Schedule	Not available	-
Filter information	Not available	*5
Error information	Available	*5
Maintenance		
Auto descending panel	Not available	-
Manual vane angle	Not available	-
Initial setting		
Main/Sub	Available	*1
Clock	Available	*5
Main display	Available	*5
Contrast	Available	*5
Display details	Available	*3
Auto mode	Available	*2
Administrator password	Available	*5
Language selection	Available	*5
Service		
Test run	Available	*5
Drain pump test run	Not available	-
Input maintenance info.	Available	*5
Function setting	Available	*5
Check	Available	*5
Request code	Available	*5
Other than request code	Not available	-
Self check	Available	*5
Maintenance password	Available	*5
Remote controller check	Available	*5

\*1: Two remote controllers cannot be used in a system, so please do not change from the factory setting.

\*2: Auto mode is only available for the RA temperature control.

\*3: Setting change is required for the SA temperature control. Please see the next page.

\*4: When PZ-61DR-E is also used, set the timer function from PZ-61DR-E.

\*5: How to use and how to set are the same way as MA remote controller PAR-31MAA, so please refer to the appendix in the installation manual and instruction book.

## 3. Initial setting

(1) For the SA temp. control, set the Room temperature not to be displayed using the following steps.

### Note

For the RA temp. control, if the display is necessary please skip this setting.

[Default display]

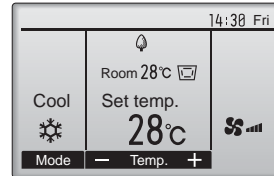

[Step1]

From the Main display, select "Main menu" -> "Initial setting" -> "Display details".

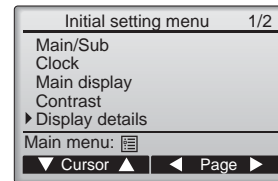

[Step2]

Move the cursor to the "Room temp." on the display details setting screen, and select "No" with the F3 or F4 button. (Factory setting is "Yes".)

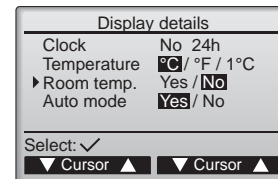

[Step3]

Check that "Room temperature" is not displayed.

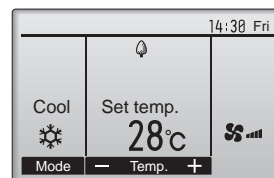

## Remote controller (PZ-01RC)

(2) Function setting from remote controller PZ-01RC.

(Automatic recovery setting)

[Function No.01]

**Please change this function to “Not available”.**

If automatic recovery needs to be used, set it from Lossnay unit. Refer to the Lossnay installation manual for details.

Function No.	Setting data	Setting check	Contents
01	1		Not available
	2 (Factory setting)		Available

The function setting below must be set as the factory setting.

If changed, please set to the factory setting.

No.	Factory setting data
02	1
03	1
04	2
05	2
06	2
07	3
15	1
16	1
17	1
21	1
24	2
28	2

### Note

The factory setting of No.08, 09, 10, 11, 12, 13, 14, 18, 19, 20, 22, 23, 25, 26 and 27 are not set and the function is not available.

## Check points

After installation work, please double-check the points below. If there is any trouble, it must be done correctly.

### (1) Check points - Unit installation

- |  |   |         |
|--|---|---------|
| <input type="checkbox"/> Is the insulation wrapped around the outside ducts?   | [Refer to Installation method]                    | page 9  |
| <input type="checkbox"/> Is the outside ducts installed correctly?   | [Refer to Installation examples]                  | page 7  |
| <input type="checkbox"/> Has the heat insulating work been completed for refrigerant and drain pipes?                                  | [Refer to Drain pipe work, Refrigerant pipe work] | page 10 |
| <input type="checkbox"/> Are refrigerant and drain pipes correctly routed?   | [Refer to Drain pipe work, Refrigerant pipe work] | page 10 |
| <input type="checkbox"/> Is the refrigerant R410A?   | [Refer to Refrigerant pipe work]                  | page 11 |
| <input type="checkbox"/> Has the gas leak test been conducted?   | [Refer to Refrigerant pipe work]                  | page 11 |
| <input type="checkbox"/> Has the drainage check been finished?   | [Refer to Drain pipe work]                        | page 10 |
| <input type="checkbox"/> Have the valves at both the higher and the lower pressure sides been checked to be fully open? [Outdoor unit] |   |         |
| <input type="checkbox"/> Has power been supplied for 12 hours or more before test run?   | [Refer to Test run]                               | page 22 |

### (2) Check points - Wiring work

- |  |  |         |
|--|--|---------|
| <input type="checkbox"/> Is the power supply voltage correct?                                      | [Outdoor unit]                               |         |
| <input type="checkbox"/> Is the wiring work the same as wiring diagram?                            | [Refer to Wiring diagram]                    | page 16 |
| <input type="checkbox"/> Is the power supply cable connected to the terminal (TB6) certainly?      | [Refer to Connecting the power supply cable] | page 14 |
| <input type="checkbox"/> Is the ground cable connected to the screw certainly?                     | [Refer to Connecting the power supply cable] | page 14 |
| <input type="checkbox"/> Are the cables properly secured using the cord clip and the PG connector? | [Refer to Connecting the power supply cable] | page 14 |



# Test run

## Before test run

- ▶ After completing installation and the wiring and piping of the indoor and outdoor units, check for refrigerant leakage, looseness in the power supply or control wiring, wrong polarity, and no disconnection of one phase in the supply.
- ▶ Use a 500-volt megohmmeter to check that the resistance between the power supply terminals and ground is at least 1.0 MΩ.
- ▶ Do not carry out this test on the control wiring (low voltage circuit) terminals.

### ⚠ WARNING:

- **Do not use the Dx-coil unit if the insulation resistance is less than 1.0 MΩ.**
- **Turn on the power at least 12 hours before starting operation.**
- Starting operation immediately after turning on the main power switch can result in severe damage to internal parts. Keep the power switch turned on during the operational season.

## Test run

- Make sure to read operation manual before test run. (Especially items to secure safety)

### Step 1 Turn on the power.

- Remote controller: The system will go into startup mode, and the remote controller power lamp (green) and "PLEASE WAIT" will blink. While the lamp and message are blinking, the remote controller cannot be operated. Wait until "PLEASE WAIT" is not displayed before operating the remote controller. After the power is turned on, "PLEASE WAIT" will be displayed for approximately 2 minutes.
- PCB A of Dx-coil unit: LED 1 will be lit up, LED 2 will be lit up or off, and LED 3 will blink.
- Outdoor controller board: LED 1 (green) and LED 2 (red) will be lit up. (After the startup mode of the system finishes, LED 2 will be turned off.) If the outdoor controller board uses a digital display, [-] and [-] will be displayed alternately every second. If the operations do not function correctly after the procedures in step 4 and thereafter are performed, the following causes should be considered and eliminated if they are found.  
(The symptoms below occur during the test run mode. "Startup" in the table means the LED display written above.)
- When the system of Lossnay unit and Dx-coil unit is in M-NET, please wait until M-NET system is ready to use.

Symptoms in test run mode		Cause
Remote Controller Display	OUTDOOR BOARD LED Display < > indicates digital display.	
Remote controller displays "PLEASE WAIT", and cannot be operated.	After "startup" is displayed, only green lights up. <00>	• After power is turned on, "PLEASE WAIT" is displayed for 2 minutes during system startup. (Normal)
After power is turned on, "PLEASE WAIT" is displayed for 3 minutes, then error code is displayed.	After "startup" is displayed, green(once) and red(once) blink alternately. <F1>	• Incorrect connection of outdoor terminal block (R, S, T and S <sub>1</sub> , S <sub>2</sub> , S <sub>3</sub> .)
	After "startup" is displayed, green(once) and red(twice) blink alternately. <F3, F5, F9>	• Outdoor unit's protection device connector is open.
No display appears even when remote controller operation switch is turned on. (Operation lamp does not light up.)	After "startup" is displayed, green(twice) and red(once) blink alternately. <EA, Eb>	• Incorrect wiring between the indoor and outdoor unit (Polarity is wrong for S <sub>1</sub> , S <sub>2</sub> , S <sub>3</sub> .)
	After "startup" is displayed, only green lights up. <00>	• Remote controller transmission wire short. • There is no outdoor unit of address 0. (Address is other than 0.)
Display appears but soon disappears even when remote controller is operated.	After "startup" is displayed, only green lights up. <00>	• Remote controller transmission wire open. • After canceling function selection, operation is not possible for about 30 seconds. (Normal)

### Step 2 Lossnay unit test run

Please refer to the installation manual of Lossnay unit for the test run.

### Step 3 Drain pump test run

Please refer to page 10.

### Step 4 Switch the remote controller (PZ-01RC) to "Test run".

- ① Select "Test run" from the Service menu, and press the [SELECT] button. (Fig. 1)
- ② Select "Test run" from the Test run menu, and press the [SELECT] button. (Fig. 2)
- ③ The test run operation starts, and the Test run operation screen is displayed.

#### Note;

- (1) When Lossnay unit fan speed is 1 or 2, Dx-coil unit will NOT be thermo-ON. Please select fan speed 3 or 4 from remote controller or other method.
- (2) When the OA temperature (Lossnay thermistor) is less than -10°C, Dx-coil unit may NOT be thermo-ON because of the intermittent operation.
- (3) When Dx-coil unit does not become thermo-ON, please wait for 10 minutes. Dx-coil unit keeps compressor OFF for at least 10 minutes for protection reason.

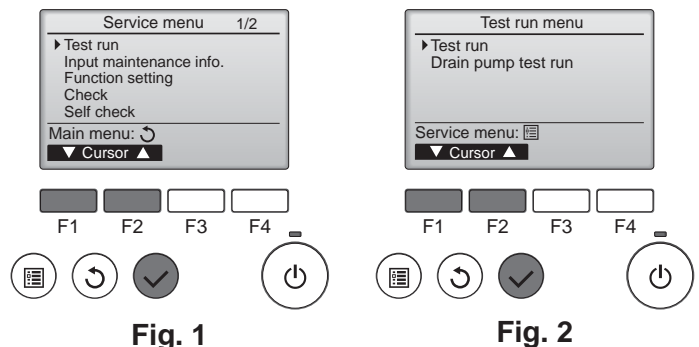



## Test run (continued)

### Step 5 Perform the test run and check the airflow temperature and auto vane.

Press the [F1] button to change the operation mode.

Cooling mode: Check that cool air blows from the unit.

Heating mode: Check that warm air blows from the unit.

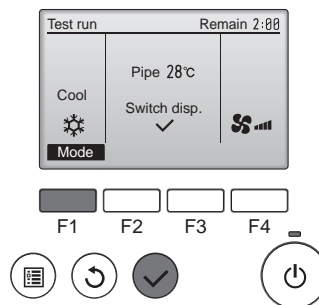

### Step 6 Confirm the operation of the outdoor unit fan.

The speed of the outdoor unit fan is controlled in order to control the performance of the unit. Depending on the ambient air, the fan will rotate at a slow speed and will keep rotating at that speed unless the performance is insufficient. Therefore, the outdoor wind may cause the fan to stop rotating or to rotate in the opposite direction, but this is not a problem.

### Step 7 Stop the test run.

Press the [ON/OFF] button to stop the test run. (The Test run menu will appear.)

## Trouble shooting

If an error code is displayed on the remote controller PZ-01RC, please follow the flow chart below.

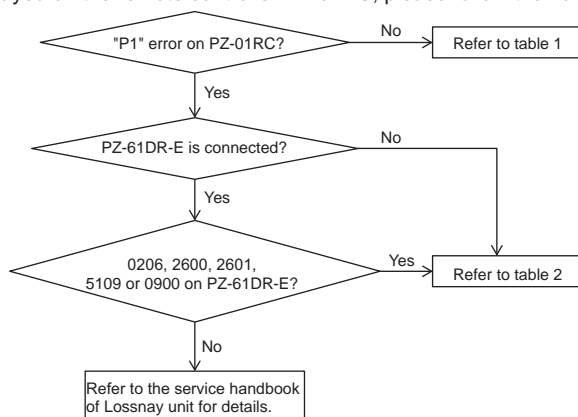

## Test run (continued)

<Table 1>

Code	Error	Action
P1	Lossnay unit failure or Dx-coil unit failure.	See table 2
P2	Liquid temperature thermistor (TH2) failure	<ul style="list-style-type: none"> <li>• Check connection of thermistor.</li> </ul>
		<ul style="list-style-type: none"> <li>• Check resistance value of thermistor. 0 °C; 15.0 kΩ 10 °C; 9.6 kΩ 20 °C; 6.3 kΩ 30 °C; 4.3 kΩ</li> </ul>
P6	Freezing/ overheating protection	<ul style="list-style-type: none"> <li>• Check local system if air flow is reduced.</li> </ul>
		<ul style="list-style-type: none"> <li>• Check outdoor fan motor.</li> </ul>
P9	Gas temperature thermistor (TH5) failure	<ul style="list-style-type: none"> <li>• Check connection of thermistor.</li> </ul>
		<ul style="list-style-type: none"> <li>• Check resistance value of thermistor. For characteristics, refer to (P2) above.</li> </ul>
E0 - E5	Communication failure between remote controller and PCB A	<ul style="list-style-type: none"> <li>• Check connection cable for damage or loose connections.</li> <li>• Check system configuration of remote controller.</li> </ul>
E6 - E7	Communication failure between PCB A and outdoor unit	<ul style="list-style-type: none"> <li>• Check that outdoor unit has not been turned off.</li> </ul>
		<ul style="list-style-type: none"> <li>• Check connection cable for damage or loose connections.</li> </ul>
		<ul style="list-style-type: none"> <li>• Refer to outdoor unit service manual.</li> </ul>
Fb	PCB A failure	<ul style="list-style-type: none"> <li>• Replace PCB A.</li> </ul>
PU	Inlet air temperature thermistor (TH11) failure	<ul style="list-style-type: none"> <li>• Check connection of thermistor.</li> </ul>
		<ul style="list-style-type: none"> <li>• Check resistance value of thermistor. For characteristics, refer to (P2) above.</li> </ul>
"6831" or "Please wait" remains displayed on the remote controller for more than 6 minutes.	Remote controller is incompatible with this model.	<ul style="list-style-type: none"> <li>• Use correct remote controller PZ-01RC (Number "BH00J360" is displayed on the bottom.)</li> </ul>

<Table 2>

Error code on PZ-61DR-E or M-NET system controller	No. of flashing of LED11 on PCB B	Error	Action
0206	1	Model selection failure	<ul style="list-style-type: none"> <li>• Check the model selection dip-switches (SW11-9 and 11-10 on PCB B), SW1-7 on PCB A and the actual model name.</li> </ul>
	5	PCB A failure	See table 1
	6	Communication failure between PCB A and PCB B	<ul style="list-style-type: none"> <li>• Check the lead wire cable is properly connected between CN105 on PCB A and CN5 on PCB B.</li> <li>• Check the PCB A is properly working.</li> </ul>
	7	Communication failure between Lossnay PCB and PCB B	<ul style="list-style-type: none"> <li>• Check the connection cable (accessory) is properly connected between CN20 on Lossnay PCB and CN120 on PCB B.</li> <li>• Check the power to Lossnay unit is properly supplied.</li> <li>• Check the SW7-1 of Lossnay unit PCB is ON.</li> </ul>
2600	2	Water level is too high in the unit	<ul style="list-style-type: none"> <li>• Check the water level in the unit. If the drain pump is broken the water level becomes high and then error code 2600 will be displayed.</li> </ul>
2601	3	Water sensor is not properly connected.	<ul style="list-style-type: none"> <li>• Check the lead wire cable of the water sensor is properly connected to CN10.</li> </ul>
5109	8	Supply air thermistor failure	<ul style="list-style-type: none"> <li>• Check the lead wire cable of the supply air thermistor is properly connected to CN9.</li> </ul>
0900	4	Drain pump test run	<ul style="list-style-type: none"> <li>• Check if SW11-1 on PCB B is OFF.</li> </ul>
Others	9	Lossnay failure	<ul style="list-style-type: none"> <li>• Check Lossnay PCB and the service handbook.</li> </ul>
-	10	Drain pump maintenance sign (2100 hours operation)	<ul style="list-style-type: none"> <li>• Check the drain pump if it works properly and replace when necessary.</li> </ul>
-	OFF	Normal operation	-

## Test run (continued)

- If the unit cannot be operated properly after the above test run has been performed, refer to the following table to remove the cause.

Symptom		LED 1, 2 (PCB in outdoor unit)	Cause
Remote controller PZ-01RC			
PLEASE WAIT	For about 2 minutes following power-on	After LED 1, 2 are lighted, LED 2 is turned off, then only LED 1 is lighted. (Correct operation)	<ul style="list-style-type: none"> <li>For about 2 minutes after power-on, operation of the remote controller is not possible due to system start-up. (Correct operation)</li> </ul>
PLEASE WAIT -> Error code	After about 2 minutes has expired following power-on	Only LED 1 is lighted. -> LED 1, 2 blink.	<ul style="list-style-type: none"> <li>Connector for the outdoor unit's protection device is not connected.</li> <li>Reverse or open phase wiring for the outdoor unit's power terminal block (L1, L2, L3)</li> </ul>
Display messages do not appear even when operation switch is turned ON (operation lamp does not light up).		Only LED 1 is lighted. -> LED 1, 2 blinks twice, LED 2 blinks once.	<ul style="list-style-type: none"> <li>Incorrect wiring between indoor and outdoor units (incorrect polarity of S1, S2, S3)</li> <li>Remote controller wire short</li> </ul>

### Note

**Operation is not possible for about 30 seconds after cancellation of function selection. (Correct operation)**

For description of each LED (LED1, 2, 3) provided on the PCB A, refer to the following table.

LED 1 (power for microcomputer)	Indicates whether control power is supplied to PCB A. Make sure that this LED is always lit.
LED 2 (power for remote controller PZ-01RC)	Indicates whether power is supplied to the remote controller.
LED 3 (communication between PCB A and outdoor units)	Indicates state of communication between PCB A and outdoor units. Make sure that this LED is always blinking.

# **mitsubishi electric corporation**

Manufactured by: MITSUBISHI ELECTRIC CORPORATION

TOKYO BLDG. 2-7-3, MARUNOUCHI, CHIYODA-KU, TOKYO, 100-8310 JAPAN

CITY MULTI Control System  
and Mitsubishi Mr. SLIM Air Conditioners

**MA Remote Controller PAR-31MAA**

**Installation Manual**



**For distribution to dealers and contractors**

This installation manual describes how to install the MA Remote Controller for use with Mitsubishi Building Air Conditioning System, direct expansion type CITY MULTI air conditioner indoor units ("A" type and later), and Mitsubishi Mr. SLIM packaged air conditioners. Please be sure to read this installation manual and the files on the CD-ROM that is supplied with the Remote Controller before proceeding with the installation. Failure to follow the instructions may result in equipment damage.



For information not contained in this booklet, please refer to the files on the CD-ROM that is supplied with the Remote Controller. If the files are not readable, please contact your dealer.

For information on how to wire and install the air conditioning units, refer to the installation manual.

After the installation, hand over this manual to users.

## 1. Safety Precautions

- Thoroughly read the following safety precautions prior to installation.
- Observe these precautions carefully to ensure safety.

 <b>WARNING</b>	Indicates a risk of death or serious injury.
 <b>CAUTION</b>	Indicates a risk of serious injury or structural damage.

- After reading this manual, pass it on to the end user to retain for future reference.
- Keep this manual for future reference and refer to it as necessary. This manual should be made available to those who repair or relocate the controller. Make sure that the manual is passed on to any future users.

**All electric work must be performed by qualified personnel.**

### General precautions

#### **WARNING**

Do not install the unit in a place where large amounts of oil, steam, organic solvents, or corrosive gases, such as sulfuric gas, are present or where acidic/alkaline solutions or sprays are used frequently. These substances can compromise the performance of the unit or cause certain components of the unit to corrode, which can result in electric shock, malfunctions, smoke, or fire.

To reduce the risk of shorting, current leakage, electric shock, malfunctions, smoke, or fire, do not wash the controller with water or any other liquid.

To reduce the risk of electric shock, malfunctions, smoke or fire, do not operate the switches/buttons or touch other electrical parts with wet hands.

To reduce the risk of injury or electric shock, before spraying a chemical around the controller, stop the operation and cover the controller.

To reduce the risk of injury or electric shock, stop the operation and switch off the power supply before cleaning, maintaining, or inspecting the controller.

Properly install all required covers to keep moisture and dust out of the controller. Dust accumulation and water can cause electric shock, smoke, or fire.

To reduce the risk of injury, keep children away while installing, inspecting, or repairing the controller.

#### **CAUTION**

To reduce the risk of fire or explosion, do not place flammable materials or use flammable sprays around the controller.

To reduce the risk of damage to the controller, do not directly spray insecticide or other flammable sprays on the controller.

To reduce the risk of electric shock or malfunctions, do not touch the touch panel, switches, or buttons with a pointy or sharp object.

To reduce the risk of injury and electric shock, avoid contact with sharp edges of certain parts.

To avoid injury from broken glass, do not apply excessive force on the glass parts.

To reduce the risk of injury, wear protective gear when working on the controller.

## Precautions during installation

### ⚠ WARNING

Do not install the controller where there is a risk of leaking flammable gas. If flammable gas accumulates around the controller, it may ignite and cause a fire or explosion.

Properly dispose of the packing materials. Plastic bags pose suffocation hazard to children.

Take appropriate safety measures against earthquakes to prevent the controller from causing injury.

To prevent injury, install the controller on a flat surface strong enough to support its weight.

### ⚠ CAUTION

To reduce the risk of shorting, current leakage, electric shock, malfunctions, smoke, or fire, do not install the controller in a place exposed to water or in a condensing environment.

Controller must be installed by qualified personnel according to the instructions detailed in the Installation Manual. Improper installation may result in electric shock or fire.

When attaching the cover and the top casing to the bottom casing, push it until it they click into place. If they are not properly locked into place, they may fall, causing personal injury, controller damage, or malfunctions.

## Precautions during wiring

### ⚠ WARNING

To reduce the risk of damage to the controller, malfunctions, smoke, or fire, do not connect the power cable to the signal terminal block.

Properly secure the cables in place and provide adequate slack in the cables so as not to stress the terminals. Improperly connected cables may break, overheat, and cause smoke or fire.

To reduce the risk of injury or electric shock, switch off the main power before performing electrical work.

All electric work must be performed by a qualified electrician according to the local regulations, standards, and the instructions detailed in the Installation Manual. Capacity shortage to the power supply circuit or improper installation may result in malfunction, electric shock, smoke, or fire.

To reduce the risk of current leakage, overheating, smoke, or fire, use properly rated cables with adequate current carrying capacity.

### ⚠ CAUTION

To reduce the risk of electric shock, shorting, or malfunctions, keep wire pieces and sheath shavings out of the terminal block.

To reduce the risk of shorting, current leakage, electric shock, or malfunctions, keep the cables out of contact with controller edges.

To reduce the risk of electric shock, malfunctions, or fire, seal the gap between the cables and cable access holes with putty.

## Precautions for moving or repairing the controller

### ⚠ WARNING

The controller should be repaired or moved only by qualified personnel. Do not disassemble or modify the controller. Improper installation or repair may cause injury, electric shock, or fire.

### ⚠ CAUTION

To reduce the risk of shorting, electric shock, fire, or malfunction, do not touch the circuit board with tools or with your hands, and do not allow dust to accumulate on the circuit board.

## Additional precautions

To avoid damage to the controller, use appropriate tools to install, inspect, or repair the controller.

This controller is designed for exclusive use with the Building Management System by Mitsubishi Electric. The use of this controller for with other systems or for other purposes may cause malfunctions.

Take appropriate measures against electrical noise interference when installing the air conditioners in hospitals or facilities with radio communication capabilities. Inverter, high-frequency medical, or wireless communication equipment as well as power generators may cause the air conditioning system to malfunction. Air conditioning system may also adversely affect the operation of these types of equipment by creating electrical noise.

To avoid malfunctions, do not bundle power cables and signal cables together, or place them in the same metallic conduit.

To prevent malfunctions, do not remove the protective film or the circuit board from the casing.

To avoid damage to the controller, do not overtighten the screws.

Use a flat-head screwdriver with a blade width of 4-7 mm (5/32-9/32 inch). The use of a screwdriver with a narrower or wider blade tip may damage the controller casing.

To prevent damage to the controller casing, do not force the driver to turn with its tip inserted in the slot.

To avoid discoloration, do not use benzene, thinner, or chemical rag to clean the controller. To clean the controller, wipe with a soft cloth soaked in water with mild detergent, wipe off the detergent with a wet cloth, and wipe off water with a dry cloth.

To avoid damage to the controller, provide protection against static electricity.

Do not use solderless terminals to connect cables to the terminal block. Solderless terminals may come in contact with the circuit board and cause malfunctions or damage the controller cover.

To avoid damage to the controller, do not make holes on the controller cover.

To avoid deformation and malfunction, do not install the remote controller in direct sunlight or where the ambient temperature may exceed 40°C (104°F) or drop below 0°C (32°F).

Do not install the controller on the control panel door. Vibrations or shocks to the controller may damage the controller or cause the controller to fall.

Hold the cables in place with clamps to prevent undue force from being applied to the terminal block and causing cable breakage.

To prevent cable breakage and malfunctions, do not hang the top controller casing hang by the cable.

## 2. System Requirements

**WARNING** The CD-ROM that is supplied with the Remote Controller can only be played on a CD-drive or a DVD-drive. Do not attempt to play this CD-ROM on an audio CD player as this may damage your ears and/or speakers.

Your computer must meet the following requirements to run Manual Navigation Software.

[PC] PC/AT compatible

[CPU] Core2 Duo 1.66 GHz or faster (Core2 Duo 1.86 GHz or faster recommended)  
 Pentium D 1.7 GHz or faster (Pentium D 3.0 GHz or faster recommended)  
 Pentium M 1.7 GHz or faster (Pentium M 2.0 GHz or faster recommended)  
 Pentium 4 2.4 GHz or faster (Pentium 4 2.8 GHz or faster recommended)  
 \* Core2 Duo or faster processor is required to run Manual Navigation Software on Windows Vista.

[RAM] Windows Vista: 1 GB minimum (2 GB or more recommended)  
 Windows XP: 512 MB minimum (1 GB or more recommended)

[HDD space] 1GB minimum (available space)  
 \* Windows Vista: Available space in the drive that has the Document folder  
 \* Windows XP: Available space in the drive that has the My Document folder

[Resolution] SVGA 800 × 600 or greater

[OS] Windows Vista Ultimate/Business/Home Basic Service Pack1 (Business version recommended)  
 Windows XP Professional/Home Edition Service Pack2 or Service Pack3 (Professional version recommended)

[Required software] Adobe Reader 8.1.3 or later  
 Adobe Acrobat 8.1.3 or later  
 \* Software to view PDF files

"Windows," "Windows XP," and "Windows Vista" are registered trademarks of Microsoft Corporation.  
 "Adobe Reader" and "Adobe Acrobat" are registered trademarks of Adobe Systems Incorporated.  
 "Core2 Duo" and "Pentium" are registered trademarks of Intel Corporation.

## 3. Component names and supplied parts

The following parts are included in the box.

Parts name	Qty.	Appearance
Remote controller (front cover)	1	Right figure *1
Remote controller (top case)	1	Right figure *2
Remote controller (bottom case)	1	Right figure *3
Roundhead cross slot screws M4×30	2	
Wood screw 4.1×16 (for direct wall installation)	2	
Installation Manual (this manual)	1	
Simple Operation Manual	1	
CD-ROM (Instruction Book and Installation Manual)	1	

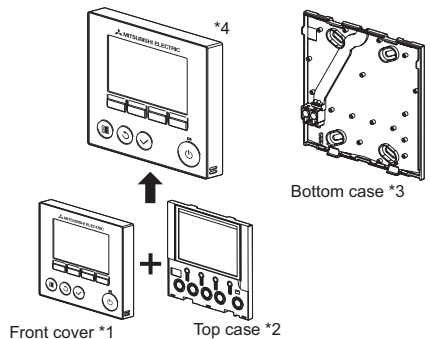

\*4 The front cover (\*1) is already installed on the top case (\*2) at factory shipment.

\*5 Remote controller cable is not included.

## 4. Field-supplied parts/Required tools

### (1) Field-supplied parts

The following parts are field-supplied parts.

Parts name	Qty.	Notes
Double switch box	1	Not required for direct wall installation
Thin metal conduit	Necessary	
Lock nut and bushing	Necessary	
Cable cover	Necessary	Required for routing remote controller cable along a wall
Putty	Reasonable	
Molly anchor	Necessary	
Remote controller cable (Use a 0.3 mm <sup>2</sup> (AWG22) 2-core sheathed cable.)	Necessary	

### (2) Field-supplied tools

- Flat-tip screwdriver (Width: 4-7 mm (5/32-9/32 inch))
- Knife or Nipper
- Miscellaneous tools

## 5. Selecting an installation site

This remote controller is for the wall installation. It can be installed either in the switch box or directly on the wall. When performing direct wall installation, wires can be thread through either back or top of the remote controller.

### (1) Selecting an installation site

Install the remote controller (switch box) on the site where the following conditions are met.

- (a) For connection to the indoor unit with an Auto descending panel, a place where people can check the Auto descending panel operation of the indoor unit while they are operating the remote controller (Refer to the indoor unit Instructions Book for how to operate Auto descending panel.)

- (b) A flat surface

- (c) A place where the remote controller can measure the accurate indoor temperature

Sensors to monitor indoor temperature are on the indoor unit and on the remote controller. When the room temperature is monitored with the sensor on the remote controller, the main remote controller monitors the room temperature. When using the sensor on the remote controller, follow the instructions below.

- To monitor the accurate indoor temperature, install the remote controller away from direct sunlight, heat sources, and the supply air outlet of the air conditioner.
- Install the remote controller in a location that allows the sensor to measure the representative room temperature.
- Install the remote controller where no wires are routed around the temperature sensor on the controller.  
(If wires are routed, the sensor cannot measure accurate indoor temperature.)

### Important

Do not install the controller in a place where the difference between the remote controller surface temperature and the actual room temperature will be great.  
If the temperature difference is too high, room temperature may not be adequately controlled.

To reduce the risk of shorting, current leakage, electric shock, malfunctions, smoke, or fire, do not install the controller in a place exposed to water or in a condensing environment.

To avoid deformation and malfunction, do not install the remote controller in direct sunlight or where the ambient temperature may exceed 40°C (104°F) or drop below 0°C (32°F).

To reduce the risk of malfunctions and damage to the controller, avoid installing the remote controller on an electrically conductive surface, such as an unpainted metal sheet.

### (2) Installation space

Leave a space around the remote controller as shown in the figure at right, regardless of whether the controller is installed in the switch box or directly on the wall. Removing the remote controller will not be easy with insufficient space.

Also, leave an operating space in front of the remote controller.

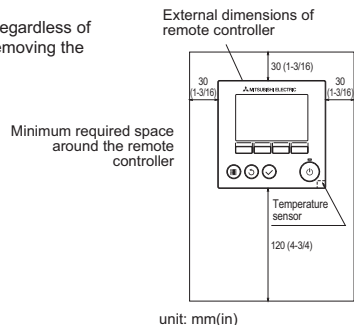



# 6. Installation/Wiring work

## (1) Installation work

Controller can be installed either in the switch box or directly on the wall. Perform the installation properly according to the method.

### ① Drill a hole in the wall.

- Installation using a switch box
  - Drill a hole in the wall, and install the switch box on the wall.
  - Connect the switch box to the conduit tube.
- Direct wall installation
  - Drill a hole in the wall, and thread the cable through it.

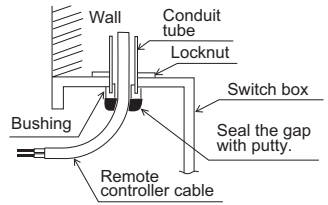

### ② Seal the cable access hole with putty.

- Installation using a switch box
  - Seal the remote controller cable access hole at the connection of switch box and conduit tube with putty.

To reduce the risk of electric shock, malfunctions, or fire, seal the gap between the cables and cable access holes with putty.

### ③ Prepare the bottom case of the remote controller.

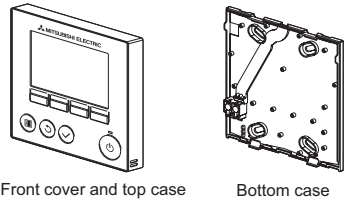

Front cover and top case

Bottom case

### ④ Connect the remote controller cable to the terminal block on the bottom case.

Peel off 6 mm of the remote controller cable sheath as shown in the figure below, and thread the cable from behind the bottom case. Thread the cable to the front of the bottom case so that the peeled part of the cable cannot be seen behind the bottom case. Connect the remote controller cable to the terminal block on the bottom case.

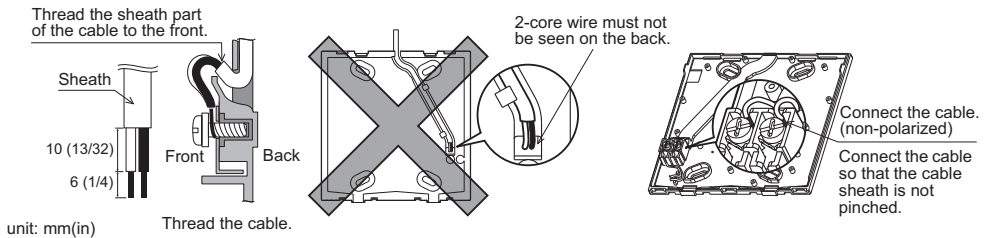

- Direct wall installation
  - Seal the hole through which the cable is threaded with putty.

To reduce the risk of electric shock, shorting, or malfunctions, keep wire pieces and sheath shavings out of the terminal block.

### Important

Do not use solderless terminals to connect cables to the terminal block. Solderless terminals may come in contact with the circuit board and cause malfunctions or damage the controller cover.

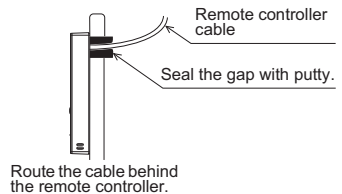

Route the cable behind the remote controller.

### ⑤ Install the bottom case.

#### ■ Installation using a switch box

- Secure at least two corners of the switch box with screws.

#### ■ Direct wall installation

- Thread the cable through the groove.
- Secure at least two corners of the remote controller with screws.
- Be sure to secure top-left and bottom-right corners of the remote controller (viewed from the front) to prevent it from lifting. (Use molly anchor etc.)

#### ■ Installation using a switch box

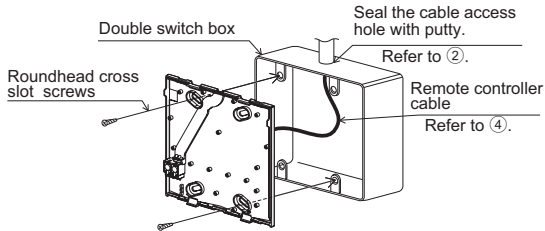

#### ■ Direct wall installation

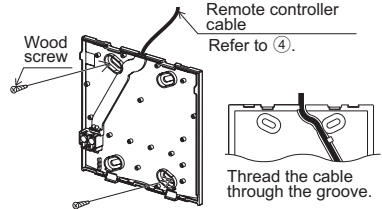

### Important

To avoid damage to the controller, do not overtighten the screws.

To avoid damage to the controller, do not make holes on the controller cover.

### ⑥ Cut out the cable access hole.

#### ■ Direct wall installation (when running the cable along the wall)

- Cut out the thin-wall part on the cover (indicated with the shaded area in the right figure) with a knife or a nipper.
- Thread the cable from the groove behind the bottom case through this access hole.

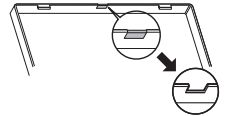

### ⑦ Route the wire to the top case.

Connect the connector on the bottom case to the connector on the top case.

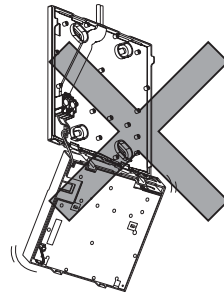
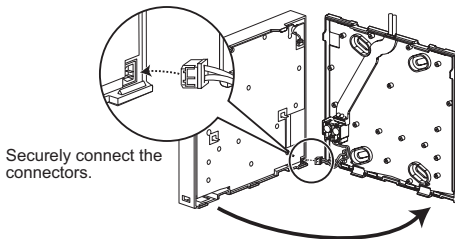

### Important

To prevent malfunctions, do not remove the protective film or the circuit board from the casing.

To prevent cable breakage and malfunctions, do not hang the top controller casing hang by the cable.

⑧ Route the wire to the top case.

**Important**

Hold the cables in place with clamps to prevent undue force from being applied to the terminal block and causing cable breakage.

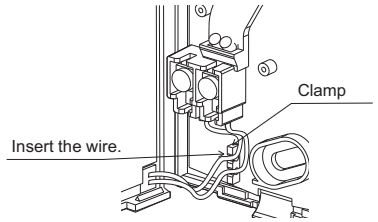

⑨ Install the front cover and top case on the bottom case.

Two mounting tabs are at the top of the top case. (A cover is already installed on the case at the time of factory shipment.) Hook those two tabs onto the bottom case, and click the top case into place. Check that the case is securely installed and not lifted.

**Important**

When attaching the cover and the top casing to the bottom casing, push it until it click into place. If they are not properly locked into place, they may fall, causing personal injury, controller damage, or malfunctions.

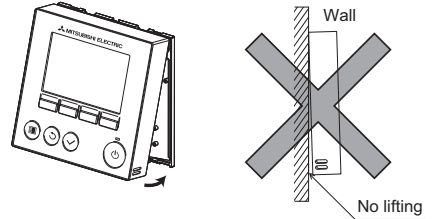

- Direct wall installation (when running the cable along the wall)
  - Thread the cable through the access hole at the top of the remote controller.
  - Seal the cut-out part of the cover with putty.
  - Use a cable cover.

Seal the gap with putty.

Use a cable cover.

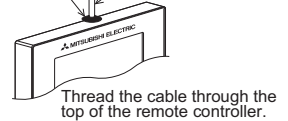

Installation is complete.  
Follow the instructions below when uninstalling them.

• **Uninstalling the front cover and top case**

① Uninstalling the front cover

Insert a flat-tip screwdriver into either of the two latches at the bottom of the remote controller, and move it in the direction of the arrow as shown in the figure at right.

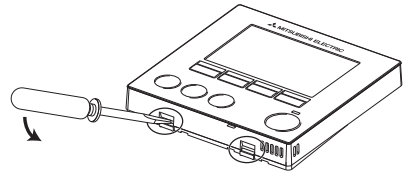

② Uninstalling the top case

Insert a flat-tip screwdriver into either of the two latches at the bottom of the remote controller, and move it in the direction of the arrow as shown in the figure at right.

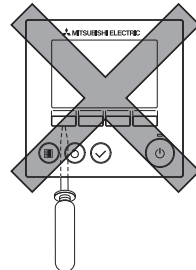
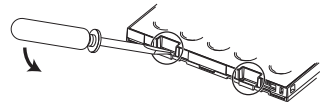

## Important

Use a flat-head screwdriver with a blade width of 4-7 mm (5/32-9/32 inch). The use of a screwdriver with a narrower or wider blade tip may damage the controller casing.

To prevent damage to the controller casing, do not force the driver to turn with its tip inserted in the slot.

To prevent damage to the control board, do not insert the driver into the slot strongly.

- ③ Installing the cover and top case  
Two mounting tabs are at the top of the top case. Hook those two tabs onto the bottom case, and click the top case into place. Install the cover on the top case in the same way as with the top case. Check that the top case is securely installed and not lifted.

## Important

When attaching the cover and the top casing to the bottom casing, push it until it they click into place. If they are not properly locked into place, they may fall, causing personal injury, controller damage, or malfunctions.

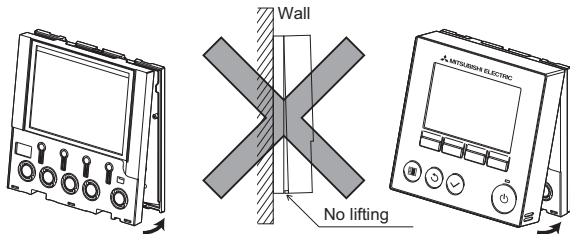

## 7. Important

### ■ Discrepancy between the indoor temperature measured at the wall and the actual indoor temperature may occur.

If the following conditions are met, the use of the temperature sensor on the indoor unit is recommended.

- Supply air does not reach to the wall easily where the remote controller is installed due to improper airflow distribution.
- There is a great discrepancy between the wall temperature and the actual indoor temperature.
- The back side of the wall is directly exposed to the outside air.

**Note:** When temperature changes rapidly, the temperature may not be detected accurately.

■ Refer to the section on initial setting in this Manual for remote controller main/sub setting.

■ Refer to either of the following manuals for temperature sensor setting: indoor unit Installation Manual for City Multi; this manual for Mr. Slim.

■ At the time of factory shipment, protective sheet is on the operation interface of the front cover. Peel off the protective sheet on the operation interface prior to use.

## 8. Remote controller button functions

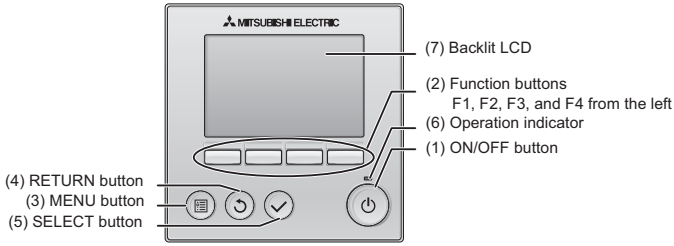

### (1) ON/OFF button

Use to turn ON/OFF the indoor unit.

### (2) Function buttons

Use to select the operation mode or to set the temperature and fan speed on the Main display.

Use to select items on other screens.

### (3) MENU button

Use to bring up the Main menu.

### (4) RETURN button

Use to return to the previous screen.

### (5) SELECT button

Use to jump to the setting screen or to save the settings.

### (6) Operation indicator

Stays lit during normal operation. Blinks during startup and when an error occurs.

### (7) Backlit LCD

Dot display. When the backlight is off, pressing any button turns the backlight on and it will stay lit for a certain period of time depending on the screen. Performing any button operation keeps the backlight on.

Pressing the MENU button will bring up the Main menu as shown below.  
(Refer to section 9.(2) "Main display" for details.)

1/3 Vane·Louver·Vent. (Lossnay)	*1
High power	*1
Timer	*1
Weekly timer	*1
OU silent mode	*1
2/3 Restriction	*1
Energy saving	*1
Night setback	*1
Filter information	*1
Error information	*1
3/3 Maintenance	*1
Initial setting	*2 *3
Service	*2 *3

\*1 Refer to the Instructions Book in the CD-ROM for details.

\*2 Explained in this manual.

\*3 If no buttons are pressed for 10 minutes on the initial setting screens, or 2 hours on the service screens (10 minutes on some screens), the screen will automatically return to the Main display. Any settings that have not been saved will be lost.

The available items on the menu depend on the connected indoor unit model. For items not described in the manuals that are enclosed with the MA remote controller, refer to the manuals that came with the air conditioning units.

Note: When the backlight is off, pressing any button turns the backlight on and does not perform its function. (except for the ON/OFF button)

### Button operations on the Main menu

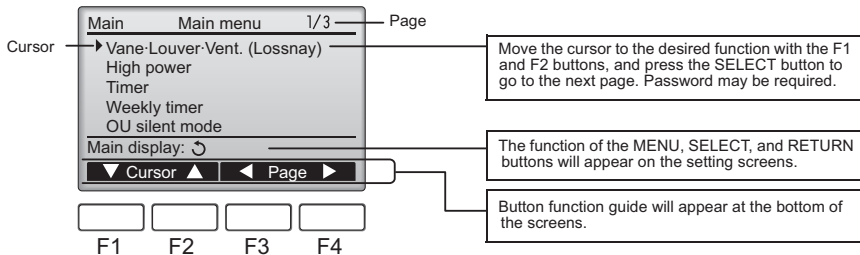

## 9. Turning on the power

Make sure that the MA remote controller is properly installed according to the instructions in the Installation Manual and that the indoor and outdoor unit installation has been completed before turning on the power.

- (1) When the power is turned on, the following screen will appear.

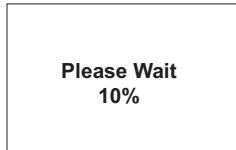

Normal start up (indicating the percentage of process completion)

### Notes

- When the power is on for the first time, the Language selection screen will be displayed. Refer to section 11 (8). Select a desired language. The system will not start-up without language selection.
- Some models of City Multi cannot have more than one remote controller connected. Refer to relevant documents (e.g., catalogs) for usage compatibility.

- (2) Main display

After the successful startup, the Main display will appear. The Main display can be displayed in two different modes: "Full" and "Basic." Refer to section 11 "Initial settings" for how to select the display mode. (The factory setting is "Full.")

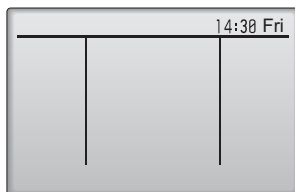

Main display in the Full mode (while the unit is not in operation)

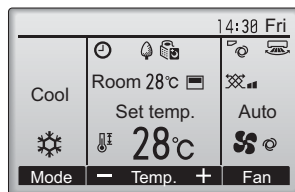

Main display in the Full mode (while the unit is in operation)

### Notes

- When connecting two remote controllers, be sure to designate one as a main and the other as a sub controller. Refer to section 11 "Initial settings" for how to make the Main/Sub setting.
- Refer to the Instructions Book for the icons on the display.

## 10. Test run <Maintenance password is required.>

- (1) Read the section about Test run in the indoor unit Installation Manual before performing a test run.
- (2) At the Main display, press the MENU button and select Service>Test run>Test run.
- (3) Press the ON/OFF button to cancel the test run if necessary.
- (4) Refer to the indoor unit Installation Manual for the detailed information about test run and for how to handle the errors that occur during a test run.

Note: Refer to section 12 "Service menu" for information about the maintenance password.

## 11. Initial settings (Remote controller settings) <Administrator password is required.>

From the Main display, select Main menu>Initial setting, and make the remote controller settings on the screen that appears.

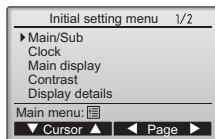

### Initial setting menu (1/2)

- Main/Sub
- Clock
- Main display
- Contrast
- Display details
- Clock
- Temperature
- Room temp.
- Auto mode

### Initial setting menu (2/2)

- Auto mode
- Administrator password
- Language selection

Note: The initial administrator password is "0000." Refer to section (7) "Administrator password setting" for how to change the password.

- (1) Main/Sub setting

When connecting two remote controllers, one of them needs to be designated as a sub controller.

[Button operation]

- [1] When the F3 or F4 button is pressed, the currently selected setting will appear highlighted. Select "Sub", and press the SELECT button to save the change.

- [2] Press the MENU button to return to the Main menu screen. (This button always brings up the Main menu screen.)

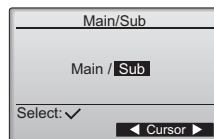

## (2) Clock setting

[Button operation]

- [1] Move the cursor with the F1 or F2 button to the desired item.
- [2] Change the date and time with the F3 or F4 button, and press the SELECT button to save the change. The change will be reflected on the clock display on the Main display.

Note: Clock setting is necessary for time display, weekly timer, timer setting and error history. Make sure to perform clock setting when the unit is used for the first time or has not used for a long time.

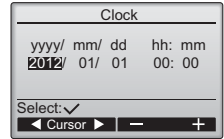

## (3) Main display setting

Use the F3 or F4 button to select the display mode "Full" or "Basic." (The factory setting is "Full.")

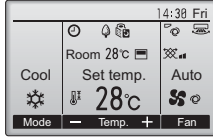

Full mode (Example)

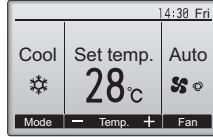

Basic mode (Example)

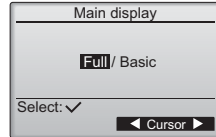

Note: This setting is only for the Main display. In the Basic mode, icons that indicate control status on timer and schedule settings will not appear on the display. Vane, louver, and ventilation settings or room temperature will not appear, either.

## (4) Display contrast

[Button operation]

Adjust LCD contrast with the F3 or F4 button.  
The current level is indicated with a triangle.

Note: Adjust the contrast to improve viewing in different lighting conditions or installation locations. This setting can not improve viewing from all directions.

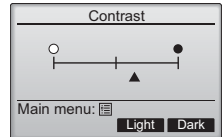

## (5) Remote controller display details setting

Make the settings for the remote-controller-related items as necessary.  
Press the SELECT button to save the changes.

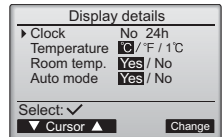

### [1] Clock display

[Button operation]

- Select "Clock" from the remote controller display details setting screen, and press the F4 button (Change) to bring up the clock display setting screen.
- Use the F1 through F4 buttons to select "Yes" (display) or "No" (non-display) and its format for the Main display.
- Save the settings with the SELECT button.  
(The factory settings are "Yes" (display) and "24 h" format.)

Clock display: Yes (Time is displayed on the Main display.)  
No (Time is not displayed on the Main display.)

Display format: 24-hour format  
12-hour format

AM/PM display (Effective when the display format is 12-hour): AM/PM before the time  
AM/PM after the time

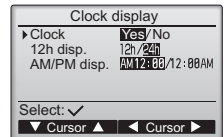

Note: Time display format will also be reflected on the timer and schedule setting display. The time is displayed as shown below.  
12-hour format: AM12:00 ~ AM1:00 ~ PM12:00 ~ PM1:00 ~ PM11:59  
24-hour format: 0:00 ~ 1:00 ~ 12:00 ~ 13:00 ~ 23:59

### [2] Temperature unit setting

[Button operation]

Move the cursor to the "Temperature" on the display details setting screen, and select the desired temperature unit with the F3 or F4 button. (The factory setting is Centigrade (°C).)

- °C: Temperature is displayed in Centigrade. Temperature is displayed in 0.5- or 1-degree increments, depending on the model of indoor units.
- °F: Temperature is displayed in Fahrenheit.
- 1 °C: Temperature is displayed in Centigrade in 1-degree increments. This item will not appear on a sub remote controller.

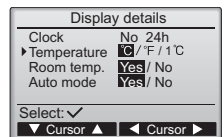

[3]Room temperature display

[Button operation]

Move the cursor to the "Room temp." on the display details setting screen, and select the desired setting with the F3 or F4 button.

(The factory setting is "Yes".)

- Yes: Room temperature appears on the Main display.
- No: Room temperature does not appear on the Main display.

Note: Even when "Yes" is set, the room temperature is not displayed on the Main display in the "Basic" mode.

[4]Auto (single set point) mode display setting

[Button operation]

Move the cursor to the "Auto mode" on the display details setting screen, and select the desired mode with the F3 or F4 button.

(The factory setting is "Yes".)

- Yes: "AUTO COOL" or "AUTO HEAT" is displayed during operation in the AUTO (single set point) mode.
- No: Only "AUTO" is displayed during operation in the AUTO (single set point) mode.

(6) Auto mode setting

[Button operation]

Whether or not to use the Auto (single set point) or Auto (dual set points) mode can be selected by using the F3 or F4 button. This setting is valid only when indoor units with the AUTO mode function are connected.

(The factory setting is "Yes".)

Press the SELECT button to save the changes made.

- Yes: The AUTO mode can be selected in the operation mode setting.
- No: The AUTO mode cannot be selected in the operation mode setting.

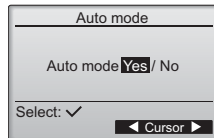

(7) Administrator password setting

[Button operation]

[1] To enter the current Administrator password (4 numerical digits), move the cursor to the digit you want to change with the F1 or F2 button, and set each number (0 through 9) with the F3 or F4 button.

[2] Press the SELECT button.

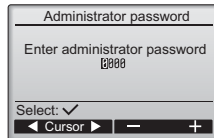

Note: The initial administrator password is "0000." Change the default password as necessary to prevent unauthorized access. Have the password available for those who need it.

Note: If you forget your administrator password, you can initialize the password to the default password "0000" by pressing and holding the F1 and F2 buttons simultaneously for three seconds on the administrator password setting screen.

[3] If the password matches, a window to enter a new password will appear. Enter a new password in the same way as explained above, and press the SELECT button.

[4] Press the F4 button (OK) on the password change confirmation screen to save the change. Press the F3 button (Cancel) to cancel the change.

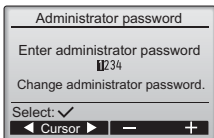

Note: The administrator password is required to make the settings for the following items.

- Timer setting · Weekly timer setting · Energy-save setting
- Outdoor unit silent mode setting · Restriction setting

Refer to the Instruction Book that came with the remote controller for the detailed information about how to make the settings for these items.

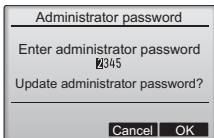

(8) Language selection

[Button operation]

Move the cursor to the language you desire with the F1 through F4 buttons.

Press the SELECT button to save the setting.

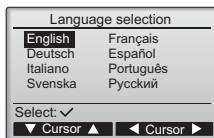



## 12. Service menu (Maintenance password is required.)

At the Main display, press the MENU button and select "Service" to make the maintenance settings.

When the Service menu is selected, a window will appear asking for the password.

To enter the current maintenance password (4 numerical digits), move the cursor to the digit you want to change with the F1 or F2 button, and set each number (0 through 9) with the F3 or F4 button. Then, press the SELECT button.

Note: The initial maintenance password is "9999." Change the default password as necessary to prevent unauthorized access. Have the password available for those who need it.

Note: If you forget your maintenance password, you can initialize the password to the default password "9999" by pressing and holding the F1 and F2 buttons simultaneously for three seconds on the maintenance password setting screen.

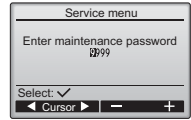

If the password matches, the Service menu will appear.

The type of menu that appears depends on the connected indoor units' type (City Multi or Mr. Slim).

<Mr. Slim>

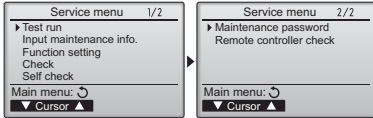

Note: Air conditioning units may need to be stopped to make certain settings. There may be some settings that cannot be made when the system is centrally controlled.

<City Multi>

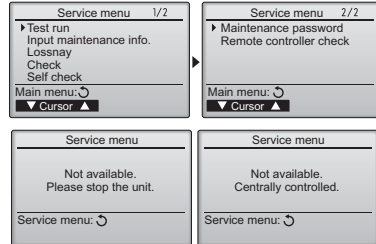

### (1) Test run (City Multi and Mr. Slim)

Select "Test run" from the Service menu to bring up the Test run menu.

- Test run: Select this option to perform a test run.
  - Drain pump test run: Select this option to perform a test run on the drain pump on the indoor unit.
- Applicable only to the type of indoor units that support the test run function.

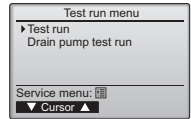

Note: Refer to the indoor unit Installation Manual for the detailed information about test run.

### (2) Input maintenance Info. (City Multi and Mr. Slim)

Select "Input maintenance Info." from the Service menu to bring up the Maintenance information screen. Refer to the indoor unit Installation Manual for how to make the settings.

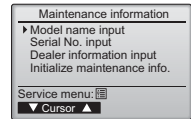

Note: The following settings can be made from the Maintenance Information screen.

- Registering model names and serial numbers  
Enter the model names and serial numbers of outdoor and indoor units. The information entered will appear on the Error information screen. Model names can have up to 18 characters, and the serial numbers can have up to 8 characters.
- Registering dealer information  
Enter phone number of a dealer. The entered information will appear on the Error information screen. Phone number can have up to 13 characters.
- Initializing maintenance information  
Select the desired item to initialize the above settings.

### (3) Function setting (Mr. Slim)

Make the settings for the indoor unit functions via the remote controller as necessary.

Select "Function setting" from the Service menu to bring up the Function setting screen.

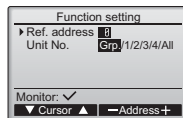

[Button operation]

[1] Set the indoor unit refrigerant addresses and unit numbers with the F1 through F4 buttons, and then press the SELECT button to confirm the current setting.

[2] When data collection from the indoor units is completed, the current settings appears highlighted. Non-highlighted items indicate that no function settings are made. Screen appearance varies depending on the "Unit No." setting.

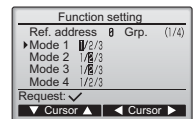

Common items

[3] Use the F1 or F2 button to move the cursor to select the mode number, and change the setting number with the F3 or F4 button.

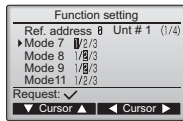

Individual items  
(Unit No. 1 through 4)

[4] When the settings are completed, press the SELECT button to send the setting data from the remote controller to the indoor units.

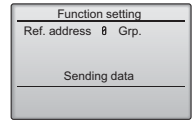

[5] When the transmission is successfully completed, the screen will return to the Function setting screen.

Note:

- Make the above settings on Mr. Slim units as necessary.
- Refer to the Instructions Book when it is necessary to set the settings for City Multi units.
- **Table 1 summarizes the setting options for each mode number. Refer to the indoor unit Installation Manual for the detailed information about initial settings, mode numbers, and setting numbers for the indoor units.**
- Be sure to write down the settings for all functions if any of the initial settings has been changed after the completion of installation work.

Table1. Function setting options

Mode No.	Mode	Settings	Setting No.	Unit numbers
01	Automatic recovery after power failure	Disable	1	Set "Grp." for the Unit number. These settings apply to all the connected indoor units.  Set "1, 2, 3, 4, or All" for the Unit number. These settings apply to each indoor unit. • If "1, 2, 3, or 4" is set for the Unit number, the settings apply only to the specified indoor unit regardless of the number of connected indoor units (one through four units). • If "ALL" is set for the Unit number, the settings apply to all the connected indoor units regardless of the number of connected indoor units (one through four units).
		Enable (Four minutes of standby time is required after the restoration of power.)	2	
02	Thermistor selection (indoor temperature detection)	Average temperature reading of the indoor units in operation	1	
		Thermistor on the indoor unit to which the remote controller is connected (fixed)	2	
		Built-in sensor on the remote controller	3	
03	LOSSNAY connection	Not connected	1	
		Connected (without outdoor air intake by the indoor units )	2	
		Connected (with outdoor air intake by the indoor units )	3	
04	Power voltage	240 V	1	
		220 V, 230 V	2	
05	AUTO mode	Enable (Automatically the unit achieves effective energy saving operation.)	1	
		Disable	2	
07	Filter sign	100 hours	1	
		2500 hours	2	
		Not displayed	3	
08	Fan speed	Silent mode (or standard)	1	
		Standard (or High ceiling 1)	2	
		High ceiling (or High ceiling 2)	3	
09	Outlet	4 directional	1	
		3 directional	2	
		2 directional	3	
10	Optional parts (High-efficiency filter)	No	1	
		Yes	2	
11	Vane	No vanes (or the vane setting No.3 is effective.)	1	
		Equipped with vanes (The vane setting No.1 is effective.)	2	
		Equipped with vanes (The vane setting No.2 is effective.)	3	

(4) LOSSNAY setting (City Multi only)

This setting is required only when the operation of City Multi units is interlocked with LOSSNAY units. This setting is not available for the Mr. Slim units. Interlock settings can be made for the indoor unit to which the remote controller is connected. (They can also be confirmed or deleted.)

Note:

- Use the centralized controller to make the settings if it is connected.
- To interlock the operation of the indoor units with the LOSSNAY units, be sure to interlock the addresses of ALL indoor units in the group and that of the LOSSNAY unit.

[Button operation]

[1] When "Lossnay" on the Service menu is selected, the remote controller will automatically begin searching for the registered LOSSNAY addresses of the currently connected indoor unit.

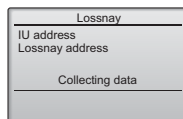

[2] When the search is completed, the smallest address of the indoor units that are connected to the remote controller and the address of the interlocked LOSSNAY unit will appear. "--" will appear if no LOSSNAY unit is interlocked with the indoor units.

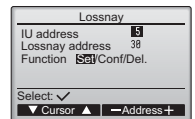

If no settings need to be made, press the RETURN button to go back to the Service menu.

To make LOSSNAY interlock setting

[3] Enter the addresses of the indoor unit and the LOSSNAY unit to be interlocked, with the F1 through F4 buttons, select "Set" in the "Function", and press the SELECT button to save the settings. "Sending data" will appear on the screen. If the setting is successfully completed, "Setting completed" will appear.

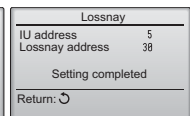
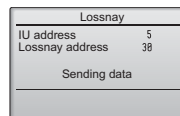

To search for the LOSSNAY address

[4] Enter the address of the indoor unit to which the remote controller is connected, select "ConF" in the "Function", and press the SELECT button. "Collecting data" will appear on the screen. If the signal is received correctly, the indoor unit address and LOSSNAY address will appear. "--" will appear when no LOSSNAY unit is found. "Unit not exist" will appear if no indoor units that are correspond to the entered address are found.

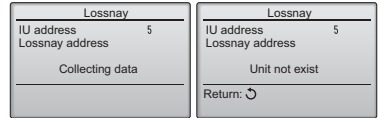

To delete the interlock setting

[5] To delete the interlocked setting between LOSSNAY unit and the indoor units to which the remote controller is connected, enter the indoor unit address and LOSSNAY address with the F1 through F4 buttons, select "Del." in the "Function", and press the SELECT button. "Deleting" will appear. The screen will return to the search result screen if the deletion is successfully completed. "Unit not exist" will appear if no indoor units that are correspond to the entered address are found. If deletion fails, "Request rejected" will appear on the screen.

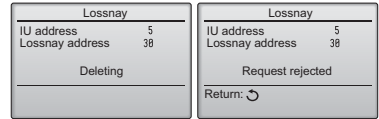

(5) Check

Select "Check" on the Service menu to bring up the Check menu screen. The type of menu that appears depends on the type of indoor units that are connected (City Multi or Mr. Slim). (When City Multi is connected, only "Error history" will appear in the menu.)

<Mr. Slim>

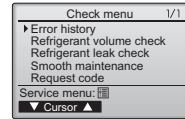

[1] Error history

Select "Error history" from the Check menu, and press the SELECT button to view up to 16 error history records. Four records are shown per page, and the top record on the first page indicates the latest error record.

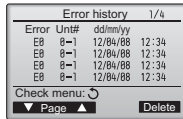

"Error history deleted" will appear on the screen. Press the Return button to go back to the Check menu screen.

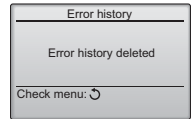

[Deleting the error history]

To delete the error history, press the F4 button (Delete) on the screen that shows error history. A confirmation screen will appear asking if you want to delete the error history. Press the F4 button (OK) to delete the history.

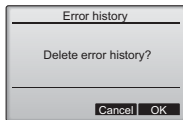

[2] Other options in the Check menu (Mr. Slim only)

The following options are also available on the Mr. Slim units in the Check menu.

- Refrigerant volume check
- Refrigerant leak check
- Smooth maintenance
- Request code

These options are available only on the Mr. Slim units. Refer to the indoor unit Installation Manual for details.

(6) Diagnostic function.

Error history of each unit can be checked via the remote controller. [Procedures]

- [1] Select "Self check" from the Service menu, and press the SELECT button to view the Self check screen.
- [2] With the F1 or F2 button, enter the refrigerant address (Mr. Slim) or the M-NET address (City Multi), and press the SELECT button.
- [3] Error code, unit number, attribute, and indoor unit demand signal ON/OFF status at the contact (City Multi only) will appear. "--" will appear if no error history is available.

<Mr. Slim>

<City Multi>

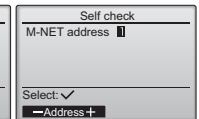
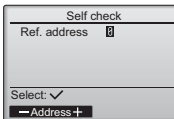

<Mr. Slim>

<City Multi>

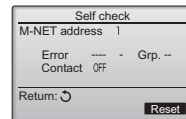
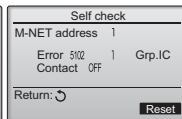
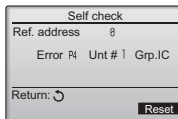

When there is no error history

[Resetting the error history]

- [1] Press the F4 button (Reset) on the screen that shows the error history. A confirmation screen will appear asking if you want to delete the error history.

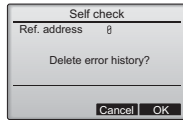

- [2] Press the F4 button (OK) to delete the error history. If deletion fails, "Request rejected" will appear, and "Unit not exist" will appear if no indoor units that are correspond to the entered address are found.

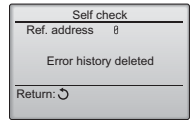

- (7) Setting the maintenance password  
Take the following steps to change the maintenance password.

[Procedures]

- [1] Select "Maintenance password" on the Service menu, and press the SELECT button to bring up the screen to enter a new password.  
[2] Move the cursor to the digit you want to change with the F1 or F2 button, and set each digit to the desired number (0 through 9) with the F3 or F4 button.  
[3] Press the SELECT button to save the new password.  
[4] A confirmation screen will appear asking if you want to change the maintenance password. Press the F4 button (OK) to save the change. Press the F3 button (Cancel) to cancel the change.

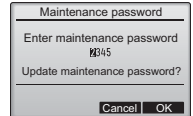
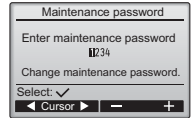

- [5] "Changes saved" will appear when the password is updated.  
[6] Press the MENU button to return to the Service menu or press the RETURN button to go back to the "Maintenance password" screen.

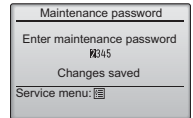

## 13. Remote controller check

When the remote controller does not work properly, use the remote controller checking function to troubleshoot the problem.

- (1) Check the remote controller display and see if anything is displayed (including lines). Nothing will appear on the remote controller display if the correct voltage (8.5-12 VDC) is not supplied to the remote controller. If this is the case, check the remote controller wiring and indoor units.

[Procedures]

- [1] Select "Remote controller check" from the Service menu, and press the SELECT button to start the remote controller check and see the check results. To cancel the remote controller check and exit the Remote controller check menu screen, press the MENU or the RETURN button. The remote controller will not reboot itself.

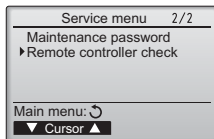

Select "Remote controller check".

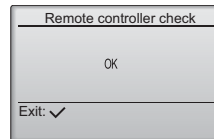
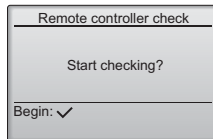

Remote controller check results screen

OK: No problems are found with the remote controller. Check other parts for problems.

E3, 6832: There is noise on the transmission line, or the indoor unit or another remote controller is faulty. Check the transmission line and the other remote controllers.

NG (ALL, ALL1): Send-receive circuit fault. Remote controller needs replacing.

ERC: The number of data errors is the discrepancy between the number of bits in the data transmitted from the remote controller and that of the data that was actually transmitted over the transmission line. If data errors are found, check the transmission line for external noise interference.

- [2] If the SELECT button is pressed after the remote controller check results are displayed, remote controller check will end, and the remote controller will automatically reboot itself.

## MITSUBISHI ELECTRIC CORPORATION

HEAD OFFICE: TOKYO BLDG., 2-7-3, MARUNOUCHI, CHIYODA-KU, TOKYO 100-8310, JAPAN

Authorized representative in EU: MITSUBISHI ELECTRIC EUROPE B.V.

HARMAN HOUSE, 1 GEORGE STREET, UXBRIDGE, MIDDLESEX UB8 1QQ, U.K.