



Changes for the Better

AIR CONDITIONING SYSTEMS

CITY MULTI

for a greener tomorrow



DATA BOOK

R410A series

YKBYLM

DATABOOK describes the technical specifications of MITSUBISHI ELECTRIC Corp.'s CITYMULTI air conditioning system products.

DATABOOK YKB/YLM is updated from DATABOOK YLM 2nd edition.
The contents below are added as well as some minor revisions.

Indoor: PEFY-P-VMA3-E has been added to the lineup.
LGH-RX5-E has changed to LGH-RVX-E.
GUF-RD3 and GUF-RDH3 have changed to GUF-RD4 and GUF-RDH4.

Outdoor: PUHY-P-Y(S)KB-A1 has been added to the lineup.
PURY-P-Y(S)LM-A1 has been added to the lineup.

We recommend DATABOOK users to read carefully and take advantage of all the contents inside to design the CITY MULTI air conditioning system and/or to prepare documents for promotions.

Along with the DATABOOK, MITSUBISHI ELECTRIC provides a Design-Tool software to ensure the users to design the system correctly and simplify the calculations. Please contact your local distributor for this software.

Please be notified that specifications are subject to change without notice due to continual improvements of the product.
For any inquiries, please contact your local distributor.

Registered trademarks

- Microsoft[®], Windows[®], Windows Vista[®], and Internet Explorer[®] are registered trademarks of Microsoft Corporation US in the USA and other countries.
- Pentium[®] and Core[™] are trademarks or registered trademarks of Intel Corporation.
- Oracle[®] is a registered trademarks of Oracle and/or its affiliates.



- Java[™] is a registered trademark of Oracle and/or its affiliates.
- BACnet[®] is a registered trademark of ASHRAE.
- LONWORKS[®] is a registered trademark of Echelon Corporation.

In this manual, Windows[®] 8.1 Pro will be referred to as Windows 8.1, Windows[®] 7 Professional will be referred to as Windows 7, Windows Vista[®] Business as Windows Vista, Windows[®] XP Professional as Windows XP, and Windows[®] 2000 Professional as Windows 2000.

CITY MULTI

Databook YKB/YLM

1. INDOOR

GENERAL LINE-UP.....	1 - 2
Ceiling concealed (Silent/Slim/High static pressure type).....	1 - 3
PEFY-P-VMR-E-L/R, PEFY-P-VMS1(L)-E, PEFY-P-VMH(S)-E	
Ceiling concealed (Middle static pressure type).....	1 - 47
PEFY-P-VMA(L)-E, PEFY-P-VMA3-E	
Ceiling concealed (Fresh air intake).....	1 - 89
PEFY-P-VMH-E-F	
Ceiling cassette (1-way flow type).....	1 - 109
PMFY-P-VBM-E	
Ceiling cassette (2-way flow type).....	1 - 117
PLFY-P-VLMD-E	
Ceiling cassette (4-way flow type).....	1 - 133
PLFY-P-VCM-E2, PLFY-P-VBM-E	
Ceiling suspended.....	1 - 153
PCFY-P-VKM-E	
Wall mounted.....	1 - 165
PKFY-P-VBM-E, PKFY-P-VHM-E, PKFY-P-VKM-E	
Floor standing (Exposed 2-way/Exposed/Concealed type).....	1 - 179
PFFY-P-VKM-E2, PFFY-P-VLEM-E, PFFY-P-VLRM-E, PFFY-P-VLRMM-E	
LOSSNAY.....	1 - 203
LGH-RVX-E	
OA processing unit.....	1 - 217
GUF-RD4, GUF-RDH4	
BC controller.....	1 - 225
CMB-P-V-G1, CMB-P-V-GA1, CMB-P-V-HA1, CMB-P-V-GB1, CMB-P-V-HB1	
CAPACITY TABLE.....	1 - 251

2. OUTDOOR

GENERAL LINE-UP.....	2 - 2
Y SERIES.....	2 - 7
Y (High COP) SERIES.....	2 - 113
R2 SERIES.....	2 - 213
R2 (High COP) SERIES.....	2 - 293

CITY MULTI

Databook YKB/YLM

3. CONTROLLER

Air-conditioner Network System (MELANS)	3 - 2
Local remote controller	3 - 4
System remote controller.....	3 - 10
System component.....	3 - 106

4. SYSTEM DESIGN

SYSTEM DESIGN Y SERIES.....	4 - 3
SYSTEM DESIGN R2 SERIES.....	4 - 65

CITY MULTI

1. INDOOR UNITS

GENERAL LINE-UP.....	1 - 2
Ceiling concealed (Silent/Slim/High static pressure type)	1 - 3
PEFY-P-VMR-E-L/R, PEFY-P-VMS1(L)-E, PEFY-P-VMH(S)-E	
Ceiling concealed (Middle static pressure type)	1 - 47
PEFY-P-VMA(L)-E, PEFY-P-VMA3-E	
Ceiling concealed (Fresh air intake type).....	1 - 89
PEFY-P-VMH-E-F	
Ceiling cassette (1-way flow type)	1 - 109
PMFY-P-VBM-E	
Ceiling cassette (2-way flow type)	1 - 117
PLFY-P-VLMD-E	
Ceiling cassette (4-way flow type)	1 - 133
PLFY-P-VCM-E2, PLFY-P-VBM-E	
Ceiling suspended	1 - 153
PCFY-P-VKM-E	
Wall mounted	1 - 165
PKFY-P-VBM-E, PKFY-P-VHM-E, PKFY-P-VKM-E	
Floor standing (Exposed 2-way/Exposed/Concealed type)	1 - 179
PFFY-P-VKM-E2, PFFY-P-VLEM-E, PFFY-P-VLRM-E, PFFY-P-VLRMM-E	
LOSSNAY	1 - 203
LGH-RVX-E	
OA processing unit	1 - 217
GUF-RD4, GUF-RDH4	
BC controller	1 - 225
CMB-P-V-G1, CMB-P-V-GA1, CMB-P-V-HA1, CMB-P-V-GB1, CMB-P-V-HB1	
CAPACITY TABLES	1 - 251

Indoor Units Line-up of CITY MULTI R410A Series.

All the indoor units are subject to CE and CCC regulation.

Model size	P15	P20	P25	P32	P40	P50	P63	P71	P80	P100	P125	P140	P200	P250	
Nominal HP	0.6HP	0.8HP	1.0HP	1.3HP	1.6HP	2.0HP	2.5HP	2.8HP	3.2HP	4.0HP	5.0HP	5.6HP	8.0HP	10.0HP	
Nominal cooling cap.*1	kW	1.7	2.2	2.8	3.6	4.5	5.6	7.1	8.0	9.0	11.2	14.0	16.0	22.4	28.0
	kcal/h	1,450	1,900	2,400	3,100	3,900	4,800	6,100	6,900	7,700	9,600	12,000	13,800	19,300	24,100
	Btu/h	5,800	7,500	9,600	12,300	15,400	19,100	24,200	27,300	30,700	38,200	47,800	54,600	76,400	95,500
Nominal cooling cap.*2	kW	1.8	2.3	2.9	3.7	4.7	5.8	7.3	8.3	9.3	11.6	14.5	16.3	23.2	29.1
	kcal/h	1,500	2,000	2,500	3,200	4,000	5,000	6,300	7,100	8,000	10,000	12,500	14,000	20,000	25,000
	Btu/h	6,100	7,800	9,900	12,600	16,000	19,800	24,900	28,300	31,700	39,600	49,500	55,600	79,200	99,300
Nominal heating cap.*3	kW	1.9	2.5	3.2	4.0	5.0	6.3	8.0	9.0	10.0	12.5	16.0	18.0	25.0	31.5
	kcal/h	1,600	2,200	2,800	3,400	4,300	5,400	6,900	7,700	8,600	10,800	13,800	15,500	21,500	27,100
	Btu/h	6,500	8,500	10,900	13,600	17,100	21,500	27,300	30,700	34,100	42,700	54,600	61,400	85,300	107,500
Ceiling concealed															
PEFY-P-VMR-E-L/R		●	●	●											
PEFY-P-VMS1(L)-E	●	●	●	●	●	●	●								
PEFY-P-VMH(S)-E					●	●	●	●	●	●	●	●	●	●	
PEFY-P-VMA(L)-E		●	●	●	●	●	●	●	●	●	●	●			
PEFY-P-VMA3-E		●													
PEFY-P-VMH-E-F									●			●	●	●	
Ceiling cassette															
PMFY-P-VBM-E		●	●	●	●										
PLFY-P-VLMD-E		●	●	●	●	●	●			●	●	●			
PLFY-P-VCM-E2	●	●	●	●	●	●	●								
PLFY-P-VBM-E		●	●	●	●	●	●			●	●	●			
Ceiling suspended															
PCFY-P-VKM-E					●	●				●	●				
Wall mounted															
PKFY-P-VBM-E	●	●	●												
PKFY-P-VHM-E				●	●	●									
PKFY-P-VKM-E							●			●					
Floor standing															
PFFY-P-VKM-E2		●	●	●	●										
PFFY-P-VLEM-E		●	●	●	●	●	●								
PFFY-P-VLRM-E		●	●	●	●	●	●								
PFFY-P-VLRMM-E		●	●	●	●	●	●								

* kcal/h=round(kWx860,-2), BTU/h=round(kWx3,412,-2)

* Nominal conditions *1, *2, *3 are referable at the Specification sheet.

PEFY-P-VMR-E-L/R, PEFY-P-VMS1(L)-E, PEFY-P-VMH(S)-E

1. SPECIFICATIONS	1 - 4
2. EXTERNAL DIMENSIONS	1 - 11
3. CENTER OF GRAVITY	1 - 17
4. ELECTRICAL WIRING DIAGRAMS	1 - 18
5. SOUND LEVELS	1 - 23
5-1. Sound levels	1 - 23
5-2. NC curves	1 - 24
6. FAN CHARACTERISTICS CURVES.....	1 - 32
7. OPTIONAL PARTS.....	1 - 42
7-1. Optional parts line up for the Indoor unit.....	1 - 42
7-2. Long-life filter	1 - 43
7-3. Drain pump	1 - 44
7-4. Control box replace kit	1 - 45

1. SPECIFICATIONS

YKB/YLM

PEFY

Model		PEFY-P20VMR-E-L/R	PEFY-P25VMR-E-L/R	PEFY-P32VMR-E-L/R		
Power source		1-phase 220-240V 50Hz / 220-230V 60Hz				
Cooling capacity (Nominal)	*1	kW	2.2	2.8	3.6	
	*1	kcal / h	1,900	2,400	3,100	
	*1	BTU / h	7,500	9,600	12,300	
	*2	kcal / h	2,000	2,500	3,150	
	*4	Power input	kW	0.06 / 0.06	0.06 / 0.06	0.07 / 0.08
*4	Current input	A	0.29 / 0.29 (220V)	0.29 / 0.29 (220V)	0.34 / 0.38 (220V)	
Heating capacity (Nominal)	*3	kW	2.5	3.2	4.0	
	*3	kcal / h	2,200	2,800	3,400	
	*3	BTU / h	8,500	10,900	13,600	
	*4	Power input	kW	0.06 / 0.06	0.06 / 0.06	0.07 / 0.08
	*4	Current input	A	0.29 / 0.29 (220V)	0.29 / 0.29 (220V)	0.34 / 0.38 (220V)
External finish		Galvanized				
External dimension H x W x D		mm	292 x 640 x 580	292 x 640 x 580	292 x 640 x 580	
		in.	11-1/2 x 25-1/4 x 22-7/8	11-1/2 x 25-1/4 x 22-7/8	11-1/2 x 25-1/4 x 22-7/8	
Net weight		kg (lbs)	18 (40)	18 (40)	18 (40)	
Heat exchanger		Cross fin (Aluminum fin and copper tube)				
FAN	Type x Quantity		Sirocco fan x 1	Sirocco fan x 1	Sirocco fan x 1	
	External (220V) static press. (230, 240V) *5	Pa	5	5	5	
		mmH ₂ O	0.5	0.5	0.5	
		Pa	5	5	5	
		mmH ₂ O	0.5	0.5	0.5	
	Motor type		1-phase induction motor			
	Motor output	kW	0.018	0.018	0.023	
	Driving mechanism		Direct-driven by motor			
	Airflow rate (Low-Mid-High)	m ³ / min	4.8 - 5.8 - 7.9	4.8 - 5.8 - 7.9	4.8 - 5.8 - 9.3	
		L / s	80 - 97 - 132	80 - 97 - 132	80 - 97 - 155	
cfm		170 - 205 - 279	170 - 205 - 279	170 - 205 - 328		
Sound pressure level (Low-Mid-High) (measured in anechoic room) *4	dB <A>	20 - 25 - 30 * (220V)	20 - 25 - 30 * (220V)	20 - 25 - 33 * (220V)		
	dB <A>	21 - 26 - 32 * (230V)	21 - 26 - 32 * (230V)	21 - 26 - 35 * (230V)		
	dB <A>	22 - 27 - 30 * (240V)	22 - 27 - 30 * (240V)	22 - 27 - 33 * (240V)		
Insulation material		Polystyrene foam, Polyethylene foam, Urethane foam				
Air filter		PP Honeycomb fabric (washable)				
Protection device		Fuse				
Refrigerant control device		LEV				
Connectable outdoor unit		R410A CITY MULTI				
Diameter of refrigerant pipe	Liquid (R410A)	mm (in.)	ø6.35 (ø1/4) Brazed	ø6.35 (ø1/4) Brazed	ø6.35 (ø1/4) Brazed	
	Gas (R410A)	mm (in.)	ø12.7 (ø1/2) Brazed	ø12.7 (ø1/2) Brazed	ø12.7 (ø1/2) Brazed	
Field drain pipe size		mm (in.)	O.D. 26mm (1)			
Drawing	External		IU-KB94-C854	IU-KB94-C854	IU-KB94-C854	
	Wiring		IU-KB94-C858	IU-KB94-C858	IU-KB94-C858	
	Refrigerant cycle		-	-	-	
Standard attachment	Document Accessory	Installation Manual, Instruction Book Drain hose I.D. 26mm (1) (flexible joint)				
Remark		* Above sound pressure level is tested in rear air inlet case. It will be a little higher in bottom air inlet case.				
Installation		Details on foundation work, duct work, insulation work, electrical wiring, power source switch, and other items shall be referred to the Installation Manual.				
Note :		*1 Nominal cooling conditions	*2 Nominal cooling conditions	*3 Nominal heating conditions	Unit converter	
Indoor : 27°CDB/19°CWB (81°FDB/66°FWB)		27°CDB/19.5°CWB (81°FDB/67°FWB)	20°CDB (68°FDB)		kcal/h = kW x 860	
Outdoor : 35°CDB (95°FDB)		35°CDB (95°FDB)	7°CDB/6°CWB (45°FDB/43°FWB)		BTU/h = kW x 3,412	
Pipe length : 7.5 m (24-9/16 ft)		5 m (16-3/8 ft)	7.5 m (24-9/16 ft)		cfm = m ³ /min x 35.31	
Level difference : 0 m (0 ft)		0 m (0 ft)	0 m (0 ft)		lbs = kg / 0.4536	
* Nominal conditions *1, *3 are subject to JIS B8615-2.					*Above specification data is subject to rounding variation.	
* Due to continuing improvement, above specification may be subject to change without notice.						
*4 The values are measured at the factory setting of external static pressure.						
*5 The external static pressure is set to 5 Pa and 0.5 mmH ₂ O.						

1. SPECIFICATIONS

Model		PEFY-P15VMS1(L)-E	PEFY-P20VMS1(L)-E	PEFY-P25VMS1(L)-E	PEFY-P32VMS1(L)-E		
Power source		220-240V (50/60Hz)					
Cooling capacity (Nominal)	*1	kW	1.7	2.2	2.8	3.6	
	*1	kcal / h	1,450	1,900	2,400	3,100	
	*1	BTU / h	5,800	7,500	9,600	12,300	
	*2	kcal / h	1,500	2,000	2,500	3,150	
	*4	Power input	kW	0.05<0.03>	0.05<0.03>	0.06<0.04>	0.07<0.05>
*4	Current input	A	0.42<0.31>	0.47<0.36>	0.50<0.39>	0.50<0.39>	
Heating capacity (Nominal)	*3	kW	1.9	2.5	3.2	4.0	
	*3	kcal / h	1,600	2,200	2,800	3,400	
	*3	BTU / h	6,500	8,500	10,900	13,600	
	*4	Power input	kW	0.03<0.03>	0.03<0.03>	0.04<0.04>	0.05<0.05>
	*4	Current input	A	0.31<0.31>	0.36<0.36>	0.39<0.39>	0.39<0.39>
External finish		Galvanized					
External dimension H x W x D		mm	200 x 790 x 700	200 x 790 x 700	200 x 790 x 700	200 x 790 x 700	
		in.	7-7/8 x 31-1/8 x 27-9/16	7-7/8 x 31-1/8 x 27-9/16	7-7/8 x 31-1/8 x 27-9/16	7-7/8 x 31-1/8 x 27-9/16	
Net weight		kg (lbs)	19(42)<18(40)>	19(42)<18(40)>	19(42)<18(40)>	20(44)<19(42)>	
Heat exchanger		Cross fin (Aluminum fin and copper tube)					
FAN	Type x Quantity		Sirocco fan x 2	Sirocco fan x 2	Sirocco fan x 2	Sirocco fan x 2	
	External (220V) static press. (230, 240V)	Pa	<5> - 15 - <35> - <50>	<5> - 15 - <35> - <50>	<5> - 15 - <35> - <50>	<5> - 15 - <35> - <50>	
		mmH ₂ O	<0.5> - 1.5 - <3.6> - <5.1>	<0.5> - 1.5 - <3.6> - <5.1>	<0.5> - 1.5 - <3.6> - <5.1>	<0.5> - 1.5 - <3.6> - <5.1>	
		Pa	<5> - 15 - <35> - <50>	<5> - 15 - <35> - <50>	<5> - 15 - <35> - <50>	<5> - 15 - <35> - <50>	
		*5 mmH ₂ O	<0.5> - 1.5 - <3.6> - <5.1>	<0.5> - 1.5 - <3.6> - <5.1>	<0.5> - 1.5 - <3.6> - <5.1>	<0.5> - 1.5 - <3.6> - <5.1>	
	Motor type		DC motor				
	Motor output		kW	0.096	0.096	0.096	0.096
	Driving mechanism		Direct-driven				
	Airflow rate (Low-Mid-High)		m ³ / min	5 - 6 - 7	5.5 - 6.5 - 8	5.5 - 7 - 9	6 - 8 - 10
			L / s	83 - 100 - 117	91 - 108 - 133	91 - 117 - 150	100 - 133 - 167
cfm			176 - 212 - 247	194 - 229 - 282	194 - 247 - 317	212 - 282 - 353	
Sound pressure level (Low-Mid-High) (measured in anechoic room) *4		dB <A>	22 - 24 - 28(15Pa,220-240V)	23 - 25 - 29(15Pa,220-240V)	24 - 26 - 30(15Pa,220-240V)	24 - 27 - 32(15Pa,220-240V)	
Insulation material		Polystyrene foam, Polyethylene foam, Urethane foam					
Air filter		PP Honeycomb fabric (washable)					
Protection device		Fuse					
Refrigerant control device		LEV					
Connectable outdoor unit		R410A CITY MULTI					
Diameter of refrigerant pipe	Liquid (R410A)	mm (in.)	ø6.35 (ø1/4) Brazed	ø6.35 (ø1/4) Brazed	ø6.35 (ø1/4) Brazed	ø6.35 (ø1/4) Brazed	
	Gas (R410A)	mm (in.)	ø12.7 (ø1/2) Brazed	ø12.7 (ø1/2) Brazed	ø12.7 (ø1/2) Brazed	ø12.7 (ø1/2) Brazed	
Field drain pipe size		mm (in.)	O.D. 32mm (1-1/4)				
Drawing	External		IU-KB94-G728<IU-KB94-G731>	IU-KB94-G728<IU-KB94-G731>	IU-KB94-G728<IU-KB94-G731>	IU-KB94-G728<IU-KB94-G731>	
	Wiring		IU-KB94-G668	IU-KB94-G668	IU-KB94-G668	IU-KB94-G668	
	Refrigerant cycle		-	-	-	-	
Standard attachment	Document		Installation Manual, Instruction Book				
	Accessory		Drain hose (flexible joint)				
Remark	Optional parts						
	Drain pump		<PAC-KE07DM-E>	<PAC-KE07DM-E>	<PAC-KE07DM-E>	<PAC-KE07DM-E>	
	Control Box Replace kit		<PAC-KE70HS-E>	<PAC-KE70HS-E>	<PAC-KE70HS-E>	<PAC-KE70HS-E>	
	Installation		Details on foundation work, duct work, insulation work, electrical wiring, power source switch, and other items shall be referred to the Installation Manual.				
Note :		*1 Nominal cooling conditions Indoor : 27°CDB/19°CWB (81°FDB/66°FWB) Outdoor : 35°CDB (95°FDB) Pipe length : 7.5 m (24-9/16 ft) Level difference : 0 m (0 ft)	*2 Nominal cooling conditions 27°CDB/19.5°CWB (81°FDB/67°FWB) 35°CDB (95°FDB) 5 m (16-3/8 ft) 0 m (0 ft)	*3 Nominal heating conditions 20°CDB (68°FDB) 7°CDB/6°CWB (45°FDB/43°FWB) 7.5 m (24-9/16 ft) 0 m (0 ft)	Unit converter kcal/h = kW x 860 BTU/h = kW x 3,412 cfm = m ³ /min x 35.31 lbs = kg / 0.4536		
* Nominal conditions *1, *3 are subject to JIS B8615-2.		* Due to continuing improvement, above specification may be subject to change without notice.		* The external static pressure is set to 15 Pa at factory shipment. * < > is in case of PEFY-P-VMS1(L)-E model.		*Above specification data is subject to rounding variation.	
*4 The values are measured at the factory setting of external static pressure. *5 The factory setting of external static pressure is shown without < >. Refer to "Fan characteristics curves", according to the external static pressure, in DATA BOOK for the usable range of air flow rate.							

1. SPECIFICATIONS

YKB/YLM

PEFY

Model		PEFY-P40VMS1(L)-E	PEFY-P50VMS1(L)-E	PEFY-P63VMS1(L)-E		
Power source		220-240V (50/60Hz)				
Cooling capacity (Nominal)	*1	kW	4.5	5.6	7.1	
	*1	kcal / h	3,900	4,800	6,100	
	*1	BTU / h	15,400	19,100	24,200	
	*2	kcal / h	4,000	5,000	6,300	
	*4	Power input	kW	0.07<0.05>	0.09<0.07>	0.09<0.07>
*4	Current input	A	0.56<0.45>	0.67<0.56>	0.72<0.61>	
Heating capacity (Nominal)	*3	kW	5.0	6.3	8.0	
	*3	kcal / h	4,300	5,400	6,900	
	*3	BTU / h	17,100	21,500	27,300	
	*4	Power input	kW	0.05<0.05>	0.07<0.07>	0.07<0.07>
	*4	Current input	A	0.45<0.45>	0.56<0.56>	0.61<0.61>
External finish		Galvanized				
External dimension H x W x D		mm	200 x 990 x 700	200 x 990 x 700	200 x 1190 x 700	
		in.	7-7/8 x 39 x 27-9/16	7-7/8 x 39 x 27-9/16	7-7/8 x 46-7/8 x 27-9/16	
Net weight		kg (lbs)	24(53)<23(51)>	24(53)<23(51)>	28(62)<27(60)>	
Heat exchanger		Cross fin (Aluminum fin and copper tube)				
FAN	Type x Quantity		Sirocco fan x 3	Sirocco fan x 3	Sirocco fan x 4	
	External (220V) static press. (230, 240V)	Pa	<5> - 15 - <35> - <50>	<5> - 15 - <35> - <50>	<5> - 15 - <35> - <50>	
		mmH ₂ O	<0.5> - 1.5 - <3.6> - <5.1>	<0.5> - 1.5 - <3.6> - <5.1>	<0.5> - 1.5 - <3.6> - <5.1>	
		Pa	<5> - 15 - <35> - <50>	<5> - 15 - <35> - <50>	<5> - 15 - <35> - <50>	
	*5	mmH ₂ O	<0.5> - 1.5 - <3.6> - <5.1>	<0.5> - 1.5 - <3.6> - <5.1>	<0.5> - 1.5 - <3.6> - <5.1>	
	Motor type		DC motor			
	Motor output		kW	0.096	0.096	0.096
	Driving mechanism		Direct-driven			
	Airflow rate (Low-Mid-High)	m ³ / min		8 - 9.5 - 11	9.5 - 11 - 13	12 - 14 - 16.5
		L / s		133 - 158 - 183	158 - 183 - 217	200 - 233 - 275
cfm		282 - 335 - 388	335 - 388 - 459	424 - 494 - 583		
Sound pressure level (Low-Mid-High) (measured in anechoic room)		*4	dB <A>	28 - 30 - 33 (15Pa,220-240V)	30 - 32 - 35 (15Pa,220-240V)	30 - 33 - 36 (15Pa,220-240V)
Insulation material		Polystyrene foam, Polyethylene foam, Urethane foam				
Air filter		PP Honeycomb fabric (washable)				
Protection device		Fuse				
Refrigerant control device		LEV				
Connectable outdoor unit		R410A CITY MULTI				
Diameter of refrigerant pipe	Liquid (R410A)	mm (in.)	ø6.35 (ø1/4) Brazed	ø6.35 (ø1/4) Brazed	ø9.52 (ø3/8) Brazed	
	Gas (R410A)	mm (in.)	ø12.7 (ø1/2) Brazed	ø12.7 (ø1/2) Brazed	ø15.88 (ø5/8) Brazed	
Field drain pipe size		mm (in.)	O.D. 32mm (1-1/4)			
Drawing	External		IU-KB94-G728(IU-KB94-G731)	IU-KB94-G728(IU-KB94-G731)	IU-KB94-G728(IU-KB94-G731)	
	Wiring		IU-KB94-G668	IU-KB94-G668	IU-KB94-G668	
	Refrigerant cycle		-	-	-	
Standard attachment	Document		Installation Manual, Instruction Book			
	Accessory		Drain hose (flexible joint)			
Remark	Optional parts					
	Drain pump		<PAC-KE07DM-E>	<PAC-KE07DM-E>	<PAC-KE07DM-E>	
	Control Box Replace kit		<PAC-KE70HS-E>	<PAC-KE70HS-E>	<PAC-KE70HS-E>	
	Installation		Details on foundation work, duct work, insulation work, electrical wiring, power source switch, and other items shall be referred to the Installation Manual.			
Note :		*1 Nominal cooling conditions	*2 Nominal cooling conditions	*3 Nominal heating conditions	Unit converter	
Indoor : 27°CDB/19°CWB (81°FDB/66°FWB)		27°CDB/19.5°CWB (81°FDB/67°FWB)	20°CDB (68°FDB)	kcal/h = kW x 860	*Above specification data is subject to rounding variation.	
Outdoor : 35°CDB (95°FDB)		35°CDB (95°FDB)	7°CDB/6°CWB (45°FDB/43°FWB)	BTU/h = kW x 3,412		
Pipe length : 7.5 m (24-9/16 ft)		5 m (16-3/8 ft)	7.5 m (24-9/16 ft)	cfm = m ³ /min x 35.31		
Level difference : 0 m (0 ft)		0 m (0 ft)	0 m (0 ft)	lbs = kg / 0.4536		
* Nominal conditions *1, *3 are subject to JIS B8615-2.		* The external static pressure is set to 15 Pa at factory shipment.				
* Due to continuing improvement, above specification may be subject to change without notice.		* < > is in case of PEFY-P-VMS1L-E model.				
*4 The values are measured at the factory setting of external static pressure.						
*5 The factory setting of external static pressure is shown without < >.						
Refer to "Fan characteristics curves", according to the external static pressure, in DATA BOOK for the usable range of air flow rate.						

1. SPECIFICATIONS

YKB/YLM

PEFY

Model		PEFY-P40VMH-E	PEFY-P50VMH-E	PEFY-P63VMH-E	PEFY-P71VMH-E		
Power source		1-phase 220-240V 50Hz/60Hz					
Cooling capacity (Nominal)	*1	kW	4.5	5.6	7.1	8.0	
	*1	kcal / h	3,900	4,800	6,100	6,900	
	*1	BTU / h	15,400	19,100	24,200	27,300	
	*2	kcal / h	4,000	5,000	6,300	7,100	
	*4	Power input	kW	0.19 / 0.23	0.19 / 0.23	0.24 / 0.30	0.26 / 0.33
*4	Current input	A	0.88 / 1.06	0.88 / 1.06	1.12 / 1.38	1.20 / 1.51	
Heating capacity (Nominal)	*3	kW	5.0	6.3	8.0	9.0	
	*3	kcal / h	4,300	5,400	6,900	7,700	
	*3	BTU / h	17,100	21,500	27,300	30,700	
	*4	Power input	kW	0.19 / 0.23	0.19 / 0.23	0.24 / 0.30	0.26 / 0.33
	*4	Current input	A	0.88 / 1.06	0.88 / 1.06	1.12 / 1.38	1.20 / 1.51
External finish		Galvanized					
External dimension H x W x D		mm	380 x 750 x 900	380 x 750 x 900	380 x 750 x 900	380 x 1,000 x 900	
		in.	15 x 29-9/16 x 35-7/16	15 x 29-9/16 x 35-7/16	15 x 29-9/16 x 35-7/16	15 x 39-3/8 x 35-7/16	
Net weight		kg (lbs)	41 (91)	41 (91)	41 (91)	50 (111)	
Heat exchanger		Cross fin (Aluminum fin and copper tube)					
FAN	Type x Quantity		Sirocco fan x 1	Sirocco fan x 1	Sirocco fan x 1	Sirocco fan x 1	
	External (220V) static press. (230, 240V)	Pa	<50> - 100 - <200>	<50> - 100 - <200>	<50> - 100 - <200>	<50> - 100 - <200>	
		mmH ₂ O	<5.1> - 10.2 - <20.4>	<5.1> - 10.2 - <20.4>	<5.1> - 10.2 - <20.4>	<5.1> - 10.2 - <20.4>	
		Pa	<100> - 150 - <200>	<100> - 150 - <200>	<100> - 150 - <200>	<100> - 150 - <200>	
	*5	mmH ₂ O	<10.2> - 15.3 - <20.4>	<10.2> - 15.3 - <20.4>	<10.2> - 15.3 - <20.4>	<10.2> - 15.3 - <20.4>	
	Motor type		1-phase induction motor				
	Motor output		kW	0.080	0.080	0.120	0.140
Driving mechanism		Direct-driven by motor					
Airflow rate (Low-Mid-High)	m ³ / min		10.0 - 14.0	10.0 - 14.0	13.5 - 19.0	15.5 - 22.0	
	L / s		167 - 233	167 - 233	225 - 317	258 - 367	
	cfm		353 - 494	353 - 494	477 - 671	547 - 777	
Sound pressure level (Low-Mid-High) (measured in anechoic room)		*4	dB <A> 27 - 34 (220V) 31 - 37 (230, 240V)	dB <A> 27 - 34 (220V) 31 - 37 (230, 240V)	dB <A> 32 - 38 (220V) 36 - 41 (230, 240V)	dB <A> 32 - 39 (220V) 35 - 41 (230, 240V)	
Insulation material		Polystyrene foam, Polyethylene foam, Urethane foam					
Air filter		Optional long life filter (Synthetic fiber unwoven cloth filter) and filter box are recommended.					
Protection device		Fuse					
Refrigerant control device		LEV					
Connectable outdoor unit		R410A CITY MULTI					
Diameter of refrigerant pipe	Liquid (R410A)	mm (in.)	ø6.35 (ø1/4) Flare	ø6.35 (ø1/4) Flare	ø9.52 (ø3/8) Flare	ø9.52 (ø3/8) Flare	
	Gas (R410A)	mm (in.)	ø12.7 (ø1/2) Flare	ø12.7 (ø1/2) Flare	ø15.88 (ø5/8) Flare	ø15.88 (ø5/8) Flare	
Field drain pipe size		mm (in.)	O.D. 32mm (1-1/4)				
Drawing	External		IU-W27-5924				
	Wiring		IU-W65-3956				
	Refrigerant cycle		-				
Standard attachment	Document		Installation Manual, Instruction Book				
	Accessory		Drain hose I.D. 32mm (1-1/4) (flexible joint)				
Remark	Optional parts						
	Long life filter		PAC-KE86LAF	PAC-KE86LAF	PAC-KE86LAF	PAC-KE88LAF	
	Filter box		PAC-KE63TB-F	PAC-KE63TB-F	PAC-KE63TB-F	PAC-KE80TB-F	
	Drain pump		PAC-KE04DM-F	PAC-KE04DM-F	PAC-KE04DM-F	PAC-KE04DM-F	
Installation		Details on foundation work, duct work, insulation work, electrical wiring, power source switch, and other items shall be referred to the Installation Manual.					
Note :		*1 Nominal cooling conditions Indoor : 27°CDB/19°CWB (81°FDB/66°FWB) Outdoor : 35°CDB (95°FDB) Pipe length : 7.5 m (24-9/16 ft) Level difference : 0 m (0 ft)	*2 Nominal cooling conditions 27°CDB/19.5°CWB (81°FDB/67°FWB) 35°CDB (95°FDB) 5 m (16-3/8 ft) 0 m (0 ft)	*3 Nominal heating conditions 20°CDB (68°FDB) 7°CDB/6°CWB (45°FDB/43°FWB) 7.5 m (24-9/16 ft) 0 m (0 ft)	Unit converter kcal/h = kW x 860 BTU/h = kW x 3,412 cfm = m ³ /min x 35.31 lbs = kg / 0.4536		
* Nominal conditions *1, *3 are subject to JIS B8615-2.		* Due to continuing improvement, above specification may be subject to change without notice.					
*4 The values are measured at the factory setting of external static pressure.							
*5 The factory setting of external static pressure is shown without < >.							
Refer to "Fan characteristics curves", according to the external static pressure, in DATA BOOK for the usable range of air flow rate.							
		*Above specification data is subject to rounding variation.					

1. SPECIFICATIONS

YKB/YLM

PEFY

Model		PEFY-P80VMH-E	PEFY-P100VMH-E	PEFY-P125VMH-E	PEFY-P140VMH-E		
Power source		1-phase 220-240V 50Hz/60Hz					
Cooling capacity (Nominal)	*1	kW	9.0	11.2	14.0	16.0	
	*1	kcal / h	7,700	9,600	12,000	13,800	
	*1	BTU / h	30,700	38,200	47,800	54,600	
	*2	kcal / h	8,000	10,000	12,500	14,000	
	*4	Power input	kW	0.32 / 0.40	0.48 / 0.58	0.48 / 0.58	0.48 / 0.59
	*4	Current input	A	1.47 / 1.83	2.34 / 2.66	2.34 / 2.66	2.35 / 2.70
Heating capacity (Nominal)	*3	kW	10.0	12.5	16.0	18.0	
	*3	kcal / h	8,600	10,800	13,800	15,500	
	*3	BTU / h	34,100	42,700	54,600	61,400	
	*4	Power input	kW	0.32 / 0.40	0.48 / 0.58	0.48 / 0.58	0.48 / 0.59
	*4	Current input	A	1.47 / 1.83	2.34 / 2.66	2.34 / 2.66	2.35 / 2.70
External finish		Galvanized					
External dimension H x W x D		mm	380 x 1,000 x 900	380 x 1,200 x 900	380 x 1,200 x 900	380 x 1,200 x 900	
		in.	15 x 39-3/8 x 35-7/16	15 x 47-1/4 x 35-7/16	15 x 47-1/4 x 35-7/16	15 x 47-1/4 x 35-7/16	
Net weight		kg (lbs)	50 (111)	65 (144)	65 (144)	67 (148)	
Heat exchanger		Cross fin (Aluminum fin and copper tube)					
FAN	Type x Quantity		Sirocco fan x 1	Sirocco fan x 2	Sirocco fan x 2	Sirocco fan x 2	
	External (220V) static press. (230, 240V)	Pa	<50> - 100 - <200>	<50> - 100 - <200>	<50> - 100 - <200>	<50> - 100 - <200>	
		mmH ₂ O	<5.1> - 10.2 - <20.4>	<5.1> - 10.2 - <20.4>	<5.1> - 10.2 - <20.4>	<5.1> - 10.2 - <20.4>	
		Pa	<100> - 150 - <200>	<100> - 150 - <200>	<100> - 150 - <200>	<100> - 150 - <200>	
	*5	mmH ₂ O	<10.2> - 15.3 - <20.4>	<10.2> - 15.3 - <20.4>	<10.2> - 15.3 - <20.4>	<10.2> - 15.3 - <20.4>	
	Motor type		1-phase induction motor				
	Motor output		kW	0.180	0.260	0.260	0.260
	Driving mechanism		Direct-driven by motor				
	Airflow rate (Low-Mid-High)	m ³ / min		18.0 - 25.0	26.5 - 38.0	26.5 - 38.0	28.0 - 40.0
		L / s		300 - 417	442 - 633	442 - 633	467 - 667
cfm		636 - 883	936 - 1,342	936 - 1,342	989 - 1,413		
Sound pressure level (Low-Mid-High) (measured in anechoic room) *4		dB <A>	35 - 41 (220V)	34 - 42 (220V)	34 - 42 (220V)	34 - 42 (220V)	
		dB <A>	38 - 43 (230, 240V)	38 - 44 (230, 240V)	38 - 44 (230, 240V)	38 - 44 (230, 240V)	
Insulation material		Polystyrene foam, Polyethylene foam, Urethane foam					
Air filter		Option : Synthetic fiber unwoven cloth filter (long life)					
Protection device		Fuse					
Refrigerant control device		LEV					
Connectable outdoor unit		R410A CITY MULTI					
Diameter of refrigerant pipe	Liquid (R410A)	mm (in.)	ø9.52 (ø3/8) Flare	ø9.52 (ø3/8) Flare	ø9.52 (ø3/8) Flare	ø9.52 (ø3/8) Flare	
	Gas (R410A)	mm (in.)	ø15.88 (ø5/8) Flare	ø15.88 (ø5/8) Flare	ø15.88 (ø5/8) Flare	ø15.88 (ø5/8) Flare	
Field drain pipe size		mm (in.)	O.D. 32mm (1-1/4)				
Drawing	External		IU-W27-5924				
	Wiring		IU-W65-3956				
	Refrigerant cycle		-				
Standard attachment	Document		Installation Manual, Instruction Book				
	Accessory		Drain hose I.D. 32mm (1-1/4) (flexible joint)				
Remark	Optional parts						
	Long life filter		PAC-KE88LAF	PAC-KE89LAF	PAC-KE89LAF	PAC-KE89LAF	
	Filter box		PAC-KE80TB-F	PAC-KE140TB-F	PAC-KE140TB-F	PAC-KE140TB-F	
	Drain pump		PAC-KE04DM-F	PAC-KE04DM-F	PAC-KE04DM-F	PAC-KE04DM-F	
	Installation		Details on foundation work, duct work, insulation work, electrical wiring, power source switch, and other items shall be referred to the Installation Manual.				
Note :		*1 Nominal cooling conditions	*2 Nominal cooling conditions	*3 Nominal heating conditions	Unit converter		
Indoor : 27°CDB/19°CWB (81°FDB/66°FWB)		27°CDB/19.5°CWB (81°FDB/67°FWB)	20°CDB (68°FDB)	kcal/h = kW x 860			
Outdoor : 35°CDB (95°FDB)		35°CDB (95°FDB)	7°CDB/6°CWB (45°FDB/43°FWB)	BTU/h = kW x 3,412			
Pipe length : 7.5 m (24-9/16 ft)		5 m (16-3/8 ft)	7.5 m (24-9/16 ft)	cfm = m ³ /min x 35.31			
Level difference : 0 m (0 ft)		0 m (0 ft)	0 m (0 ft)	lbs = kg / 0.4536			
* Nominal conditions *1, *3 are subject to JIS B8615-2.		* Due to continuing improvement, above specification may be subject to change without notice.				*Above specification data is subject to rounding variation.	
*4 The values are measured at the factory setting of external static pressure.							
*5 The factory setting of external static pressure is shown without < >.							
Refer to "Fan characteristics curves", according to the external static pressure, in DATA BOOK for the usable range of air flow rate.							

1. SPECIFICATIONS

Model		PEFY-P200VMH-E	PEFY-P250VMH-E			
Power source		3-phase, 4-wire, 380-415V 50/60Hz				
Cooling capacity (Nominal)	*1	kW	22.4	28.0		
	*1	kcal / h	19,300	24,100		
	*1	BTU / h	76,400	95,500		
	*2	kcal / h	20,000	25,000		
	*4	Power input	kW	0.99 / 1.14	1.23 / 1.41	
*4	Current input	A	1.62 / 1.86	2.0 / 2.3		
Heating capacity (Nominal)	*3	kW	25.0	31.5		
	*3	kcal / h	21,500	27,100		
	*3	BTU / h	85,300	107,500		
	*4	Power input	kW	0.99 / 1.14	1.23 / 1.41	
	*4	Current input	A	1.62 / 1.86	2.0 / 2.3	
External finish		Galvanized				
External dimension H x W x D		mm	470 X 1,250 X 1,120	470 X 1,250 X 1,120		
		in.	18-9/16 x 49-1/4 x 44-1/8	18-9/16 x 49-1/4 x 44-1/8		
Net weight		kg (lbs)	100 (221)	100 (221)		
Heat exchanger		Cross fin (Aluminum fin and copper tube)				
FAN	Type x Quantity		Sirocco fan x 2	Sirocco fan x 2		
	External (380V) static press. (400, 415V)	Pa	<110>- 220	<110>- 220		
		mmH ₂ O	<11.2>- 22.4	<11.2>- 22.4		
		Pa	<130>- 260	<130>- 260		
		*5 mmH ₂ O	<13.3>- 26.5	<13.3>- 26.5		
	Motor type		3-phase induction motor			
	Motor output		kW	0.760	1.080	
	Driving mechanism		Direct-driven by motor			
	Airflow rate (Low-Mid-High)	m ³ / min	58	72		
		L / s	967	1,200		
cfm		2,048	2,543			
Sound pressure level (Low-Mid-High) (measured in anechoic room)	*4	dB <A>	42 / 45 (380V)	50 / 52 (380V)		
		dB <A>	44 / 47 (400, 415V)	52 / 54 (400, 415V)		
Insulation material		Polystyrene foam, Polyethylene foam, Urethane foam				
Air filter		Option : Synthetic fiber unwoven cloth filter (long life)				
Protection device		Fuse				
Refrigerant control device		LEV				
Connectable outdoor unit		R410A CITY MULTI				
Diameter of refrigerant pipe	Liquid (R410A)	mm (in.)	ø9.52 (ø3/8) Brazed	ø9.52 (ø3/8) Brazed		
	Gas (R410A)	mm (in.)	ø19.05 (ø3/4) Brazed	ø22.2 (ø7/8) Brazed		
Field drain pipe size		mm (in.)	O.D. 32mm (1-1/4)			
Drawing	External		IU-W27-5925			
	Wiring		IU-W65-3957			
	Refrigerant cycle		-			
Standard attachment	Document		Installation Manual, Instruction Book			
	Accessory		Drain hose I.D. 32mm (1-1/4) (flexible joint)			
Remark	Optional parts					
	Long life filter		PAC-KE85LAF	PAC-KE85LAF		
	Filter box		PAC-KE250TB-F	PAC-KE250TB-F		
	Drain pump		PAC-KE04DM-F	PAC-KE04DM-F		
Installation		Details on foundation work, duct work, insulation work, electrical wiring, power source switch, and other items shall be referred to the Installation Manual.				
Note :		*1 Nominal cooling conditions	*2 Nominal cooling conditions	*3 Nominal heating conditions	Unit converter	
Indoor : 27°CDB/19°CWB (81°FDB/66°FWB)		27°CDB/19.5°CWB (81°FDB/67°FWB)	20°CDB (68°FDB)	kcal/h = kW x 860	*Above specification data is subject to rounding variation.	
Outdoor : 35°CDB (95°FDB)		35°CDB (95°FDB)	7°CDB/6°CWB (45°FDB/43°FWB)	BTU/h = kW x 3,412		
Pipe length : 7.5 m (24-9/16 ft)		5 m (16-3/8 ft)	7.5 m (24-9/16 ft)	cfm = m ³ /min x 35.31		
Level difference : 0 m (0 ft)		0 m (0 ft)	0 m (0 ft)	lbs = kg / 0.4536		
* Nominal conditions *1, *3 are subject to JIS B8615-2.						
* Due to continuing improvement, above specification may be subject to change without notice.						
*4 The values are measured at the factory setting of external static pressure.						
*5 The factory setting of external static pressure is shown without < >.						
Refer to "Fan characteristics curves", according to the external static pressure, in DATA BOOK for the usable range of air flow rate.						

1. SPECIFICATIONS

YKB/YLM

PEFY

Model			PEFY-P200VMHS-E	PEFY-P250VMHS-E		
Power source			1-phase 220-230-240V 50/60Hz	1-phase 220-230-240V 50/60Hz		
Cooling capacity (Nominal)	*1	kW	22.4	28.0		
		kcal / h	19,300	24,100		
		BTU / h	76,400	95,500		
	*2	Power input	kW	0.63	0.82	
		Current input	A	3.47 - 3.32 - 3.18 (220-230-240V)	4.72 - 4.43 - 4.14 (220-230-240V)	
Heating capacity (Nominal)	*3	kW	25.0	31.5		
		kcal / h	21,500	27,100		
		BTU / h	85,300	107,500		
	*2	Power input	kW	0.63	0.82	
		Current input	A	3.47 - 3.32 - 3.18 (220-230-240V)	4.72 - 4.43 - 4.14 (220-230-240V)	
External finish			Galvanized steel plate	Galvanized steel plate		
External dimension HxWxD			mm	470 x 1,250 x 1,120	470 x 1,250 x 1,120	
			inch	18-1/2 x 49-1/4 x 44-1/8	18-1/2 x 49-1/4 x 44-1/8	
Net weight			kg(lbs)	97(214)	100(221)	
Heat exchanger			Cross fin (Aluminum fin and copper tube)	Cross fin (Aluminum fin and copper tube)		
FAN	Type x Quantity		Sirocco fan x 2	Sirocco fan x 2		
	*4	External static press.	Pa	<50> - <100> - 150 - <200> - <250>	<50> - <100> - 150 - <200> - <250>	
			mmH ₂ O	<5.1> - <10.2> - 15.3 - <20.4> - <25.5>	<5.1> - <10.2> - 15.3 - <20.4> - <25.5>	
	Motor Type		DC motor	DC motor		
	Motor output		kW	0.870	0.870	
	Driving mechanism		Inverter-control	Inverter-control		
	Air flow rate		(Low-Mid-High)		(Low-Mid-High)	
			m ³ / min	50.0 - 61.0 - 72.0	58.0 - 71.0 - 84.0	
			L/s	833 - 1,017 - 1,200	967 - 1,183 - 1,400	
cfm		1,766 - 2,154 - 2,542	2,048 - 2,507 - 2,966			
Sound pressure level (measured in anechoic room)			(Low-Mid-High)	(Low-Mid-High)		
*2		dB <A>	36-39-43	39-42-46		
Insulation material			EPS, Polyethylene foam, Urethane foam	EPS, Polyethylene foam, Urethane foam		
Air filter			Option: Synthetic fiber unwoven cloth filter (long life filter) and filter box are recommended.	Option: Synthetic fiber unwoven cloth filter (long life filter) and filter box are recommended.		
Protection device			Fuse	Fuse		
Refrigerant control device			LEV	LEV		
Connectable outdoor unit			R410A CITY MULTI	R410A CITY MULTI		
Diameter of refrigerant pipe	Liquid (R410A)	mm(inch)	9.52(3/8")Braze	9.52(3/8")Braze		
	Gas (R410A)	mm(inch)	19.05(3/4")Braze	22.22(7/8")Braze		
Field drain pipe size			mm(inch)	O.D.32(1-1/4")	O.D.32(1-1/4")	
Drawing	External		KD94G757	KD94G757		
	Wiring		KD94G911	KD94G911		
	Refrigerant cycle		-	-		
Standard attachment	Document		Installation Manual, Instruction Book	Installation Manual, Instruction Book		
	Accessory		Insulation pipe for refrigerant pipe, Washer, Drain hose, Tie band	Insulation pipe for refrigerant pipe, Washer, Drain hose, Tie band		
Optional parts	Drain pump kit		PAC-KE05DM-F	PAC-KE05DM-F		
	Long life filter		PAC-KE85LAF	PAC-KE85LAF		
	Filter box		PAC-KE250TB-F	PAC-KE250TB-F		
Remark			* Details on foundation work, duct work, insulation work, electrical wiring, power source switch, and other items shall be referred to the Installation Manual. * Due to continuing improvement, above specifications may be subject to change without notice.			

Notes:	Unit converter
1.Nominal cooling conditions (subject to JIS B8615-2) Indoor: 27°CDB/19°CWB (81°FDB/66°FWB), Outdoor: 35°CDB (95°FDB) Pipe length: 7.5m (24-9/16"ft.), Level difference: 0m (0ft.)	kcal/h =kW x 860 BTU/h =kW x 3,412 cfm =m ³ /min x 35.31 lbs =kg/0.4536
2.The values are measured at the factory setting of external static pressure.	
3.Nominal heating conditions (subject to JIS B8615-2) Indoor: 20°CDB (68°FDB), Outdoor: 7°CDB/6°CWB (45°FDB/43°FWB) Pipe length: 7.5m (24-9/16"ft.) Level, difference: 0m(0ft.)	
4.The factory setting of external static pressure is shown without < >. Refer to "Fan characteristics curves", according to the external static pressure, in DATA BOOK for the usable range of air flow rate.	*Above specification data is subject to rounding variation.

PEFY-P20,25,32VMR-E-L/R

Unit : mm

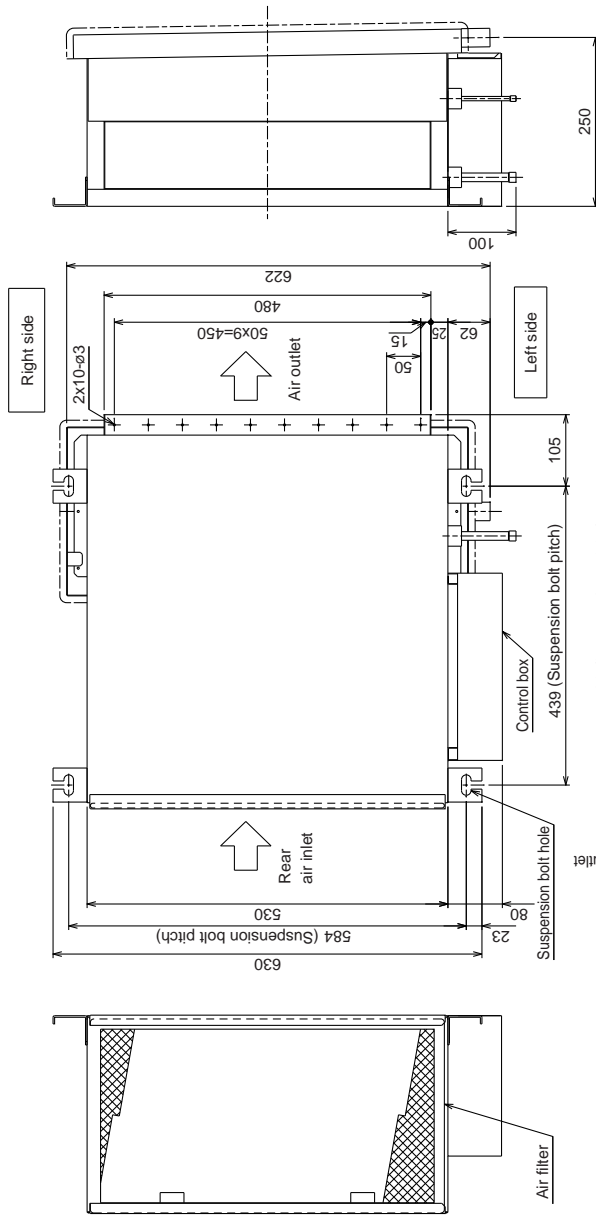

- Note 1. Use M10 screw for the suspension bolt (field supply).
 50mm or below of clearance between the indoor unit top and the end of the suspension bolt will make maintenance of the Indoor heat exchanger easier.
2. Access door of 450mmx450mm at the ceiling under the drain pan should be designed for heat exchanger cleaning and maintenance.
3. This drawing shows the left piping specification. The symmetry shows the right piping specification.
 Model name: <Left piping> PEFY-P20 · 25 · 32VMR-E-L
 <Right piping> PEFY-P20 · 25 · 32VMR-E-R
4. Period cleaning of drain pan will prevent water overflowing.
 Gradient piping design is needed for water draining.
5. The inlet direction can be changed between rear inlet and bottom inlet.
 Keep the inlet space between the ceiling and the unit in case of bottom inlet.

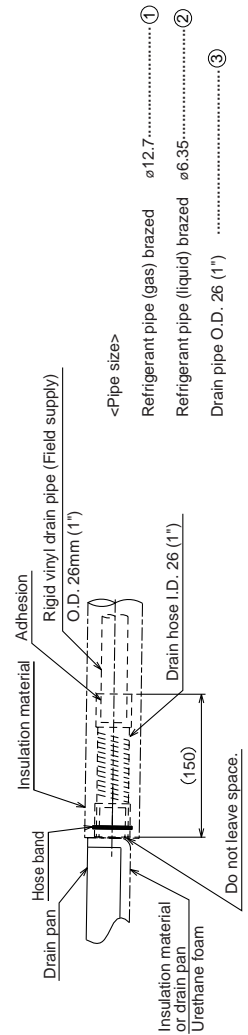
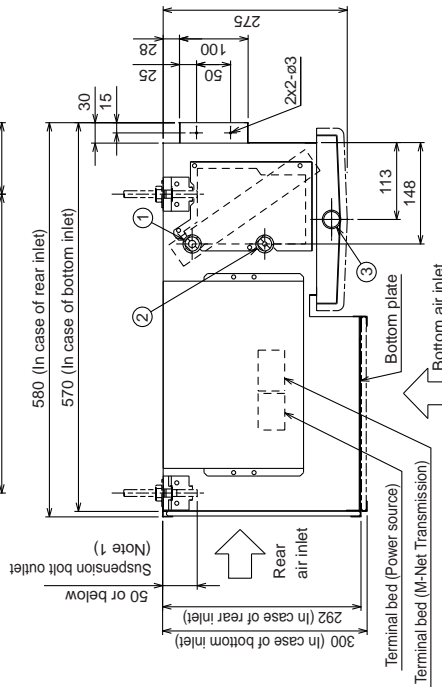

- <Pipe size>
 Refrigerant pipe (gas) brazed ø12.7.....①
 Refrigerant pipe (liquid) brazed ø6.35.....②
 Drain pipe O.D. 26 (1")③

PEFY-P15,20,25,32,40,50,63VMS1L-E

Unit : mm

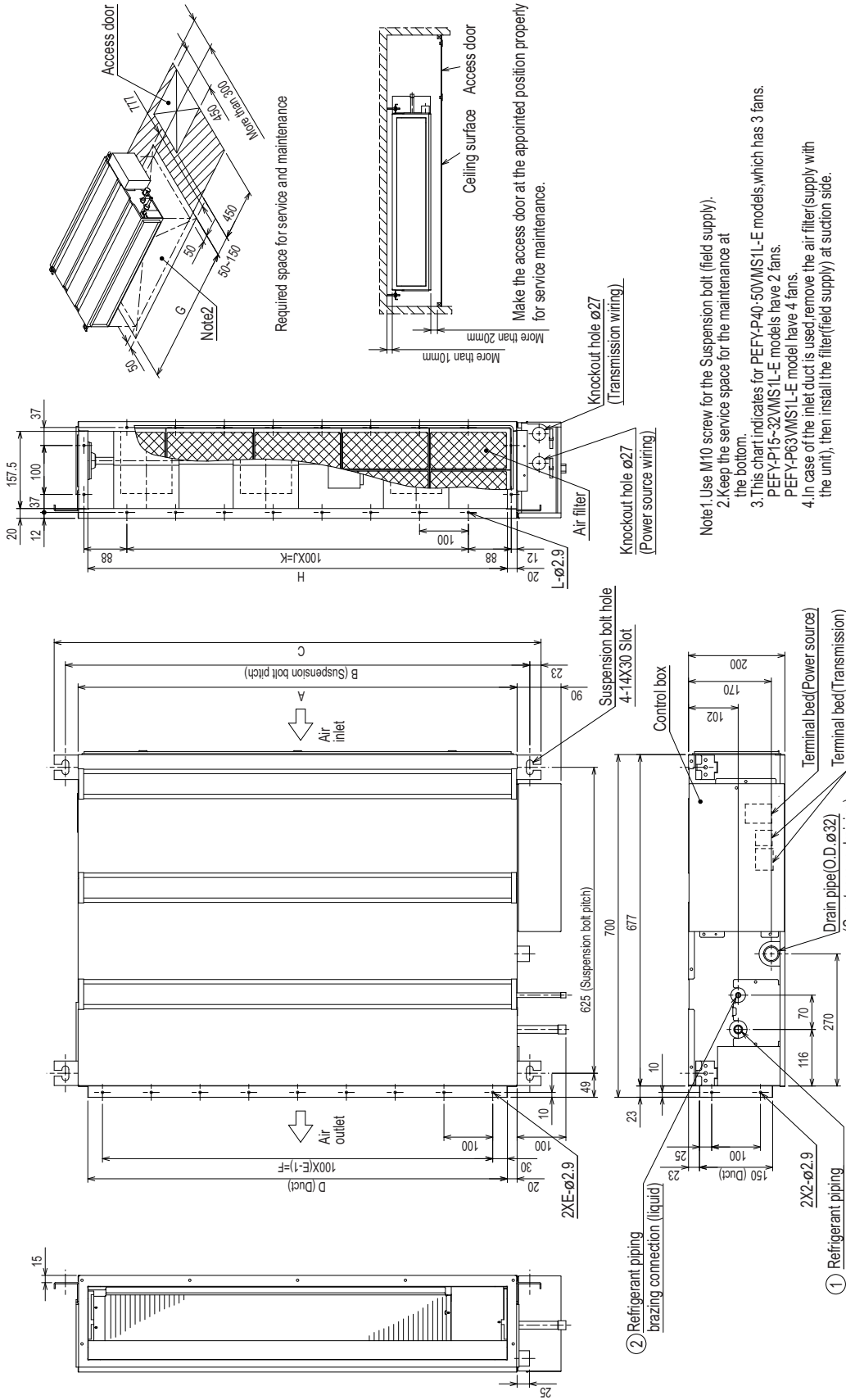

Model	A	B	C	D	E	F	G	H	J	K	L	① Gas pipe	② Liquid pipe
PEFY-P15,20,25,32VMS1L-E	700	752	798	660	7	600	800	660	5	500	16	ø12.7	ø6.35
PEFY-P40VMS1L-E	900	952	998	860	9	800	1000	860	7	700	20		
PEFY-P50VMS1L-E	1100	1152	1198	1060	11	1000	1200	1060	9	900	24	ø15.88	ø9.52

PEFY-P40, 50, 63, 71, 80, 100, 125, 140VMH-E

Unit : mm

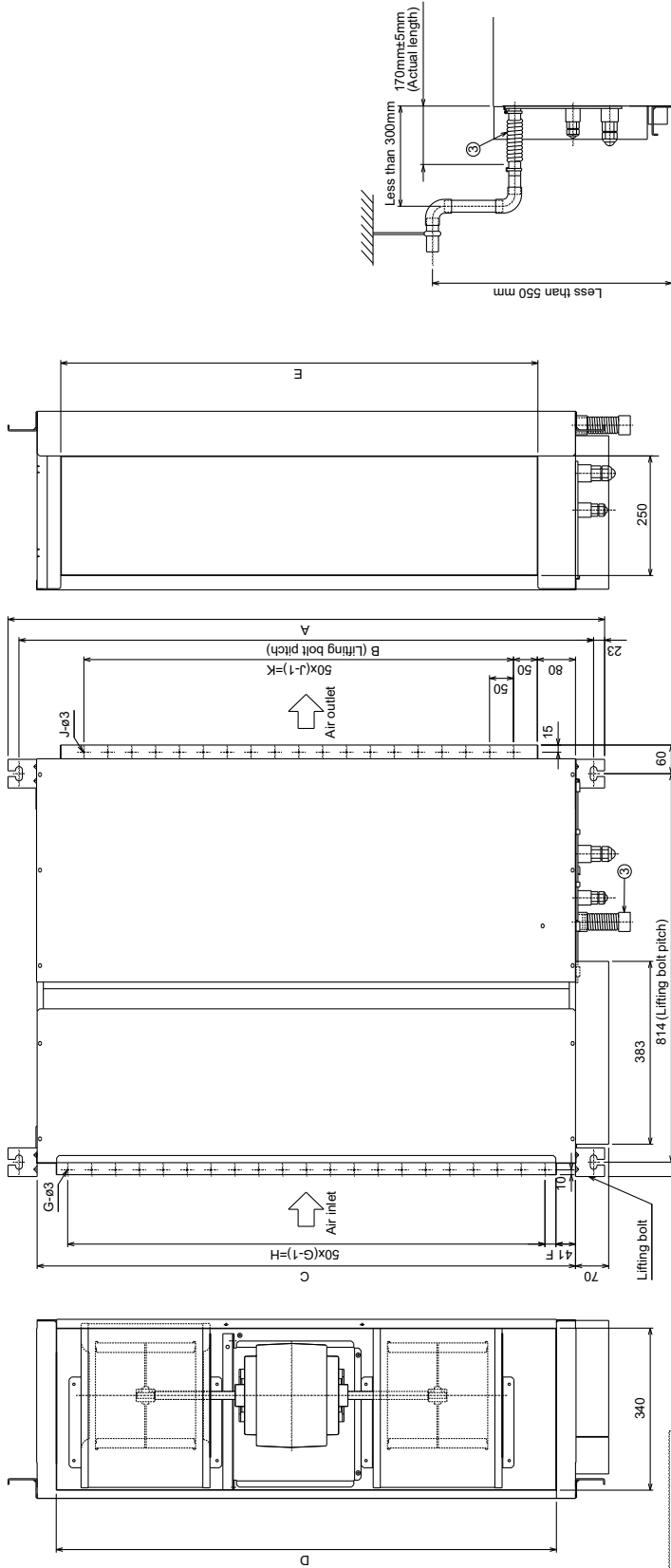

When installing the drain water lifting-up mech(option).

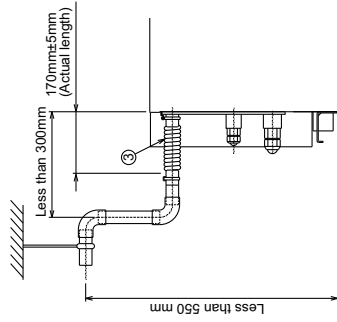

Model	A	B	C	D	E	F	G	H	J	K	L	M	N
P40VMH-E	800	754	680	600	650	50	11	500	10	450	780	ø12.7	ø6.35
P50VMH-E	800	754	680	600	650	50	11	500	10	450	780	ø12.7	ø6.35
P63VMH-E	800	754	680	600	650	50	11	500	10	450	780	ø15.88	ø9.52
P71-80VMH-E	1050	1004	930	850	800	25	17	800	15	700	1030	ø15.88	ø9.52
P100-125-140VMH-E	1250	1204	1130	1050	1000	25	21	1000	19	900	1230	ø15.88	ø9.52

- Note : 1. Use M10 screw for the lifting bolt (field supply).
 2. Keep the service space for the maintenance from the bottom when the heat exchanger is cleaned.
 3. This chart indicates for PEFY-P100-125-140VMH-E models, which have 2 fans.
 PEFY-P40-50-63-71-80 models have 1 fan.
 4. Make sure to install the air filter (field supply) on the air intake side.
 In case field supplied air filter is used, attach it where the filter service is easily done.

- Refrigerant piping flare connection (gas M copper tube) ①
 Refrigerant piping flare connection (liquid N copper tube) ②
 Drain hose I.D. 32(1-1/4") <flexible joint, 200mm> (accessory) ③

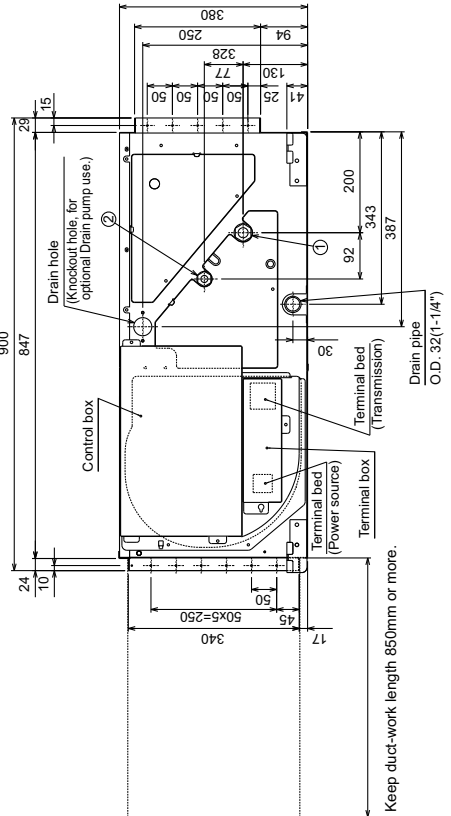

Keep duct-work length 850mm or more.

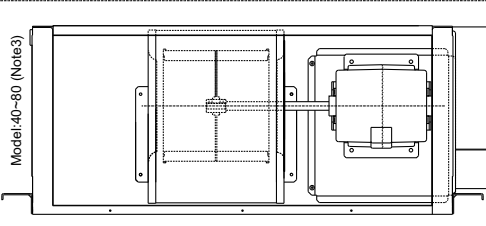

PEFY-P200, 250VMH-E

Unit : mm

- Note : 1. Use M10 screw for the lifting bolt (field supply).
 2. Keep the service space for the maintenance from the bottom when the heat exchanger is cleaned.
 3. Make sure to install the air filter (field supply) on the air intake side. In case field supplied air filter is used, attach it where the filter service is easily done.

Model	A	B
P200VMH-E	ø19.05	ø9.52
P250VMH-E	ø22.2	ø9.52

- ① Refrigerant piping brazing connection (gas A copper tube)
- ② Refrigerant piping brazing connection (liquid B copper tube)
- ③ Drain hose I.D. 32 (1-1/4") <flexible joint 200mm> (accessory)

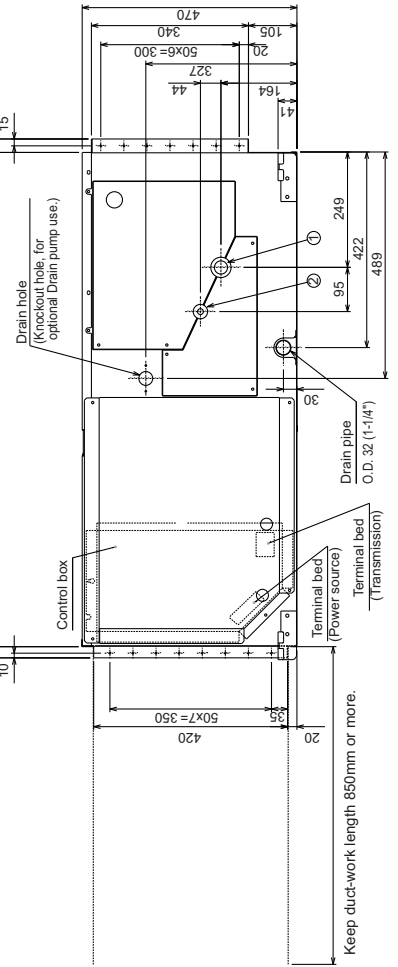
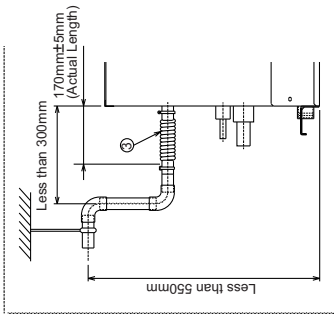
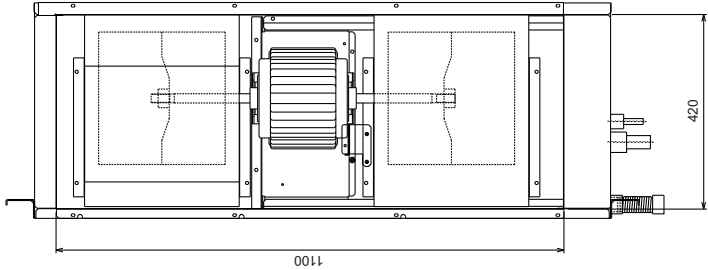
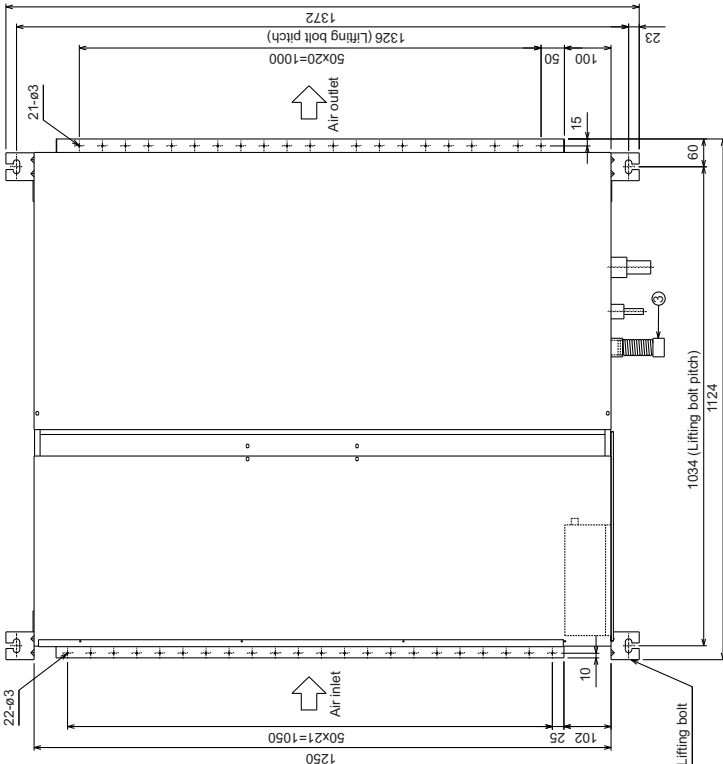
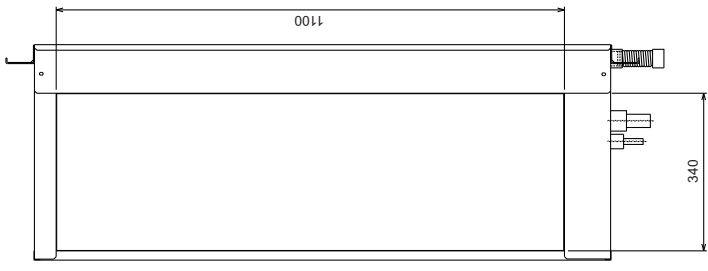

When installing the drain water lifting-up mech(option).

Keep duct-work length 850mm or more.

PEFY-P200,P250VMHS-E

Unit : mm

Required space for service and maintenance.

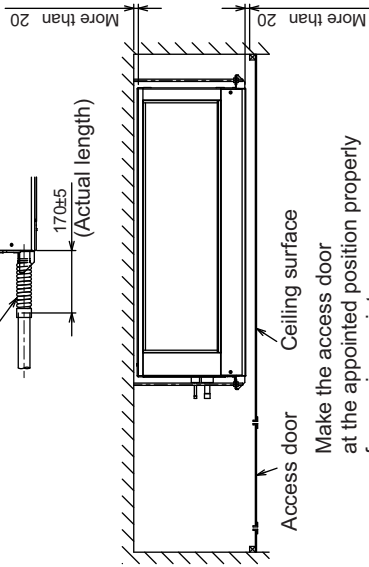
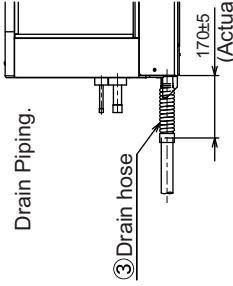
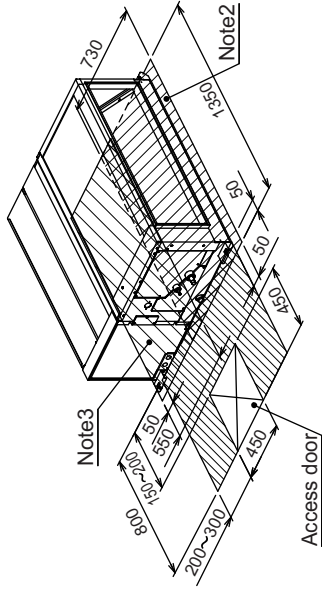

- Note 1. Use M10 screw for the suspension bolt (field supply).
2. Keep the service space for the maintenance from the bottom when the heat exchanger is cleaned.
3. Keep the service space for the maintenance from the bottom when the fan motor is changed.
4. Make sure to install the air filter (field supply) on the air intake side. In case field supplied air filter is used, attach it where the filter service is easily done.

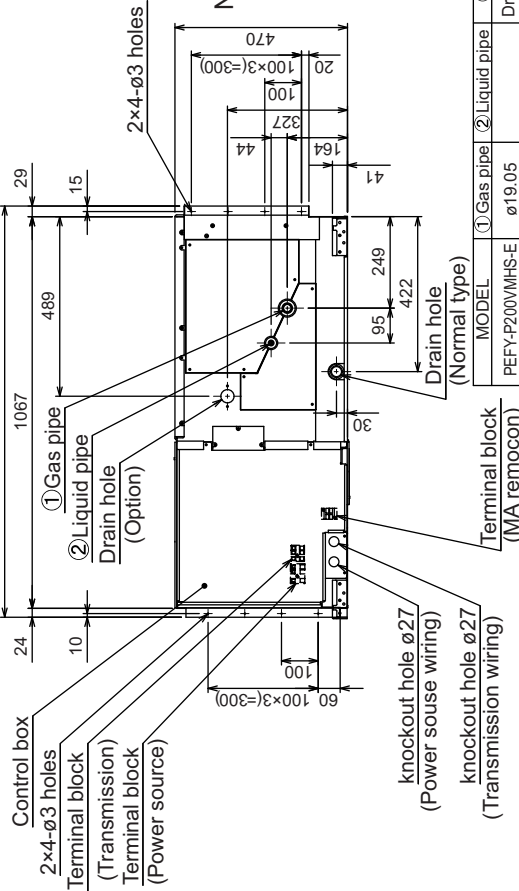
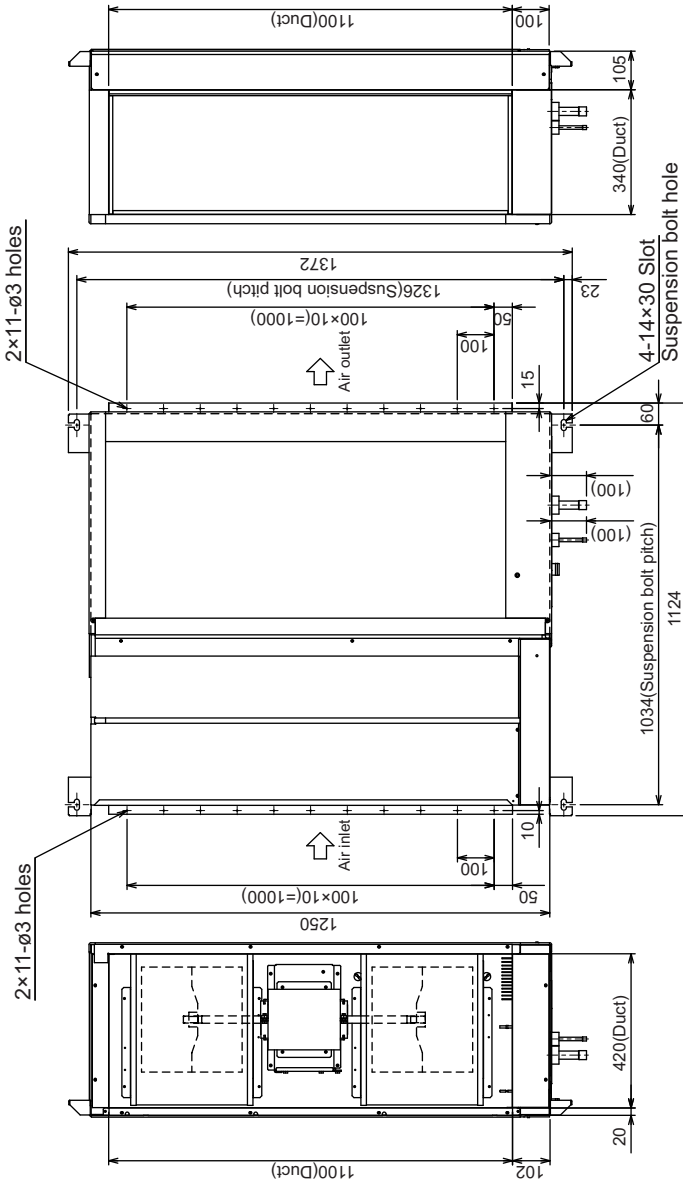

MODEL	① Gas pipe φ19.05	② Liquid pipe φ9.52	③ Drain hose Drain hose 32mm <flexible joint> <accessory>
PEFY-P200VMHS-E			
PEFY-P250VMHS-E	φ22.2		

PEFY-P20, 25, 32VMR-E/L/R

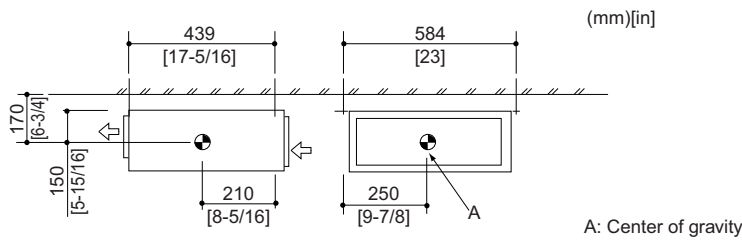

PEFY-P15,20,25,32,40,50,63VMS1(L)-E

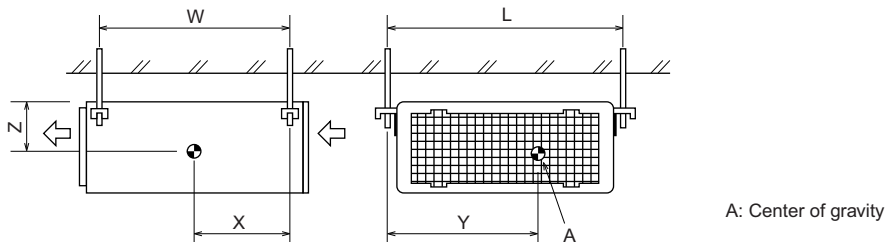

(mm)[in]

Model name	W	L	X	Y	Z
PEFY-P15VMS1(L)-E	625 [24-5/8]	752 [29-5/8]	263 [10-3/8]	338 [13-5/8]	105 [4-5/32]
PEFY-P20VMS1(L)-E	625 [24-5/8]	752 [29-5/8]	263 [10-3/8]	338 [13-5/16]	105 [4-5/32]
PEFY-P25VMS1(L)-E	625 [24-5/8]	752 [29-5/8]	263 [10-3/8]	338 [13-5/16]	105 [4-5/32]
PEFY-P32VMS1(L)-E	625 [24-5/8]	752 [29-5/8]	275 [10-27/32]	340 [13-13/32]	104 [4-1/8]
PEFY-P40VMS1(L)-E	625 [24-5/8]	952 [37-1/2]	280 [11-1/32]	422 [16-5/8]	104 [4-1/8]
PEFY-P50VMS1(L)-E	625 [24-5/8]	952 [37-1/2]	280 [11-1/32]	422 [16-5/8]	104 [4-1/8]
PEFY-P63VMS1(L)-E	625 [24-5/8]	1152 [45-3/8]	285 [11-1/4]	511 [20-1/8]	104 [4-1/8]

PEFY-P40,50,63,71,80,100,125,140,200,250VMH(S)-E

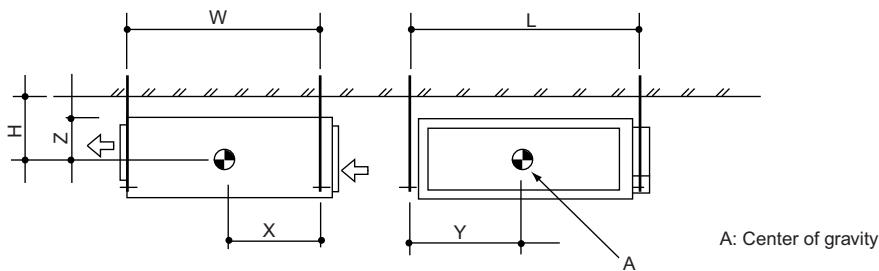

(mm)[in]

Model name	W	L	H	X	Y	Z
PEFY-P40VMH-E	814 [32-1/16]	754 [29-11/16]	210 [8-9/32]	374 [14-3/4]	440 [17-11/32]	190 [7-1/2]
PEFY-P50VMH-E	814 [32-1/16]	754 [29-11/16]	210 [8-9/32]	374 [14-3/4]	440 [17-11/32]	190 [7-1/2]
PEFY-P63VMH-E	814 [32-1/16]	754 [29-11/16]	210 [8-9/32]	374 [14-3/4]	440 [17-11/32]	190 [7-1/2]
PEFY-P71VMH-E	814 [32-1/16]	1004 [39-17/32]	210 [8-9/32]	394 [15-17/32]	584 [22-32/32]	190 [7-1/2]
PEFY-P80VMH-E	814 [32-1/16]	1004 [39-17/32]	210 [8-9/32]	394 [15-17/32]	584 [22-32/32]	190 [7-1/2]
PEFY-P100VMH-E	814 [32-1/16]	1204 [47-13/32]	210 [8-9/32]	364 [14-11/32]	649 [25-9/16]	190 [7-1/2]
PEFY-P125VMH-E	814 [32-1/16]	1204 [47-13/32]	210 [8-9/32]	364 [14-11/32]	649 [25-9/16]	190 [7-1/2]
PEFY-P140VMH-E	814 [32-1/16]	1204 [47-13/32]	210 [8-9/32]	364 [14-11/32]	649 [25-9/16]	190 [7-1/2]
PEFY-P200VMH(S)-E	1034 [40-23/32]	1326 [52-7/32]	255 [10-1/16]	462 [18-7/32]	660 [25-32/32]	235 [9-9/32]
PEFY-P250VMH(S)-E	1034 [40-23/32]	1326 [52-7/32]	255 [10-1/16]	462 [18-7/32]	660 [25-32/32]	235 [9-9/32]

PEFY-P20,25,32VMR-E-L/R

INSIDE SECTION OF CONTROL BOX

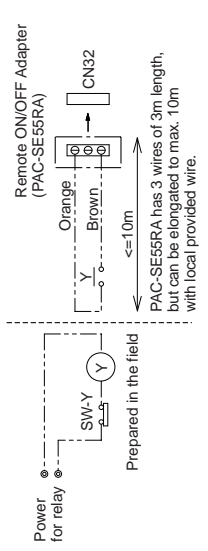
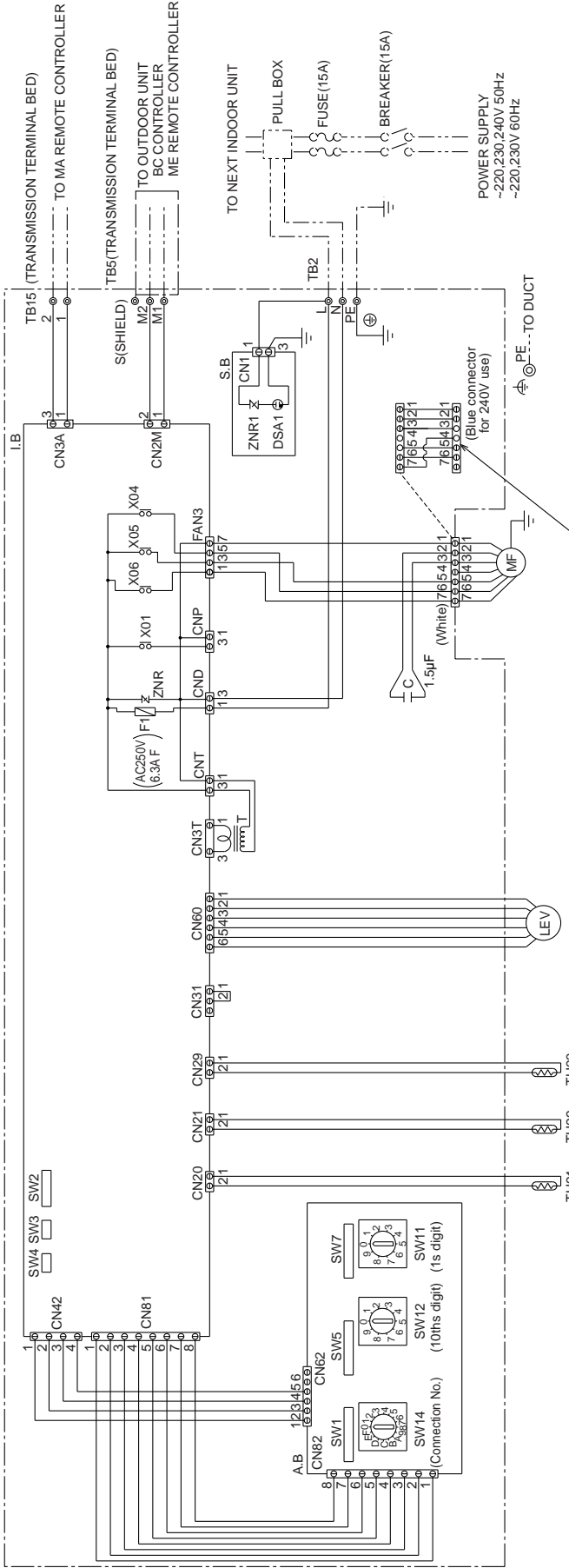

At factory shipment, the motor connector is connected for 220/230V power. If 240V power is used, insert the attached Blue connector between the Motor connector and White connector from indoor board.
 Connector color: for power source
 White: 220V/230V
 Blue: 240V

SW-Y	Status	Display and operation at Local Remote Controller
OFF	Obey to local remote controller (Allowed)	Operation permitted
ON	Remote - OFF	"Central control" displayed. Local Remote Controller operation prohibited (not functioning).

Y: Aux. relay (Load >= 12VDC 1mA)

NOTE:1. The wirings to TB2, TB5 shown in dotted line are field work.
 2. Mark ⊕ indicates terminal bed, ⊖ connector, ⊕ board insertion connector or fastening connector of control board.

SYMBOL EXPLANATION

SYMBOL	NAME	SYMBOL	NAME
MF	Fan motor	TH21	Thermistor (inlet temp. detection)
C	Capacitor (for MF) 1.5µF	TH22	Thermistor (piping temp. detection/liquid)
I.B	Indoor controller board	TH23	Thermistor (piping temp. detection/gas)
A.B	Address board	SW1(A,B)	Switch (1s digit address set)
TB2	Power source terminal bed	SW2(A,B)	Switch (10ths digit address set)
TB5	Transmission terminal bed	SW4(A,B)	Switch (connection No. set)
F1	Fuse AC250V 6.3A F	SW2(LB)	Switch (for mode selection)
T	Transformer	SW3(LB)	Switch (for mode selection)
LEV	Electronic linear expan. valve	SW4(LB)	Switch (for model selection)
S.B	Surge absorber board	SW5(A,B)	Switch (for voltage selection)
X04-X06	Aux. relay	SW7(A,B)	Switch (for mode selection)

PEFY-P15,20,25,32,40,50,63VMS1(L)-E

INSIDE SECTION OF CONTROL BOX

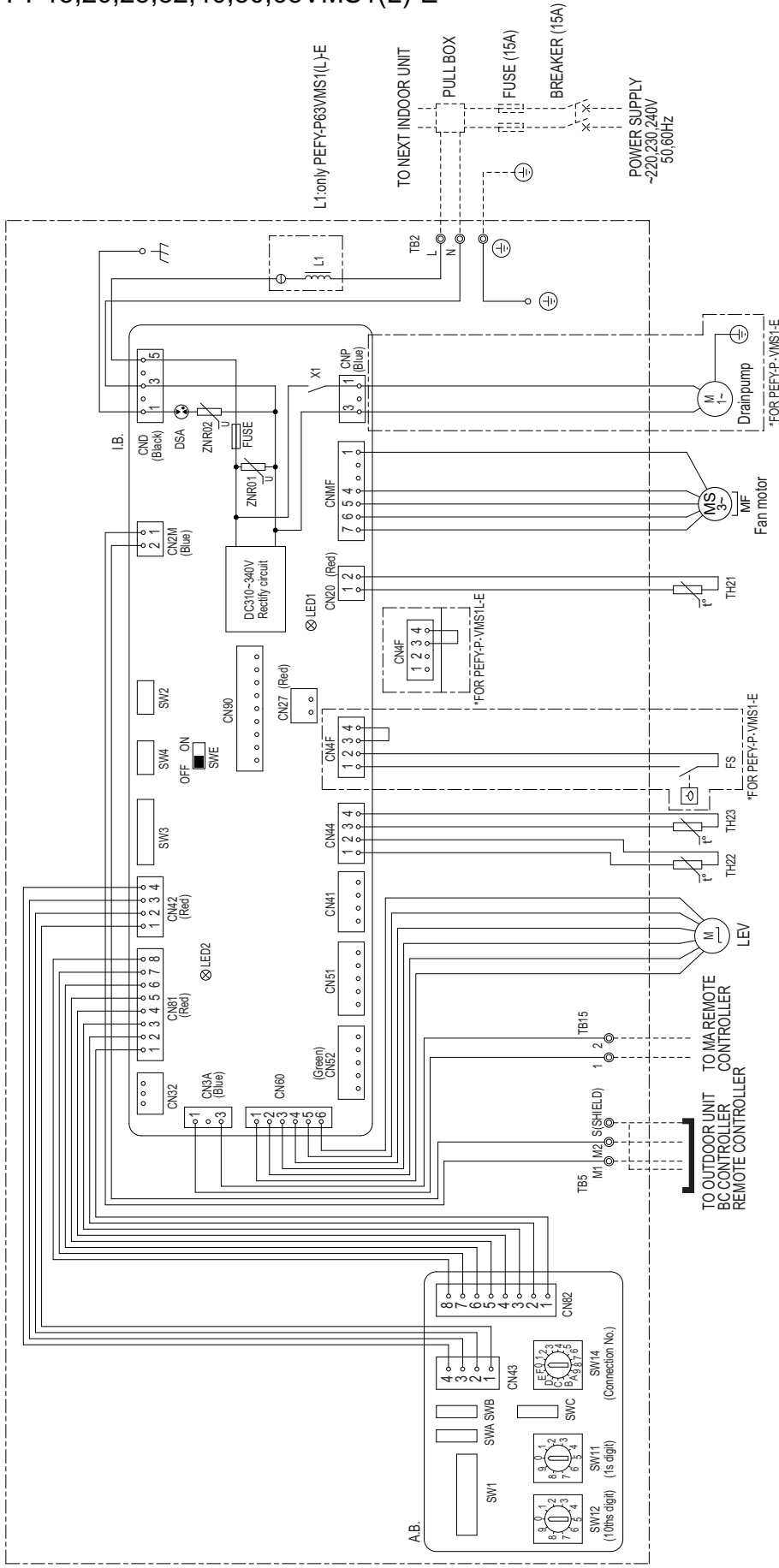

NOTE: 1. The wirings to TB2, TB5, TB15 shown in dotted line are field work.
 2. Mark ⊙ indicates terminal bed, ⊕ connector.

SYMBOL EXPLANATION

SYMBOL	NAME	SYMBOL	NAME	SYMBOL	NAME
IB.	Indoor controller board	CN32	Connector (Remote switch)	SW4(I.B.)	Switch (for model selection)
A.B.	Address board	CN41	Connector (HA terminal-A)	SWE(I.B.)	Connector (emergency operation)
TB5	Power source terminal bed	CN51	Connector (Centrally control)	SW1(A.B.)	Switch (for mode selection)
TB15	Transmission terminal bed	CN52	Connector (Remote indication)	SW11(A.B.)	Switch (1s digit address set)
FUSE	Fuse AC250V 6.3A	CN90	Connector (Wireless)	SW12(A.B.)	Switch (10hrs digit address set)
ZNR01,02	Varistor	FS	Float switch	SW14(A.B.)	Switch (connection No. set)
DSA	Arrester	TH21	Thermistor (inlet air temp. detection)	SWA(A.B.)	Switch (for static pressure selection)
X1	Aux. relay	TH22	Thermistor (piping temp. detection/liquid)	SWB(A.B.)	Switch (for model selection)
L1	AC reactor (Power factor improvement)	TH23	Thermistor (piping temp. detection/gas)	SWC(A.B.)	Switch (for static pressure selection)
CN27	Connector (Damper)	SW2(I.B.)	Switch (for capacity code)		
		SW3(I.B.)	Switch (for mode selection)		

PEFY-P40,50,63,71,80,100,125,140VMH-E

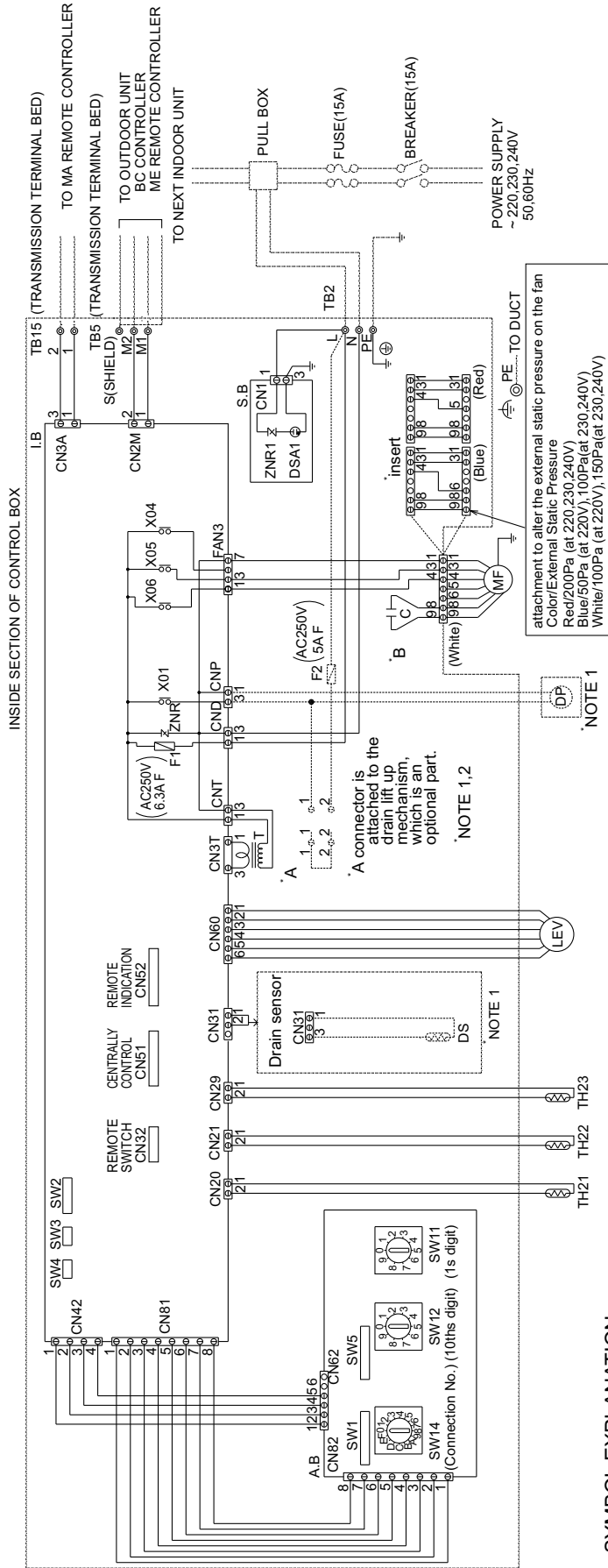

NOTE 1: The part of the broken line indicates the circuit for optional parts.

NOTE 2: A in the chart is the connector for a drain pump test run operation.
 (The Drain Pump operates continuously if the connector is inserted and the power is supplied.)
 After the test run, make sure to remove the 'A' connector.

NOTE 3: The wirings to TB2, TB5 (shown in dotted line) are field work.

NOTE 4: Mark ⊕ indicates terminal bed, ⊖ connector, ⊕ board insertion connector or fastening connector of control board.

Capacitor
 MODELS 40/50 3.0μF
 MODEL 63 4.0μF
 MODELS 71/80 5.0μF
 MODELS 100/125/140 7.0μF

SYMBOL EXPLANATION

SYMBOL	NAME	SYMBOL	NAME
MF	Fan motor	S.B	Surge absorber board
C	Capacitor (for MF)	TH21	Thermistor (inlet temp.detection)
I.B	Indoor controller board	TH22	Thermistor (piping temp.detection/liquid)
A.B	Address board	TH23	Thermistor (piping temp.detection/gas)
TB2	Power source terminal bed	SW1(A,B)	Switch (1s digit address set)
TB5	Transmission terminal bed	SW12(A,B)	Switch (10ths digit address set)
F1	Fuse AC250V 6.3A F	SW14(A,B)	Switch (connection No.set)
<F2>	Fuse AC250V 5A F	SW1(A,B)	Switch(for mode selection)
T	Transformer	SW2(I,B)	Switch(for capacity code)
<DP>	Drain Pump	SW3(I,B)	Switch(for mode selection)
LEV	Electronic linear expan. valve	SW4(I,B)	Switch(for model selection)
<DS>	Drain sensor	SW5(A,B)	Switch(for voltage selection)
		X04-X06	Aux.relay

inside < > is the optional parts

PEFY-P200,250VMH-E

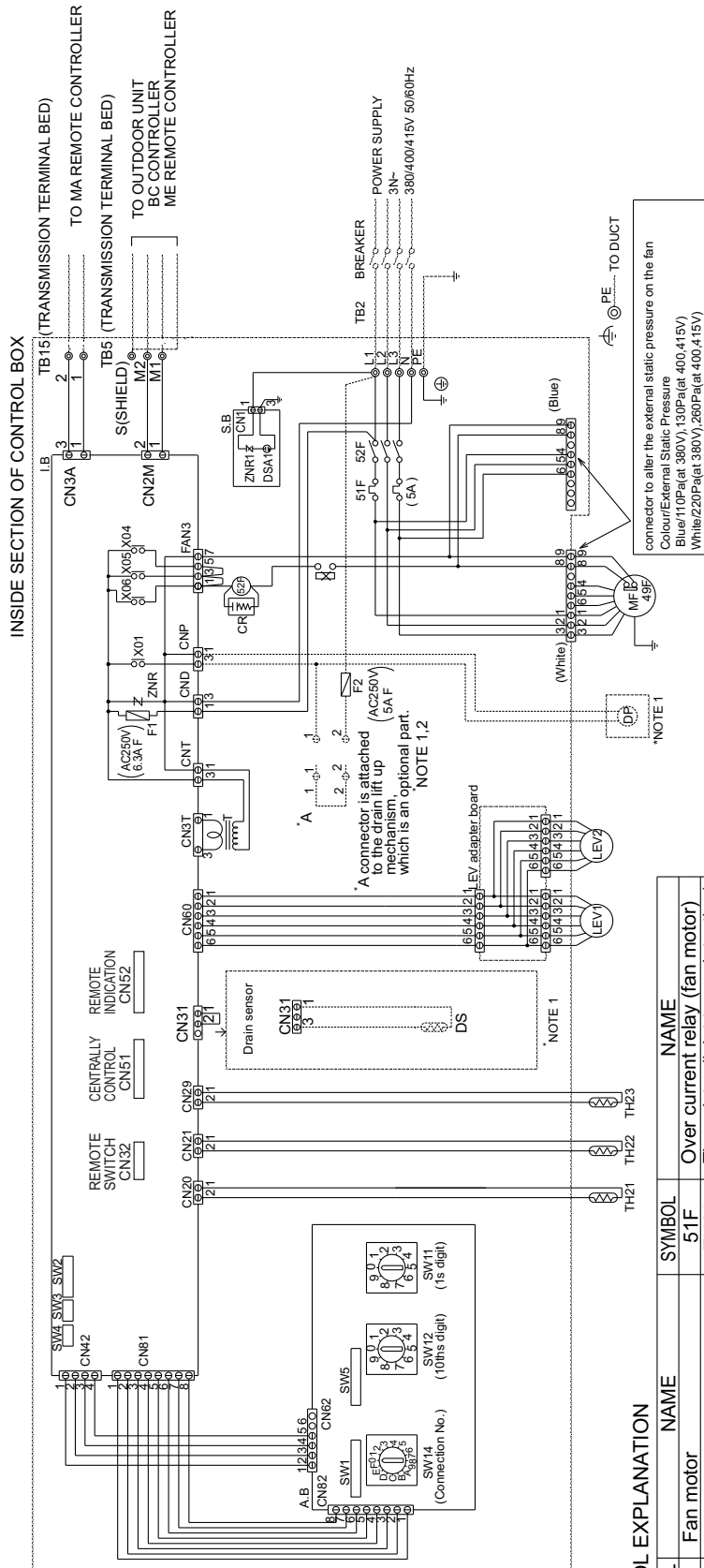

SYMBOL EXPLANATION

SYMBOL	NAME	SYMBOL	NAME
MF	Fan motor	51F	Over current relay (fan motor)
I.B	Indoor controller board	TH21	Thermistor (inlet temp. detection)
A.B	Address board	TH22	Thermistor (piping temp. detection/liquid)
TB2	Power source terminal bed	TH23	Thermistor (piping temp. detection/gas)
TB5	Transmission terminal bed	SW11(A,B)	Switch (1s digit address set)
TB15	Transmission terminal bed	SW12(A,B)	Switch (10ths digit address set)
F1	Fuse AC250V 6.3A F	SW14(A,B)	Switch (connection No. set)
<F2>	Fuse AC250V 5A F	SW1(A,B)	Switch (for mode selection)
T	Transformer	SW2(LB)	Switch (for capacity code)
<DP>	Drain Pump	SW3(LB)	Switch (for mode selection)
LEV1,LEV2	Electronic linear expan. valve	SW4(LB)	Switch (for mode selection)
<DS>	Drain sensor	SW5(A,B)	Switch (for voltage selection)
S.B	Surge absorber board	X04-X06	Aux. relay
52F	Contactors (fan motor)	49F	Inner thermostat

inside < > is the optional parts

PEFY-P200,P250VMHS-E

SYMBOL	EXPLANATION	NAME
I.B.	Indoor controller board	
CN25	Connector	
CN32	Connector (Remote switch)	
CN41	Connector (HA terminal-A)	
CN90	Connector (Wireless)	
SW1	Switch (for mode selection)	
SW2	Switch (for capacity code)	
SW3	Switch (for mode selection)	
SW4	Switch (for model selection)	
SW5	Switch (for mode selection)	
SW11	Switch (10ths digit address set)	
SW12	Switch (10ths digit address set)	
SW14	Switch (BRANCH No.)	
SWA	Switch (for static pressure selection)	
SWC	Switch (for static pressure selection)	
SWE	Connector (emergency operation)	
NF.B.	Noise filter board	
DSA001	Arrester	
ZNR01~	Varistor	
ZNR03		
X010,X100	Aux. relay	
F001	Fuse(AC250V 10A)	
F100	Fuse(3.15A)	
NF	Noise filter	
P.B.	Power supply board	
INV.B.	Inverter board	
IPM	Intelligent power module	
F01	Fuse(AC250V 15A)	
TB2	Power source terminal block	
TB5	Transmission terminal block	
TB15	Transmission terminal block	
TH21	Thermistor(inlet air temp.detection)	
TH22	Thermistor(piping temp.detection/liquid)	
TH23	Thermistor(piping temp.detection/gas)	
THHS	Thermistor(heatsink)	
MF	Fan motor	
LEV1,LEV2	Electronic linear expansion valve	
ACL	AC reactor (Power factor improvement)	
R	Resistor	
DB01	Diode bridge	
ACCT	Current Sensor (AC)	
LED1	LED (Power supply)	
LED2	LED (Remote controller supply)	
<DP>	Drain pump	
<FS>	Float switch	
	Inside <	>is the optional parts.

INSIDE SECTION OF CONTROL BOX

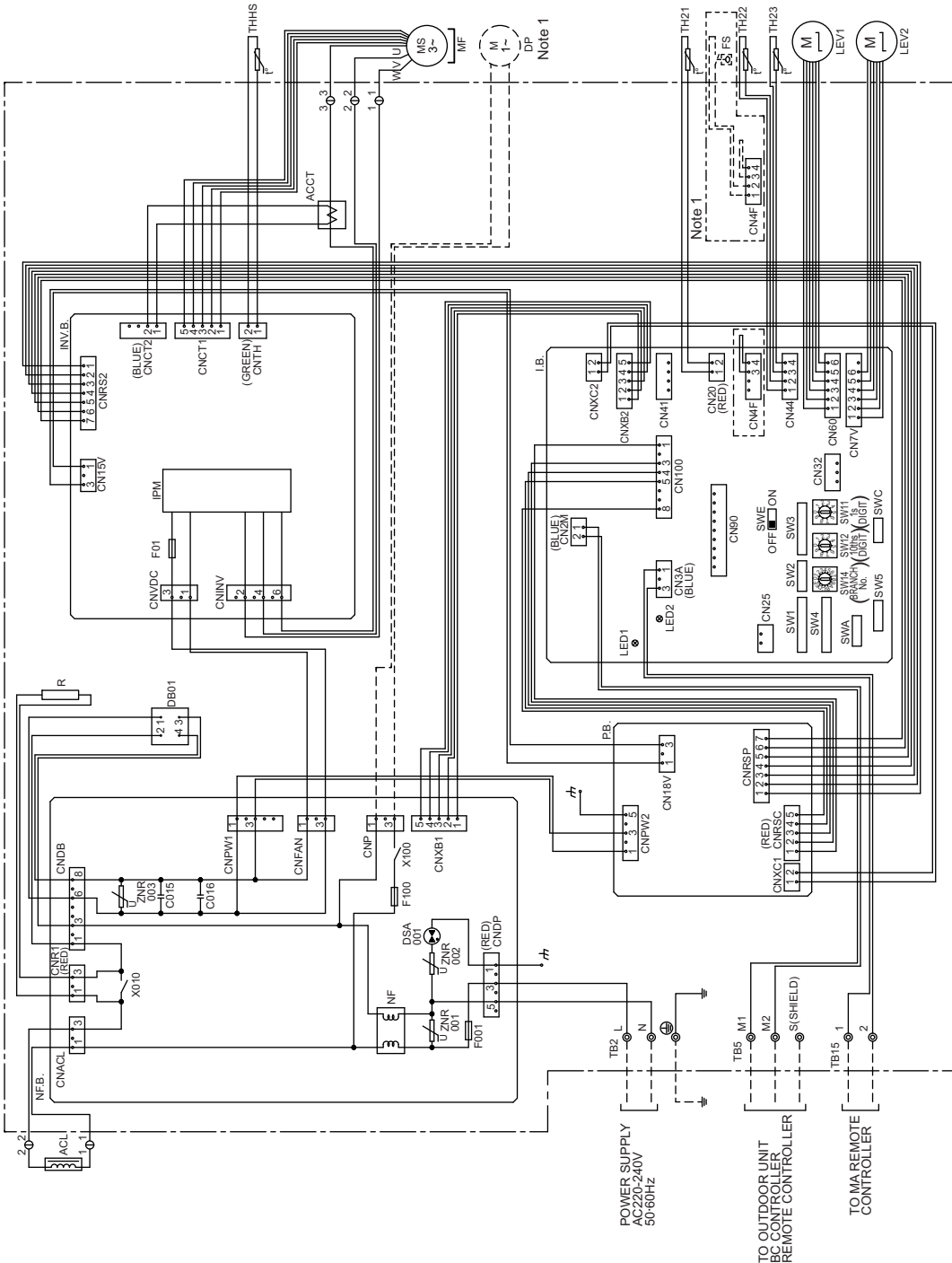

NOTE:1 The part of thin dotted line indicates the circuit for optional parts.
 2. To perform a drainage test for the drain pump turn on the SWE on the control board while the indoor unit is being powered.
 *Be sure to turn off the SWE after completing a drainage test or test run.
 3. The wirings to TB2, TB5, TB15 shown in dotted line are field work.
 4. Mark Ⓞ indicates terminal block, ⊕ connector.

5-1. Sound levels

PEFY-P-VMR-E-L/R, VMS1(L)-E, VMH(S)-E

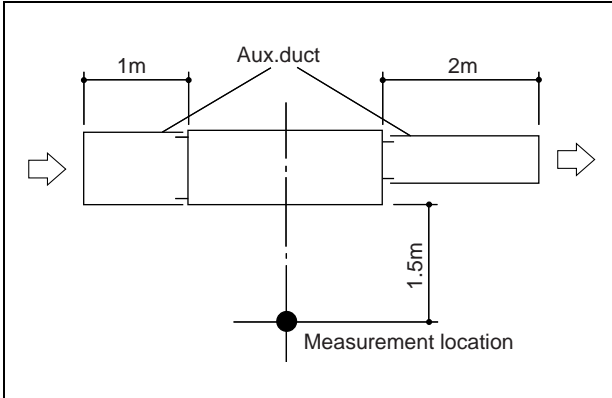

* Measured in anechoic room.

Sound level at anechoic room: Low-Mid-High

		Sound level dB (A)		
PEFY-P20VMR-E-L/R	220V	20 - 25 - 30		
	230V	21 - 26 - 32		
	240V	22 - 27 - 30		
PEFY-P25VMR-E-L/R	220V	20 - 25 - 30		
	230V	21 - 26 - 32		
	240V	22 - 27 - 30		
PEFY-P32VMR-E-L/R	220V	20 - 25 - 33		
	230V	21 - 26 - 35		
	240V	22 - 27 - 33		

Sound level at anechoic room: Low-Mid-High

		Sound level dB (A)				
		5Pa	15Pa	35Pa	50Pa	
PEFY-P15VMS1(L)-E	220-240V	22 - 24 - 26	22 - 24 - 28	23 - 26 - 29	23 - 27 - 30	
PEFY-P20VMS1(L)-E	220-240V	22 - 25 - 28	23 - 25 - 29	24 - 27 - 30	25 - 28 - 32	
PEFY-P25VMS1(L)-E	220-240V	22 - 25 - 29	23 - 26 - 30	24 - 28 - 31	25 - 29 - 33	
PEFY-P32VMS1(L)-E	220-240V	23 - 27 - 30	23 - 27 - 32	24 - 28 - 33	25 - 29 - 34	
PEFY-P40VMS1(L)-E	220-240V	26 - 28 - 30	28 - 30 - 33	30 - 32 - 35	31 - 33 - 36	
PEFY-P50VMS1(L)-E	220-240V	29 - 31 - 34	30 - 32 - 35	31 - 34 - 37	32 - 34 - 38	
PEFY-P63VMS1(L)-E	220-240V	29 - 32 - 35	30 - 33 - 36	31 - 35 - 39	32 - 36 - 40	

Sound level at anechoic room: Low-High

		Sound level dB (A)		
		Low*	Mid*	High*
PEFY-P40VMH-E	220V	25 - 30	27 - 34	30 - 40
PEFY-P50VMH-E	230,240V	30 - 34	31 - 37	31 - 41
PEFY-P63VMH-E	220V	31 - 36	32 - 38	36 - 43
	230,240V	35 - 39	36 - 41	38 - 44
PEFY-P71VMH-E	220V	30 - 36	32 - 39	35 - 43
	230,240V	34 - 39	35 - 41	37 - 44
PEFY-P80VMH-E	220V	32 - 39	35 - 41	37 - 43
	230,240V	37 - 41	38 - 43	39 - 45
PEFY-P100,125VMH-E	220V	32 - 40	34 - 42	36 - 46
PEFY-P140VMH-E	230,240V	36 - 42	38 - 44	38 - 47
PEFY-P200VMH-E	380V	42	-	45
	400,415V	44	-	47
PEFY-P250VMH-E	380V	50	-	52
	400,415V	52	-	54

* External static pressure of PEFY-P40-140VMH-E
 Low: 50Pa at 220V, 100Pa at 230, 240V
 Mid: 100Pa at 220V, 150Pa at 230, 240V
 High: 200Pa at 220V, 200Pa at 230, 240V
 * External static pressure of PEFY-P200-250VMH-E
 Low: 110Pa at 380V, 130Pa at 400, 415V
 High: 220Pa at 380V, 260Pa at 400, 415V

Sound level at anechoic room: Low-Mid-High

		Sound level dB (A)				
		50Pa	100Pa	150Pa	200Pa	250Pa
PEFY-P200VMHS-E	220-240V	32 - 35 - 39	34 - 37 - 41	36 - 39 - 43	38 - 41 - 45	40 - 43 - 47
PEFY-P250VMHS-E	220-240V	35 - 38 - 42	37 - 40 - 44	39 - 42 - 46	41 - 44 - 48	43 - 46 - 50

5-2. NC curves

PEFY-P20,25VMR-E-L/R

External static pressure : 5Pa
Power source : 220V, 50/60Hz

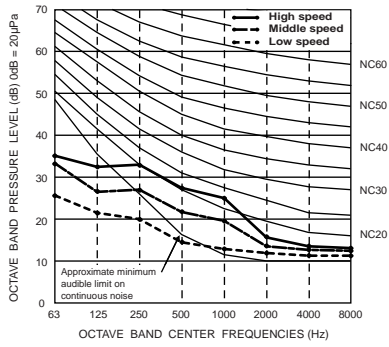

PEFY-P20,25VMR-E-L/R

External static pressure : 5Pa
Power source : 230V, 50/60Hz

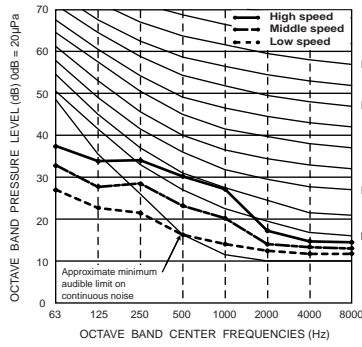

PEFY-P20,25VMR-E-L/R

External static pressure : 5Pa
Power source : 240V, 50Hz

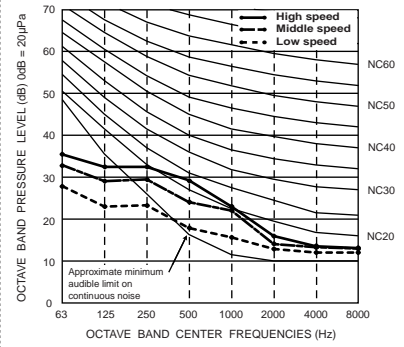

PEFY-P32VMR-E-L/R

External static pressure : 5Pa
Power source : 220V, 50/60Hz

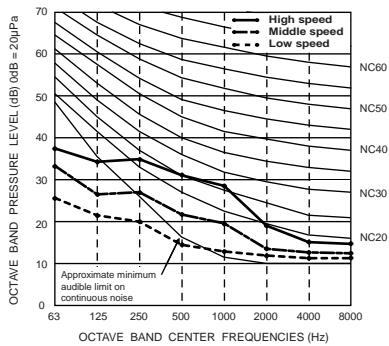

PEFY-P32VMR-E-L/R

External static pressure : 5Pa
Power source : 230V, 50/60Hz

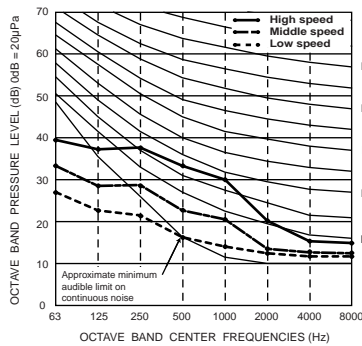

PEFY-P32VMR-E-L/R

External static pressure : 5Pa
Power source : 240V, 50Hz

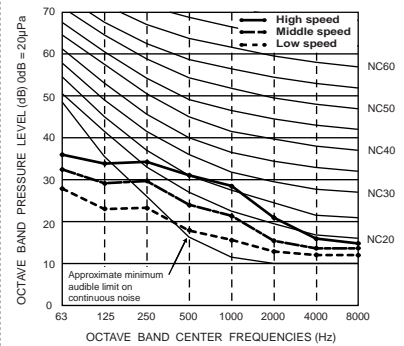

PEFY-P15VMS1(L)-E
 External static pressure : 5Pa
 Power source : 220,230,240V, 50/60Hz

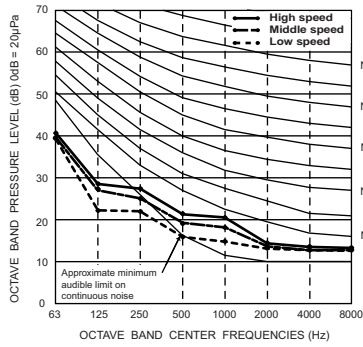

PEFY-P15VMS1(L)-E
 External static pressure : 15Pa
 Power source : 220,230,240V, 50/60Hz

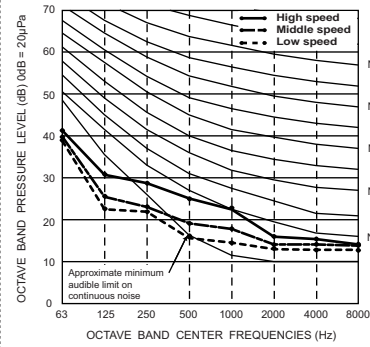

PEFY-P15VMS1(L)-E
 External static pressure : 35Pa
 Power source : 220,230,240V, 50/60Hz

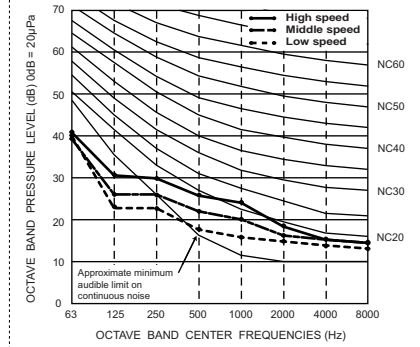

PEFY-P15VMS1(L)-E
 External static pressure : 50Pa
 Power source : 220,230,240V, 50/60Hz

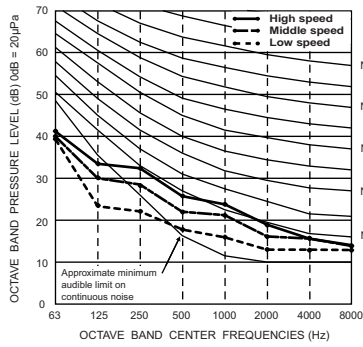

PEFY-P20VMS1(L)-E
 External static pressure : 5Pa
 Power source : 220,230,240V, 50/60Hz

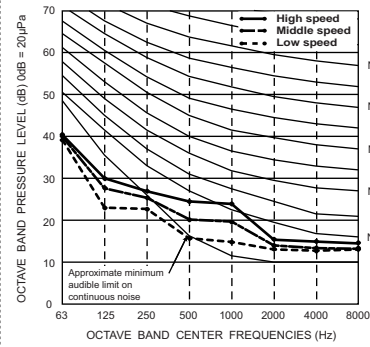

PEFY-P20VMS1(L)-E
 External static pressure : 15Pa
 Power source : 220,230,240V, 50/60Hz

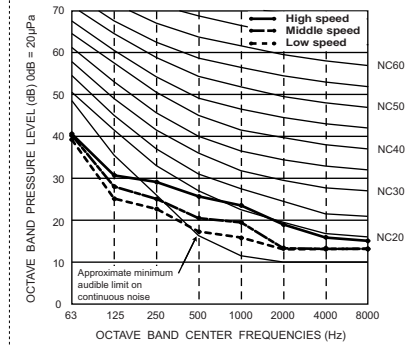

PEFY-P20VMS1(L)-E
 External static pressure : 35Pa
 Power source : 220,230,240V, 50/60Hz

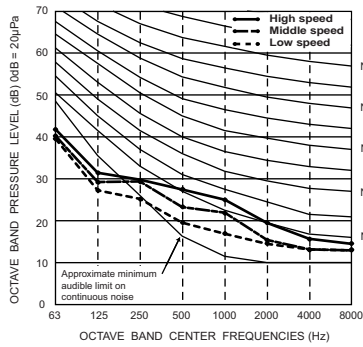

PEFY-P20VMS1(L)-E
 External static pressure : 50Pa
 Power source : 220,230,240V, 50/60Hz

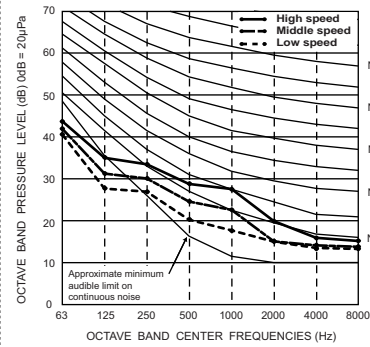

PEFY-P25VMS1(L)-E
 External static pressure : 5Pa
 Power source : 220,230,240V, 50/60Hz

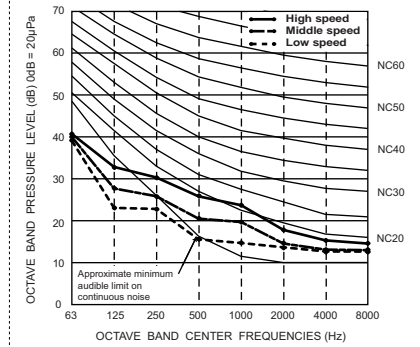

PEFY-P25VMS1(L)-E
 External static pressure : 15Pa
 Power source : 220,230,240V, 50/60Hz

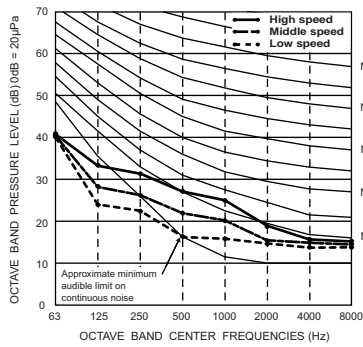

PEFY-P25VMS1(L)-E
 External static pressure : 35Pa
 Power source : 220,230,240V, 50/60Hz

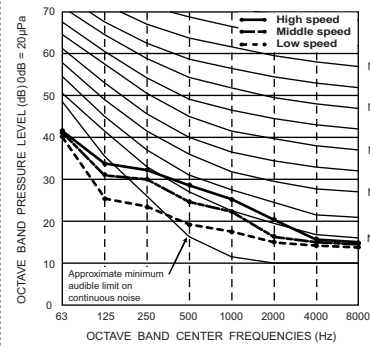

PEFY-P25VMS1(L)-E
 External static pressure : 50Pa
 Power source : 220,230,240V, 50/60Hz

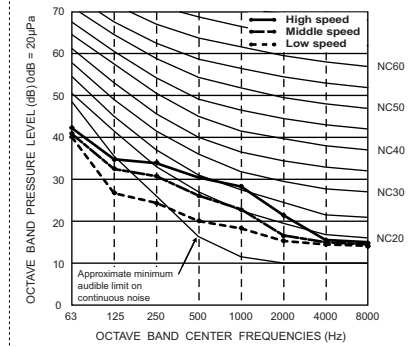

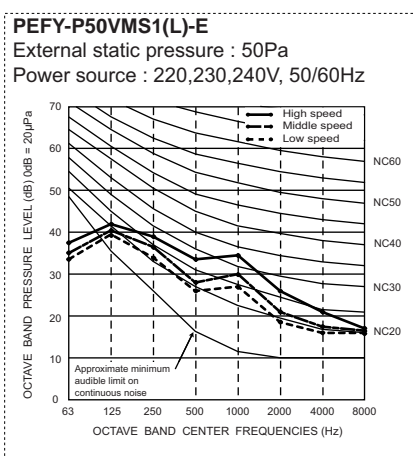
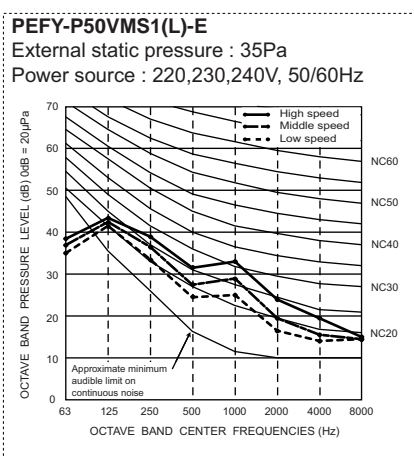
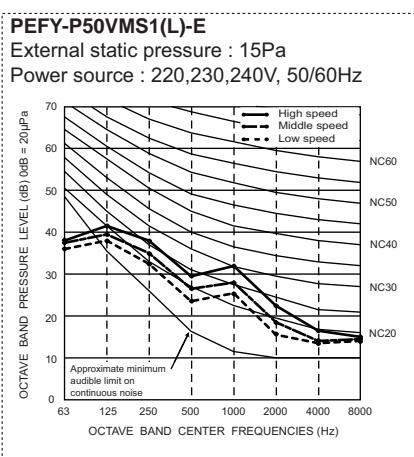
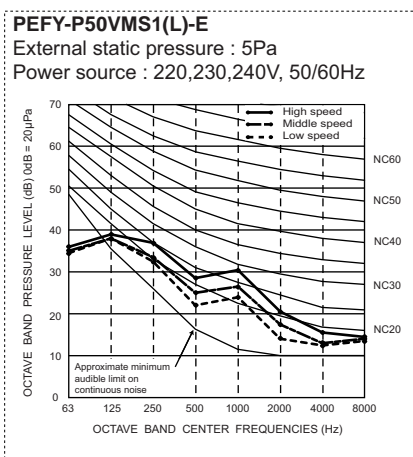
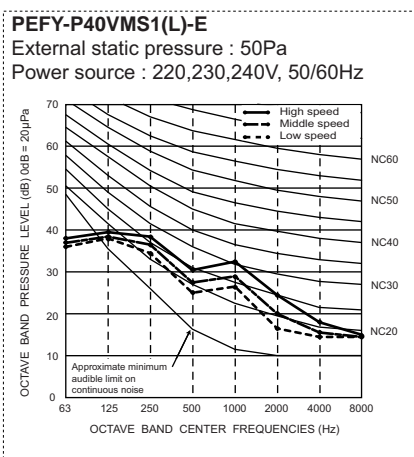
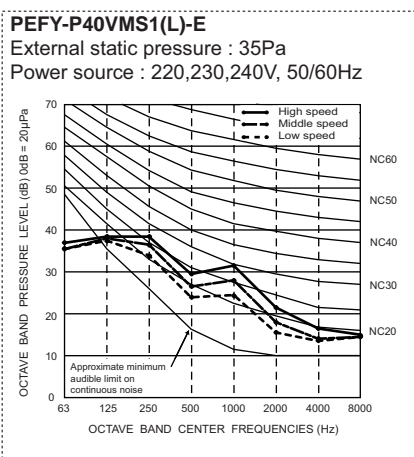
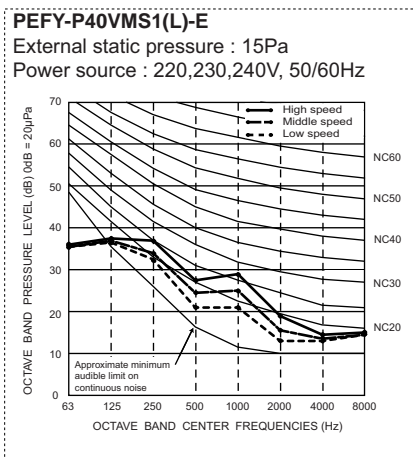
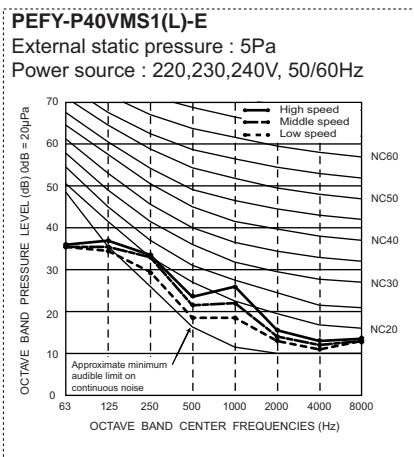
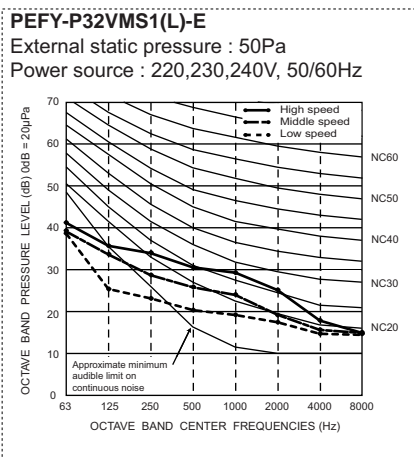
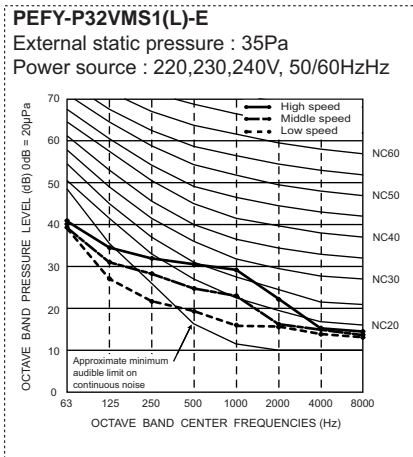
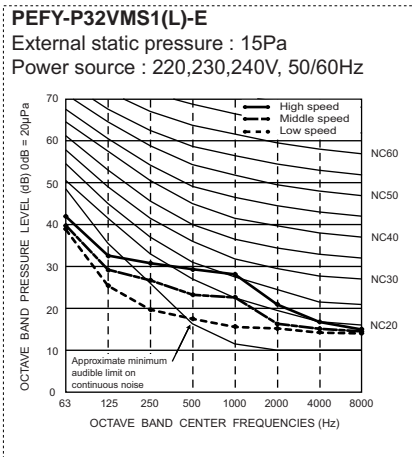
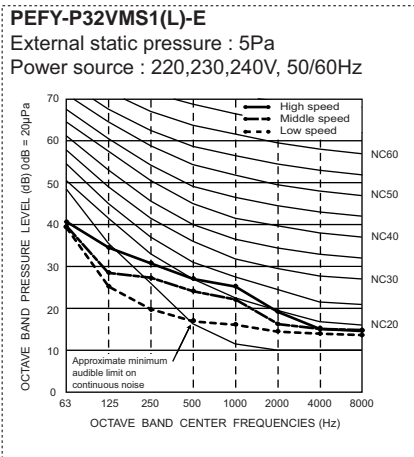

PEFY-P63VMS1(L)-E
 External static pressure : 5Pa
 Power source : 220,230,240V, 50/60Hz

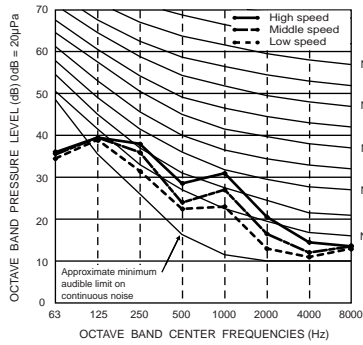

PEFY-P63VMS1(L)-E
 External static pressure : 15Pa
 Power source : 220,230,240V, 50/60Hz

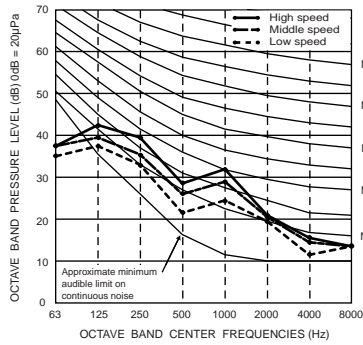

PEFY-P63VMS1(L)-E
 External static pressure : 35Pa
 Power source : 220,230,240V, 50/60Hz

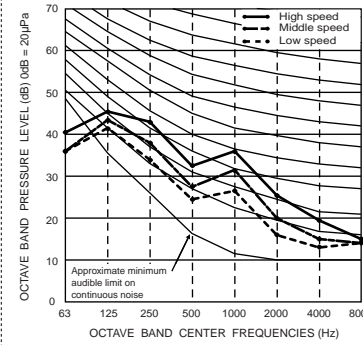

PEFY-P63VMS1(L)-E
 External static pressure : 50Pa
 Power source : 220,230,240V, 50/60Hz

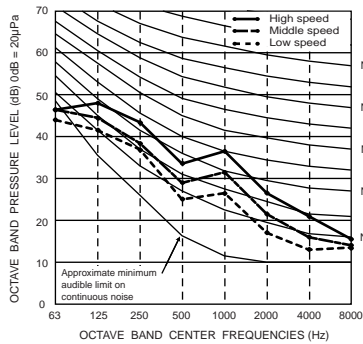

PEFY-P40,50VMH-E
 External static pressure : 50Pa
 Power source : 220V, 50/60Hz

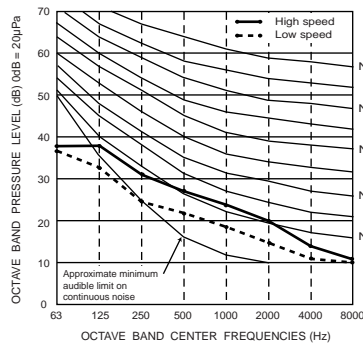

PEFY-P40,50VMH-E
 External static pressure : 100Pa
 Power source : 220V, 50/60Hz

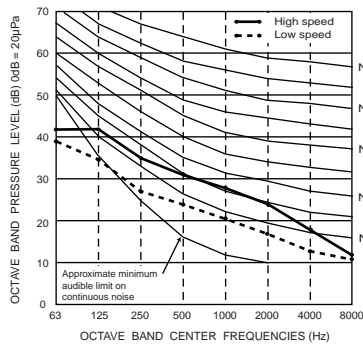

PEFY-P40,50VMH-E
 External static pressure : 200Pa
 Power source : 220V, 50/60Hz

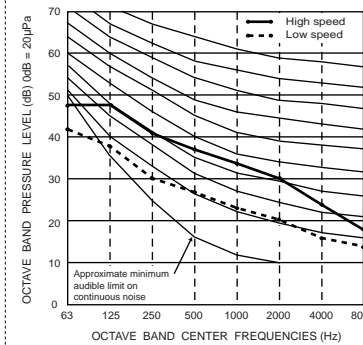

PEFY-P63VMH-E
 External static pressure : 50Pa
 Power source : 220V, 50/60Hz

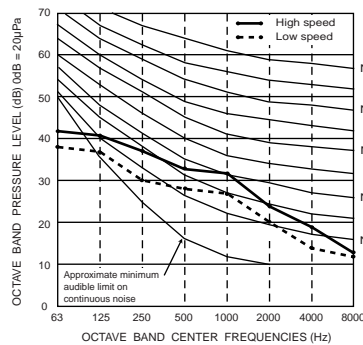

PEFY-P63VMH-E
 External static pressure : 100Pa
 Power source : 220V, 50/60Hz

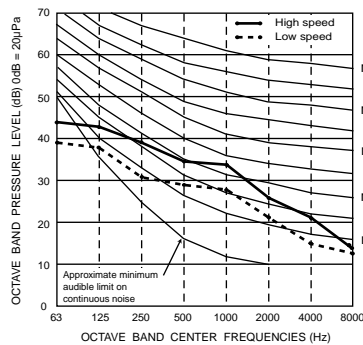

PEFY-P63VMH-E
 External static pressure : 200Pa
 Power source : 220V, 50/60Hz

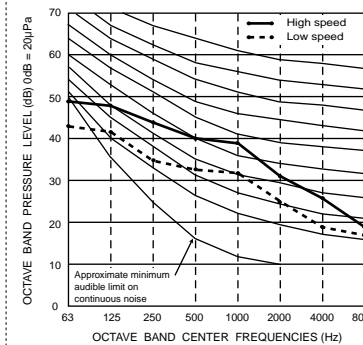

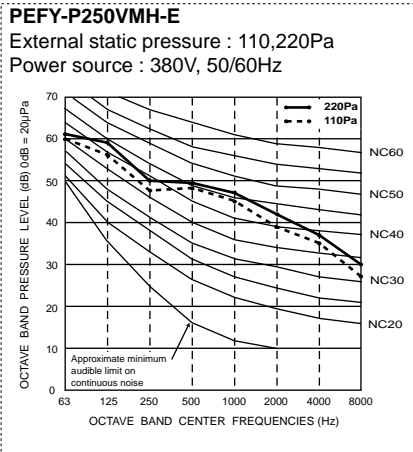
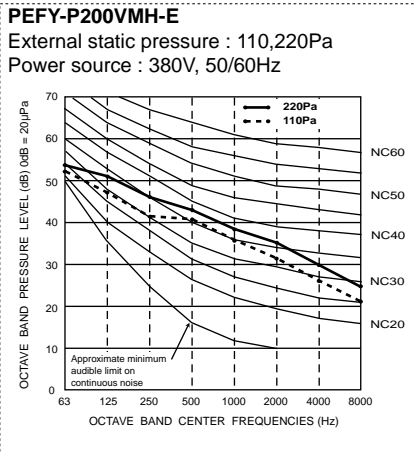
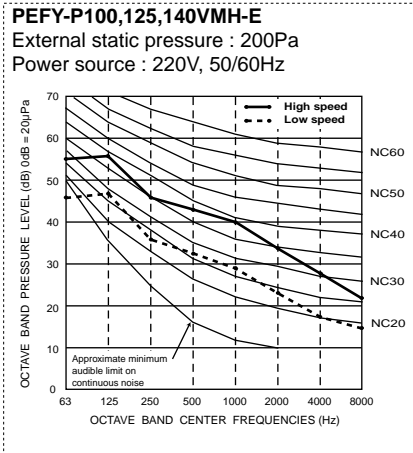
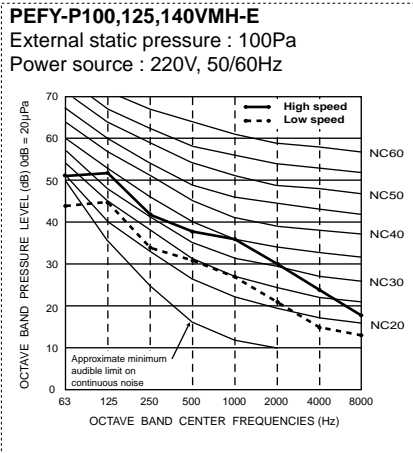
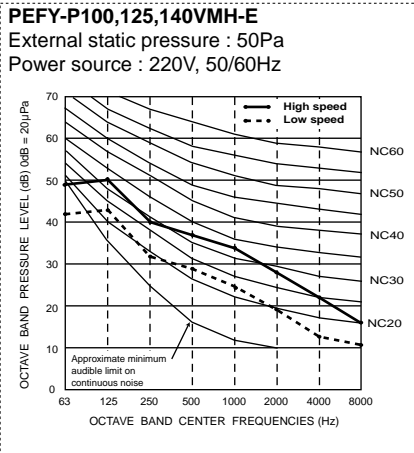
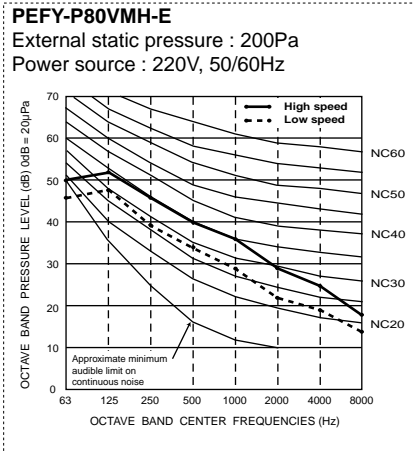
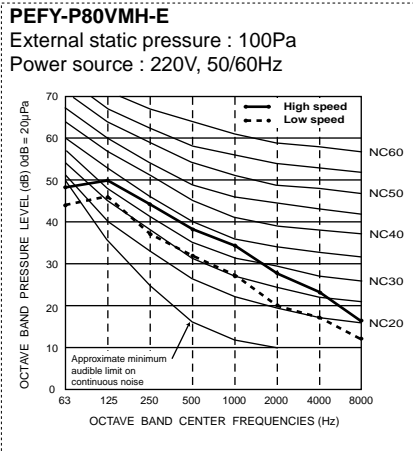
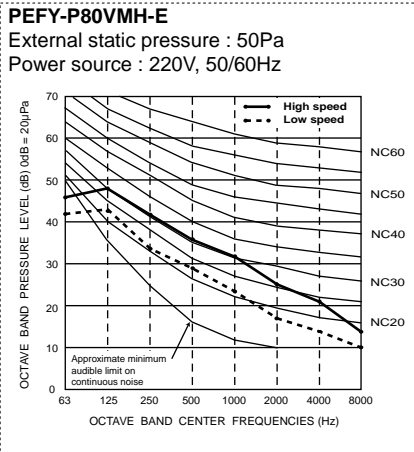
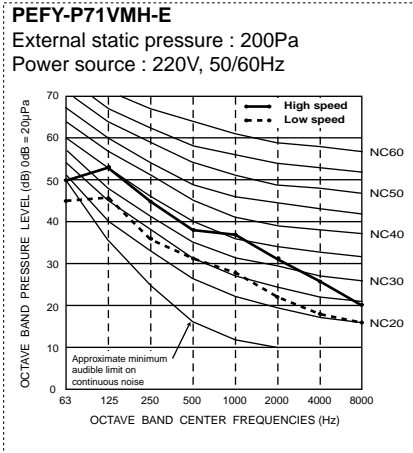
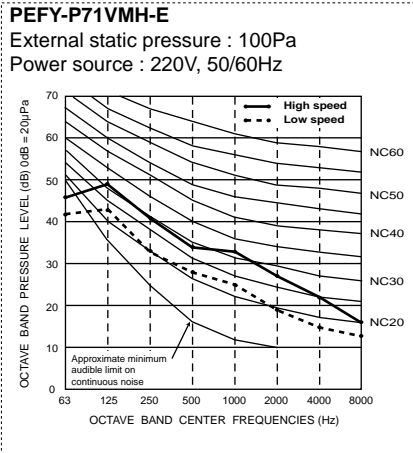
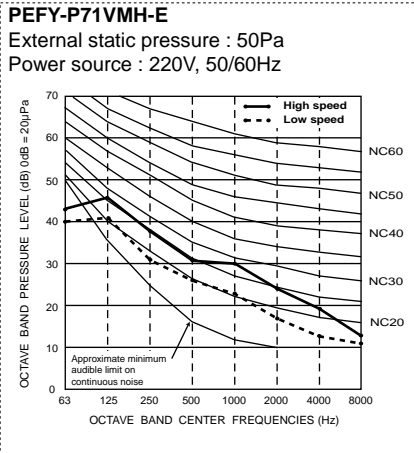

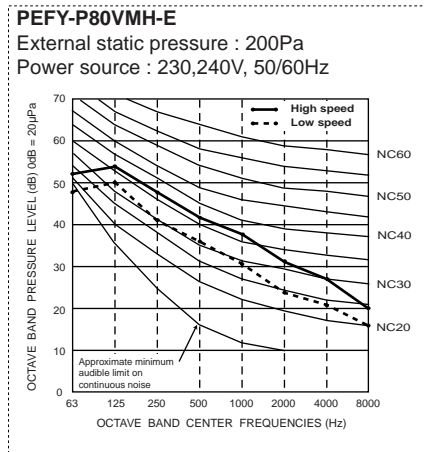
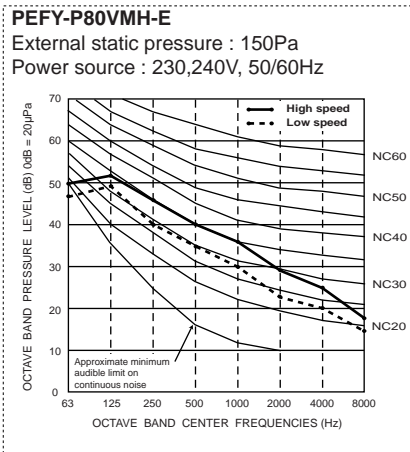
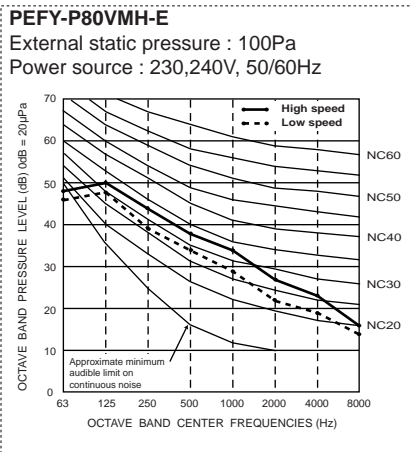
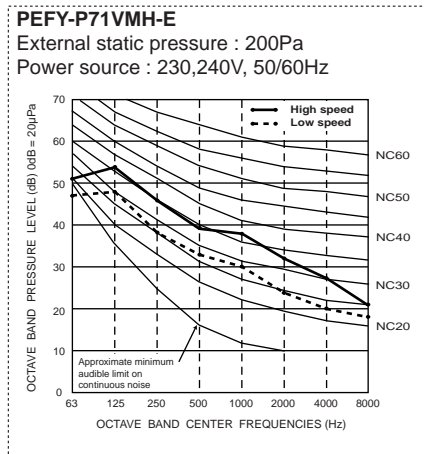
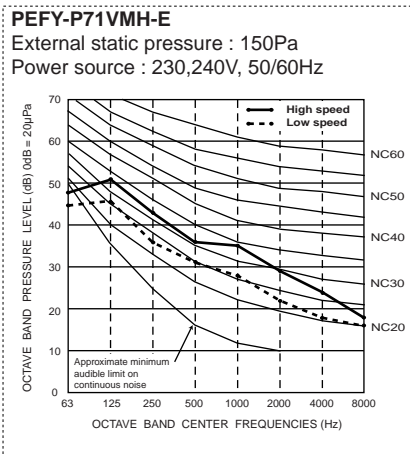
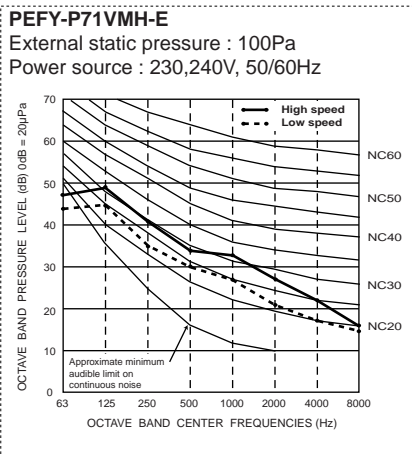
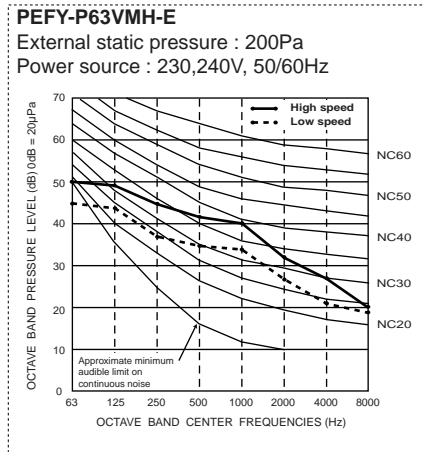
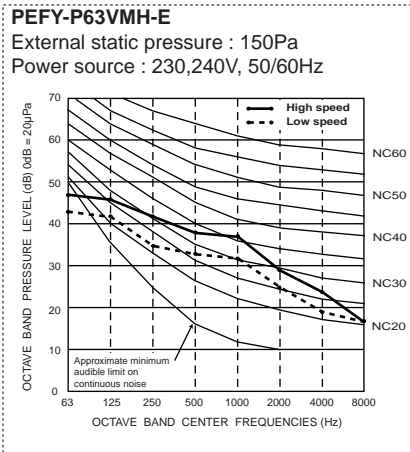
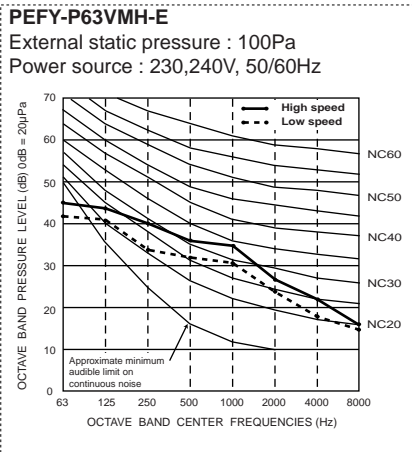
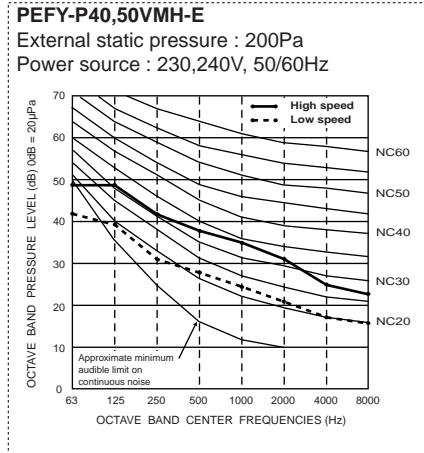
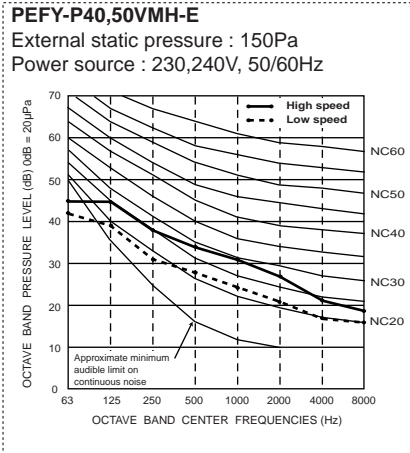
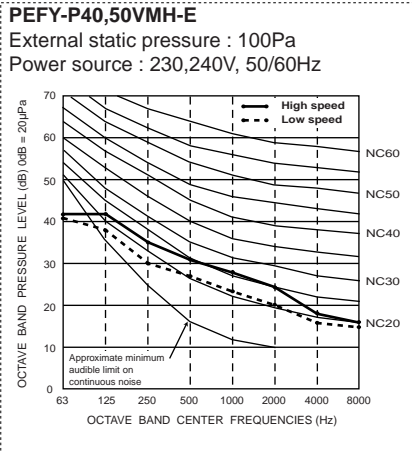

PEFY-P100,125,140VMH-E
 External static pressure : 100Pa
 Power source : 230,240V, 50/60Hz

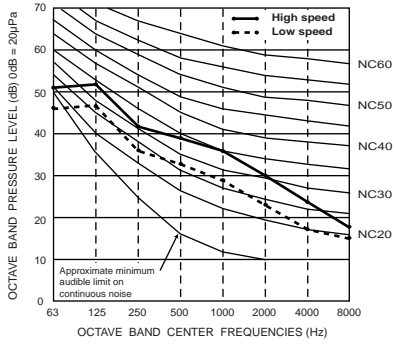

PEFY-P100,125,140VMH-E
 External static pressure : 150Pa
 Power source : 230,240V, 50/60Hz

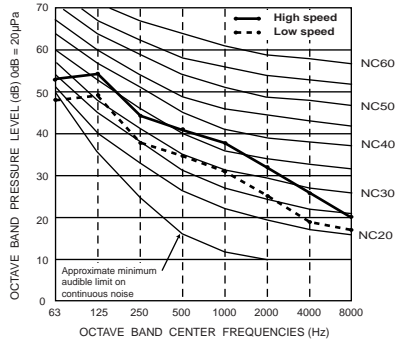

PEFY-P100,125,140VMH-E
 External static pressure : 200Pa
 Power source : 230,240V, 50/60Hz

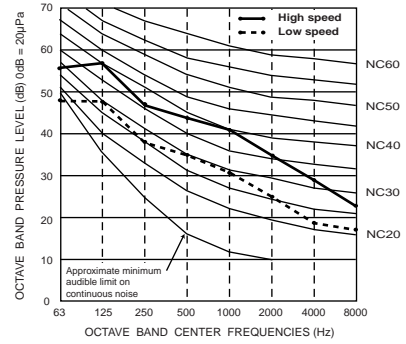

PEFY-P200VMH-E
 External static pressure : 130,260Pa
 Power source : 400,415V, 50/60Hz

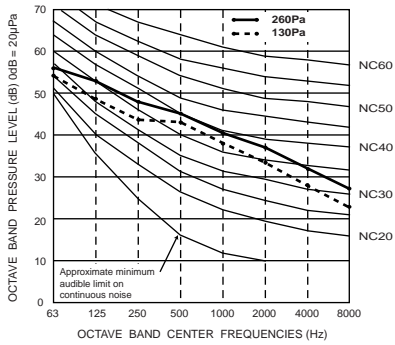

PEFY-P250VMH-E
 External static pressure : 130,260Pa
 Power source : 400,415V, 50/60Hz

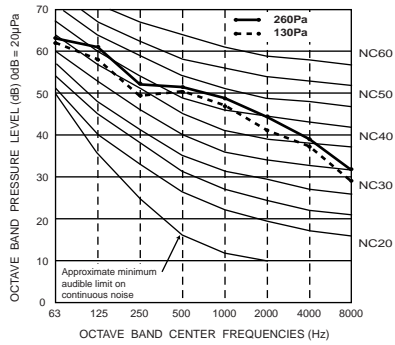

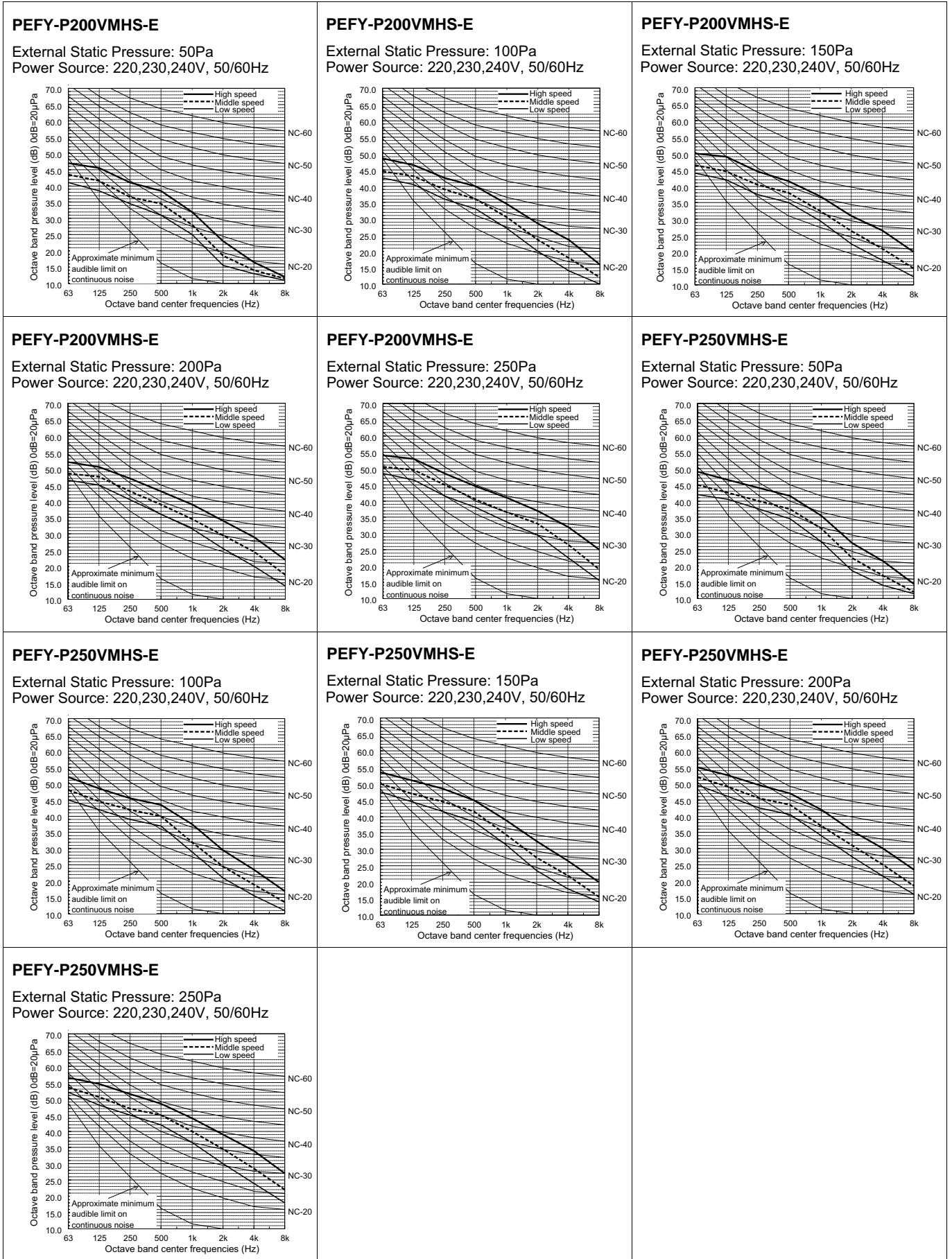

6. FAN CHARACTERISTICS CURVES

PEFY

PEFY-P20,25VMR-E-L/R

External static pressure : 5Pa
Power source : 220,230,240V

Suction : Back inlet
— 50Hz
- - - 60Hz

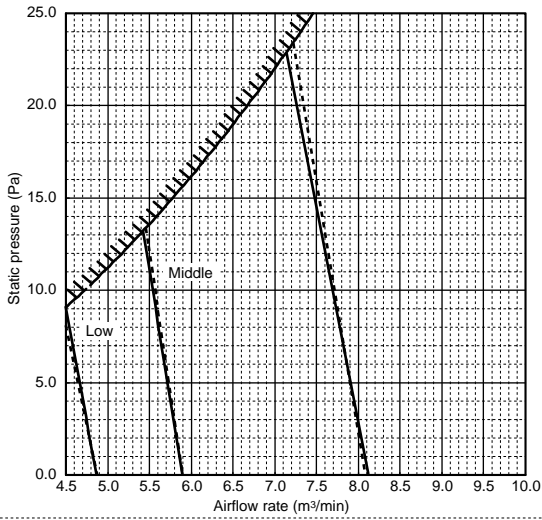

PEFY-P32VMR-E-L/R

External static pressure : 5Pa
Power source : 220,230,240V

Suction : Back inlet
— 50Hz
- - - 60Hz

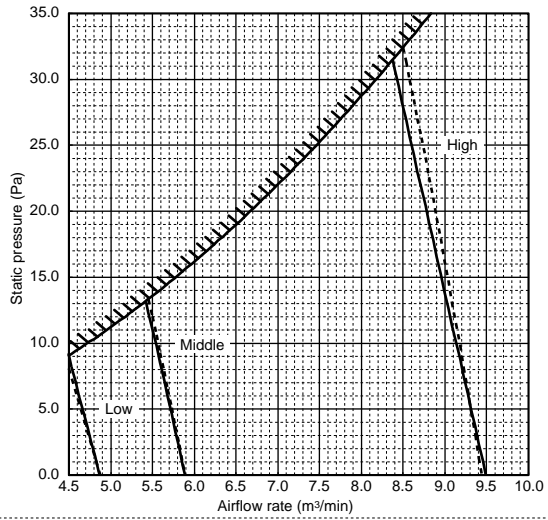

PEFY-P15VMS1(L)-E

External static pressure : 5Pa
Power source : 220,230,240V, 50/60Hz

Suction : Back inlet

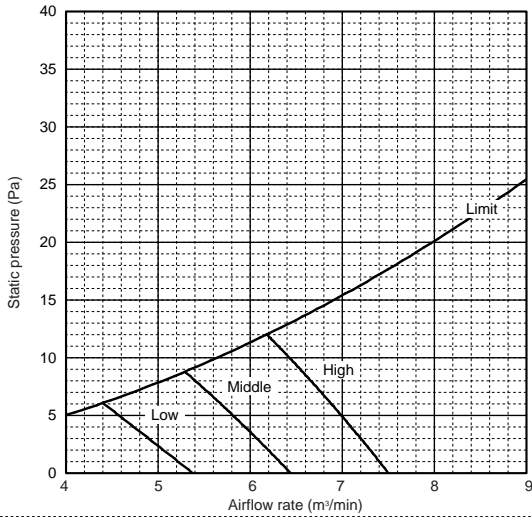

PEFY-P15VMS1(L)-E

External static pressure : 15Pa
Power source : 220,230,240V, 50/60Hz

Suction : Back inlet

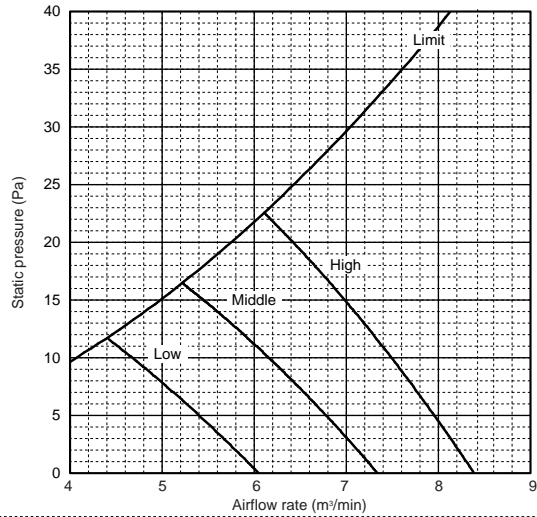

PEFY-P15VMS1(L)-E

External static pressure : 35Pa
Power source : 220,230,240V, 50/60Hz

Suction : Back inlet

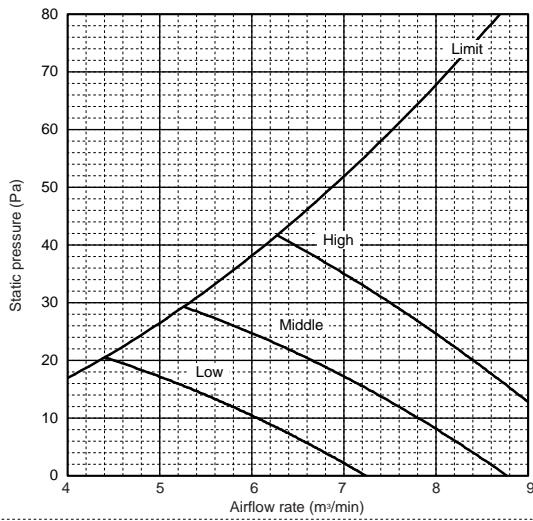

PEFY-P15VMS1(L)-E

External static pressure : 50Pa
Power source : 220,230,240V, 50/60Hz

Suction : Back inlet

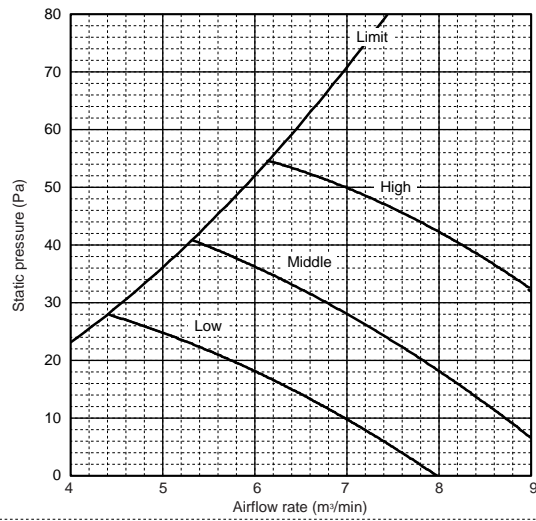

PEFY-P20VMS1(L)-E

External static pressure : 5Pa
Power source : 220,230,240V, 50/60Hz

Suction : Back inlet

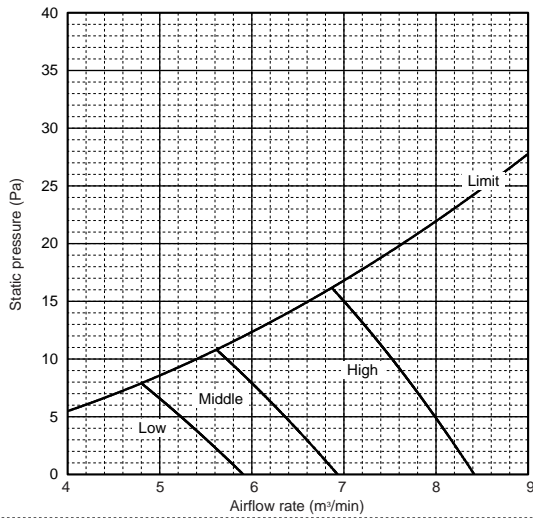

PEFY-P20VMS1(L)-E

External static pressure : 15Pa
Power source : 220,230,240V, 50/60Hz

Suction : Back inlet

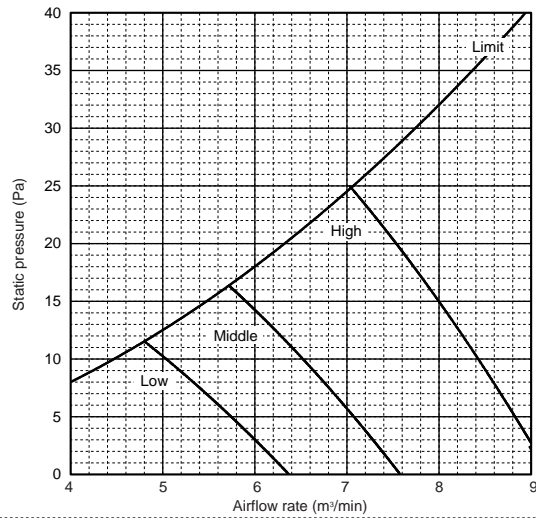

PEFY-P20VMS1(L)-E

External static pressure : 35Pa
Power source : 220,230,240V, 50/60Hz

Suction : Back inlet

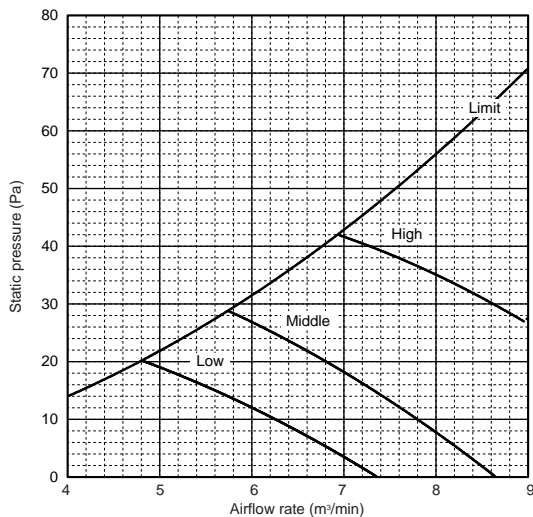

PEFY-P20VMS1(L)-E

External static pressure : 50Pa
Power source : 220,230,240V, 50/60Hz

Suction : Back inlet

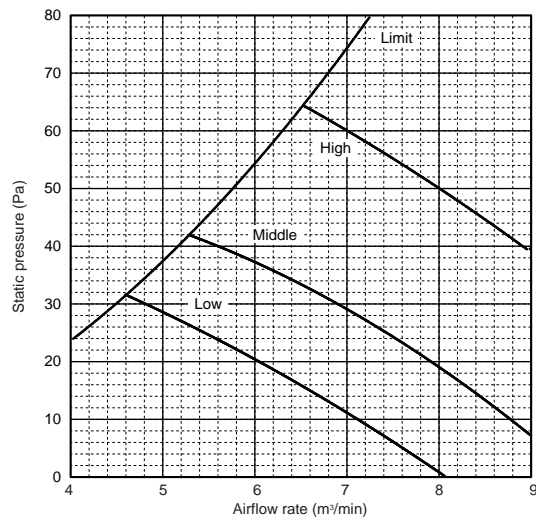

6. FAN CHARACTERISTICS CURVES

PEFY

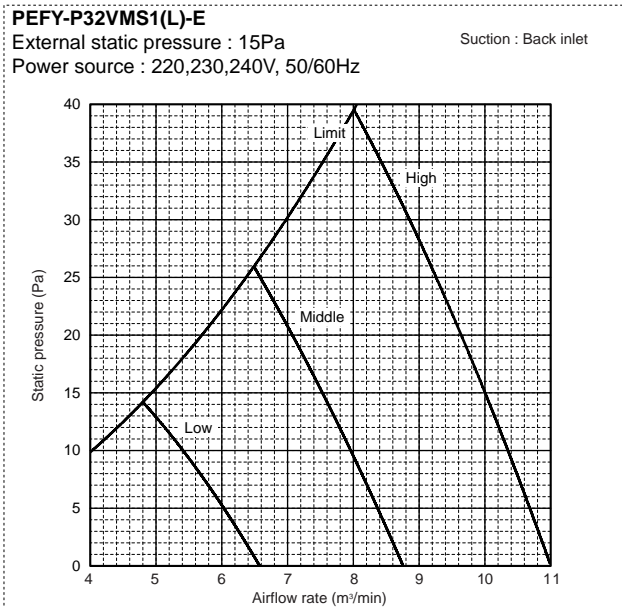
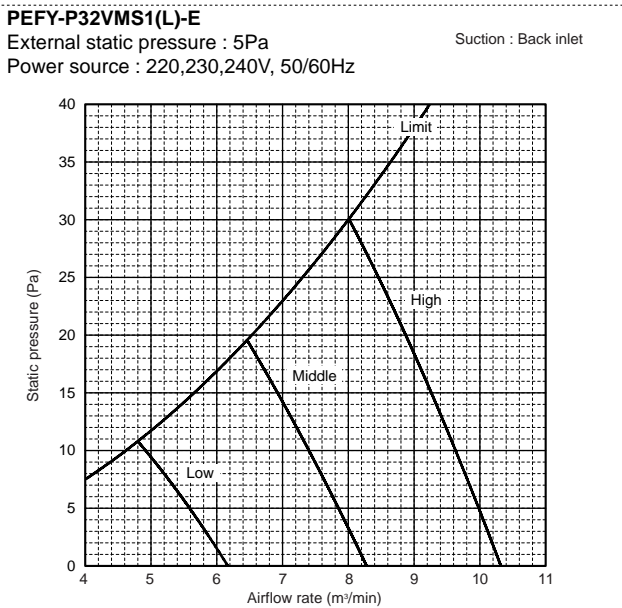
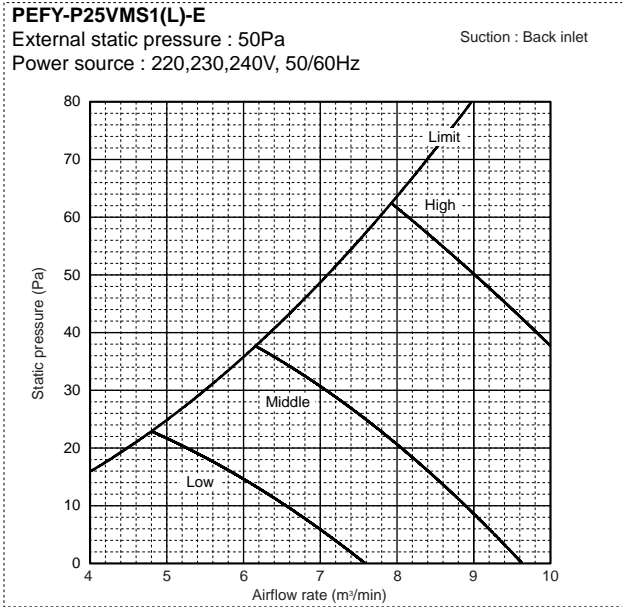
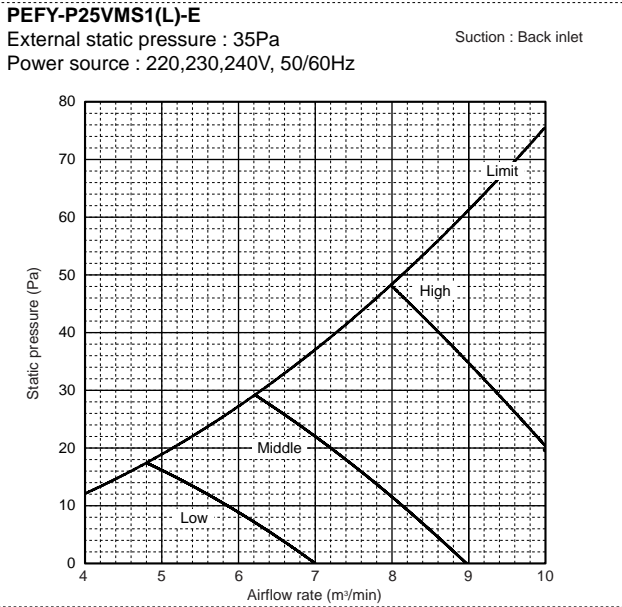
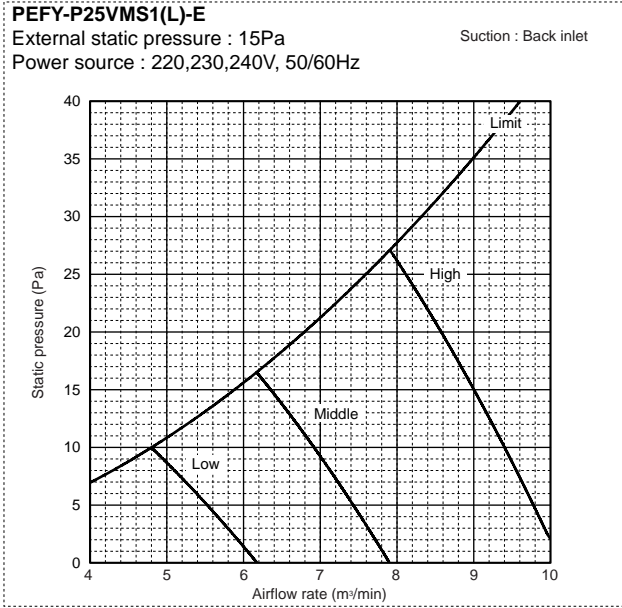
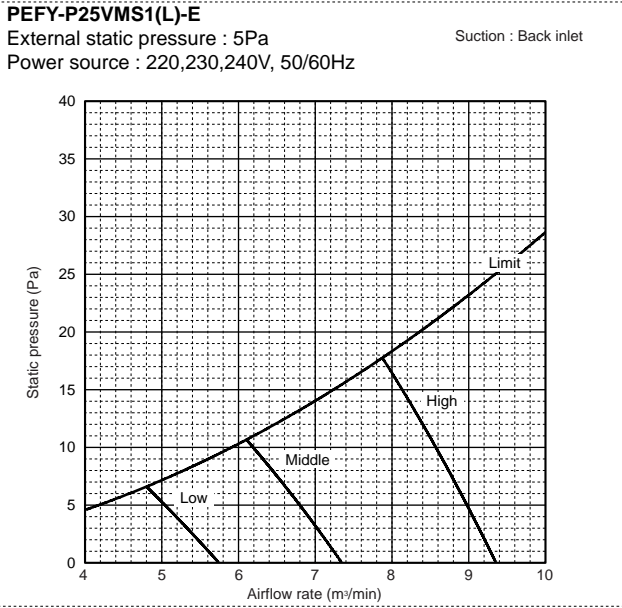

PEFY-P32VMS1(L)-E

External static pressure : 35Pa
Power source : 220,230,240V, 50/60Hz

Suction : Back inlet

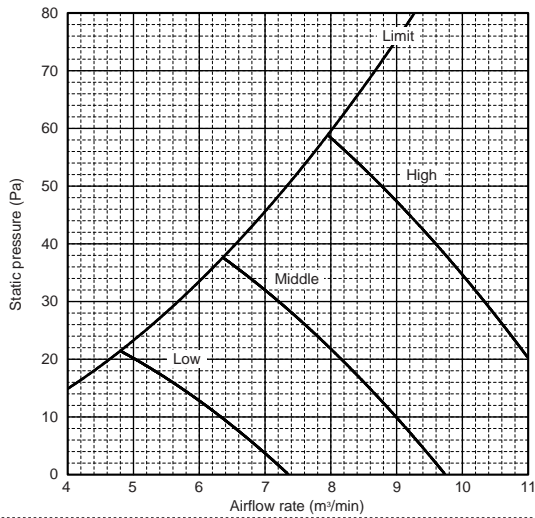

PEFY-P32VMS1(L)-E

External static pressure : 50Pa
Power source : 220,230,240V, 50/60Hz

Suction : Back inlet

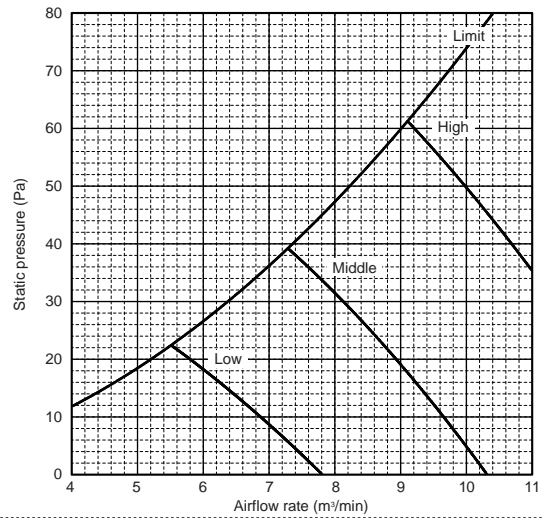

PEFY-P40VMS1(L)-E

External static pressure : 5Pa
Power source : 220,230,240V, 50/60Hz

Suction : Back inlet

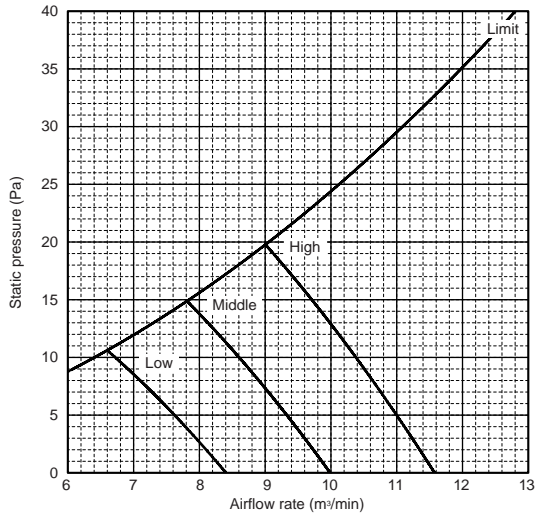

PEFY-P40VMS1(L)-E

External static pressure : 15Pa
Power source : 220,230,240V, 50/60Hz

Suction : Back inlet

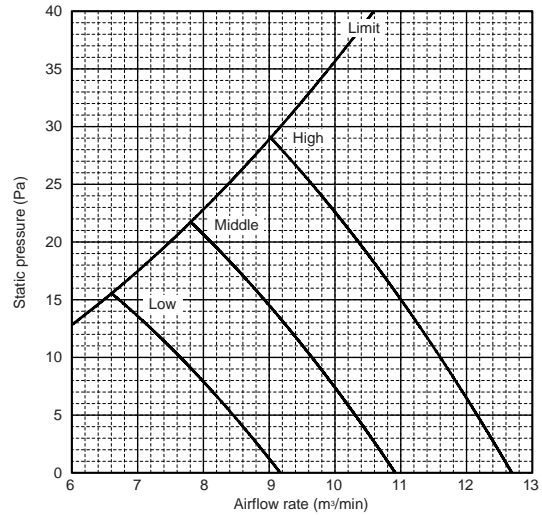

PEFY-P40VMS1(L)-E

External static pressure : 35Pa
Power source : 220,230,240V, 50/60Hz

Suction : Back inlet

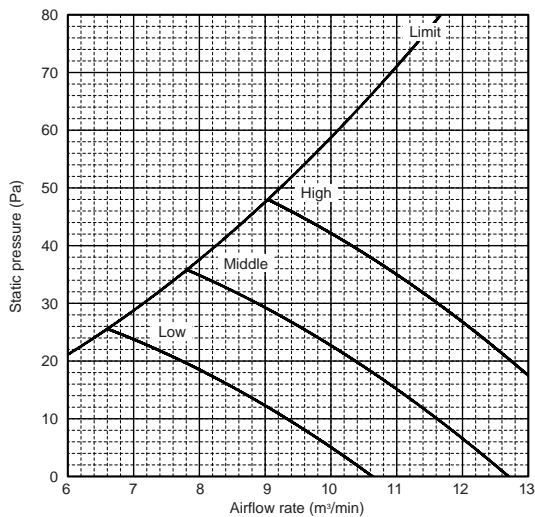

PEFY-P40VMS1(L)-E

External static pressure : 50Pa
Power source : 220,230,240V, 50/60Hz

Suction : Back inlet

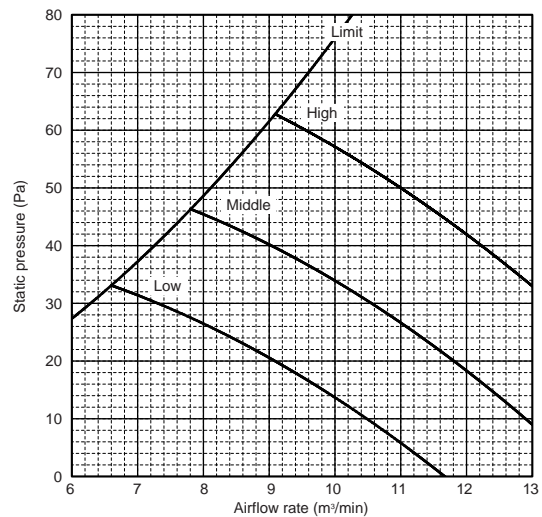

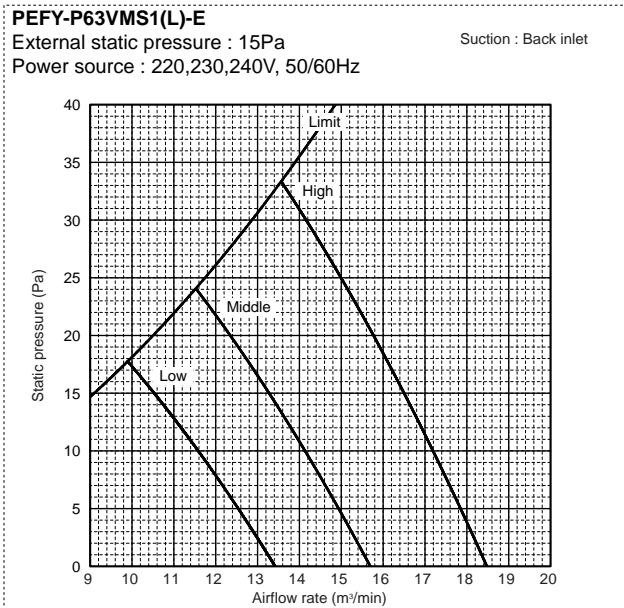
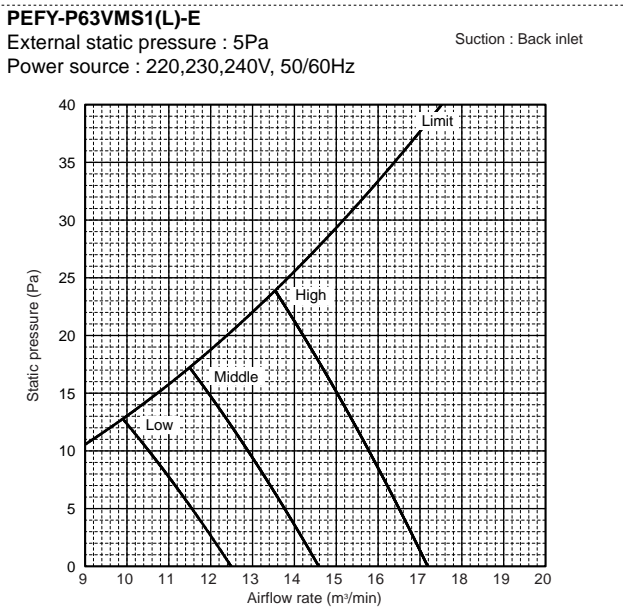
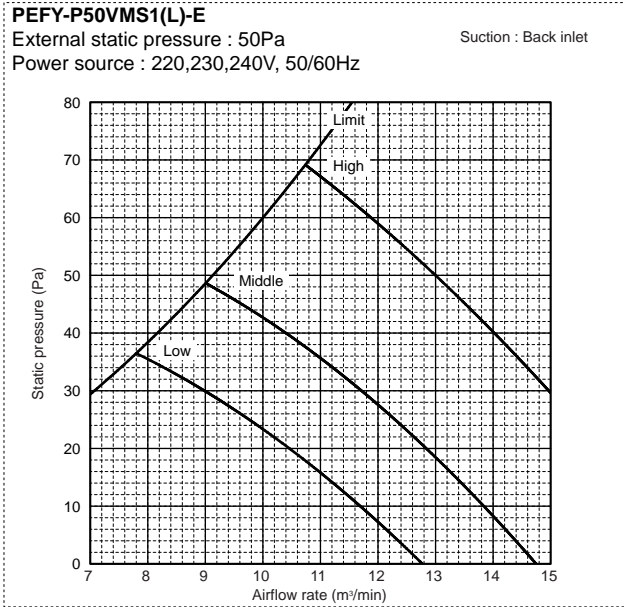
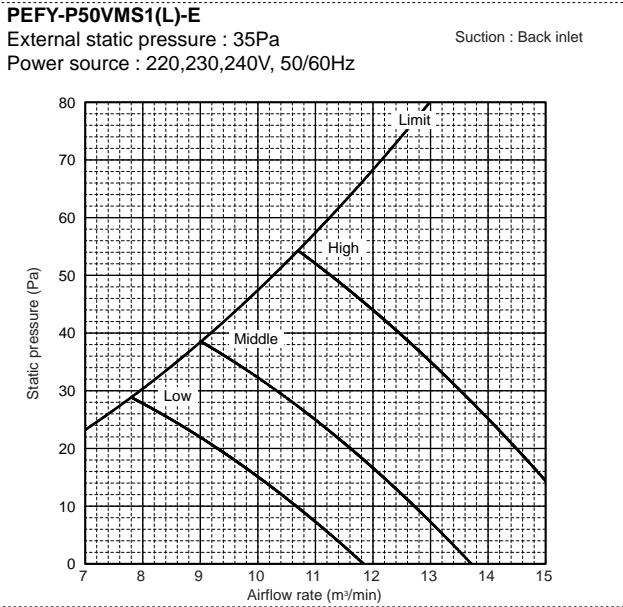
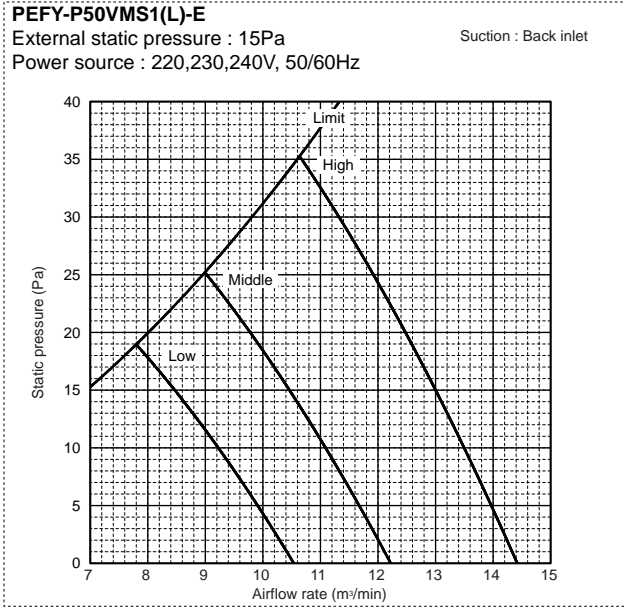
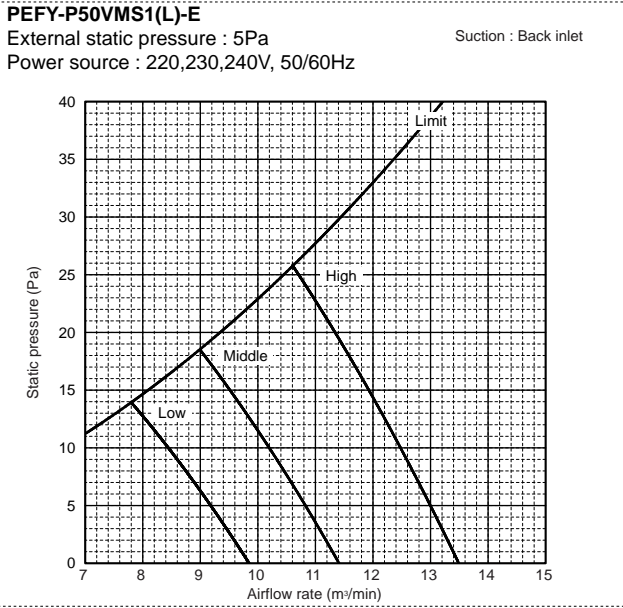

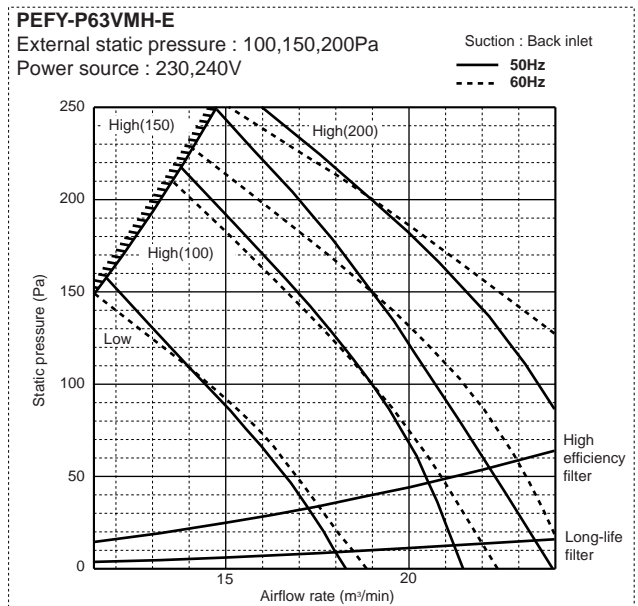
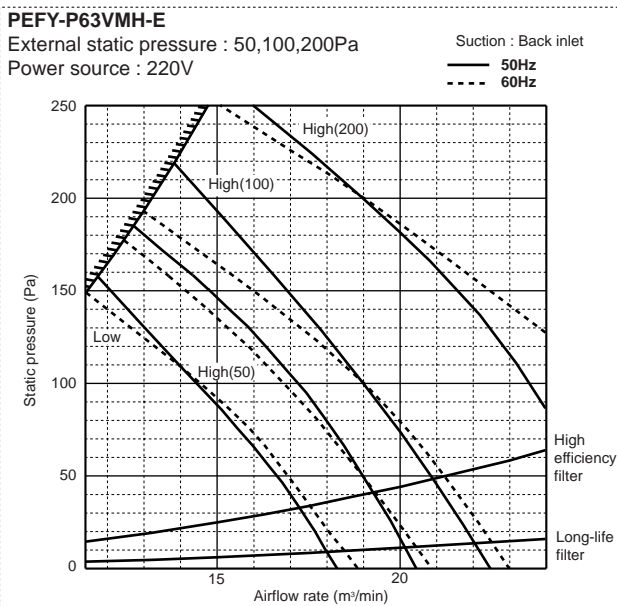
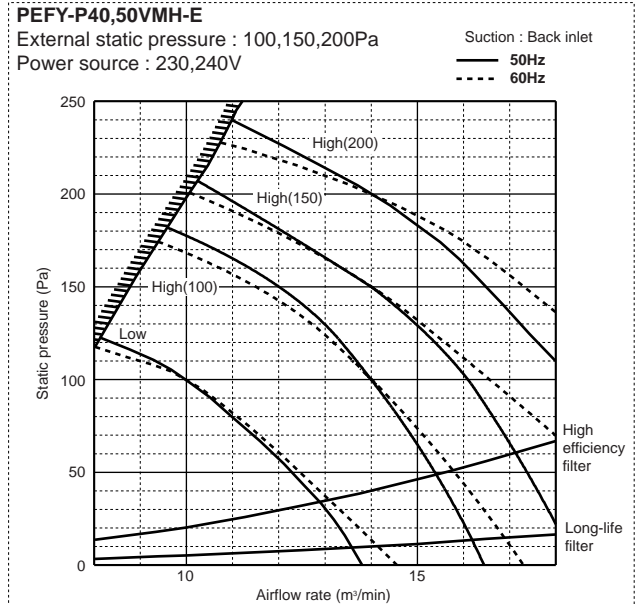
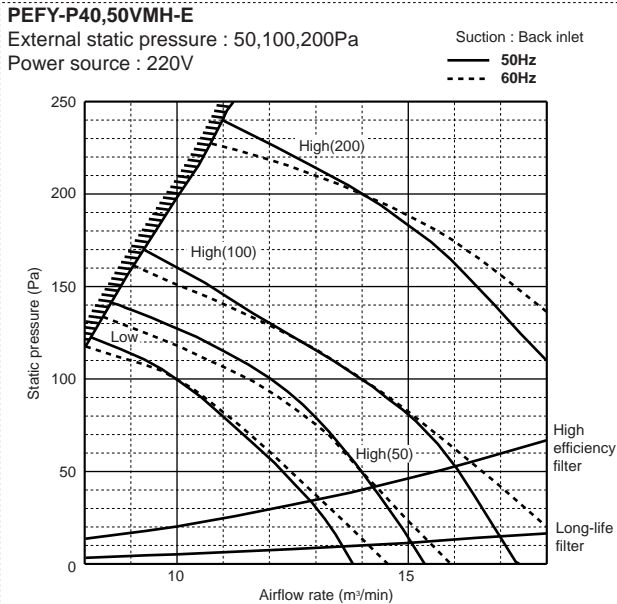
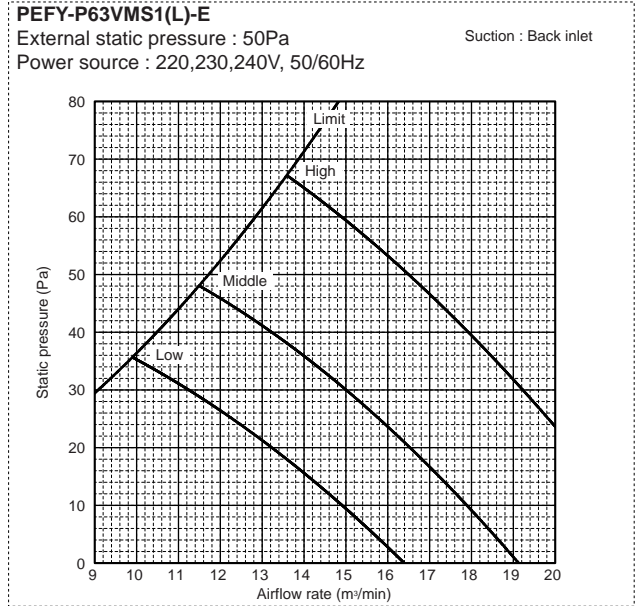
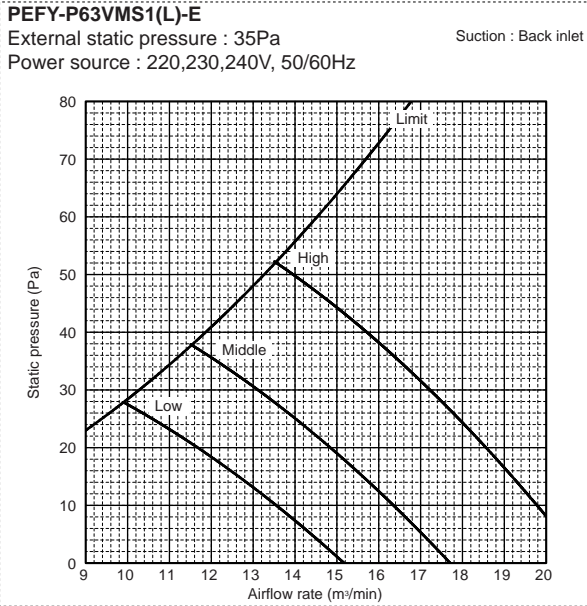

6. FAN CHARACTERISTICS CURVES

PEFY

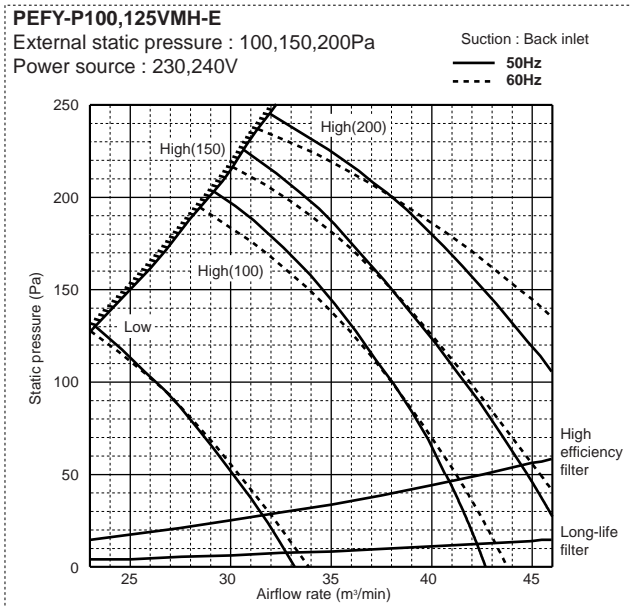
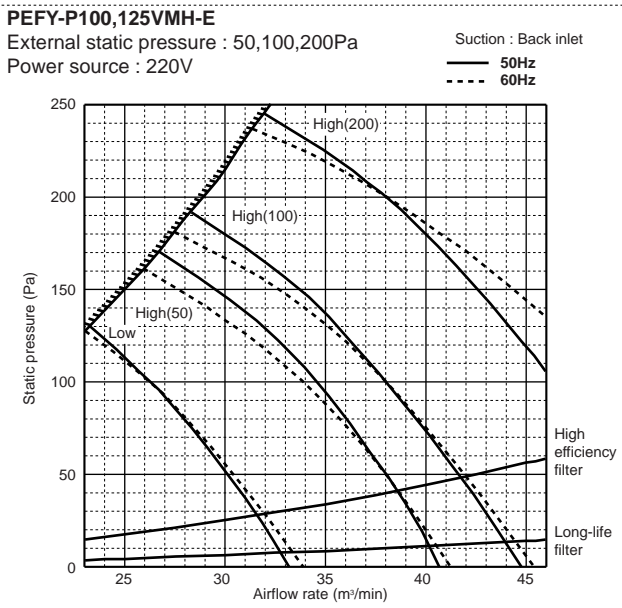
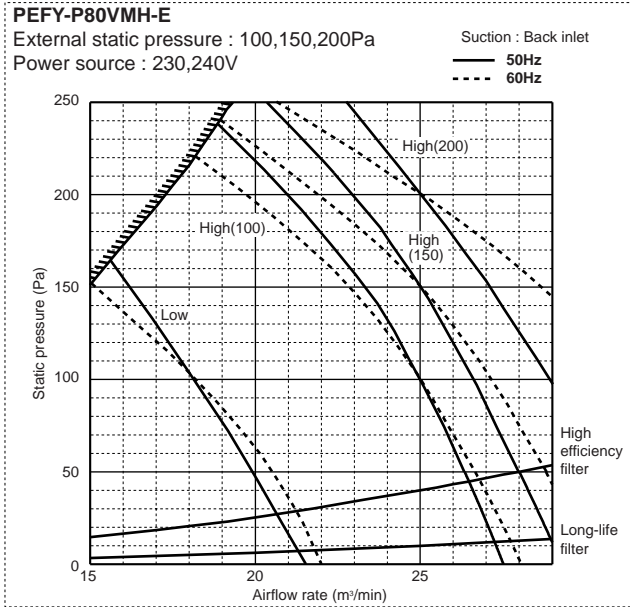
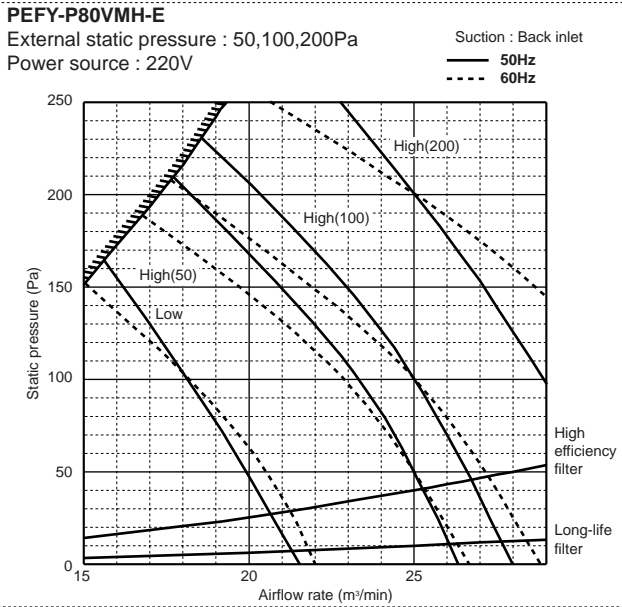
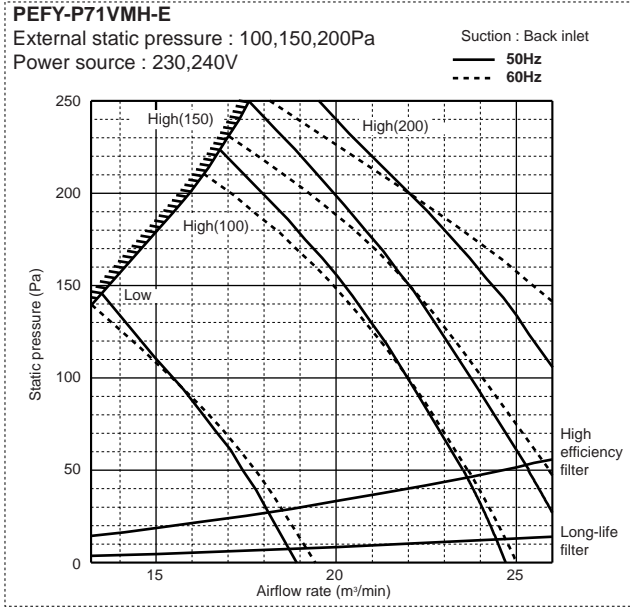
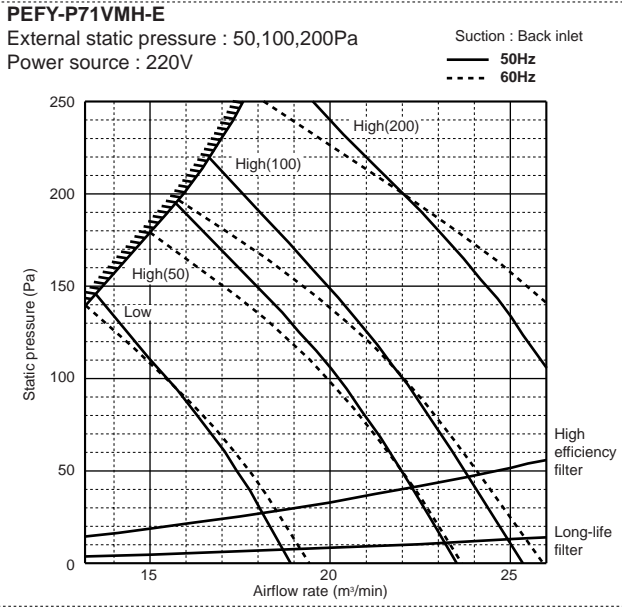

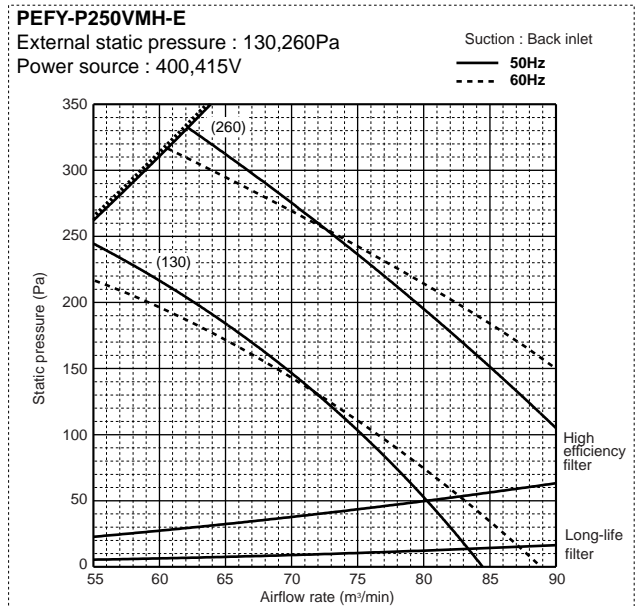
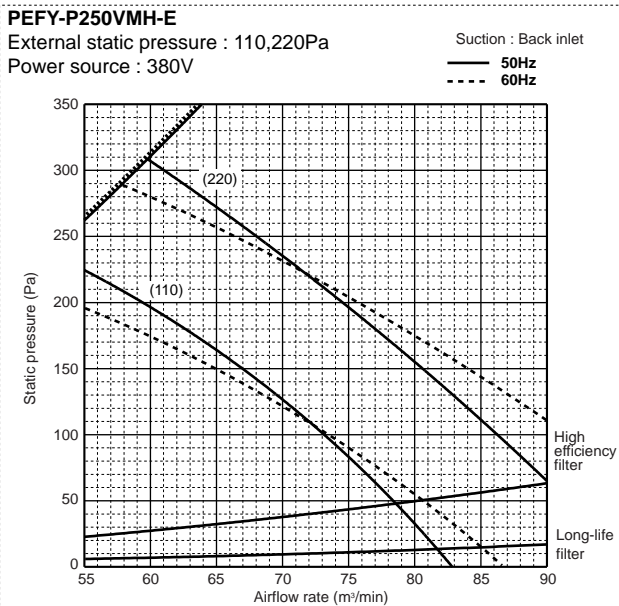
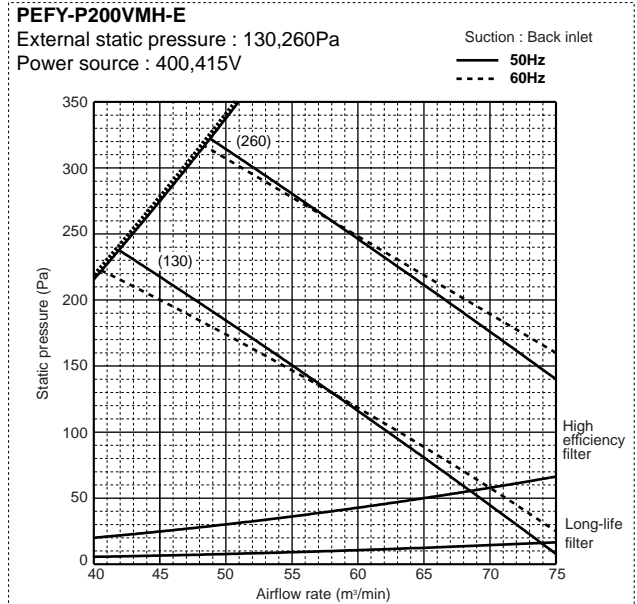
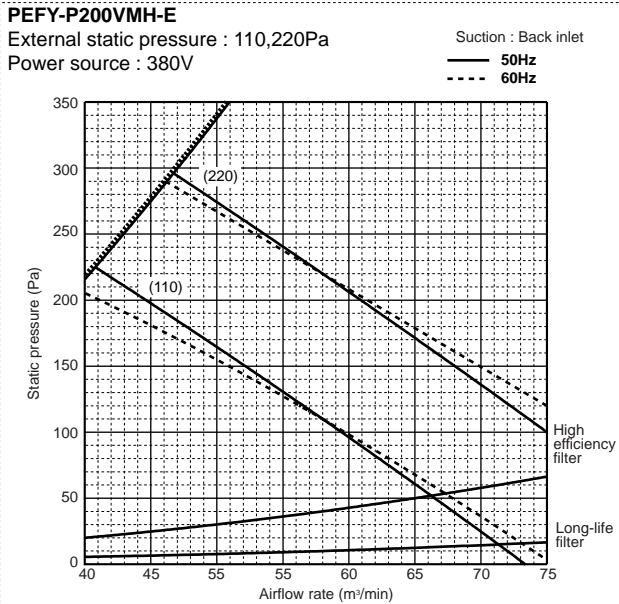
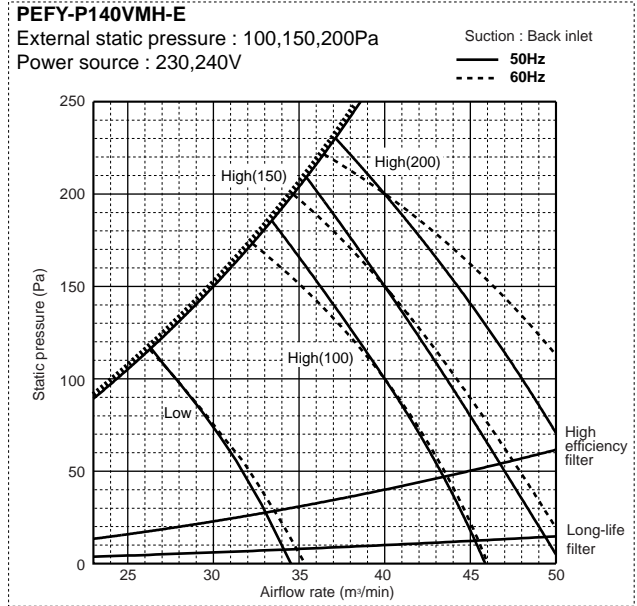
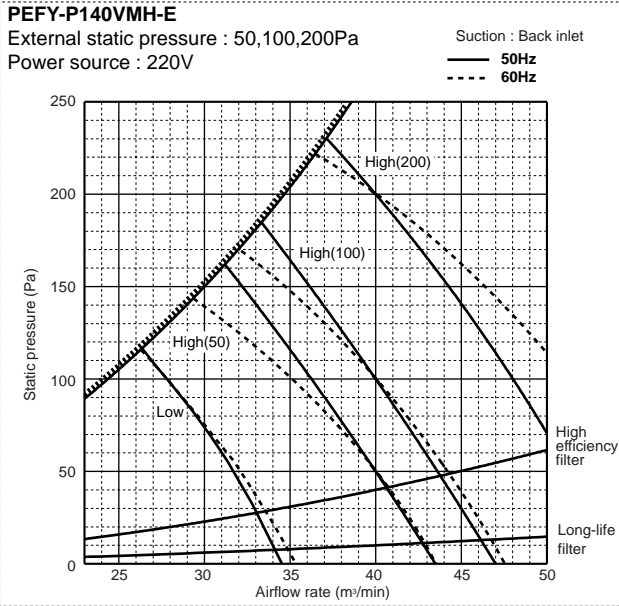

6. FAN CHARACTERISTICS CURVES

YKB/YLM

PEFY

PEFY-P200VMHS-E

External static pressure : 50Pa
Power source : 220,230,240V, 50/60Hz

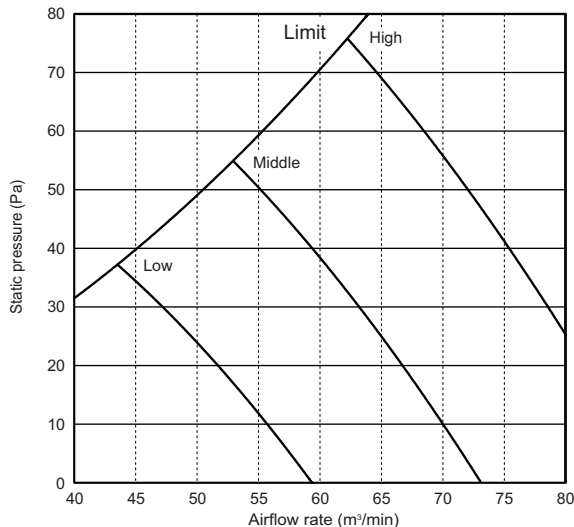

PEFY-P200VMHS-E

External static pressure : 100Pa
Power source : 220,230,240V, 50/60Hz

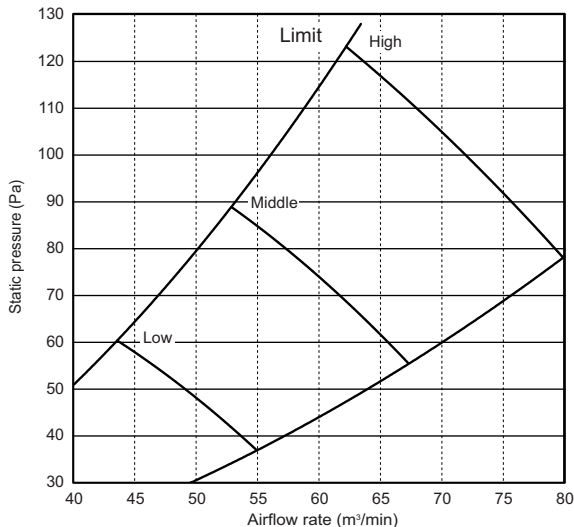

PEFY-P200VMHS-E

External static pressure : 150Pa
Power source : 220,230,240V, 50/60Hz

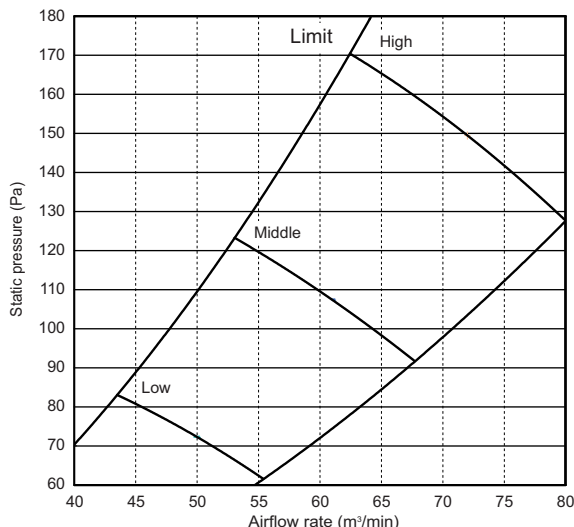

PEFY-P200VMHS-E

External static pressure : 200Pa
Power source : 220,230,240V, 50/60Hz

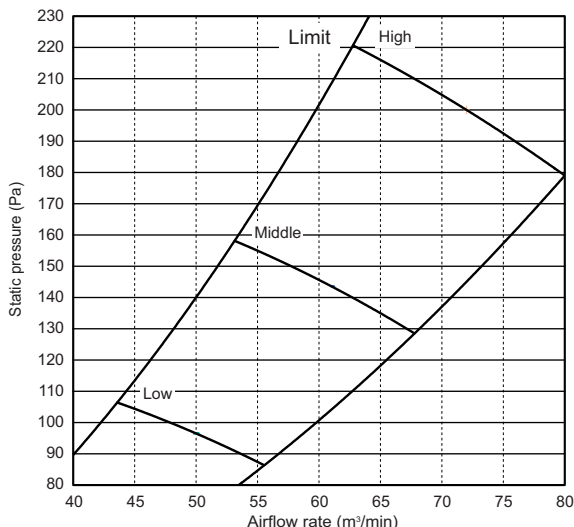

PEFY-P200VMHS-E

External static pressure : 250Pa
Power source : 220,230,240V, 50/60Hz

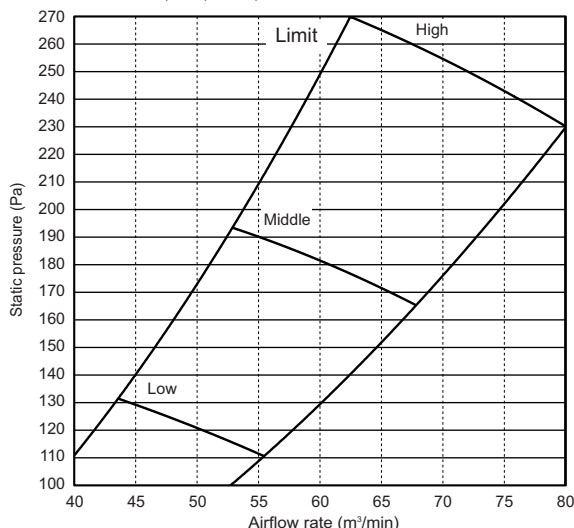

PEFY-P250VMHS-E

External static pressure : 50Pa
Power source : 220,230,240V, 50/60Hz

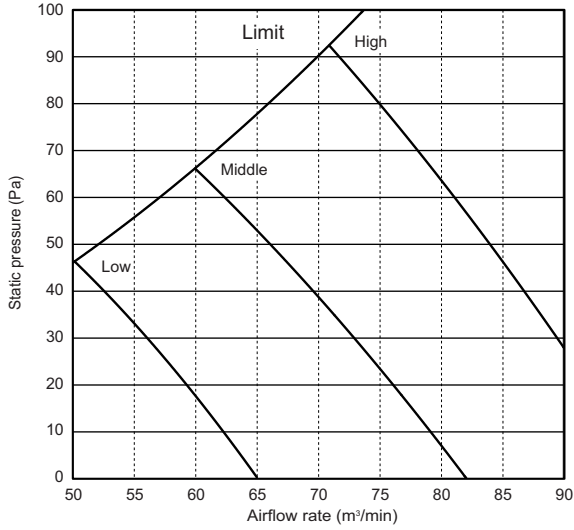

PEFY-P250VMHS-E

External static pressure : 100Pa
Power source : 220,230,240V, 50/60Hz

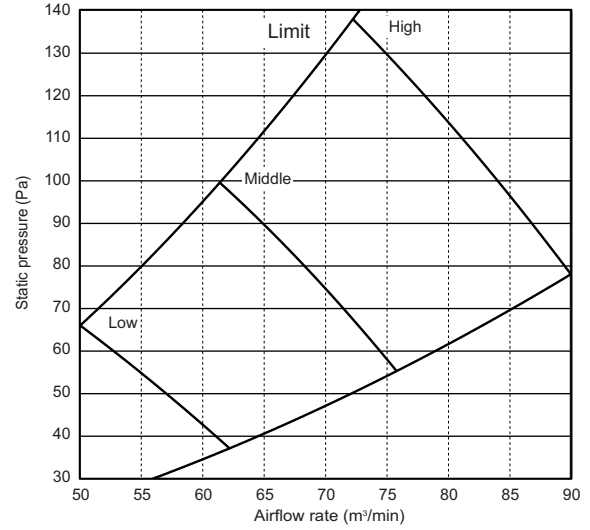

PEFY-P250VMHS-E

External static pressure : 150Pa
Power source : 220,230,240V, 50/60Hz

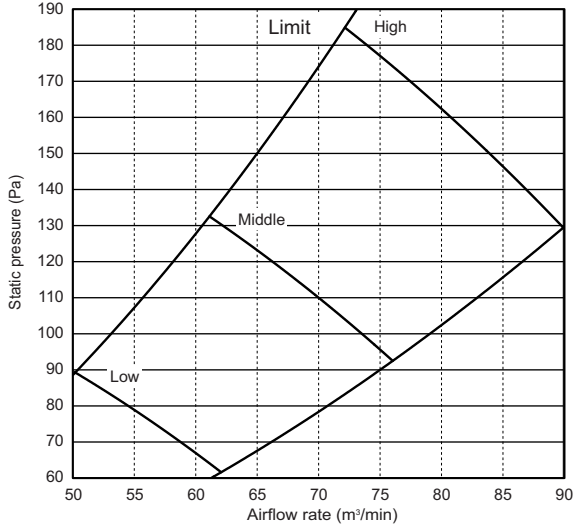

PEFY-P250VMHS-E

External static pressure : 200Pa
Power source : 220,230,240V, 50/60Hz

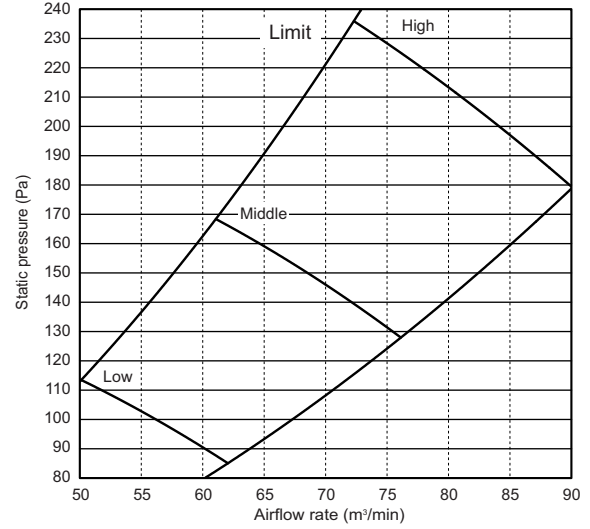

PEFY-P250VMHS-E

External static pressure : 250Pa
Power source : 220,230,240V, 50/60Hz

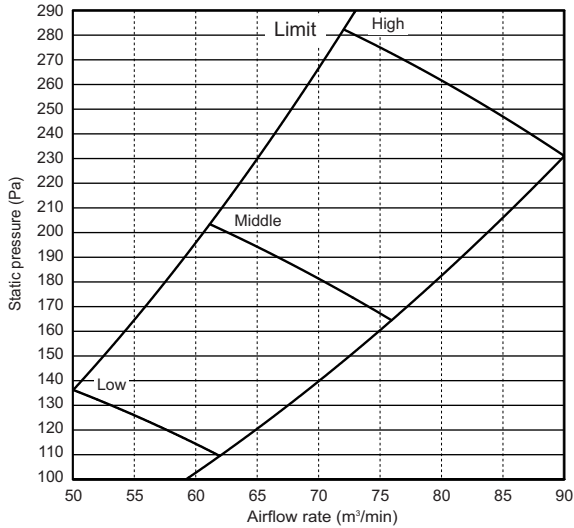

7-1. Optional parts line up for the Indoor unit

	Drain pump	Control box replace kit		
PEFY-P15,20,25,32,40,50,63VMS1-E	-	PAC-KE70HS-E		
PEFY-P15,20,25,32,40,50,63VMS1L-E	PAC-KE07DM-E	PAC-KE70HS-E		
	Long-life filter	Filter box	Drain pump	
PEFY-P40,50,63VMH-E	PAC-KE86LAF	PAC-KE63TB-F	PAC-KE04DM-F	
PEFY-P71,80VMH-E	PAC-KE88LAF	PAC-KE80TB-F	PAC-KE04DM-F	
PEFY-P100,125,140VMH-E	PAC-KE89LAF	PAC-KE140TB-F	PAC-KE04DM-F	
PEFY-P200,250VMH-E	PAC-KE85LAF	PAC-KE250TB-F	PAC-KE04DM-F	
PEFY-P200,250VMHS-E	PAC-KE85LAF	PAC-KE250TB-F	PAC-KE05DM-F	

PEFY-P-VMS1 (L) -E

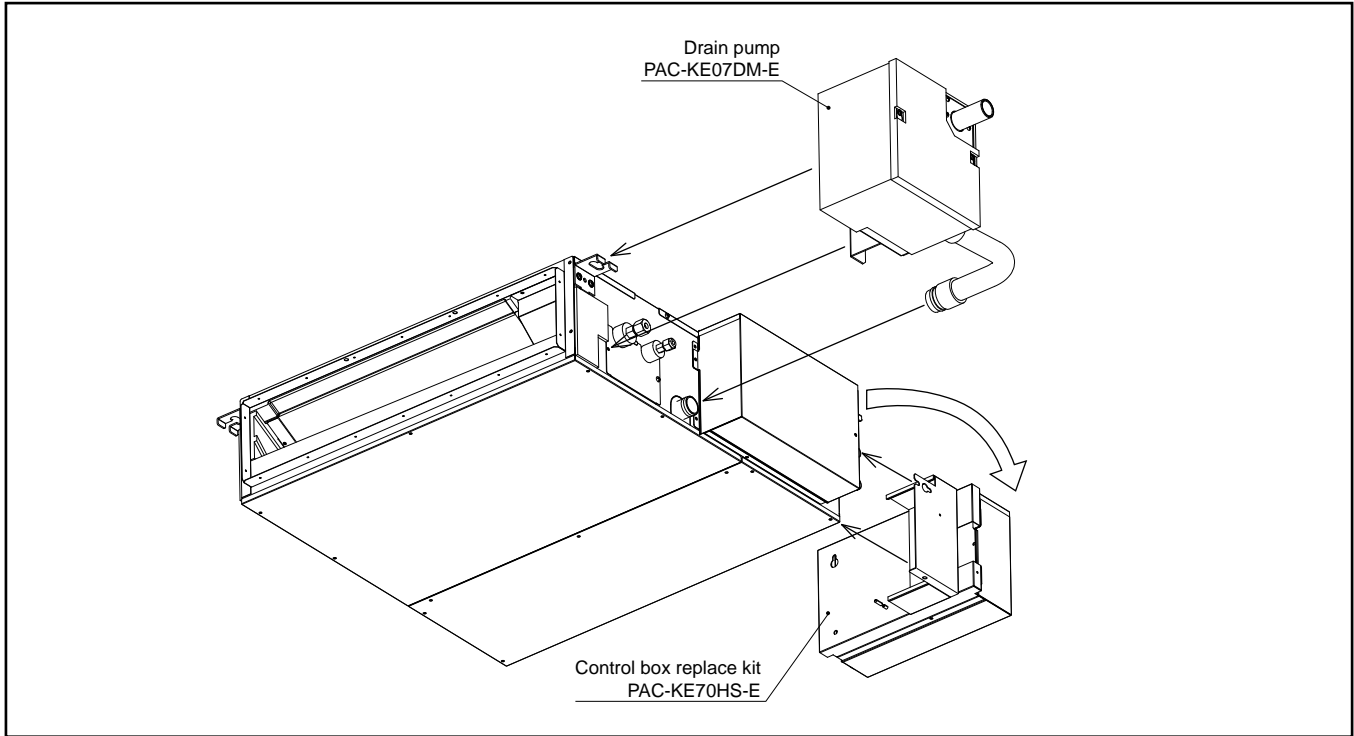

PEFY-P-VMH (S) -E

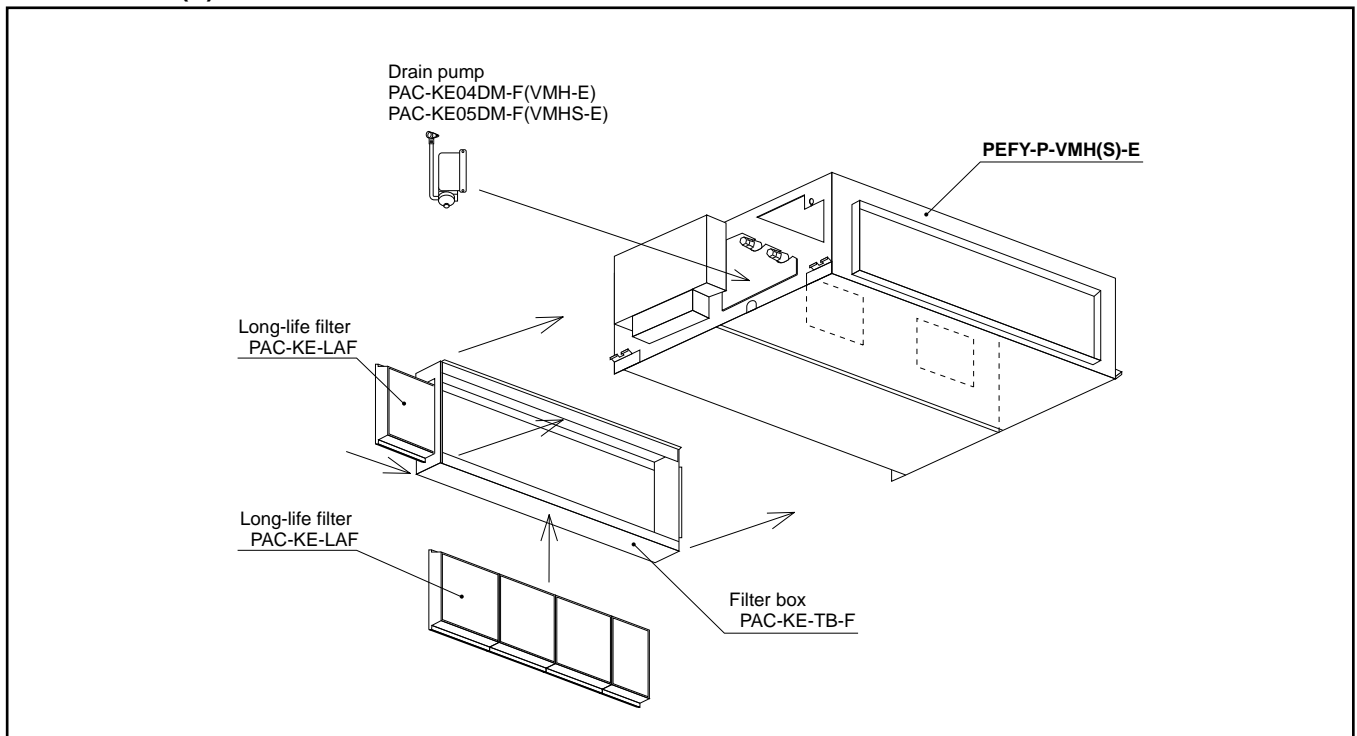

7-2. Long-life filter

Life span: 2,500 hr (Dust concentration 0.15mg/m³)
 * The actual dust situation affects the filter life span, which should be considered at the applying site.
 Material: Synthetic fiber unwoven cloth filter
 Static pressure loss is referred to 6 "FAN CHARACTERISTICS CURVES".
 Long-life filter should be used together with filter box PAC-KE-TB-F.

PAC-KE-LAF

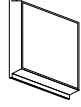
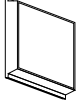
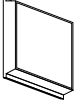
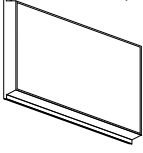
Item	PAC-KE86LAF	PAC-KE88LAF	PAC-KE89LAF	PAC-KE85LAF
Quantity	2	3	3	2
	(298X300)	(298X300)	(298X300)	(411X600)
Shape				

Detailed installation information should be referred to its Installation Manual.

PAC-KE-TB-F

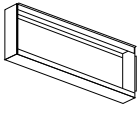
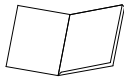





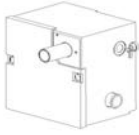

Item	① Screw	② Filter box	③ Installation manual	
Quantity	10/12*	1	1	
Shape				*PAC-KE250TB has 12 pieces of screw.

Detailed installation information should be referred to its Installation Manual.

7-3. Drain pump

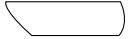
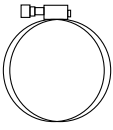

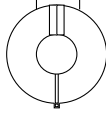
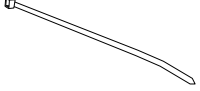

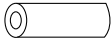
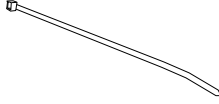

Drain pump is an optional part for VMS1L, and a standard for VMS1. When using drain pump, PAC-KE07DM-E (mounting type) is required.

PAC-KE07DM-E

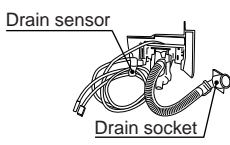
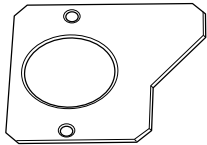
Item	① Drain pump	② Attachment	③ Drain hose 1 (385mm)	④ Pipe cover 1 (255mm)	⑤ Pipe cover 2 (200mm)
Quantity	1	1	1	1	1
Shape					
Item	⑥ Hose band	⑦ Screw	⑧ Clamp	⑨ Ferrite clamp	⑩ Band 1 (100mm)
Quantity	1	3	3	1	2
Shape					
Item	⑪ Drain hose 2 (175mm)	⑫ Pipe cover 3	⑬ Band 2 (380mm)		
Quantity	1	1	6		
Shape					

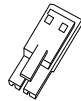
If drain water can not flow out the Indoor unit by gravity and gradient, a Drain-pump for draining is needed. Drain pump PAC-KE04DM-F can pump water up to 550mm [21-11/16 in.] high from the drain pan.

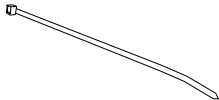

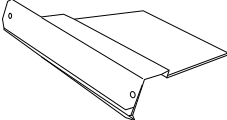
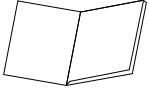

PAC-KE04DM-F

Item	① Drain pump ass'y	② Separator	③ Rubber plug	④ Connector	⑤ Dummy connector
Quantity	1	1	2	1	1
Shape					
Item	⑥ Rubber bushing	⑦ Band	⑧ PTT screw 4X10	⑨ Fixing plate	⑩ Installation manual
Quantity	1	2	6+1 (spare)	1	1
Shape					

Detailed installation information should be referred to its Installation Manual.

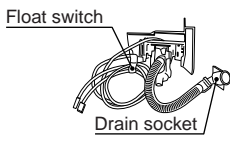
If drain water can not flow out the Indoor unit by gravity and gradient, a Drain-pump for draining is needed. Drain pump PAC-KE05DM-F can pump water up to 700mm [27-9/16 in.] high from the drain pan.

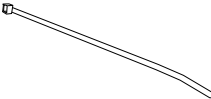

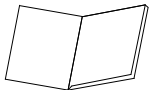















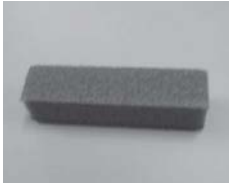

PAC-KE05DM-F

Item	① Drain pump ass'y	② Rubber plug	③ Rubber bushing	④ Band	⑤ PTT screw 4X10
Quantity	1	2	1	2	6+1 (spare)
Shape					
Item	⑥ Installation manual				
Quantity	1				
Shape					

Detailed installation information should be referred to its Installation Manual.

7-4. Control box replace kit

PAC-KE70HS-E

Parts	① PLATE A	② PLATE B	③ PLATE C	④ COVER A
Q'ty	1	1	1	1
Shape				
Parts	⑤ COVER B	⑥ LEAD WIRE MOTOR	⑦ LEAD WIRE LEV	⑧ LEAD WIRE THM A
Q'ty	1	1	1	1
Shape		 White 7-pin connector	 White 6-pin connector	 White 4-pin connector
Parts	⑨ LEAD WIRE THM B	⑩ LEAD WIRE EARTH	⑪ LEAD WIRE PUMP	⑫ LEAD WIRE FS
Q'ty	1	1	1	1
Shape	 Red 2-pin connector	 Ring terminal on both ends	 Blue 3-pin connector	 White 4-pin connector
Parts	⑬ INSULATOR	⑭ Connecting terminals	⑮ BAND	⑯ CLAMP
Q'ty	3	4	6	4
Shape				
Parts	⑰ SCREW 1	⑱ SCREW 2	⑲ SCREW 3	⑳ FERRITE CORE
Q'ty	2	4	5	1
Shape	 4X10	 4X10 with a washer	 5X10 with a washer	

When installing the control box replace kit on the air inlet on the unit, ⑫ LEAD WIRE FS is not used.

PEFY-P-VMA(L)-E, PEFY-P-VMA3-E

1. SPECIFICATIONS	1 - 48
2. EXTERNAL DIMENSIONS	1 - 54
3. CENTER OF GRAVITY	1 - 64
4. ELECTRICAL WIRING DIAGRAMS	1 - 65
5. SOUND LEVELS	1 - 67
5-1. Sound levels	1 - 67
5-2. NC curves	1 - 68
6. FAN CHARACTERISTICS CURVES.....	1 - 77
7. OPTIONAL PARTS.....	1 - 87
7-1. Optional parts line up for the Indoor unit.....	1 - 87
7-2. Filter box	1 - 87

1. SPECIFICATIONS

YKB/YLM

PEFY-VM(L), VMA3

Model			PEFY-P20VMA-E	PEFY-P25VMA-E	PEFY-P32VMA-E	PEFY-P40VMA-E	
Power source			1-phase 220-230-240V 50/60Hz	1-phase 220-230-240V 50/60Hz	1-phase 220-230-240V 50/60Hz	1-phase 220-230-240V 50/60Hz	
Cooling capacity (Nominal)	*1	kW	2.2	2.8	3.6	4.5	
	*1	kcal / h	1,900	2,400	3,100	3,900	
	*1	BTU / h	7,500	9,600	12,300	15,400	
	*2	Power input	kW	0.06	0.06	0.07	0.09
	*2	Current input	A	0.53	0.53	0.55	0.64
Heating capacity (Nominal)	*3	kW	2.5	3.2	4.0	5.0	
	*3	kcal / h	2,200	2,800	3,400	4,300	
	*3	BTU / h	8,500	10,900	13,600	17,100	
	*2	Power input	kW	0.04	0.04	0.05	0.07
	*2	Current input	A	0.42	0.42	0.44	0.53
External finish			Galvanized steel plate	Galvanized steel plate	Galvanized steel plate	Galvanized steel plate	
External dimension HxWxD			mm	250 x 700 x 732	250 x 700 x 732	250 x 700 x 732	
			inch	9-7/8 x 27-9/16 x 28-7/8	9-7/8 x 27-9/16 x 28-7/8	9-7/8 x 27-9/16 x 28-7/8	9-7/8 x 35-7/16 x 28-7/8
Net weight			kg(lbs)	23(51)	23(51)	23(51)	
Heat exchanger			Cross fin(Aluminum fin and copper tube)	Cross fin(Aluminum fin and copper tube)	Cross fin(Aluminum fin and copper tube)	Cross fin(Aluminum fin and copper tube)	
FAN	Type x Quantity		Sirocco fan x 1	Sirocco fan x 1	Sirocco fan x 1	Sirocco fan x 1	
	*4	External static press.	Pa	<35> - 50 - <70> - <100> - <150>	<35> - 50 - <70> - <100> - <150>	<35> - 50 - <70> - <100> - <150>	<35> - 50 - <70> - <100> - <150>
			mmH ₂ O	<3.6> - 5.1 - <7.1> - <10.2> - <15.3>	<3.6> - 5.1 - <7.1> - <10.2> - <15.3>	<3.6> - 5.1 - <7.1> - <10.2> - <15.3>	<3.6> - 5.1 - <7.1> - <10.2> - <15.3>
	Motor Type		DC motor	DC motor	DC motor	DC motor	
	Motor output		kW	0.085	0.085	0.085	0.085
	Driving mechanism		Direct-driven by motor	Direct-driven by motor	Direct-driven by motor	Direct-driven by motor	
	Air flow rate		(Low-Mid-High)				
			m ³ / min	6.0 - 7.5 - 8.5	6.0 - 7.5 - 8.5	7.5 - 9.0 - 10.5	10.0 - 12.0 - 14.0
L/s			100 - 125 - 142	100 - 125 - 142	125 - 150 - 175	167 - 200 - 233	
		cfm	212 - 265 - 300	212 - 265 - 300	265 - 318 - 371	353 - 424 - 494	
Sound pressure level (measured in anechoic room)			(Low-Mid-High)	(Low-Mid-High)	(Low-Mid-High)	(Low-Mid-High)	
		*2 *5	dB <A>	26-28-29	26-28-29	28-30-34	
		*2 *6	dB <A>	23-25-26	23-25-26	23-26-29	
Insulation material			EPS, Polyethylene foam, Urethane foam	EPS, Polyethylene foam, Urethane foam	EPS, Polyethylene foam, Urethane foam	EPS, Polyethylene foam, Urethane foam	
Air filter			PP honeycomb fabric.	PP honeycomb fabric.	PP honeycomb fabric.	PP honeycomb fabric.	
Protection device			Fuse	Fuse	Fuse	Fuse	
Refrigerant control device			LEV	LEV	LEV	LEV	
Connectable outdoor unit			R410A CITY MULTI	R410A CITY MULTI	R410A CITY MULTI	R410A CITY MULTI	
Diameter of refrigerant pipe	Liquid (R410A)	mm(in.)	6.35(1/4)Braze	6.35(1/4)Braze	6.35(1/4)Braze	6.35(1/4)Braze	
	Gas (R410A)	mm(in.)	12.7(1/2)Braze	12.7(1/2)Braze	12.7(1/2)Braze	12.7(1/2)Braze	
Field drain pipe size			mm(in.)	O.D.32(1-1/4)	O.D.32(1-1/4)	O.D.32(1-1/4)	
Drawing	External		IU-KB94-R528	IU-KB94-R528	IU-KB94-R528	IU-KB94-R528	
	Wiring		IU-KB94-R069	IU-KB94-R069	IU-KB94-R069	IU-KB94-R069	
	Refrigerant cycle		-	-	-	-	
Standard attachment	Document		Installation Manual, Instruction Book	Installation Manual, Instruction Book	Installation Manual, Instruction Book	Installation Manual, Instruction Book	
	Accessory		Insulation pipe for refrigerant pipe, Washer, Drain hose, Tie band	Insulation pipe for refrigerant pipe, Washer, Drain hose, Tie band	Insulation pipe for refrigerant pipe, Washer, Drain hose, Tie band	Insulation pipe for refrigerant pipe, Washer, Drain hose, Tie band	
Optional parts	Filter box		PAC-KE91TB-E	PAC-KE91TB-E	PAC-KE91TB-E	PAC-KE92TB-E	
Remarks			* Details on foundation work, duct work, insulation work, electrical wiring, power source switch, and other items shall be referred to the Installation Manual. * Due to continuing improvement, above specifications may be subject to change without notice.				

Notes:	Unit converter
1.Nominal cooling conditions Indoor:27°CDB/19°CWB(81°FDB/66°FWB), Outdoor:35°CDB(95°FDB) Pipe length:7.5m(24-9/16ft.), Level difference:0m(0ft.)	kcal/h =kW x 860 BTU/h =kW x 3,412 cfm =m ³ /min x 35.31 lbs =kg / 0.4536
2.The values are measured at the factory setting of external static pressure.	
3.Nominal heating conditions Indoor:20°CDB(68°FDB), Outdoor:7°CDB/6°CWB(45°FDB/43°FWB) Pipe length:7.5m(24-9/16ft.), Level difference:0m(0ft.)	
4.The factory setting of external static pressure is shown without < > . Refer to "Fan characteristics curves", according to the external static pressure, in DATA BOOK for the usable range of air flow rate.	
5.Measured in anechoic room with a 1m air inlet duct and 2m air outlet duct attached to the unit and 1.5m below the unit. Refer to 5-1-1 for details.	*Above specification data is subject to rounding variation.
6.Measured in anechoic room with a 2m air inlet duct and 2m air outlet duct attached to the unit and 1.5m below the unit. Refer to 5-1-2 for details.	

1. SPECIFICATIONS

YKB/YLM

PEFY-VMA(L), VMA3

Model			PEFY-P50VMA-E	PEFY-P63VMA-E	PEFY-P71VMA-E	PEFY-P80VMA-E	
Power source			1-phase 220-230-240V 50/60Hz	1-phase 220-230-240V 50/60Hz	1-phase 220-230-240V 50/60Hz	1-phase 220-230-240V 50/60Hz	
Cooling capacity (Nominal)	*1	kW	5.6	7.1	8.0	9.0	
		kcal / h	4,800	6,100	6,900	7,700	
		BTU / h	19,100	24,200	27,300	30,700	
	*2	Power input	kW	0.11	0.12	0.14	0.14
		Current input	A	0.74	1.01	1.15	1.15
	Heating capacity (Nominal)	*3	kW	6.3	8.0	9.0	10.0
kcal / h			5,400	6,900	7,700	8,600	
BTU / h			21,500	27,300	30,700	34,100	
*2		Power input	kW	0.09	0.10	0.12	0.12
		Current input	A	0.63	0.90	1.04	1.04
External finish			Galvanized steel plate	Galvanized steel plate	Galvanized steel plate	Galvanized steel plate	
External dimension HxWxD			mm	250 x 900 x 732	250 x 1,100 x 732	250 x 1,100 x 732	
			inch	9-7/8 x 35-7/16 x 28-7/8	9-7/8 x 43-5/16 x 28-7/8	9-7/8 x 43-5/16 x 28-7/8	9-7/8 x 43-5/16 x 28-7/8
Net weight			kg(lbs)	26(58)	32(71)	32(71)	
Heat exchanger			Cross fin(Aluminum fin and copper tube)	Cross fin(Aluminum fin and copper tube)	Cross fin(Aluminum fin and copper tube)	Cross fin(Aluminum fin and copper tube)	
FAN			Sirocco fan x 1	Sirocco fan x 2	Sirocco fan x 2	Sirocco fan x 2	
*4	Type x Quantity		Sirocco fan x 1	Sirocco fan x 2	Sirocco fan x 2	Sirocco fan x 2	
	External static press.	Pa	<35> - 50 - <70> - <100> - <150>	<35> - 50 - <70> - <100> - <150>	<35> - 50 - <70> - <100> - <150>	<35> - 50 - <70> - <100> - <150>	
		mmH ₂ O	<3.6> - 5.1 - <7.1> - <10.2> - <15.3>	<3.6> - 5.1 - <7.1> - <10.2> - <15.3>	<3.6> - 5.1 - <7.1> - <10.2> - <15.3>	<3.6> - 5.1 - <7.1> - <10.2> - <15.3>	
	Motor Type		DC motor	DC motor	DC motor	DC motor	
	Motor output		kW	0.085	0.121	0.121	0.121
	Driving mechanism		Direct-driven by motor	Direct-driven by motor	Direct-driven by motor	Direct-driven by motor	
	Air flow rate		(Low-Mid-High)				
			m ³ / min	12.0 - 14.5 - 17.0	13.5 - 16.0 - 19.0	14.5 - 18.0 - 21.0	14.5 - 18.0 - 21.0
			L/s	200 - 242 - 283	225 - 267 - 317	242 - 300 - 350	242 - 300 - 350
			cfm	424 - 512 - 600	477 - 565 - 671	512 - 636 - 742	512 - 636 - 742
Sound pressure level (measured in anechoic room)			(Low-Mid-High)	(Low-Mid-High)	(Low-Mid-High)	(Low-Mid-High)	
*2 *5	dB <A>		28-32-35	29-32-36	30-34-38	30-34-38	
	dB <A>		25-29-32	25-29-33	26-29-34	26-29-34	
Insulation material			EPS, Polyethylene foam, Urethane foam	EPS, Polyethylene foam, Urethane foam	EPS, Polyethylene foam, Urethane foam	EPS, Polyethylene foam, Urethane foam	
Air filter			PP honeycomb fabric.	PP honeycomb fabric.	PP honeycomb fabric.	PP honeycomb fabric.	
Protection device			Fuse	Fuse	Fuse	Fuse	
Refrigerant control device			LEV	LEV	LEV	LEV	
Connectable outdoor unit			R410A CITY MULTI	R410A CITY MULTI	R410A CITY MULTI	R410A CITY MULTI	
Diameter of refrigerant pipe	Liquid (R410A)	mm(in.)	6.35(1/4)Braze	9.52(3/8)Braze	9.52(3/8)Braze	9.52(3/8)Braze	
	Gas (R410A)	mm(in.)	12.7(1/2)Braze	15.88(5/8)Braze	15.88(5/8)Braze	15.88(5/8)Braze	
Field drain pipe size			mm(in.)	O.D.32(1-1/4)	O.D.32(1-1/4)	O.D.32(1-1/4)	
Drawing	External		IU-KB94-R528	IU-KB94-R528	IU-KB94-R528	IU-KB94-R528	
	Wiring		IU-KB94-R069	IU-KB94-R069	IU-KB94-R069	IU-KB94-R069	
	Refrigerant cycle		-	-	-	-	
Standard attachment	Document		Installation Manual, Instruction Book	Installation Manual, Instruction Book	Installation Manual, Instruction Book	Installation Manual, Instruction Book	
	Accessory		Insulation pipe for refrigerant pipe, Washer, Drain hose, Tie band	Insulation pipe for refrigerant pipe, Washer, Drain hose, Tie band	Insulation pipe for refrigerant pipe, Washer, Drain hose, Tie band	Insulation pipe for refrigerant pipe, Washer, Drain hose, Tie band	
Optional parts	Filter box		PAC-KE92TB-E	PAC-KE93TB-E	PAC-KE93TB-E	PAC-KE93TB-E	
Remarks			* Details on foundation work, duct work, insulation work, electrical wiring, power source switch, and other items shall be referred to the Installation Manual. * Due to continuing improvement, above specifications may be subject to change without notice.				

Notes:	1.Nominal cooling conditions Indoor:27°CDB/19°CWB(81°FDB/66°FWB), Outdoor:35°CDB(95°FDB) Pipe length:7.5m(24-9/16ft.), Level difference:0m(0ft.)	Unit converter kcal/h =kW x 860 BTU/h =kW x 3,412 cfm =m ³ /min x 35.31 lbs =kg / 0.4536
	2.The values are measured at the factory setting of external static pressure.	
	3.Nominal heating conditions Indoor:20°CDB(68°FDB), Outdoor:7°CDB/6°CWB(45°FDB/43°FWB) Pipe length:7.5m(24-9/16ft.), Level difference:0m(0ft.)	
	4.The factory setting of external static pressure is shown without < > . Refer to "Fan characteristics curves", according to the external static pressure, in DATA BOOK for the usable range of air flow rate.	
	5.Measured in anechoic room with a 1m air inlet duct and 2m air outlet duct attached to the unit and 1.5m below the unit. Refer to 5-1-1 for details.	
	6.Measured in anechoic room with a 2m air inlet duct and 2m air outlet duct attached to the unit and 1.5m below the unit. Refer to 5-1-2 for details.	
		*Above specification data is subject to rounding variation.

1. SPECIFICATIONS

YKB/YLM

PEFY-VM(A,L), VMA3

Model			PEFY-P100VMA-E	PEFY-P125VMA-E	PEFY-P140VMA-E	PEFY-P20VMA3-E	
Power source			1-phase 220-230-240V 50/60Hz	1-phase 220-230-240V 50/60Hz	1-phase 220-230-240V 50/60Hz	1-phase 220-230-240V 50/60Hz	
Cooling capacity (Nominal)	*1	kW	11.2	14.0	16.0	2.2	
	*1	kcal / h	9,600	12,000	13,800	1,900	
	*1	BTU / h	38,200	47,800	54,600	7,500	
	*2	Power input	kW	0.24	0.34	0.36	0.110
	*2	Current input	A	1.47	2.05	2.21	0.90
Heating capacity (Nominal)	*3	kW	12.5	16.0	18.0	2.5	
	*3	kcal / h	10,800	13,800	15,500	2,200	
	*3	BTU / h	42,700	54,600	61,400	8,500	
	*2	Power input	kW	0.22	0.32	0.34	0.090
	*2	Current input	A	1.36	1.94	2.10	0.79
External finish			Galvanized steel plate	Galvanized steel plate	Galvanized steel plate	Galvanized steel plate	
External dimension HxWxD			mm	250 x 1,400 x 732	250 x 1,400 x 732	250 x 1,600 x 732	
			inch	9-7/8 x 55-1/8 x 28-7/8	9-7/8 x 55-1/8 x 28-7/8	9-7/8 x 63 x 28-7/8	9-7/8 x 35-7/16 x 28-7/8
Net weight			kg(lbs)	42(93)	42(93)	46(102)	
Heat exchanger			Cross fin(Aluminum fin and copper tube)	Cross fin(Aluminum fin and copper tube)	Cross fin(Aluminum fin and copper tube)	Cross fin(Aluminum fin and copper tube)	
FAN			Sirocco fan x 2	Sirocco fan x 2	Sirocco fan x 2	Sirocco fan x 1	
*4	Type x Quantity		Sirocco fan x 2	Sirocco fan x 2	Sirocco fan x 2	Sirocco fan x 1	
	External static press.	Pa	<35> - 50 - <70> - <100> - <150>	<35> - 50 - <70> - <100> - <150>	<35> - 50 - <70> - <100> - <150>	<35> - 50 - <70> - <100> - <125>	
		mmH ₂ O	<3.6> - 5.1 - <7.1> - <10.2> - <15.3>	<3.6> - 5.1 - <7.1> - <10.2> - <15.3>	<3.6> - 5.1 - <7.1> - <10.2> - <15.3>	<3.6> - 5.1 - <7.1> - <10.2> - <12.7>	
	Motor Type		DC motor	DC motor	DC motor	DC motor	
	Motor output		kW	0.244	0.244	0.244	0.085
	Driving mechanism		Direct-driven by motor*	Direct-driven by motor	Direct-driven by motor	Direct-driven by motor	
	Air flow rate		(Low-Mid-High)	(Low-Mid-High)	(Low-Mid-High)	(Low-Mid-High)	
			m ³ / min	23.0 - 28.0 - 33.0	28.0 - 34.0 - 40.0	29.5 - 35.5 - 42.0	12.0 - 14.5 - 17.0
L/s			383 - 467 - 550	467 - 567 - 667	492 - 592 - 700	200 - 242 - 283	
		cfm	812 - 989 - 1,165	989 - 1,201 - 1,412	1,042 - 1,254 - 1,483	424 - 512 - 600	
Sound pressure level (measured in anechoic room)			(Low-Mid-High)	(Low-Mid-High)	(Low-Mid-High)	(Low-Mid-High)	
*2 *5	dB <A>		32-37-41	35-40-44	36-41-45	30-35-39	
	dB <A>		28-33-37	32-36-40	33-37-42	-	
Insulation material			EPS, Polyethylene foam, Urethane foam	EPS, Polyethylene foam, Urethane foam	EPS, Polyethylene foam, Urethane foam	EPS, Polyethylene foam, Urethane foam	
Air filter			PP honeycomb fabric.	PP honeycomb fabric.	PP honeycomb fabric.	PP honeycomb fabric.	
Protection device			Fuse	Fuse	Fuse	Fuse	
Refrigerant control device			LEV	LEV	LEV	-	
Connectable outdoor unit			R410A CITY MULTI	R410A CITY MULTI	R410A CITY MULTI	-	
Diameter of refrigerant pipe	Liquid (R410A)	mm(in.)	9.52(3/8)Braze	9.52(3/8)Braze	9.52(3/8)Braze	6.35 (1/4)Flare	
	Gas (R410A)	mm(in.)	15.88(5/8)Braze	15.88(5/8)Braze	15.88(5/8)Braze	12.7 (1/2)Flare	
Field drain pipe size			mm(in.)	O.D.32(1-1/4)	O.D.32(1-1/4)	O.D.32 (1-1/4)	
Drawing	External		IU-KB94-R528	IU-KB94-R528	IU-KB94-R528	-	
	Wiring		IU-KB94-R069	IU-KB94-R069	IU-KB94-R069	-	
	Refrigerant cycle		-	-	-	-	
Standard attachment	Document		Installation Manual, Instruction Book	Installation Manual, Instruction Book	Installation Manual, Instruction Book	Installation Manual, Instruction Book	
	Accessory		Insulation pipe for refrigerant pipe, Washer, Drain hose, Tie band	Insulation pipe for refrigerant pipe, Washer, Drain hose, Tie band	Insulation pipe for refrigerant pipe, Washer, Drain hose, Tie band	Insulation pipe for refrigerant pipe, Washer, Drain hose, Tie band	
Optional parts	Filter box		PAC-KE94TB-E	PAC-KE94TB-E	PAC-KE95TB-E	PAC-KE92TB-E	
Remarks			* Details on foundation work, duct work, insulation work, electrical wiring, power source switch, and other items shall be referred to the Installation Manual. * Due to continuing improvement, above specifications may be subject to change without notice.				

Notes:	Unit converter
1.Nominal cooling conditions Indoor:27°CDB/19°CWB(81°FDB/66°FWB), Outdoor:35°CDB(95°FDB) Pipe length:7.5m(24-9/16ft.), Level difference:0m(0ft.)	kcal/h =kW x 860 BTU/h =kW x 3,412 cfm =m ³ /min x 35.31 lbs =kg / 0.4536
2.The values are measured at the factory setting of external static pressure.	
3.Nominal heating conditions Indoor:20°CDB(68°FDB), Outdoor:7°CDB/6°CWB(45°FDB/43°FWB) Pipe length:7.5m(24-9/16ft.), Level difference:0m(0ft.)	
4.The factory setting of external static pressure is shown without < >. Refer to "Fan characteristics curves", according to the external static pressure, in DATA BOOK for the usable range of air flow rate.	
5.Measured in anechoic room with a 1m air inlet duct and 2m air outlet duct attached to the unit and 1.5m below the unit. Refer to 5-1-1 for details.	*Above specification data is subject to rounding variation.
6.Measured in anechoic room with a 2m air inlet duct and 2m air outlet duct attached to the unit and 1.5m below the unit. Refer to 5-1-2 for details.	

1. SPECIFICATIONS

YKB/YLM

PEFY-VMA(L), VMA3

Model			PEFY-P20VMAL-E	PEFY-P25VMAL-E	PEFY-P32VMAL-E	PEFY-P40VMAL-E	
Power source			1-phase 220-230-240V 50/60Hz	1-phase 220-230-240V 50/60Hz	1-phase 220-230-240V 50/60Hz	1-phase 220-230-240V 50/60Hz	
Cooling capacity (Nominal)	*1	kW	2.2	2.8	3.6	4.5	
		kcal / h	1,900	2,400	3,100	3,900	
		BTU / h	7,500	9,600	12,300	15,400	
	*2	Power input	kW	0.04	0.04	0.05	0.07
		Current input	A	0.42	0.42	0.44	0.53
	Heating capacity (Nominal)	*3	kW	2.5	3.2	4.0	5.0
kcal / h			2,200	2,800	3,400	4,300	
BTU / h			8,500	10,900	13,600	17,100	
*2		Power input	kW	0.04	0.04	0.05	0.07
		Current input	A	0.42	0.42	0.44	0.53
External finish			Galvanized steel plate	Galvanized steel plate	Galvanized steel plate	Galvanized steel plate	
External dimension HxWxD			mm	250 x 700 x 732	250 x 700 x 732	250 x 700 x 732	
			inch	9-7/8 x 27-9/16 x 28-7/8	9-7/8 x 27-9/16 x 28-7/8	9-7/8 x 27-9/16 x 28-7/8	9-7/8 x 35-7/16 x 28-7/8
Net weight			kg(lbs)	22(49)	22(49)	25(56)	
Heat exchanger			Cross fin(Aluminum fin and copper tube)	Cross fin(Aluminum fin and copper tube)	Cross fin(Aluminum fin and copper tube)	Cross fin(Aluminum fin and copper tube)	
FAN			Sirocco fan x 1	Sirocco fan x 1	Sirocco fan x 1	Sirocco fan x 1	
*4	Type x Quantity		Sirocco fan x 1	Sirocco fan x 1	Sirocco fan x 1	Sirocco fan x 1	
	External static press.	Pa	<35> - 50 - <70> - <100> - <150>	<35> - 50 - <70> - <100> - <150>	<35> - 50 - <70> - <100> - <150>	<35> - 50 - <70> - <100> - <150>	
		mmH ₂ O	<3.6> - 5.1 - <7.1> - <10.2> - <15.3>	<3.6> - 5.1 - <7.1> - <10.2> - <15.3>	<3.6> - 5.1 - <7.1> - <10.2> - <15.3>	<3.6> - 5.1 - <7.1> - <10.2> - <15.3>	
	Motor Type		DC motor	DC motor	DC motor	DC motor	
	Motor output		kW	0.085	0.085	0.085	0.085
	Driving mechanism		Direct-driven by motor	Direct-driven by motor	Direct-driven by motor	Direct-driven by motor	
	Air flow rate		(Low-Mid-High)				
			m ³ / min	6.0 - 7.5 - 8.5	6.0 - 7.5 - 8.5	7.5 - 9.0 - 10.5	10.0 - 12.0 - 14.0
			L/s	100 - 125 - 142	100 - 125 - 142	125 - 150 - 175	167 - 200 - 233
			cfm	212 - 265 - 300	212 - 265 - 300	265 - 318 - 371	353 - 424 - 494
Sound pressure level (measured in anechoic room)			(Low-Mid-High)	(Low-Mid-High)	(Low-Mid-High)	(Low-Mid-High)	
*2 *5	dB <A>		26-28-29	26-28-29	28-30-34	28-30-34	
	dB <A>		23-25-26	23-25-26	23-26-29	23-27-30	
Insulation material			EPS, Polyethylene foam, Urethane foam	EPS, Polyethylene foam, Urethane foam	EPS, Polyethylene foam, Urethane foam	EPS, Polyethylene foam, Urethane foam	
Air filter			PP honeycomb fabric.	PP honeycomb fabric.	PP honeycomb fabric.	PP honeycomb fabric.	
Protection device			Fuse	Fuse	Fuse	Fuse	
Refrigerant control device			LEV	LEV	LEV	LEV	
Connectable outdoor unit			R410A CITY MULTI	R410A CITY MULTI	R410A CITY MULTI	R410A CITY MULTI	
Diameter of refrigerant pipe	Liquid (R410A)	mm(in.)	6.35(1/4)Braze	6.35(1/4)Braze	6.35(1/4)Braze	6.35(1/4)Braze	
	Gas (R410A)	mm(in.)	12.7(1/2)Braze	12.7(1/2)Braze	12.7(1/2)Braze	12.7(1/2)Braze	
Field drain pipe size			mm(in.)	O.D.32(1-1/4)	O.D.32(1-1/4)	O.D.32(1-1/4)	
Drawing	External		IU-KB94-R548	IU-KB94-R548	IU-KB94-R548	IU-KB94-R548	
	Wiring		IU-KB94-R069	IU-KB94-R069	IU-KB94-R069	IU-KB94-R069	
	Refrigerant cycle		-	-	-	-	
Standard attachment	Document		Installation Manual, Instruction Book	Installation Manual, Instruction Book	Installation Manual, Instruction Book	Installation Manual, Instruction Book	
	Accessory		Insulation pipe for refrigerant pipe, Washer, Drain hose, Tie band	Insulation pipe for refrigerant pipe, Washer, Drain hose, Tie band	Insulation pipe for refrigerant pipe, Washer, Drain hose, Tie band	Insulation pipe for refrigerant pipe, Washer, Drain hose, Tie band	
Optional parts	Filter box		PAC-KE91TB-E	PAC-KE91TB-E	PAC-KE91TB-E	PAC-KE92TB-E	
Remarks			* Details on foundation work, duct work, insulation work, electrical wiring, power source switch, and other items shall be referred to the Installation Manual. * Due to continuing improvement, above specifications may be subject to change without notice.				

Notes:	Unit converter
1.Nominal cooling conditions Indoor:27°CDB/19°CWB(81°FDB/66°FWB), Outdoor:35°CDB(95°FDB) Pipe length:7.5m(24-9/16ft.), Level difference:0m(0ft.)	kcal/h =kW x 860 BTU/h =kW x 3,412 cfm =m ³ /min x 35.31 lbs =kg / 0.4536
2.The values are measured at the factory setting of external static pressure.	
3.Nominal heating conditions Indoor:20°CDB(68°FDB), Outdoor:7°CDB/6°CWB(45°FDB/43°FWB) Pipe length:7.5m(24-9/16ft.), Level difference:0m(0ft.)	
4.The factory setting of external static pressure is shown without < > . Refer to "Fan characteristics curves", according to the external static pressure, in DATA BOOK for the usable range of air flow rate.	
5.Measured in anechoic room with a 1m air inlet duct and 2m air outlet duct attached to the unit and 1.5m below the unit. Refer to 5-1-1 for details.	*Above specification data is subject to rounding variation.
6.Measured in anechoic room with a 2m air inlet duct and 2m air outlet duct attached to the unit and 1.5m below the unit. Refer to 5-1-2 for details.	

1. SPECIFICATIONS

YKB/YLM

PEFY-VM(L), VMA3

Model			PEFY-P50VMAL-E	PEFY-P63VMAL-E	PEFY-P71VMAL-E	PEFY-P80VMAL-E	
Power source			1-phase 220-230-240V 50/60Hz	1-phase 220-230-240V 50/60Hz	1-phase 220-230-240V 50/60Hz	1-phase 220-230-240V 50/60Hz	
Cooling capacity (Nominal)	*1	kW	5.6	7.1	8.0	9.0	
		kcal / h	4,800	6,100	6,900	7,700	
		BTU / h	19,100	24,200	27,300	30,700	
	*2	Power input	kW	0.09	0.10	0.12	0.12
	*2	Current input	A	0.63	0.90	1.04	1.04
Heating capacity (Nominal)	*3	kW	6.3	8.0	9.0	10.0	
		kcal / h	5,400	6,900	7,700	8,600	
		BTU / h	21,500	27,300	30,700	34,100	
	*2	Power input	kW	0.09	0.10	0.12	0.12
	*2	Current input	A	0.63	0.90	1.04	1.04
External finish			Galvanized steel plate	Galvanized steel plate	Galvanized steel plate	Galvanized steel plate	
External dimension HxWxD			mm	250 x 900 x 732	250 x 1,100 x 732	250 x 1,100 x 732	
			inch	9-7/8 x 35-7/16 x 28-7/8	9-7/8 x 43-5/16 x 28-7/8	9-7/8 x 43-5/16 x 28-7/8	9-7/8 x 43-5/16 x 28-7/8
Net weight			kg(lbs)	25(56)	31(69)	31(69)	
Heat exchanger			Cross fin(Aluminum fin and copper tube)	Cross fin(Aluminum fin and copper tube)	Cross fin(Aluminum fin and copper tube)	Cross fin(Aluminum fin and copper tube)	
FAN	Type x Quantity		Sirocco fan x 1	Sirocco fan x 2	Sirocco fan x 2	Sirocco fan x 2	
	*4	External static press.	Pa	<35> - 50 - <70> - <100> - <150>	<35> - 50 - <70> - <100> - <150>	<35> - 50 - <70> - <100> - <150>	<35> - 50 - <70> - <100> - <150>
			mmH ₂ O	<3.6> - 5.1 - <7.1> - <10.2> - <15.3>	<3.6> - 5.1 - <7.1> - <10.2> - <15.3>	<3.6> - 5.1 - <7.1> - <10.2> - <15.3>	<3.6> - 5.1 - <7.1> - <10.2> - <15.3>
	Motor Type		DC motor	DC motor	DC motor	DC motor	
	Motor output		kW	0.085	0.121	0.121	0.121
	Driving mechanism		Direct-driven by motor	Direct-driven by motor	Direct-driven by motor	Direct-driven by motor	
	Air flow rate		(Low-Mid-High)		(Low-Mid-High)	(Low-Mid-High)	(Low-Mid-High)
			m ³ / min	12.0 - 14.5 - 17.0	13.5 - 16.0 - 19.0	14.5 - 18.0 - 21.0	14.5 - 18.0 - 21.0
			L/s	200 - 242 - 283	225 - 267 - 317	242 - 300 - 350	242 - 300 - 350
			cfm	424 - 512 - 600	477 - 565 - 671	512 - 636 - 742	512 - 636 - 742
Sound pressure level (measured in anechoic room)			(Low-Mid-High)	(Low-Mid-High)	(Low-Mid-High)	(Low-Mid-High)	
*2 *5	dB <A>	28-32-35		29-32-36	30-34-38	30-34-38	
		25-29-32		25-29-32	26-29-34	26-29-34	
Insulation material			EPS, Polyethylene foam, Urethane foam	EPS, Polyethylene foam, Urethane foam	EPS, Polyethylene foam, Urethane foam	EPS, Polyethylene foam, Urethane foam	
Air filter			PP honeycomb fabric.	PP honeycomb fabric.	PP honeycomb fabric.	PP honeycomb fabric.	
Protection device			Fuse	Fuse	Fuse	Fuse	
Refrigerant control device			LEV	LEV	LEV	LEV	
Connectable outdoor unit			R410A CITY MULTI	R410A CITY MULTI	R410A CITY MULTI	R410A CITY MULTI	
Diameter of refrigerant pipe	Liquid (R410A)	mm(in.)	6.35(1/4)Braze	9.52(3/8)Braze	9.52(3/8)Braze	9.52(3/8)Braze	
	Gas (R410A)	mm(in.)	12.7(1/2)Braze	15.88(5/8)Braze	15.88(5/8)Braze	15.88(5/8)Braze	
Field drain pipe size			mm(in.)	O.D.32(1-1/4)	O.D.32(1-1/4)	O.D.32(1-1/4)	
Drawing	External		IU-KB94-R548	IU-KB94-R548	IU-KB94-R548	IU-KB94-R548	
	Wiring		IU-KB94-R069	IU-KB94-R069	IU-KB94-R069	IU-KB94-R069	
	Refrigerant cycle		-	-	-	-	
Standard attachment	Document		Installation Manual, Instruction Book	Installation Manual, Instruction Book	Installation Manual, Instruction Book	Installation Manual, Instruction Book	
	Accessory		Insulation pipe for refrigerant pipe, Washer, Drain hose, Tie band	Insulation pipe for refrigerant pipe, Washer, Drain hose, Tie band	Insulation pipe for refrigerant pipe, Washer, Drain hose, Tie band	Insulation pipe for refrigerant pipe, Washer, Drain hose, Tie band	
Optional parts	Filter box		PAC-KE92TB-E	PAC-KE93TB-E	PAC-KE93TB-E	PAC-KE93TB-E	
Remarks			* Details on foundation work, duct work, insulation work, electrical wiring, power source switch, and other items shall be referred to the Installation Manual. * Due to continuing improvement, above specifications may be subject to change without notice.				

Notes:	Unit converter
1.Nominal cooling conditions Indoor:27°CDB/19°CWB(81°FDB/66°FWB), Outdoor:35°CDB(95°FDB) Pipe length:7.5m(24-9/16ft.), Level difference:0m(0ft.)	kcal/h =kW x 860 BTU/h =kW x 3,412 cfm =m ³ /min x 35.31 lbs =kg / 0.4536
2.The values are measured at the factory setting of external static pressure.	
3.Nominal heating conditions Indoor:20°CDB(68°FDB), Outdoor:7°CDB/6°CWB(45°FDB/43°FWB) Pipe length:7.5m(24-9/16ft.), Level difference:0m(0ft.)	
4.The factory setting of external static pressure is shown without < >. Refer to "Fan characteristics curves", according to the external static pressure, in DATA BOOK for the usable range of air flow rate.	
5.Measured in anechoic room with a 1m air inlet duct and 2m air outlet duct attached to the unit and 1.5m below the unit. Refer to 5-1-1 for details.	*Above specification data is subject to rounding variation.
6.Measured in anechoic room with a 2m air inlet duct and 2m air outlet duct attached to the unit and 1.5m below the unit. Refer to 5-1-2 for details.	

1. SPECIFICATIONS

Model			PEFY-P100VMAL-E	PEFY-P125VMAL-E	PEFY-P140VMAL-E	
Power source			1-phase 220-230-240V 50/60Hz	1-phase 220-230-240V 50/60Hz	1-phase 220-230-240V 50/60Hz	
Cooling capacity (Nominal)	*1	kW	11.2	14.0	16.0	
		kcal / h	9,600	12,000	13,800	
		BTU / h	38,200	47,800	54,600	
	*2	Power input	kW	0.22	0.32	0.34
		Current input	A	1.36	1.94	2.10
	Heating capacity (Nominal)	*3	kW	12.5	16.0	18.0
kcal / h			10,800	13,800	15,500	
BTU / h			42,700	54,600	61,400	
*2		Power input	kW	0.22	0.32	0.34
		Current input	A	1.36	1.94	2.10
External finish			Galvanized steel plate	Galvanized steel plate	Galvanized steel plate	
External dimension HxWxD			mm	250 x 1,400 x 732	250 x 1,400 x 732	
			inch	9-7/8 x 55-1/8 x 28-7/8	9-7/8 x 55-1/8 x 28-7/8	9-7/8 x 63 x 28-7/8
Net weight			kg(lbs)	41(91)	45(100)	
Heat exchanger			Cross fin(Aluminum fin and copper tube)	Cross fin(Aluminum fin and copper tube)	Cross fin(Aluminum fin and copper tube)	
FAN	Type x Quantity		Sirocco fan x 2	Sirocco fan x 2	Sirocco fan x 2	
	*4	External static press.	Pa	<35> - 50 - <70> - <100> - <150>	<35> - 50 - <70> - <100> - <150>	<35> - 50 - <70> - <100> - <150>
			mmH ₂ O	<3.6> - 5.1 - <7.1> - <10.2> - <15.3>	<3.6> - 5.1 - <7.1> - <10.2> - <15.3>	<3.6> - 5.1 - <7.1> - <10.2> - <15.3>
	Motor Type		DC motor	DC motor	DC motor	
	Motor output		kW	0.244	0.244	0.244
	Driving mechanism		Direct-driven by motor	Direct-driven by motor	Direct-driven by motor	
	Air flow rate		(Low-Mid-High)			
			m ³ / min	23.0 - 28.0 - 33.0	28.0 - 34.0 - 40.0	29.5 - 35.5 - 42.0
			L/s	383 - 467 - 550	467 - 567 - 667	492 - 592 - 700
			cfm	812 - 989 - 1,165	989 - 1,201 - 1,412	1,042 - 1,254 - 1,483
Sound pressure level (measured in anechoic room)			(Low-Mid-High)	(Low-Mid-High)	(Low-Mid-High)	
*2	*5	dB <A>	32-37-41	35-40-44	36-41-45	
	*6	dB <A>	28-33-37	32-36-40	33-37-42	
Insulation material			EPS, Polyethylene foam, Urethane foam	EPS, Polyethylene foam, Urethane foam	EPS, Polyethylene foam, Urethane foam	
Air filter			PP honeycomb fabric.	PP honeycomb fabric.	PP honeycomb fabric.	
Protection device			Fuse	Fuse	Fuse	
Refrigerant control device			LEV	LEV	LEV	
Connectable outdoor unit			R410A CITY MULTI	R410A CITY MULTI	R410A CITY MULTI	
Diameter of refrigerant pipe	Liquid (R410A)	mm(in.)	9.52(3/8)Braze	9.52(3/8)Braze	9.52(3/8)Braze	
	Gas (R410A)	mm(in.)	15.88(5/8)Braze	15.88(5/8)Braze	15.88(5/8)Braze	
Field drain pipe size			mm(in.)	O.D.32(1-1/4)	O.D.32(1-1/4)	
Drawing	External		IU-KB94-R548	IU-KB94-R548	IU-KB94-R548	
	Wiring		IU-KB94-R069	IU-KB94-R069	IU-KB94-R069	
	Refrigerant cycle		-	-	-	
Standard attachment	Document		Installation Manual, Instruction Book	Installation Manual, Instruction Book	Installation Manual, Instruction Book	
	Accessory		Insulation pipe for refrigerant pipe, Washer, Drain hose, Tie band	Insulation pipe for refrigerant pipe, Washer, Drain hose, Tie band	Insulation pipe for refrigerant pipe, Washer, Drain hose, Tie band	
Optional parts	Filter box		PAC-KE94TB-E	PAC-KE94TB-E	PAC-KE95TB-E	
Remarks			* Details on foundation work, duct work, insulation work, electrical wiring, power source switch, and other items shall be referred to the Installation Manual. * Due to continuing improvement, above specifications may be subject to change without notice.			

<p>Notes:</p> <p>1.Nominal cooling conditions Indoor:27°CDB/19°CWB(81°FDB/66°FWB), Outdoor:35°CDB(95°FDB) Pipe length:7.5m(24-9/16ft.), Level difference:0m(0ft.)</p> <p>2.The values are measured at the factory setting of external static pressure.</p> <p>3.Nominal heating conditions Indoor:20°CDB(68°FDB), Outdoor:7°CDB/6°CWB(45°FDB/43°FWB) Pipe length:7.5m(24-9/16ft.), Level difference:0m(0ft.)</p> <p>4.The factory setting of external static pressure is shown without < > . Refer to "Fan characteristics curves", according to the external static pressure, in DATA BOOK for the usable range of air flow rate.</p> <p>5.Measured in anechoic room with a 1m air inlet duct and 2m air outlet duct attached to the unit and 1.5m below the unit. Refer to 5-1-1 for details.</p> <p>6.Measured in anechoic room with a 2m air inlet duct and 2m air outlet duct attached to the unit and 1.5m below the unit. Refer to 5-1-2 for details.</p>	<p>Unit converter</p> <p>kcal/h =kW x 860</p> <p>BTU/h =kW x 3,412</p> <p>cfm =m³/min x 35.31</p> <p>lbs =kg / 0.4536</p>	
		*Above specification data is subject to rounding variation.

PEFY-P20, 25, 32, 40, 50, 63, 71, 80, 100, 125, 140VMA-E

Unit : mm

- Note 1. Use M10 screw for the Suspension bolt (field supply).
 2. Keep the service space for the maintenance at the bottom.
 3. This chart indicates for PEFY-P63-71-80-100-125-140VMA-E models, which have 2 fans. PEFY-P20-25-32-40-50VMA-E models have 1 fan.
 4. In case of the inlet duct is used, remove the air filter (supply with the unit), then install the filter (field supply) at suction side.

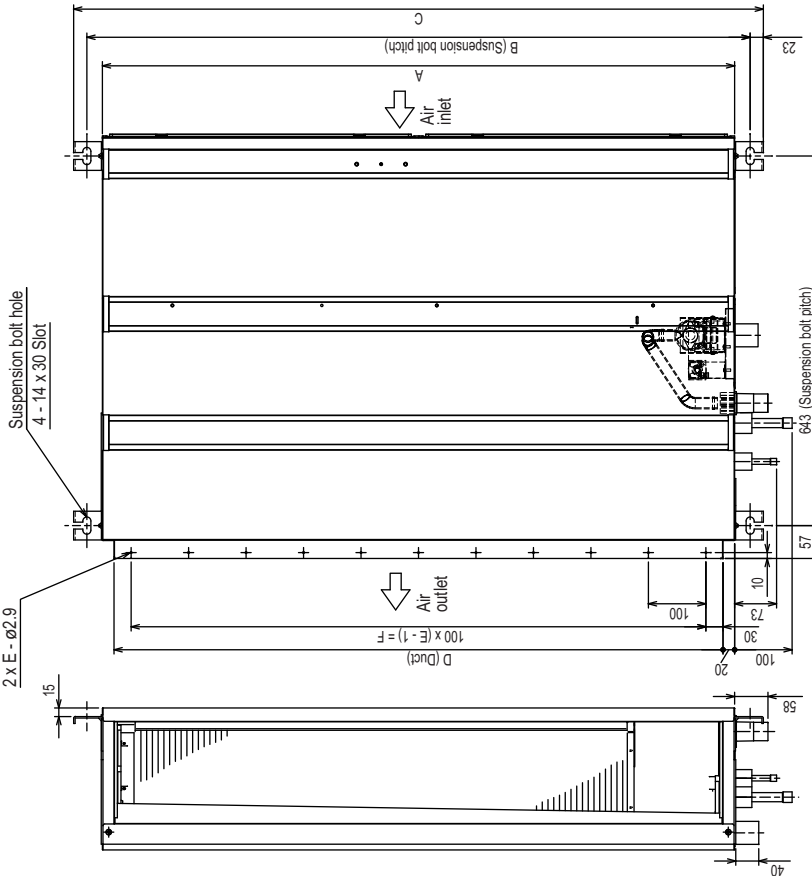
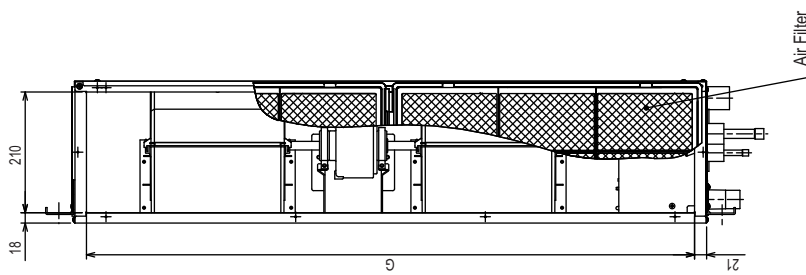

Model	A	B	C	D	E	F	G	① Gas pipe	② Liquid pipe
PEFY-P20,25,32VMA-E	700	754	800	660	7	600	658	ø12.7	ø6.35
PEFY-P40,50VMA-E	900	954	1000	860	9	800	858	ø15.88	ø9.52
PEFY-P63,71,80VMA-E	1100	1154	1200	1060	11	1000	1058	ø15.88	ø9.52
PEFY-P100,125VMA-E	1400	1454	1500	1360	14	1300	1358	ø15.88	ø9.52
PEFY-P140VMA-E	1600	1654	1700	1560	16	1500	1558	ø15.88	ø9.52

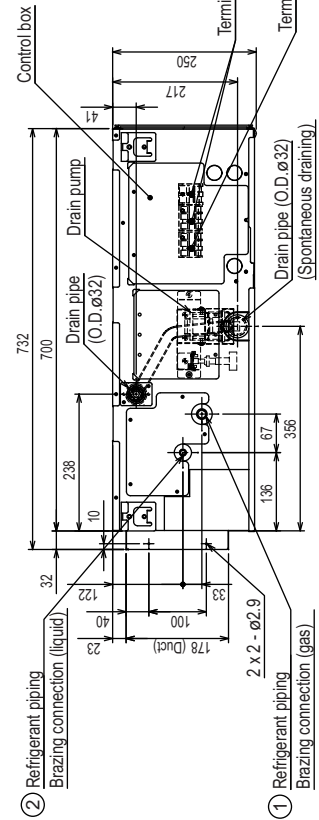

PEFY-P20, 25, 32, 40, 50, 63, 71, 80, 100, 125, 140VMA-E

Unit : mm

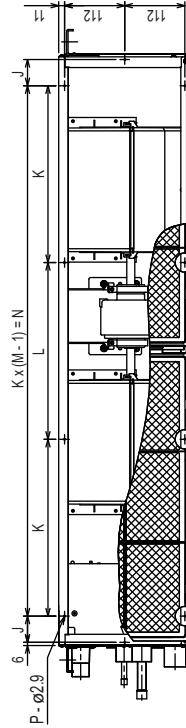
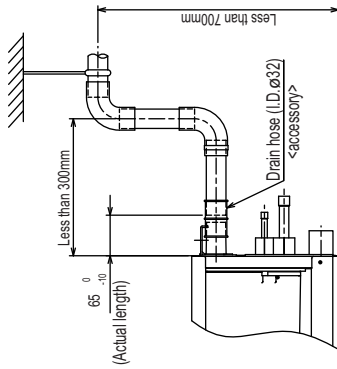

Model	H	J	K	L	M	N	P
PEFY-P20,25,32VMA-E	800	44	150	300			10
PEFY-P40VMA-E					4	780	10
PEFY-P50VMA-E	1000	54	260				
PEFY-P63,71,80VMA-E	1200	49	330		4	990	10
PEFY-P100,125VMA-E	1500	54	320		5	1280	12
PEFY-P140VMA-E	1700	54	370		5	1480	12

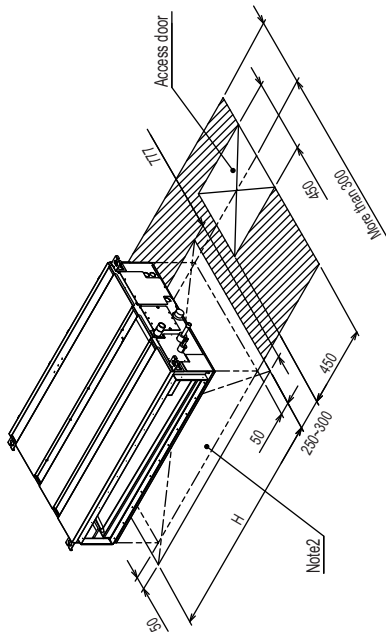

Required space for service and maintenance

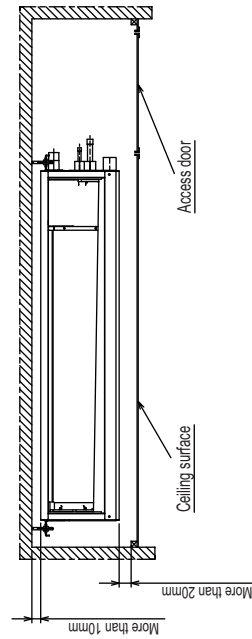

Make the access door at the appointed position properly for service maintenance.

PEFY-P20, 25, 32, 40, 50, 63, 71, 80, 100, 125, 140VMA-E with filter box

Unit : mm

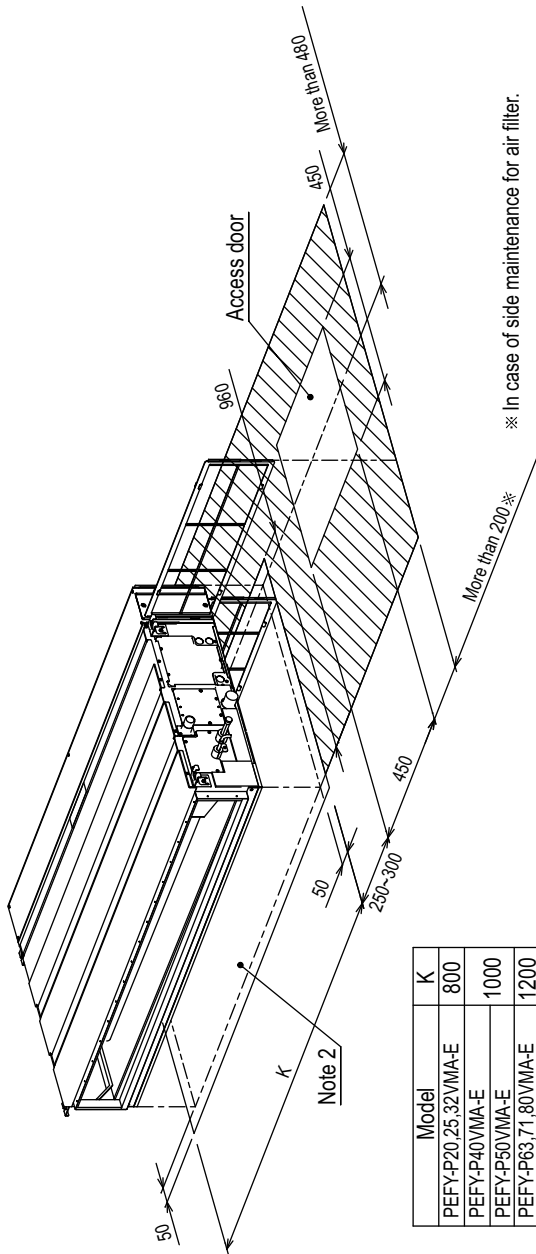
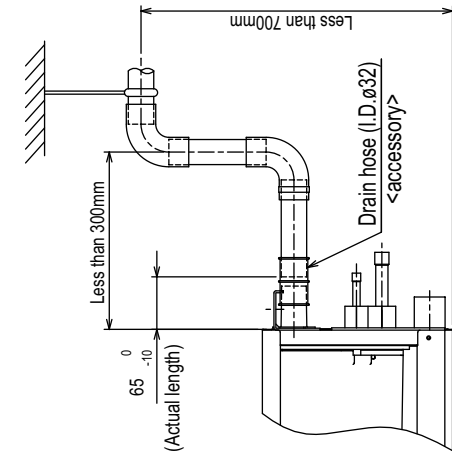

Model	K
PEFY-P20,25,32VMA-E	800
PEFY-P40VMA-E	1000
PEFY-P50VMA-E	1200
PEFY-P63,71,80VMA-E	1500
PEFY-P100,125VMA-E	1700
PEFY-P140VMA-E	1700

Note 2

※ In case of side maintenance for air filter.

Required space for service and maintenance

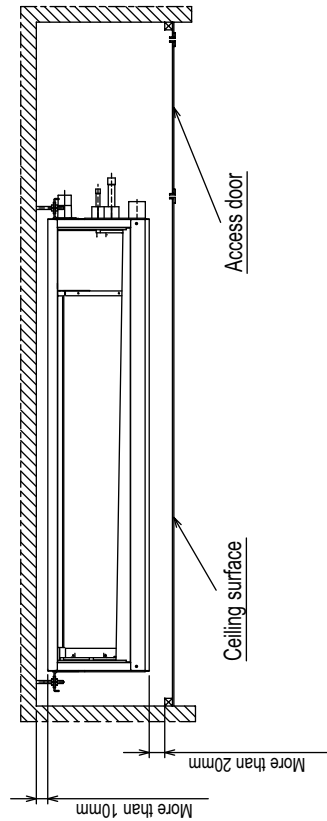

Make the access door at the appointed position properly for service maintenance.

PEFY-P20VMA3-E

Unit : mm

- Note 1. Use M10 screw for the Suspension bolt (field supply).
 2. Keep the service space for the maintenance at the bottom.
 3. In case of the inlet duct is used, remove the air filter (supply with the unit), then install the filter (field supply) at suction side.

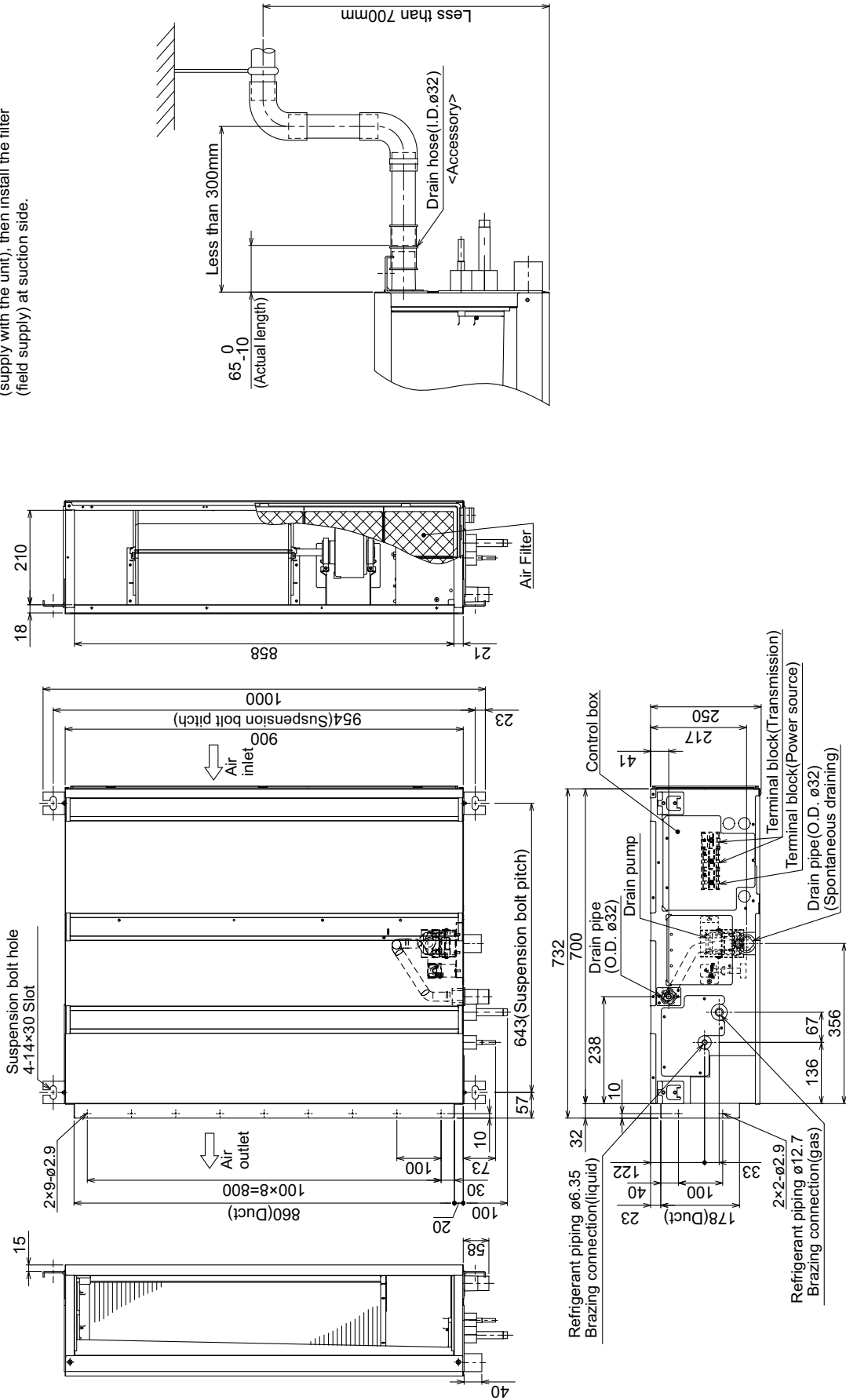

PEFY-P20VMA3-E

Unit : mm

[Maintenance access space]
Secure enough access space to allow for the maintenance, inspection, and replacement of the motor, fan, drain pump, heat exchanger, and electric box in one of the following ways.
Select an installation site for the indoor unit so that its maintenance access space will not be obstructed by beams or other objects.

- (1) When a space of 300mm or more is available below the unit between the unit and the ceiling. (Fig.1)
 - Create access door 1 and 2 (450x450mm each) as shown in Fig.2.
 - (Access door 2 is not required if enough space is available below the unit for a maintenance worker to work in.)
- (2) When a space of less than 300mm is available below the unit between the unit and the ceiling.
 - (At least 20mm of space should be left below the unit as shown in Fig.3.)
 - Create access door 1 diagonally below the electric box and access door 3 below the unit as shown in Fig.4.
 - or
 - Create access door 4 below the electric box and the unit as shown in Fig.5.

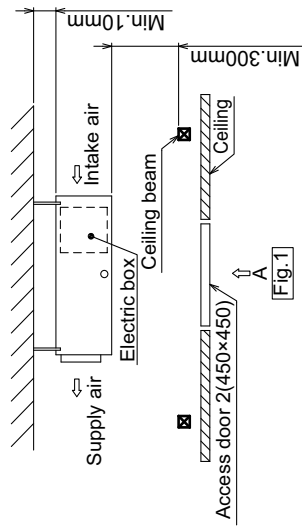

[Fig.1]

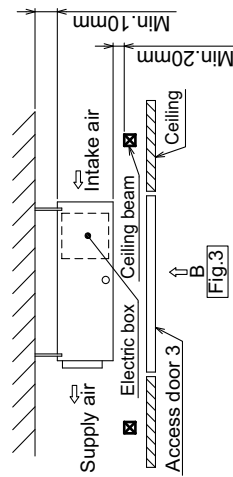

[Fig.3]

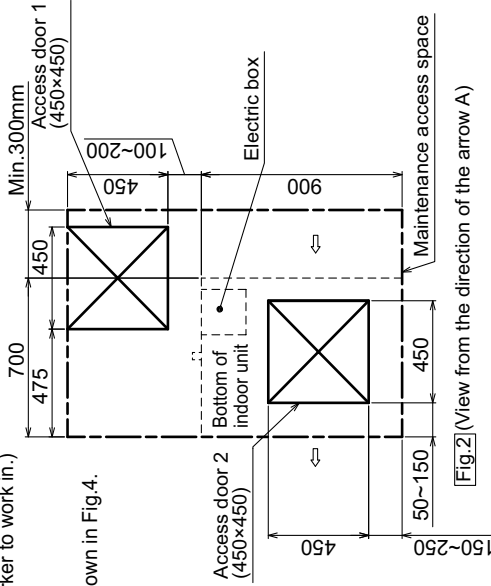
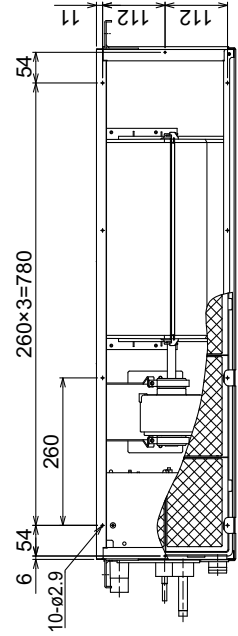

[Fig.2] (View from the direction of the arrow A)

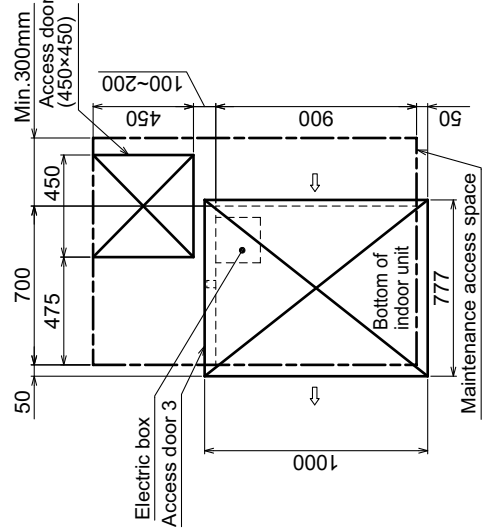

[Fig.4] (View from the direction of the arrow B)

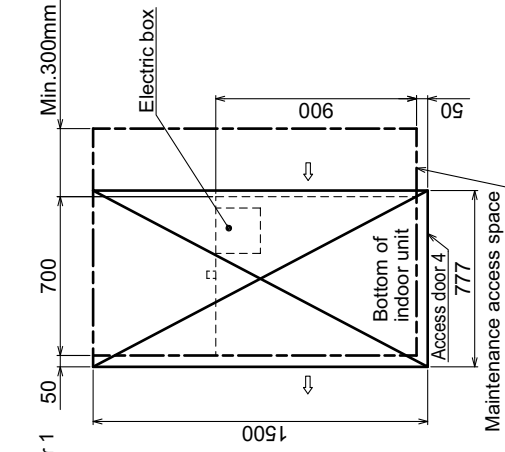

[Fig.5] (View from the direction of the arrow B)

2. EXTERNAL DIMENSIONS

YKB/YLM

PEFY-P20, 25, 32, 40, 50, 63, 71, 80, 100, 125, 140VMAL-E

Unit : mm

- Note 1. Use M10 screw for the Suspension bolt (field supply).
 2. Keep the service space for the maintenance at the bottom.
 3. This chart indicates for PEFY-P63-71-80-100-125-140VMAL-E models, which have 2 fans. PEFY-P20-25-32-40-50VMAL-E models have 1 fan.
 4. In case of the inlet duct is used, remove the air filter (supply with the unit), then install the filter (field supply) at suction side.

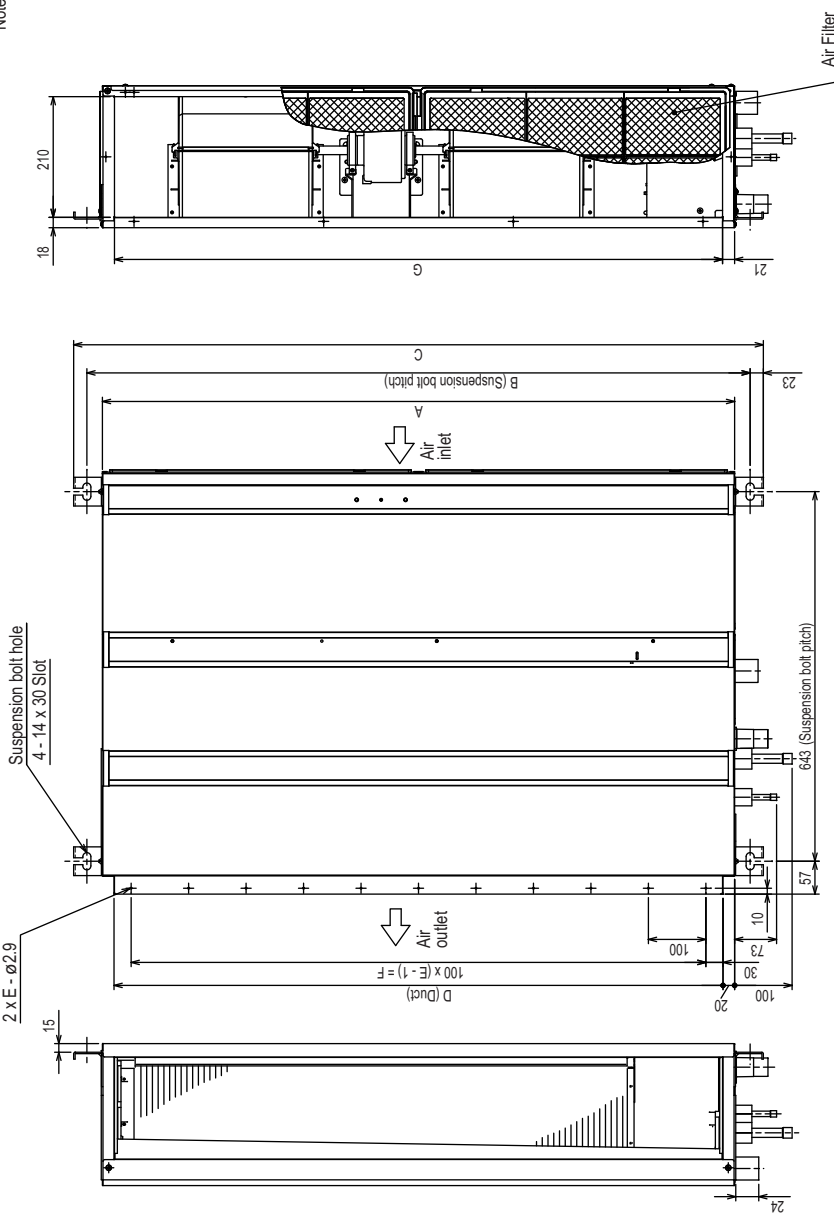

Model	A	B	C	D	E	F	G	① Gas pipe	② Liquid pipe
PEFY-P20,25,32VMAL-E	700	754	800	660	7	600	658	ø12.7	ø6.35
PEFY-P40,50VMAL-E	900	954	1000	860	9	800	858		
PEFY-P63,71,80VMAL-E	1100	1154	1200	1060	11	1000	1058		
PEFY-P100,125VMAL-E	1400	1454	1500	1360	14	1300	1358		
PEFY-P140VMAL-E	1600	1654	1700	1560	16	1500	1558		

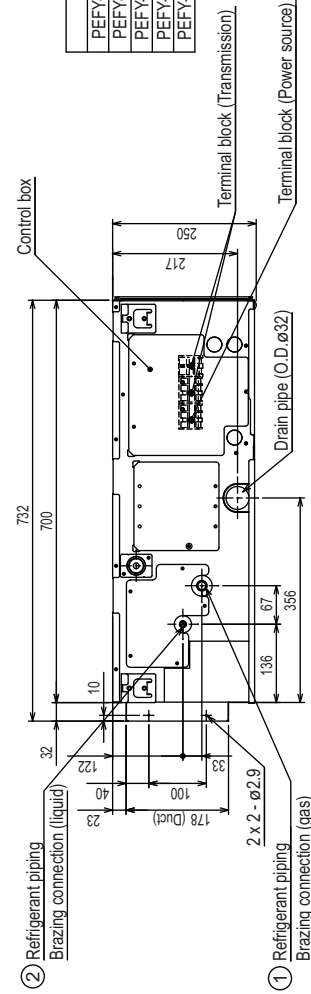

PEFY-P20, 25, 32, 40, 50, 63, 71, 80, 100, 125, 140VMALE

Unit : mm

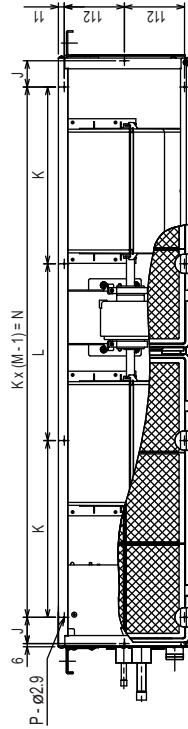
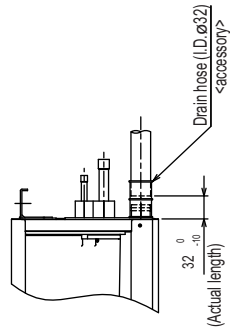

Model	H	J	K	L	M	N	P
PEFY-P20,25,32VMALE	800	44	150	300			10
PEFY-P40VMALE					4	780	10
PEFY-P50VMALE	1000	54	260				
PEFY-P63,71,80VMALE	1200	49	330		4	990	10
PEFY-P100,125VMALE	1500	54	320		5	1280	12
PEFY-P140VMALE	1700	54	370		5	1480	12

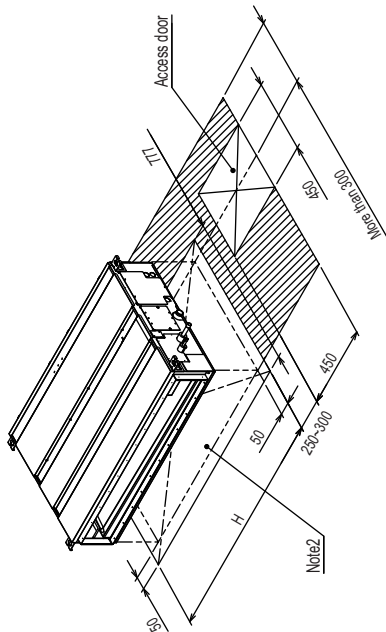

Required space for service and maintenance

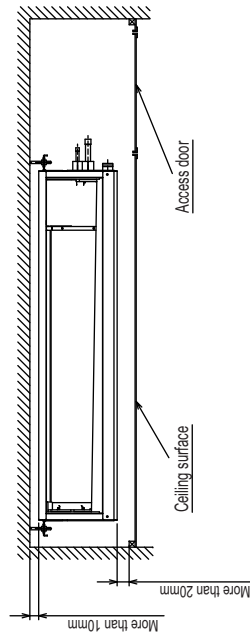

Make the access door at the appointed position properly for service maintenance.

PEFY-P20, 25, 32, 40, 50, 63, 71, 80, 100, 125, 140VMAL-E with filter box

Unit : mm

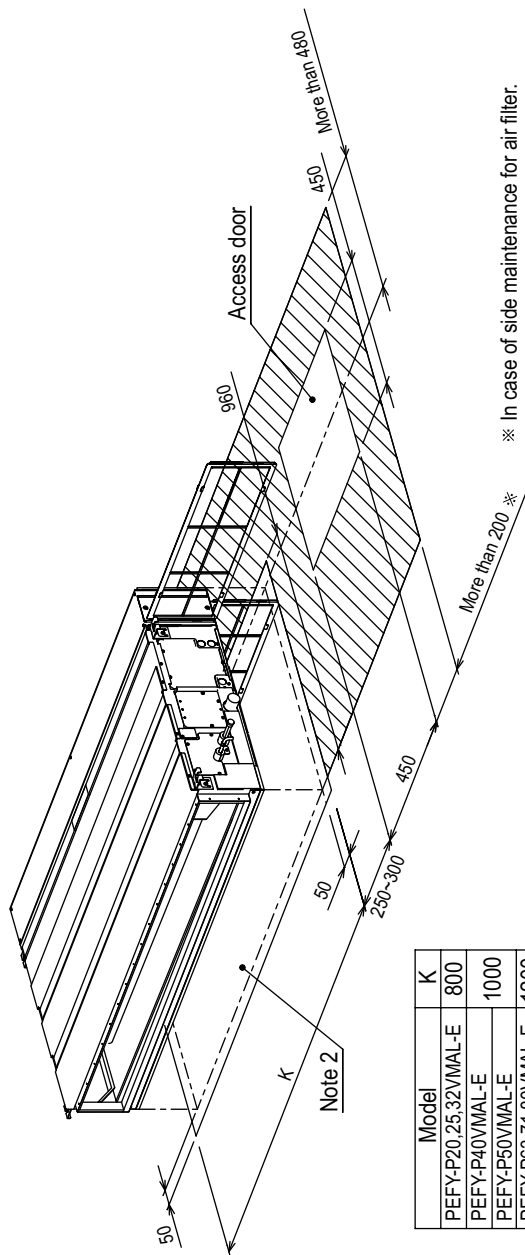
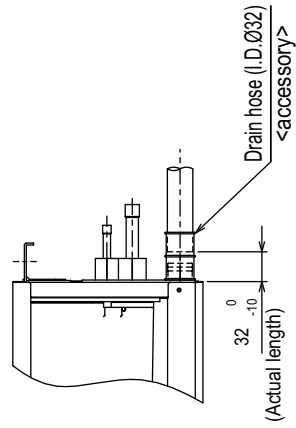

Model	K
PEFY-P20,25,32VMAL-E	800
PEFY-P40VMAL-E	1000
PEFY-P60VMAL-E	1200
PEFY-P63,71,80VMAL-E	1500
PEFY-P100,125VMAL-E	1700
PEFY-P140VMAL-E	1700

Required space for service and maintenance

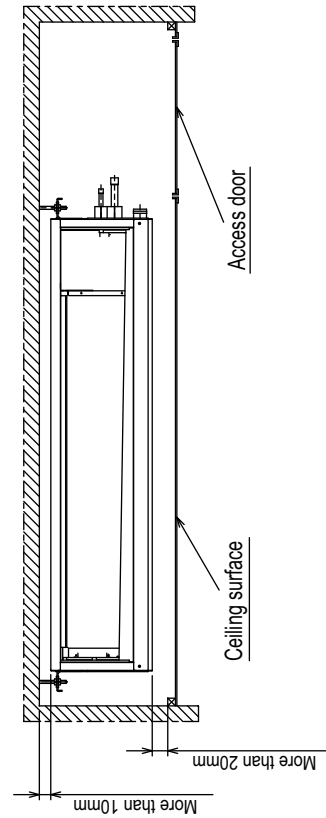

Make the access door at the appointed position properly for service maintenance.

PEFY-P20, 25, 32, 40, 50, 63, 71, 80, 100, 125, 140VMA(L)-E
 PEFY-P20VMA3-E

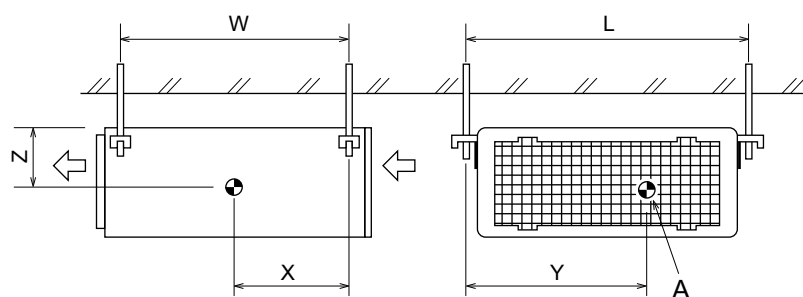

A : Center of gravity

(mm)[in]

Model name	W	L	X	Y	Z
PEFY-P20VMA(L)-E	643 [25 - 6/16]	754 [29 - 11/16]	330 [13]	300 [11 - 13/16]	130 [5 - 2/16]
PEFY-P25VMA(L)-E	643 [25 - 6/16]	754 [29 - 11/16]	330 [13]	300 [11 - 13/16]	130 [5 - 2/16]
PEFY-P32VMA(L)-E	643 [25 - 6/16]	754 [29 - 11/16]	330 [13]	300 [11 - 13/16]	130 [5 - 2/16]
PEFY-P40VMA(L)-E	643 [25 - 6/16]	954 [37 - 9/16]	340 [13 - 7/16]	375 [14 - 13/16]	130 [5 - 2/16]
PEFY-P50VMA(L)-E	643 [25 - 6/16]	954 [37 - 9/16]	340 [13 - 7/16]	375 [14 - 13/16]	130 [5 - 2/16]
PEFY-P63VMA(L)-E	643 [25 - 6/16]	1154 [45 - 7/16]	325 [12 - 13/16]	525 [20 - 11/16]	130 [5 - 2/16]
PEFY-P71VMA(L)-E	643 [25 - 6/16]	1154 [45 - 7/16]	325 [12 - 13/16]	525 [20 - 11/16]	130 [5 - 2/16]
PEFY-P80VMA(L)-E	643 [25 - 6/16]	1154 [45 - 7/16]	325 [12 - 13/16]	525 [20 - 11/16]	130 [5 - 2/16]
PEFY-P100VMA(L)-E	643 [25 - 6/16]	1454 [57 - 4/16]	330 [13]	675 [26 - 10/16]	130 [5 - 2/16]
PEFY-P125VMA(L)-E	643 [25 - 6/16]	1454 [57 - 4/16]	330 [13]	675 [26 - 10/16]	130 [5 - 2/16]
PEFY-P140VMA(L)-E	643 [25 - 6/16]	1654 [65 - 2/16]	332 [13 - 2/16]	725 [28 - 9/16]	130 [5 - 2/16]
PEFY-P20VMA3-E	643 [25 - 6/16]	954 [37 - 9/16]	340 [13 - 7/16]	375 [14 - 13/16]	130 [5 - 2/16]

PEFY-P20, 25, 32, 40, 50, 63, 71, 80, 100, 125, 140VMA(L)-E

INSIDE SECTION OF CONTROL BOX

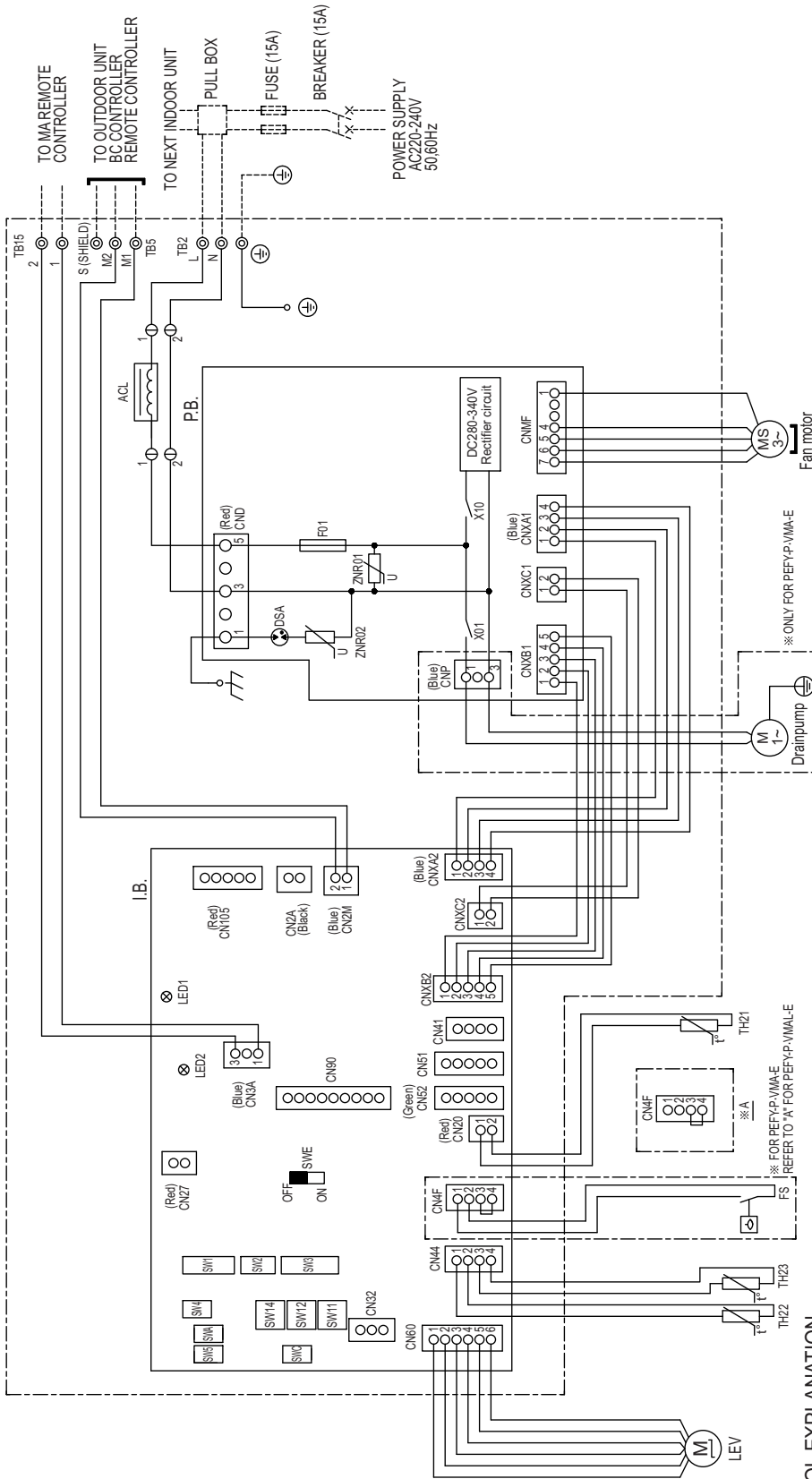

NOTE: 1. The wirings to TB2, TB5, TB15 shown in dotted line are field work.
 2. Mark ⊙ indicates terminal block, ○ connector.

SYMBOL EXPLANATION

SYMBOL	NAME	SYMBOL	NAME	SYMBOL	NAME
I.B.	Indoor controller board	CN41	Connector (HA terminal-A)	SW4 (I.B.)	Switch (for mode selection)
P.B.	Power supply board	CN51	Connector (Centrally control)	SW5 (I.B.)	Switch (for mode selection)
TB2	Power source terminal block	CN52	Connector (Remote indication)	SW11 (I.B.)	Switch (1s digit address set)
TB5	Transmission terminal block	CN90	Connector (Wireless)	SW12 (I.B.)	Switch (10ths digit address set)
TB15	Transmission terminal block	CN105	Connector (IT terminal)	SW14 (I.B.)	Switch (BRANCH No.)
F01	Fuse AC250V 6.3A	CN2A	Connector (0-10V Analog input)	SWA (I.B.)	Switch (for static pressure selection)
ZNR01,02	Varistor	FS	Float switch	SWC (I.B.)	Switch (for static pressure selection)
DSA	Arrester	TH21	Thermistor (inlet air temp. detection)	SWE (I.B.)	Connector (emergency operation)
X01	Aux. relay	TH22	Thermistor (piping temp. detection/liquid)	LED1	LED (Power supply)
X10	Aux. relay	TH23	Thermistor (piping temp. detection/gas)	LED2	LED (Remote controller supply)
ACL	AC reactor (Power factor improvement)	SW1 (I.B.)	Switch (for mode selection)		
CN27	Connector (Damper)	SW2 (I.B.)	Switch (for capacity code)		
CN32	Connector (Remote switch)	SW3 (I.B.)	Switch (for mode selection)		

PEFY-P20VMA3-E

PEFY-VM(L), VMA3

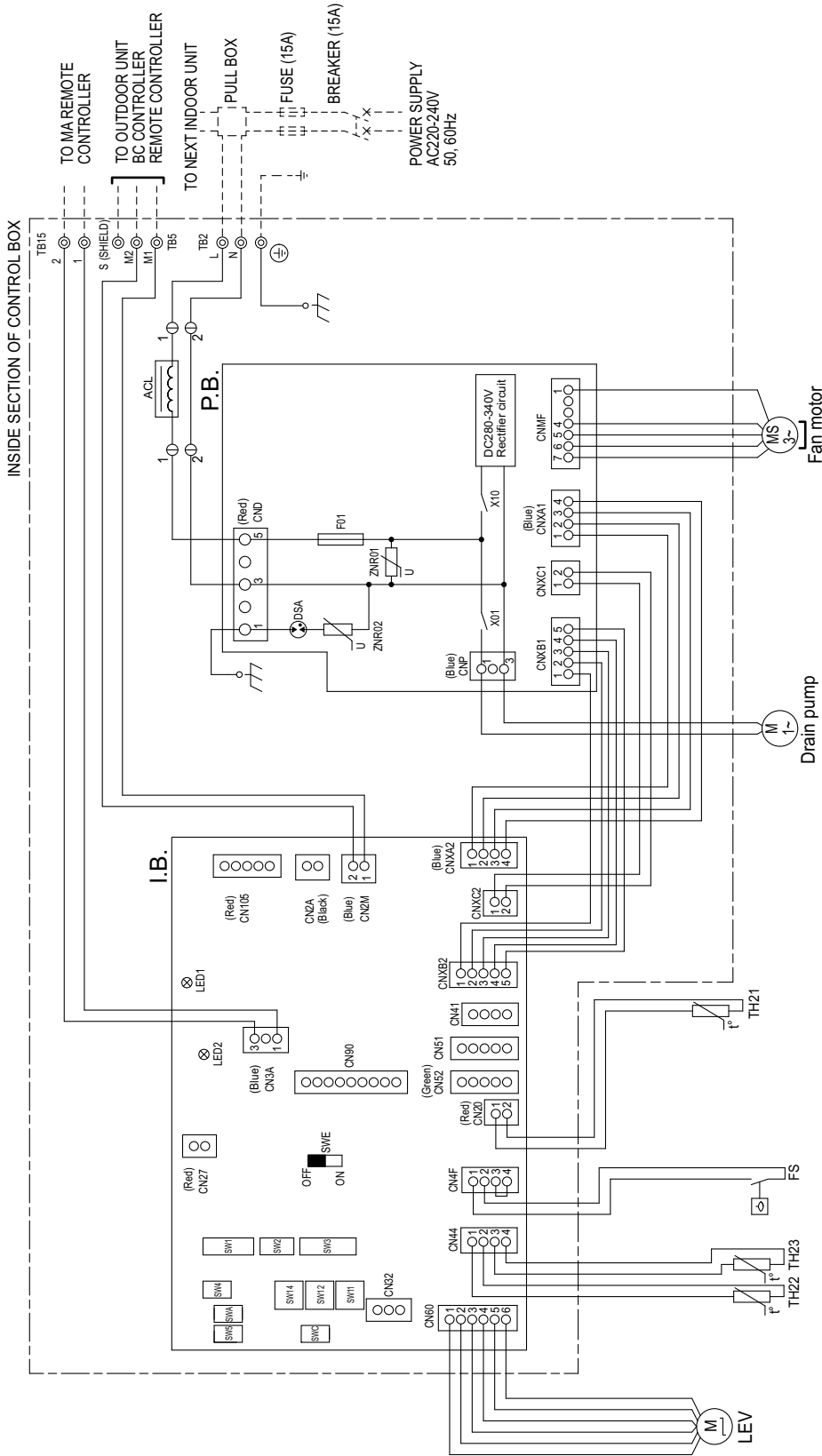

NOTE:1. The wirings to TB2, TB5, TB15 shown in dotted line are field work.
 2. Mark ⊙ indicates terminal block, ⊕ connector.

SYMBOL EXPLANATION

SYMBOL	NAME	SYMBOL	NAME	SYMBOL	NAME
I.B.	Indoor controller board	CN41	Connector (HA terminal-A)	SW4 (I.B.)	Switch (for mode selection)
P.B.	Power supply board	CN51	Connector (Centrally control)	SW5 (I.B.)	Switch (for mode selection)
TB2	Power source terminal block	CN52	Connector (Remote indication)	SW11 (I.B.)	Switch (1s digit address set)
TB5	Transmission terminal block	CN90	Connector (Wireless)	SW12 (I.B.)	Switch (10ths digit address set)
TB15	Transmission terminal block	CN105	Connector (IT terminal)	SW14 (I.B.)	Switch (BRANCH No.)
FB01	Fuse AC250V 6.3A	CN2A	Connector (0-10V Analog input)	SWA (I.B.)	Switch (for static pressure selection)
ZNR01, 02	Varistor	FS	Float switch	SWC (I.B.)	Switch (for static pressure selection)
DSA	Arrester	TH21	Thermistor (inlet air temp. detection)	SWE (I.B.)	Connector (emergency operation)
X10	Aux. relay	TH22	Thermistor (piping temp. detection/liquid)	LED1	LED (Power supply)
X10	Aux. relay	TH23	Thermistor (piping temp. detection/gas)	LED2	LED (Remote controller supply)
ACL	AC reactor (Power factor improvement)	SW1 (I.B.)	Switch (for mode selection)		
CN27	Connector (Damper)	SW2 (I.B.)	Switch (for capacity code)		
CN32	Connector (Remote switch)	SW3 (I.B.)	Switch (for mode selection)		

5-1. Sound levels

5-1-1. Sound levels (Measured point: With 1m air inlet duct and 2m air outlet duct)

PEFY-P-VMA(L)-E, VMA3-E

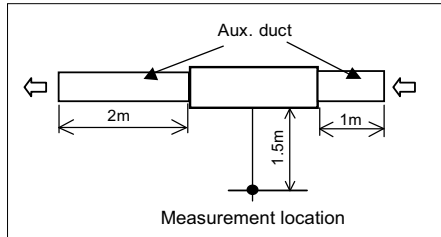

* Measured in anechoic room.

Sound level at anechoic room : Low-Mid-High

Model	Sound level dB(A)				
	35Pa	50Pa	70Pa	100Pa	150Pa
PEFY-P20VMA(L)-E	26-27-28	26-28-29	26-29-31	27-30-33	28-33-37
PEFY-P25VMA(L)-E	26-27-28	26-28-29	26-29-31	27-30-33	28-33-37
PEFY-P32VMA(L)-E	28-30-34	28-30-34	29-32-36	29-33-37	31-35-40
PEFY-P40VMA(L)-E	28-30-34	28-30-34	29-32-36	29-33-37	32-36-40
PEFY-P50VMA(L)-E	28-31-35	28-32-35	29-33-37	30-34-38	32-37-41
PEFY-P63VMA(L)-E	29-32-35	29-32-36	30-33-38	31-35-39	33-38-41
PEFY-P71VMA(L)-E	30-33-37	30-34-38	31-36-39	33-37-41	36-41-44
PEFY-P80VMA(L)-E	30-33-37	30-34-38	31-36-39	33-37-41	36-41-44
PEFY-P100VMA(L)-E	31-36-40	32-37-41	33-38-42	35-39-43	37-42-45
PEFY-P125VMA(L)-E	35-40-44	35-40-44	37-41-45	38-42-46	39-44-47
PEFY-P140VMA(L)-E	36-41-45	36-41-45	38-42-46	39-43-47	40-45-48

PEFY-VMA(L), VMA3

	35Pa	50Pa	70Pa	100Pa	125Pa
PEFY-P20VMA3-E	29-34-38	30-35-39	32-36-40	33-37-41	35-39-43

5-1-2. Sound levels (Measured point: With 2m air inlet duct and 2m air outlet duct)

PEFY-P-VMA(L)-E

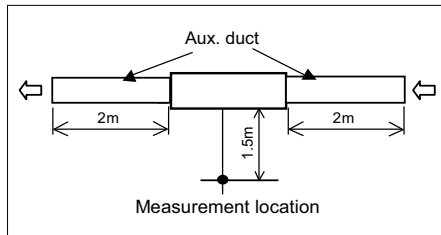

* Measured in anechoic room.

Sound level at anechoic room : Low-Mid-High

Model	Sound level dB(A)				
	35Pa	50Pa	70Pa	100Pa	150Pa
PEFY-P20VMA(L)-E	23-24-25	23-25-26	23-26-28	24-27-30	25-30-34
PEFY-P25VMA(L)-E	23-24-25	23-25-26	23-26-28	24-27-30	25-30-34
PEFY-P32VMA(L)-E	23-25-28	23-26-29	24-27-30	25-28-32	28-32-36
PEFY-P40VMA(L)-E	23-26-29	23-27-30	24-28-31	26-29-33	29-33-37
PEFY-P50VMA(L)-E	24-28-31	25-29-32	26-30-33	27-31-34	29-34-38
PEFY-P63VMA(L)-E	25-28-32	25-29-33	26-30-34	27-31-35	29-34-38
PEFY-P71VMA(L)-E	26-29-33	26-29-34	26-30-35	29-33-37	32-37-41
PEFY-P80VMA(L)-E	26-29-33	26-29-34	26-30-35	29-33-37	32-37-41
PEFY-P100VMA(L)-E	28-32-36	28-33-37	30-35-39	31-36-40	33-38-43
PEFY-P125VMA(L)-E	31-35-39	32-36-40	32-37-41	33-39-42	37-40-44
PEFY-P140VMA(L)-E	31-35-40	33-37-42	34-38-43	35-39-44	37-41-45

5-2. NC curves

5-2-1. NC curves (Sound level measured point : With 1m air inlet duct and 2m air outlet duct)

PEFY-VM(L), VMA3

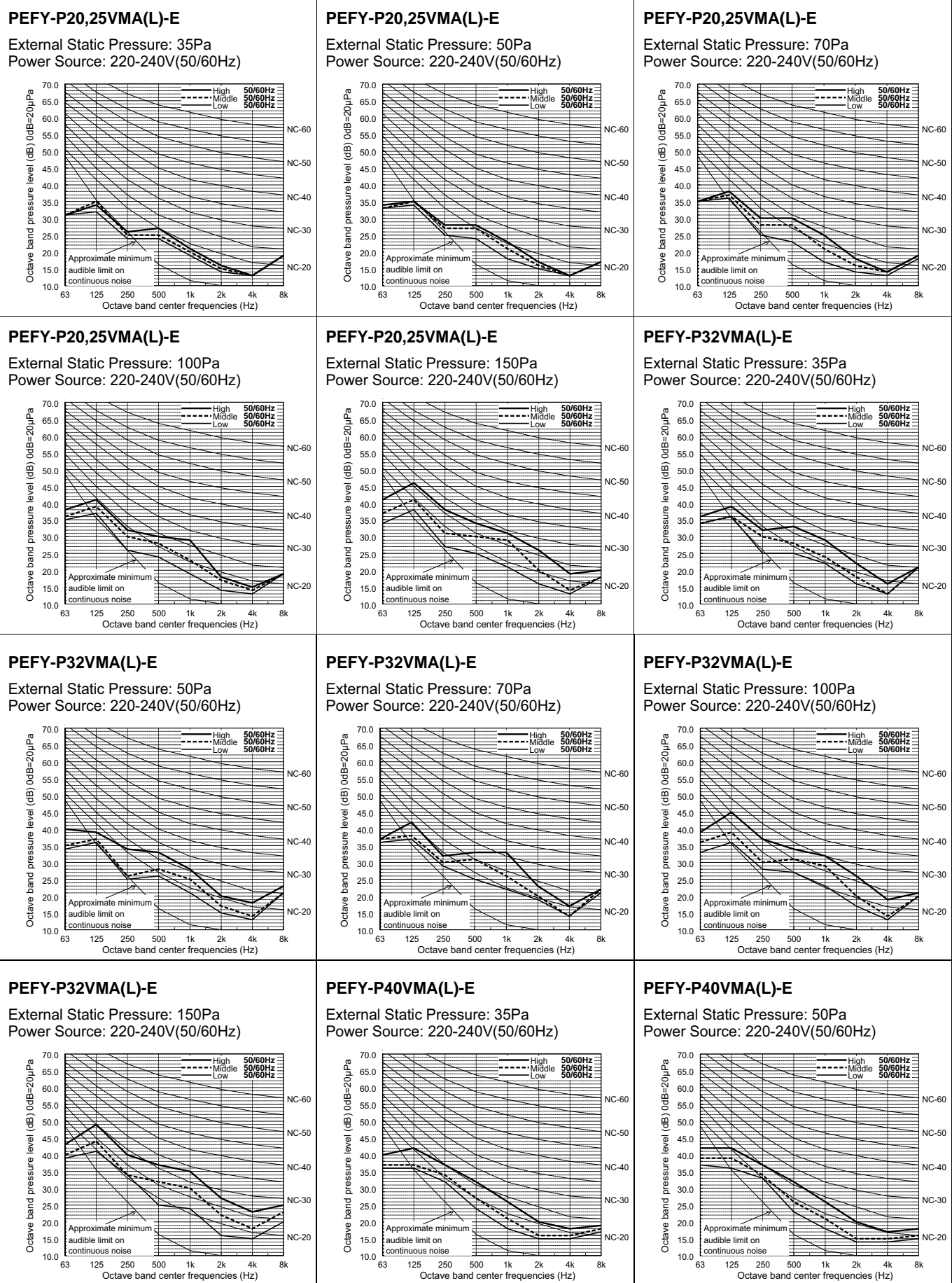

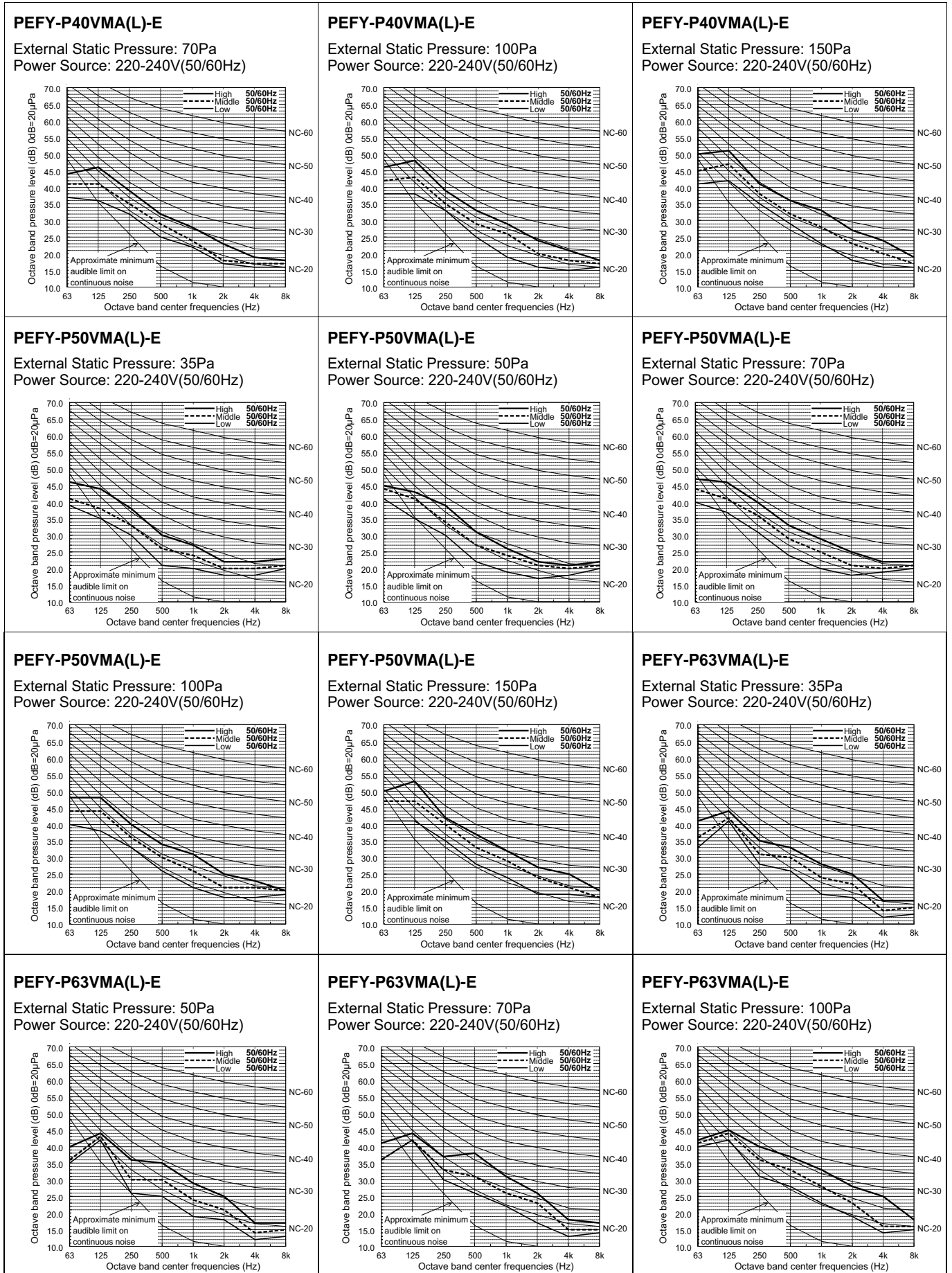

PEFY-VM(L), VMA3

PEFY-P63VMA(L)-E

External Static Pressure: 150Pa
Power Source: 220-240V(50/60Hz)

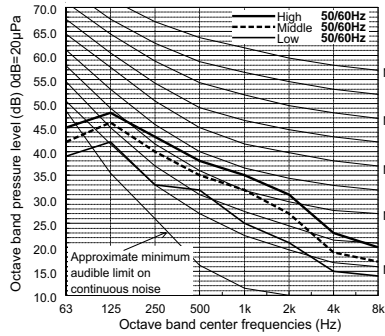

PEFY-P71,80VMA(L)-E

External Static Pressure: 35Pa
Power Source: 220-240V(50/60Hz)

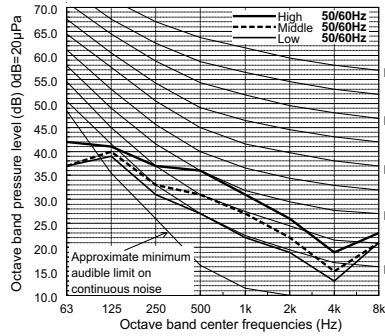

PEFY-P71,80VMA(L)-E

External Static Pressure: 50Pa
Power Source: 220-240V(50/60Hz)

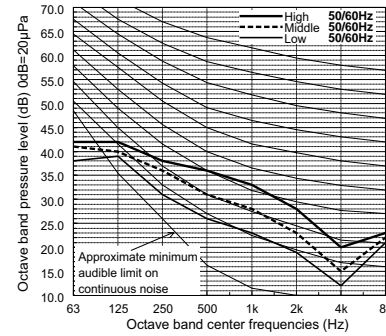

PEFY-P71,80VMA(L)-E

External Static Pressure: 70Pa
Power Source: 220-240V(50/60Hz)

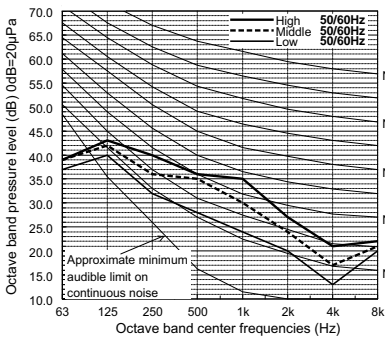

PEFY-P71,80VMA(L)-E

External Static Pressure: 100Pa
Power Source: 220-240V(50/60Hz)

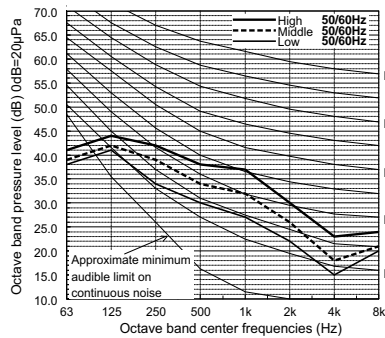

PEFY-P71,80VMA(L)-E

External Static Pressure: 150Pa
Power Source: 220-240V(50/60Hz)

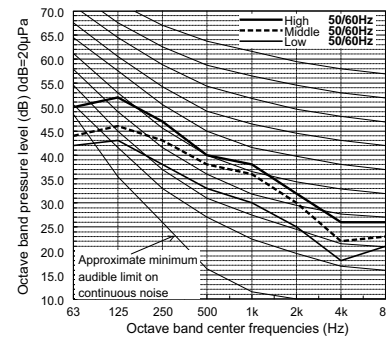

PEFY-P100VMA(L)-E

External Static Pressure: 35Pa
Power Source: 220-240V(50/60Hz)

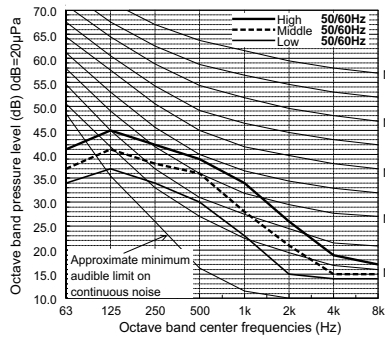

PEFY-P100VMA(L)-E

External Static Pressure: 50Pa
Power Source: 220-240V(50/60Hz)

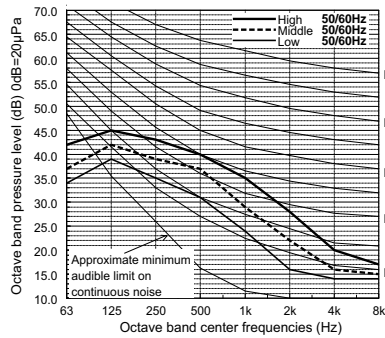

PEFY-P100VMA(L)-E

External Static Pressure: 70Pa
Power Source: 220-240V(50/60Hz)

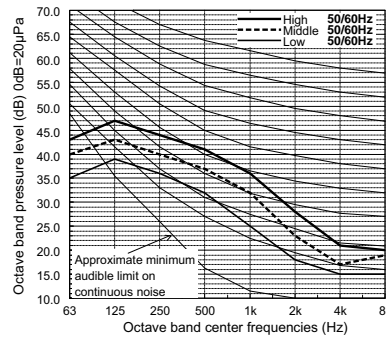

PEFY-P100VMA(L)-E

External Static Pressure: 100Pa
Power Source: 220-240V(50/60Hz)

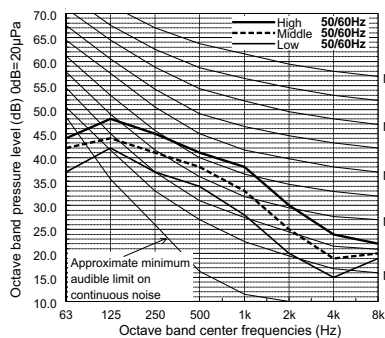

PEFY-P100VMA(L)-E

External Static Pressure: 150Pa
Power Source: 220-240V(50/60Hz)

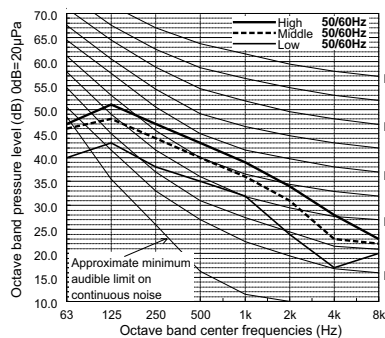

PEFY-P125VMA(L)-E

External Static Pressure: 35Pa
Power Source: 220-240V(50/60Hz)

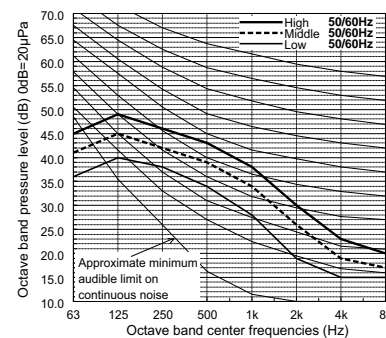

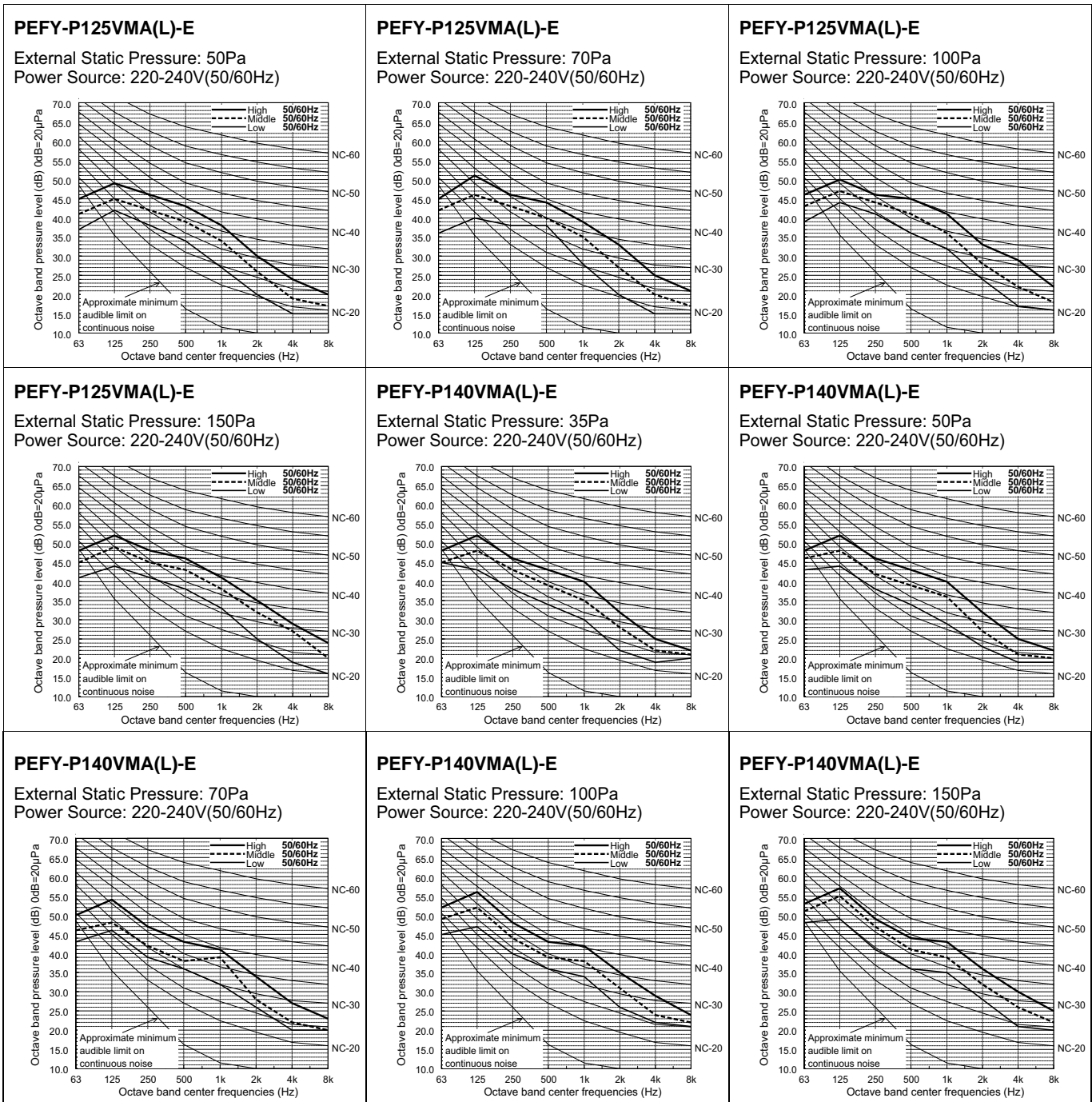

PEFY-VM(L), VMA3

PEFY-P20VMA3-E

External Static Pressure: 35Pa [0.14in.WG]
Power Source: 220-240V(50Hz/60Hz)

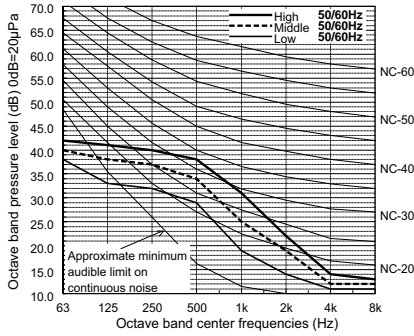

PEFY-P20VMA3-E

External Static Pressure: 50Pa [0.20in.WG]
Power Source: 220-240V(50Hz/60Hz)

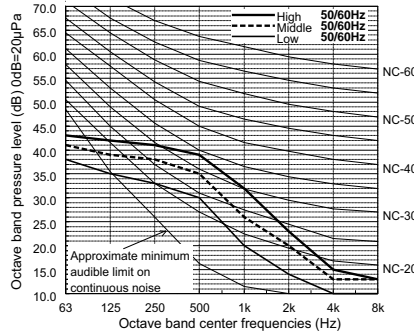

PEFY-P20VMA3-E

External Static Pressure: 70Pa [0.28in.WG]
Power Source: 220-240V(50Hz/60Hz)

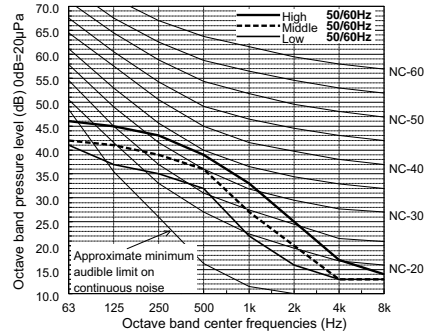

PEFY-P20VMA3-E

External Static Pressure: 100Pa [0.40in.WG]
Power Source: 220-240V(50Hz/60Hz)

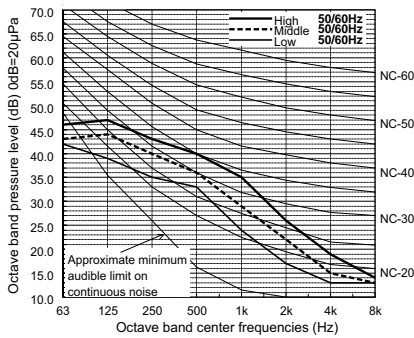

PEFY-P20VMA3-E

External Static Pressure: 125Pa [0.50in.WG]
Power Source: 220-240V(50Hz/60Hz)

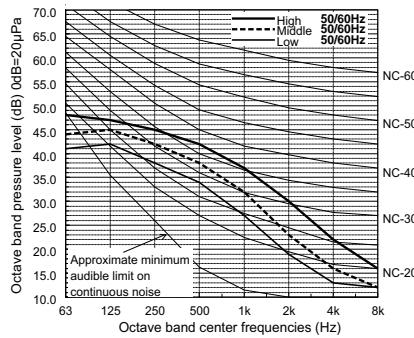

5-2-2. NC curves (Sound level measured point : With 2m air inlet duct and 2m air outlet duct)

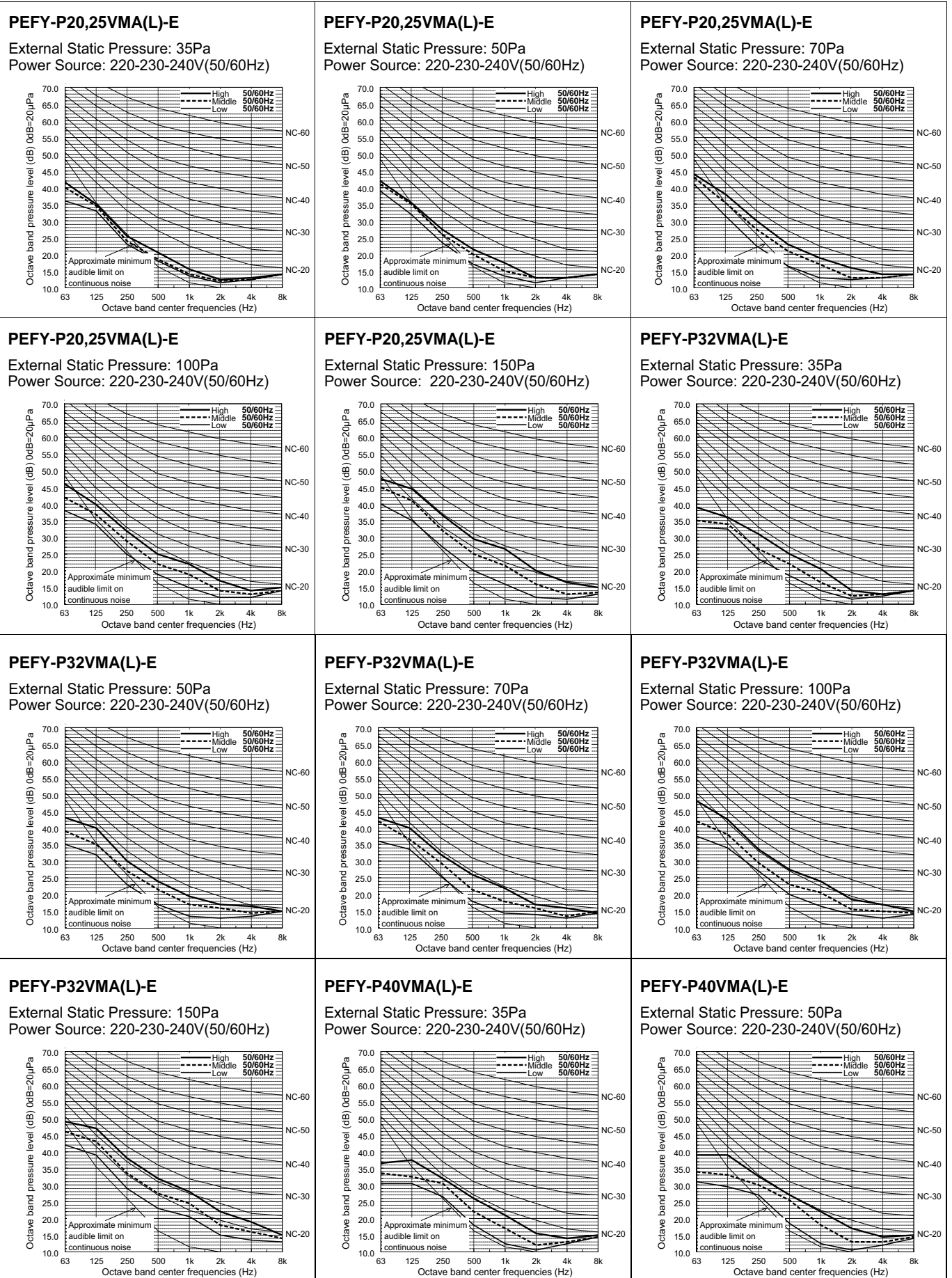

PEFY-VM(L), VMA3

PEFY-P40VMA(L)-E

External Static Pressure: 70Pa
Power Source: 220-230-240V(50/60Hz)

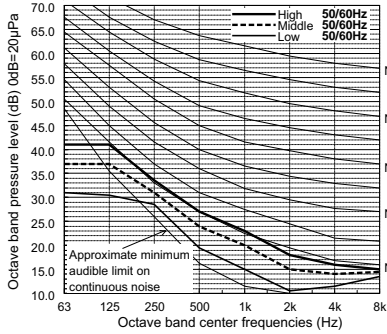

PEFY-P40VMA(L)-E

External Static Pressure: 100Pa
Power Source: 220-230-240V(50/60Hz)

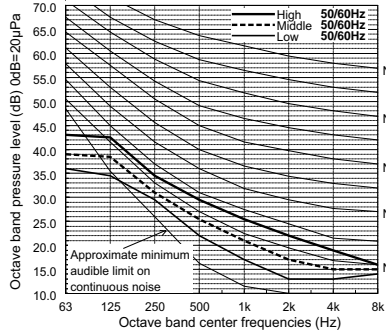

PEFY-P40VMA(L)-E

External Static Pressure: 150Pa
Power Source: 220-230-240V(50/60Hz)

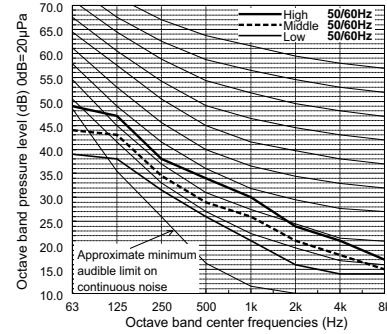

PEFY-P50VMA(L)-E

External Static Pressure: 35Pa
Power Source: 220-230-240V(50/60Hz)

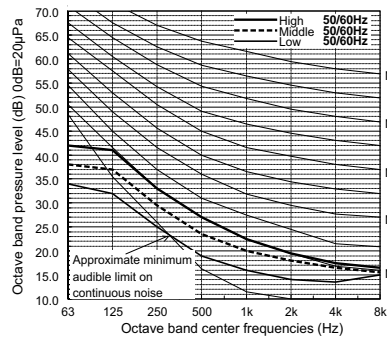

PEFY-P50VMA(L)-E

External Static Pressure: 50Pa
Power Source: 220-230-240V(50/60Hz)

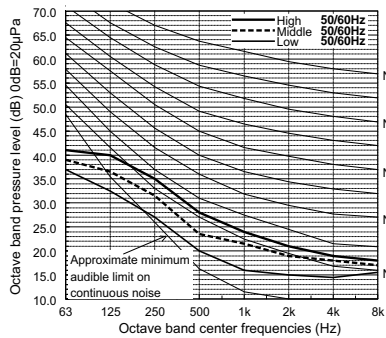

PEFY-P50VMA(L)-E

External Static Pressure: 70Pa
Power Source: 220-230-240V(50/60Hz)

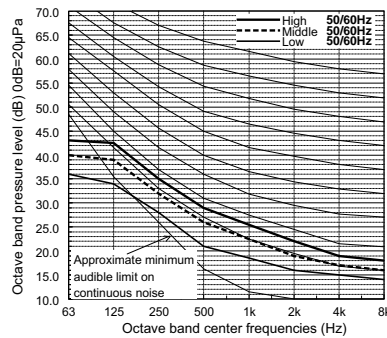

PEFY-P50VMA(L)-E

External Static Pressure: 100Pa
Power Source: 220-230-240V(50/60Hz)

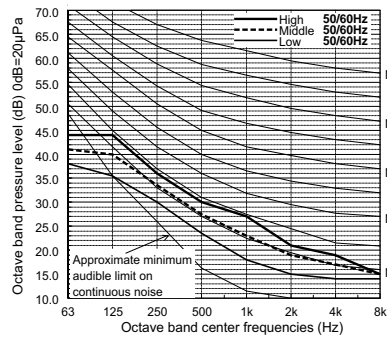

PEFY-P50VMA(L)-E

External Static Pressure: 150Pa
Power Source: 220-230-240V(50/60Hz)

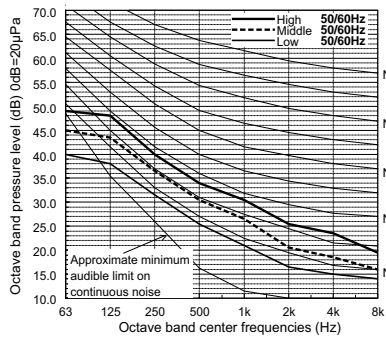

PEFY-P63VMA(L)-E

External Static Pressure: 35Pa
Power Source: 220-230-240V(50/60Hz)

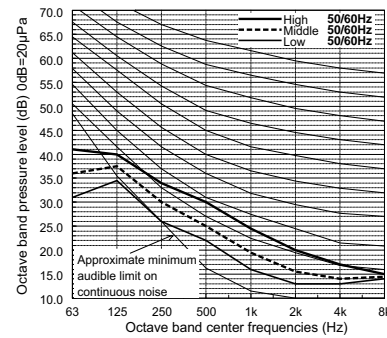

PEFY-P63VMA(L)-E

External Static Pressure: 50Pa
Power Source: 220-230-240V(50/60Hz)

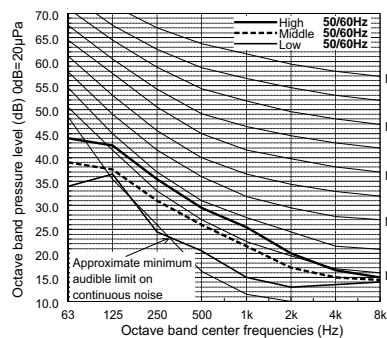

PEFY-P63VMA(L)-E

External Static Pressure: 70Pa
Power Source: 220-230-240V(50/60Hz)

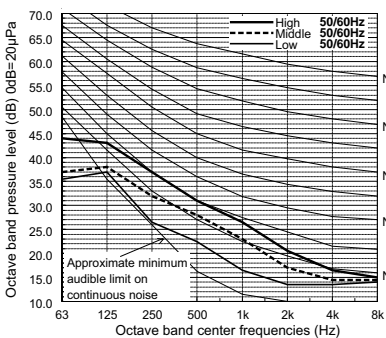

PEFY-P63VMA(L)-E

External Static Pressure: 100Pa
Power Source: 220-230-240V(50/60Hz)

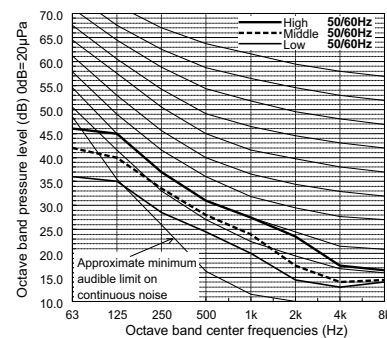

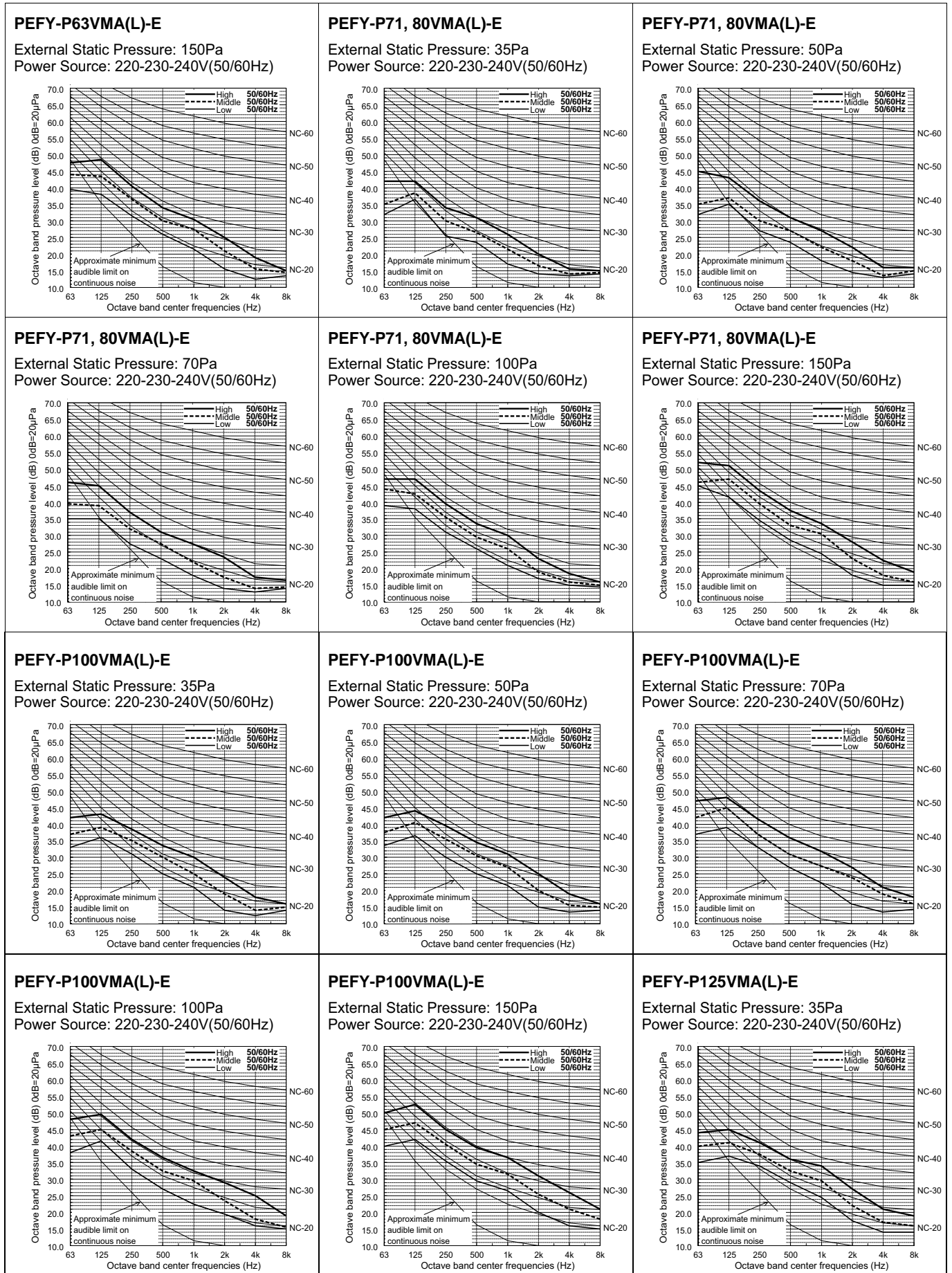

PEFY-VMA(L), VMA3

PEFY-P125VMA(L)-E

External Static Pressure: 50Pa
Power Source: 220-230-240V(50/60Hz)

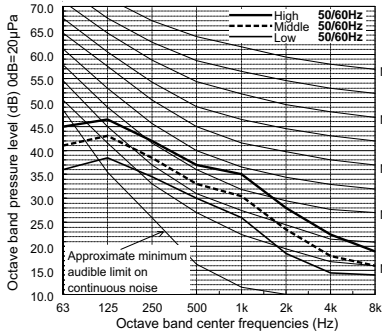

PEFY-P125VMA(L)-E

External Static Pressure: 70Pa
Power Source: 220-230-240V(50/60Hz)

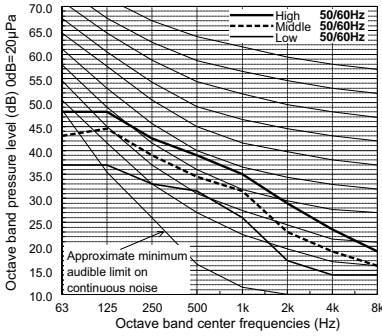

PEFY-P125VMA(L)-E

External Static Pressure: 100Pa
Power Source: 220-230-240V(50/60Hz)

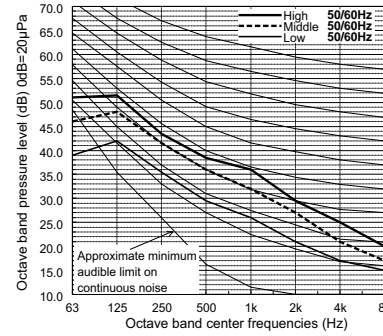

PEFY-P125VMA(L)-E

External Static Pressure: 150Pa
Power Source: 220-230-240V(50/60Hz)

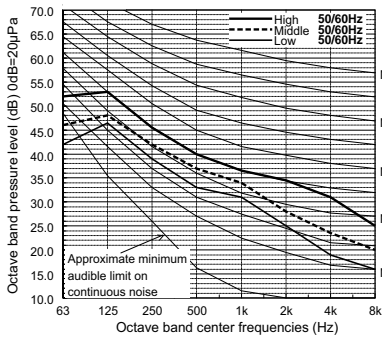

PEFY-P140VMA(L)-E

External Static Pressure: 35Pa
Power Source: 220-230-240V(50/60Hz)

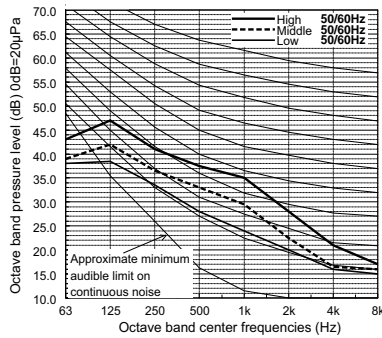

PEFY-P140VMA(L)-E

External Static Pressure: 50Pa
Power Source: 220-230-240V(50/60Hz)

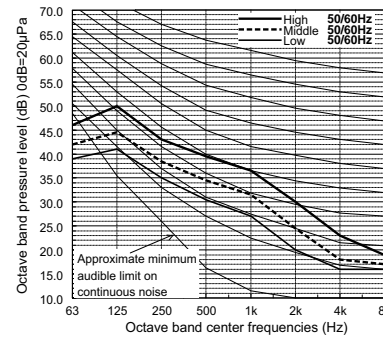

PEFY-P140VMA(L)-E

External Static Pressure: 70Pa
Power Source: 220-230-240V(50/60Hz)

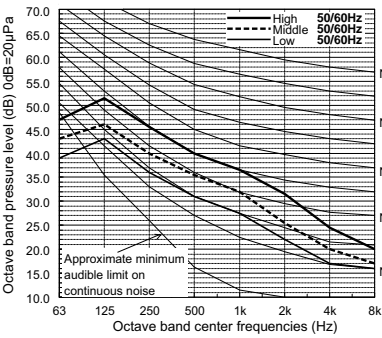

PEFY-P140VMA(L)-E

External Static Pressure: 100Pa
Power Source: 220-230-240V(50/60Hz)

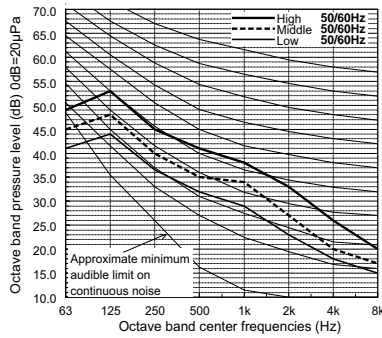

PEFY-P140VMA(L)-E

External Static Pressure: 150Pa
Power Source: 220-230-240V(50/60Hz)

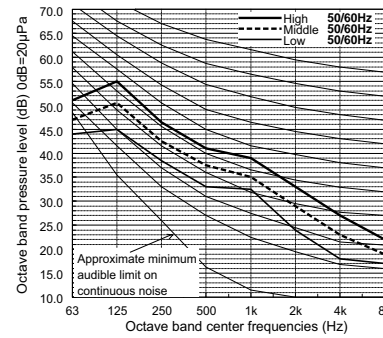

6. FAN CHARACTERISTICS CURVES

PEFY-P20,25VMA(L)-E

External static pressure : 35Pa
Power source : 220-240V

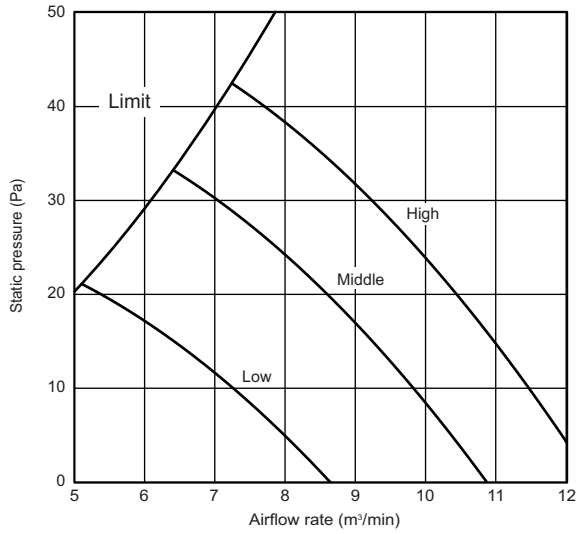

PEFY-P20,25VMA(L)-E

External static pressure : 50Pa
Power source : 220-240V

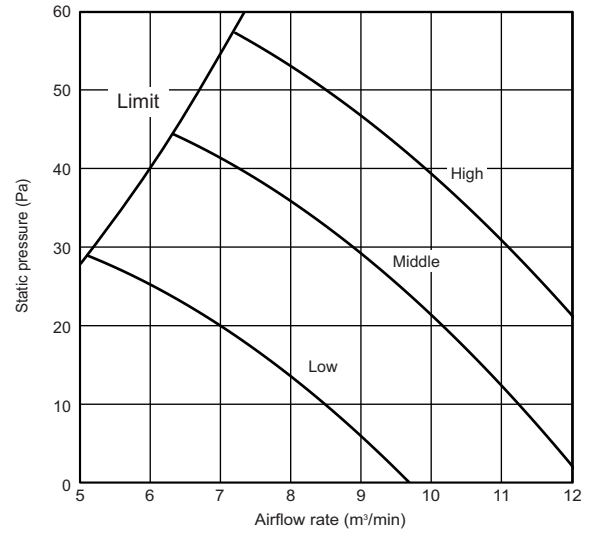

PEFY-P20,25VMA(L)-E

External static pressure : 70Pa
Power source : 220-240V

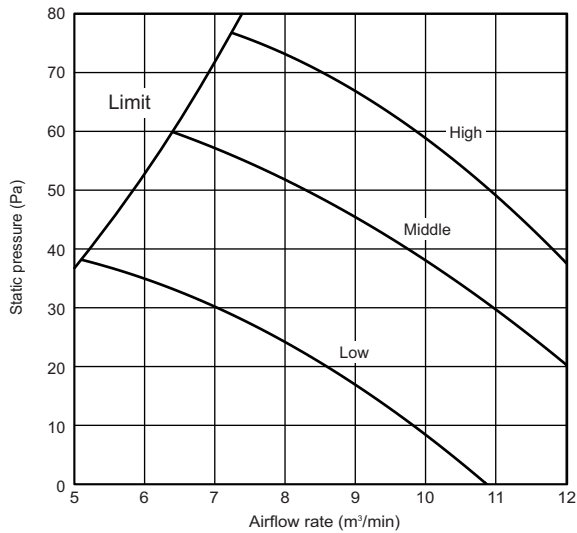

PEFY-P20,25VMA(L)-E

External static pressure : 100Pa
Power source : 220-240V

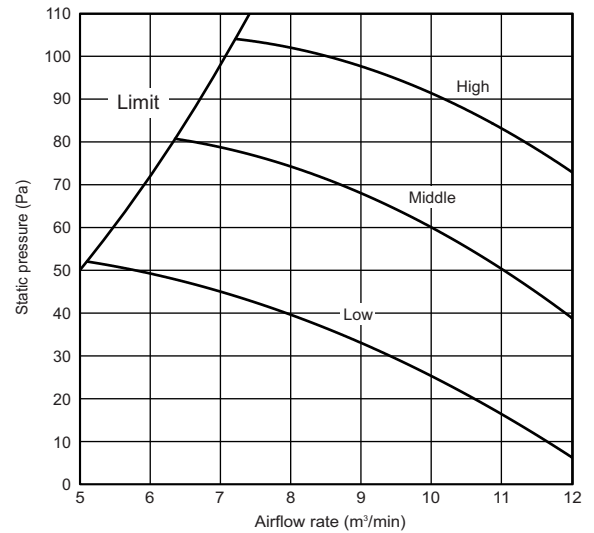

PEFY-P20,25VMA(L)-E

External static pressure : 150Pa
Power source : 220-240V

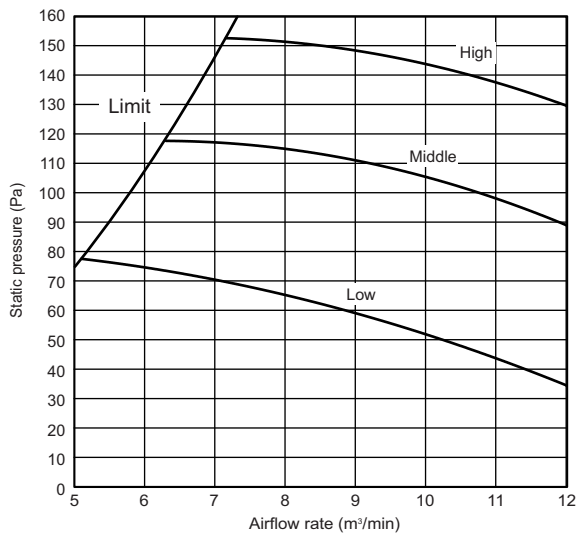

6. FAN CHARACTERISTICS CURVES

YKB/YLM

PEFY-VMA(L), VMA3

PEFY-P32VMA(L)-E

External static pressure : 35Pa
Power source : 220-240V

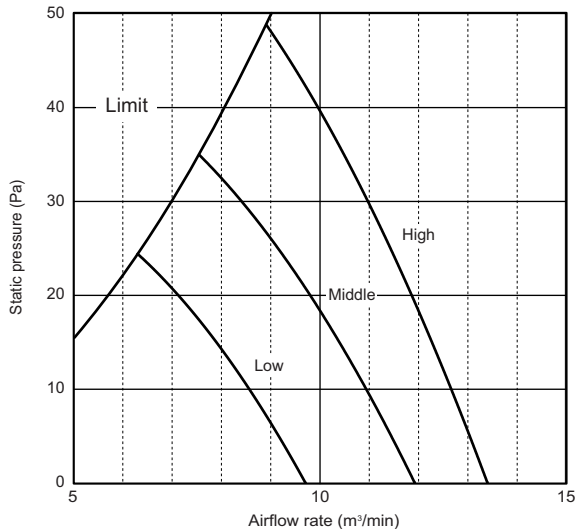

PEFY-P32VMA(L)-E

External static pressure : 50Pa
Power source : 220-240V

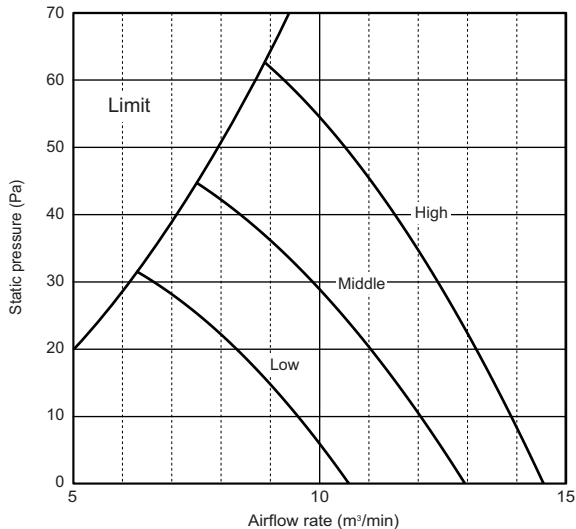

PEFY-P32VMA(L)-E

External static pressure : 70Pa
Power source : 220-240V

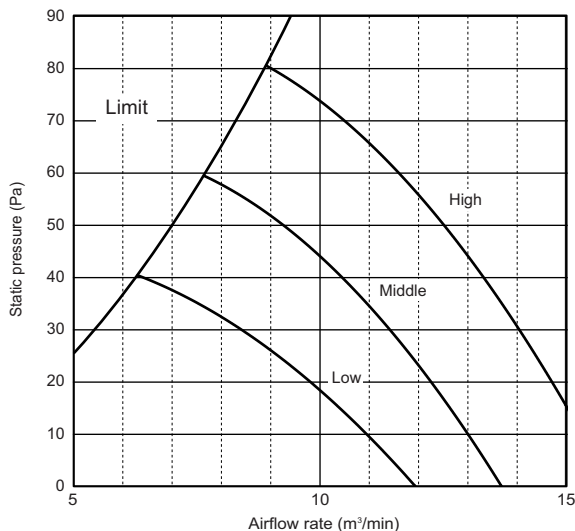

PEFY-P32VMA(L)-E

External static pressure : 100Pa
Power source : 220-240V

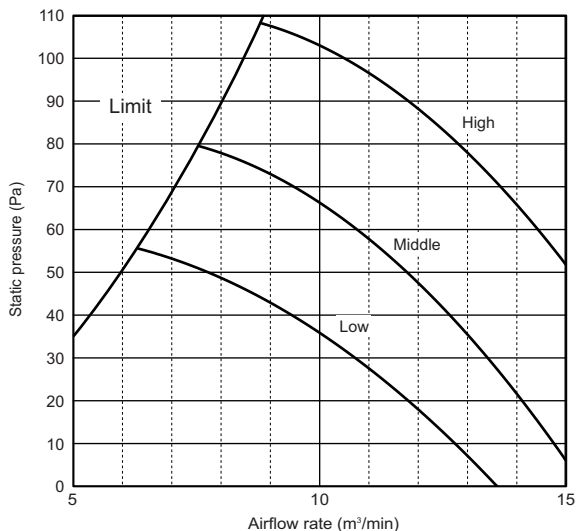

PEFY-P32VMA(L)-E

External static pressure : 150Pa
Power source : 220-240V

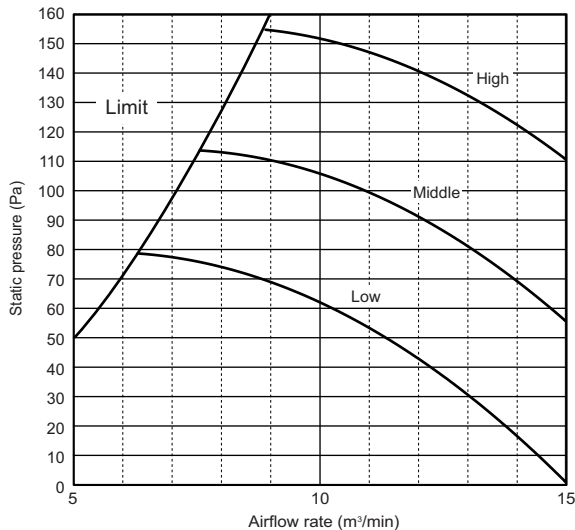

6. FAN CHARACTERISTICS CURVES

PEFY-P40VMA(L)-E

External static pressure : 35Pa
Power source : 220-240V

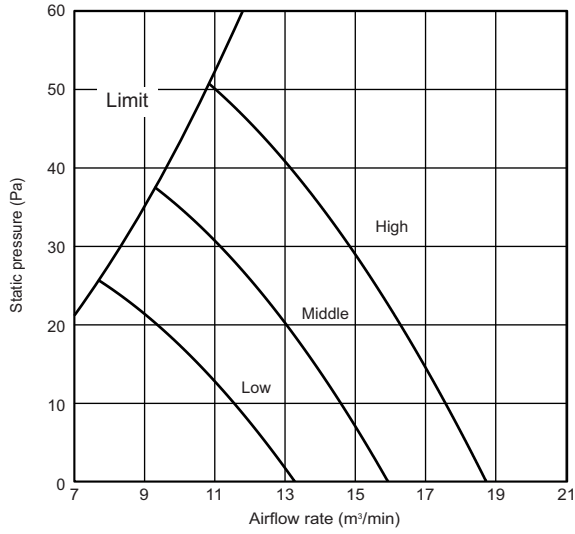

PEFY-P40VMA(L)-E

External static pressure : 50Pa
Power source : 220-240V

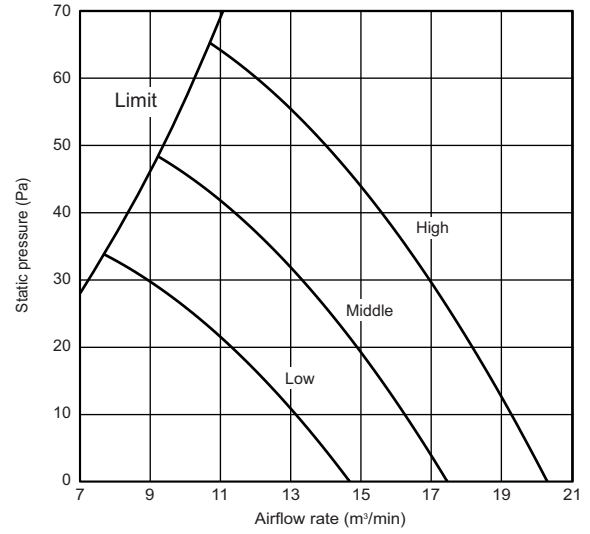

PEFY-P40VMA(L)-E

External static pressure : 70Pa
Power source : 220-240V

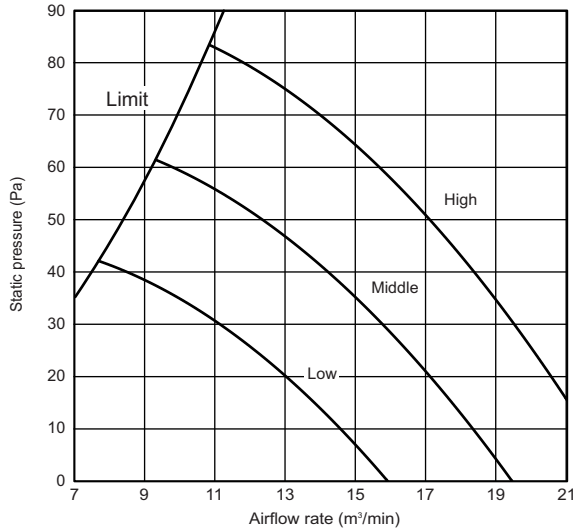

PEFY-P40VMA(L)-E

External static pressure : 100Pa
Power source : 220-240V

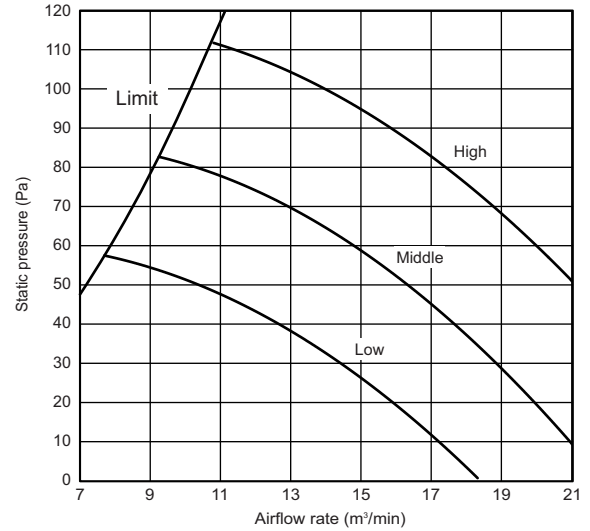

PEFY-P40VMA(L)-E

External static pressure : 150Pa
Power source : 220-240V

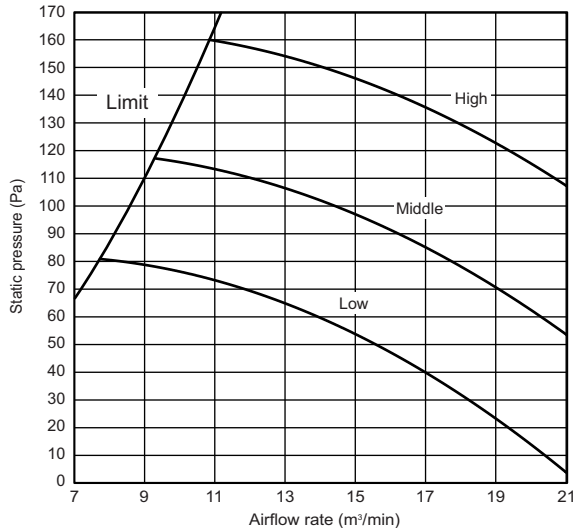

6. FAN CHARACTERISTICS CURVES

YKB/YLM

PEFY-VM(L), VMA3

PEFY-P50VMA(L)-E

External static pressure : 35Pa
Power source : 220-240V

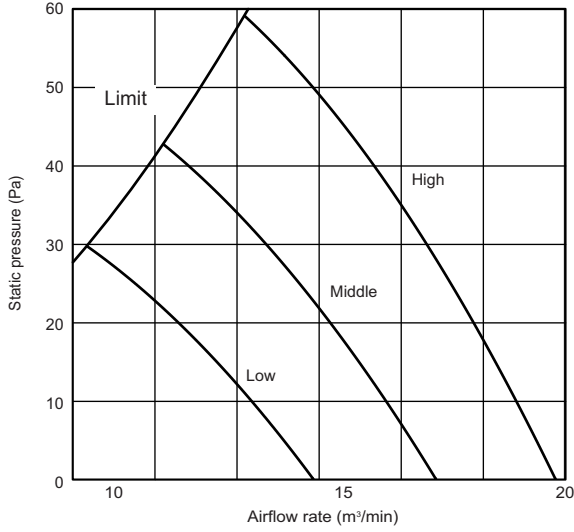

PEFY-P50VMA(L)-E

External static pressure : 50Pa
Power source : 220-240V

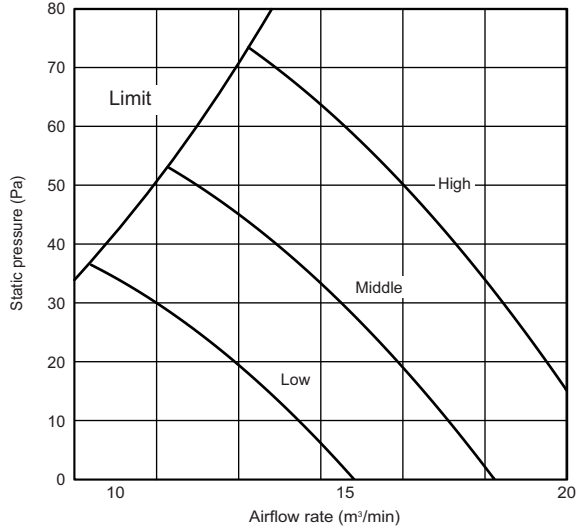

PEFY-P50VMA(L)-E

External static pressure : 70Pa
Power source : 220-240V

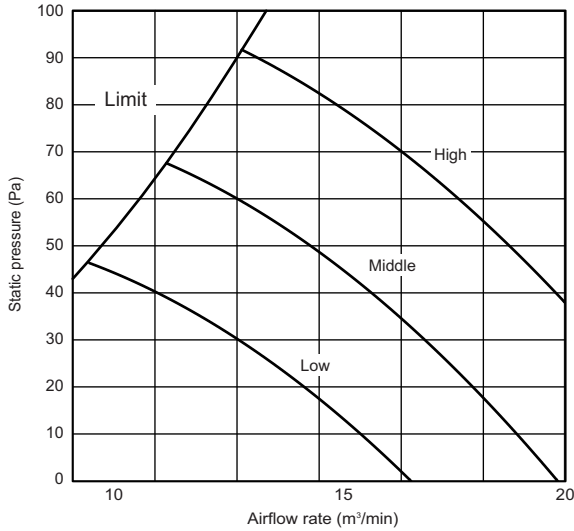

PEFY-P50VMA(L)-E

External static pressure : 100Pa
Power source : 220-240V

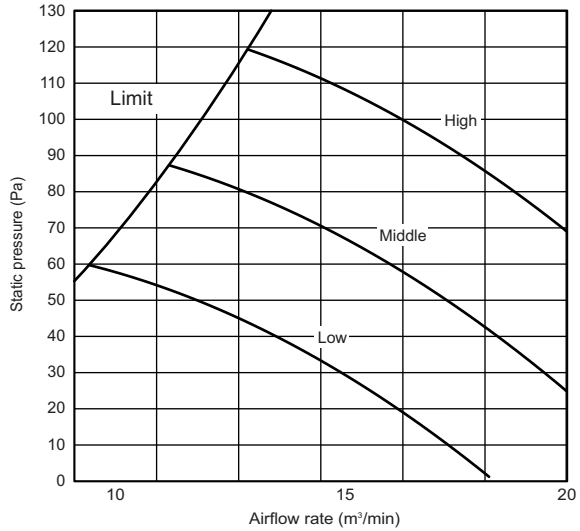

PEFY-P50VMA(L)-E

External static pressure : 150Pa
Power source : 220-240V

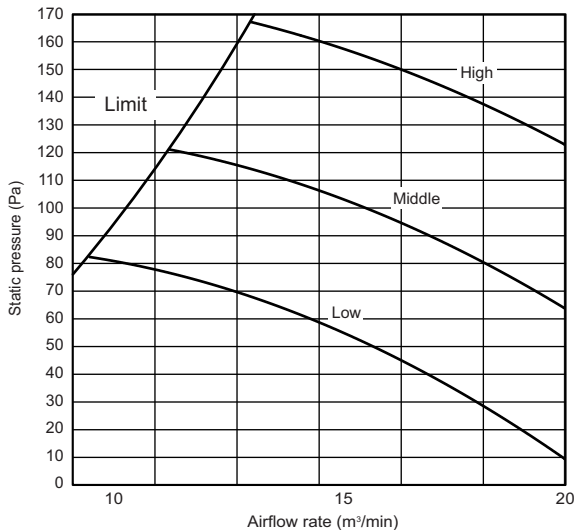

6. FAN CHARACTERISTICS CURVES

PEFY-P63VMA(L)-E

External static pressure : 35Pa
Power source : 220-240V

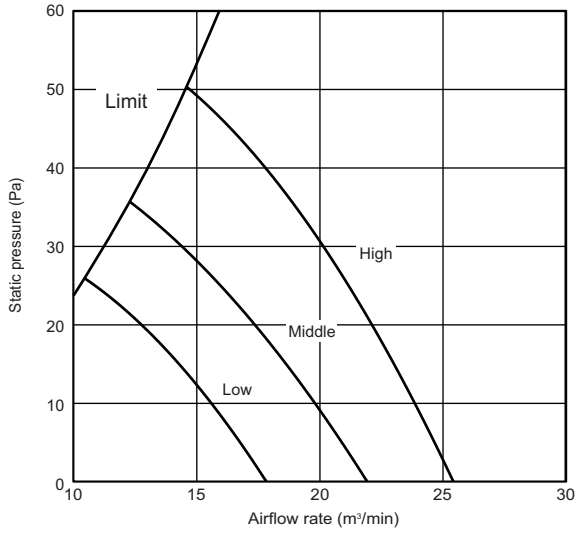

PEFY-P63VMA(L)-E

External static pressure : 50Pa
Power source : 220-240V

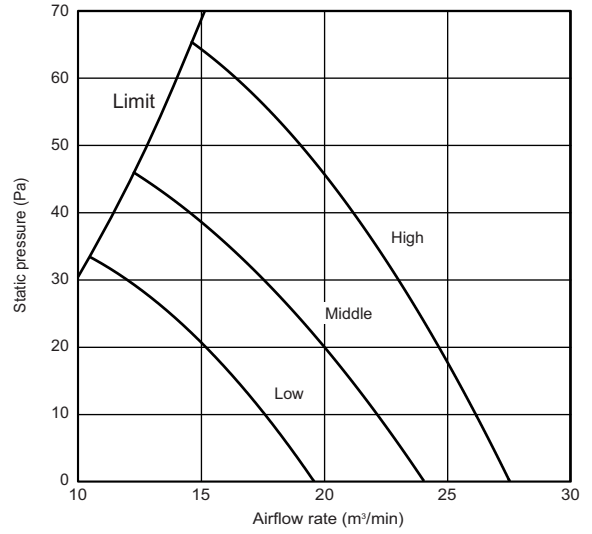

PEFY-P63VMA(L)-E

External static pressure : 70Pa
Power source : 220-240V

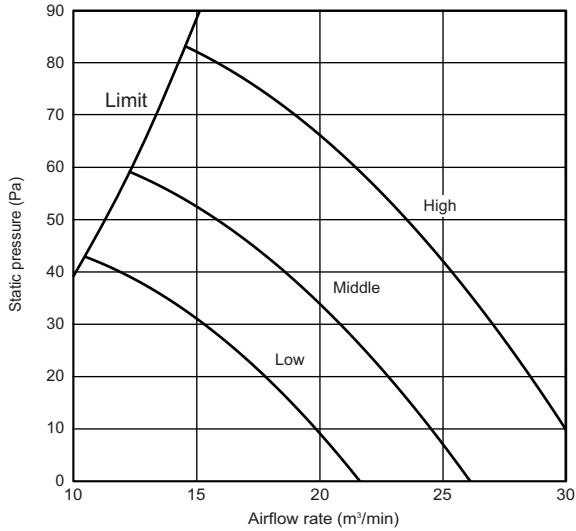

PEFY-P63VMA(L)-E

External static pressure : 100Pa
Power source : 220-240V

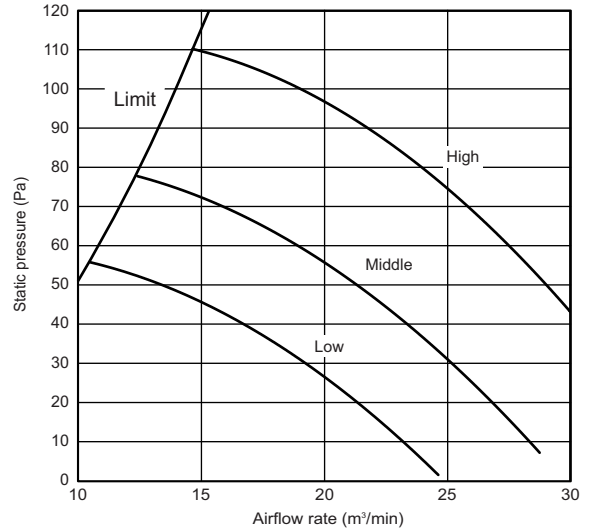

PEFY-P63VMA(L)-E

External static pressure : 150Pa
Power source : 220-240V

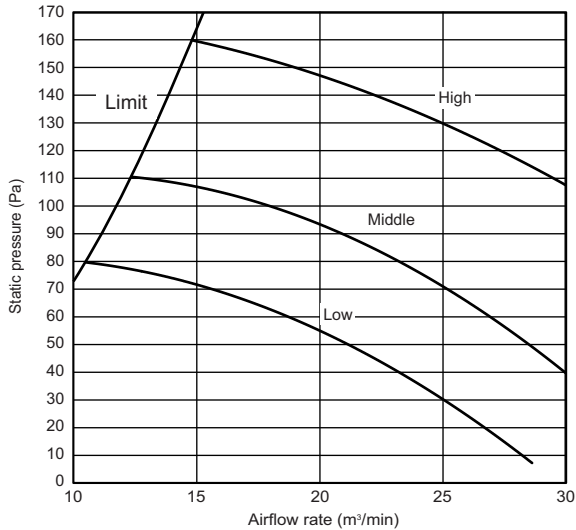

6. FAN CHARACTERISTICS CURVES

YKB/YLM

PEFY-VM(L), VMA3

PEFY-P71,80VMA(L)-E

External static pressure : 35Pa
Power source : 220-240V

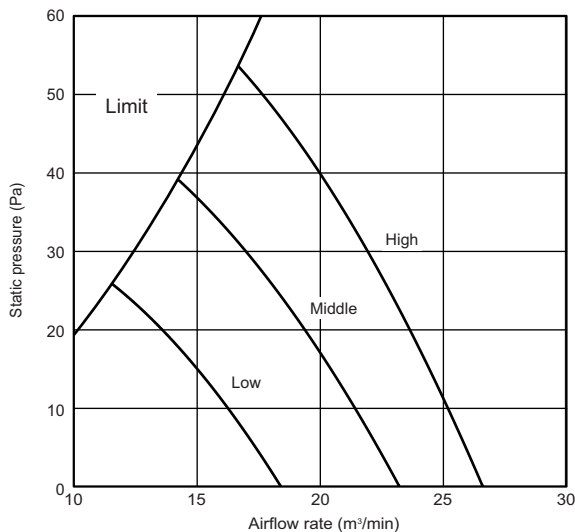

PEFY-P71,80VMA(L)-E

External static pressure : 50Pa
Power source : 220-240V

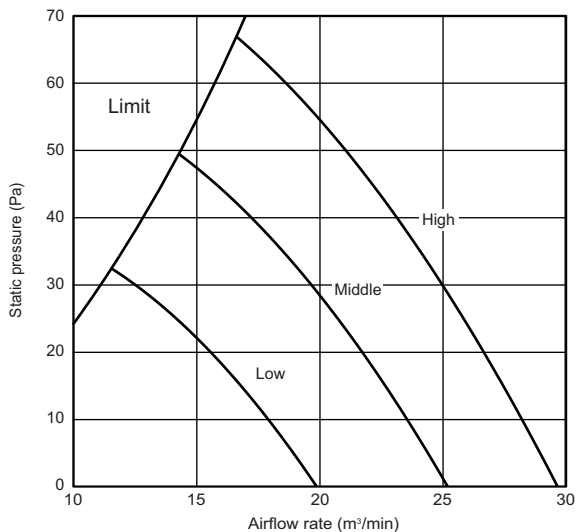

PEFY-P71,80VMA(L)-E

External static pressure : 70Pa
Power source : 220-240V

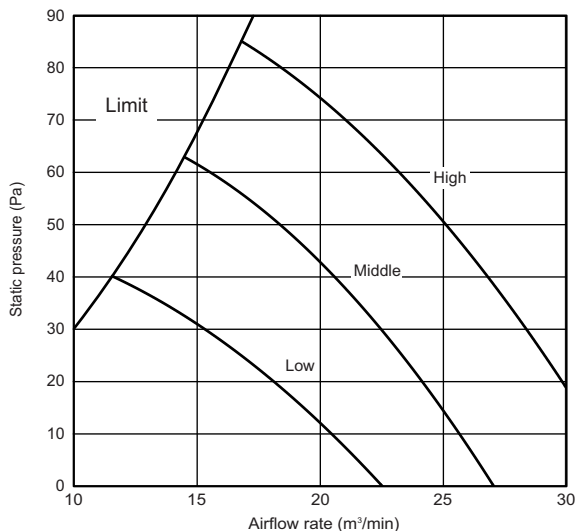

PEFY-P71,80VMA(L)-E

External static pressure : 100Pa
Power source : 220-240V

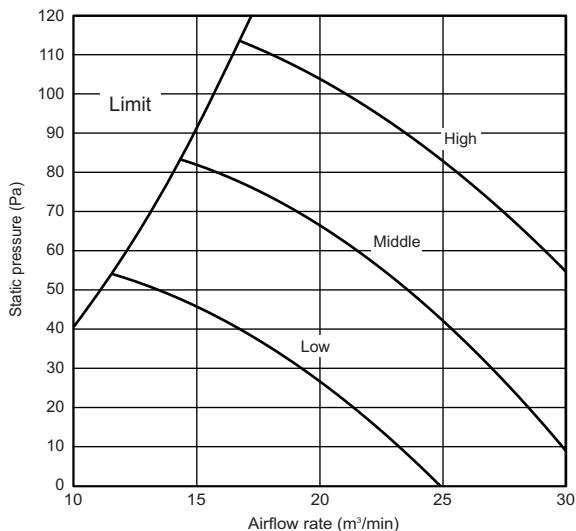

PEFY-P71,80VMA(L)-E

External static pressure : 150Pa
Power source : 220-240V

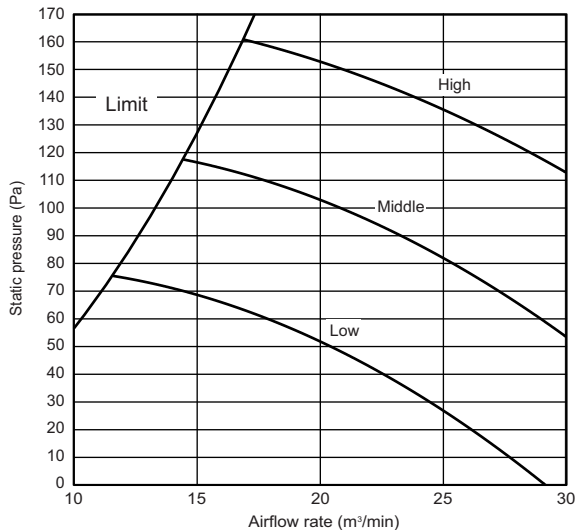

6. FAN CHARACTERISTICS CURVES

PEFY-P100VMA(L)-E

External static pressure : 35Pa
Power source : 220-240V

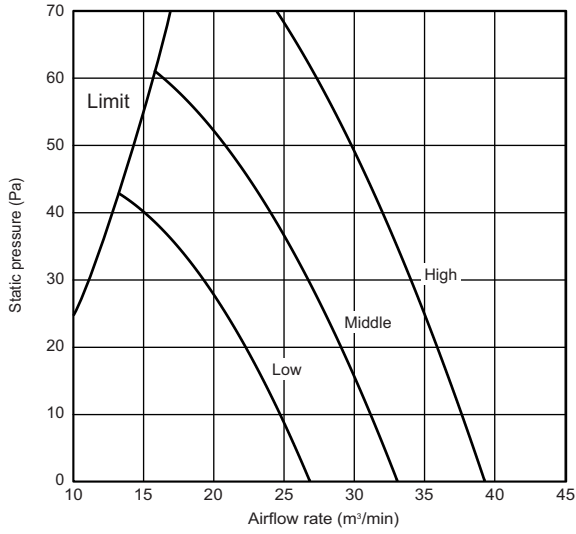

PEFY-P100VMA(L)-E

External static pressure : 50Pa
Power source : 220-240V

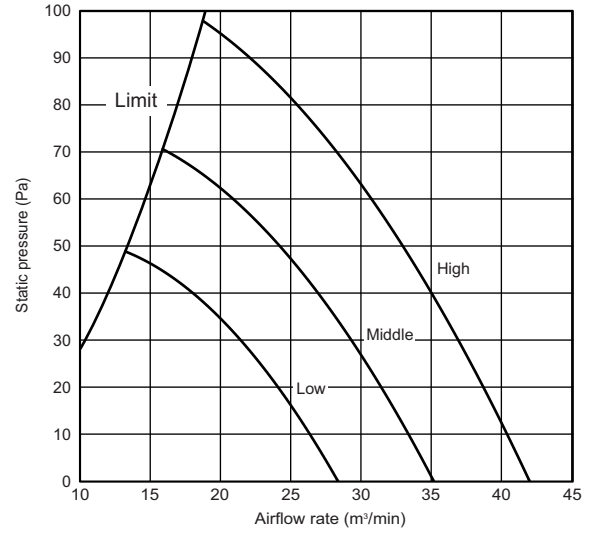

PEFY-P100VMA(L)-E

External static pressure : 70Pa
Power source : 220-240V

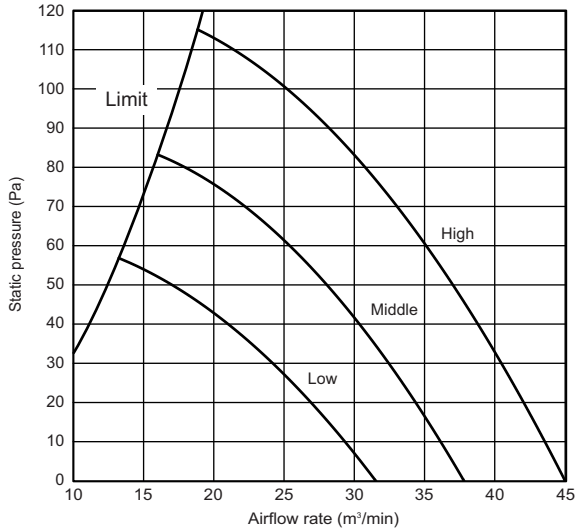

PEFY-P100VMA(L)-E

External static pressure : 100Pa
Power source : 220-240V

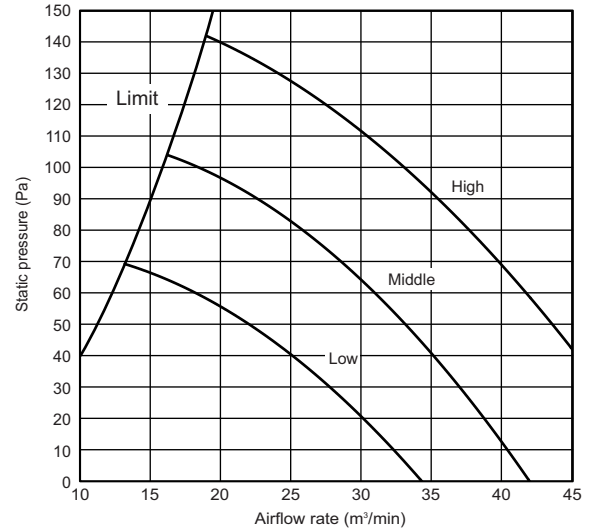

PEFY-P100VMA(L)-E

External static pressure : 150Pa
Power source : 220-240V

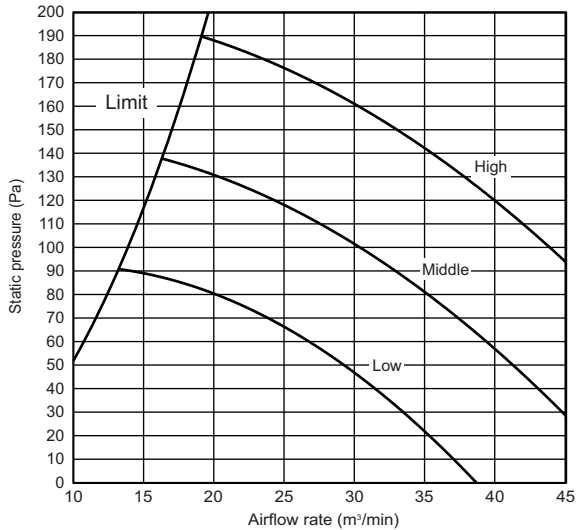

6. FAN CHARACTERISTICS CURVES

YKB/YLM

PEFY-VM(L), VMA3

PEFY-P125VMA(L)-E

External static pressure : 35Pa
Power source : 220-240V

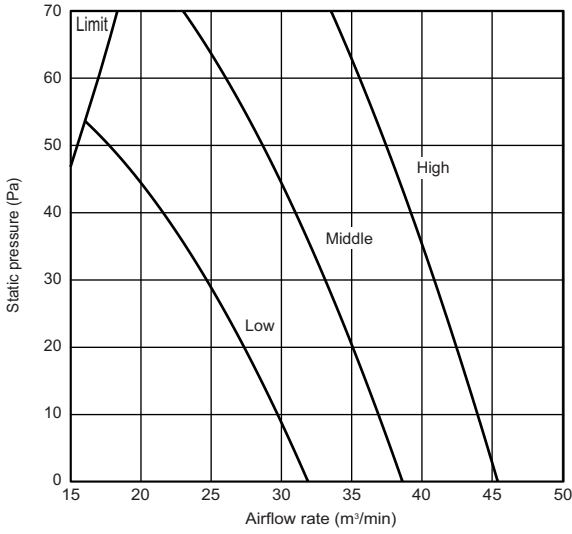

PEFY-P125VMA(L)-E

External static pressure : 50Pa
Power source : 220-240V

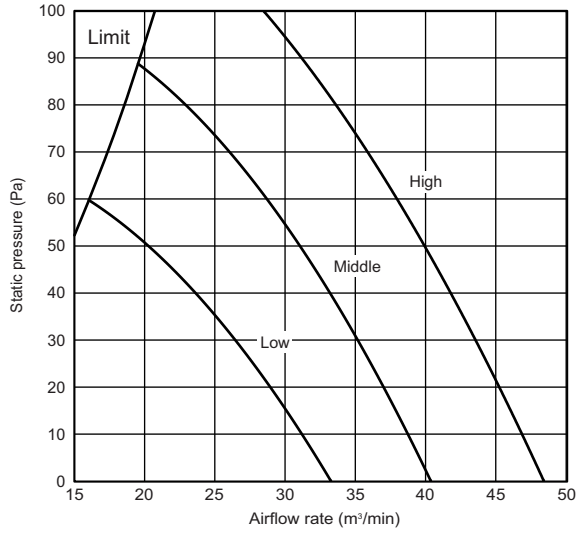

PEFY-P125VMA(L)-E

External static pressure : 70Pa
Power source : 220-240V

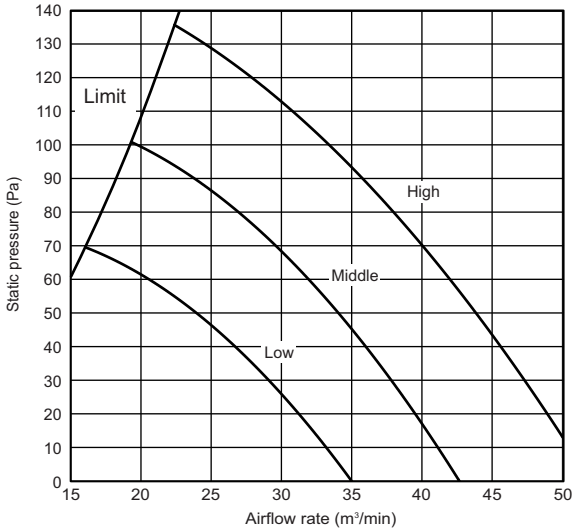

PEFY-P125VMA(L)-E

External static pressure : 100Pa
Power source : 220-240V

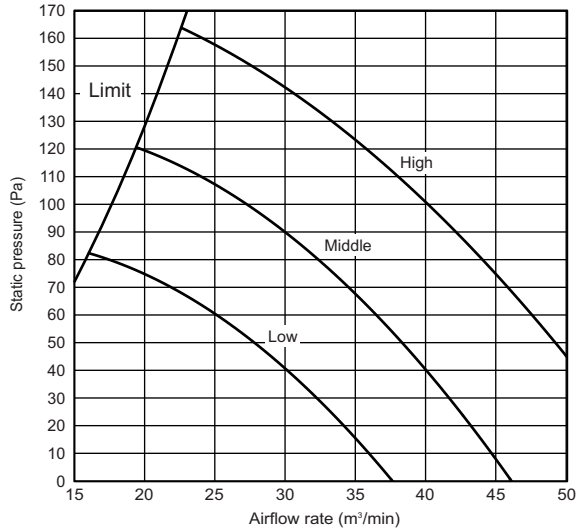

PEFY-P125VMA(L)-E

External static pressure : 150Pa
Power source : 220-240V

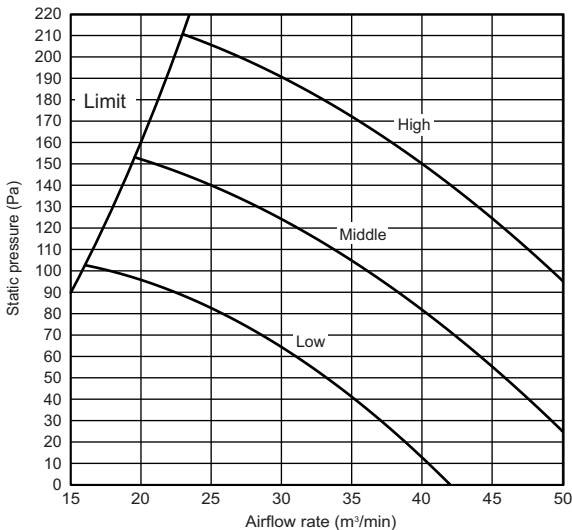

6. FAN CHARACTERISTICS CURVES

PEFY-P140VMA(L)-E

External static pressure : 35Pa
Power source : 220-240V

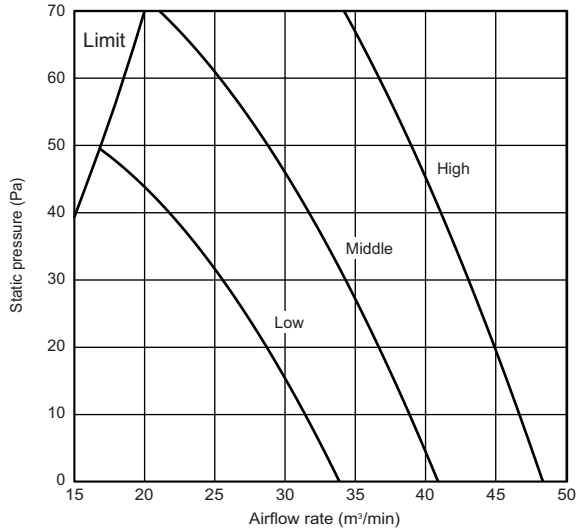

PEFY-P140VMA(L)-E

External static pressure : 50Pa
Power source : 220-240V

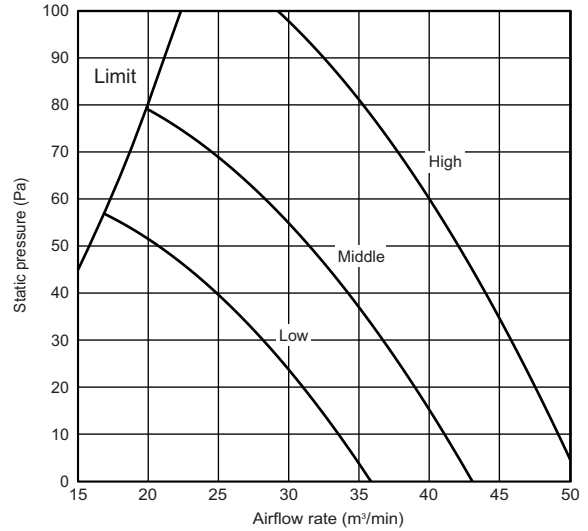

PEFY-P140VMA(L)-E

External static pressure : 70Pa
Power source : 220-240V

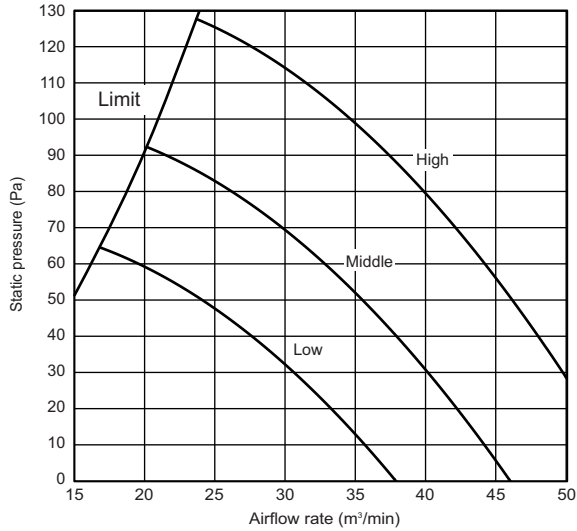

PEFY-P140VMA(L)-E

External static pressure : 100Pa
Power source : 220-240V

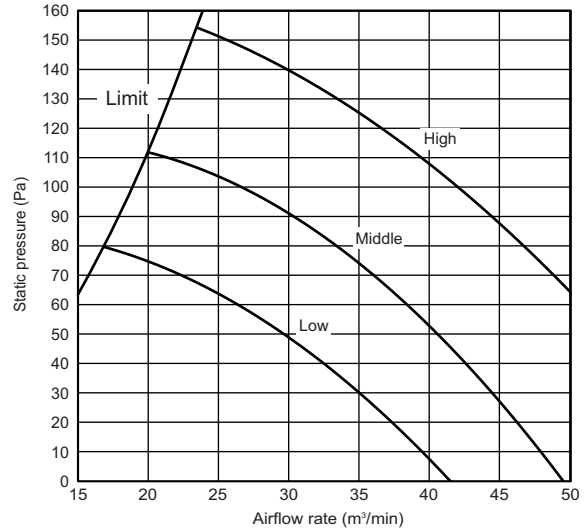

PEFY-P140VMA(L)-E

External static pressure : 150Pa
Power source : 220-240V

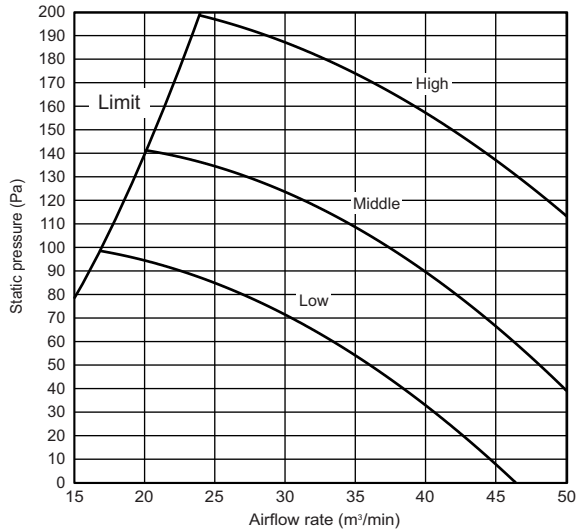

6. FAN CHARACTERISTICS CURVES

YKB/YLM

PEFY-VM(A)(L), VMA3

PEFY-P20VMA3-E

External static pressure : 35Pa
Power source : 220-240V

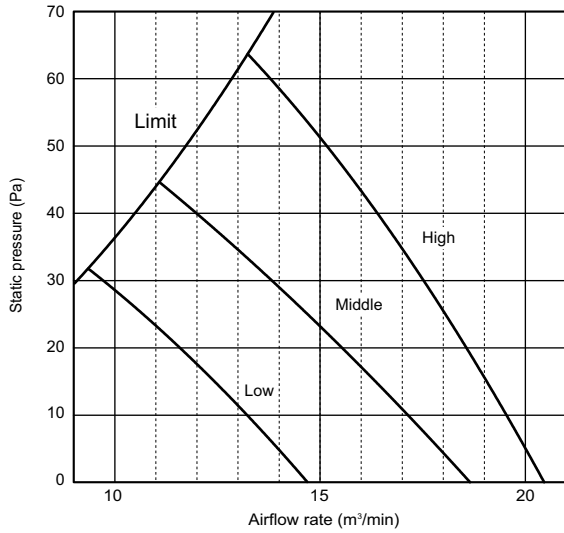

PEFY-P20VMA3-E

External static pressure : 50Pa
Power source : 220-240V

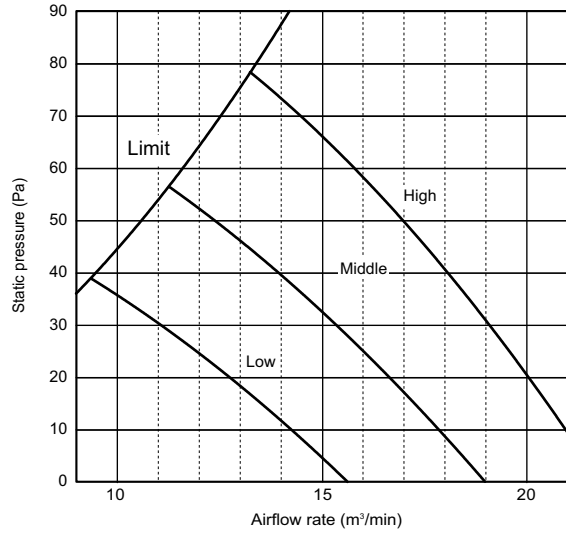

PEFY-P20VMA3-E

External static pressure : 70Pa
Power source : 220-240V

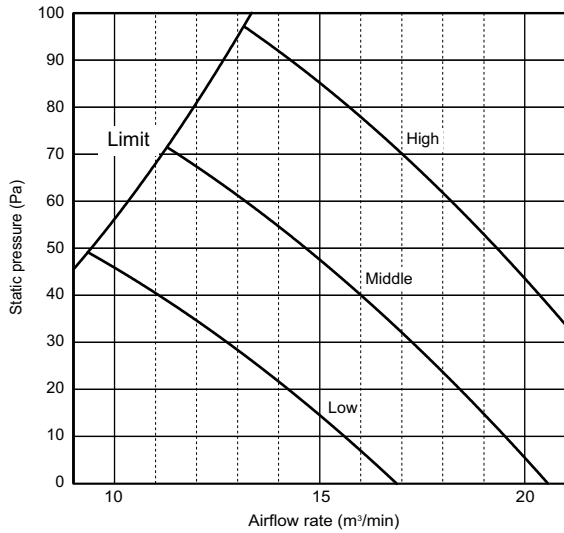

PEFY-P20VMA3-E

External static pressure : 100Pa
Power source : 220-240V

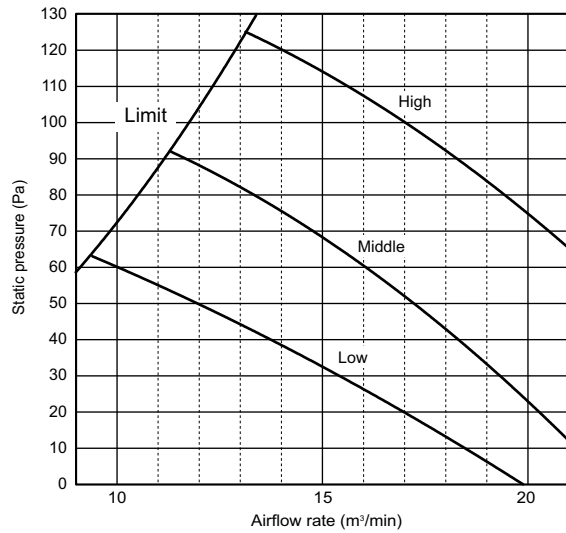

PEFY-P20VMA3-E

External static pressure : 125Pa
Power source : 220-240V

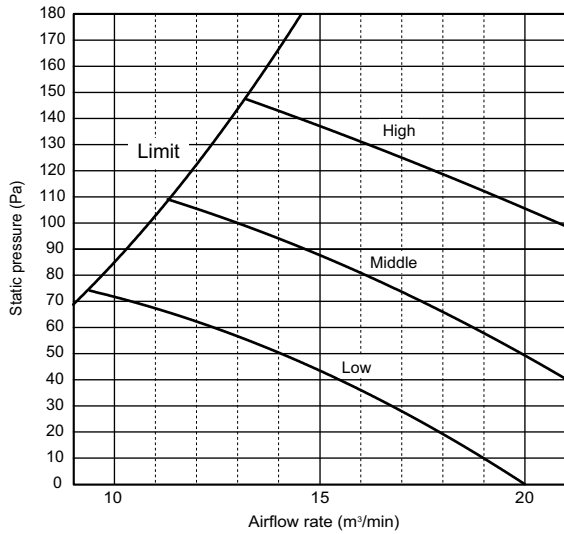

7-1. Optional parts line up for the Indoor unit

	Filter box
PEFY-P20, 25, 32VMA(L)-E	PAC-KE91TB-E
PEFY-P40, 50VMA(L)-E, P20VMA3-E	PAC-KE92TB-E
PEFY-P63, 71, 80VMA(L)-E	PAC-KE93TB-E
PEFY-P100, 125VMA(L)-E	PAC-KE94TB-E
PEFY-P140VMA(L)-E	PAC-KE95TB-E

● PEFY-P-VMA(L)-E, VMA3-E

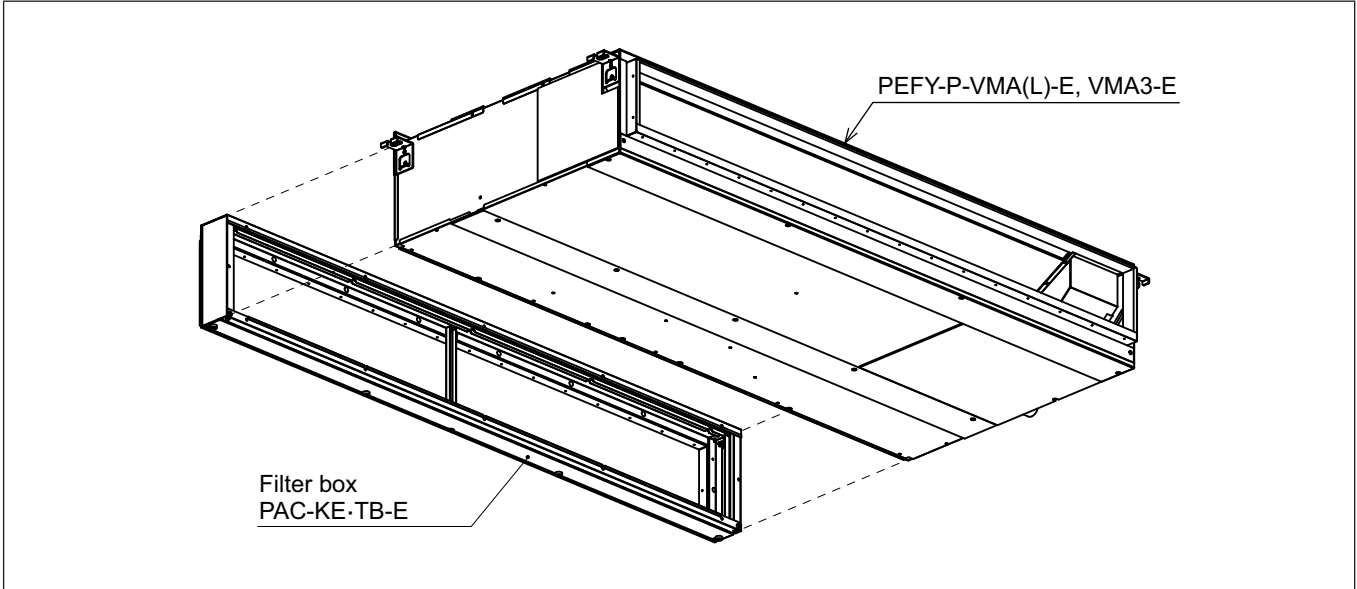

7-2. Filter box

PAC-KE-TB-E

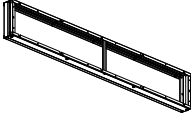
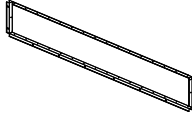
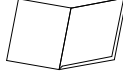
Item	1 Screw	2 Filter box	3 FLANGE	4 Installation manual	
Quantity	30	1	1	1	
Shape					

Detailed installation information should be referred to its Installation Manual.

PEFY-P- VMH-E-F

1. SPECIFICATIONS	1 - 90
2. EXTERNAL DIMENSIONS	1 - 91
3. CENTER OF GRAVITY	1 - 93
4. ELECTRICAL WIRING DIAGRAMS	1 - 94
5. SOUND LEVELS	1 - 96
5-1. Sound levels	1 - 96
5-2. NC curves	1 - 97
6. FAN CHARACTERISTICS CURVES.....	1 - 100
7. CAPACITY TABLES	1 - 103
7-1. Cooling capacity	1 - 103
7-2. Outlet air temp. cooled.....	1 - 104
7-3. Heating capacity	1 - 105
7-4. Outlet air temp. heated	1 - 106
8. OPTIONAL PARTS.....	1 - 107
8-1. Optional parts line up for the Indoor unit.....	1 - 107
8-2. Long-life filter	1 - 107
8-3. Drain pump	1 - 108

1. SPECIFICATIONS

YKB/YLM

PEFY-E-F

Model			PEFY-P80VMH-E-F	PEFY-P140VMH-E-F	PEFY-P200VMH-E-F	PEFY-P250VMH-E-F	
Power source			1-phase 220-240V 50Hz, 1-phase 208-230V 60Hz		3-phase, 4-wire, 380-415V 50/60Hz		
Cooling capacity (Nominal)	*1	kW	9.0	16.0	22.4	28.0	
	*1	kcal / h	7,700	13,800	19,300	24,100	
	*1	BTU / h	30,700	54,600	76,400	95,500	
	*2	kcal / h	-	-	-	-	
	*4	Power input	0.16/0.21	0.29/0.33	0.34/0.42	0.39/0.50	
*4	Current input	A	0.67/0.91	1.24/1.48	0.58/0.74	0.68/0.86	
Temp. range of Cooling			21°CDB/15.5°CWB ~ 43°CDB/35°CWB 70°FDB/60°FWB ~ 109°FDB/95°FWB *Thermo-off (FAN-mode) automatically starts if the outdoor temperature is lower than 21°CDB (70°FDB).				
Heating capacity (Nominal)	*3	kW	8.5	15.1	21.2	26.5	
	*3	kcal / h	7,300	13,000	18,200	22,800	
	*3	BTU / h	29,000	51,500	72,300	90,400	
	*4	Power input	0.16/0.21	0.29/0.33	0.34/0.42	0.39/0.50	
	*4	Current input	A	0.67/0.91	1.24/1.48	0.58/0.74	0.68/0.86
Temp. range of Heating			-10°CDB ~ 20°CDB 14°FDB ~ 68°FDB *Thermo-off (FAN-mode) automatically starts if the outdoor temperature is higher than 20°CDB (68°FDB).				
External finish			Galvanized				
External dimension H x W x D		mm	380 x 1,000 x 900	380 x 1,200 x 900	470 x 1,250 x 1,120	470 x 1,250 x 1,120	
		in.	15 x 39-3/8 x 35-7/16	15 x 47-2/8 x 35-7/16	18-9/16 x 49-1/4 x 44-1/8	18-9/16 x 49-1/4 x 44-1/8	
Net weight		kg (lbs)	50 (111)	67 (148)	100 (221)	100 (221)	
Heat exchanger			Cross fin (Aluminum fin and copper tube)				
FAN	Type x Quantity		Sirocco fan x 1	Sirocco fan x 2	Sirocco fan x 2	Sirocco fan x 2	
	External static press.	(208V)	Pa	<35> -85- <170>	<35> -85- <170>	<140> -200	<110> -190
			mmH ₂ O	<3.6> -8.7- <17.3>	<3.6> -8.7- <17.3>	<14.3> -20.4 (380V)	<11.2> -19.4 (380V)
		(220V)	Pa	<40> -115- <190>	<50> -115- <190>	<150> -210	<120> -200
			mmH ₂ O	<4.1> -11.7- <19.4>	<5.1> -11.7- <19.4>	<15.3> -21.4 (400V)	<12.2> -20.4 (400V)
	(230V)	Pa	<50> -130- <210>	<60> -130- <220>	<160> -220	<130> -210	
		mmH ₂ O	<5.1> -13.3- <21.4>	<6.1> -13.3- <22.4>	<16.3> -22.4 (415V)	<13.3> -21.4 (415V)	
	(240V)	Pa	<80> -170- <220>	<100> -170- <240>	-	-	
		mmH ₂ O	<8.2> -17.3- <22.4>	<10.2> -17.3- <24.5>	-	-	
	Motor type		Single phase induction motor		3-phase induction motor		
Motor output		kW	0.09 (220V, 115Pa)	0.14 (220V, 115Pa)	0.20 (415V, 220Pa)	0.23 (415V, 210Pa)	
Driving mechanism		Direct-driven by motor					
Airflow rate (Low-Mid-High)		m ³ / min	9.0	18.0	28.0	35.0	
		L / s	150	300	467	583	
		cfm	318	636	989	1,236	
Sound pressure level (Low-Mid-High)/(Low-High) (measured in anechoic room)		dB <A>	27-38-43 (208,220V)	28-38-43 (208,220V)	39-42 (380V)	40-44 (380V)	
		dB <A>	33-43-45 (230,240V)	34-43-45 (230,240V)	40-43 (400V)	40-45 (400V)	
		dB <A>	-	-	40-44 (415V)	41-46 (415V)	
Insulation material			EPS, Polyethylene foam				
Air filter			Optional long life filter (synthetic fiber unwoven cloth filter) and filter box are recommended. Field supplied filter is also possible.				
Protection device			Fuse				
Refrigerant control device			LEV				
Connectable outdoor unit			R410A CITY MULTI				
Diameter of refrigerant pipe	Liquid (R410A)	mm (in.)	ø9.52 (ø3/8) Flare	ø9.52 (ø3/8) Flare	ø9.52 (ø3/8) Brazed	ø9.52 (ø3/8) Brazed	
	Gas (R410A)	mm (in.)	ø15.88 (ø5/8) Flare	ø15.88 (ø5/8) Flare	ø19.05 (ø3/4) Brazed	ø22.2 (ø7/8) Brazed	
Field drain pipe size		mm (in.)	O.D. 32mm (1-1/4)				
Drawing	External		IU-W27-5926		IU-W27-7653		
	Wiring		IU-W65-3961		IU-W65-3999		
	Refrigerant cycle		-		-		
Standard attachment	Document		Installation Manual, Instruction Book				
	Accessory		Insulation pipe for refrigerant pipe, washer, drain hose, tie band, pipe				
Remark	Optional long life filter		PAC-KE88LAF	PAC-KE89LAF	PAC-KE85LAF	PAC-KE85LAF	
	Optional filter box		PAC-KE80TB-F	PAC-KE140TB-F	PAC-KE250TB-F	PAC-KE250TB-F	
	Drain pump		PAC-KE04DM-F	PAC-KE04DM-F	PAC-KE04DM-F	PAC-KE04DM-F	
			a. When the PEFY-P-VMH-E-F is connected with the outdoor unit, the maximum connectable total indoor unit capacity is as follows. Heat pump model _____ Cooling only model _____ 110% (100% in case of heating below -5°C(23°F)) 110%				
			b. Only the thermo-sensor in the remote controller or an extra remote thermo-sensor can be chosen as the room temperature sensor. c. No Auto mode or Dry mode is available. d. The fan temporarily stops in defrosting. e. The air flow rate should be kept lower than 110% of value above. Please see "FAN Curve" for details. f. As PEFY-P-VMH-E-F cools the outdoor air directly, dewing at the air outlet grilles is possible, and should be considered. g. Air filter must be installed in the air intake side, and should be easy to maintain.				
Installation		Details on foundation work, duct work, insulation work, electrical wiring, power source switch, and other items shall be referred to the Installation Manual.					
Note :			*1 Nominal cooling condition	*2 Nominal cooling condition	*3 Nominal heating condition	Unit converter	
			Indoor: 33°CDB/28°CWB (91°FDB/82°FWB)	-	0°CDB/-2.9°CDB (32°FDB/27°FDB)	kcal/h = kW x 860	
			Outdoor: 33°CDB (91°FDB)	-	0°CDB/-2.9°CDB (32°FDB/27°FDB)	BTU/h = kW x 3,412	
			Pipe length: 7.5 m (24-9/16 ft)	-	7.5 m (24-9/16 ft)	cfm = m ³ /min x 35.31	
			Level difference: 0 m (0 ft)	-	0 m (0 ft)	lbs = kg / 0.4536	
			* Due to continuing improvement, above specification may be subject to change without notice.			*5 The factory setting of external static pressure is shown without < > .	
			*4 The values are measured at the factory setting of external static pressure.			Refer to "Fan characteristics curves", according to the external static pressure, in DATA BOOK for the usable range of air flow rate.	
						*Above specification data is subject to rounding variation.	

PEFY-P80,140VMH-E-F

Unit : mm

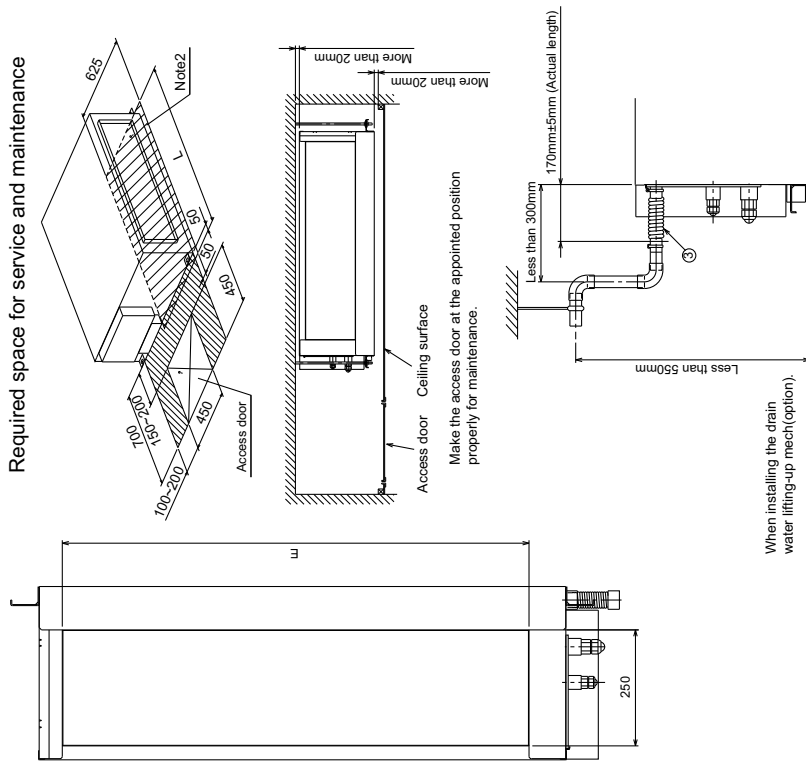

- Note 1 Use M10 screw for the lifting bolt (field supply).
 2. Keep the service space for maintenance from the bottom when the heat exchanger is cleaned.
 3. This chart indicates for PEFY-P140VMH-E-F models, which have 2 fans.
 PEFY-P80VMH-E-F model has 1 fan.
 4. Make sure to install the air filter (field supply) on the air intake side.
 In case field supplied air filter is used, attach it where the filter service is easily done.

- Refrigerant piping flare connection (gas M copper tube) ①
 Refrigerant piping flare connection (liquid N copper tube) ②
 Drain hose I.D. 32 (1-1/4") <flexible joint 200mm> (accessory) ③

Model	A	B	C	D	E	F	G	H	J	K	L	M	N
PEFY-P80VMH-E-F	1050	1004	930	850	800	25	17	800	15	700	1030	ø15.88	ø9.52
PEFY-P140VMH-E-F	1250	1204	1130	1050	1000	25	21	1000	19	900	1230	ø15.88	ø9.52

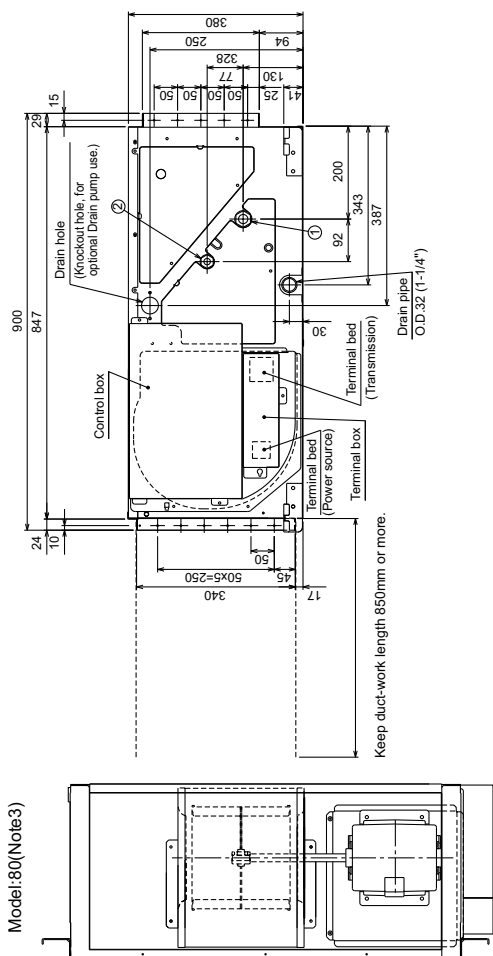
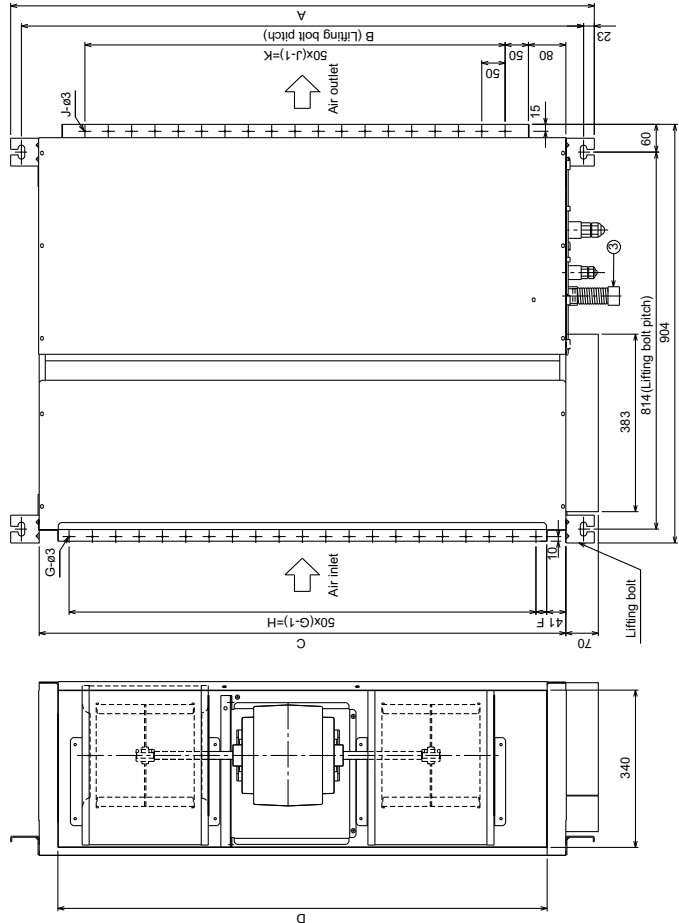

PEFY-E-F

PEFY-P200,250VMH-E-F

Unit : mm

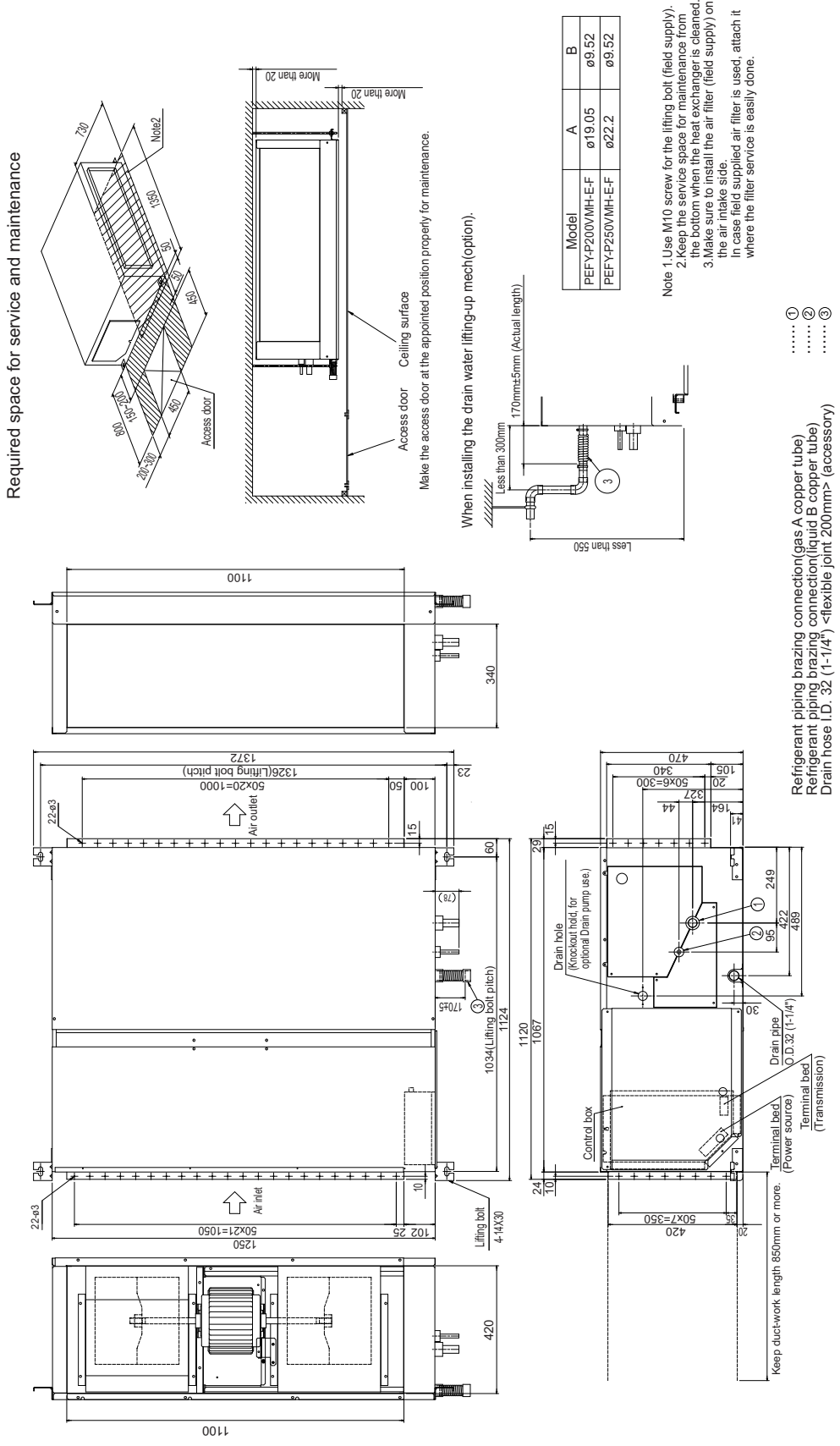

Model	A	B
PEFY-P200VMH-E-F	ø19.05	ø9.52
PEFY-P250VMH-E-F	ø22.2	ø9.52

Note 1. Use M10 screw for the lifting bolt (field supply).
 2. Keep the service space for maintenance from the bottom when the heat exchanger is cleaned.
 3. Make sure to install the air filter (field supply) on the air intake side.
 In case field supplied air filter is used, attach it where the filter service is easily done.

- ①
 - ②
 - ③
- Refrigerant piping brazing connection(gas A copper tube)
 Refrigerant piping brazing connection(liquid B copper tube)
 Drain hose I.D. 32 (1-1/4) -flexible joint 200mm- (accessory)

PEFY-P80,140,200,250VMH-E-F

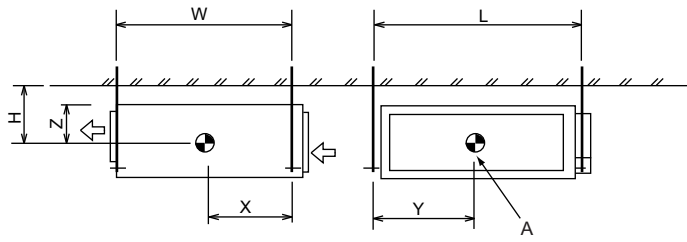

A: Center of gravity

(mm)[in]

Model name	W	L	H	X	Y	Z
PEFY-P80VMH-E-F	814 [32-1/16]	1004 [39-17/32]	210 [8-9/32]	394 [15-17/32]	584 [22-32/32]	190 [7-1/2]
PEFY-P140VMH-E-F	814 [32-1/16]	1204 [47-13/32]	210 [8-9/32]	364 [14-11/32]	649 [25-9/16]	190 [7-1/2]
PEFY-P200VMH-E-F	1034 [40-23/32]	1326 [52-7/32]	255 [10-1/16]	462 [18-7/32]	660 [25-32/32]	235 [9-9/32]
PEFY-P250VMH-E-F	1034 [40-23/32]	1326 [52-7/32]	255 [10-1/16]	462 [18-7/32]	660 [25-32/32]	235 [9-9/32]

PEFY-E-F

PEFY-P80, 140VMH-E-F

INSIDE SECTION OF CONTROL BOX

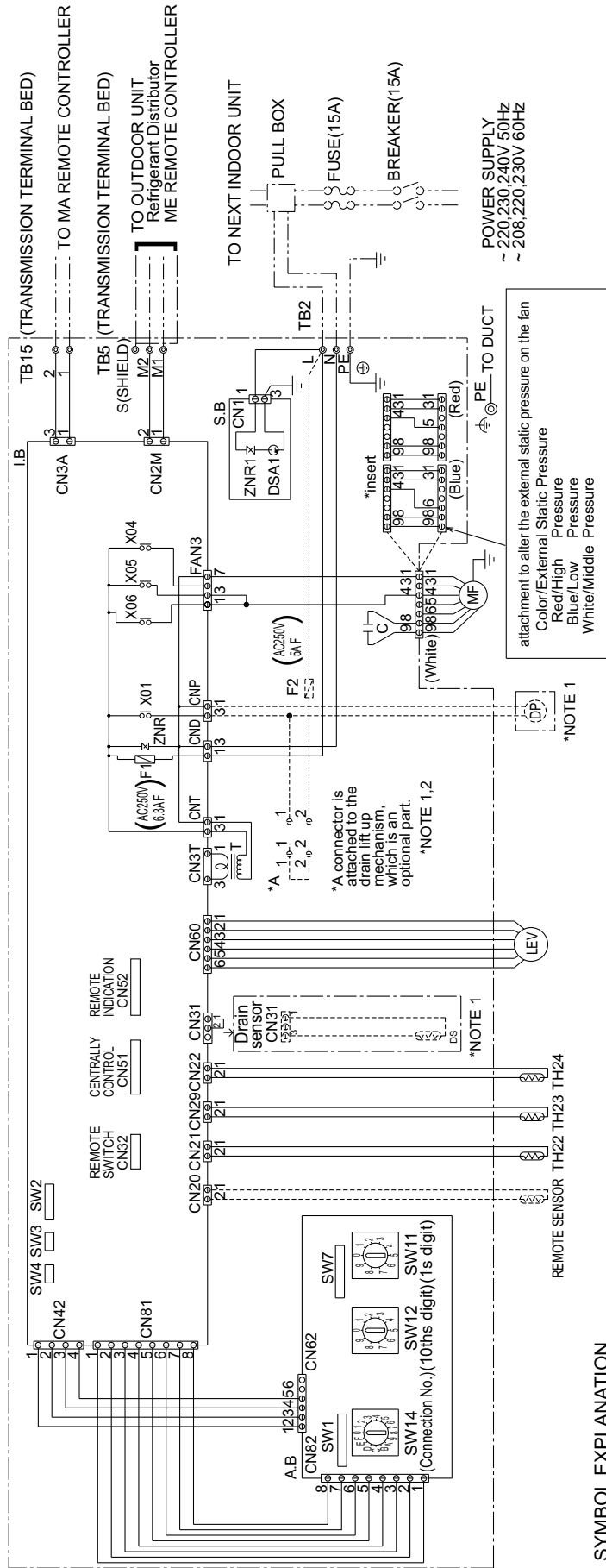

SYMBOL EXPLANATION

SYMBOL	NAME	SYMBOL	NAME
MF	Fan motor	CN20	Connector (remote sensor)
C	B Capacitor (for MF)	TH22	Thermistor (piping temp.detection/liquid)
LB	Indoor controller board	TH23	Thermistor (piping temp.detection/gas)
<DS>	Drain sensor	TH24	Thermistor (outdoor air temp.detection)
A.B	Address board	SW11(A.B)	Switch (1s digit address set)
TB2	Power source terminal bed	SW12(A.B)	Switch (10ths digit address set)
TB5	Transmission terminal bed	SW14(A.B)	Switch (connection No.set)
TB15	Transmission terminal bed	SW1(A.B)	Switch (for mode selection)
F1	Fuse AC250V 5A F	SW2(L.B)	Switch (for capacity code)
<F2>	Fuse AC250V 6.3A F	SW3(L.B)	Switch (for mode selection)
T	Transformer	SW4(L.B)	Switch (for model selection)
<DP>	Drain Pump	SW7(A.B)	Switch (for model selection)
LEV	Electronic linear expans. valve	X04 ~ X06	Aux.relay
S.B	Surge absorber board		

Inside < > is the optional parts.

- NOTE 1. The part of the broken line indicates the circuit for optional parts.
 2. *A in the chart is the connector for a drain pump test run operation. (The Drain Pump operates continuously, if the connector is inserted and the power is supplied.) After the test run, make sure to remove the *A connector.
 3. The wirings to TB2, TB5 (shown in dotted line) are field work.
 4. Mark ⊕ indicates terminal bed, ⊖ connector, ⊞ board insertion connector or fastening connector of control board.

PEFY-P200, 250VMH-E-F

INSIDE SECTION OF CONTROL BOX

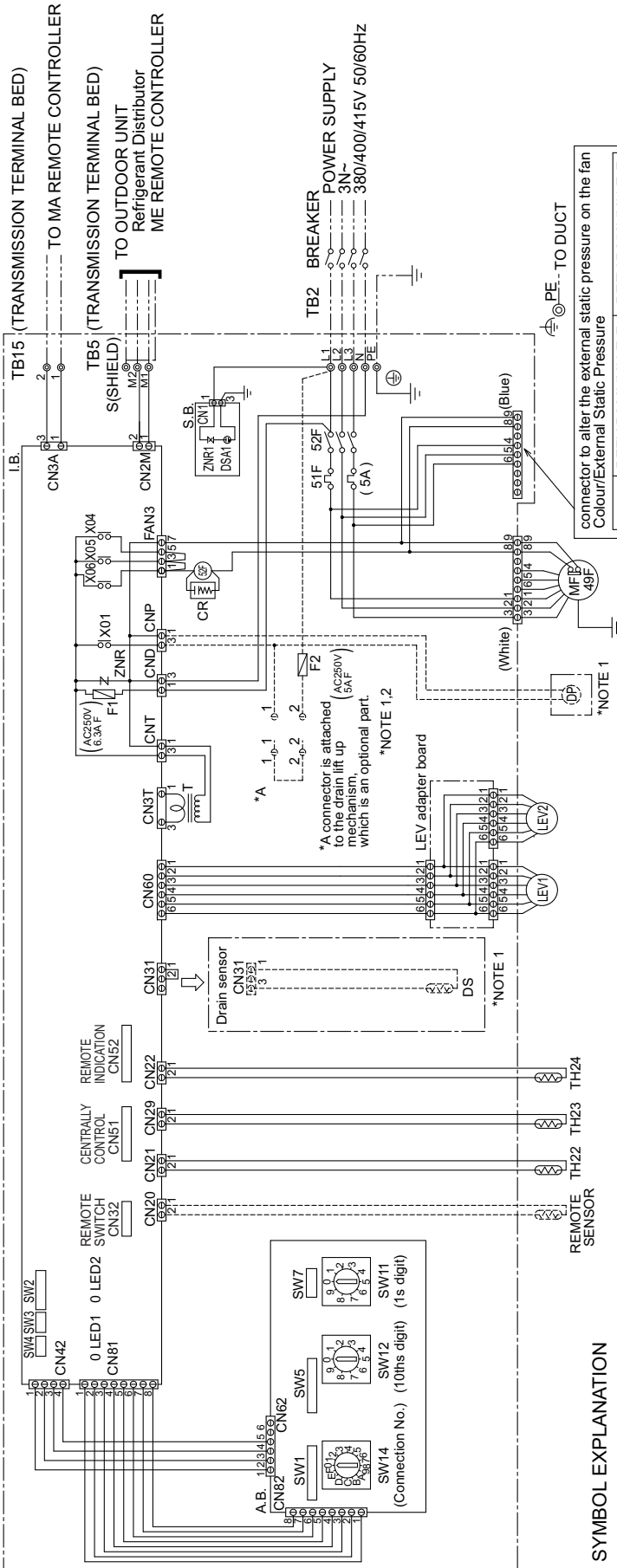

connector to alter the external static pressure on the fan Colour/External Static Pressure

Colour	PEFY-P200VMH-E-F	PEFY-P250VMH-E-F
Blue	140Pa (at 380V) 150Pa (at 400V) 160Pa (at 415V)	110Pa (at 380V) 120Pa (at 400V) 130Pa (at 415V)
White	200Pa (at 380V) 210Pa (at 400V) 220Pa (at 415V)	190Pa (at 380V) 200Pa (at 400V) 210Pa (at 415V)

- CAUTION:** 1. To protect Fan motor from abnormal current, Over current relays <51F> is installed. Therefore, do not change factory set value of Over current relays.
 NOTE: 1. The part of the broken line indicates the circuit for optional parts.
 2. *A in the chart is the connector for a drain pump test run operation. (The Drain Pump operates continuously if the connector is inserted and the power is supplied.)
 After the test run, make sure to remove the *A connector.
 3. The wirings to TB2, TB5 shown in dotted line are field work.
 4. Mark ⊕ indicates terminal bed, ⊖ connector, ⊞ board insertion connector or fastening connector of control board.

SYMBOL EXPLANATION

SYMBOL	NAME	SYMBOL	NAME
MF	Fan motor	TH22	Thermistor (piping temp. detection/liquid)
I.B.	Indoor controller board	TH23	Thermistor (piping temp. detection/gas)
A.B.	Address board	TH24	Thermistor (outdoor air temp. detection)
TB2	Power source terminal bed	SW11 (A.B.)	Switch (1s digit address set)
TB5	Transmission terminal bed	SW12 (A.B.)	Switch (10ths digit address set)
TB15	Transmission terminal bed	SW14 (A.B.)	Switch (connection No. set)
F1	Fuse AC250V 6.3A F	SW1 (A.B.)	Switch (for mode selection)
<F2>	Fuse AC250V 5A F	SW2 (I.B.)	Switch (for capacity code)
T	Transformer	SW3 (I.B.)	Switch (for mode selection)
<DP>	Drain Pump	SW4 (I.B.)	Switch (for model selection)
LEV1, LEV2	Electronic linear expan. valve	SW5 (A.B.)	Switch (for voltage selection)
<DS>	Drain sensor	SW7 (A.B.)	Switch (for model selection)
S.B.	Surge absorber board	X04-X06	Aux. relay
52F	Contact (fan motor)	49F	Inner thermostat
51F	Over current relay (fan motor)	LED1	Power Supply (I.B.)
		LED2	Power Supply (Remote Controller)

Inside < > is the optional parts.

5-1. Sound levels

PEFY-P-VMH-E-F

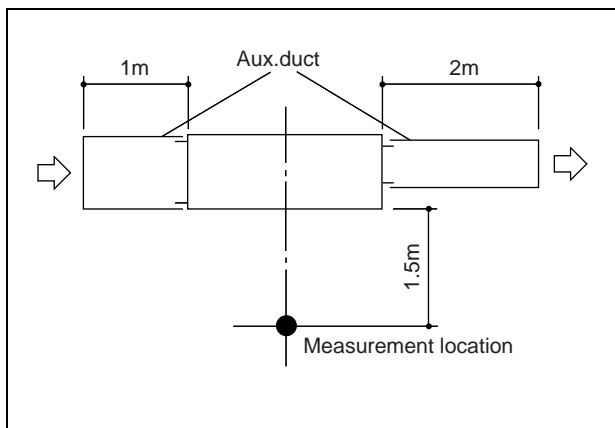

Sound level at anechoic room : Low-Mid-High, Low-High

		Sound level dB (A)
PEFY-P80VMH-E-F	208, 220V	27 - 38 - 43
	230, 240V	33 - 43 - 45
PEFY-P140VMH-E-F	208, 220V	28 - 38 - 43
	230, 240V	34 - 43 - 45
PEFY-P200VMH-E-F	380V	39 - 42
	400V	40 - 43
	415V	40 - 44
PEFY-P250VMH-E-F	380V	40 - 44
	400V	40 - 45
	415V	41 - 46

*Measured in anechoic room.

* External static pressure : Low-Mid-High, Low-High

Unit : Pa

		PEFY-P80VMH-E-F	PEFY-P140VMH-E-F	PEFY-P200VMH-E-F	PEFY-P250VMH-E-F
External static press.(Pa)	50Hz	-	-	140-200 (380V)	110-190 (380V)
	60Hz	35-85-170 (208V)	35-85-170 (208V)	140-200 (380V)	110-190 (380V)
	50Hz	40-115-190 (220V)	50-115-190 (220V)	150-210 (400V)	120-200 (400V)
	60Hz	40-115-190 (220V)	50-115-190 (220V)	150-210 (400V)	120-200 (400V)
	50Hz	50-130-210 (230V)	60-130-220 (230V)	160-220 (415V)	130-210 (415V)
	60Hz	50-130-210 (230V)	60-130-220 (230V)	160-220 (415V)	130-210 (415V)
	50Hz	80-170-220 (240V)	100-170-240 (240V)		
	60Hz	-	-		

5-2. NC curves

PEFY-E-F

PEFY-P80VMH-E-F

External static pressure : 35Pa
Power source : 208V, 60Hz

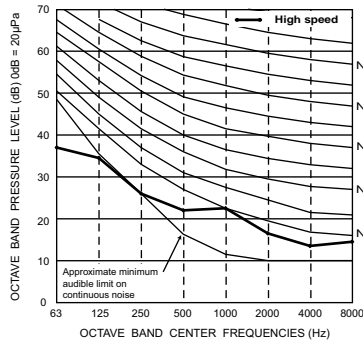

PEFY-P80VMH-E-F

External static pressure : 85Pa
Power source : 208V, 60Hz

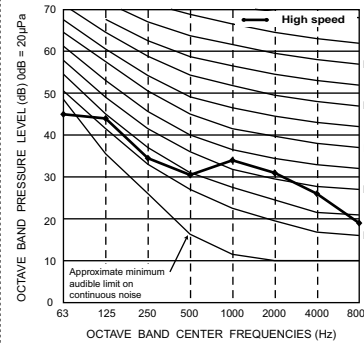

PEFY-P80VMH-E-F

External static pressure : 170Pa
Power source : 208V, 60Hz

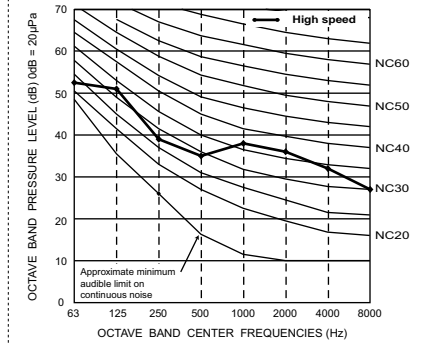

PEFY-P80VMH-E-F

External static pressure : 40Pa
Power source : 220V, 50/60Hz

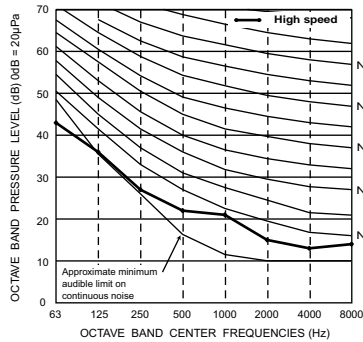

PEFY-P80VMH-E-F

External static pressure : 115Pa
Power source : 220V, 50/60Hz

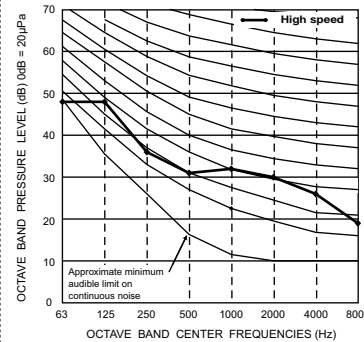

PEFY-P80VMH-E-F

External static pressure : 190Pa
Power source : 220V, 50/60Hz

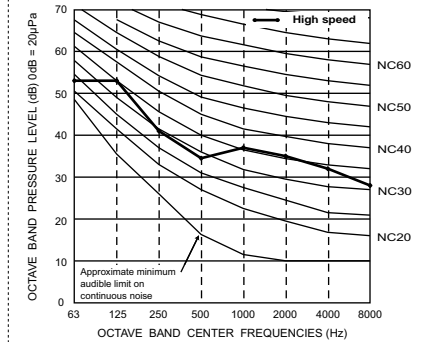

PEFY-P80VMH-E-F

External static pressure : 50Pa
Power source : 230V, 50/60Hz

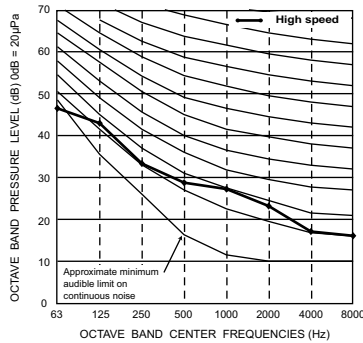

PEFY-P80VMH-E-F

External static pressure : 130Pa
Power source : 230V, 50/60Hz

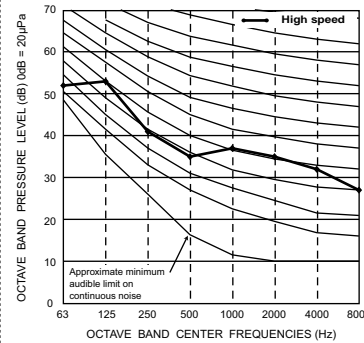

PEFY-P80VMH-E-F

External static pressure : 210Pa
Power source : 230V, 50/60Hz

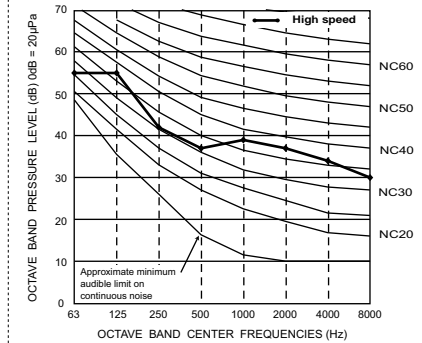

PEFY-P80VMH-E-F

External static pressure : 80Pa
Power source : 240V, 50Hz

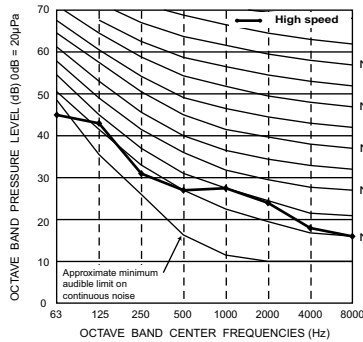

PEFY-P80VMH-E-F

External static pressure : 170Pa
Power source : 240V, 50Hz

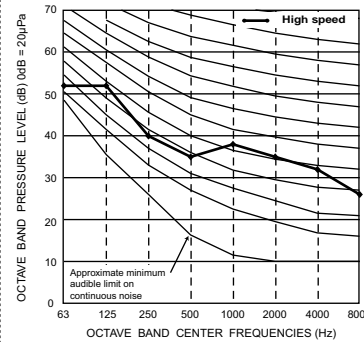

PEFY-P80VMH-E-F

External static pressure : 220Pa
Power source : 240V, 50Hz

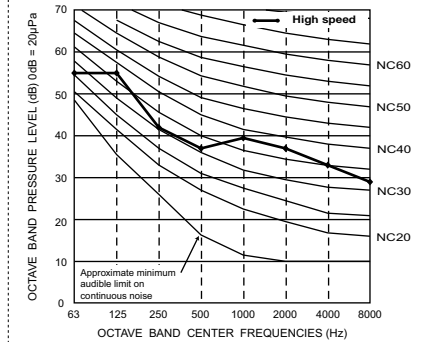

PEFY-P140VMH-E-F
 External static pressure : 35Pa
 Power source : 208V, 60Hz

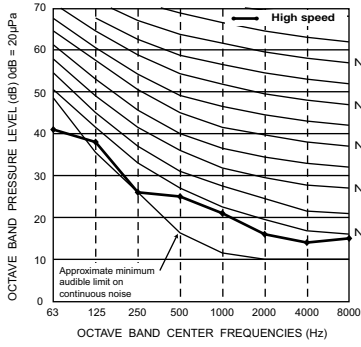

PEFY-P140VMH-E-F
 External static pressure : 85Pa
 Power source : 208V, 60Hz

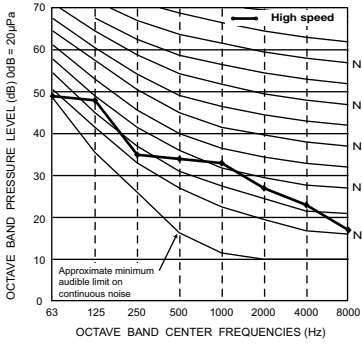

PEFY-P140VMH-E-F
 External static pressure : 170Pa
 Power source : 208V, 60Hz

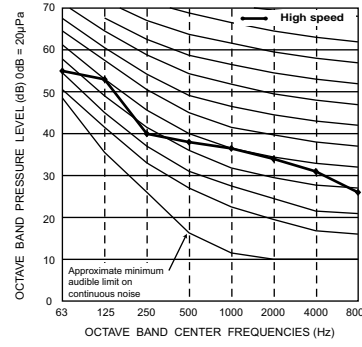

PEFY-P140VMH-E-F
 External static pressure : 50Pa
 Power source : 220V, 50/60Hz

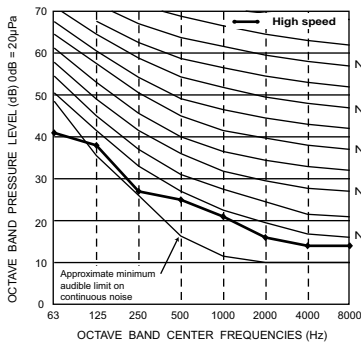

PEFY-P140VMH-E-F
 External static pressure : 115Pa
 Power source : 220V, 50/60Hz

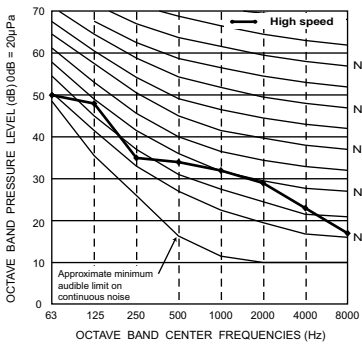

PEFY-P140VMH-E-F
 External static pressure : 190Pa
 Power source : 220V, 50/60Hz

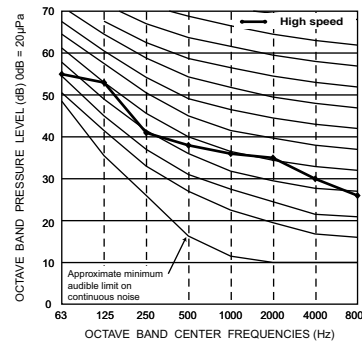

PEFY-P140VMH-E-F
 External static pressure : 60Pa
 Power source : 230V, 50/60Hz

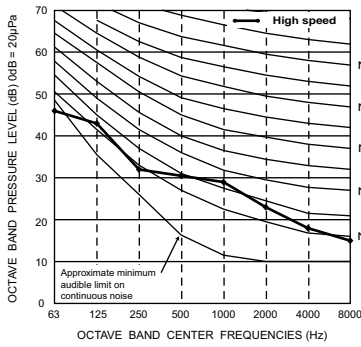

PEFY-P140VMH-E-F
 External static pressure : 130Pa
 Power source : 230V, 50/60Hz

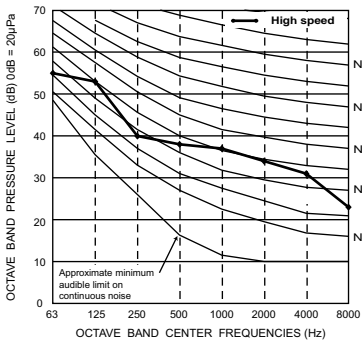

PEFY-P140VMH-E-F
 External static pressure : 220Pa
 Power source : 230V, 50/60Hz

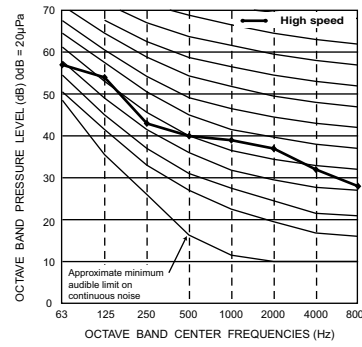

PEFY-P140VMH-E-F
 External static pressure : 100Pa
 Power source : 240V, 50Hz

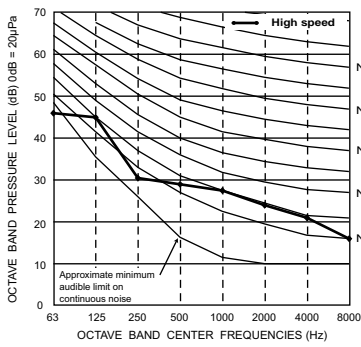

PEFY-P140VMH-E-F
 External static pressure : 170Pa
 Power source : 240V, 50Hz

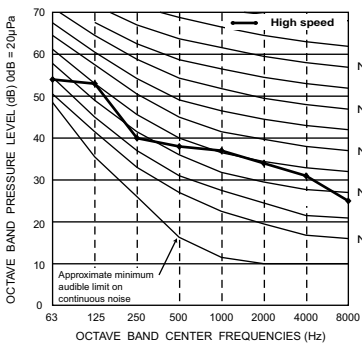

PEFY-P140VMH-E-F
 External static pressure : 240Pa
 Power source : 240V, 50Hz

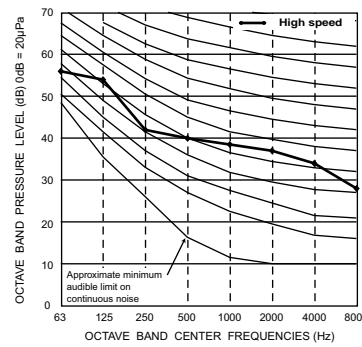

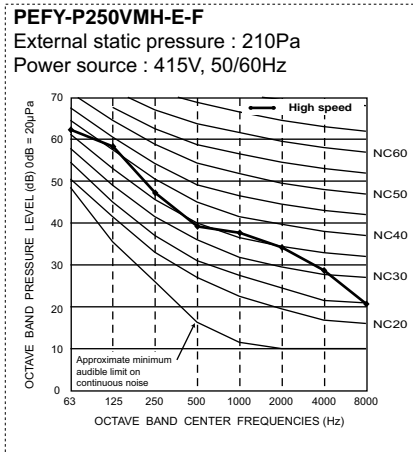
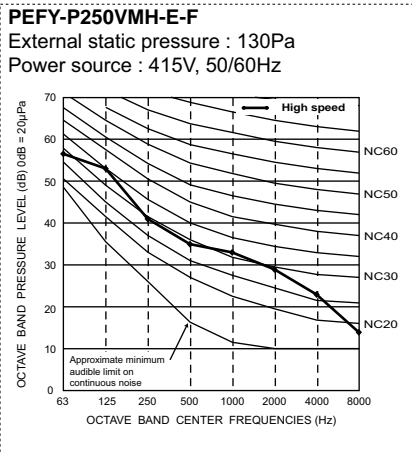
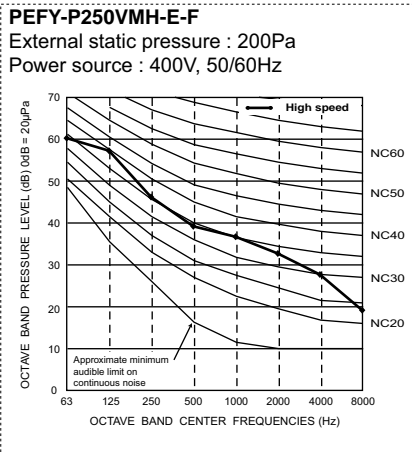
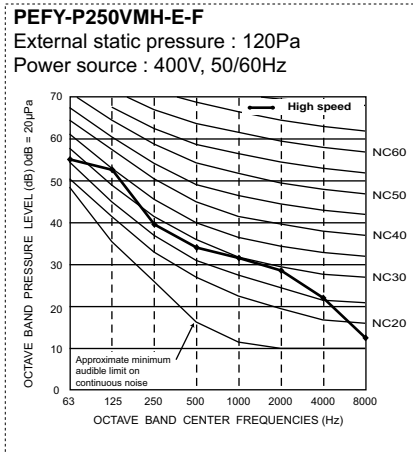
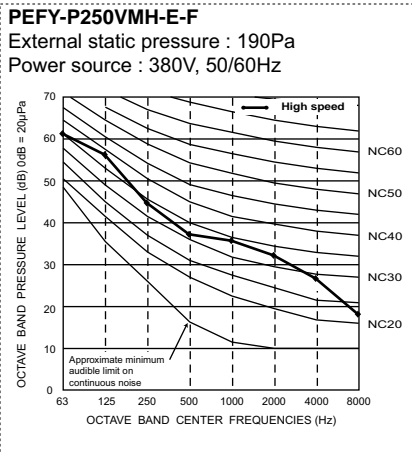
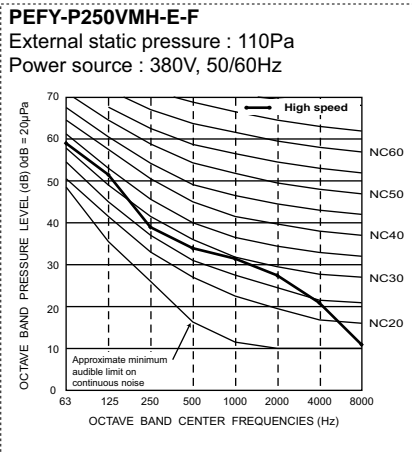
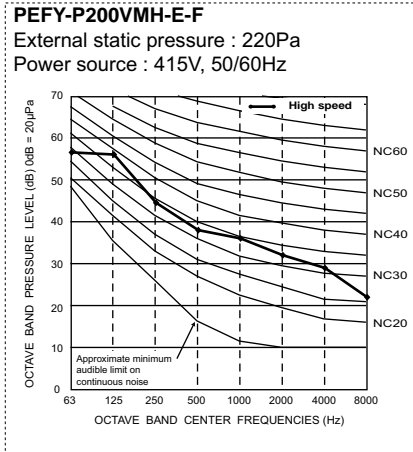
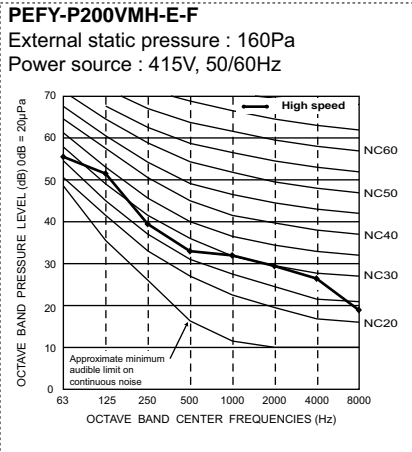
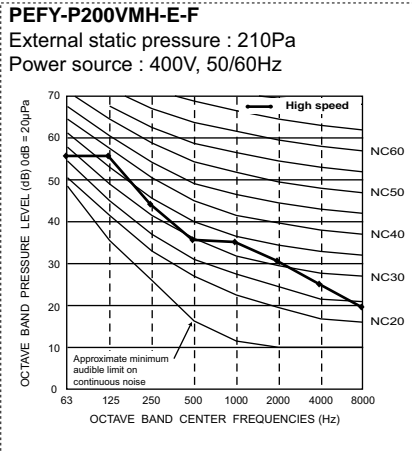
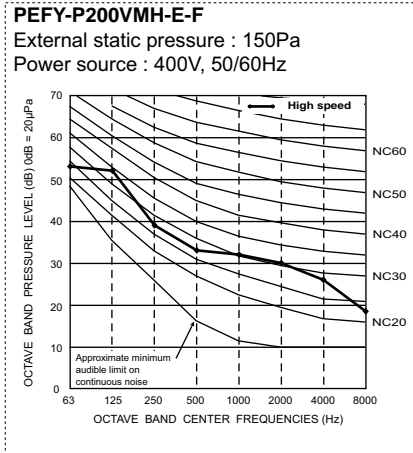
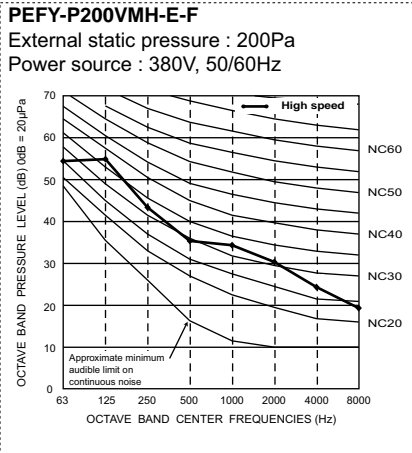
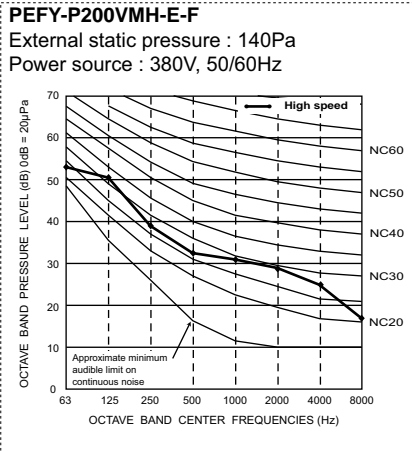

PEFY-E-F

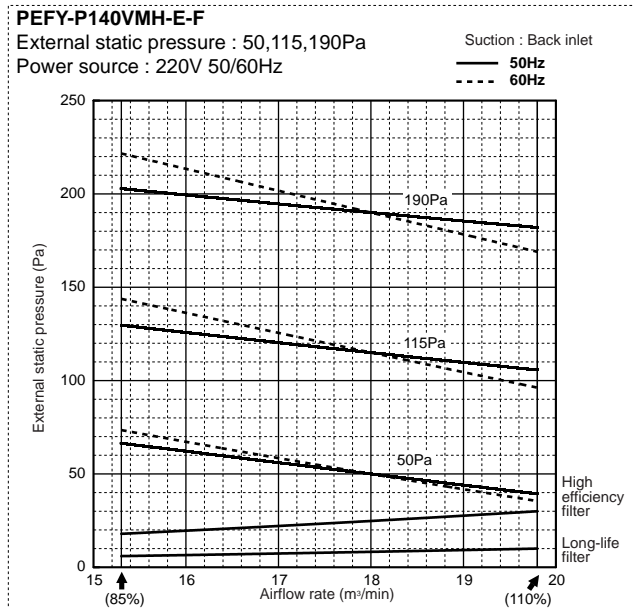
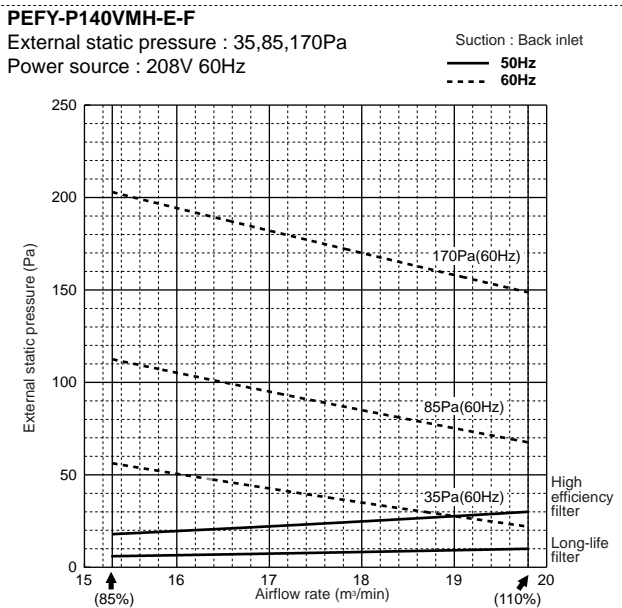
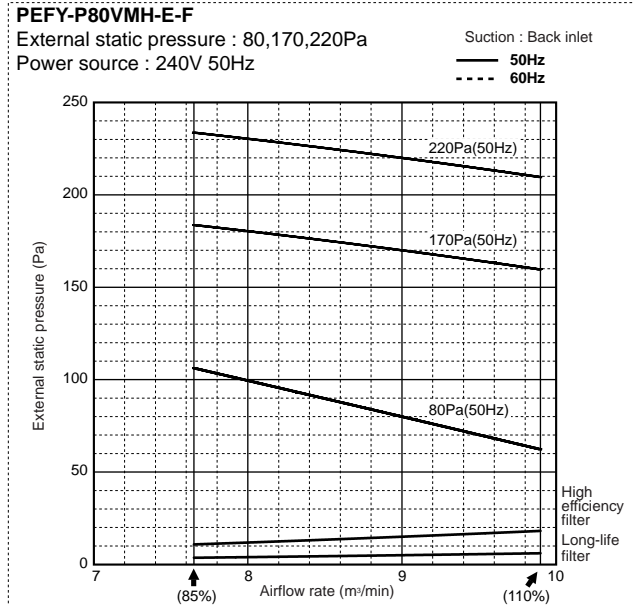
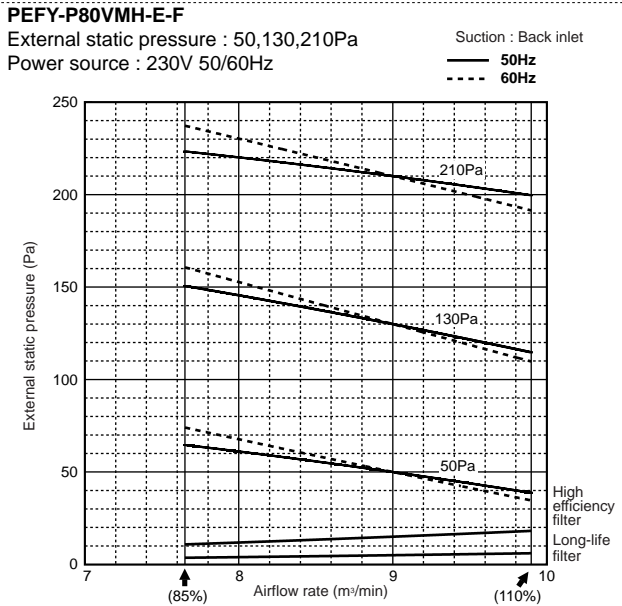
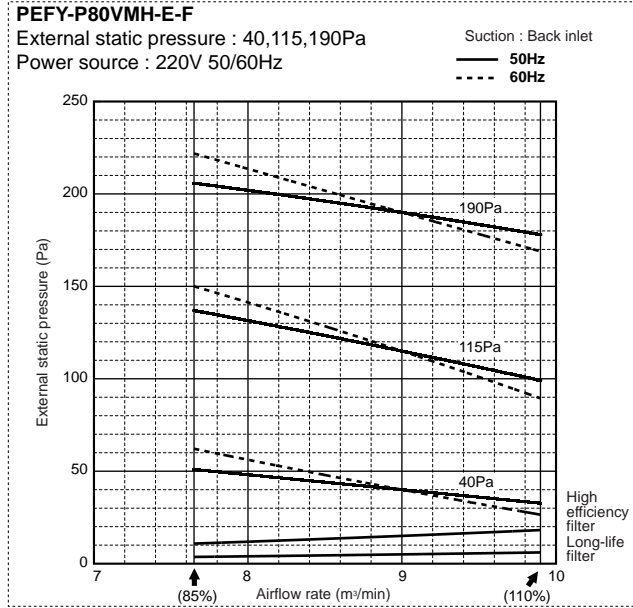
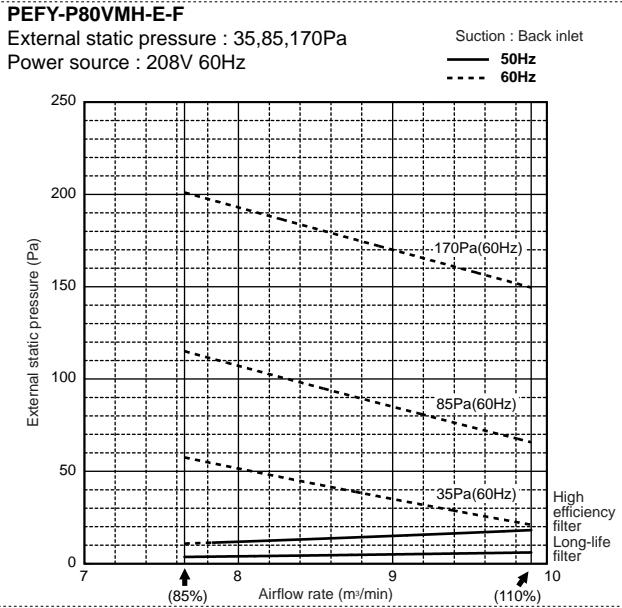

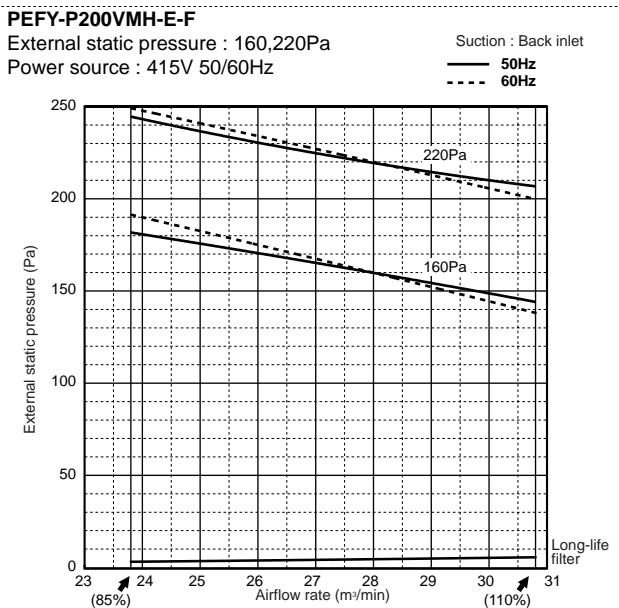
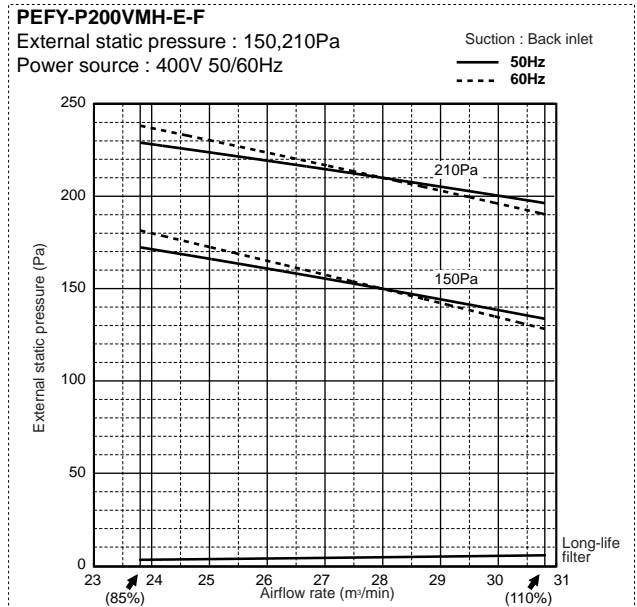
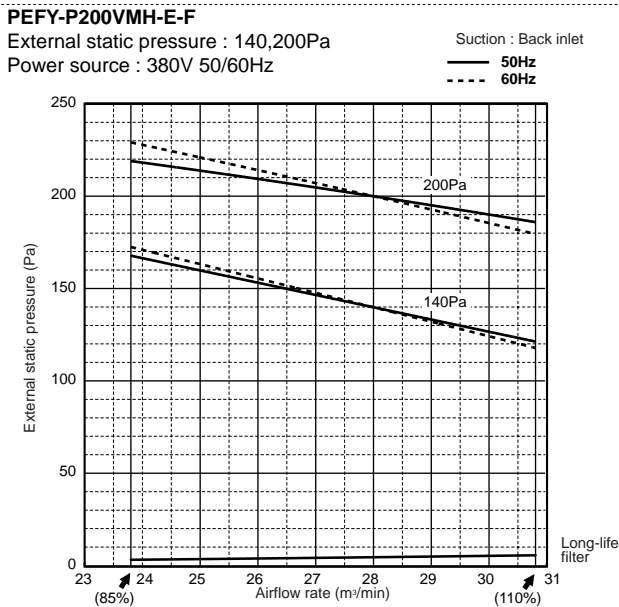
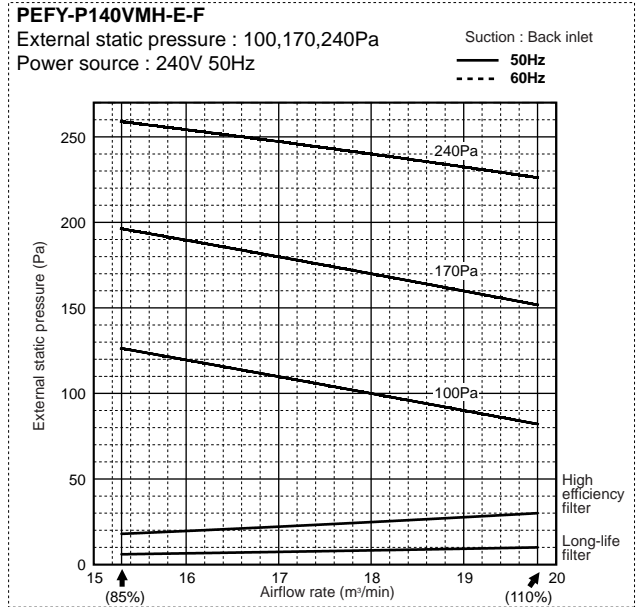
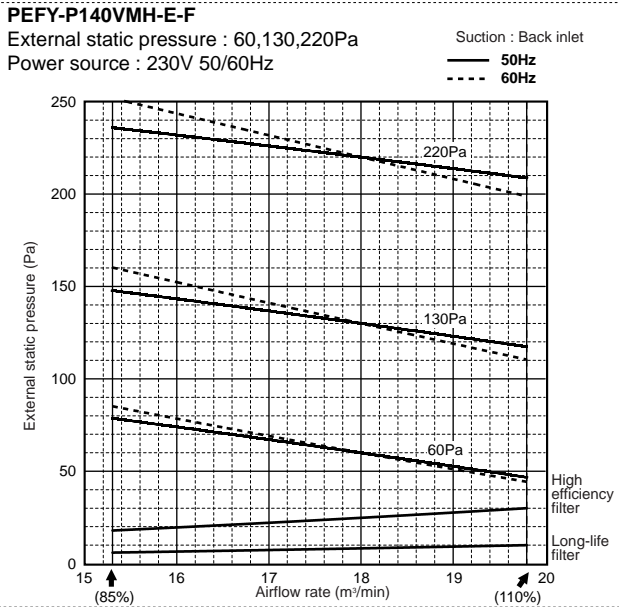

6. FAN CHARACTERISTICS CURVES

PEFY-E-F

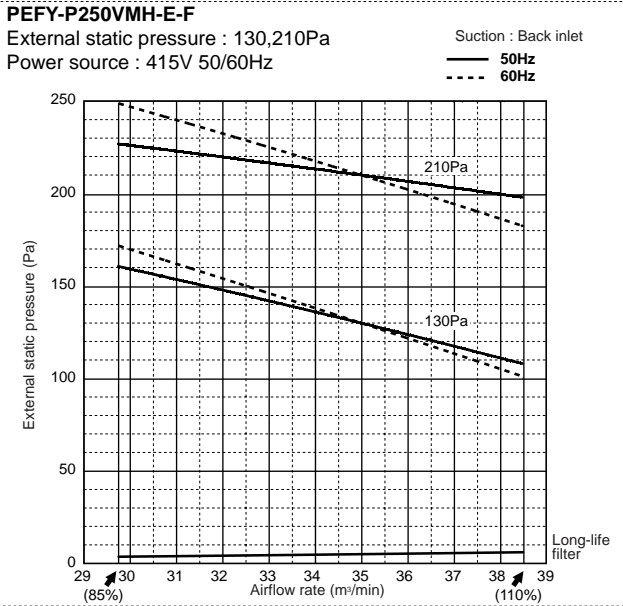
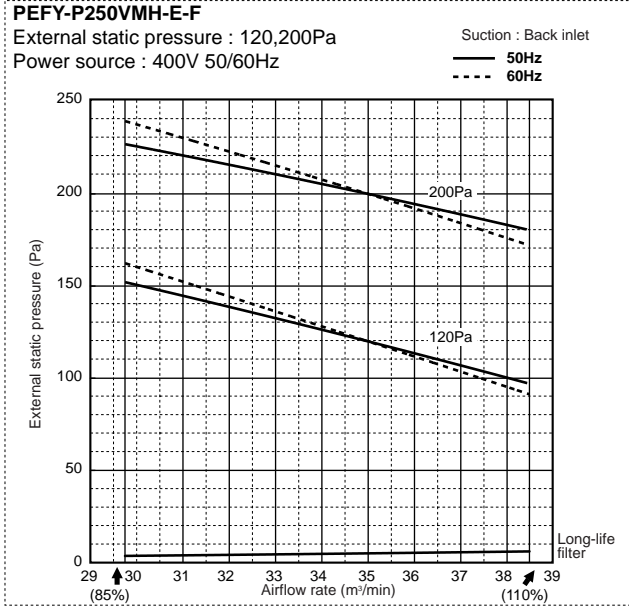
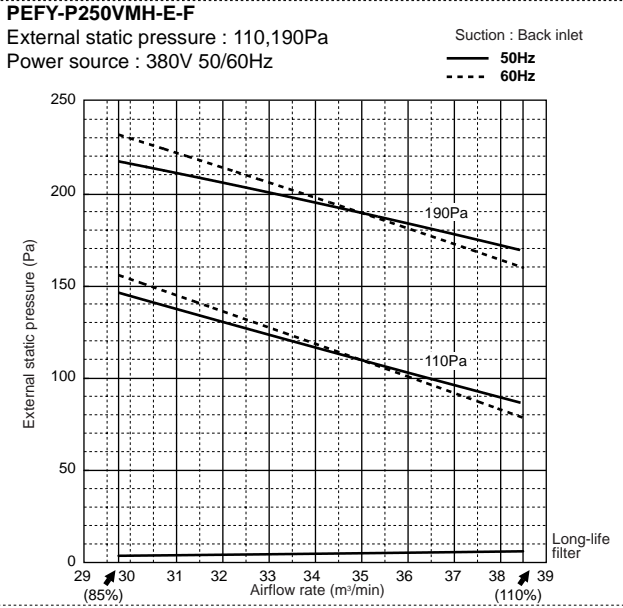

7. CAPACITY TABLES

7-1. Cooling capacity

PEFY-P80VMH-E-F

CA:Capacity(kW) , SHC:Sensible Heat Capacity(kW)

Outdoor air temp.		59°FWB		63°FWB		68°FWB		73°FWB		79°FWB		82°FWB		86°FWB		90°FWB		95°FWB	
		15°CWB		17°CWB		20°CWB		23°CWB		26°CWB		28°CWB		30°CWB		32°CWB		35°CWB	
°FDB	°CDB	CA	SHC	CA	SHC	CA	SHC	CA	SHC	CA	SHC	CA	SHC	CA	SHC	CA	SHC	CA	SHC
70	21	4.4	3.0	5.3	2.9	-	-	-	-	-	-	-	-	-	-	-	-	-	-
73	23	4.4	3.4	5.3	3.3	6.5	3.0	-	-	-	-	-	-	-	-	-	-	-	-
77	25	4.4	3.8	5.2	3.7	6.4	3.4	-	-	-	-	-	-	-	-	-	-	-	-
81	27	-	-	5.2	4.0	6.4	3.7	7.5	3.3	-	-	-	-	-	-	-	-	-	-
84	29	-	-	-	-	6.4	4.1	7.5	3.7	8.5	3.2	-	-	-	-	-	-	-	-
88	31	-	-	-	-	6.3	4.5	7.4	4.0	8.4	3.5	9.1	3.1	-	-	-	-	-	-
91	33	-	-	-	-	-	-	7.3	4.4	8.3	3.8	9.0	3.5	9.6	3.0	-	-	-	-
95	35	-	-	-	-	-	-	7.2	4.7	8.2	4.2	8.9	3.8	9.5	3.3	-	-	-	-
99	37	-	-	-	-	-	-	-	-	8.1	4.5	8.8	4.1	9.4	3.7	9.9	3.2	-	-
104	40	-	-	-	-	-	-	-	-	8.0	5.0	8.6	4.6	9.1	4.1	9.7	3.7	10.5	2.9

PEFY-P140VMH-E-F

Outdoor air temp.		59°FWB		63°FWB		68°FWB		73°FWB		79°FWB		82°FWB		86°FWB		90°FWB		95°FWB	
		15°CWB		17°CWB		20°CWB		23°CWB		26°CWB		28°CWB		30°CWB		32°CWB		35°CWB	
°FDB	°CDB	CA	SHC	CA	SHC	CA	SHC	CA	SHC	CA	SHC	CA	SHC	CA	SHC	CA	SHC	CA	SHC
70	21	7.8	5.6	9.4	5.3	-	-	-	-	-	-	-	-	-	-	-	-	-	-
73	23	7.8	6.3	9.3	6.0	11.5	5.4	-	-	-	-	-	-	-	-	-	-	-	-
77	25	7.8	7.1	9.3	6.8	11.5	6.1	-	-	-	-	-	-	-	-	-	-	-	-
81	27	-	-	9.3	7.5	11.4	6.8	13.4	6.0	-	-	-	-	-	-	-	-	-	-
84	29	-	-	-	-	11.3	7.5	13.3	6.7	15.2	5.6	-	-	-	-	-	-	-	-
88	31	-	-	-	-	11.2	8.2	13.2	7.3	15.0	6.3	16.2	5.5	-	-	-	-	-	-
91	33	-	-	-	-	-	-	13.0	8.0	14.8	7.0	16.0	6.2	17.1	5.3	-	-	-	-
95	35	-	-	-	-	-	-	12.9	8.7	14.6	7.6	15.8	6.8	16.9	6.0	-	-	-	-
99	37	-	-	-	-	-	-	-	-	14.5	8.3	15.6	7.5	16.6	6.6	17.7	5.7	-	-
104	40	-	-	-	-	-	-	-	-	14.2	9.3	15.2	8.5	16.3	7.6	17.3	6.7	18.7	5.3

PEFY-P200VMH-E-F

Outdoor air temp.		59°FWB		63°FWB		68°FWB		73°FWB		79°FWB		82°FWB		86°FWB		90°FWB		95°FWB	
		15°CWB		17°CWB		20°CWB		23°CWB		26°CWB		28°CWB		30°CWB		32°CWB		35°CWB	
°FDB	°CDB	CA	SHC	CA	SHC	CA	SHC	CA	SHC	CA	SHC	CA	SHC	CA	SHC	CA	SHC	CA	SHC
70	21	10.9	7.9	13.1	7.5	-	-	-	-	-	-	-	-	-	-	-	-	-	-
73	23	11.0	9.0	13.1	8.5	16.1	7.6	-	-	-	-	-	-	-	-	-	-	-	-
77	25	11.0	10.1	13.0	9.6	16.0	8.6	-	-	-	-	-	-	-	-	-	-	-	-
81	27	-	-	13.0	10.7	15.9	9.7	18.8	8.4	-	-	-	-	-	-	-	-	-	-
84	29	-	-	-	-	15.8	10.7	18.6	9.4	21.2	7.9	-	-	-	-	-	-	-	-
88	31	-	-	-	-	15.7	11.7	18.4	10.4	21.0	8.9	22.6	7.7	-	-	-	-	-	-
91	33	-	-	-	-	-	-	18.2	11.4	20.7	9.8	22.4	8.7	23.9	7.5	-	-	-	-
95	35	-	-	-	-	-	-	18.0	12.4	20.5	10.8	22.1	9.6	23.6	8.4	-	-	-	-
99	37	-	-	-	-	-	-	-	-	20.2	11.8	21.8	10.6	23.3	9.4	24.7	8.1	-	-
104	40	-	-	-	-	-	-	-	-	19.8	13.2	21.3	12.0	22.8	10.8	24.2	9.5	26.2	7.47

PEFY-P250VMH-E-F

Outdoor air temp.		59°FWB		63°FWB		68°FWB		73°FWB		79°FWB		82°FWB		86°FWB		90°FWB		95°FWB	
		15°CWB		17°CWB		20°CWB		23°CWB		26°CWB		28°CWB		30°CWB		32°CWB		35°CWB	
°FDB	°CDB	CA	SHC	CA	SHC	CA	SHC	CA	SHC	CA	SHC	CA	SHC	CA	SHC	CA	SHC	CA	SHC
70	21	13.7	9.9	16.4	9.3	-	-	-	-	-	-	-	-	-	-	-	-	-	-
73	23	13.7	11.3	16.3	10.7	20.2	9.5	-	-	-	-	-	-	-	-	-	-	-	-
77	25	13.7	12.6	16.3	12.0	20.1	10.8	-	-	-	-	-	-	-	-	-	-	-	-
81	27	-	-	16.2	13.3	19.9	12.1	23.4	10.5	-	-	-	-	-	-	-	-	-	-
84	29	-	-	-	-	19.8	13.4	23.2	11.7	26.5	9.8	-	-	-	-	-	-	-	-
88	31	-	-	-	-	19.6	14.7	23.0	13.0	26.2	11.1	28.3	9.7	-	-	-	-	-	-
91	33	-	-	-	-	-	-	22.8	14.2	25.9	12.3	28.0	10.9	29.9	9.3	-	-	-	-
95	35	-	-	-	-	-	-	22.5	15.5	25.6	13.5	27.6	12.1	29.5	10.5	-	-	-	-
99	37	-	-	-	-	-	-	-	-	25.3	14.7	27.2	13.3	29.1	11.7	30.9	10.1	-	-
104	40	-	-	-	-	-	-	-	-	24.8	16.5	26.6	15.0	28.4	13.5	30.2	11.9	32.7	9.34

There are times when the cooling capacity is lowered to protect the compressor in cases where the outdoor air temperature exceeds 40°C (104°F)

7. CAPACITY TABLES

YKB/YLM

7-2. Outlet air temp. cooled

PEFY-P80VMH-E-F

Outdoor air temp.		59°FWB		63°FWB		68°FWB		73°FWB		79°FWB		82°FWB		86°FWB		90°FWB		95°FWB	
		15°CWB		17°CWB		20°CWB		23°CWB		26°CWB		28°CWB		30°CWB		32°CWB		35°CWB	
°FDB	°CDB	°CDB	°CWB	°CDB	°CWB	°CDB	°CWB	°CDB	°CWB	°CDB	°CWB	°CDB	°CWB	°CDB	°CWB	°CDB	°CWB	°CDB	°CWB
70	21	5.1	5.0	5.6	5.6	-	-	-	-	-	-	-	-	-	-	-	-	-	-
73	23	5.1	5.0	5.7	5.6	7.0	7.0	-	-	-	-	-	-	-	-	-	-	-	-
77	25	5.1	5.0	5.7	5.7	7.1	7.1	-	-	-	-	-	-	-	-	-	-	-	-
81	27	-	-	5.8	5.7	7.2	7.2	9.2	9.2	-	-	-	-	-	-	-	-	-	-
84	29	-	-	-	-	7.4	7.3	9.4	9.4	12.0	12.0	-	-	-	-	-	-	-	-
88	31	-	-	-	-	7.5	7.4	9.6	9.6	12.2	12.2	14.2	14.2	-	-	-	-	-	-
91	33	-	-	-	-	-	-	9.8	9.7	12.4	12.4	14.4	14.4	16.6	16.6	-	-	-	-
95	35	-	-	-	-	-	-	10.0	9.9	12.6	12.6	14.6	14.6	16.8	16.8	-	-	-	-
99	37	-	-	-	-	-	-	-	-	12.8	12.8	14.9	14.8	17.1	17.1	19.5	19.5	-	-
104	40	-	-	-	-	-	-	-	-	13.2	13.1	15.3	15.2	17.5	17.4	19.9	19.8	23.7	23.7

PEFY-P140VMH-E-F

Outdoor air temp.		59°FWB		63°FWB		68°FWB		73°FWB		79°FWB		82°FWB		86°FWB		90°FWB		95°FWB	
		15°CWB		17°CWB		20°CWB		23°CWB		26°CWB		28°CWB		30°CWB		32°CWB		35°CWB	
°FDB	°CDB	°CDB	°CWB	°CDB	°CWB	°CDB	°CWB	°CDB	°CWB	°CDB	°CWB	°CDB	°CWB	°CDB	°CWB	°CDB	°CWB	°CDB	°CWB
70	21	6.3	6.3	7.1	7.0	-	-	-	-	-	-	-	-	-	-	-	-	-	-
73	23	6.3	6.3	7.1	7.1	8.7	8.7	-	-	-	-	-	-	-	-	-	-	-	-
77	25	6.4	6.3	7.2	7.1	8.8	8.8	-	-	-	-	-	-	-	-	-	-	-	-
81	27	-	-	7.2	7.1	8.9	8.9	11.1	11.1	-	-	-	-	-	-	-	-	-	-
84	29	-	-	-	-	9.0	9.0	11.2	11.2	13.9	13.9	-	-	-	-	-	-	-	-
88	31	-	-	-	-	9.1	9.0	11.4	11.3	14.0	14.0	16.1	16.1	-	-	-	-	-	-
91	33	-	-	-	-	-	-	11.5	11.5	14.2	14.2	16.2	16.2	18.4	18.4	-	-	-	-
95	35	-	-	-	-	-	-	11.7	11.6	14.4	14.4	16.4	16.4	18.6	18.6	-	-	-	-
99	37	-	-	-	-	-	-	-	-	14.6	14.5	16.7	16.6	18.8	18.8	21.2	21.1	-	-
104	40	-	-	-	-	-	-	-	-	14.9	14.8	17.0	16.9	19.2	19.1	21.5	21.5	25.2	25.2

PEFY-P200VMH-E-F

Outdoor air temp.		59°FWB		63°FWB		68°FWB		73°FWB		79°FWB		82°FWB		86°FWB		90°FWB		95°FWB	
		15°CWB		17°CWB		20°CWB		23°CWB		26°CWB		28°CWB		30°CWB		32°CWB		35°CWB	
°FDB	°CDB	°CDB	°CWB	°CDB	°CWB	°CDB	°CWB	°CDB	°CWB	°CDB	°CWB	°CDB	°CWB	°CDB	°CWB	°CDB	°CWB	°CDB	°CWB
70	21	7.6	7.2	8.3	8.2	-	-	-	-	-	-	-	-	-	-	-	-	-	-
73	23	7.7	7.2	8.5	8.2	10.0	10.0	-	-	-	-	-	-	-	-	-	-	-	-
77	25	7.8	7.2	8.6	8.2	10.3	10.1	-	-	-	-	-	-	-	-	-	-	-	-
81	27	-	-	8.8	8.2	10.5	10.1	12.5	12.4	-	-	-	-	-	-	-	-	-	-
84	29	-	-	-	-	10.7	10.2	12.8	12.6	15.3	15.3	-	-	-	-	-	-	-	-
88	31	-	-	-	-	10.9	10.3	13.0	12.7	15.6	15.4	17.5	17.5	-	-	-	-	-	-
91	33	-	-	-	-	-	-	13.3	12.8	15.9	15.6	17.7	17.6	19.8	19.8	-	-	-	-
95	35	-	-	-	-	-	-	13.6	12.9	16.1	15.7	18.1	17.8	20.1	20.0	-	-	-	-
99	37	-	-	-	-	-	-	-	-	16.4	15.9	18.4	17.9	20.4	20.1	22.6	22.4	-	-
104	40	-	-	-	-	-	-	-	-	16.9	16.1	18.8	18.2	20.9	20.4	23.1	22.7	26.5	26.3

PEFY-P250VMH-E-F

Outdoor air temp.		59°FWB		63°FWB		68°FWB		73°FWB		79°FWB		82°FWB		86°FWB		90°FWB		95°FWB	
		15°CWB		17°CWB		20°CWB		23°CWB		26°CWB		28°CWB		30°CWB		32°CWB		35°CWB	
°FDB	°CDB	°CDB	°CWB	°CDB	°CWB	°CDB	°CWB	°CDB	°CWB	°CDB	°CWB	°CDB	°CWB	°CDB	°CWB	°CDB	°CWB	°CDB	°CWB
70	21	7.6	7.2	8.3	8.2	-	-	-	-	-	-	-	-	-	-	-	-	-	-
73	23	7.7	7.2	8.5	8.2	10.0	10.0	-	-	-	-	-	-	-	-	-	-	-	-
77	25	7.8	7.2	8.6	8.2	10.3	10.1	-	-	-	-	-	-	-	-	-	-	-	-
81	27	-	-	8.8	8.2	10.5	10.1	12.5	12.4	-	-	-	-	-	-	-	-	-	-
84	29	-	-	-	-	10.7	10.2	12.8	12.6	15.3	15.3	-	-	-	-	-	-	-	-
88	31	-	-	-	-	10.9	10.3	13.0	12.7	15.6	15.4	17.5	17.5	-	-	-	-	-	-
91	33	-	-	-	-	-	-	13.3	12.8	15.9	15.6	17.7	17.6	19.8	19.8	-	-	-	-
95	35	-	-	-	-	-	-	13.6	12.9	16.1	15.7	18.1	17.8	20.1	20.0	-	-	-	-
99	37	-	-	-	-	-	-	-	-	16.4	15.9	18.4	17.9	20.4	20.1	22.6	22.4	-	-
104	40	-	-	-	-	-	-	-	-	16.9	16.1	18.8	18.2	20.9	20.4	23.1	22.7	26.5	26.3

7-3. Heating capacity

PEFY-P80VMH-E-F

SHC:Sensible Heat Capacity(kW)

Outdoor air temp.		16°FWB	23°FWB	27°FWB	32°FWB	36°FWB	39°FWB	43°FWB	50°FWB	57°FWB
		-9°CWB	-5°CWB	-2.9°CWB	0°CWB	2°CWB	4°CWB	6°CWB	10°CWB	14°CWB
°FDB	°CDB	SHC	SHC	SHC	SHC	SHC	SHC	SHC	SHC	SHC
18	-8	8.2	-	-	-	-	-	-	-	-
27	-3	-	9.1	-	-	-	-	-	-	-
32	0	-	-	8.5	-	-	-	-	-	-
37	3	-	-	-	7.9	7.9	-	-	-	-
45	7	-	-	-	-	7.1	7.1	7.1	-	-
52	11	-	-	-	-	-	-	6.3	6.3	-
59	15	-	-	-	-	-	-	-	5.5	5.5
64	18	-	-	-	-	-	-	-	5.0	5.0
68	20	-	-	-	-	-	-	-	-	4.6

PEFY-P140VMH-E-F

Outdoor air temp.		16°FWB	23°FWB	27°FWB	32°FWB	36°FWB	39°FWB	43°FWB	50°FWB	57°FWB
		-9°CWB	-5°CWB	-2.9°CWB	0°CWB	2°CWB	4°CWB	6°CWB	10°CWB	14°CWB
°FDB	°CDB	SHC	SHC	SHC	SHC	SHC	SHC	SHC	SHC	SHC
18	-8	14.6	-	-	-	-	-	-	-	-
27	-3	-	16.2	-	-	-	-	-	-	-
32	0	-	-	15.1	-	-	-	-	-	-
37	3	-	-	-	14.0	14.0	-	-	-	-
45	7	-	-	-	-	12.6	12.6	12.6	-	-
52	11	-	-	-	-	-	-	11.2	11.2	-
59	15	-	-	-	-	-	-	-	9.8	9.8
64	18	-	-	-	-	-	-	-	8.8	8.8
68	20	-	-	-	-	-	-	-	-	8.1

PEFY-P200VMH-E-F

Outdoor air temp.		16°FWB	23°FWB	27°FWB	32°FWB	36°FWB	39°FWB	43°FWB	50°FWB	57°FWB
		-9°CWB	-5°CWB	-2.9°CWB	0°CWB	2°CWB	4°CWB	6°CWB	10°CWB	14°CWB
°FDB	°CDB	SHC	SHC	SHC	SHC	SHC	SHC	SHC	SHC	SHC
18	-8	20.5	-	-	-	-	-	-	-	-
27	-3	-	22.7	-	-	-	-	-	-	-
32	0	-	-	21.2	-	-	-	-	-	-
37	3	-	-	-	19.7	19.7	-	-	-	-
45	7	-	-	-	-	17.8	17.8	17.8	-	-
52	11	-	-	-	-	-	-	15.8	15.8	-
59	15	-	-	-	-	-	-	-	13.8	13.8
64	18	-	-	-	-	-	-	-	12.3	12.3
68	20	-	-	-	-	-	-	-	-	11.4

PEFY-P250VMH-E-F

Outdoor air temp.		16°FWB	23°FWB	27°FWB	32°FWB	36°FWB	39°FWB	43°FWB	50°FWB	57°FWB
		-9°CWB	-5°CWB	-2.9°CWB	0°CWB	2°CWB	4°CWB	6°CWB	10°CWB	14°CWB
°FDB	°CDB	SHC	SHC	SHC	SHC	SHC	SHC	SHC	SHC	SHC
18	-8	25.7	-	-	-	-	-	-	-	-
27	-3	-	28.3	-	-	-	-	-	-	-
32	0	-	-	26.5	-	-	-	-	-	-
37	3	-	-	-	24.7	24.7	-	-	-	-
45	7	-	-	-	-	22.2	22.2	22.2	-	-
52	11	-	-	-	-	-	-	19.7	19.7	-
59	15	-	-	-	-	-	-	-	17.3	17.3
64	18	-	-	-	-	-	-	-	15.4	15.4
68	20	-	-	-	-	-	-	-	-	14.2

PEFY-E-F

7-4. Outlet air temp. heated

PEFY-P80VMH-E-F

Outdoor air temp.		16°F WB	23°F WB	27°F WB	32°F WB	36°F WB	39°F WB	43°F WB	50°F WB	57°F WB
		-9°C WB	-5°C WB	-2.9°C WB	0°C WB	2°C WB	4°C WB	6°C WB	10°C WB	14°C WB
°F DB	°C DB	°C DB	°C DB	°C DB	°C DB	°C DB	°C DB	°C DB	°C DB	°C DB
18	-8	40.6	-	-	-	-	-	-	-	-
27	-3	-	53.1	-	-	-	-	-	-	-
32	0	-	-	51.9	-	-	-	-	-	-
37	3	-	-	-	51.3	51.8	-	-	-	-
45	7	-	-	-	-	50.5	50.5	50.9	-	-
52	11	-	-	-	-	-	-	49.6	50.1	-
59	15	-	-	-	-	-	-	-	48.8	49.2
64	18	-	-	-	-	-	-	-	48.2	48.2
68	20	-	-	-	-	-	-	-	-	47.8

PEFY-P140VMH-E-F

Outdoor air temp.		16°F WB	23°F WB	27°F WB	32°F WB	36°F WB	39°F WB	43°F WB	50°F WB	57°F WB
		-9°C WB	-5°C WB	-2.9°C WB	0°C WB	2°C WB	4°C WB	6°C WB	10°C WB	14°C WB
°F DB	°C DB	°C DB	°C DB	°C DB	°C DB	°C DB	°C DB	°C DB	°C DB	°C DB
18	-8	34.7	-	-	-	-	-	-	-	-
27	-3	-	45.8	-	-	-	-	-	-	-
32	0	-	-	45.6	-	-	-	-	-	-
37	3	-	-	-	45.4	45.4	-	-	-	-
45	7	-	-	-	-	45.2	45.2	45.2	-	-
52	11	-	-	-	-	-	-	45.0	45.0	-
59	15	-	-	-	-	-	-	-	44.7	45.1
64	18	-	-	-	-	-	-	-	44.6	44.6
68	20	-	-	-	-	-	-	-	-	44.4

PEFY-P200VMH-E-F

Outdoor air temp.		16°F WB	23°F WB	27°F WB	32°F WB	36°F WB	39°F WB	43°F WB	50°F WB	57°F WB
		-9°C WB	-5°C WB	-2.9°C WB	0°C WB	2°C WB	4°C WB	6°C WB	10°C WB	14°C WB
°F DB	°C DB	°C DB	°C DB	°C DB	°C DB	°C DB	°C DB	°C DB	°C DB	°C DB
18	-8	29.7	-	-	-	-	-	-	-	-
27	-3	-	40.0	-	-	-	-	-	-	-
32	0	-	-	40.3	-	-	-	-	-	-
37	3	-	-	-	40.6	40.7	-	-	-	-
45	7	-	-	-	-	40.8	40.9	41.0	-	-
52	11	-	-	-	-	-	-	41.2	41.4	-
59	15	-	-	-	-	-	-	-	41.5	41.7
64	18	-	-	-	-	-	-	-	41.7	41.8
68	20	-	-	-	-	-	-	-	-	41.9

PEFY-P250VMH-E-F

Outdoor air temp.		16°F WB	23°F WB	27°F WB	32°F WB	36°F WB	39°F WB	43°F WB	50°F WB	57°F WB
		-9°C WB	-5°C WB	-2.9°C WB	0°C WB	2°C WB	4°C WB	6°C WB	10°C WB	14°C WB
°F DB	°C DB	°C DB	°C DB	°C DB	°C DB	°C DB	°C DB	°C DB	°C DB	°C DB
18	-8	29.7	-	-	-	-	-	-	-	-
27	-3	-	40.0	-	-	-	-	-	-	-
32	0	-	-	40.3	-	-	-	-	-	-
37	3	-	-	-	40.6	40.7	-	-	-	-
45	7	-	-	-	-	40.8	40.9	41.0	-	-
52	11	-	-	-	-	-	-	41.2	41.4	-
59	15	-	-	-	-	-	-	-	41.5	41.7
64	18	-	-	-	-	-	-	-	41.6	41.8
68	20	-	-	-	-	-	-	-	-	41.9

PEFY-E-F

8-1. Optional parts line up for the Indoor unit

	Long-life filter	Filter box	Drain pump
PEFY-P80VMH-E-F	PAC-KE88LAF	PAC-KE80TB-F	PAC-KE04DM-F
PEFY-P100VMH-E-F	PAC-KE89LAF	PAC-KE140TB-F	PAC-KE04DM-F
PEFY-P200VMH-E-F	PAC-KE85LAF	PAC-KE250TB-F	PAC-KE04DM-F
PEFY-P250VMH-E-F	PAC-KE85LAF	PAC-KE250TB-F	PAC-KE04DM-F

PEFY-P-VMH-E-F

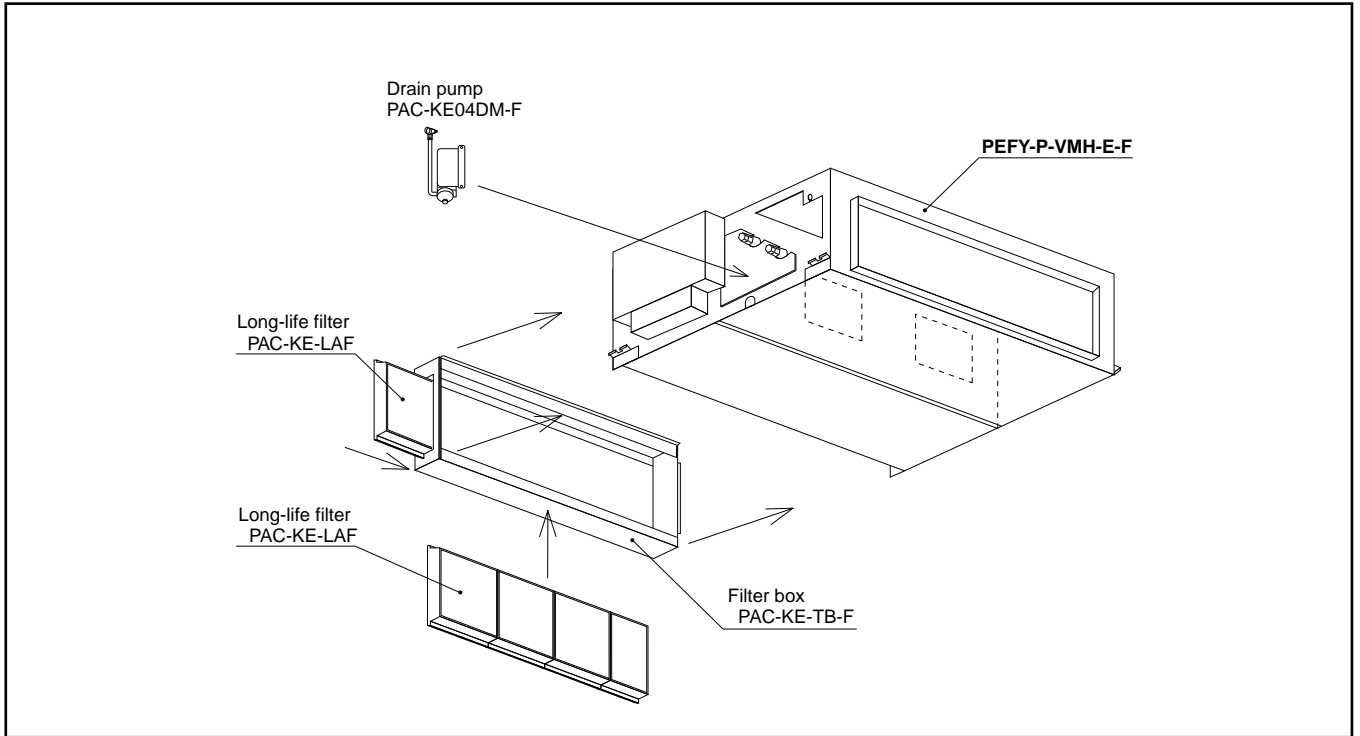

8-2. Long-life filter

Life span: 2,500 hr (Dust concentration 0.15mg/m³)
 *The actual dust situation affects the filter life span, which should be considered at the applying site.
 Material: Synthetic fiber unwoven cloth filter
 Static pressure loss is referred to 6 "FAN CHARACTERISTICS CURVES".
 Long-life filter should be used together with filter box PAC-KE-TB-F.

PAC-KE-LAF

Item	PAC-KE86LAF	PAC-KE88LAF	PAC-KE89LAF	PAC-KE85LAF
Quantity	2	3	3	2
Shape	(298X300) 	(298X300) 	(298X300) 	(411X600)

Detailed installation information should be referred to its Installation Manual.

PAC-KE-TB-F







Item	① Screw	② Filter box	③ Installation manual	
Quantity	10/12*	1	1	
Shape				*PAC-KE250TB has 12 pieces of screw.

Detailed installation information should be referred to its Installation Manual.

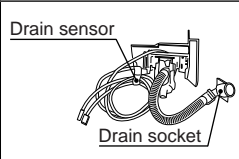
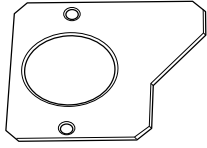
8-3. Drain pump

If drain water can not flow out the Indoor unit by gravity and gradient, a Drain-pump for draining is needed.
 Drain pump PAC-KE04DM-F can pump water up to 550mm [21-11/16 in.] high from the drain pan.

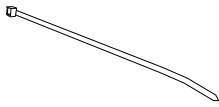
PAC-KE04DM-F

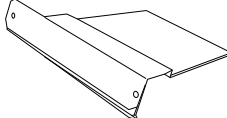
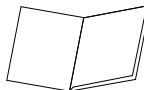
Item	① Drain pump ass'y	② Separator	③ Rubber plug	④ Connector	⑤ Dummy connector
Quantity	1	1	2	1	1
Shape					
Item	⑥ Rubber bushing	⑦ Band	⑧ PTT screw 4X10	⑨ Fixing plate	⑩ Installation manual
Quantity	1	2	6+1 (spare)	1	1
Shape					

Detailed installation information should be referred to its Installation Manual.

PMFY-P-VBM-E

1. SPECIFICATIONS	1 - 110
2. EXTERNAL DIMENSIONS	1 - 111
3. CENTER OF GRAVITY	1 - 112
4. ELECTRICAL WIRING DIAGRAMS	1 - 113
5. SOUND LEVELS	1 - 114
5-1. Sound levels	1 - 114
5-2. NC curves	1 - 114
6. TEMPERATURE/AIRFLOW DISTRIBUTIONS	1 - 115
6-1. Temperature distributions	1 - 115
6-2. Airflow distributions	1 - 115

1. SPECIFICATIONS

YKB/YLM

Model			PMFY-P20VBM-E	PMFY-P25VBM-E	PMFY-P32VBM-E	PMFY-P40VBM-E	
Power source			1-phase 220-240V 50Hz, 1-phase 220V 60Hz				
Cooling capacity (Nominal)	*1	kW	2.2	2.8	3.6	4.5	
	*1	kcal / h	1,900	2,400	3,100	3,900	
	*1	BTU / h	7,500	9,600	12,300	15,400	
	*2	kcal / h	2,000	2,500	3,150	4,000	
	*4	Power input	kW	0.042	0.044	0.044	0.054
	*4	Current input	A	0.20	0.21	0.21	0.26
Heating capacity (Nominal)	*3	kW	2.5	3.2	4.0	5.0	
	*3	kcal / h	2,200	2,800	3,400	4,300	
	*3	BTU / h	8,500	10,900	13,600	17,100	
	*4	Power input	kW	0.042	0.044	0.044	0.054
	*4	Current input	A	0.20	0.21	0.21	0.26
External finish			Galvanized, with grey insulation sheet				
External dimension H x W x D		mm	230 x 812 x 395				
		in.	9-1/16 x 32 x 15-9/16				
Net weight		kg (lbs)	14 (31)				
Decoration panel	Model		PMP-40BMW	PMP-40BMW	PMP-40BMW	PMP-40BMW	
	External finish		MUNSELL (0.98Y 8.99/0.63)				
	Dimension	mm	30 x 1,000 x 470				
	H x W x D	in.	1-3/16 x 39-3/8 x 18-9/16				
	Net Weight	kg (lbs)	3 (7)				
Heat exchanger			Cross fin (Aluminum fin and copper tube)				
FAN	Type x Quantity		Line flow fan x 1				
	External static press.	Pa	0				
		mmH ₂ O	0				
	Motor type		1-phase induction motor				
	Motor output	kW	0.028				
	Driving mechanism		Direct-driven by motor				
	Airflow rate (Low-Mid-High)	m ³ / min	6.5 - 7.2 - 8.0 - 8.7	7.3 - 8.0 - 8.6 - 9.3	7.3 - 8.0 - 8.6 - 9.3	7.7 - 8.7 - 9.7 - 10.7	
L / s		108 - 120 - 133 - 145	122 - 133 - 143 - 155	122 - 133 - 143 - 155	128 - 145 - 162 - 178		
	cfm	230 - 254 - 283 - 307	258 - 283 - 304 - 328	258 - 283 - 304 - 328	272 - 307 - 343 - 378		
Sound pressure level (Low-Mid-High) (measured in anechoic room)	*4	dB <A>	27 - 30 - 33 - 35	32 - 34 - 36 - 37	32 - 34 - 36 - 37	33 - 35 - 37 - 39	
Insulation material			Polyester sheet				
Air filter			PP honeycomb fabric				
Protection device			Fuse				
Refrigerant control device			LEV				
Connectable outdoor unit			R410A CITY MULTI				
Diameter of refrigerant pipe	Liquid (R410A)	mm (in.)	ø6.35 (ø1/4) Flare	ø6.35 (ø1/4) Flare	ø6.35 (ø1/4) Flare	ø6.35 (ø1/4) Flare	
	Gas (R410A)	mm (in.)	ø12.7 (ø1/2) Flare	ø12.7 (ø1/2) Flare	ø12.7 (ø1/2) Flare	ø12.7 (ø1/2) Flare	
Field drain pipe size		mm (in.)	O.D. 26 (1)				
Drawing	External		IU-BH01-C184				
	Wiring		IU-RG79-A671				
	Refrigerant cycle						
Standard attachment	Document		Installation Manual, Instruction Book				
	Accessory		Drain hose I.D. 26 (1) (flexible joint)				
Remark	Optional parts						
	Decoration panel		PMP-40BMW	PMP-40BMW	PMP-40BMW	PMP-40BMW	
			*PMFY-P-VBM-E should be used together with PMP-40BMW				
Installation		Details on foundation work, duct work, insulation work, electrical wiring, power source switch, and other items shall be referred to the Installation Manual.					
Note :			*1 Nominal cooling conditions	*2 Nominal cooling conditions	*3 Nominal heating conditions	Unit converter	
Indoor :			27°CDB/19°CWB (81°FDB/66°FWB)	27°CDB/19.5°CWB (81°FDB/67°FWB)	20°CDB (68°FDB)	kcal/h = kW x 860	
Outdoor :			35°CDB (95°FDB)	35°CDB (95°FDB)	7°CDB/6°CWB (45°FDB/43°FWB)	BTU/h = kW x 3,412	
Pipe length :			7.5 m (24-9/16 ft)	5 m (16-3/8 ft)	7.5 m (24-9/16 ft)	cfm = m ³ /min x 35.31	
Level difference :			0 m (0 ft)	0 m (0 ft)	0 m (0 ft)	lbs = kg / 0.4536	
* Nominal conditions *1, *3 are subject to JIS B8615-1.						*Above specification data is subject to rounding variation.	
* Due to continuing improvement, above specification may be subject to change without notice.							
*4 The values are measured at the rated external static pressure.							

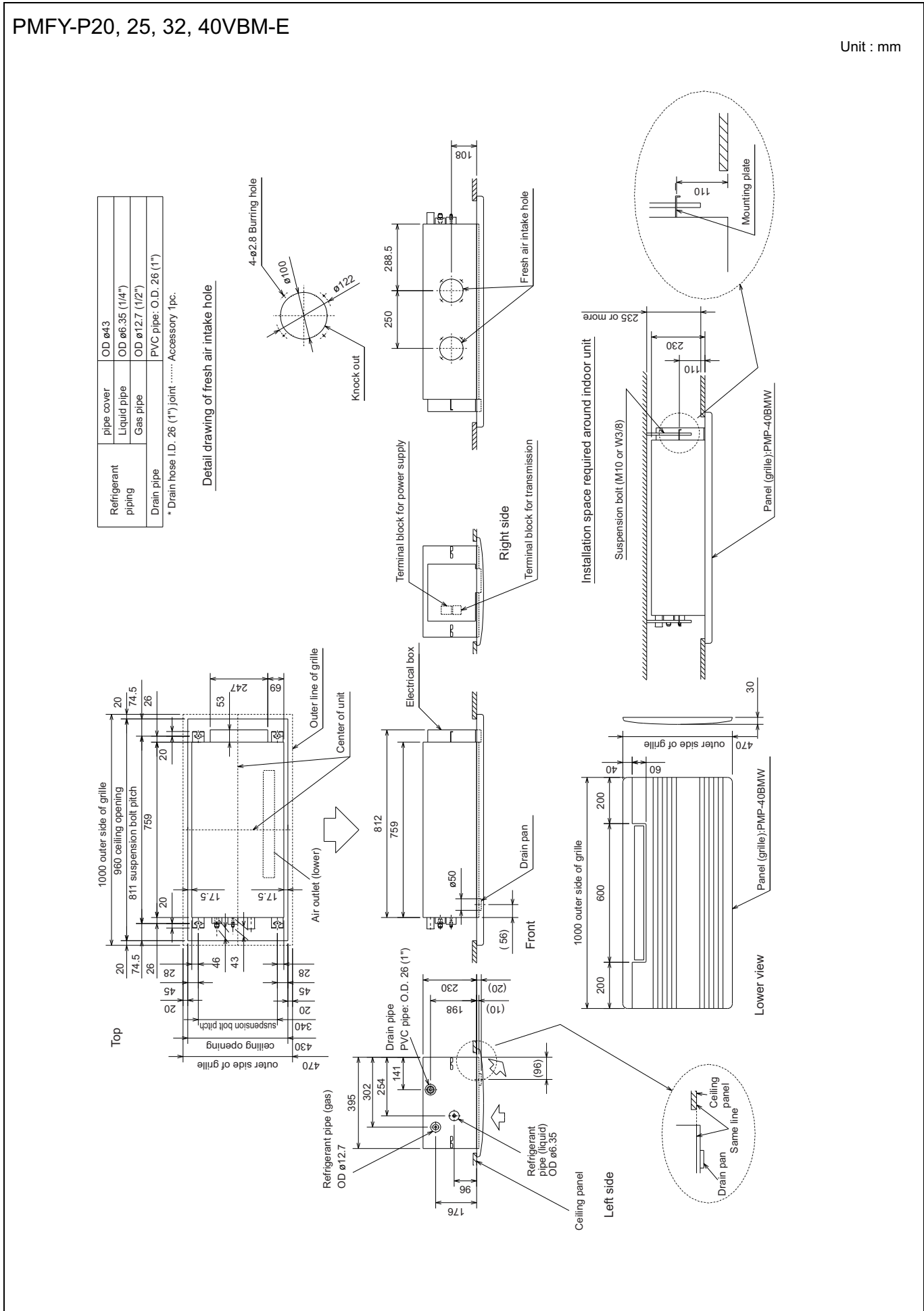

PMFY

PMFY-P20, 25, 32, 40VBM-E

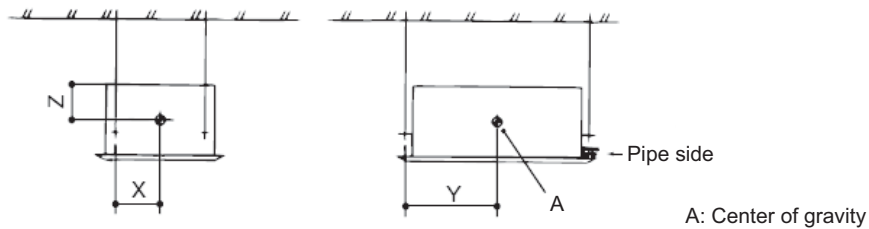

A: Center of gravity

(mm)[in]

Model name	X	Y	Z
PMFY-P20VBM-E	165 [6-1/2]	390 [15-3/8]	130 [5-1/8]
PMFY-P25VBM-E	165 [6-1/2]	390 [15-3/8]	130 [5-1/8]
PMFY-P32VBM-E	165 [6-1/2]	390 [15-3/8]	130 [5-1/8]
PMFY-P40VBM-E	165 [6-1/2]	390 [15-3/8]	130 [5-1/8]

PMFY-P20, 25, 32, 40VBM-E

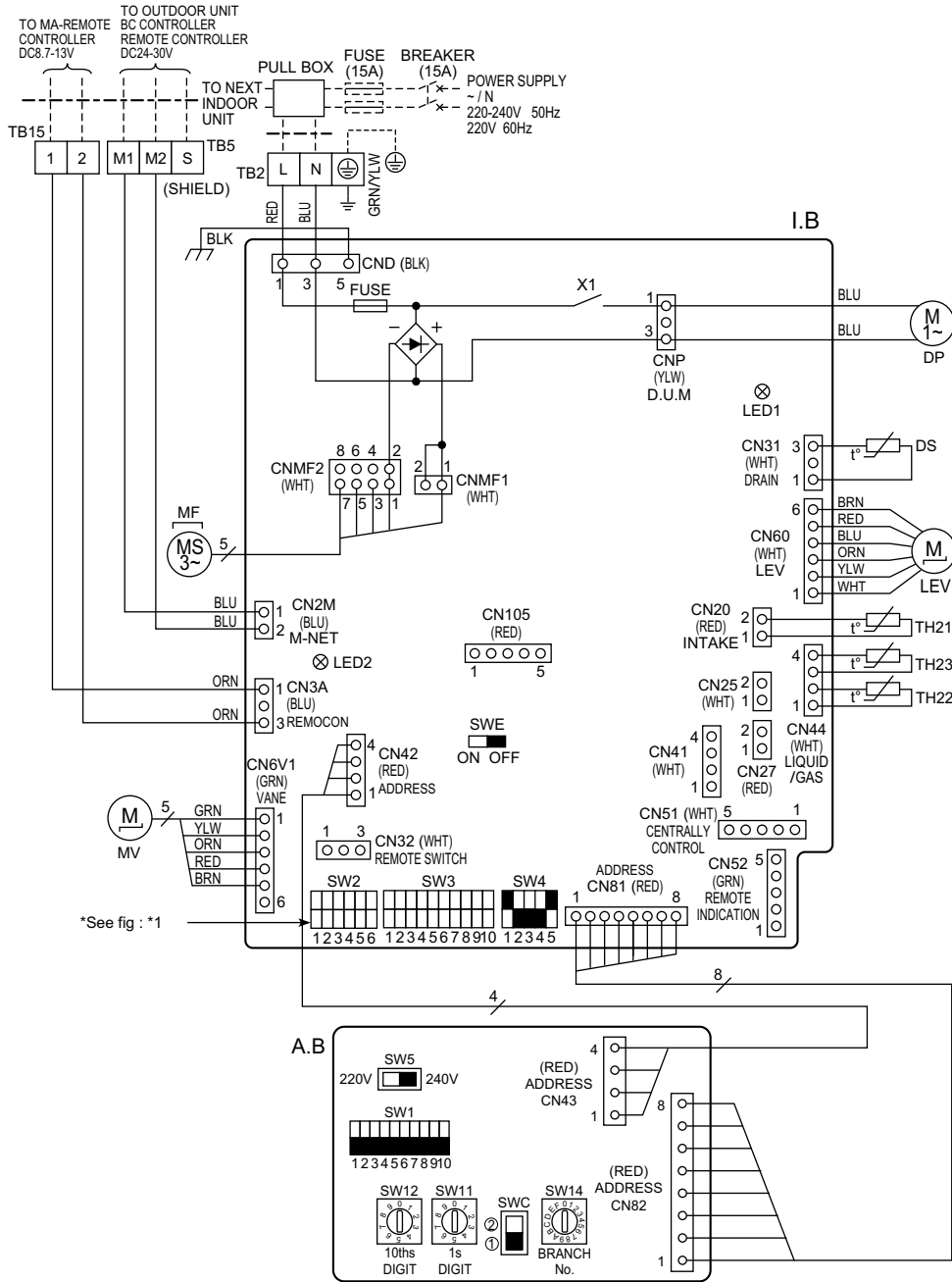

*See fig : *1

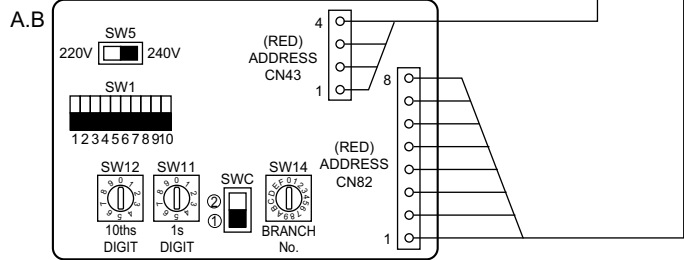

[LEGEND]

SYMBOL	NAME	SYMBOL	NAME
I.B	INDOOR CONTROLLER BOARD	DS	DRAIN SENSOR
CN25	CONNECTOR HUMIDIFIER	TB2	TERMINAL POWER SUPPLY
CN27	DAMPER	TB5	BLOCK TRANSMISSION
CN32	REMOTE SWITCH	TB15	MA-REMOTE CONTROLLER
CN51	CENTRALLY CONTROL	TH21	THERMISTOR ROOM TEMP. DETECTION (0°C/15kΩ, 25°C/5.4kΩ)
CN52	REMOTE INDICATION	TH22	PIPE TEMP. DETECTION / LIQUID (0°C/15kΩ, 25°C/5.4kΩ)
CN105	IT TERMINAL	TH23	PIPE TEMP. DETECTION / GAS (0°C/15kΩ, 25°C/5.4kΩ)
SW2	SWITCH CAPACITY CORD	LEV	LINEAR EXPANSION VALVE
SW3	MODE SELECTION	FUSE	FUSE (T6.3AL 250V)
SW4	MODEL SELECTOR	X1	AUX.RELAY DRAIN PUMP
SWE	DRAIN UP MACHINE (TEST MODE)	LED1	POWER SUPPLY (I.B)
		LED2	POWER SUPPLY (I.B)
MF	FAN MOTOR	MF	FAN MOTOR
MV	VANE MOTOR	MV	VANE MOTOR
DP	DRAIN PUMP	DP	DRAIN PUMP
		A.B	CIRCUIT BOARD
		SW1	SWITCH MODE SELECTION
		SW5	VOLTAGE SELECTION
		SW11	ADDRESS SETTING 1s DIGIT
		SW12	ADDRESS SETTING 10ths DIGIT
		SW14	BRANCH No.

The black square (■) indicates a switch position. < *1 >

MODELS	SW2	SW3
P20VBM	ON OFF [123456]	ON OFF [12345678910]
P25VBM	ON OFF [123456]	ON OFF [12345678910]
P32VBM	ON OFF [123456]	ON OFF [12345678910]
P40VBM	ON OFF [123456]	ON OFF [12345678910]

NOTES:

- At servicing for outdoor unit, always follow the wiring diagram of outdoor unit.
- In case of using MA-Remote controller, please connect to TB15. (Remote controller wire is non-polar.)
- In case of using M-NET, please connect to TB5. (Transmission line is non-polar.)
- Symbol [S] of TB5 is the shield wire connection.
- Symbols used in wiring diagram above are, [] : terminal block, [] : connector.
- The setting of the SW2 dip switches differs in the capacity. For the detail, refer to the table above.
- Please set the switch SW5 according to the power supply voltage. Set SW5 to 240V side when the power supply is 230 and 240 volts. When the power supply is 220 volts, set SW5 to 220V side.

LED on indoor board for service

Mark	Meaning	Function
LED1	Main power supply	Main power supply (Indoor unit:220-240V) Power on → lamp is lit
LED2	Power supply for MA-Remote controller	Power supply for MA-Remote controller on → lamp is lit

PMFY

5-1. Sound levels

PMFY-P-VBM-E

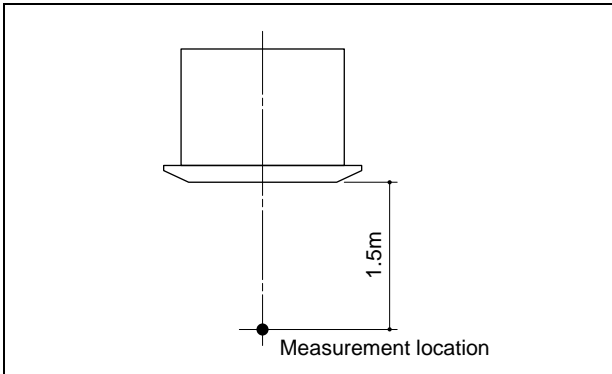

* Measured in anechoic room

Sound level at anechoic room : Low-Middle2-Middle1-High

	Sound level dB (A)
PMFY-P20VBM-E	27-30-33-35
PMFY-P25VBM-E	32-34-36-37
PMFY-P32VBM-E	33-35-37-39
PMFY-P40VBM-E	33-35-37-39

PMFY

5-2. NC curves

PMFY-P20VBM-E

External static pressure : 0Pa
Power source : 220, 230, 240V, 50Hz / 220V, 60Hz

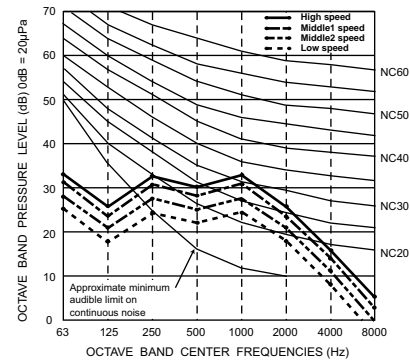

PMFY-P25, 32VBM-E

External static pressure : 0Pa
Power source : 220, 230, 240V, 50Hz / 220V, 60Hz

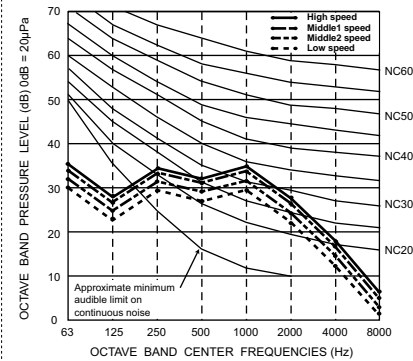

PMFY-P40VBM-E

External static pressure : 0Pa
Power source : 220, 230, 240V, 50Hz / 220V, 60Hz

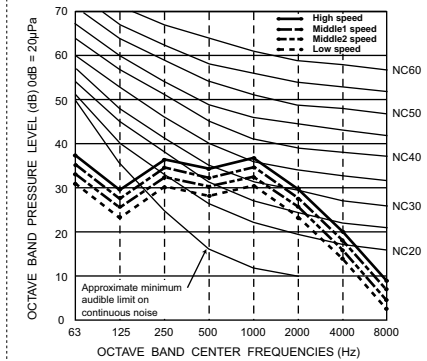

6-1. Temperature distributions

PMFY-P20-40VBM-E

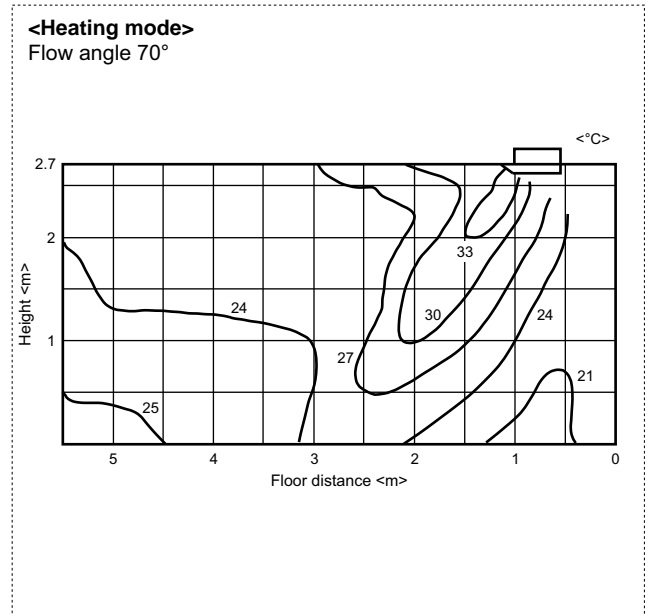
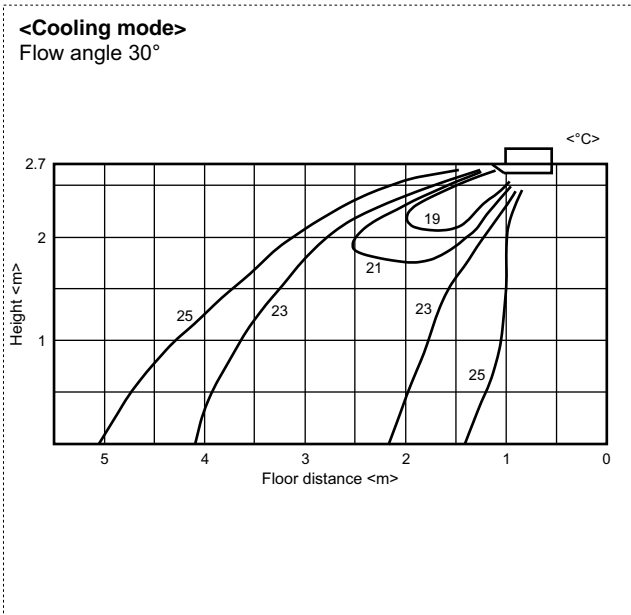

Note : These figures show typical temperature distributions in the conditions above. In the actual installation, they may differ from these figures under the influence of air temperature conditions, ceiling height, cooling/heating load, obstacles, etc.

6-2. Airflow distributions

PMFY-P20-40VBM-EC

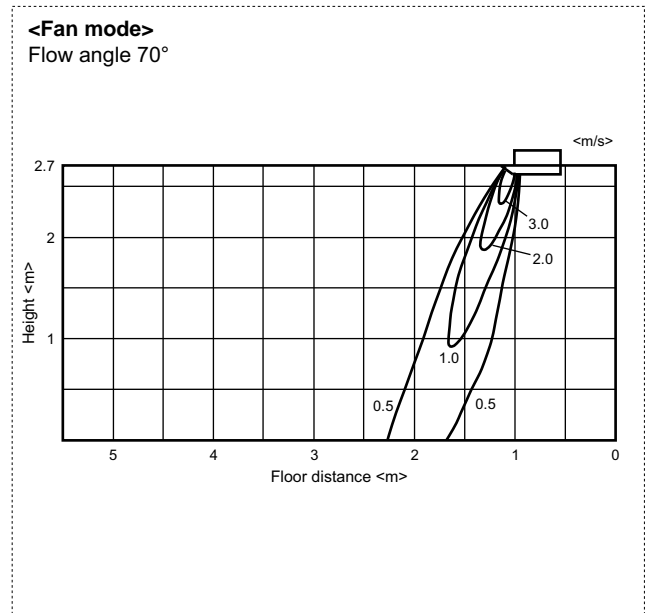
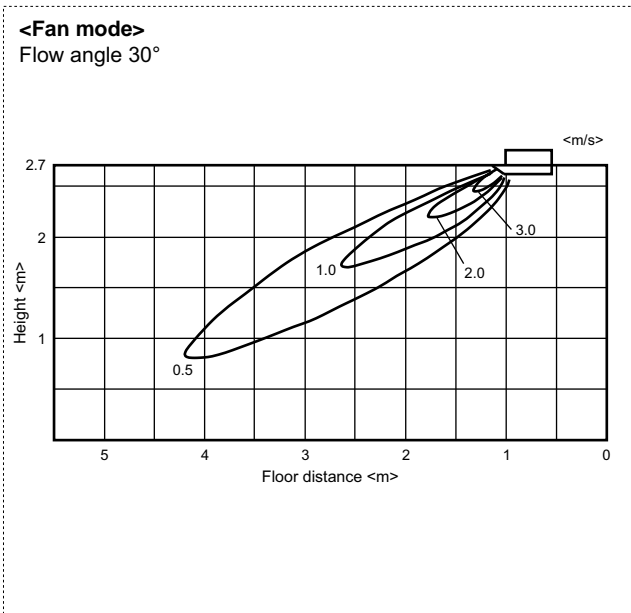

Note : These figures show typical airflow distributions in the conditions above. In the actual installation, they may differ from these figures under the influence of air temperature conditions, ceiling height, cooling/heating load, obstacles, etc.

PLFY-P-VLMD-E

1. SPECIFICATIONS	1 - 118
2. EXTERNAL DIMENSIONS	1 - 120
3. CENTER OF GRAVITY	1 - 123
4. ELECTRICAL WIRING DIAGRAMS	1 - 124
5. SOUND LEVELS	1 - 126
5-1. Sound levels	1 - 126
5-2. NC curves	1 - 126
6. OA INTAKE-STATIC PRESSURE CURVES	1 - 128
7. BRANCH DUCT INTAKE-STATIC PRESSURE CURVES	1 - 129
8. TEMPERATURE/AIRFLOW DISTRIBUTIONS	1 - 130
8-1. Temperature distributions	1 - 130
8-2. Airflow distributions	1 - 130
9. OPTIONAL PARTS	1 - 131
9-1. Optional parts line up for the Indoor unit	1 - 131
9-2. OA duct flange	1 - 131

1. SPECIFICATIONS

YKB/YLM

Model			PLFY-P20VLMD-E	PLFY-P25VLMD-E	PLFY-P32VLMD-E	PLFY-P40VLMD-E																																			
Power source			1-phase 220-240V 50Hz, 1-phase 220-230V 60Hz																																						
Cooling capacity (Nominal)	*1	kW	2.2	2.8	3.6	4.5																																			
	*1	kcal / h	1,900	2,400	3,100	3,900																																			
	*1	BTU / h	7,500	9,600	12,300	15,400																																			
	*2	kcal / h	2,000	2,500	3,150	4,000																																			
	*4	Power input	kW	0.072 / 0.075	0.072 / 0.075	0.072 / 0.075	0.081 / 0.085																																		
*4	Current input	A	0.36 / 0.37	0.36 / 0.37	0.36 / 0.37	0.40 / 0.42																																			
Heating capacity (Nominal)	*3	kW	2.5	3.2	4.0	5.0																																			
	*3	kcal / h	2,200	2,800	3,400	4,300																																			
	*3	BTU / h	8,500	10,900	13,600	17,100																																			
	*4	Power input	kW	0.065 / 0.069	0.065 / 0.069	0.065 / 0.069	0.074 / 0.079																																		
	*4	Current input	A	0.30 / 0.32	0.30 / 0.32	0.30 / 0.32	0.34 / 0.37																																		
External finish			Unit : Galvanized																																						
External dimension H x W x D		mm	290 x 776 x 634		290 x 776 x 634																																				
		in.	11-7/16 x 30-9/16 x 25		11-7/16 x 30-9/16 x 25																																				
Net weight		kg (lbs)	23 (51)	23 (51)	24 (53)	24 (53)																																			
Decoration panel	Model		CMP-40VLW-C	CMP-40VLW-C	CMP-40VLW-C	CMP-40VLW-C																																			
	External finish		ABS, MUNSELL (6.4Y 8.9/0.4), include Service Panel : Galvanized, MUNSELL (6.4Y 8.9/0.4)																																						
	Dimension		20 x 1,080 x 710																																						
	H x W x D		13/16 x 30-9/16 x 28																																						
	Net weight		6.5 (15)																																						
Heat exchanger			Cross fin																																						
FAN	Type x Quantity		Turbo fan x 1	Turbo fan x 1	Turbo fan x 1	Turbo fan x 1																																			
	External static press.	Pa	0	0	0	0																																			
		mmH ₂ O	0	0	0	0																																			
	Motor type		1-phase induction motor																																						
	Motor output		kW	0.015 (at 240V)	0.015 (at 240V)	0.015 (at 240V)	0.015 (at 240V)																																		
	Driving mechanism		Direct-driven by motor																																						
	Airflow rate (Low-Mid-High)	m ³ / min	6.5 - 8.0 - 9.5	6.5 - 8.0 - 9.5	6.5 - 8.0 - 9.5	7.0 - 8.5 - 10.5																																			
		L / s	108 - 133 - 158	108 - 133 - 158	108 - 133 - 158	117 - 142 - 175																																			
cfm		230 - 283 - 335	230 - 283 - 335	230 - 283 - 335	247 - 300 - 371																																				
Sound pressure level (Low-Mid-High) (measured in anechoic room)		dB <A>	27 - 30 - 33 (220, 240V)	27 - 30 - 33 (220,240V)	27 - 30 - 33 (220,240V)	29 - 33 - 36 (220,240V)																																			
		dB <A>	28 - 31 - 34 (230V)	28 - 31 - 34 (230V)	28 - 31 - 34 (230V)	30 - 34 - 37 (230V)																																			
Insulation material			Polystyrene foam, Polyethylene foam, Urethane foam																																						
Air filter			PP honeycomb fabric (long life filter)																																						
Protection device			Fuse																																						
Refrigerant control device			LEV																																						
Connectable outdoor unit			R410A CITY MULTI																																						
Diameter of refrigerant pipe	Liquid (R410A)	mm (in.)	ø6.35 (ø1/4) Flare	ø6.35 (ø1/4) Flare	ø6.35 (ø1/4) Flare	ø6.35 (ø1/4) Flare																																			
	Gas (R410A)	mm (in.)	ø12.7 (ø1/2) Flare	ø12.7 (ø1/2) Flare	ø12.7 (ø1/2) Flare	ø12.7 (ø1/2) Flare																																			
Field drain pipe size		mm (in.)	O.D. 32mm (1-1/4)																																						
Drawing	External		IU-W275-920																																						
	Wiring		IU-W653-952																																						
	Refrigerant cycle		-																																						
Standard attachment	Document		Installation Manual, Instruction Book																																						
	Accessory		Drain hose I.D. 32mm (1-1/4) (flexible joint)																																						
Remark	Optional parts																																								
	Decoration panel		CMP-40VLW-C	CMP-40VLW-C	CMP-40VLW-C	CMP-40VLW-C																																			
	OA duct flange		PAC-KH110F	PAC-KH110F	PAC-KH110F	PAC-KH110F																																			
Installation		Details on foundation work, duct work, insulation work, electrical wiring, power source switch, and other items shall be referred to the Installation Manual.																																							
<p>Note :</p> <table border="0"> <tr> <td>*1 Nominal cooling conditions</td> <td>*2 Nominal cooling conditions</td> <td>*3 Nominal heating conditions</td> <td colspan="4">Unit converter</td> </tr> <tr> <td>Indoor : 27°CDB/19°CWB (81°FDB/66°FWB)</td> <td>27°CDB/19.5°CWB (81°FDB/67°FWB)</td> <td>20°CDB (68°FDB)</td> <td>kcal/h = kW x 860</td> <td colspan="3"></td> </tr> <tr> <td>Outdoor : 35°CDB (95°FDB)</td> <td>35°CDB (95°FDB)</td> <td>7°CDB/6°CWB (45°FDB/43°FWB)</td> <td>BTU/h = kW x 3,412</td> <td colspan="3"></td> </tr> <tr> <td>Pipe length : 7.5 m (24-9/16 ft)</td> <td>5 m (16-3/8 ft)</td> <td>7.5 m (24-9/16 ft)</td> <td>cfm = m³/min x 35.31</td> <td colspan="3"></td> </tr> <tr> <td>Level difference : 0 m (0 ft)</td> <td>0 m (0 ft)</td> <td>0 m (0 ft)</td> <td>lbs = kg / 0.4536</td> <td colspan="3"></td> </tr> </table> <p>* Nominal conditions *1, *3 are subject to JIS B8615-1. * Due to continuing improvement, above specification may be subject to change without notice. *4 The values are measured at the factory setting of external static pressure.</p>							*1 Nominal cooling conditions	*2 Nominal cooling conditions	*3 Nominal heating conditions	Unit converter				Indoor : 27°CDB/19°CWB (81°FDB/66°FWB)	27°CDB/19.5°CWB (81°FDB/67°FWB)	20°CDB (68°FDB)	kcal/h = kW x 860				Outdoor : 35°CDB (95°FDB)	35°CDB (95°FDB)	7°CDB/6°CWB (45°FDB/43°FWB)	BTU/h = kW x 3,412				Pipe length : 7.5 m (24-9/16 ft)	5 m (16-3/8 ft)	7.5 m (24-9/16 ft)	cfm = m ³ /min x 35.31				Level difference : 0 m (0 ft)	0 m (0 ft)	0 m (0 ft)	lbs = kg / 0.4536			
*1 Nominal cooling conditions	*2 Nominal cooling conditions	*3 Nominal heating conditions	Unit converter																																						
Indoor : 27°CDB/19°CWB (81°FDB/66°FWB)	27°CDB/19.5°CWB (81°FDB/67°FWB)	20°CDB (68°FDB)	kcal/h = kW x 860																																						
Outdoor : 35°CDB (95°FDB)	35°CDB (95°FDB)	7°CDB/6°CWB (45°FDB/43°FWB)	BTU/h = kW x 3,412																																						
Pipe length : 7.5 m (24-9/16 ft)	5 m (16-3/8 ft)	7.5 m (24-9/16 ft)	cfm = m ³ /min x 35.31																																						
Level difference : 0 m (0 ft)	0 m (0 ft)	0 m (0 ft)	lbs = kg / 0.4536																																						

1. SPECIFICATIONS

YKB/YLM

Model		PLFY-P50VLM-D-E	PLFY-P63VLM-D-E	PLFY-P80VLM-D-E	PLFY-P100VLM-D-E	PLFY-P125VLM-D-E		
Power source		1-phase 220-240V 50Hz, 1-phase 220-230V 60Hz						
Cooling capacity (Nominal)	*1	kW	5.6	7.1	9.0	11.2	14.0	
	*1	kcal / h	4,800	6,100	7,700	9,600	12,000	
	*1	BTU / h	19,100	24,200	30,700	38,200	47,800	
	*2	kcal / h	5,000	6,300	8,000	10,000	12,500	
	*4	Power input	kW	0.082 / 0.086	0.101 / 0.105	0.147 / 0.156	0.157 / 0.186	0.28 / 0.28
	*4	Current input	A	0.41 / 0.43	0.49 / 0.51	0.72 / 0.74	0.75 / 0.88	1.35 / 1.35
Heating capacity (Nominal)	*3	kW	6.3	8.0	10.0	12.5	16.0	
	*3	kcal / h	5,400	6,900	8,600	10,800	13,800	
	*3	BTU / h	21,500	27,300	34,100	42,700	54,600	
	*4	Power input	kW	0.075 / 0.080	0.094 / 0.099	0.140 / 0.150	0.150 / 0.180	0.27 / 0.27
	*4	Current input	A	0.35 / 0.38	0.43 / 0.46	0.66 / 0.69	0.69 / 0.83	1.33 / 1.33
	External finish		Unit : Galvanized					
External dimension H x W x D		mm	290 x 946 x 634		290 x 1,446 x 634		290 x 1,708 x 606	
		in.	11-7/16 x 37-1/4 x 25		11-7/16 x 56-15/16 x 25		11-7/16 x 67-1/4 x 23-7/8	
Net weight		kg (lbs)	27 (60)	28 (62)	44 (98)	47 (104)	56 (124)	
Decoration panel	Model		CMP-63VLW-C	CMP-63VLW-C	CMP-100VLW-C	CMP-100VLW-C	CMP-125VLW-C	
	External finish	ABS, MUNSELL (6.4Y 8.9/0.4), include Service Panel : Galvanized, MUNSELL (6.4Y 8.9/0.4)						
	Dimension	mm	20 x 1,250 x 710		20 x 1,750 x 710		20 x 2,010 x 710	
	H x W x D	in.	13/16 x 49-1/4 x 28		13/16 x 56-15/16 x 28		13/16 x 67-1/4 x 28	
	Net weight	kg (lbs)	7.5 (17)		12.5 (28)		13.0 (29)	
Heat exchanger		Cross fin						
FAN	Type x Quantity		Turbo fan x 1	Turbo fan x 1	Turbo fan x 2	Turbo fan x 2	Sirocco fan x 4	
	External static press.	Pa	0	0	0	0	0	
		mmH ₂ O	0	0	0	0	0	
	Motor type		1-phase induction motor					
	Motor output		kW	0.020 (at 240V)	0.020 (at 240V)	0.020 x 2 (at 240V)	0.030 x 2 (at 240V)	0.078 x 2 (at 240V)
	Driving mechanism		Direct-driven by motor					
	Airflow rate (Low-Mid-High)	m ³ / min	9.0 - 11.0 - 12.5	10.0 - 13.0 - 15.5	15.5 - 18.5 - 22.0	17.5 - 21.0 - 25.0	24.0 - 27.0 - 30.0 - 33.0	
L / s		150 - 183 - 208	167 - 217 - 258	258 - 308 - 367	292 - 350 - 417	400 - 450 - 500 - 550		
cfm		318 - 388 - 441	353 - 459 - 547	547 - 653 - 777	618 - 742 - 883	848 - 953 - 1,059 - 1,165		
Sound pressure level (Low-Mid-High) (measured in anechoic room)	*4	dB <A>	31 - 34 - 37 (220, 240V)	32 - 37 - 39 (220, 240V)	33 - 36 - 39 (220, 240V)	36 - 39 - 42 (220, 240V)	40 - 42 - 44 - 46 (220, 240V)	
		dB <A>	32 - 35 - 38 (230V)	33 - 38 - 40 (230V)	34 - 37 - 40 (230V)	37 - 41 - 43 (230V)	40 - 42 - 44 - 46 (230V)	
Insulation material		Polystyrene foam, Polyethylene foam, Urethane foam						
Air filter		PP honeycomb fabric (long life filter)					Synthetic fiber unwoven cloth filter (long life)	
Protection device		Fuse						
Refrigerant control device		LEV						
Connectable outdoor unit		R410A CITY MULTI						
Diameter of refrigerant pipe	Liquid (R410A)	mm (in.)	ø6.35 (ø1/4) Flare	ø9.52 (ø3/8) Flare	ø9.52 (ø3/8) Flare	ø9.52 (ø3/8) Flare	ø9.52 (ø3/8) Flare	
	Gas (R410A)	mm (in.)	ø12.7 (ø1/2) Flare	ø15.88 (ø5/8) Flare	ø15.88 (ø5/8) Flare	ø15.88 (ø5/8) Flare	ø15.88 (ø5/8) Flare	
Field drain pipe size		mm (in.)	O.D. 32mm (1-1/4)					
Drawing	External		IU-W275-920	IU-W275-920	IU-W275-920	IU-W275-920	IU-W275-921	
	Wiring		IU-W653-952	IU-W653-952	IU-W653-952	IU-W653-952	IU-W275-927	
	Refrigerant cycle		-	-	-	-	-	
Standard attachment	Document	Installation Manual, Instruction Book						
	Accessory	Drain hose I.D. 32mm (1-1/4) (flexible joint)						
Remark	Optional parts							
	Decoration panel		CMP-63VLW-C	CMP-63VLW-C	CMP-100VLW-C	CMP-100VLW-C	CMP-125VLW-C	
	OA duct flange		PAC-KH11OF	PAC-KH11OF	PAC-KH11OF	PAC-KH11OF	PAC-KH11OF	
	Installation		Details on foundation work, duct work, insulation work, electrical wiring, power source switch, and other items shall be referred to the Installation Manual.					
Note :		*1 Nominal cooling conditions	*2 Nominal cooling conditions	*3 Nominal heating conditions	Unit converter			
Indoor :		27°CDB/19°CWB (81°FDB/66°FWB)	27°CDB/19.5°CWB (81°FDB/67°FWB)	20°CDB (68°FDB)	kcal/h = kW x 860			
Outdoor :		35°CDB (95°FDB)	35°CDB (95°FDB)	7°CDB/6°CWB (45°FDB/43°FWB)	BTU/h = kW x 3,412			
Pipe length :		7.5 m (24-9/16 ft)	5 m (16-3/8 ft)	7.5 m (24-9/16 ft)	cfm = m ³ /min x 35.31			
Level difference :		0 m (0 ft)	0 m (0 ft)	0 m (0 ft)	lbs = kg / 0.4536			
* Nominal conditions *1, *3 are subject to JIS B8615-1.								
* Due to continuing improvement, above specification may be subject to change without notice.								
*4 The values are measured at the factory setting of external static pressure.								

PLFY

PLFY-P20, 25, 32, 40, 50, 63, 80, 100VLM-D-E

Unit : mm

PLFY

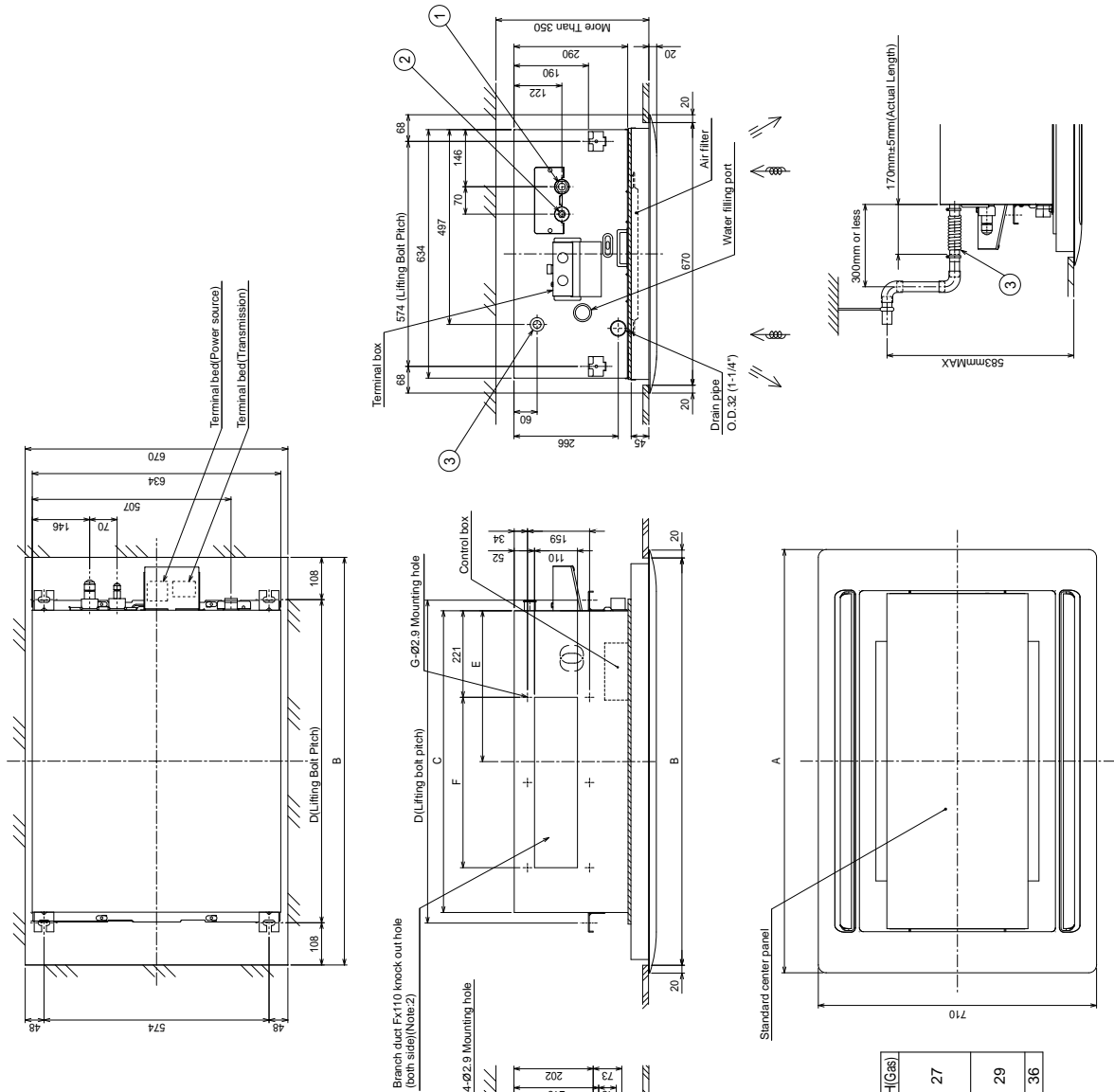

Note: 1. Use M10 screw for the lifting bolt (field supply).
 2. It is available to connect the branch duct on right and left side both.

Model	Gas pipe	Liquid pipe	<flare>	①	②	③
20-25-32-40	ø12.7	ø6.35	
50	ø12.7	ø6.35	
63-80	ø15.88	ø9.52	
100	ø15.88	ø9.52	
Drain hose	I.D. 32 (1-1/4")	<flexible joint>	(accessory)

Model	A	B	C	D	E	F	G	H [Liquid]	H [Gas]
PLFY-P20VLM-D-E	1080	1040	776	824	388	217.5x2	6	17	27
PLFY-P25VLM-D-E						=435			
PLFY-P32VLM-D-E									
PLFY-P40VLM-D-E									
PLFY-P50VLM-D-E	1250	1210	946	994	473			22	29
PLFY-P63VLM-D-E									
PLFY-P80VLM-D-E									
PLFY-P100VLM-D-E	1750	1710	1446	1494	723	188.5x4	10	22	36
						=754			

PLFY-P20, 25, 32, 40, 50, 63, 80, 100VLM-D-E with OA duct flange

Unit : mm

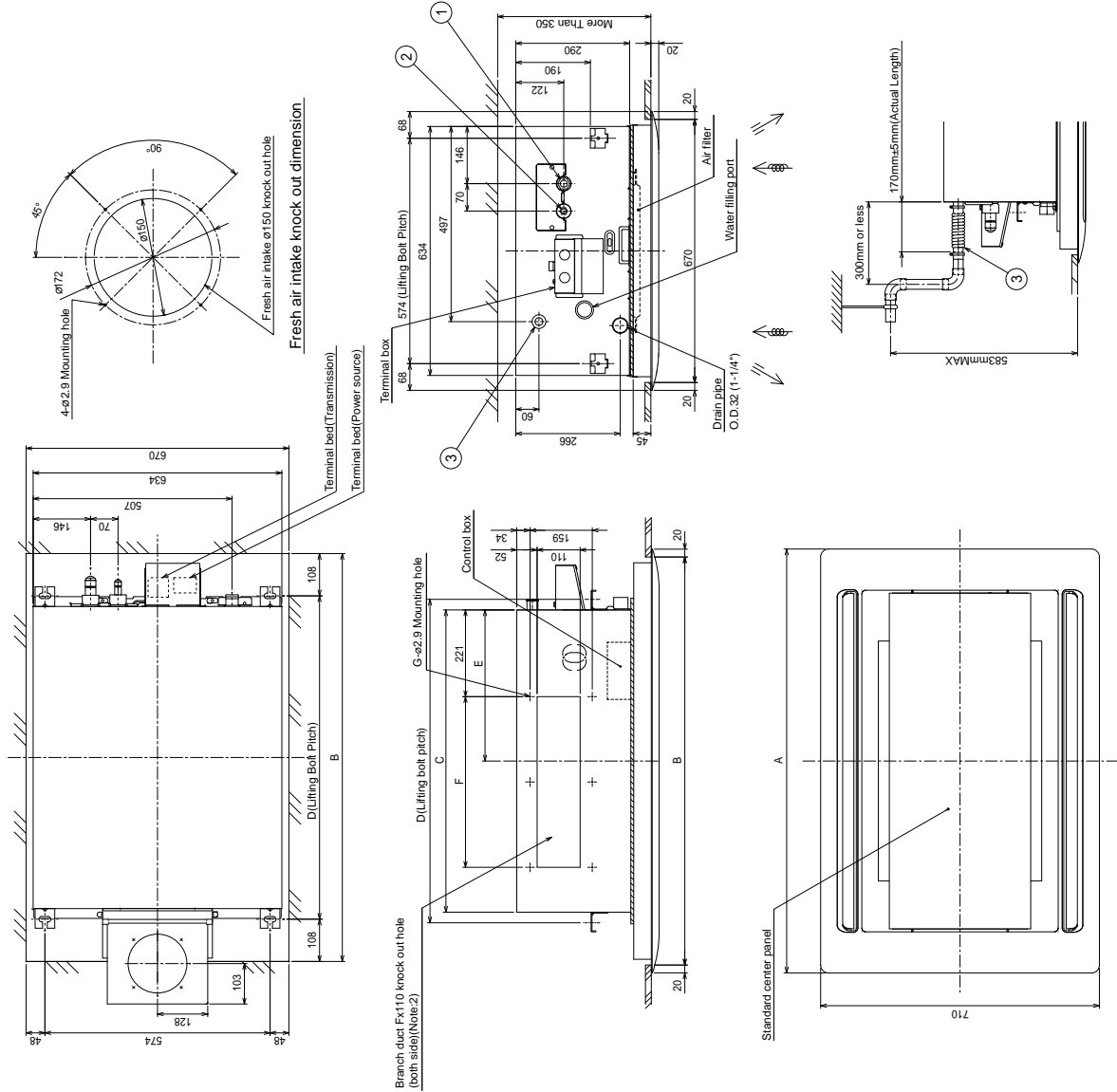

Note: 1. Use M10 screw for the lifting bolt (field supply).
 2. It is available to connect the branch duct on right and left side both.

Model	<flares>	Gas pipe	Liquid pipe	①	②
Model 20-25-32-40	$\phi 12.7$ $\phi 6.35$	Gas pipe	Liquid pipe
Model 50	$\phi 12.7$ $\phi 6.35$	Gas pipe	Liquid pipe
Model 63-80	$\phi 15.88$ $\phi 9.52$	Gas pipe	Liquid pipe
Model 100	$\phi 15.88$ $\phi 9.52$	Gas pipe	Liquid pipe
Drain hose	I.D. 32 (1-1/4")	<flexible joint>	(accessory)	③

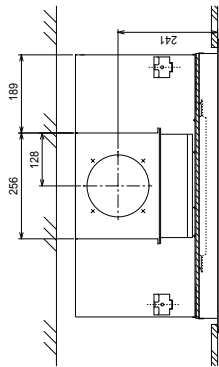

Model	A	B	C	D	E	F	G
PLFY-P20VLM-D-E	1080	1040	776	824	388	217.5x2	6
PLFY-P25VLM-D-E						≈ 435	
PLFY-P32VLM-D-E							
PLFY-P40VLM-D-E							
PLFY-P50VLM-D-E	1250	1210	946	994	473		
PLFY-P63VLM-D-E							
PLFY-P80VLM-D-E	1750	1710	1446	1494	723	188.5x4	10
PLFY-P100VLM-D-E						≈ 754	

PLFY

PLFY-P125VLM-D-E

Unit : mm

PLFY

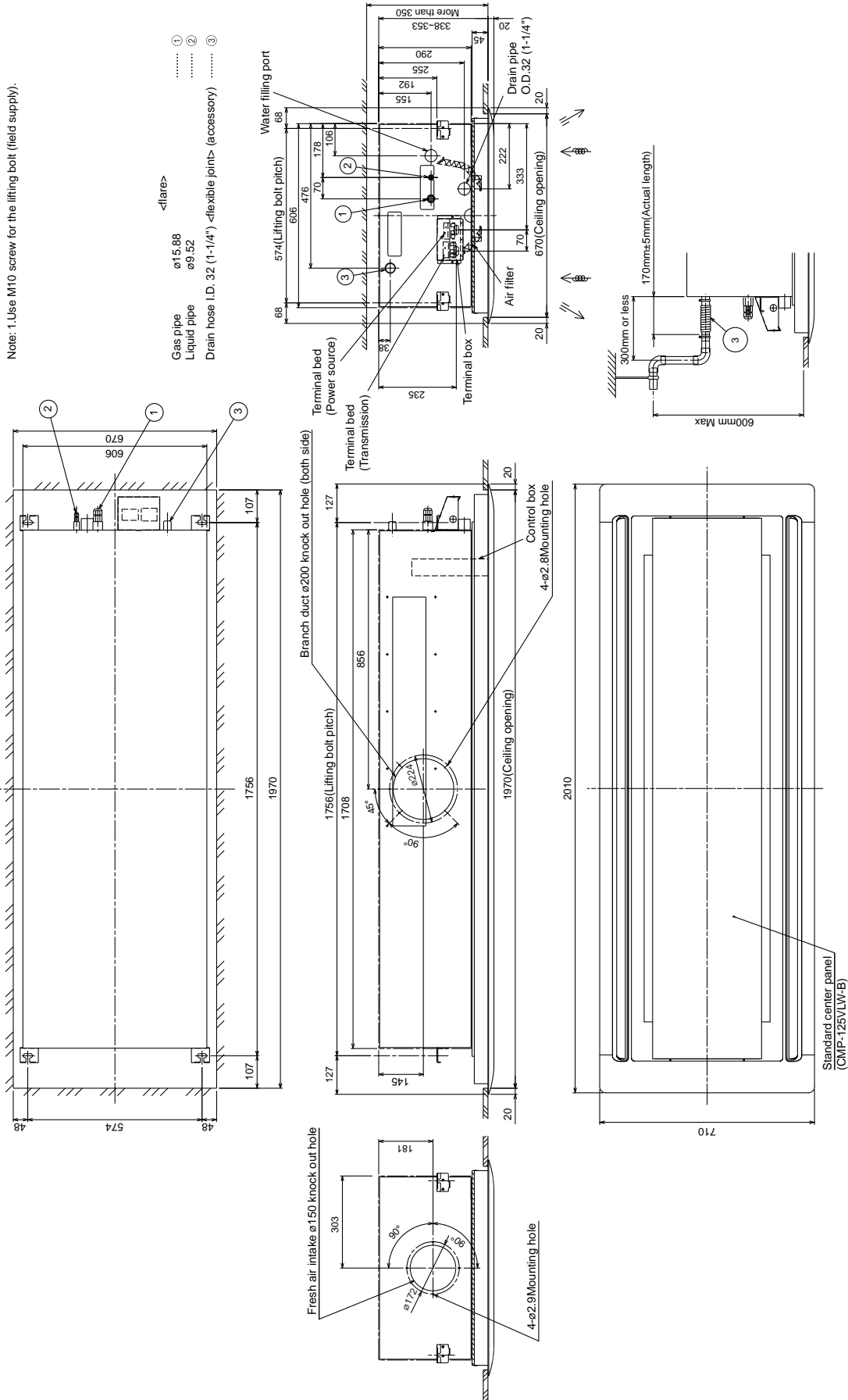

PLFY-P20, 25, 32, 40, 50, 63, 80, 100, 125VLMD-E

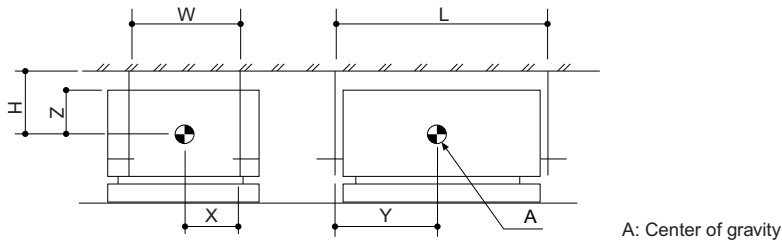

Model name	(mm)[in]					
	W	L	H	X	Y	Z
PLFY-P20VLMD-E	574 [22-5/8]	824 [32-15/32]	172 [6-25/32]	287 [11-5/16]	370 [14-19/32]	160 [6-5/16]
PLFY-P25VLMD-E	574 [22-5/8]	824 [32-15/32]	172 [6-25/32]	287 [11-5/16]	370 [14-19/32]	160 [6-5/16]
PLFY-P32VLMD-E	574 [22-5/8]	824 [32-15/32]	172 [6-25/32]	287 [11-5/16]	370 [14-19/32]	160 [6-5/16]
PLFY-P40VLMD-E	574 [22-5/8]	824 [32-15/32]	172 [6-25/32]	287 [11-5/16]	370 [14-19/32]	160 [6-5/16]
PLFY-P50VLMD-E	574 [22-5/8]	994 [32-5/32]	172 [6-25/32]	287 [11-5/16]	445 [17-17/32]	160 [6-5/16]
PLFY-P63VLMD-E	574 [22-5/8]	994 [32-5/32]	172 [6-25/32]	287 [11-5/16]	445 [17-17/32]	160 [6-5/16]
PLFY-P80VLMD-E	574 [22-5/8]	1494 [58-27/32]	172 [6-25/32]	287 [11-5/16]	655 [25-13/16]	160 [6-5/16]
PLFY-P100VLMD-E	574 [22-5/8]	1494 [58-27/32]	172 [6-25/32]	287 [11-5/16]	655 [25-13/16]	160 [6-5/16]
PLFY-P125VLMD-E	574 [22-5/8]	1756 [69-5/32]	203 [8]	287 [11-5/16]	758 [29-27/32]	181 [7-5/32]

PLFY

PLFY-P20, 25, 32, 40, 50, 63, 80, 100VLM-D-E

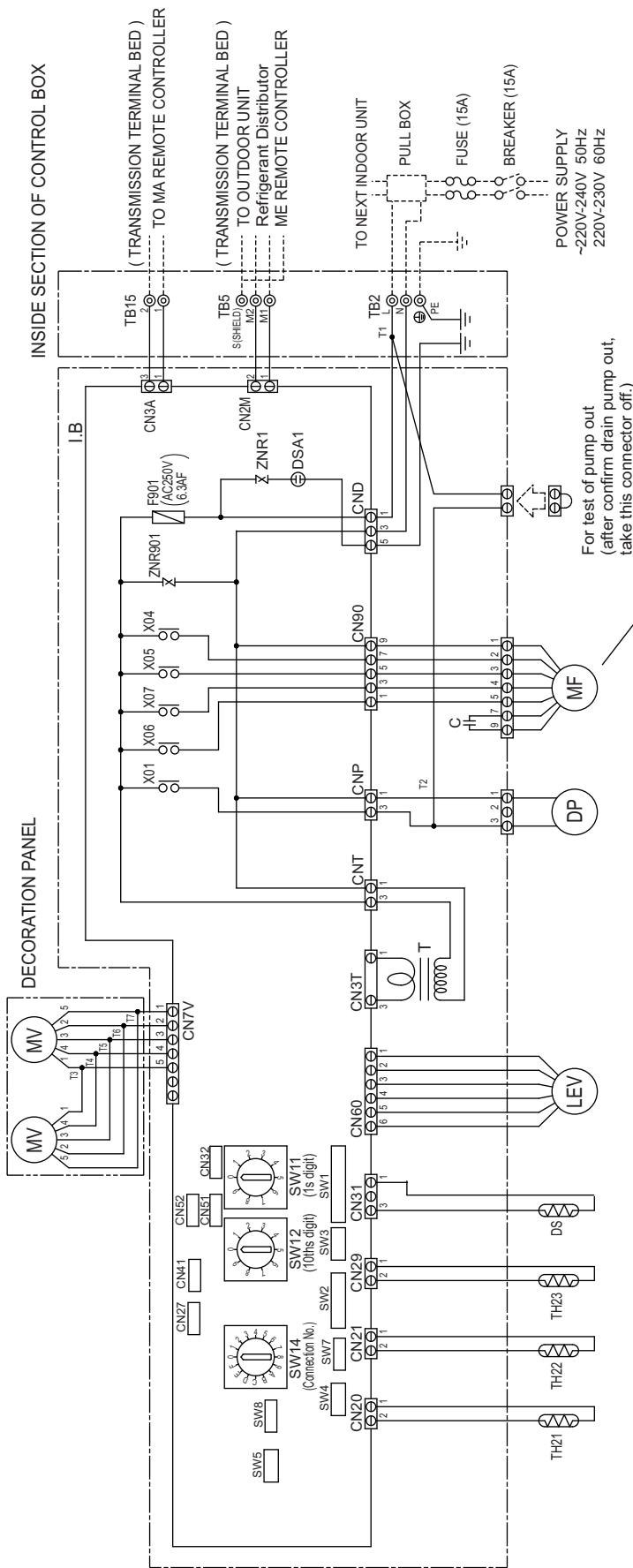

NOTE : 1. TB2, TB5, and TB15 shown in dotted line are field work.
 2. Mark ⊙ indicates terminal bed, ⊖ connector, ⊕ board insertion connector of fastening connector of control board.

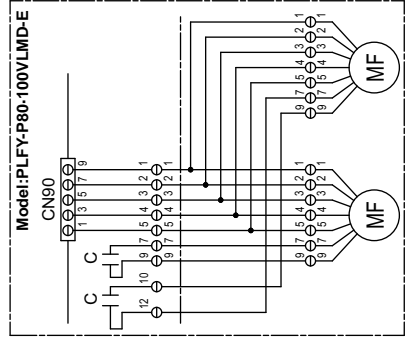

SYMBOL		NAME		SYMBOL		NAME	
MF	Fan motor	CN27	Connector (Damper)	SW11	Switch (1s digit address set)	CN90	Terminal
C	Capacitor(for MF)	CN32	Connector (Centrally control)	SW12	Switch (10ths digit address set)	T1-T7	Thermistor (pipe temp.detection/liquid)
I.B	Indoor controller board	CN41	Connector (HA terminal-A)	SW14	Switch (connection No.set)	TH21	Thermistor (inlet temp.detection)
TB2	Power source terminal bed	CN51	Connector (Centrally control)	SW1	Switch (for mode selection 1)	TH22	Thermistor (pipe temp.detection/liquid)
TB5	Transmission terminal bed	CN52	Connector (Remote indication)	SW2	Switch (for capacity code)	TH23	Thermistor (pipe temp.detection/gas)
TB15	MA Remote controller terminal bed	X01	Aux.relay (Drain pump)	SW3	Switch (for mode selection 2)	DS	Drain sensor
F901	Fuse (6.3A/6A)	X04	Aux.relay (L notch:240V)	SW4	Switch (for mode selection)	DP	Drain pump
ZNR1,ZNR901	Varistor	X05	Aux.relay (M/L notch:240V/220-230V)	SW5	Switch (for voltage selection)	MV	Motor for vane
T	Transformer	X06	Aux.relay (H notch:220-230V)	SW7	Switch (for model selection)		
DP	Drain pump	X07	Aux.relay (H/M notch:240V/220-230V)	SW8	Switch (for model selection 3)		
LEV	Electronic linear expan.valve	TH21	Thermistor (inlet temp.detection)				
DS	Drain sensor	TH22	Thermistor (pipe temp.detection/liquid)				
MV	Motor for vane	TH23	Thermistor (pipe temp.detection/gas)				

PLFY-P125VLM-D-E

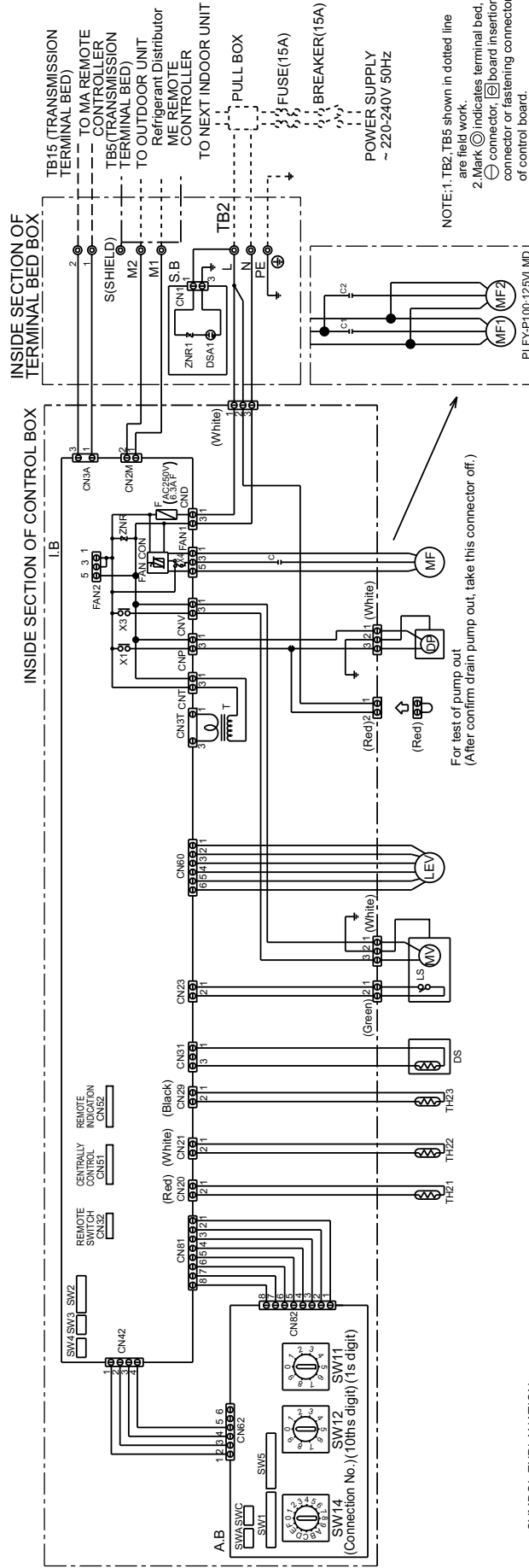

SYMBOL EXPLANATION

SYMBOL	NAME	SYMBOL	NAME	SYMBOL	NAME
MF, MF1, MF2	Fan motor	LEV	Electronic linear expan. valve	SW14(A,B)	Switch (connection No. set)
C1, C2	Capacitor (for MF, MF1, MF2)	S, B	Surge absorber board	SW1(A,B)	Switch (for mode selection)
A, B	Address board	LS	Limit switch (MV built in)	SW2(LB)	Switch (for capacity code)
TB2	Power source terminal bed	MV	Motor for vane (with limit switch)	SW3(LB)	Switch (for mode selection)
TB5	Transmission terminal bed	DS	Drain sensor	SW4(LB)	Switch (for mode selection)
TB15	Transmission terminal bed	TH21	Thermistor (inlet temp. detection)	SW5(A,B)	Switch (for voltage selection)
F	Fuse AC250V/6.3A F	TH23	Thermistor (pipe temp. detection / liquid)	SWC(A,B)	Switch (option parts)
T	Transformer	SW11(A,B)	Switch (1s digit address set)	X1, X3, X4	Aux. relay
DP	Drain pump	SW12(A,B)	Switch (10ths digit address set)		

PLFY

5-1. Sound levels

PLFY-P-VLMD-E

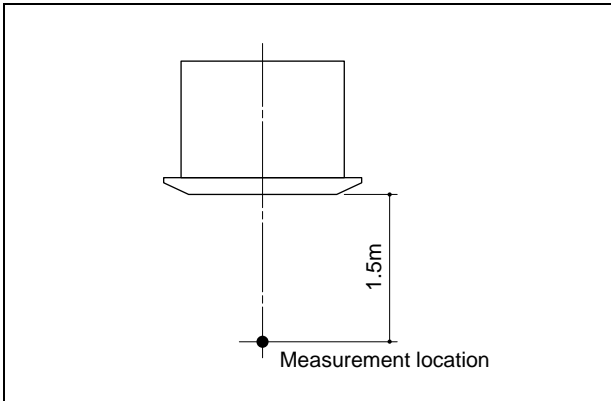

* Measured in anechoic room

Sound level at anechoic room : Low-Mid-High

	Sound level dB (A)	
	220,240V	230V
PLFY-P20VLMD-E		
PLFY-P25VLMD-E	27-30-33	28-31-34
PLFY-P32VLMD-E		
PLFY-P40VLMD-E	29-33-36	30-34-37
PLFY-P50VLMD-E	31-34-37	32-35-38
PLFY-P63VLMD-E	32-37-39	33-38-40
PLFY-P80VLMD-E	33-36-39	34-37-40
PLFY-P100VLMD-E	36-39-42	37-41-43
PLFY-P125VLMD-E	40-42-44-46	

PLFY

5-2. NC curves

PLFY-P20,25VLMD-E

External static pressure : 0Pa
Power source : 220,240V, 50/60Hz

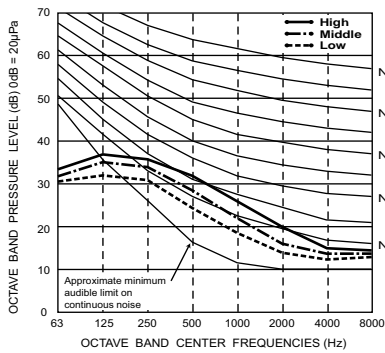

PLFY-P20,25VLMD-E

External static pressure : 0Pa
Power source : 230V, 50/60Hz

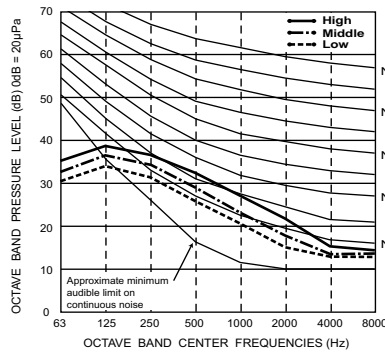

PLFY-P32VLMD-E

External static pressure : 0Pa
Power source : 220,240V, 50/60Hz

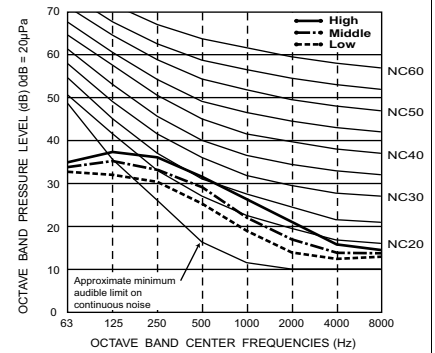

PLFY-P32VLMD-E

External static pressure : 0Pa
Power source : 230V, 50/60Hz

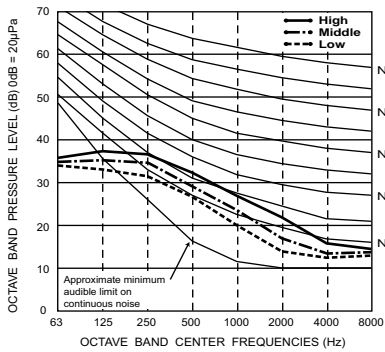

PLFY-P40VLMD-E

External static pressure : 0Pa
Power source : 220,240V, 50/60Hz

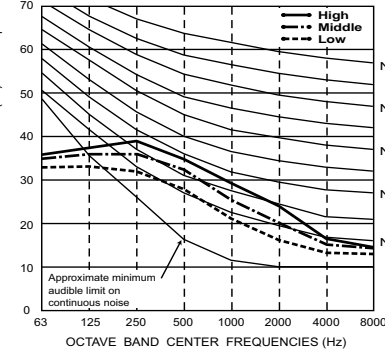

PLFY-P40VLMD-E

External static pressure : 0Pa
Power source : 230V, 50/60Hz

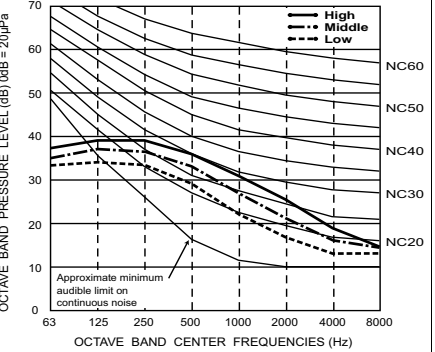

PLFY-P50VLM-D-E

External static pressure : 0Pa
Power source : 220,240V, 50/60Hz

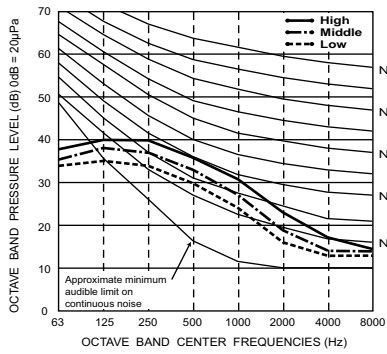

PLFY-P50VLM-D-E

External static pressure : 0Pa
Power source : 230V, 50/60Hz

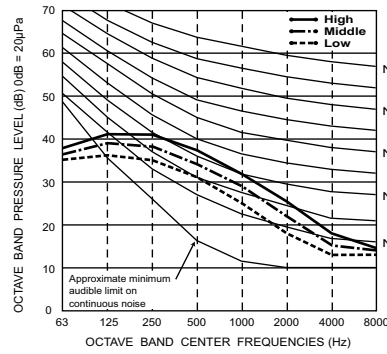

PLFY-P63VLM-D-E

External static pressure : 0Pa
Power source : 220,240V, 50/60Hz

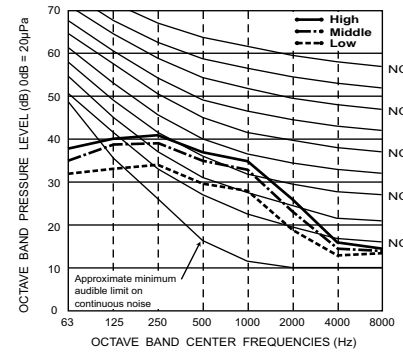

PLFY-P63VLM-D-E

External static pressure : 0Pa
Power source : 230V, 50/60Hz

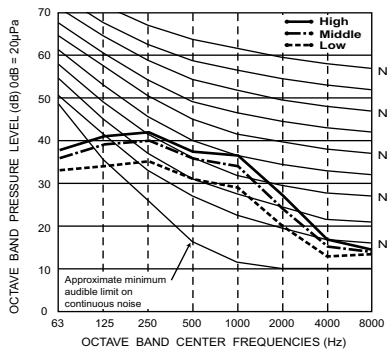

PLFY-P80VLM-D-E

External static pressure : 0Pa
Power source : 220,240V, 50/60Hz

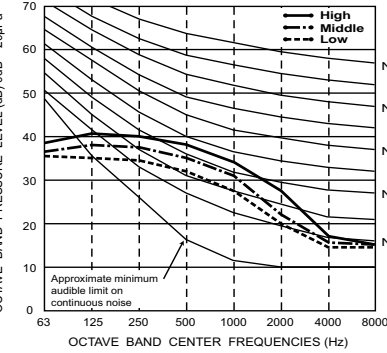

PLFY-P80VLM-D-E

External static pressure : 0Pa
Power source : 230V, 50/60Hz

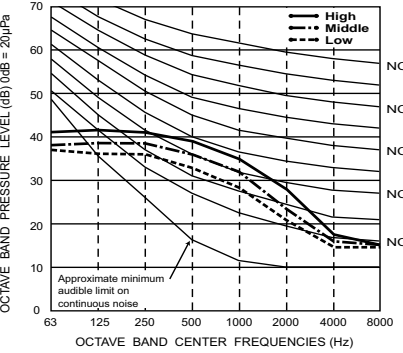

PLFY-P100VLM-D-E

External static pressure : 0Pa
Power source : 220,240V, 50/60Hz

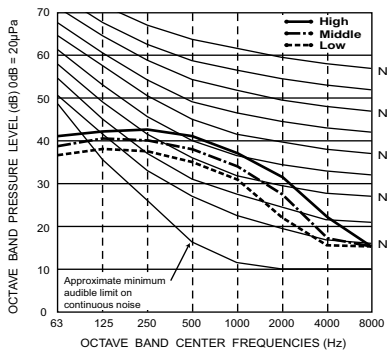

PLFY-P100VLM-D-E

External static pressure : 0Pa
Power source : 230V, 50/60Hz

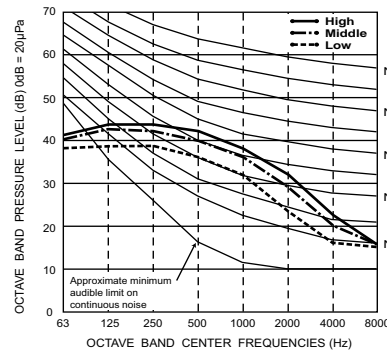

PLFY-P125VLM-D-E

External static pressure : 0Pa
Power source : 220,240V, 50/60Hz

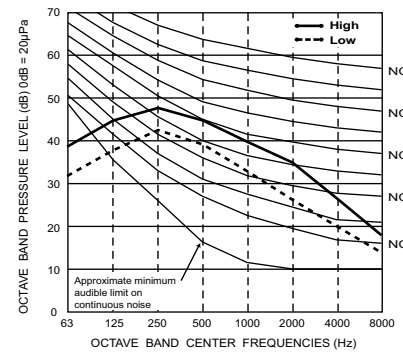

PLFY-P125VLM-D-E

External static pressure : 0Pa
Power source : 230V, 50/60Hz

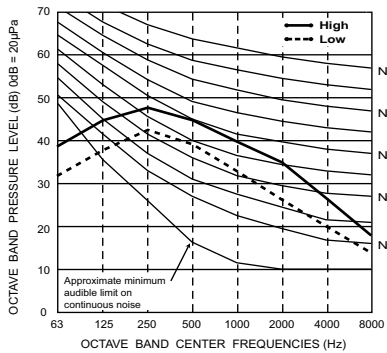

6. OA INTAKE-STATIC PRESSURE CURVES

YKB/YLM

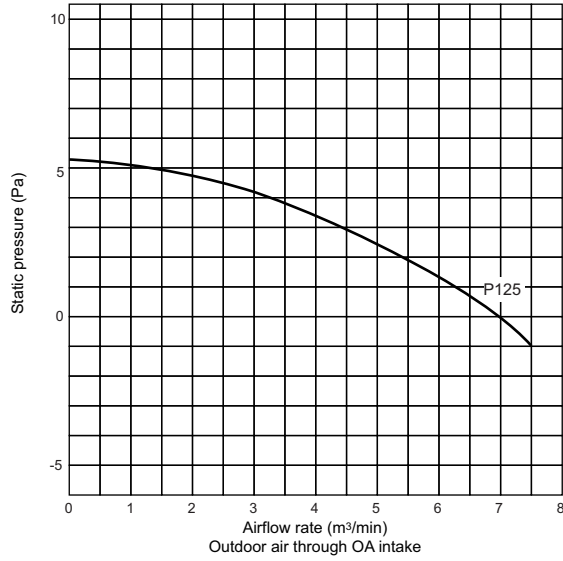
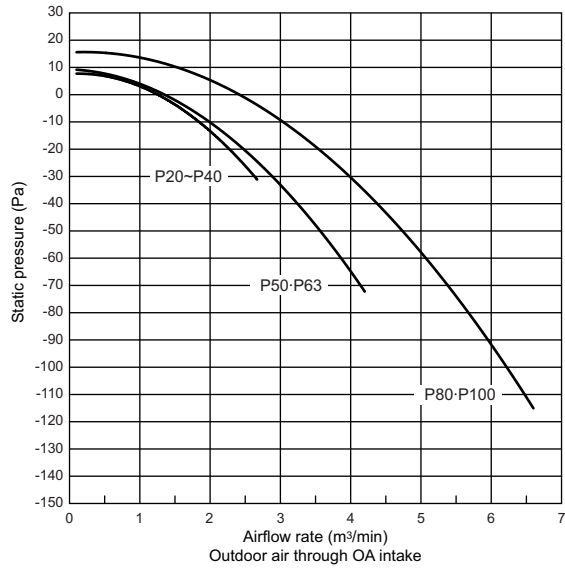

Please confirm that inlet-air temperature (which is mixed with outdoor air) is in the following operating temperature range.

PLFY-P-VLMD-E: Operating temperature range

Mode	Temperature range of inlet air
Cooling	15°C~24°C(Wet bulb)
Dry	
Heating	15°C~27°C(Dry bulb)

*Relative humidity range is 30~80%.

PLFY

7. BRANCH DUCT INTAKE-STATIC PRESSURE CURVES

YKB/YLM

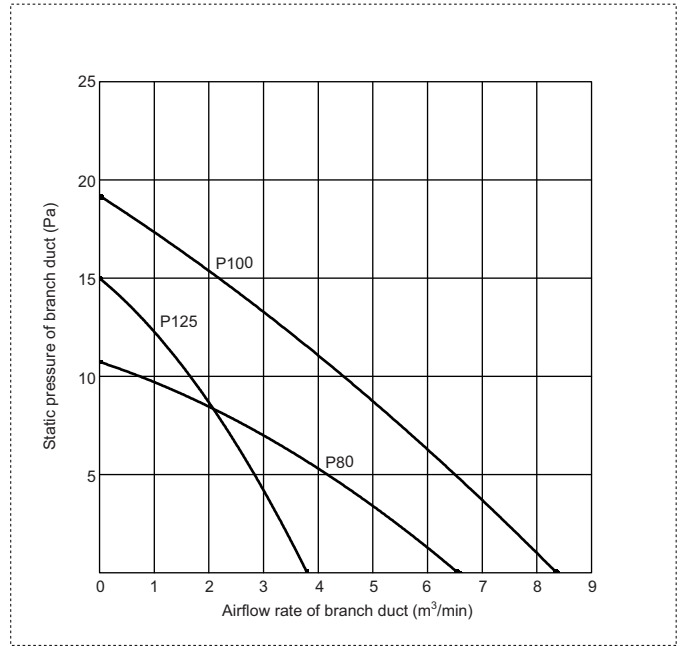
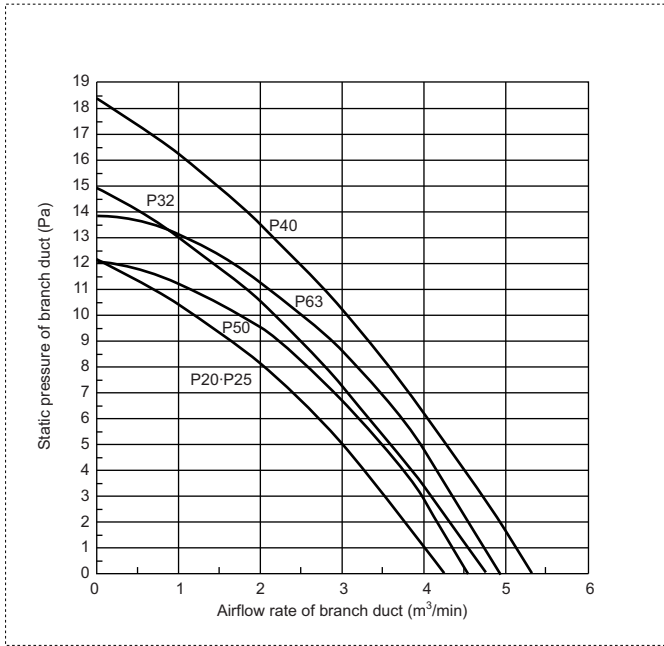

PLFY

8-1. Temperature distributions

PLFY-P20-125VLM-D-E

<Cooling mode>

Airflow angle : Horizontal
 Room temp.: 27°C
 Airflow rate : High

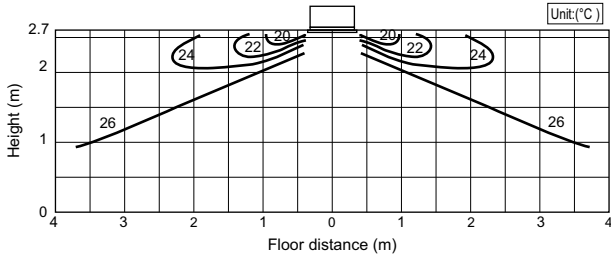

<Heating mode>

Airflow angle : Downward
 Room temp.: 20°C
 Airflow rate : High

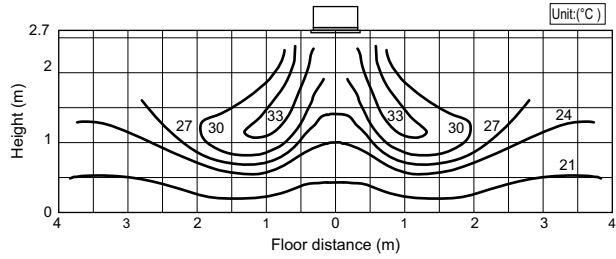

Note : These figures show typical temperature distributions in the conditions above. In the actual installation, they may differ from these figures under the influence of air temperature conditions, ceiling height, cooling/heating load, obstacles, etc.

8-2. Airflow distributions

PLFY-P20-125VLM-D-E

<Cooling mode>

Airflow angle : Horizontal
 Room temp.: 27°C
 Airflow rate : High

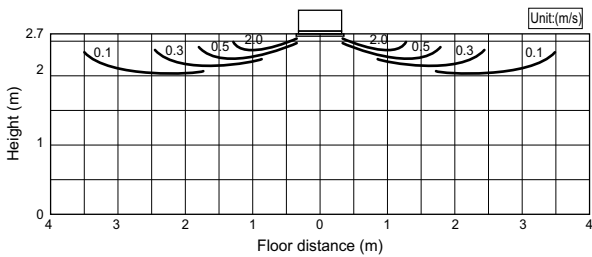

<Heating mode>

Airflow angle : Downward
 Room temp.: 20°C
 Airflow rate : High

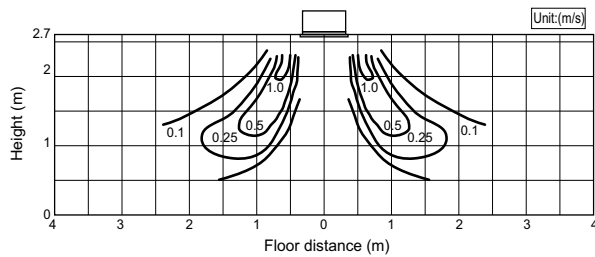

Note : These figures show typical airflow distributions in the conditions above. In the actual installation, they may differ from these figures under the influence of air temperature conditions, ceiling height, cooling/heating load, obstacles, etc.

PLFY

9-1. Optional parts line up for the Indoor unit

	OA duct flange
PLFY-P-VLMD-E	PAC-KH110F

PLFY-P-VLMD-E

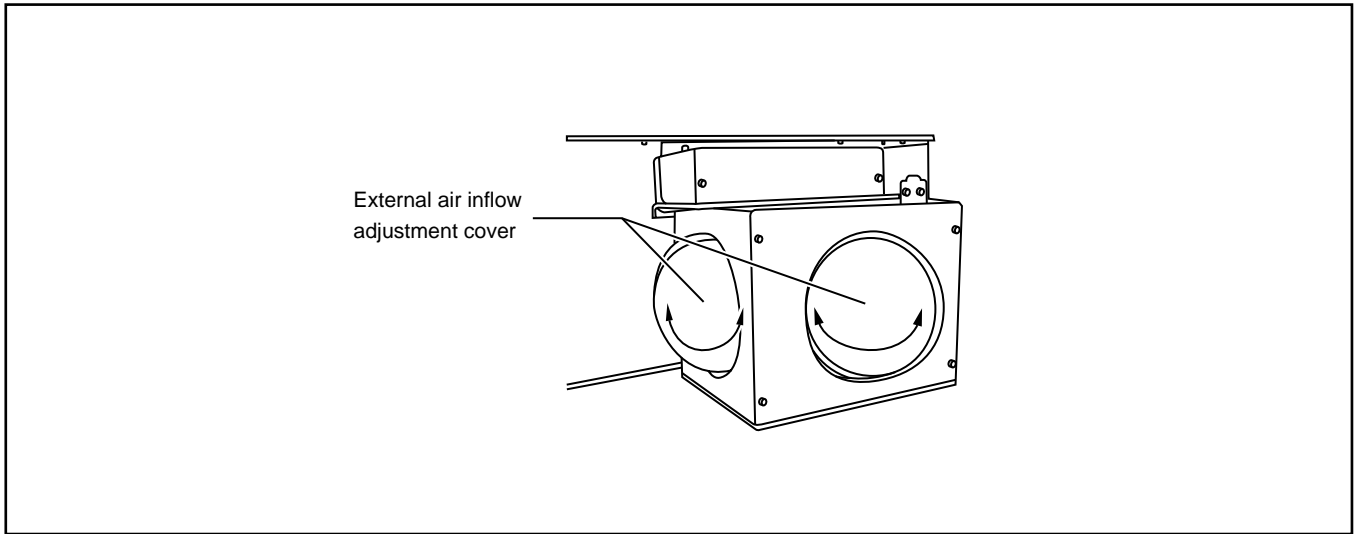

9-2. OA duct flange

OA duct flange PAC-KH110F makes outside fresh air ducting to the Indoor unit easier.
 Material: Galvanized steel plate, with insulation sheet adhered.

Item	① External air intake ducting	② Ducting flange	③ PTT screws (4x10)
Quantity	1	1	10 (two spares)
Shape			

Detailed installation information should be referred to its Installation Manual.

PLFY

PLFY-P-VCM-E2, PLY-P-VBM-E

1. SPECIFICATIONS	1 - 134
2. EXTERNAL DIMENSIONS	1 - 139
3. CENTER OF GRAVITY	1 - 141
4. ELECTRICAL WIRING DIAGRAMS	1 - 142
5. SOUND LEVELS	1 - 144
5-1. Sound levels	1 - 144
5-2. NC curves	1 - 144
6. TEMPERATURE/AIRFLOW DISTRIBUTIONS	1 - 146
6-1. Temperature distributions	1 - 146
6-2. Airflow distributions	1 - 148
7. OPTIONAL PARTS.....	1 - 149
7-1. Optional parts line up for the Indoor unit.....	1 - 149
7-2. Air outlet shutter plate	1 - 149
7-3. High efficiency filter element.....	1 - 150
7-4. Multi-function casement.....	1 - 150
7-5. i-see sensor corner panel	1 - 151
7-6. Automatic filter elevation panel.....	1 - 151
7-7. Wireless signal receiver.....	1 - 152
7-8. Space panel.....	1 - 152
7-9. Duct flange for fresh air intake.....	1 - 152

1. SPECIFICATIONS

YKB/YLM

Model			PLFY-P15VCM-E2	PLFY-P20VCM-E2	PLFY-P25VCM-E2				
Power source			1-phase 220-230-240V 50Hz						
Cooling capacity (Nominal)	*1	kW	1.7	2.2	2.8				
		kcal / h	1,450	1,900	2,400				
		BTU / h	5,800	7,500	9,600				
	*2	kcal / h	1,500	2,000	2,500				
		*4	Power input kW	0.04	0.05	0.05			
*4	Current input A	0.19	0.23	0.23					
Heating capacity (Nominal)	*3	kW	1.9	2.5	3.2				
		kcal / h	1,600	2,200	2,800				
		BTU / h	6,500	8,500	10,900				
	*4	Power input kW	0.04	0.05	0.05				
		Current input A	0.19	0.23	0.23				
External finish			Galvanized sheets with grey heat insulation						
External dimension H x W x D		mm	208 x 570 x 570	208 x 570 x 570	208 x 570 x 570				
		in.	8-1/4 x 22-1/2 x 22-1/2	8-1/4 x 22-1/2 x 22-1/2	8-1/4 x 22-1/2 x 22-1/2				
Net weight		kg (lbs)	15.5 (35)	15.5 (35)	15.5 (35)				
Decoration panel	Model		SLP-2AAW/SLP-2ALW	SLP-2AAW/SLP-2ALW	SLP-2AAW/SLP-2ALW				
	External finish		White Munsell (6.4Y 8.9/0.4)						
	Dimension		20 x 650 x 650	20 x 650 x 650	20 x 650 x 650				
	H x W x D		13/16 x 25-5/8 x 25-5/8	13/16 x 25-5/8 x 25-5/8	13/16 x 25-5/8 x 25-5/8				
	Net Weight		3 (7)	3 (7)	3 (7)				
	Cord heater		kW	0.015	0.015	0.015			
Heat exchanger			Cross fin (Aluminum fin and copper tube)						
FAN	Type x Quantity		Turbo fan x 1						
	External static press.		0Pa (0mmH ₂ O)	0Pa (0mmH ₂ O)	0Pa (0mmH ₂ O)				
	Motor type		1-phase induction motor						
	Motor output	kW	0.008	0.011	0.015				
	Driving mechanism		Direct-driven by motor						
	Airflow rate			(Low-Mid-High)	(Low-Mid-High)	(Low-Mid-High)			
m ³ / min			8-8.5-9	8-9-10	8-9-10				
L / s			133-142-150	133-150-167	133-150-167				
cfm			283-300-353	283-318-353	283-318-353				
Sound pressure level (measured in anechoic room)		*4	(Low-Mid-High) 28-30-31	(Low-Mid-High) 28-31-35	(Low-Mid-High) 29-31-37				
Insulation material			Polyethylene foam						
Air filter			PP honeycomb fabric (long life type)						
Protection device			Fuse						
Refrigerant control device			LEV						
Connectable outdoor unit			R410A CITY MULTI						
Diameter of refrigerant pipe	Liquid	mm (in.)	ø6.35 (ø1/4) Flare	ø6.35 (ø1/4) Flare	ø6.35 (ø1/4) Flare				
	Gas	mm (in.)	ø12.7 (ø1/2) Flare	ø12.7 (ø1/2) Flare	ø12.7 (ø1/2) Flare				
Field drain pipe size		mm (in.)	O.D. 32 (1-1/4) (PVC pipe VP-25 connectable)						
Drawing	External		IU-VRG01N654						
	Wiring		IU-VBH79B040						
	Refrigerant circle		-						
Standard attachment	Document		Installation manual, Instruction book						
	Accessory		Drain hose I.D. 32mm (1-1/4"), Wireless junction cable						
Remark	Optional parts								
	Decoration panel		SLP-2AAW/SLP-2ALW						
			*PLFY-P-VCM-E2 should use together with Decoration panel.						
Installation		Details on foundation work, duct work, insulation work, electrical wiring, power source switch, and other items shall be referred to the Installation Manual.							
Note : <table border="0" style="width:100%; border:none;"> <tr> <td style="width:33%; vertical-align:top;"> *1 Nominal cooling condition Indoor : 27°CDB/19°CWB (81°FDB/66°FWB) Outdoor : 35°CDB (95°FDB) Pipe length : 7.5 m (24-9/16 ft) Level difference : 0 m (0 ft) </td> <td style="width:33%; vertical-align:top;"> *2 Nominal cooling condition 27°CDB/19.5°CWB (81°FDB/67°FWB) 35°CDB (95°FDB) 5 m (16-3/8 ft) 0 m (0 ft) </td> <td style="width:33%; vertical-align:top;"> *3 Nominal heating condition 20°CDB (68°FDB) 7°CDB/6°CWB (45°FDB/43°FWB) 7.5 m (24-9/16 ft) 0 m (0 ft) </td> <td style="width:33%; vertical-align:top;"> Unit converter kcal/h = kW x 860 BTU/h = kW x 3,412 cfm = m³/min x 35.31 lbs = kg / 0.4536 </td> </tr> </table>						*1 Nominal cooling condition Indoor : 27°CDB/19°CWB (81°FDB/66°FWB) Outdoor : 35°CDB (95°FDB) Pipe length : 7.5 m (24-9/16 ft) Level difference : 0 m (0 ft)	*2 Nominal cooling condition 27°CDB/19.5°CWB (81°FDB/67°FWB) 35°CDB (95°FDB) 5 m (16-3/8 ft) 0 m (0 ft)	*3 Nominal heating condition 20°CDB (68°FDB) 7°CDB/6°CWB (45°FDB/43°FWB) 7.5 m (24-9/16 ft) 0 m (0 ft)	Unit converter kcal/h = kW x 860 BTU/h = kW x 3,412 cfm = m ³ /min x 35.31 lbs = kg / 0.4536
*1 Nominal cooling condition Indoor : 27°CDB/19°CWB (81°FDB/66°FWB) Outdoor : 35°CDB (95°FDB) Pipe length : 7.5 m (24-9/16 ft) Level difference : 0 m (0 ft)	*2 Nominal cooling condition 27°CDB/19.5°CWB (81°FDB/67°FWB) 35°CDB (95°FDB) 5 m (16-3/8 ft) 0 m (0 ft)	*3 Nominal heating condition 20°CDB (68°FDB) 7°CDB/6°CWB (45°FDB/43°FWB) 7.5 m (24-9/16 ft) 0 m (0 ft)	Unit converter kcal/h = kW x 860 BTU/h = kW x 3,412 cfm = m ³ /min x 35.31 lbs = kg / 0.4536						
* Nominal conditions *1, *3 are subject to JIS B8615-1. * Due to continuing improvement, above specification may be subject to change without notice. *4 The values are measured at the rated external static pressure. *Above specification data is subject to rounding variation.									

1. SPECIFICATIONS

YKB/YLM

Model			PLFY-P32VCM-E2	PLFY-P40VCM-E2																					
Power source			1-phase 220-230-240V 50Hz																						
Cooling capacity (Nominal)	*1	kW	3.6	4.5																					
	*1	kcal / h	3,100	3,900																					
	*1	BTU / h	12,300	15,400																					
	*2	kcal / h	3,150	4,000																					
	*4	Power input	kW	0.06	0.06																				
	*4	Current input	A	0.28	0.28																				
Heating capacity (Nominal)	*3	kW	4.0	5.0																					
	*3	kcal / h	3,400	4,300																					
	*3	BTU / h	13,600	17,100																					
	*4	Power input	kW	0.06	0.06																				
	*4	Current input	A	0.28	0.28																				
External finish			Galvanized sheets with grey heat insulation																						
External dimension H x W x D		mm	208 x 570 x 570	208 x 570 x 570																					
		in.	8-1/4 x 22-1/2 x 22-1/2	8-1/4 x 22-1/2 x 22-1/2																					
Net weight		kg (lbs)	17 (38)	17 (38)																					
Decoration panel	Model		SLP-2AAW/SLP-2ALW	SLP-2AAW/SLP-2ALW																					
	External finish		White Munsell (6.4Y 8.9/0.4)																						
	Dimension	mm	20 x 650 x 650	20 x 650 x 650																					
		in.	13/16 x 25-5/8 x 25-5/8	13/16 x 25-5/8 x 25-5/8																					
	Net Weight		kg (lbs)	3 (7)	3 (7)																				
	Cord heater		kW	0.015	0.015																				
Heat exchanger			Cross fin (Aluminum fin and copper tube)																						
FAN	Type x Quantity		Turbo fan x 1																						
	External static press.		0Pa (0mmH ₂ O)	0Pa (0mmH ₂ O)																					
	Motor type		1-phase induction motor																						
	Motor output	kW	0.02	0.02																					
	Driving mechanism		Direct-driven by motor																						
	Airflow rate		(Low-Mid-High)	(Low-Mid-High)																					
			m ³ / min	8-9-11	8-9-11																				
L / s			133-150-183	133-150-183																					
	cfm	283-318-388	283-318-388																						
Sound pressure level (measured in anechoic room)		*4	(Low-Mid-High) 29-33-38	(Low-Mid-High) 30-34-39																					
Insulation material			Polyethylene foam																						
Air filter			PP honeycomb fabric (long life type)																						
Protection device			Fuse																						
Refrigerant control device			LEV																						
Connectable outdoor unit			R410A CITY MULTI																						
Diameter of refrigerant pipe	Liquid	mm (in.)	ø6.35 (ø1/4) Flare	ø6.35 (ø1/4) Flare																					
	Gas	mm (in.)	ø12.7 (ø1/2) Flare	ø12.7 (ø1/2) Flare																					
Field drain pipe size		mm (in.)	O.D. 32 (1-1/4) (PVC pipe VP-25 connectable)																						
Drawing	External		IU-VRG01N654																						
	Wiring		IU-VBH79B040																						
	Refrigerant circle		-																						
Standard attachment	Document		Installation manual, Instruction book																						
	Accessory		Drain hose I.D. 32mm (1-1/4"), Wireless junction cable																						
Remark	Optional parts																								
	Decoration panel		SLP-2AAW/SLP-2ALW																						
			*PLFY-P-VCM-E2 should use together with Decoration panel.																						
Installation		Details on foundation work, duct work, insulation work, electrical wiring, power source switch, and other items shall be referred to the Installation Manual.																							
<p>Note :</p> <table border="0"> <tr> <td>*1 Nominal cooling condition</td> <td>*2 Nominal cooling condition</td> <td>*3 Nominal heating condition</td> <td>Unit converter</td> </tr> <tr> <td>Indoor : 27°CDB/19°CWB (81°FDB/66°FWB)</td> <td>27°CDB/19.5°CWB (81°FDB/67°FWB)</td> <td>20°CDB (68°FDB)</td> <td>kcal/h = kW x 860</td> </tr> <tr> <td>Outdoor : 35°CDB (95°FDB)</td> <td>35°CDB (95°FDB)</td> <td>7°CDB/6°CWB (45°FDB/43°FWB)</td> <td>BTU/h = kW x 3,412</td> </tr> <tr> <td>Pipe length : 7.5 m (24-9/16 ft)</td> <td>5 m (16-3/8 ft)</td> <td>7.5 m (24-9/16 ft)</td> <td>cfm = m³/min x 35.31</td> </tr> <tr> <td>Level difference : 0 m (0 ft)</td> <td>0 m (0 ft)</td> <td>0 m (0 ft)</td> <td>lbs = kg / 0.4536</td> </tr> </table> <p>* Nominal conditions *1, *3 are subject to JIS B8615-1. * Due to continuing improvement, above specification may be subject to change without notice. *4 The values are measured at the rated external static pressure.</p>						*1 Nominal cooling condition	*2 Nominal cooling condition	*3 Nominal heating condition	Unit converter	Indoor : 27°CDB/19°CWB (81°FDB/66°FWB)	27°CDB/19.5°CWB (81°FDB/67°FWB)	20°CDB (68°FDB)	kcal/h = kW x 860	Outdoor : 35°CDB (95°FDB)	35°CDB (95°FDB)	7°CDB/6°CWB (45°FDB/43°FWB)	BTU/h = kW x 3,412	Pipe length : 7.5 m (24-9/16 ft)	5 m (16-3/8 ft)	7.5 m (24-9/16 ft)	cfm = m ³ /min x 35.31	Level difference : 0 m (0 ft)	0 m (0 ft)	0 m (0 ft)	lbs = kg / 0.4536
*1 Nominal cooling condition	*2 Nominal cooling condition	*3 Nominal heating condition	Unit converter																						
Indoor : 27°CDB/19°CWB (81°FDB/66°FWB)	27°CDB/19.5°CWB (81°FDB/67°FWB)	20°CDB (68°FDB)	kcal/h = kW x 860																						
Outdoor : 35°CDB (95°FDB)	35°CDB (95°FDB)	7°CDB/6°CWB (45°FDB/43°FWB)	BTU/h = kW x 3,412																						
Pipe length : 7.5 m (24-9/16 ft)	5 m (16-3/8 ft)	7.5 m (24-9/16 ft)	cfm = m ³ /min x 35.31																						
Level difference : 0 m (0 ft)	0 m (0 ft)	0 m (0 ft)	lbs = kg / 0.4536																						
<p>*Above specification data is subject to rounding variation.</p>																									

PLFY-VCM/VBM

1. SPECIFICATIONS

YKB/YLM

Model			PLFY-P20VBM-E	PLFY-P25VBM-E	PLFY-P32VBM-E	PLFY-P40VBM-E	
Power source			1-phase 220-240V 50Hz, 1-phase 220V 60Hz				
Cooling capacity (Nominal)	*1	kW	2.2	2.8	3.6	4.5	
	*1	kcal / h	1,900	2,400	3,100	3,900	
	*1	BTU / h	7,500	9,600	12,300	15,400	
	*2	kcal / h	2,000	2,500	3,150	4,000	
	*4	Power input	kW	0.03	0.03	0.03	0.04
*4	Current input	A	0.26	0.26	0.27	0.29	
Heating capacity (Nominal)	*3	kW	2.5	3.2	4.0	5.0	
	*3	kcal / h	2,200	2,800	3,400	4,300	
	*3	BTU / h	8,500	10,900	13,600	17,100	
	*4	Power input	kW	0.02	0.02	0.02	0.03
	*4	Current input	A	0.19	0.19	0.20	0.22
External finish			Galvanized steel sheet				
External dimension H x W x D		mm	258 x 840 x 840				
		in.	10-3/16 x 33-1/8 x 33-1/8				
Net weight		kg (lbs)	22 (49)	22 (49)	22 (49)	22 (49)	
Decoration panel	Model		PLP-6BA	PLP-6BA	PLP-6BA	PLP-6BA	
	External finish		MUNSELL (6.4Y 8.9/0.4)				
	Dimension		35 x 950 x 950				
	H x W x D		1-3/8 x 37-7/16 x 37-7/16				
	Net weight		6 (13)				
Heat exchanger			Cross fin (Aluminum fin and copper tube)				
FAN	Type x Quantity		Turbo fan x 1	Turbo fan x 1	Turbo fan x 1	Turbo fan x 1	
	External static press.	Pa	0	0	0	0	
		mmH ₂ O	0	0	0	0	
	Motor type		DC motor				
	Motor output	kW	0.050	0.050	0.050	0.050	
	Driving mechanism		Direct-drive				
	Airflow rate			(Low-Mid2-Mid1-High)	(Low-Mid2-Mid1-High)	(Low-Mid2-Mid1-High)	(Low-Mid2-Mid1-High)
		m ³ / min		11 - 12 - 13 - 14	11 - 12 - 13 - 14	11 - 12 - 13 - 14	12 - 13 - 14 - 16
		L / s		183 - 200 - 217 - 233	183 - 200 - 217 - 233	183 - 200 - 217 - 233	200 - 217 - 233 - 267
		cfm		388 - 424 - 459 - 494	388 - 424 - 459 - 494	388 - 424 - 459 - 494	424 - 459 - 494 - 565
Sound pressure level (measured in anechoic room)		*4	(Low-Mid2-Mid1-High)	(Low-Mid2-Mid1-High)	(Low-Mid2-Mid1-High)	(Low-Mid2-Mid1-High)	
			27 - 28 - 29 - 31	27 - 28 - 29 - 31	27 - 28 - 29 - 31	27 - 28 - 30 - 31	
Insulation material			PS				
Air filter			PP honeycomb				
Protection device			Fuse				
Refrigerant control device			LEV				
Connectable outdoor unit			R410A CITY MULTI				
Diameter of refrigerant pipe	Liquid (R410A)	mm (in.)	ø6.35 (ø1/4) Flare	ø6.35 (ø1/4) Flare	ø6.35 (ø1/4) Flare	ø6.35 (ø1/4) Flare	
	Gas (R410A)	mm (in.)	ø12.7 (ø1/2) Flare	ø12.7 (ø1/2) Flare	ø12.7 (ø1/2) Flare	ø12.7 (ø1/2) Flare	
Field drain pipe size		mm (in.)	O.D. 32 (1-1/4)				
Standard attachment	Document	Installation Manual, Instruction Book					
	Accessory						
Remark	Optional parts						
	Decoration panel **1		PLP-6BA	PLP-6BA	PLP-6BA	PLP-6BA	
	Air outlet shutter plate		PAC-SH51SP-E	PAC-SH51SP-E	PAC-SH51SP-E	PAC-SH51SP-E	
	High efficiency filter element **2		PAC-SH59KF-E	PAC-SH59KF-E	PAC-SH59KF-E	PAC-SH59KF-E	
	Multi-function casement		PAC-SH53TM-E	PAC-SH53TM-E	PAC-SH53TM-E	PAC-SH53TM-E	
			**1.PLFY-P-VBM-E should use together with PLP-6BA. **2.PAC-SH53TM-E is necessary to use with filter PAC-SH59KF-E.				
Installation		Details on foundation work, duct work, insulation work, electrical wiring, power source switch, and other items shall be referred to the Installation Manual.					
Note :			*1 Nominal cooling conditions	*2 Nominal cooling conditions	*3 Nominal heating conditions	Unit converter	
Indoor :			27°CDB/19°CWB (81°FDB/66°FWB)	27°CDB/19.5°CWB (81°FDB/67°FWB)	20°CDB (68°FDB)	kcal/h = kW x 860	
Outdoor :			35°CDB (95°FDB)	35°CDB (95°FDB)	7°CDB/6°CWB (45°FDB/43°FWB)	BTU/h = kW x 3,412	
Pipe length :			7.5 m (24-9/16 ft)	5 m (16-3/8 ft)	7.5 m (24-9/16 ft)	cfm = m ³ /min x 35.31	
Level difference :			0 m (0 ft)	0 m (0 ft)	0 m (0 ft)	lbs = kg / 0.4536	
* Nominal conditions *1, *3 are subject to JIS B8615-1.						*Above specification data is subject to rounding variation.	
* Due to continuing improvement, above specification may be subject to change without notice.							
*4 The values are measured at the rated external static pressure.							

1. SPECIFICATIONS

YKB/YLM

Model			PLFY-P50VBM-E	PLFY-P63VBM-E	PLFY-P80VBM-E	PLFY-P100VBM-E	
Power source			1-phase 220-240V 50Hz, 1-phase 220V 60Hz				
Cooling capacity (Nominal)	*1	kW	5.6	7.1	9.0	11.2	
		kcal / h	4,800	6,100	7,700	9,600	
	*2	BTU / h	19,100	24,200	30,700	38,200	
		kcal / h	5,000	6,300	8,000	10,000	
	*4	Power input	0.04	0.05	0.07	0.15	
*4	Current input	A	0.29	0.36	0.51	1.00	
Heating capacity (Nominal)	*3	kW	6.3	8.0	10.0	12.5	
		kcal / h	5,400	6,900	8,600	10,800	
	*3	BTU / h	21,500	27,300	34,100	42,700	
		Power input	0.03	0.04	0.06	0.14	
	*4	Current input	A	0.22	0.29	0.43	0.94
External finish			Galvanized steel sheet				
External dimension H x W x D		mm	258 x 840 x 840	258 x 840 x 840	258 x 840 x 840	298 x 840 x 840	
		in.	10-3/16 x 33-1/8 x 33-1/8	10-3/16 x 33-1/8 x 33-1/8	10-3/16 x 33-1/8 x 33-1/8	11-3/4 x 33-1/8 x 33-1/8	
Net weight		kg (lbs)	22 (49)	23 (51)	23(51)	27(60)	
Decoration panel		Model	PLP-6BA	PLP-6BA	PLP-6BA	PLP-6BA	
		External finish	MUNSELL (6.4Y 8.9/0.4)				
		Dimension	35 x 950 x 950				
		H x W x D	1-3/8 x 37-7/16 x 37-7/16				
		Net weight	6 (13)				
Heat exchanger			Cross fin (Aluminum fin and copper tube)				
FAN		Type x Quantity	Turbo fan x 1	Turbo fan x 1	Turbo fan x 1	Turbo fan x 1	
		External static press.	Pa	0	0	0	
			mmH ₂ O	0	0	0	
		Motor type	DC motor				
		Motor output	kW	0.050	0.050	0.050	
		Driving mechanism	Direct-drive				
		Airflow rate	(Low-Mid2-Mid1-High)	(Low-Mid2-Mid1-High)	(Low-Mid2-Mid1-High)	(Low-Mid2-Mid1-High)	
			m ³ / min	12 - 13 - 14 - 16	14 - 15 - 16 - 18	16 - 18 - 20 - 22	21 - 24 - 27 - 29
			L / s	200 - 217 - 233 - 267	233 - 250 - 267 - 300	267 - 300 - 333 - 367	350 - 400 - 450 - 483
			cfm	424 - 459 - 494 - 565	494 - 530 - 565 - 636	565 - 636 - 706 - 777	742 - 848 - 953 - 1024
Sound pressure level (measured in anechoic room)		*4	dB <A>	(Low-Mid2-Mid1-High) 27 - 28 - 30 - 31	(Low-Mid2-Mid1-High) 28 - 29 - 30 - 32	(Low-Mid2-Mid1-High) 30 - 32 - 35 - 37	(Low-Mid2-Mid1-High) 34 - 37 - 39 - 41
Insulation material			PS				
Air filter			PP honeycomb				
Protection device			Fuse				
Refrigerant control device			LEV				
Connectable outdoor unit			R410A CITY MULTI				
Diameter of refrigerant pipe	Liquid (R410A)	mm (in.)	ø6.35 (ø1/4) Flare	ø9.52 (ø3/8) Flare	ø9.52 (ø3/8) Flare	ø9.52 (ø3/8) Flare	
	Gas (R410A)	mm (in.)	ø12.7 (ø1/2) Flare	ø15.88 (ø5/8) Flare	ø15.88 (ø5/8) Flare	ø15.88 (ø5/8) Flare	
Field drain pipe size		mm (in.)	O.D. 32 (1-1/4)				
Standard attachment		Document Accessory	Installation Manual, Instruction Book				
Remark		Optional parts					
		Decoration panel **1	PLP-6BA	PLP-6BA	PLP-6BA	PLP-6BA	
		Air outlet shutter plate	PAC-SH51SP-E	PAC-SH51SP-E	PAC-SH51SP-E	PAC-SH51SP-E	
		High efficiency filter element **2	PAC-SH59KF-E	PAC-SH59KF-E	PAC-SH59KF-E	PAC-SH59KF-E	
		Multi-function casement	PAC-SH53TM-E	PAC-SH53TM-E	PAC-SH53TM-E	PAC-SH53TM-E	
		**1.PLFY-P-VBM-E should use together with PLP-6BA. **2.PAC-SH53TM-E is necessary to use with filter PAC-SH59KF-E.					
Installation		Details on foundation work, duct work, insulation work, electrical wiring, power source switch, and other items shall be referred to the Installation Manual.					
Note :		*1 Nominal cooling conditions	*2 Nominal cooling conditions	*3 Nominal heating conditions	Unit converter		
		Indoor : 27°CDB/19°CWB (81°FDB/66°FWB)	27°CDB/19.5°CWB (81°FDB/67°FWB)	20°CDB (68°FDB)	kcal/h = kW x 860		
		Outdoor : 35°CDB (95°FDB)	35°CDB (95°FDB)	7°CDB/6°CWB (45°FDB/43°FWB)	BTU/h = kW x 3,412		
		Pipe length : 7.5 m (24-9/16 ft)	5 m (16-3/8 ft)	7.5 m (24-9/16 ft)	cfm = m ³ /min x 35.31		
		Level difference : 0 m (0 ft)	0 m (0 ft)	0 m (0 ft)	lbs = kg / 0.4536		
		* Nominal conditions *1, *3 are subject to JIS B8615-1.					
		* Due to continuing improvement, above specification may be subject to change without notice.					
		*4 The values are measured at the rated external static pressure.					
		*Above specification data is subject to rounding variation.					

PLFY-VCM/VBM

1. SPECIFICATIONS

YKB/YLM

Model		PLFY-P125VBM-E		
Power source		1-phase 220-240V 50Hz, 1-phase 220V 60Hz		
Cooling capacity (Nominal)	*1	kW	14.0	
	*1	kcal / h	12,000	
	*1	BTU / h	47,800	
	*2	kcal / h	12,500	
	*4	Power input	kW	0.16
*4	Current input	A	1.07	
Heating capacity (Nominal)	*3	kW	16.0	
	*3	kcal / h	13,800	
	*3	BTU / h	54,600	
	*4	Power input	kW	0.15
	*4	Current input	A	1.00
External finish		Galvanized steel sheet		
External dimension H x W x D		mm	298 x 840 x 840	
		in.	11-3/4 x 33-1/8 x 33-1/8	
Net weight		kg (lbs)	27(60)	
Decoration panel	Model		PLP-6BA	
	External finish		MUNSELL (6.4Y 8.9/0.4)	
	Dimension H x W x D	mm	35 x 950 x 950	
		in.	1-3/8 x 37-7/16 x 37-7/16	
	Net weight	kg (lbs)	6(13)	
Heat exchanger		Cross fin (Aluminum fin and copper tube)		
FAN	Type x Quantity		Turbo fan x 1	
	External static press.	Pa	0	
		mmH ₂ O	0	
	Motor type		DC motor	
	Motor output	kW	0.120	
	Driving mechanism		Direct-drive	
	Airflow rate	(Low-Mid2-Mid1-High)		
		m ³ / min	22 - 25 - 28 - 30	
L / s		367 - 417 - 467 - 500		
cfm		777 - 883 - 989 - 1059		
Sound pressure level (measured in anechoic room)	*4	dB <A>	(Low-Mid2-Mid1-High) 35 - 38 - 41 - 43	
Insulation material		PS		
Air filter		PP honeycomb		
Protection device		Fuse		
Refrigerant control device		LEV		
Connectable outdoor unit		R410A CITY MULTI		
Diameter of refrigerant pipe	Liquid (R410A)	mm (in.)	ø9.52 (ø3/8) Flare	
	Gas (R410A)	mm (in.)	ø15.88 (ø5/8) Flare	
Field drain pipe size		mm (in.)	O.D. 32 (1-1/4)	
Standard attachment	Document	Installation Manual, Instruction Book		
	Accessory			
Remark	Optional parts			
	Decoration panel **1	PLP-6BA		
	Air outlet shutter plate	PAC-SH51SP-E		
	High efficiency filter element **2	PAC-SH59KF-E		
	Multi-function casement	PAC-SH53TM-E		
		**1.PLFY-P-VBM-E should use together with PLP-6BA. **2.PAC-SH53TM-E is necessary to use with filter PAC-SH59KF-E.		
Installation		Details on foundation work, duct work, insulation work, electrical wiring, power source switch, and other items shall be referred to the Installation Manual.		
Note :	*1 Nominal cooling conditions		*2 Nominal cooling conditions	
	Indoor : 27°CDB/19°CWB (81°FDB/66°FWB)		27°CDB/19.5°CWB (81°FDB/67°FWB)	
	Outdoor : 35°CDB (95°FDB)		35°CDB (95°FDB)	
	Pipe length : 7.5 m (24-9/16 ft)		5 m (16-3/8 ft)	
	Level difference : 0 m (0 ft)		0 m (0 ft)	
		*3 Nominal heating conditions	Unit converter	
		20°CDB (68°FDB)	kcal/h = kW x 860	
		7°CDB/6°CWB (45°FDB/43°FWB)	BTU/h = kW x 3,412	
		7.5 m (24-9/16 ft)	cfm = m ³ /min x 35.31	
		0 m (0 ft)	lbs = kg / 0.4536	
			*Above specification data is subject to rounding variation.	
* Nominal conditions *1, *3 are subject to JIS B8615-1.				
* Due to continuing improvement, above specification may be subject to change without notice.				
*4 The values are measured at the rated external static pressure.				

PLFY-YCM/VBM

PLFY-P15, 20, 25, 32, 40VCM-E2

Unit : mm

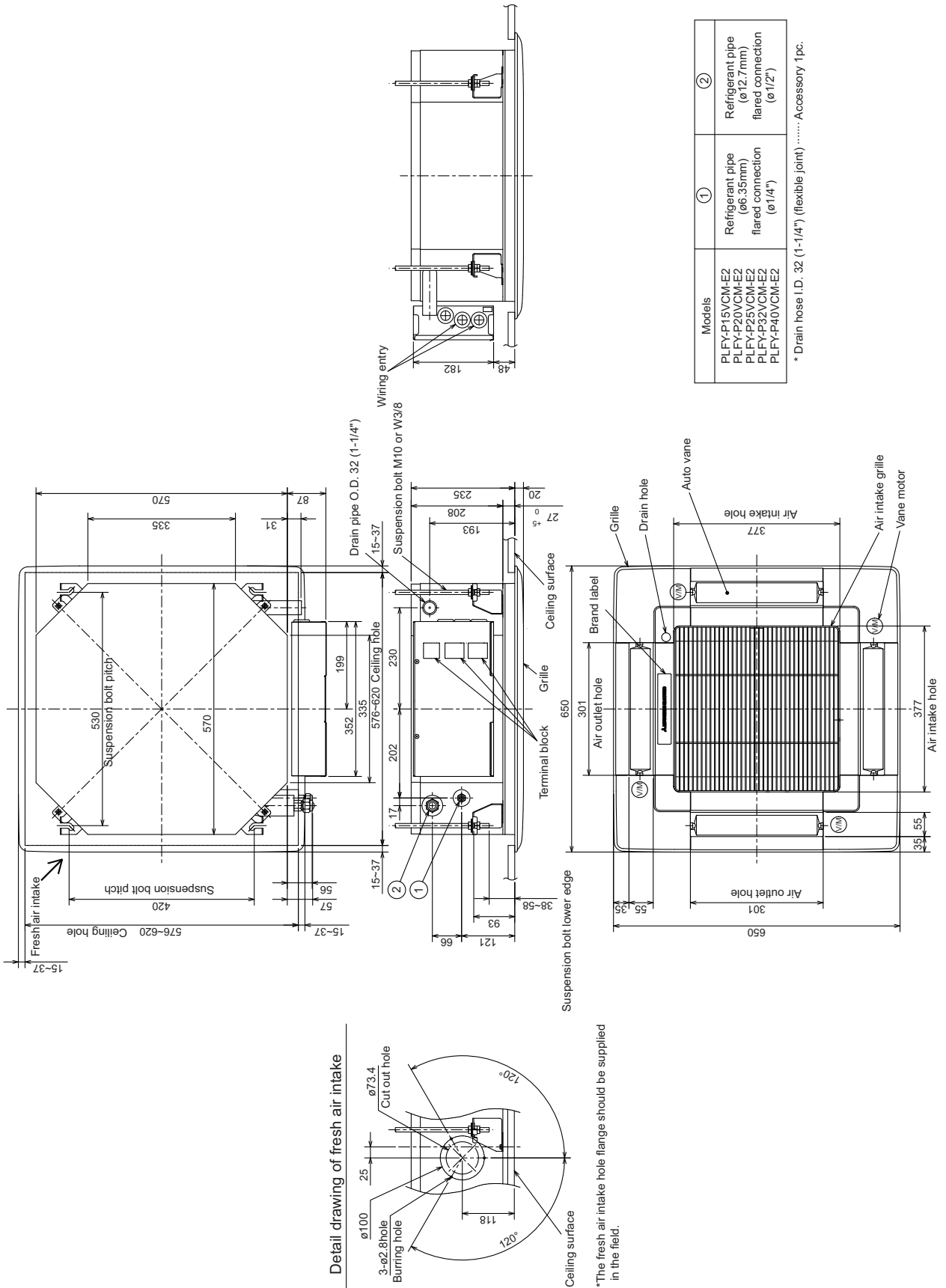

PLFY-VCM/VBM

PLFY-P20, 25, 32, 40, 50, 63, 80, 100, 125VBM-E

Unit: mm

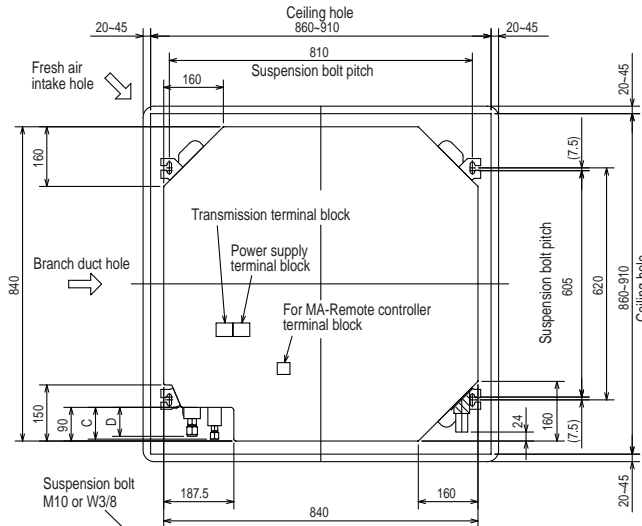

Detail connecting of Branch duct (Both aspects)

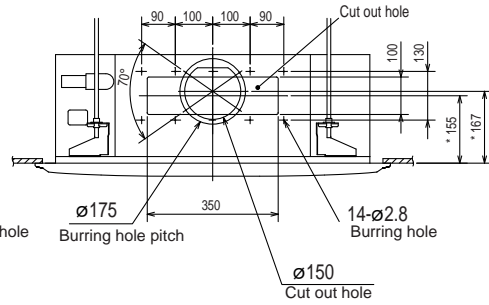

Detail drawing of fresh air intake hole

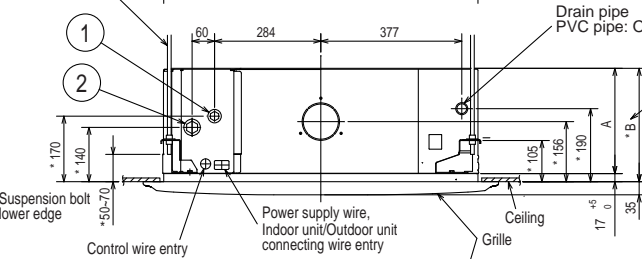
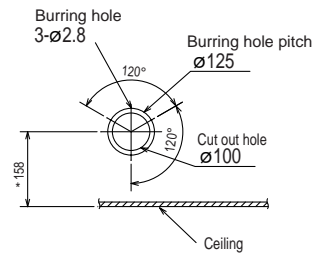

Drain pipe PVC pipe: O.D. 32 (1-1/4") (Connected the attached flexible pipe or socket. I.D. 32 (1-1/4"))
 Keep approximately 10 to 15 mm space between unit ceiling and ceiling slab.

In case of standard grille : PLP-6BA



In case of Auto-Grille : PLP-6BAJ

In case of wireless remote controller : PLP-6BALM

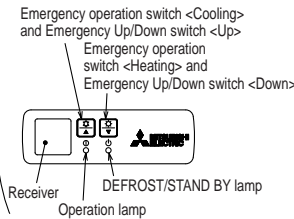

Auto-Grille Air intake grille Up/down distance

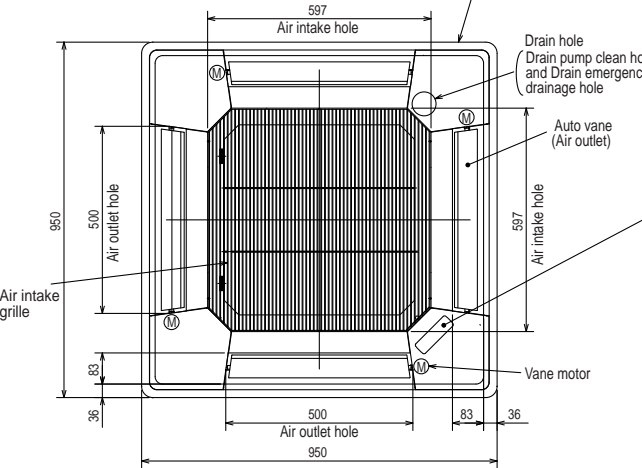
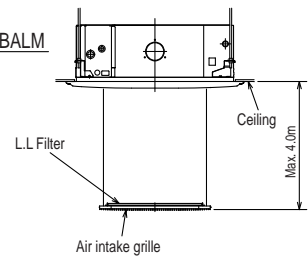

- Note 1. Please choose the Grille from a standard grille, Auto-Grille.
 2. As for drain pipe, please use VP-25 (O.D. ø32 PVC TUBE). Drain pump inclusion. Raise is max 850mm from the ceiling.
 3. As for suspension bolt, please use M10 or W3/8. (Procured at local site)
 4. Electrical box may be removed for the service purpose. Make sure to slack the electrical wire little bit for control/power wires connection.
 5. The height of the indoor unit is able to be adjusted with the grille attached.
 6. For the installation of the optional high efficiency filter or optional multi-functional casement.
 1) Requires E or more space between transom and ceiling for the installation.
 2) Add 135 mm to the dimensions * marked on the figure.
 3) The optional high efficiency filter becomes optional multi-functional casement and concomitant use.
 7. When installing the branch ducts, be sure to insulate adequately. Otherwise condensation and dripping may occur. (It becomes the cause of dew drops/Wear dew.)
 8. As for necessary installation/service space, please refer to the left at figure.

Accessory ... Drain socket (I.D. 32 (1-1/4"))

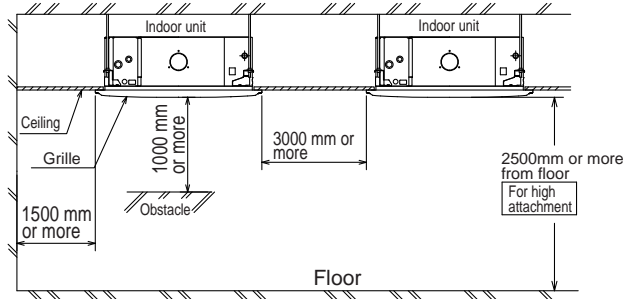

Models	①	②	A	B	C	D	E
PLFY-P20,25,32,40VBM-E	Refrigerant pipe--ø 6.35 Flared connection--1/4F	Refrigerant pipe --ø12.7 Flared connection--1/2F			80	74	
PLFY-P50VBM-E	Refrigerant pipe ø6.35 /ø9.52 Flared connection 1/4F / 3/8F (compatible)	Refrigerant pipe ø12.7 Flared connection 1/2F	241	258	87	78	400
PLFY-P63,80VBM-E	Refrigerant pipe--3/8F Flared connection--ø9.52	Refrigerant pipe--ø15.88 Flared connection--5/8F				77	
PLFY-P100,125VBM-E		Refrigerant pipe ø15.88 Flared connection 5/8F	281	298	85	81	440

PLFY-P15, 20, 25, 32, 40VCM-E2

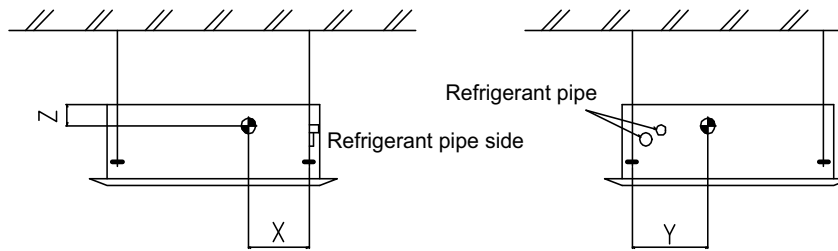

(mm)[in]

Model name	X	Y	Z
PLFY-P15VCM-E2	150 [5-29/32]	260 [10-1/4]	105 [4-5/32]
PLFY-P20VCM-E2	150 [5-29/32]	260 [10-1/4]	105 [4-5/32]
PLFY-P25VCM-E2	150 [5-29/32]	260 [10-1/4]	105 [4-5/32]
PLFY-P32VCM-E2	150 [5-29/32]	260 [10-1/4]	105 [4-5/32]
PLFY-P40VCM-E2	150 [5-29/32]	260 [10-1/4]	105 [4-5/32]

PLFY-P20, 25, 32, 40, 50, 63, 80, 100, 125VBM-E

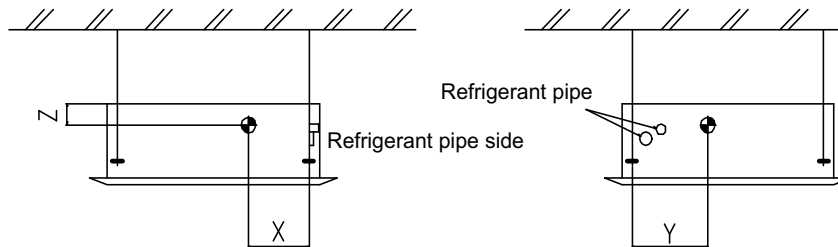

(mm)[in]

Model name	X	Y	Z
PLFY-P20VBM-E	280 [11-1/32]	400 [15-3/4]	105 [4-5/32]
PLFY-P25VBM-E	280 [11-1/32]	400 [15-3/4]	105 [4-5/32]
PLFY-P32VBM-E	280 [11-1/32]	400 [15-3/4]	105 [4-5/32]
PLFY-P40VBM-E	280 [11-1/32]	400 [15-3/4]	105 [4-5/32]
PLFY-P50VBM-E	280 [11-1/32]	400 [15-3/4]	105 [4-5/32]
PLFY-P63VBM-E	280 [11-1/32]	400 [15-3/4]	105 [4-5/32]
PLFY-P80VBM-E	280 [11-1/32]	400 [15-3/4]	105 [4-5/32]
PLFY-P100VBM-E	280 [11-1/32]	400 [15-3/4]	125 [4-15/16]
PLFY-P125VBM-E	280 [11-1/32]	400 [15-3/4]	125 [4-15/16]

PLFY-P15, 20, 25, 32, 40VCM-E2

[LEGEND]

SYMBOL	NAME	SYMBOL	NAME
I.B	INDOOR CONTROLLER BOARD	DS	DRAIN SENSOR
CN32	CONNECTOR	H2	DEW PREVENTION HEATER
CN41		LEV	LINEAR EXPANSION VALVE
CN51		MF	FAN MOTOR (WITH THERMAL FUSE)
CN52		MV	VANE MOTOR
CN100	IT TERMINAL	TB2	TERMINAL POWER SUPPLY
FUSE	FUSE (T6.3AL 250V)	TB5	BLOCK TRANSMISSION
SW1	SWITCH	TB15	MA-REMOTE CONTROLLER
SW2		TH21	THERMISTOR ROOM TEMP. DETECTION (0°C/15kΩ, 25°C/5.4kΩ)
SW3		TH22	PIPE TEMP. DETECTION / LIQUID (0°C/15kΩ, 25°C/5.4kΩ)
SW4		TH23	PIPE TEMP. DETECTION / GAS (0°C/15kΩ, 25°C/5.4kΩ)
SW11		P.B	INDOOR POWER BOARD
SW12			
SW14			
SWE			
X1	AUX.		
X4	RELAY		
X5			
X6			
X7			
C1	CAPACITOR (FAN MOTOR)		
DP	DRAIN PUMP		
		OPTION PART	
		W.B	PCB FOR WIRELESS REMOTE CONTROLLER
		BZ	BUZZER
		LED1	LED(OPERATION INDICATOR:GREEN)
		LED2	LED(PREPARATION FOR HEATING : ORANGE)
		RU	RECEIVING UNIT
		SW1	EMERGENCY OPERATION(HEAT)
		SW2	EMERGENCY OPERATION(COOL)

The black square(■)indicates a switch position. <*1>

MODELS	SW2
P15	ON OFF ■■■■ 123456
P20	ON OFF ■■■■ 123456
P25	ON OFF ■■■■ 123456
P32	ON OFF ■■■■ 123456
P40	ON OFF ■■■■ 123456

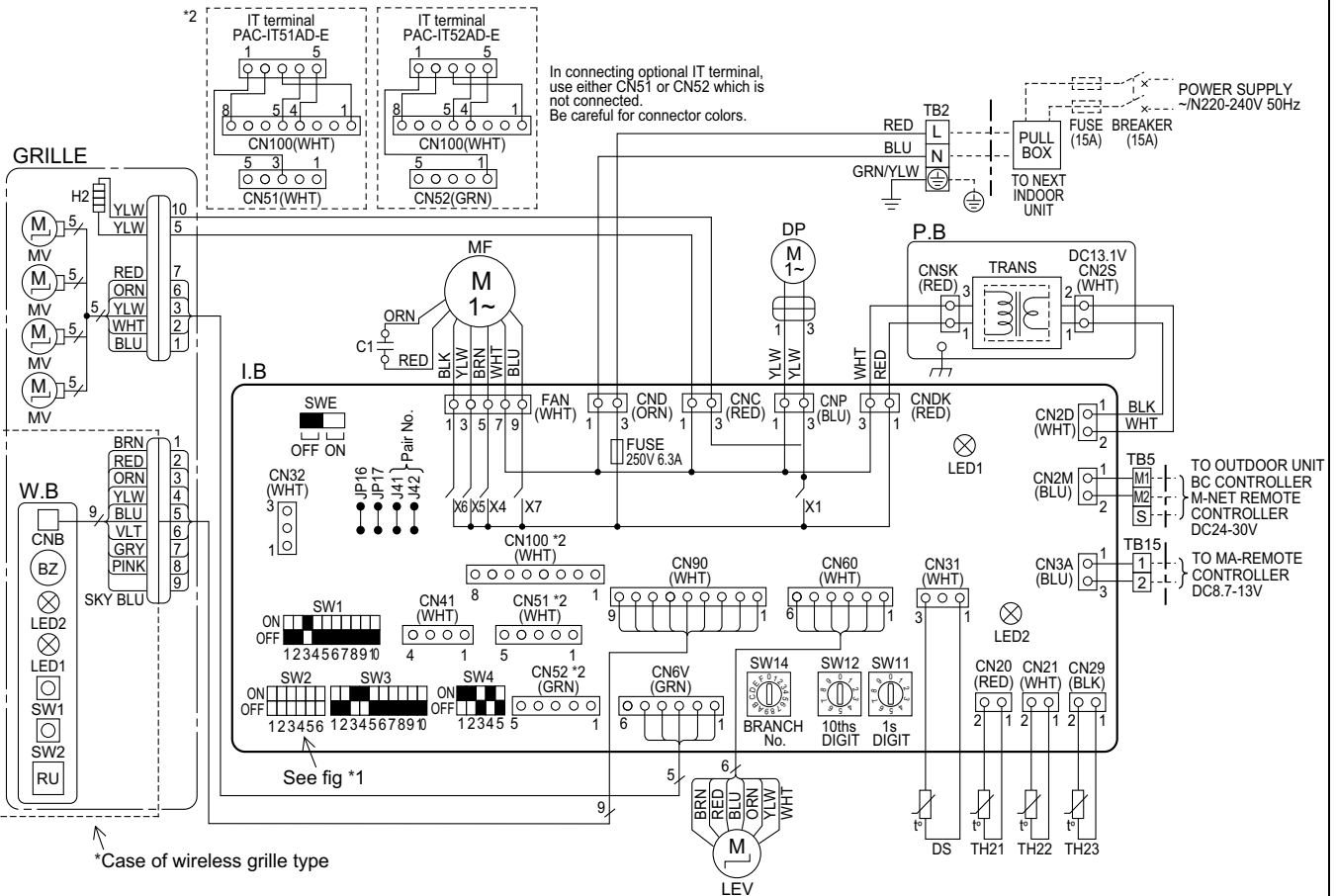

- Notes:
1. At servicing for outdoor unit, always follow the wiring diagram of outdoor unit.
 2. In case of using MA-Remote controller, please connect to TB15. (Remote controller wire is non-polar.)
 3. In case of using M-NET, please connect to TB5. (Transmission line is non-polar.)
 4. Symbol [S] of TB5 is the shield wire connection.
 5. Symbols used in wiring diagram above are, □□□: terminal block, ○○○: connector.
 6. The setting of the SW2 dip switches differs in the capacity. For the detail, refer to the fig.*1.

LED on indoor board for service

Mark	Meaning	Function
LED1	Main power supply	Main power supply (Indoor unit) Power on → lamp is lit
LED2	Power supply for MA-Remote controller	Power supply for MA-Remote controller on → lamp is lit

PLFY-P20, 25, 32, 40, 50, 63, 80, 100, 125VBM-E

[LEGEND]

SYMBOL	NAME	SYMBOL	NAME	SYMBOL	NAME
I. B	INDOOR CONTROLLER BOARD	DP	DRAIN-UP MACHINE	A. B	ADDRESS BOARD
CN27	CONNECTOR DAMPER	FS	DRAIN FLOAT SWITCH	SWA	SWITCH CEILING HEIGHT SELECTOR
CN32	REMOTE SWITCH	LEV	LINEAR EXPANSION VALVE	SWB	DISCHARGE OUTLET NUMBER SELECTOR
CN51	CENTRALLY CONTROL	MF	FAN MOTOR	SWC	OPTION SELECTOR
CN52	REMOTE INDICATION	MV	VANE MOTOR	SW1	MODE SELECTION
CH100	IT TERMINAL	TB2	TERMINAL POWER SUPPLY	SW11	ADDRESS SETTING 1s DIGIT
FUSE	FUSE(T6.3AL250V)	TB5	BLOCK TRANSMISSION	SW12	ADDRESS SETTING 10ths DIGIT
LED1	POWER SUPPLY(L. B)	TB15	MA-REMOTE CONTROLLER	SW14	CONNECTION NO.
LED2	POWER SUPPLY(L. B)	TH21	THERMISTOR ROOM TEMP. DETECTION (0°C / 15kΩ, 25°C / 5.4kΩ)	OPTION PART	
SW2	SWITCH CAPACITY CODE			W.B	PCB FOR WIRELESS REMOTE CONTROLLER
SW3	MODE SELECTION			BZ	BUZZER
SW4	MODEL SELECTION			LED1	LED(OPERATION INDICATION : GREEN)
SWE	DRAIN-UP MACHINE(TEST MODE)			LED2	LED(PREPARATION FOR HEATING : ORANGE)
X1	AUX. RELAY DRAIN WATER LIFTING-UP MACH.			RU	RECEIVING UNIT
				SW1	EMERGENCY OPERATION(HEAT / DOWN)
				SW2	EMERGENCY OPERATION(COOL / UP)

The black square (■) indicates a switch position.<*1>

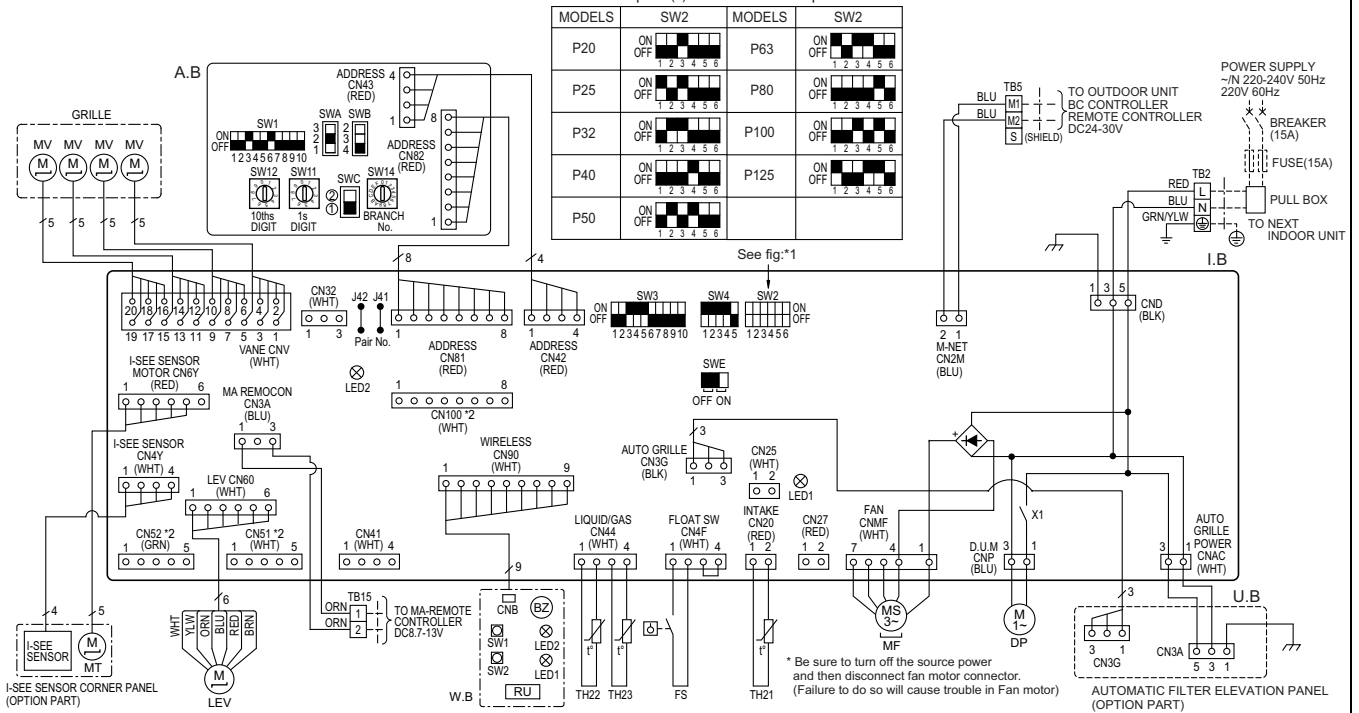

NOTES:

- At servicing for outdoor unit, always follow the wiring diagram of outdoor unit.
- In case of using MA-Remote controller, please connect to TB15. (Remote controller wire is non-polar.)
- In case of using M-NET, please connect to TB5. (Transmission line is non-polar.)
- Symbol [S] of TB5 is the shield wire connection.
- Symbols used in wiring diagram above are, [] : terminal block, [] : connector.
- The setting of the SW2 dip switches differs in the capacity. For the detail, refer to fig<*1>.

LED on indoor board for service

Mark	Meaning	Function
LED1	Main power supply	Main Power supply(Indoor unit:220-240V) power on → lamp is lit
LED2	Power supply for MA-Remote controller	Power supply for MA-Remote controller on → lamp is lit

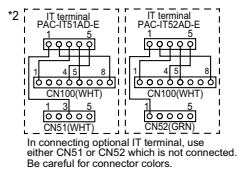

PLFY-VCM/VBM

5-1. Sound levels

PLFY-P-VCM-E2, VBM-E

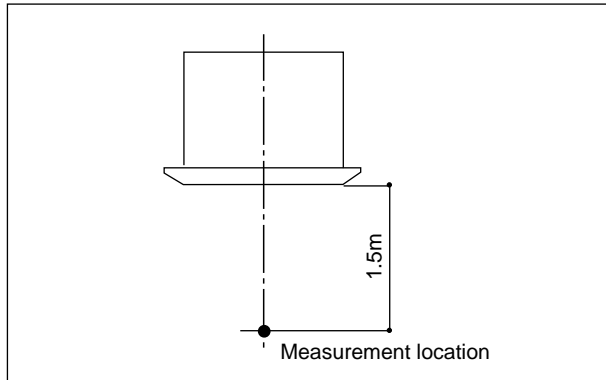

* Measured in anechoic room.

Sound level at anechoic room : Low-Mid-High

	Sound level dB (A)
PLFY-P15VCM-E2	28-30-31
PLFY-P20VCM-E2	28-31-35
PLFY-P25VCM-E2	28-31-37
PLFY-P32VCM-E2	29-33-38
PLFY-P40VCM-E2	30-34-39

Sound level at anechoic room : Low-Mid2-Mid1-High

	Sound level dB (A)
PLFY-P20VBM-E	27-28-29-31
PLFY-P25VBM-E	
PLFY-P32VBM-E	
PLFY-P40VBM-E	27-28-30-31
PLFY-P50VBM-E	
PLFY-P63VBM-E	
PLFY-P80VBM-E	28-29-30-32
PLFY-P100VBM-E	30-32-35-37
PLFY-P125VBM-E	34-37-39-41
PLFY-P125VBM-E	35-38-41-43

5-2. NC curves

PLFY-VCM/VBM

PLFY-P15VCM-E2

External Static Pressure: 0Pa
Power Source: 220,230,240V, 50Hz

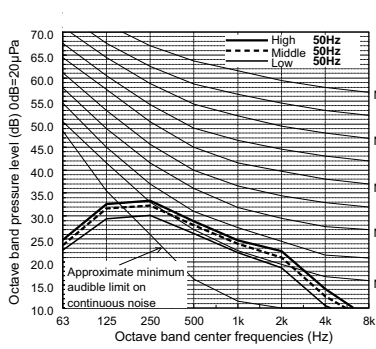

PLFY-P20VCM-E2

External static pressure : 0Pa
Power source : 220,230,240V, 50Hz

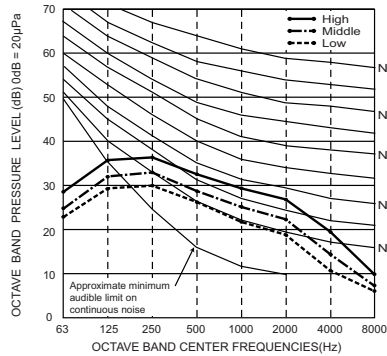

PLFY-P25VCM-E2

External static pressure : 0Pa
Power source : 220,230,240V, 50Hz

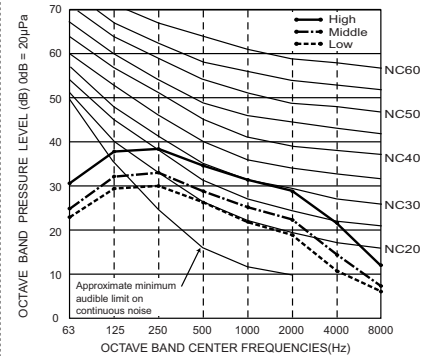

PLFY-P32VCM-E2

External static pressure : 0Pa
Power source : 220,230,240V, 50Hz

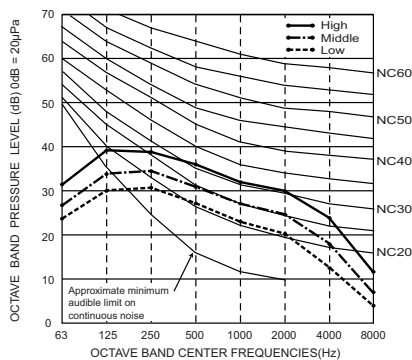

PLFY-P40VCM-E2

External static pressure : 0Pa
Power source : 220,230,240V, 50Hz

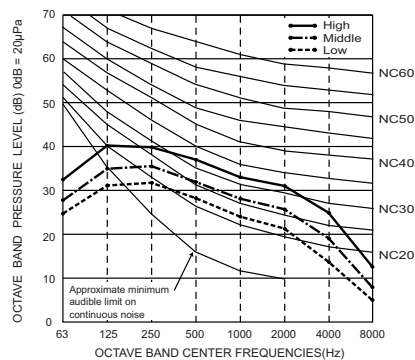

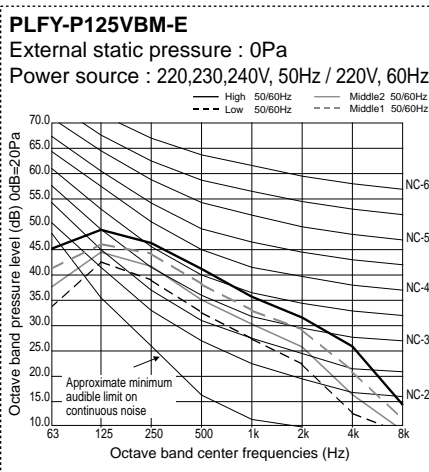
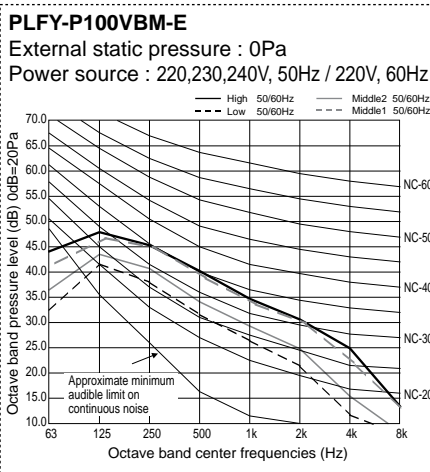
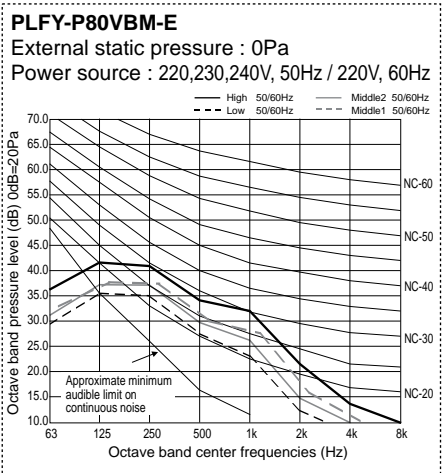
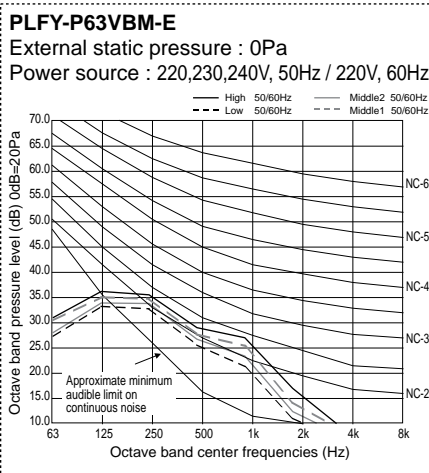
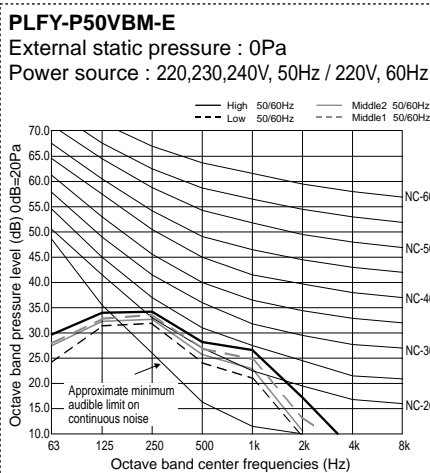
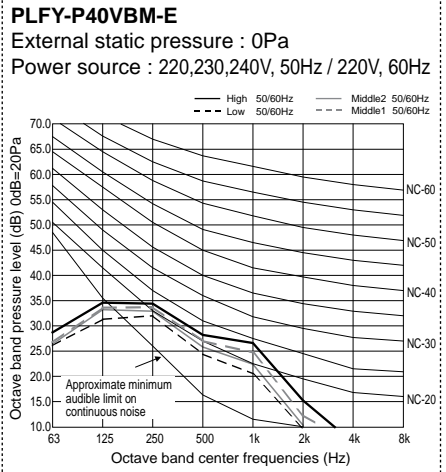
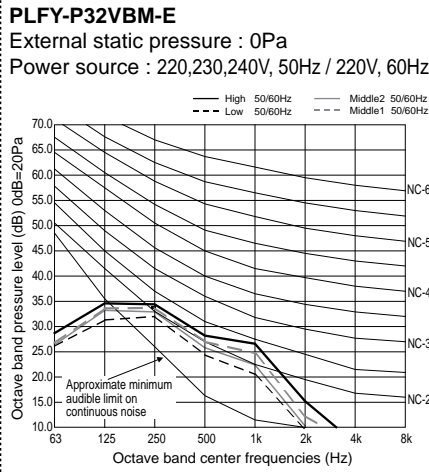
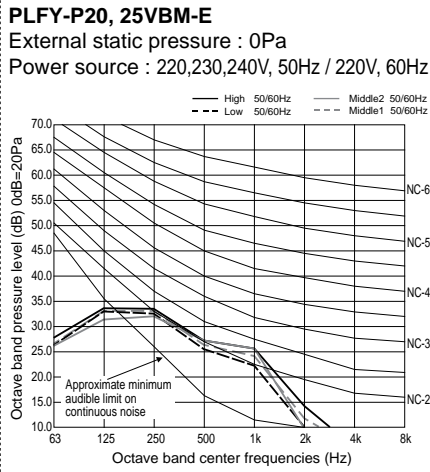

PLFY-VCM/VBM

6-1. Temperature distributions

PLFY-P15-40VCM-E2

<Cooling mode>

Flow angle 30°

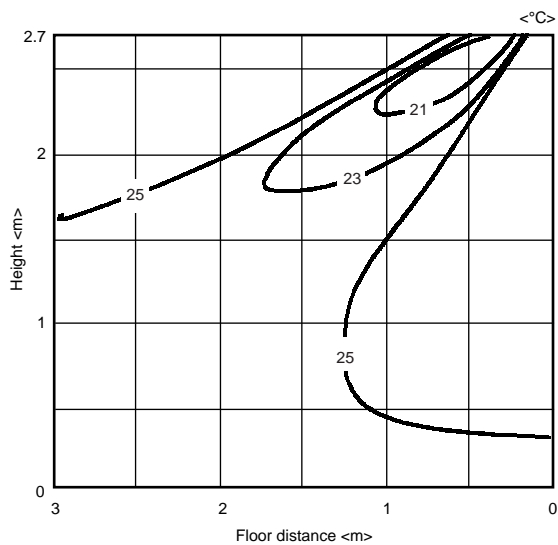

<Heating mode>

Flow angle 70°

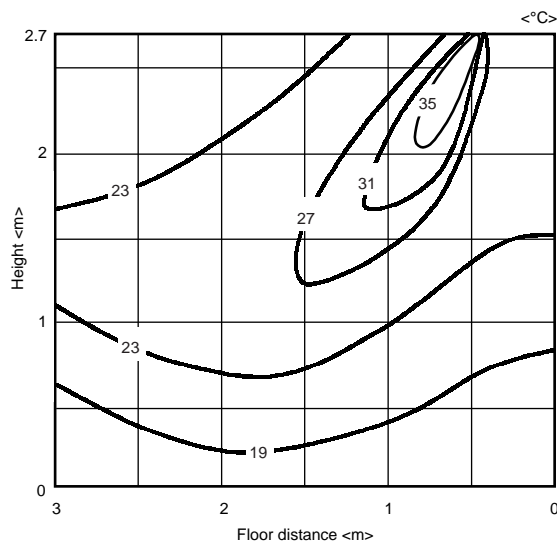

Note : These figures show typical temperature distributions in the conditions above. In the actual installation, they may differ from these figures under the influence of air temperature conditions, ceiling height, cooling/heating load, obstacles, etc.

PLFY-P-VBM-E

• PLY-P20-80VBM-E
 <Cooling mode> Standard
 Flow angle : 30° 4-way flow
 ceiling height : 2.7 m

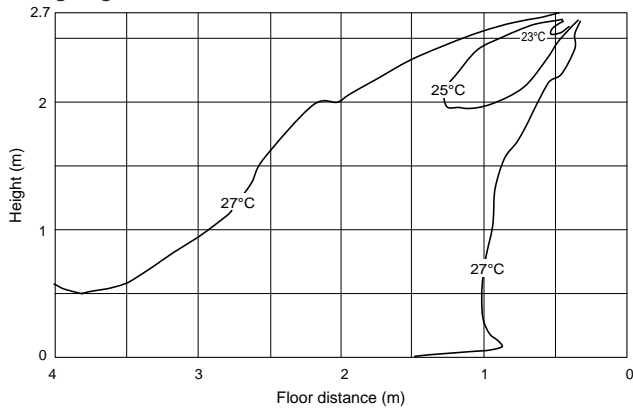

<Heating mode> Standard
 Flow angle : 60° 4-way flow
 ceiling height : 2.7 m

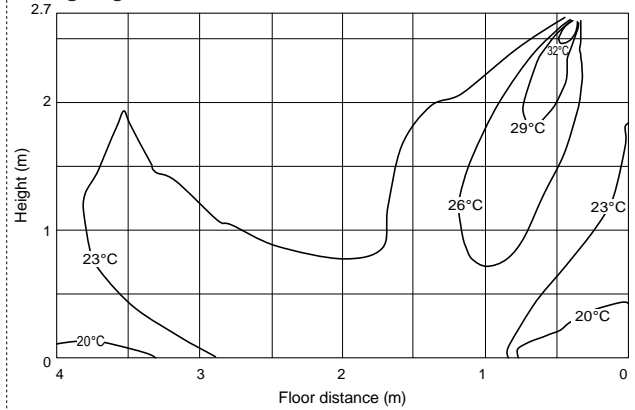

• PLY-P100, 125VBM-E
 <Cooling mode> Standard
 Flow angle : 30° 4-way flow
 ceiling height : 3.2 m

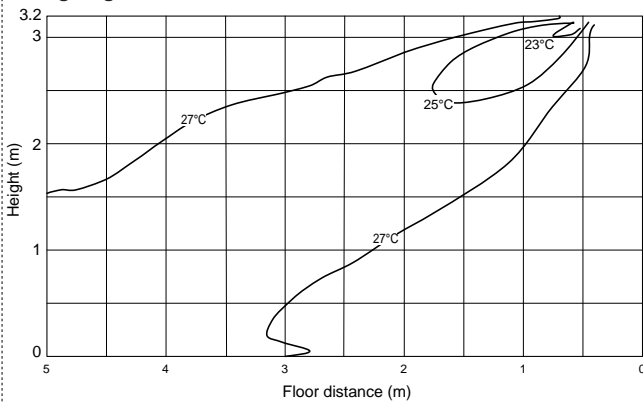

<Heating mode> Standard
 Flow angle : 60° 4-way flow
 ceiling height : 3.2 m

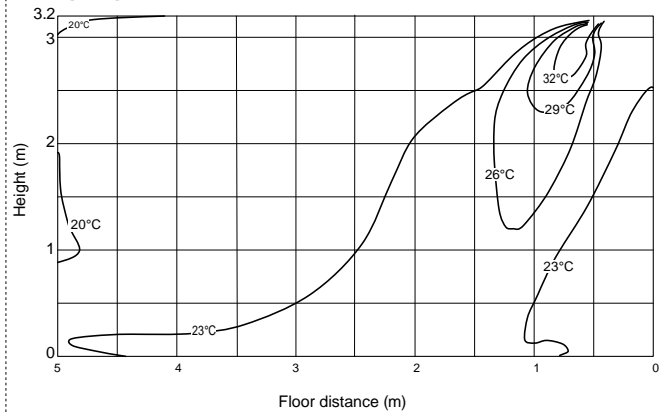

PLFY-VCM/VBM

Note : These figures show typical temperature distributions in the conditions above. In the actual installation, they may differ from these figures under the influence of air temperature conditions, ceiling height, cooling/heating load, obstacles, etc.

6-2. Airflow distributions

PLFY-P15-40VCM-E2

<Fan mode>
Flow angle 70°



<Fan mode>
Flow angle 30°

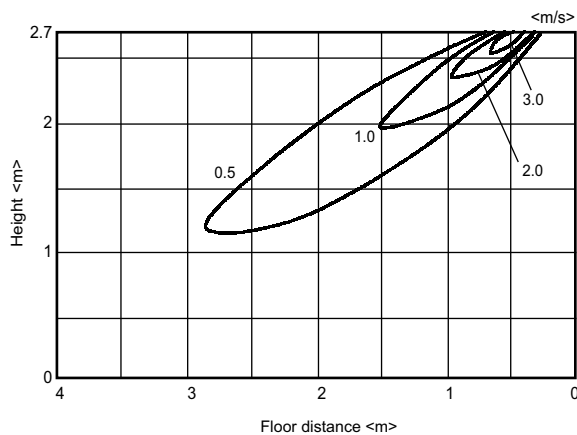

PLFY-P20-80VBM-E

<Heating mode>
Flow angle 60°

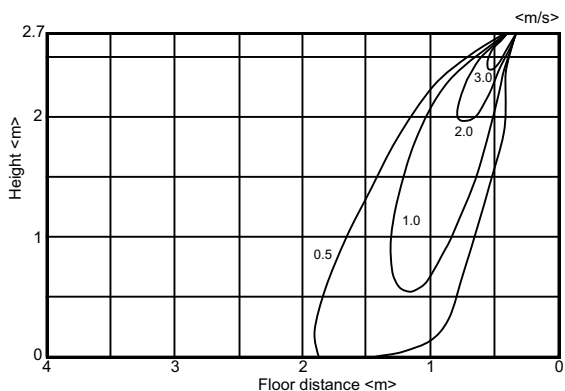

<Cooling mode>
Flow angle 30°

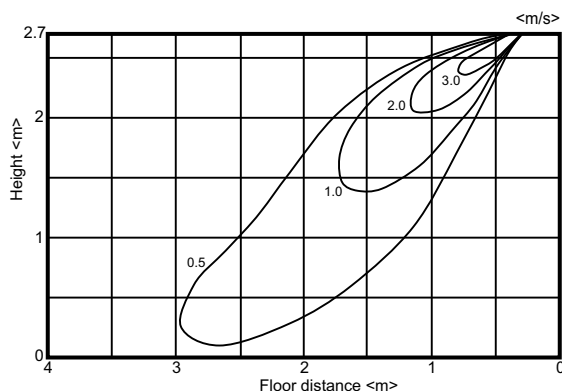

PLFY-P100, 125VBM-E

<Heating mode>
Flow angle 60°

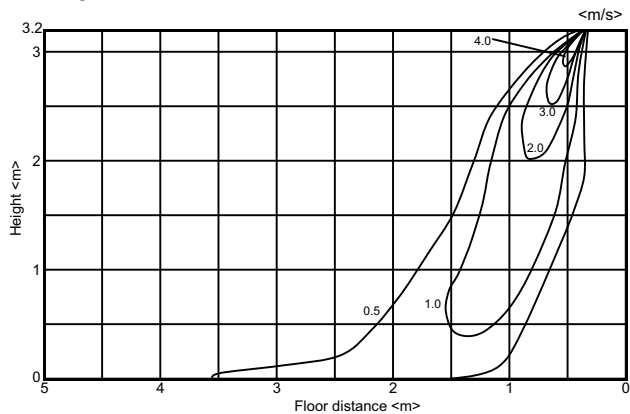

<Cooling mode>
Flow angle 30°

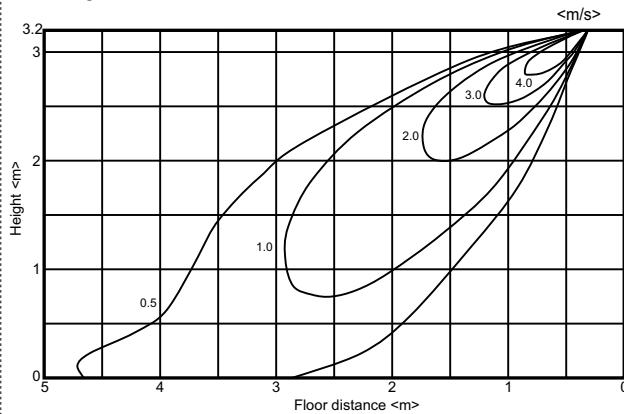

Note : These figures show typical airflow distributions in the conditions above. In the actual installation, they may differ from these figures under the influence of air temperature conditions, ceiling height, cooling/heating load, obstacles, etc.

7-1. Optional parts line up for the Indoor unit

	Description	Model
PLFY-P-VBM-E	Air outlet shutter plate	PAC-SH51SP-E
	Multi-function casement	PAC-SH53TM-E
	High efficiency filter element	PAC-SH59KF-E
	i-see Sensor corner panel	PAC-SA1ME-E
	Automatic filter elevation panel	PLP-6BAJ
	Wireless signal receiver	PAR-SA9FA-E
	Space panel	PAC-SH48AS-E
	Duct flange for fresh air intake	PAC-SH65OF-E

PLFY-P-VBM-E

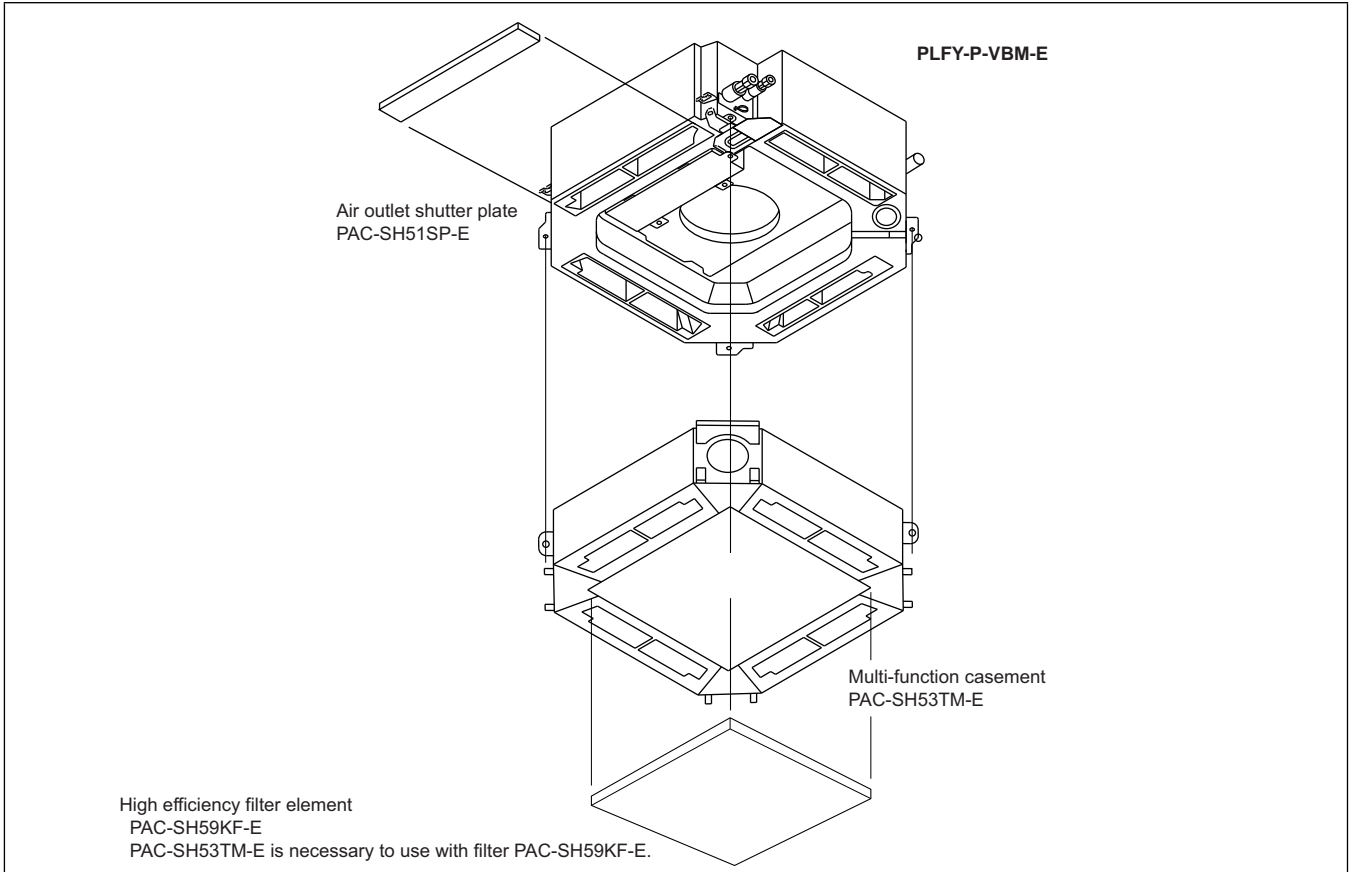

PLFY-VCM/VBM

7-2. Air outlet shutter plate

Using the air outlet shutter plate to block the air outlet to modify the air-way from 4 to 3 or 2.
 With 1 PAC-SH51SP-E, 4 air-ways can be changed to 3;
 With 2 PAC-SH51SP-E, 4 air-ways can be changed to 2;
 Changing to 1 way is not allowed.
 Material: Foamed polyethylene + foamed urethane, color: Black

Item	① Shutter plate	② Insulator	
Quantity	2	1	
Shape			

Detailed installation information should be referred to its Installation Manual.

7-3. High efficiency filter element

Life span: 2,500 hr (Dust concentration 0.15mg/m³); Colorimetric method 65% (JIS 11 class); No re-production.

* The actual dust situation affects the filter life span, which should be considered at the applying site.

Material: Electrostatic polyolefin fiber

High efficiency filter element PAC-SH59KF-E should be used together with the Multi-function casement PAC-SH53TM-E. When using PAC-SH59KF-E, switching on SWC of the Indoor unit address board is needed. Details should be referred to its Installation Manual.

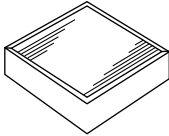
Quantity	1	
Shape		

Detailed installation information is referred in its Installation Manual.



7-4. Multi-function casement

Multi-function casement is used for High efficiency filter element and/or fresh air intake from outdoor.

It should be used with High efficiency filter element PAC-SH59KF-E (Colorimetric method 65%).

Fresh air intake on the Multi-function casement is possible from any 2 or less corners among the 4 ones.

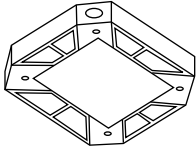
But duct and flange on the casement should be prepare locally.

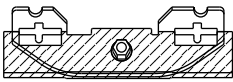
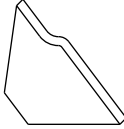
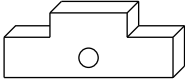

Item	① Multi-functional casement	② Screw with washer (black)	③ Screw
Quantity	1	4	8
Shape		M5X0.8X25 	M5X0.8X12 
Item	④ Decorative panel securing bracket	⑤ Insulator A for Decorative panel	⑥ Insulator B for Decorative panel
Quantity	4	1	1
Shape	With insulator 		

Detailed installation information should be referred to its Installation Manual.

PLFY-YCM/VBM

7-5. i-see sensor corner panel

i-see sensor provides comfortable space as it detects the floor temperature to prevent spotty temperature. And that enables the unit to save energy.
 Attention
 Make sure that there are no gaps between the unit and the grille, and the grille and ceiling.
 ※ It may cause dew dripping.

Item	① i-see sensor corner panel	② Plastic fastener	
Quantity	1	2	
Shape			

Detailed installation information should be referred to its Installation Manual.

7-6. Automatic filter elevation panel

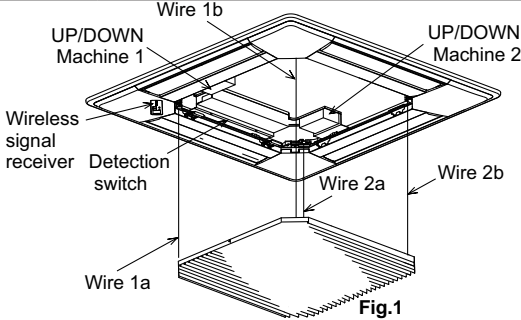
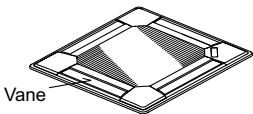
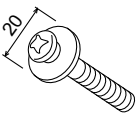
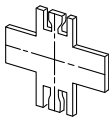

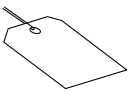





Fig.1

- Air intake grille can be lifted and lowered automatically by wired remote controller (MA type) or wireless remote controller (Item 9).
- Lowering the air intake grille allows you to clean the filter easily.
- You can set up eight different stages of lowering distance for the air intake grille according to the set up location if desired. (Maximum : 4m)

Item	① Decorative panel	② Screw with washer	③ Installation gauge	④ Plastic fastener
Quantity	1	4	1	3
Shape		 M5X0.8X25	 (Used split into four pieces)	
Item	⑤ Tag	⑥ Screw	⑦ Screw	⑧ Screw
Quantity	1	4	1	3
Shape		 4X8 Only three are used	 4X12	 M5X10
Item	⑨ Wireless remote controller			
Quantity	1			
Shape				

Detailed installation information should be referred to its Installation Manual.

7-7. Wireless signal receiver

Wireless signal receiver PAR-SA9FA-E is necessary for using wireless remote controller PAR-SA9FA-E is a corner panel with the signal receiver for wireless remote controller.

Item	① Wireless signal receiver	
Quantity	1	
Shape		

Detailed installation information should be referred to its Installation Manual.

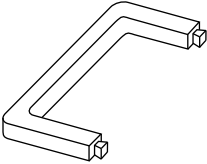
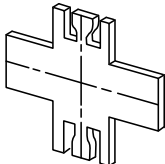

7-8. Space panel

Decorative cover for the installation when the ceiling height is low.

Item	① Space panel	② Gauge for installation
Quantity	2	1
Shape		

7-9. Duct flange for fresh air intake

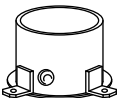
Part to attach a duct to take in fresh air from outdoors.

Item	① Duct flange	② Insulator	③ Screws (M4 x 10)
Quantity	1	1	3
Shape			

PLFY-YCM/VBM

PCFY-P-VKM-E

1. SPECIFICATIONS	1 - 154
2. EXTERNAL DIMENSIONS	1 - 155
3. CENTER OF GRAVITY	1 - 158
4. ELECTRICAL WIRING DIAGRAMS	1 - 159
5. SOUND LEVELS	1 - 160
5-1. Sound levels	1 - 160
5-2. NC curves	1 - 160
6. OA INTAKE-STATIC PRESSURE CURVES	1 - 161
7. TEMPERATURE/AIRFLOW DISTRIBUTIONS	1 - 162
7-1. Temperature distributions	1 - 162
7-2. Airflow distributions	1 - 163
8. OPTIONAL PARTS	1 - 164
8-1. Optional parts line up for the Indoor unit	1 - 164
8-2. High efficiency filter	1 - 164
8-3. Drain pump	1 - 164
8-4. Wireless remote controller kit	1 - 164

1. SPECIFICATIONS

YKB/YLM

Model		PCFY-P40VKM-E	PCFY-P63VKM-E	PCFY-P100VKM-E	PCFY-P125VKM-E	
Power source		1-phase 220-240V 50Hz, 1-phase 220V 60Hz	1-phase 220-240V 50Hz, 1-phase 220V 60Hz	1-phase 220-240V 50Hz, 1-phase 220V 60Hz	1-phase 220-240V 50Hz, 1-phase 220V 60Hz	
Cooling capacity (Nominal)	*1 kW	4.5	7.1	11.2	14.0	
	*1 kcal / h	3,900	6,100	9,600	12,000	
	*1 BTU / h	15,400	24,200	38,200	47,800	
	*2 kcal / h	4,000	6,300	10,000	12,500	
	(220V) Power input kW	0.04	0.05	0.09	0.11	
(220V) Current input	A	0.28	0.33	0.65	0.76	
Heating capacity (Nominal)	*3 kW	5.0	8.0	12.5	16.0	
	*3 kcal / h	4,300	6,900	10,800	13,800	
	*3 BTU / h	17,100	27,300	42,700	54,600	
	(220V) Power input kW	0.04	0.05	0.09	0.11	
	(220V) Current input	A	0.28	0.33	0.65	0.76
External finish		MUNSELL (6.4Y 8.9/0.4)	MUNSELL (6.4Y 8.9/0.4)	MUNSELL (6.4Y 8.9/0.4)	MUNSELL (6.4Y 8.9/0.4)	
External dimension HxWxD		mm 230x960x680	mm 230x1280x680	mm 230x1600x680	mm 230x1600x680	
		in. 9-1/16 x 37-13/16 x 26-3/4	in. 9-1/16 x 50-3/8 x 26-3/4	in. 9-1/16 x 63 x 26-3/4	in. 9-1/16 x 63 x 26-3/4	
Net weight		kg(lbs) 24(53)	kg(lbs) 32(71)	kg(lbs) 36(79)	kg(lbs) 38(84)	
Heat exchanger		Cross fin (Aluminum fin and copper tube)	Cross fin (Aluminum fin and copper tube)	Cross fin (Aluminum fin and copper tube)	Cross fin (Aluminum fin and copper tube)	
FAN	Type x Quantity		Sirocco fan x 2	Sirocco fan x 3	Sirocco fan x 4	Sirocco fan x 4
	External static press.	Pa	0	0	0	0
		mmH ₂ O	0	0	0	0
	Motor Type		DC motor	DC motor	DC motor	DC motor
	Motor output		kW 0.090	kW 0.095	kW 0.160	kW 0.160
	Driving mechanism		Direct-drive	Direct-drive	Direct-drive	Direct-drive
	Air flow rate (Low-Mid2-Mid1-High)	m ³ / min	10-11-12-13	14-15-16-18	21-24-26-28	21-24-27-31
		L/s	167-183-200-217	233-250-267-300	350-400-433-467	350-400-450-517
cfm		353-388-424-459	494-530-565-636	742-847-918-989	742-847-953-1095	
Sound pressure level (measured in anechoic room)		dB <A> 29-32-34-36	dB <A> 31-33-35-37	dB <A> 36-38-41-43	dB <A> 36-39-42-44	
Insulation material		Polyeter sheet	Polyeter sheet	Polyeter sheet	Polyeter sheet	
Air filter		PP honeycomb (long life)	PP honeycomb (long life)	PP honeycomb (long life)	PP honeycomb (long life)	
Protection device		Fuse	Fuse	Fuse	Fuse	
Refrigerant control device		LEV	LEV	LEV	LEV	
Connectable outdoor unit		R410A CITY MULTI	R410A CITY MULTI	R410A CITY MULTI	R410A CITY MULTI	
Diameter of refrigerant pipe	Liquid (R410A)	mm(in.) 6.35(1/4) Flare	mm(in.) 9.52(3/8) Flare	mm(in.) 9.52(3/8) Flare	mm(in.) 9.52(3/8) Flare	
	Gas (R410A)	mm(in.) 12.70(1/2) Flare	mm(in.) 15.88(5/8) Flare	mm(in.) 15.88(5/8) Flare	mm(in.) 15.88(5/8) Flare	
Field drain pipe size		mm(in.) O.D. 26mm(1)	mm(in.) O.D. 26mm(1)	mm(in.) O.D. 26mm(1)	mm(in.) O.D. 26mm(1)	
Drawing	External		-	-	-	-
	Wiring		-	-	-	-
	Refrigerant cycle		-	-	-	-
Standard attachment	Document		Installation Manual, Instruction Book	Installation Manual, Instruction Book	Installation Manual, Instruction Book	Installation Manual, Instruction Book
	Accessory		-	-	-	-
Optional parts	Circular duct flange		-	-	-	-
	Drain pump kit		PAC-SH83DM-E	PAC-SH84DM-E	PAC-SH84DM-E	PAC-SH84DM-E
	Square duct flange		-	-	-	-
	Filter box for rear suction		-	-	-	-
	Filter box for bottom suction		-	-	-	-
	Canvas duct for bottom suction		-	-	-	-
	Medium efficiency filter 65%		-	-	-	-
	High efficiency filter		PAC-SH88KF-E	PAC-SH89KF-E	PAC-SH90KF-E	PAC-SH90KF-E
	Maintenance panel with air intake		-	-	-	-
Wireless remote controller kit		PAR-SL94B-E	PAR-SL94B-E	PAR-SL94B-E	PAR-SL94B-E	
Remarks		* Details on foundation work, duct work, insulation work, electrical wiring, power source switch, and other items shall be referred to the Installation Manual.	* Details on foundation work, duct work, insulation work, electrical wiring, power source switch, and other items shall be referred to the Installation Manual.	* Details on foundation work, duct work, insulation work, electrical wiring, power source switch, and other items shall be referred to the Installation Manual.	* Details on foundation work, duct work, insulation work, electrical wiring, power source switch, and other items shall be referred to the Installation Manual.	

Notes:	*1 Nominal cooling conditions (subject to JIS B8615-1)	*2 Nominal cooling conditions	*3 Nominal heating conditions (subject to JIS B8615-1)	Unit converter
Indoor:	27degC D.B. / 19degC W.B. (81degF D.B. / 66degF W.B.)	27degC D.B. / 19.5degC W.B. (81degF D.B. / 67degF W.B.)	20degC D.B. (68degF D.B.)	kcal/h = kW x 860 BTU/h = kW x 3,412
Outdoor:	35degC D.B. (95degF D.B.)	35degC D.B. (95degF D.B.)	7degC D.B. / 6degC W.B. (45degF D.B. / 43degF W.B.)	cfm = m ³ /min x 35.31 lbs = kg / 0.4536
Pipe length:	7.5 m (24-9/16 ft.)	5 m (16-3/8 ft.)	7.5 m (24-9/16 ft.)	
Level difference:	0 m (0 ft.)	0 m (0 ft.)	0 m (0 ft.)	*The specification data is subject to rounding variation.

PCFY-P40VKM-E

Unit : mm

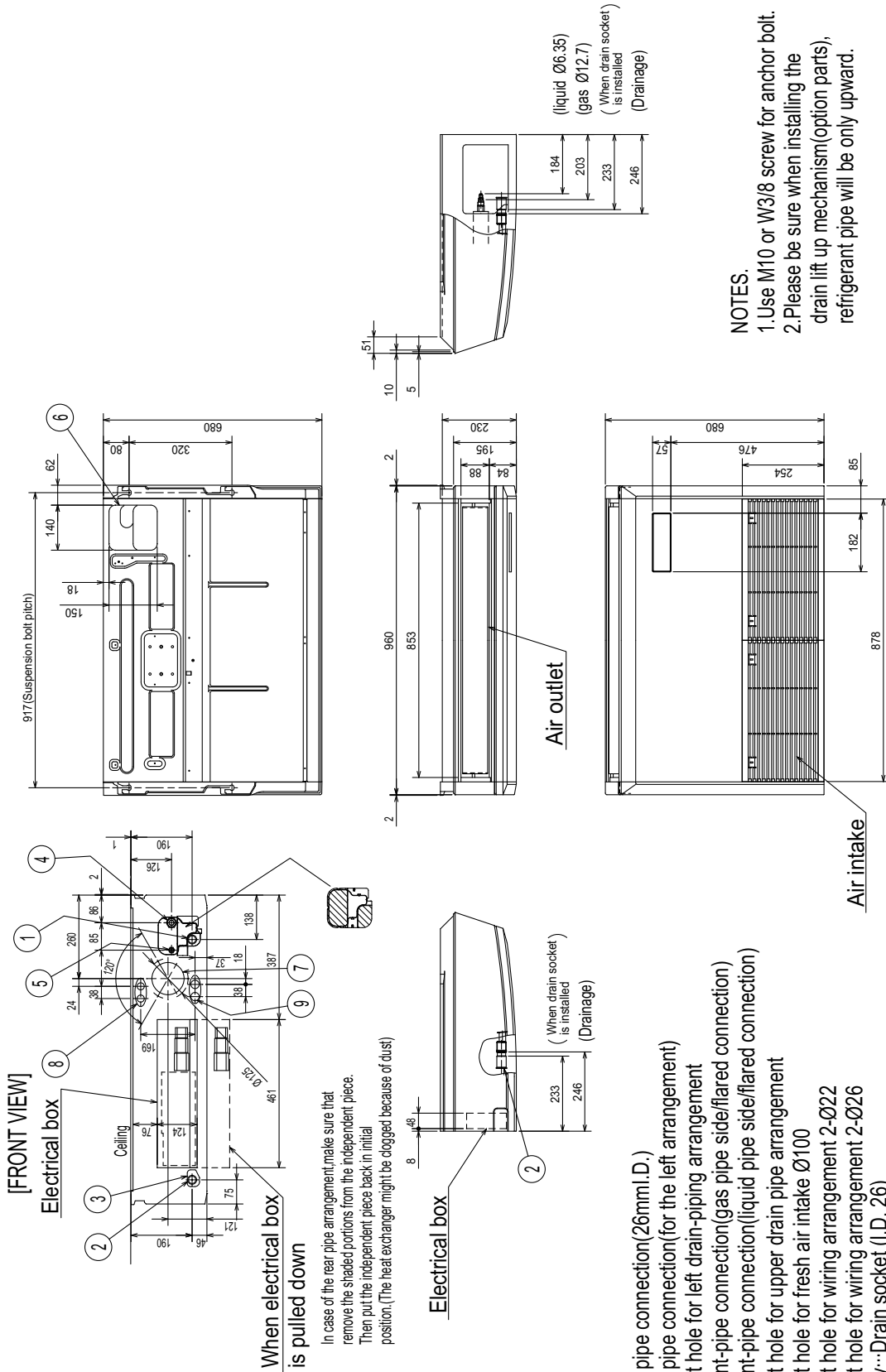

NOTES.
 1. Use M10 or W3/8 screw for anchor bolt.
 2. Please be sure when installing the drain lift up mechanism (option parts), refrigerant pipe will be only upward.

- ① Drainage pipe connection (26mm I.D.)
 - ② Drainage pipe connection (for the left arrangement)
 - ③ Knock out hole for left drain-piping arrangement
 - ④ Refrigerant-pipe connection (gas pipe side/flared connection)
 - ⑤ Refrigerant-pipe connection (liquid pipe side/flared connection)
 - ⑥ Knock out hole for upper drain pipe arrangement
 - ⑦ Knock out hole for fresh air intake Ø100
 - ⑧ Knock out hole for wiring arrangement 2-Ø22
 - ⑨ Knock out hole for wiring arrangement 2-Ø26
- Accessory... Drain socket (I.D. 26)

PCFY

PCFY-P63VKM-E

Unit : mm

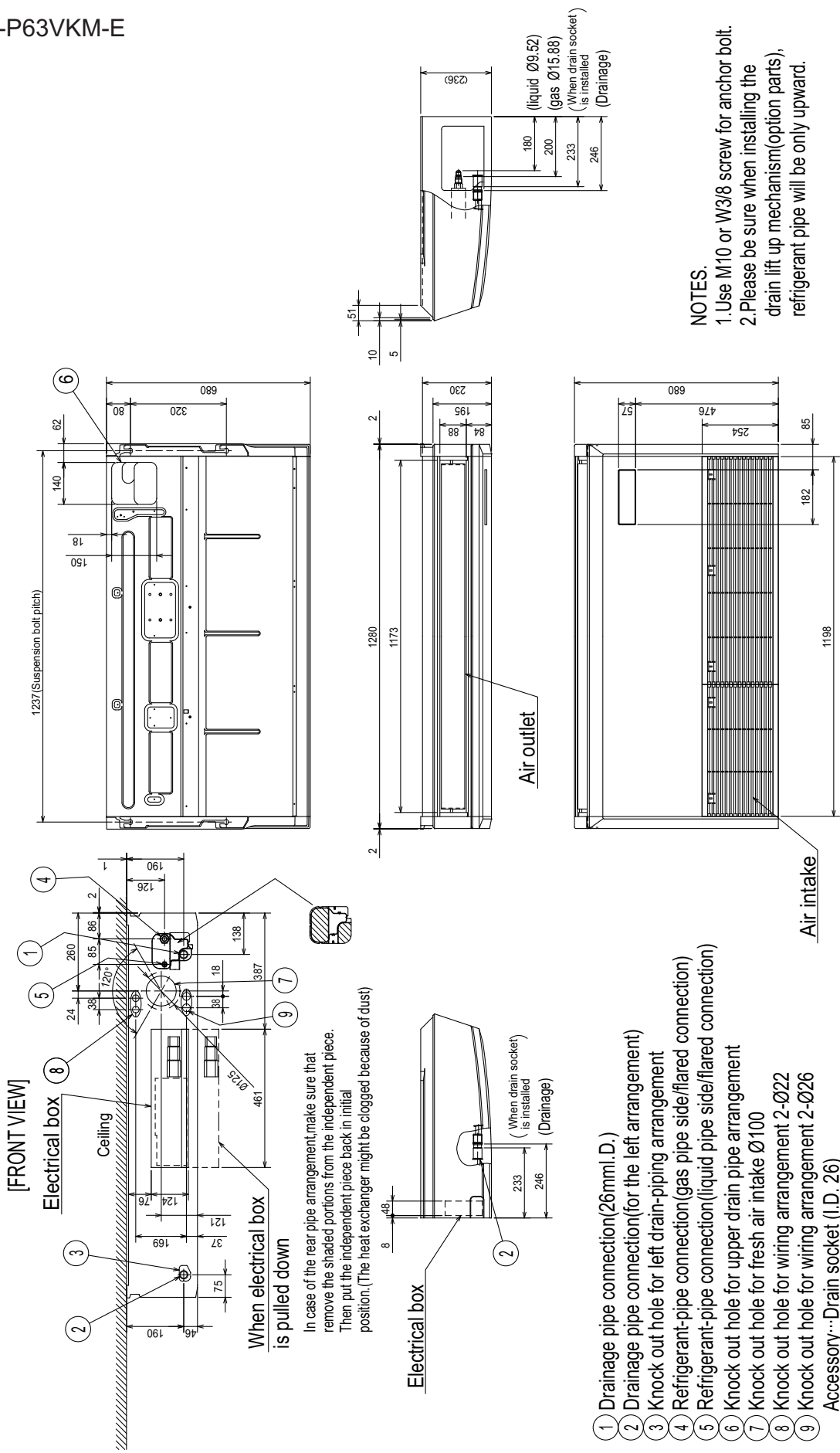

NOTES.
 1. Use M10 or W3/8 screw for anchor bolt.
 2. Please be sure when installing the drain lift up mechanism(option parts), refrigerant pipe will be only upward.

In case of the rear pipe arrangement, make sure that remove the shaded portions from the independent piece. Then put the independent piece back in initial position. (The heat exchanger might be clogged because of dust)

- ① Drainage pipe connection(26mm.I.D.)
 - ② Drainage pipe connection(for the left arrangement)
 - ③ Knock out hole for left drain-piping arrangement
 - ④ Refrigerant-pipe connection(gas pipe side/flared connection)
 - ⑤ Refrigerant-pipe connection(liquid pipe side/flared connection)
 - ⑥ Knock out hole for upper drain pipe arrangement
 - ⑦ Knock out hole for fresh air intake Ø100
 - ⑧ Knock out hole for wiring arrangement 2-Ø22
 - ⑨ Knock out hole for wiring arrangement 2-Ø26
- Accessory...Drain socket (I.D. 26)

PCFY-P100,125VKM-E

Unit : mm

- ⑥ Knock out hole for upper drain pipe arrangement
- ⑦ Knock out hole for fresh air intake Ø100
- ⑧ Knock out hole for wiring arrangement 2-Ø22
- ⑨ Knock out hole for wiring arrangement 2-Ø26
- Accessory : Drain socket (I.D. 26)

- ① Drainage pipe connection(26mm I.D.)
- ② Drainage pipe connection(for the left arrangement)
- ③ Knock out hole for left drain-piping arrangement
- ④ Refrigerant-pipe connection(gas pipe side/flared connection)
- ⑤ Refrigerant-pipe connection(liquid pipe side/flared connection)

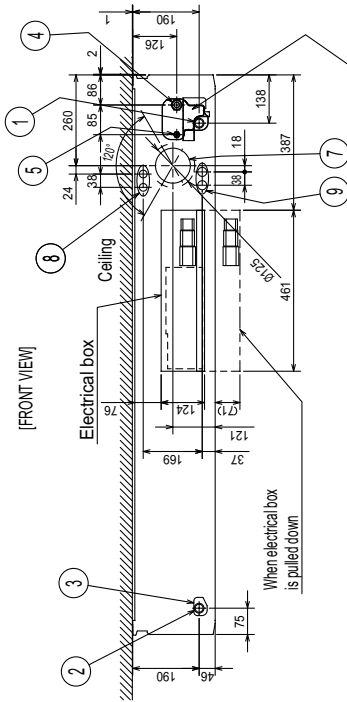

In case of the rear pipe arrangement, make sure that remove the shaded portions from the independent piece. Then put the independent piece back in initial position. (The heat exchanger might be clogged because of dust)

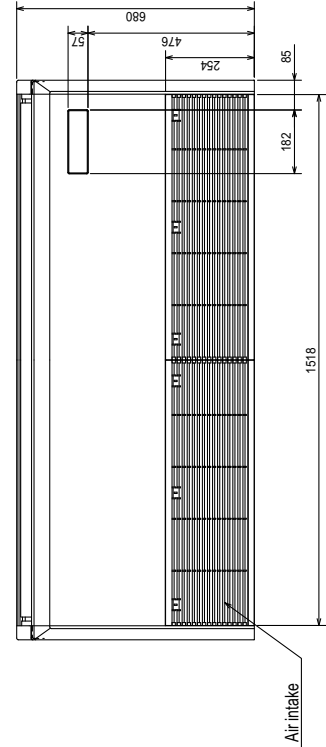
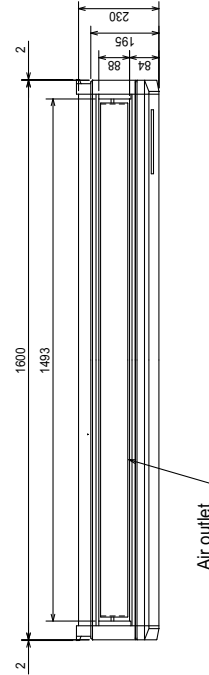
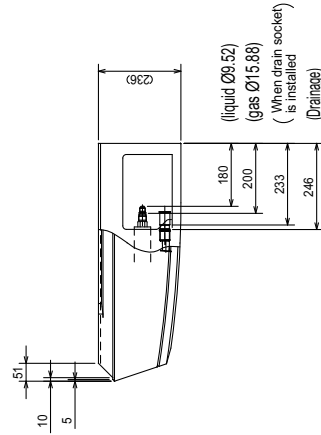

- NOTES.
- 1. Use M10 or W3/8 screw for anchor bolt.
 - 2. Please be sure when installing the drain lift up mechanism(option parts), refrigerant pipe will be only upward.

Use the current nuts meeting the pipe size of the outdoor unit.

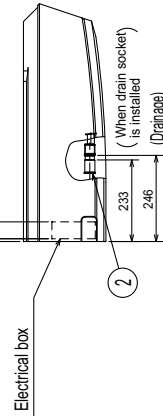

PCFY-P40,63,100,125VKM-E

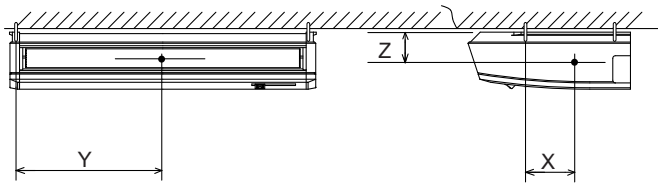

Model name	X	Y	Z
PCFY-P40VKM-E	110	450	115
PCFY-P63VKM-E	110	610	115
PCFY-P100VKM-E	110	770	115
PCFY-P125VKM-E	110	770	115

PCFY-P40, 63, 100, 125VKM-E

[LEGEND]

SYMBOL	NAME	SYMBOL	NAME
I. B	INDOOR CONTROLLER BOARD	TH22	THERMISTOR PIPE TEMP. DETECTION / LIQUID (0°C / 15kΩ, 25°C / 5.4kΩ)
CN27	CONNECTOR DAMPER	TH23	PIPE TEMP. DETECTION / GAS (0°C / 15kΩ, 25°C / 5.4kΩ)
CN32	CONNECTOR REMOTE SWITCH	A. B	ADDRESS BOARD
CN51	CONNECTOR CENTRALLY CONTROL	SWA	SWITCH CEILING HEIGHT SELECTOR
CN52	CONNECTOR REMOTE INDICATION	SWC	SWITCH OPTION SELECTOR
CN105	CONNECTOR IT TERMINAL	SW1	SWITCH MODE SELECTION
FUSE	FUSE (T6.3AL250V)	SW11	SWITCH ADDRESS SETTING 1s DIGIT
SW2	SWITCH CAPACITY CODE	SW12	SWITCH ADDRESS SETTING 10ths DIGIT
SW3	SWITCH MODE SELECTION	SW14	SWITCH BRANCH No.
SW4	SWITCH MODEL SELECTION	OPTIONAL PARTS	
SWE	SWITCH DRAIN PUMP (TEST MODE)	W. B	PCB FOR WIRELESS REMOTE CONTROLLER
X1	AUX. RELAY DRAIN PUMP (OPTIONAL PARTS)	BZ	BUZZER
LEV	LINEAR EXPANSION VALVE	LED1	LED (OPERATION INDICATION : GREEN)
DCL	REACTOR	LED2	LED (PREPARATION FOR HEATING : ORANGE)
MF	FAN MOTOR	RU	RECEIVING UNIT
MV	VANE MOTOR	SW1	SWITCH EMERGENCY OPERATION (HEAT / DOWN)
TB2	TERMINAL BLOCK POWER SUPPLY	SW2	SWITCH EMERGENCY OPERATION (COOL / UP)
TB5	TERMINAL BLOCK TRANSMISSION	DP	DRAIN PUMP
TB15	TERMINAL BLOCK MA-REMOTE CONTROLLER	FS	DRAIN FLOAT SWITCH
TH21	THERMISTOR ROOM TEMP. DETECTION (0°C / 15kΩ, 25°C / 5.4kΩ)		

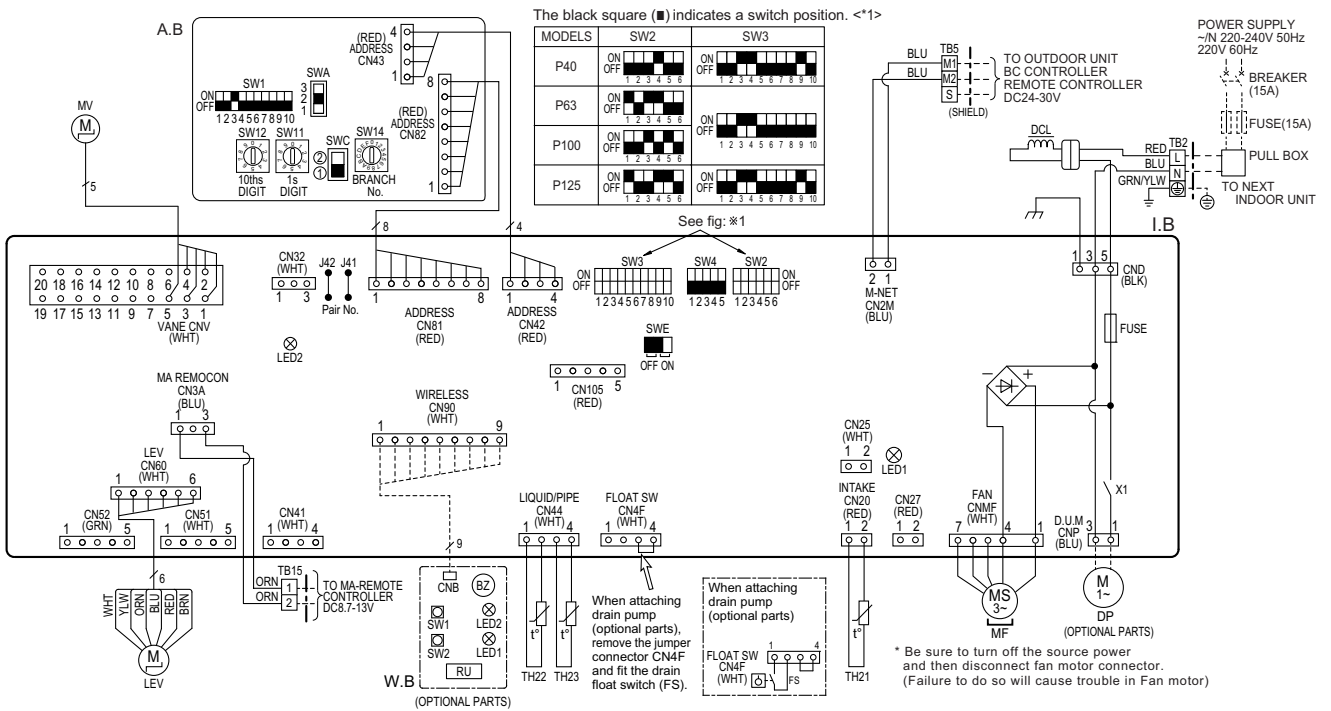

NOTES:

- At servicing for outdoor unit, always follow the wiring diagram of outdoor unit.
- In case of using MA-Remote controller, please connect to TB15.
(Remote controller wire is non-polar.)
- In case of using M-NET, please connect to TB5. (Transmission line is non-polar.)
- Symbol [S] of TB5 is the shield wire connection.
- Symbols used in wiring diagram above are, [] : terminal block, [] : connector.
- The setting of the SW2 dip switches differs in the capacity. For the detail, refer to fig <*1>.

LED on indoor board for service

Mark	Meaning	Function
LED1	Main power supply	Main Power supply (Indoor unit:220-240V) power on → lamp is lit
LED2	Power supply for MA-Remote controller	Power supply for MA-Remote controller on → lamp is lit

PCFY

5-1. Sound levels

Ceiling suspended

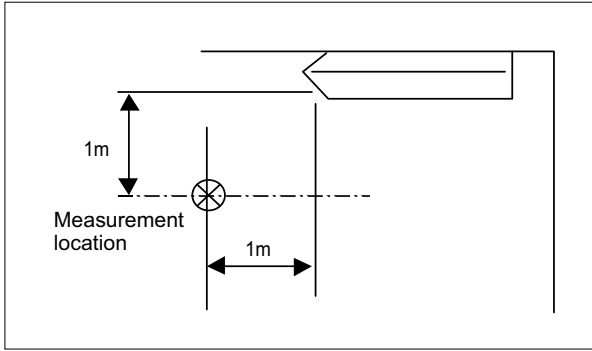

Sound level at anechoic room : Low-Middle2-Middle1-High

Model	Sound level dB (A)
PCFY-P40VKM-E	29-32-34-36
PCFY-P63VKM-E	31-33-35-37
PCFY-P100VKM-E	36-38-41-43
PCFY-P125VKM-E	36-39-42-44

* Measured in anechoic room.

5-2. NC curves

PCFY-P40VKM

External Static Pressure: 0Pa
Power Source: 200V, 50/60Hz

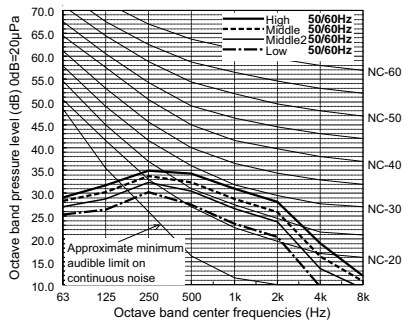

PCFY-P63VKM

External Static Pressure: 0Pa
Power Source: 200V 50/60Hz

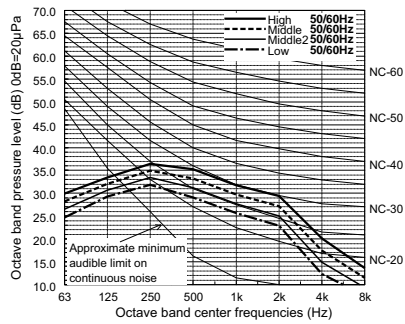

PCFY-P100VKM

External Static Pressure: 0Pa
Power Source: 200V 50/60Hz

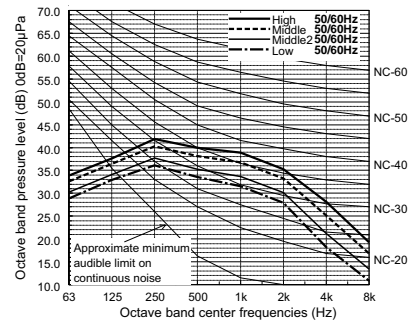

PCFY-P125VKM

External Static Pressure: 0Pa
Power Source: 200V 50/60Hz

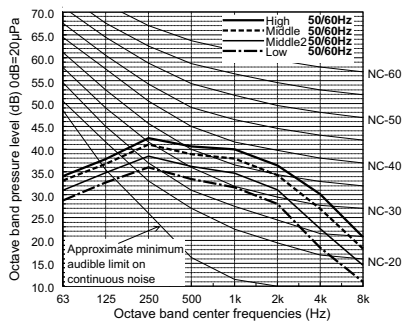

PCFY

■ PCFY-P40VKM-E

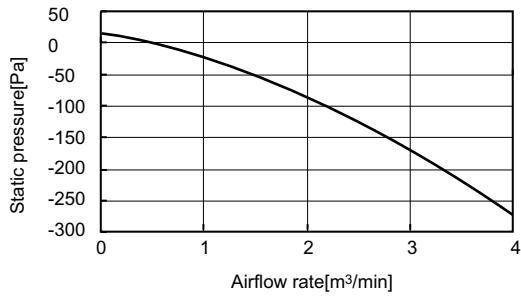

■ PCFY-P63VKM-E

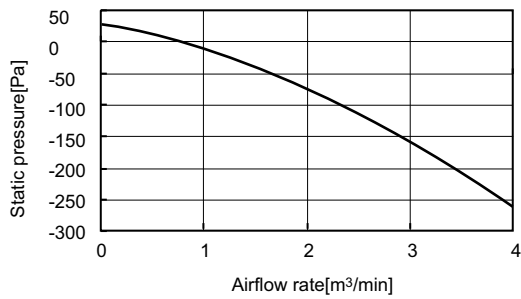

■ PCFY-P100, 125VKM-E



PCFY

7-1. Temperature distributions

Temperature distributions

PCFY-P40, 63VKM-E

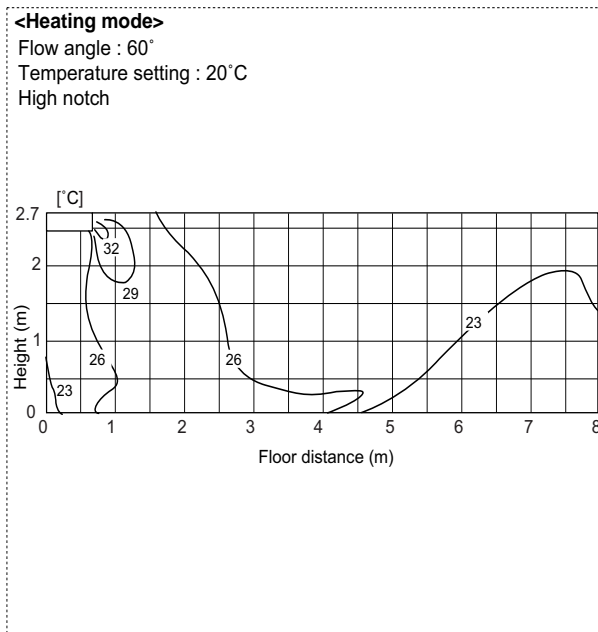
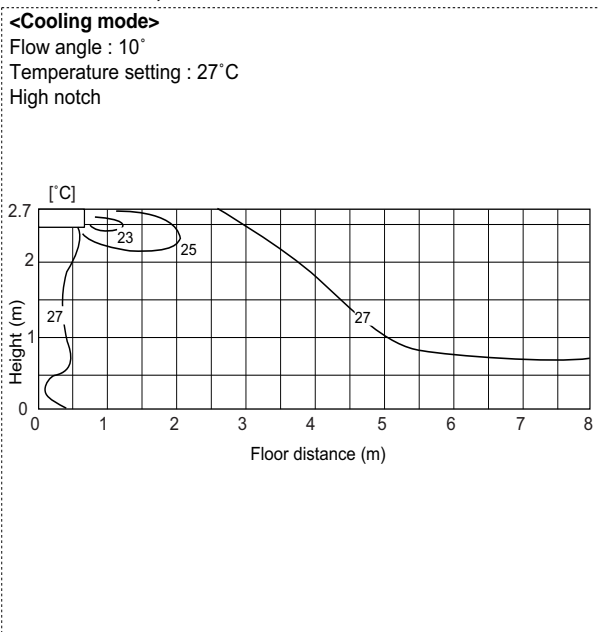

PCFY-P100, 125VKM-E

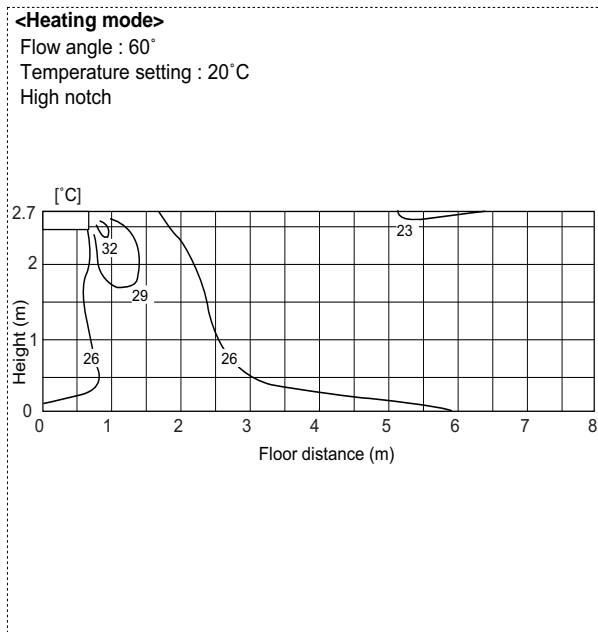
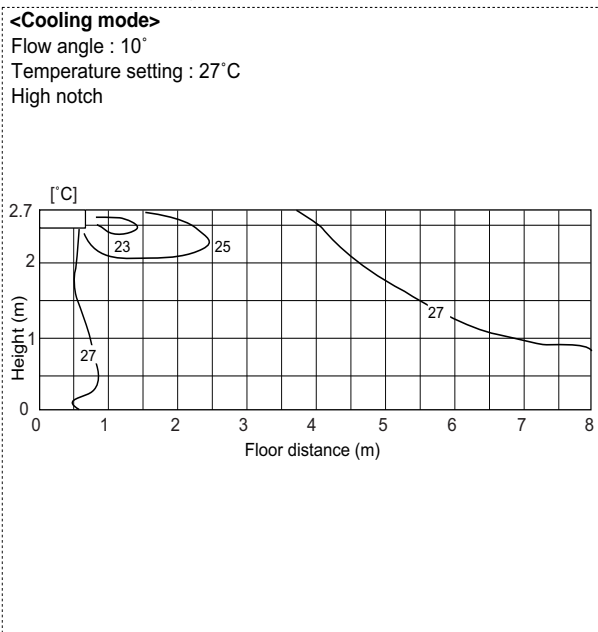

Note : These figures show typical airflow distributions in the conditions above. In the actual installation, they may differ from these figures under the influence of air temperature conditions, ceiling height, cooling/heating load, obstacles, etc.

PCFY

7-2. Airflow distributions

**Airflow distributions
PCFY-P40, 63VKM-E**

<Cooling mode>

Flow angle : 10°
Temperature setting : 27°C
High notch
Ceiling height : 2.7m

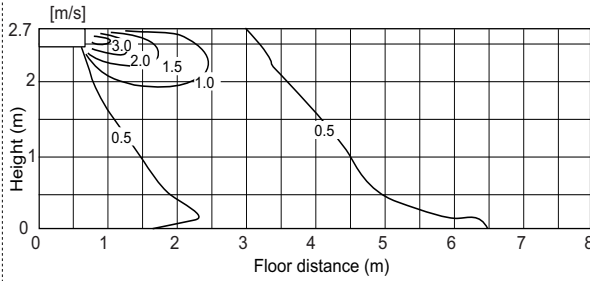

<Heating mode>

Flow angle : 60°
Temperature setting : 27°C
High notch
Ceiling height : 2.7m

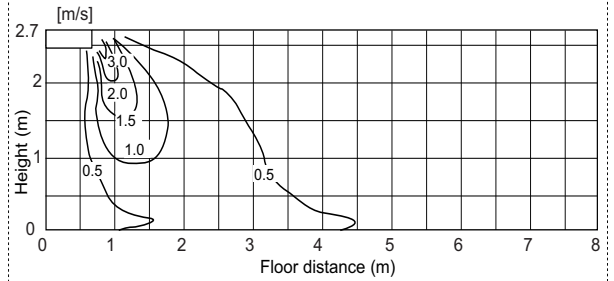

PCFY-P100, 125VKM-E

<Fan mode>

Flow angle : 10°
Temperature setting : 27°C
High notch
Ceiling height : 2.7m

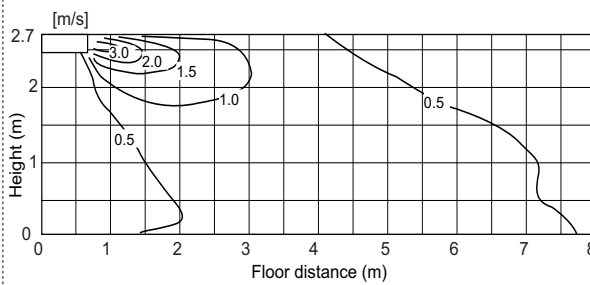

<Fan mode>

Flow angle : 60°
Temperature setting : 27°C
High notch
Ceiling height : 2.7m

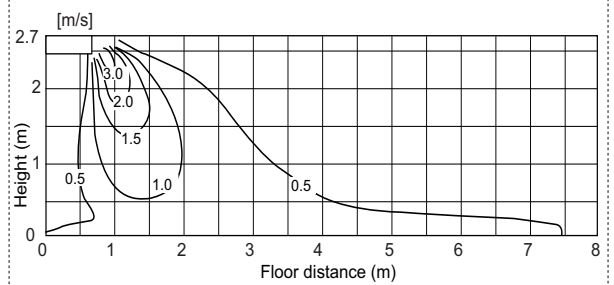

Note : These figures show typical airflow distributions in the conditions above. In the actual installation, they may differ from these figures under the influence of air temperature conditions, ceiling height, cooling/heating load, obstacles, etc.

8-1. Optional parts line up for the Indoor unit



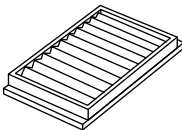

	High-efficiency filter	Wireless remote controller kit	Drain pump
PCFY-P40VKM-E	PAC-SH88KF-E	PAR-SL94B-E	PAC-SH83DM-E
PCFY-P63VKM-E	PAC-SH89KF-E	PAR-SL94B-E	PAC-SH84DM-E
PCFY-P100,125VKM-E	PAC-SH90KF-E	PAR-SL94B-E	PAC-SH84DM-E

8-2. High efficiency filter

Material: PP honeycomb Gravimetric method: 70%			
Item	PAC-SH88KF-E	PAC-SH89KF-E	PAC-SH90KF-E
Quantity	2 (Small)	1 (Small), 2 (Large)	2 (Large)
Shape			

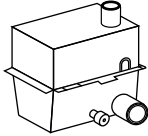
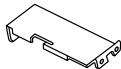
8-3. Drain pump

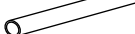
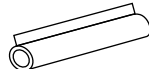
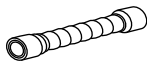
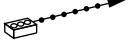
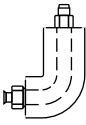
If drain water can not flow out the Indoor unit by gravity and gradient, a Drain-pump for draining is needed.
Drain pump PAC-SH-DM-E can pump water up to 600 mm high from the ceiling.

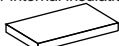
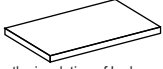
Item	① Drain lift up mechanism	② Attachment	③ Screws (4×10)	④ VP-20 pipe	⑤ Pipe cover
Quantity	1	1	6	1	1
Shape		 1 Drain lift up mechanism fixture	 For the installation of drain lift up mechanism 1		 For insulation of VP20 pipe4
Item	⑥ Flexible hose	⑦ Fastener	⑧ L-shaped pipe (gas pipe)	⑨ L-shaped pipe (liquid pipe)	⑩ Insulator A
Quantity	1	1	1	1	2
Shape					6t×220×80 (For internal insulation)  For the insulation of L-shaped pipes ⑧ and ⑨ and the refrigerant pipes.
Item	⑪ Insulator B				
Quantity	2				
Shape	3t×250×120 (For external insulation)  For the insulation of L-shaped pipes ⑧ and ⑨ and the refrigerant pipes.				

Detailed installation information should be referred to its Installation Manual.

8-4. Wireless remote controller kit

Wireless remote controller receiver is built-in type.

Item	① Wireless remote controller receiver	② Wireless remote controller	③ Remote control holder	④ "AAA" LR3 alkaline batterie	⑤ 4.1 x 16 wood screw
Quantity	1	1	1	2	2
Item	⑥ Cord retaining clips	⑦ Connection cord fixing seal (12x30 size)			
Quantity	2	1			

Detailed installation information should be referred to its Installation Manual.

PKFY-P-VBM-E, PKFY-P-VHM-E, PKFY-P-VKM-E

1. SPECIFICATIONS 1 - 166

2. EXTERNAL DIMENSIONS 1 - 168

3. CENTER OF GRAVITY 1 - 171

4. ELECTRICAL WIRING DIAGRAMS 1 - 172

5. SOUND LEVELS 1 - 175

 5-1. Sound levels 1 - 175

 5-2. NC curves 1 - 175

6. TEMPERATURE/AIRFLOW DISTRIBUTIONS 1 - 176

 6-1. Temperature distributions 1 - 176

 6-2. Airflow distributions 1 - 177

7. OPTIONAL PARTS..... 1 - 178

 7-1. Optional parts line up for the Indoor unit..... 1 - 178

 7-2. External LEV Box..... 1 - 178

 7-3. Drain pump 1 - 178

1. SPECIFICATIONS

YKB/YLM

Model		PKFY-P15VBM-E	PKFY-P20VBM-E	PKFY-P25VBM-E	PKFY-P32VHM-E		
Power source		1-phase 220-240V 50Hz, 1-phase 220V 60Hz	1-phase 220-240V 50Hz, 1-phase 220V 60Hz	1-phase 220-240V 50Hz, 1-phase 220V 60Hz	1-phase 220-240V 50Hz, 1-phase 220V 60Hz		
Cooling capacity (Nominal)	*1 kW	1.7	2.2	2.8	3.6		
	*1 kcal / h	1,450	1,900	2,400	3,100		
	*1 BTU / h	5,800	7,500	9,600	12,300		
	*2 kcal / h	1,500	2,000	2,500	3,150		
	(220V) Power input	*4 kW	0.04	0.04	0.04	0.04	
(220V) Current input	*4 A	0.20	0.20	0.20	0.40		
Heating capacity (Nominal)	*3 kW	1.9	2.5	3.2	4.0		
	*3 kcal / h	1,600	2,200	2,800	3,400		
	*3 BTU / h	6,500	8,500	10,900	13,600		
	(220V) Power input	kW	0.04	0.04	0.04	0.03	
	(220V) Current input	A	0.20	0.20	0.20	0.30	
External finish		Plastic, MUNSELL (1.0Y 9.2/0.2)	Plastic, MUNSELL (1.0Y 9.2/0.2)	Plastic, MUNSELL (1.0Y 9.2/0.2)	Plastic, MUNSELL (1.0Y 9.2/0.2)		
External dimension HxWxD		mm 295x815x225	mm 295x815x225	mm 295x815x225	mm 295x898x249		
		in. 11-5/8 x 32-1/8 x 8-7/8	in. 11-5/8 x 32-1/8 x 8-7/8	in. 11-5/8 x 32-1/8 x 8-7/8	in. 11-5/8 x 35-3/8 x 9-13/16		
Net weight		kg(lbs)	10 (23)	10 (23)	13(29)		
Heat exchanger		Cross fin (Aluminum fin and copper tube)	Cross fin (Aluminum fin and copper tube)	Cross fin (Aluminum fin and copper tube)	Cross fin (Aluminum fin and copper tube)		
FAN	Type x Quantity		Line flow fan x 1	Line flow fan x 1	Line flow fan x 1	Line flow fan x 1	
	External static press.	Pa	0	0	0	0	
		mmH ₂ O	0	0	0	0	
	Motor Type		1-phase induction motor	1-phase induction motor	1-phase induction motor	DC motor	
	Motor output		kW	0.017	0.017	0.017	0.030
	Driving mechanism		Direct-driven by motor	Direct-driven by motor	Direct-driven by motor	Direct-drive	
	Airflow rate (Low-Mid2-Mid-High)	m ³ / min		4.9-5.0-5.2-5.3	4.9-5.2-5.6-5.9	4.9-5.2-5.6-5.9	9-10-11
		L/s		82-83-87-88	82-87-93-98	82-87-93-98	150-167-183
cfm		173-177-184-187	173-184-198-208	173-184-198-208	318-353-388		
Sound pressure level (measured in anechoic room)		dB <A>	29-31-32-33	29-31-34-36	29-31-34-36	34-37-41	
Insulation material		Polyethylene sheet	Polyethylene sheet	Polyethylene sheet	Polyethylene sheet		
Air filter		PP honeycomb	PP honeycomb	PP honeycomb	PP honeycomb		
Protection device		Fuse	Fuse	Fuse	Fuse		
Refrigerant control device		LEV	LEV	LEV	LEV		
Connectable outdoor unit		R410A CITY MULTI	R410A CITY MULTI	R410A CITY MULTI	R410A CITY MULTI		
Diameter of refrigerant pipe	Liquid (R410A)	mm(in.)	6.35(1/4) Flare	6.35(1/4) Flare	6.35(1/4) Flare	6.35(1/4) Flare	
	Gas (R410A)	mm(in.)	12.70(1/2) Flare	12.70(1/2) Flare	12.70(1/2) Flare	12.70(1/2) Flare	
Field drain pipe size		mm(in.)	I.D. 16(5/8)	I.D. 16(5/8)	I.D. 16(5/8)	I.D. 16(5/8)	
Drawing	External		-	-	-	-	
	Wiring		-	-	-	-	
	Refrigerant cycle		-	-	-	-	
Standard attachment	Document		Installation Manual, Instruction Book	Installation Manual, Instruction Book	Installation Manual, Instruction Book	Installation Manual, Instruction Book	
	Accessory		-	-	-	-	
Optional parts	External LEV Box		PAC-SG95LE-E	PAC-SG95LE-E	PAC-SG95LE-E	-	
	Drain pump		-	-	-	PAC-SH75DM-E	
Remarks		* Details on foundation work, duct work, insulation work, electrical wiring, power source switch, and other items shall be referred to the Installation Manual. * Due to continuing improvement, above specification may be subject to change without notice.					

Notes:	*1 Nominal cooling conditions (subject to JIS B8615-1)	*2 Nominal cooling conditions	*3 Nominal heating conditions (subject to JIS B8615-1)	Unit converter
Indoor:	27degC D.B. / 19degC W.B. (81degF D.B. / 66degF W.B.)	27degC D.B. / 19.5degC W.B. (81degF D.B. / 67degF W.B.)	20degC D.B. (68degF D.B.)	kcal/h = kW x 860
Outdoor:	35degC D.B. (95degF D.B.)	35degC D.B. (95degF D.B.)	7degC D.B. / 6degC W.B. (45degF D.B. / 43degF W.B.)	BTU/h = kW x 3,412
Pipe length:	7.5 m (24-9/16 ft.)	5 m (16-3/8 ft.)	7.5 m (24-9/16 ft.)	cfm = m ³ /min x 35.31
Level difference:	0 m (0 ft.)	0 m (0 ft.)	0 m (0 ft.)	lbs = kg / 0.4536
				*The specification data is subject to rounding variation.
*4 Electrical characteristic of cooling are included optional drain-pump. (Applicable only to PKFY-P32VHM-E)				

PKFY

1. SPECIFICATIONS

YKB/YLM

Model			PKFY-P40VHM-E	PKFY-P50VHM-E	PKFY-P63VKM-E	PKFY-P100VKM-E	
Power source			1-phase 220-240V 50Hz, 1-phase 220V 60Hz	1-phase 220-240V 50Hz, 1-phase 220V 60Hz	1-phase 220-240V 50Hz, 1-phase 220V 60Hz	1-phase 220-240V 50Hz, 1-phase 220V 60Hz	
Cooling capacity (Nominal)	*1	kW	4.5	5.6	7.1	11.2	
		kcal / h	3,900	4,800	6,100	9,600	
		BTU / h	15,400	19,100	24,200	38,200	
	(220V)	*4	Power input kW	0.04	0.04	0.05	0.08
			Current input A	0.40	0.40	0.37	0.58
Heating capacity (Nominal)	*3	kW	5.0	6.3	8.0	12.5	
		kcal / h	4,300	5,400	6,900	10,800	
		BTU / h	17,100	21,500	27,300	42,600	
	(220V)	*4	Power input kW	0.03	0.03	0.04	0.07
			Current input A	0.30	0.30	0.30	0.51
External finish			Plastic, MUNSELL (1.0Y 9.2/0.2)	Plastic, MUNSELL (1.0Y 9.2/0.2)	Plastic, MUNSELL (1.0Y 9.2/0.2)	Plastic, MUNSELL (1.0Y 9.2/0.2)	
External dimension HxWxD			mm	295x898x249	295x898x249	365x1170x295	
			in.	11-5/8 x 35-3/8 x 9-13/16	11-5/8 x 35-3/8 x 9-13/16	14-3/8 x 46-1/16 x 11-5/8	14-3/8 x 46-1/16 x 11-5/8
Net weight			kg(lbs)	13(29)	13(29)	21(46)	
Heat exchanger			Cross fin (Aluminum fin and copper tube)	Cross fin (Aluminum fin and copper tube)	Cross fin (Aluminum fin and copper tube)	Cross fin (Aluminum fin and copper tube)	
FAN	Type x Quantity		Line flow fan x 1	Line flow fan x 1	Line flow fan x 1	Line flow fan x 1	
	External static press.	Pa	0	0	0	0	
		mmH ₂ O	0	0	0	0	
	Motor Type		DC motor	DC motor	DC motor	DC motor	
	Motor output	kW	0.030	0.030	0.056	0.056	
	Driving mechanism		Direct-drive	Direct-drive	Direct-drive	Direct-drive	
	Airflow rate (Low-Mid2-Mid-High)	m ³ / min	9-10.5-11.5	9-10.5-12	16-20	20-26	
L/s		150-175-192	150-175-200	267-333	333-433		
cfm		318-371-406	318-371-424	565-706	706-918		
Sound pressure level (measured in anechoic room)			dB <A>	34-38-41	34-39-43	39-45	
Insulation material			Polyethylene sheet	Polyethylene sheet	Polyethylene sheet	Polyethylene sheet	
Air filter			PP honeycomb	PP honeycomb	PP honeycomb	PP honeycomb	
Protection device			Fuse	Fuse	Fuse	Fuse	
Refrigerant control device			LEV	LEV	LEV	LEV	
Connectable outdoor unit			R410A CITY MULTI	R410A CITY MULTI	R410A CITY MULTI	R410A CITY MULTI	
Diameter of refrigerant pipe	Liquid (R410A)	mm(in.)	6.35(1/4) Flare	6.35(1/4) Flare	9.52(3/8) Flare	9.52(3/8) Flare	
	Gas (R410A)	mm(in.)	12.70(1/2) Flare	12.70(1/2) Flare	15.88(5/8) Flare	15.88(5/8) Flare	
Field drain pipe size			mm(in.)	I.D. 16(5/8)	I.D. 16(5/8)	I.D. 16(5/8)	
Drawing	External		-	-	-	-	
	Wiring		-	-	-	-	
	Refrigerant cycle		-	-	-	-	
Standard attachment	Document		Installation Manual, Instruction Book	Installation Manual, Instruction Book	Installation Manual, Instruction Book	Installation Manual, Instruction Book	
	Accessory		-	-	-	-	
Optional parts	External LEV Box		PAC-SG95LE-E	PAC-SG95LE-E	PAC-SG95LE-E	-	
	Drain pump		PAC-SH75DM-E	PAC-SH75DM-E	PAC-SH94DM-E	PAC-SH94DM-E	
Remarks			* Details on foundation work, duct work, insulation work, electrical wiring, power source switch, and other items shall be referred to the Installation Manual. * Due to continuing improvement, above specification may be subject to change without notice.				

Notes:	*1 Nominal cooling conditions (subject to JIS B8615-1)	*2 Nominal cooling conditions	*3 Nominal heating conditions (subject to JIS B8615-1)	Unit converter
	Indoor: 27degC D.B. / 19degC W.B. (81degF D.B. / 66degF W.B.)	27degC D.B. / 19.5degC W.B. (81degF D.B. / 67degF W.B.)	20degC D.B. (68degF D.B.)	kcal/h = kW x 860
	Outdoor: 35degC D.B. (95degF D.B.)	35degC D.B. (95degF D.B.)	7degC D.B. / 6degC W.B. (45degF D.B. / 43degF W.B.)	BTU/h = kW x 3,412
	Pipe length: 7.5 m (24-9/16 ft.)	5 m (16-3/8 ft.)	7.5 m (24-9/16 ft.)	cfm = m3/min x 35.31
	Level difference: 0 m (0 ft.)	0 m (0 ft.)	0 m (0 ft.)	lbs = kg / 0.4536
	*The specification data is subject to rounding variation.			
*4 Electrical characteristic of cooling are included optional drain-pump.				

PKFY-P15, 20, 25VBM-E

Unit : mm

Detail of installation plate

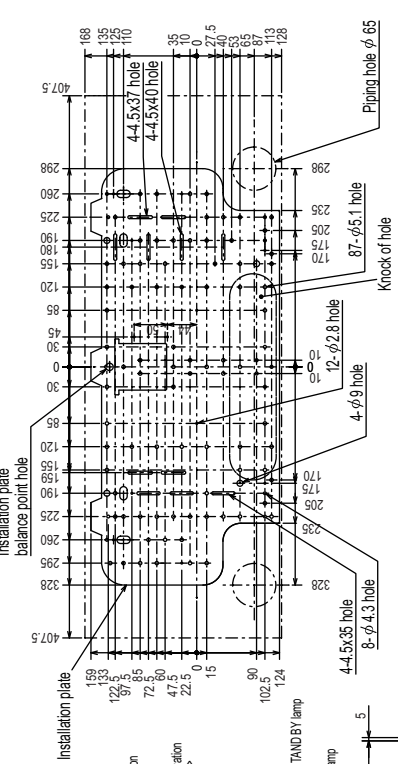

Installation space

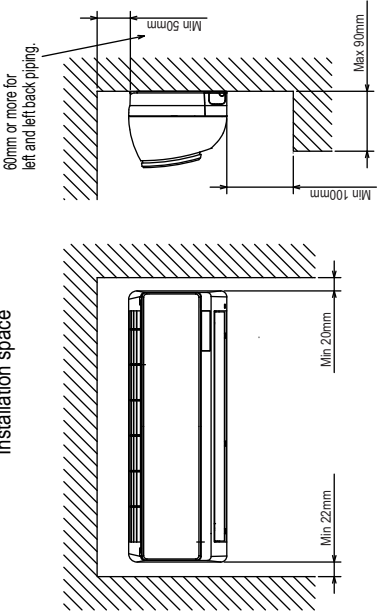

PKFY

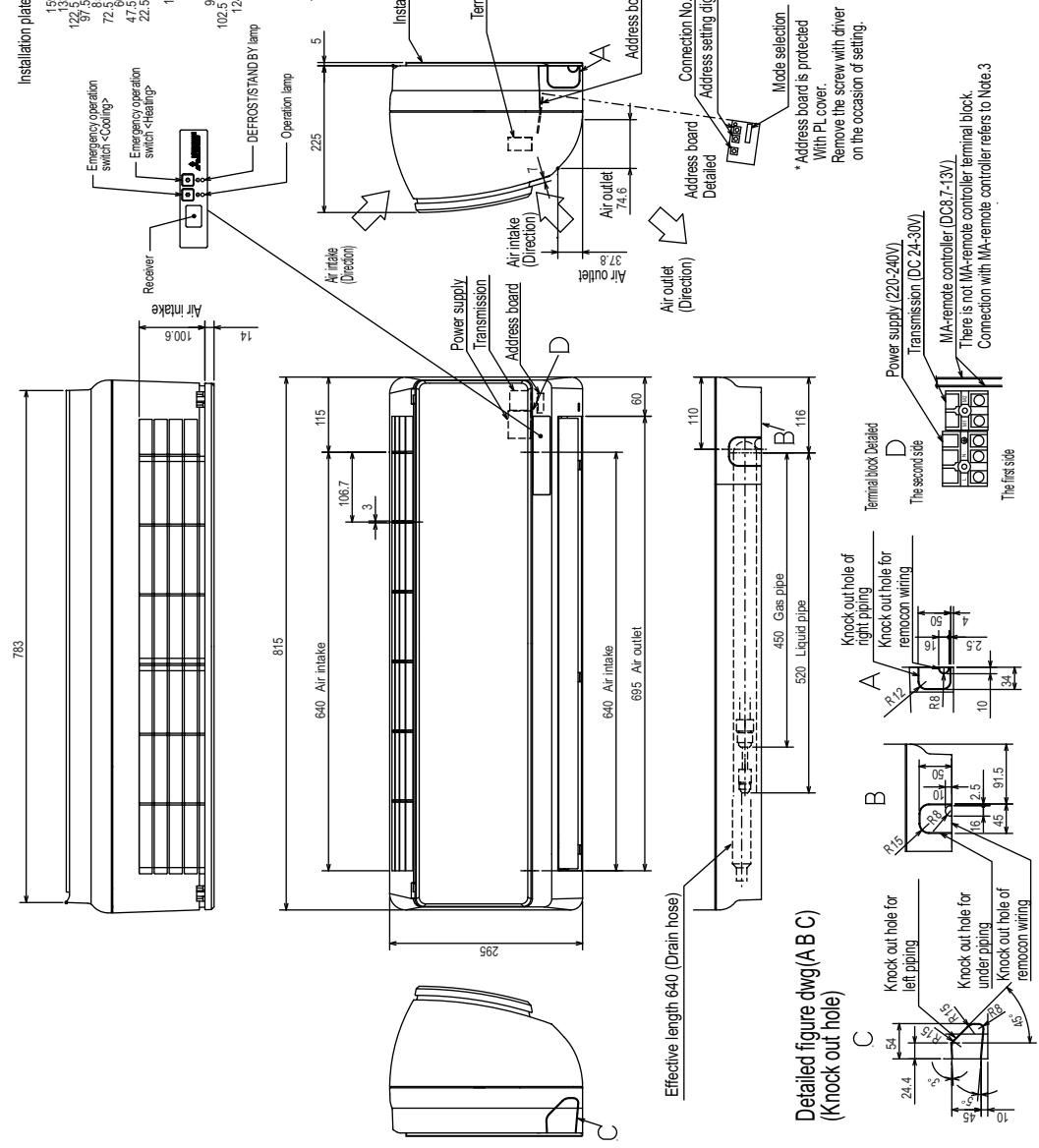

Effective length 640 (Drain hose)

Detailed figure dwg(A B C)
(Knock out hole)

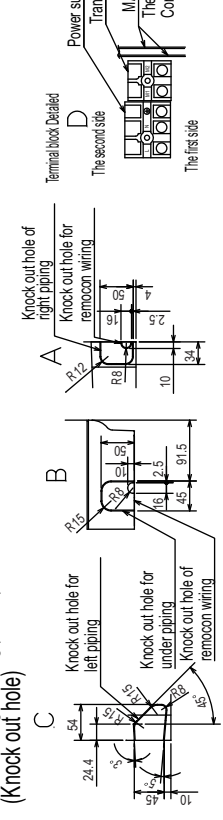

- Note.1 Use M10 or W3/8 screw for installation plate.
- Note.2 Extension piping side.
- Note.3 In case of connecting MA-remote controller, please connect MA-remote controller cable (accessory) to the connector.

Refrigerant piping	Liquid pipe	1/4F (φ 6.35mm)
	Gas pipe	1/2F (φ 12.7mm)
	Drain pipe	φ 16mm(LD)

* Address board is protected With PL cover. Remove the screw with driver on the occasion of setting.

MA-remote controller (DC8.7-13V)
There is not MA-remote controller terminal block. Connection with MA-remote controller refers to Note.3

PKFY-P63, 100VKM-E

Unit : mm

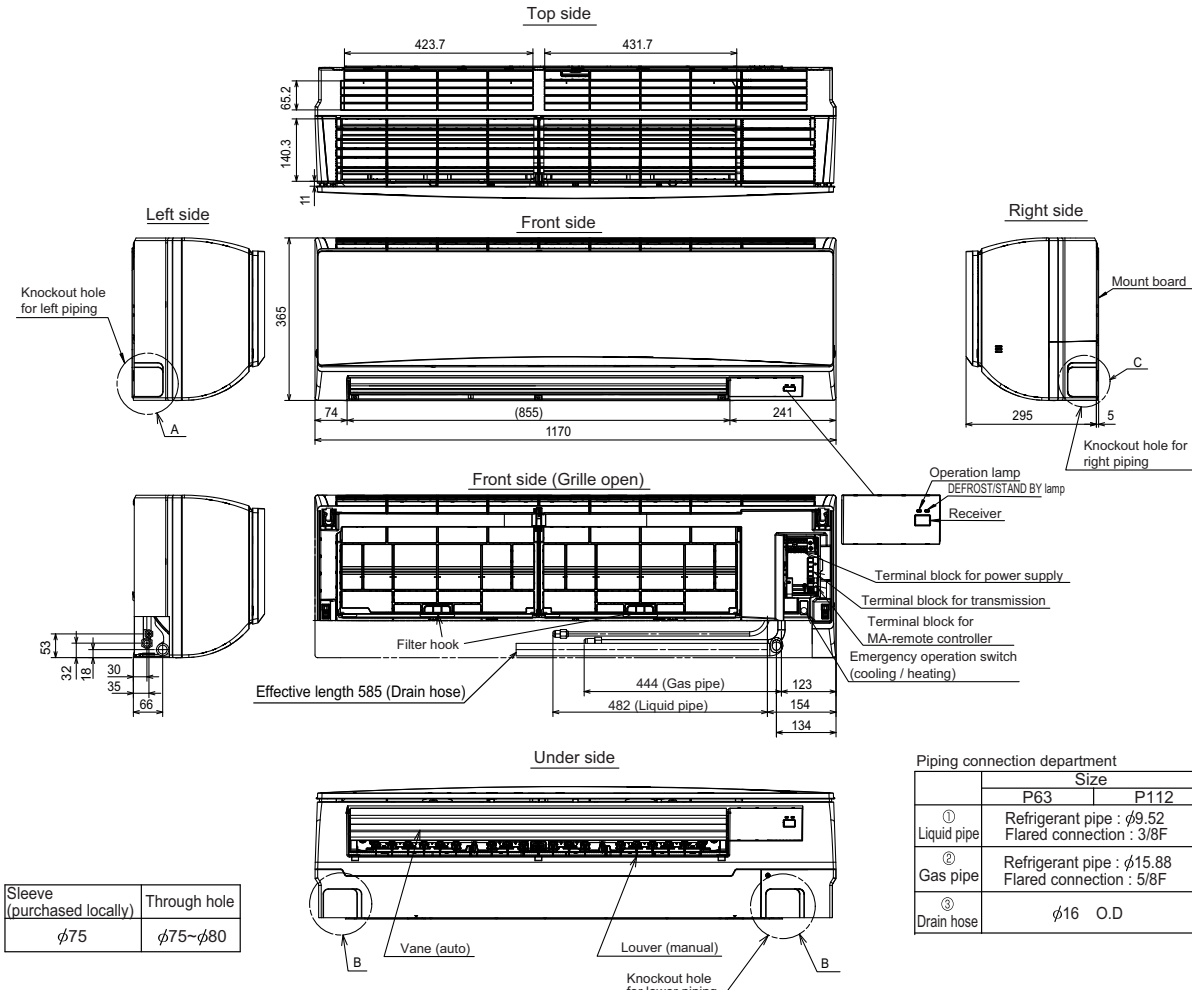

Sleeve (purchased locally)	Through hole
φ75	φ75~φ80

	Piping connection department	
	P63	P112
① Liquid pipe	Refrigerant pipe : φ9.52 Flared connection : 3/8F	
② Gas pipe	Refrigerant pipe : φ15.88 Flared connection : 5/8F	
③ Drain hose	φ16 O.D	

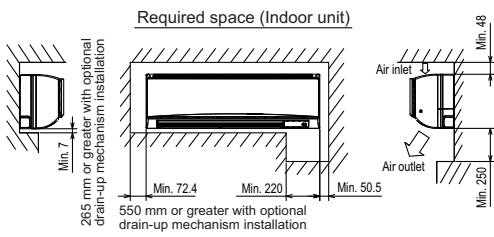
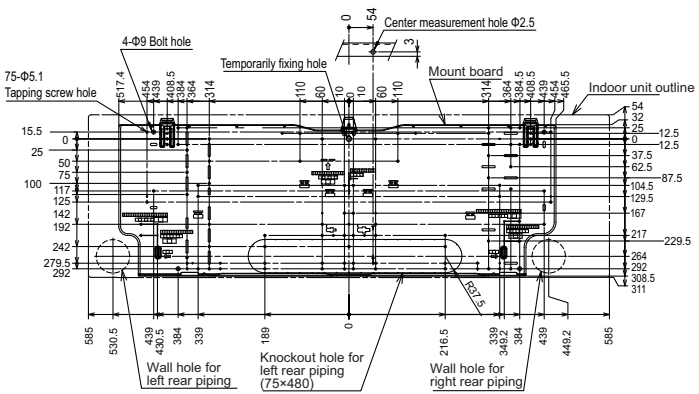
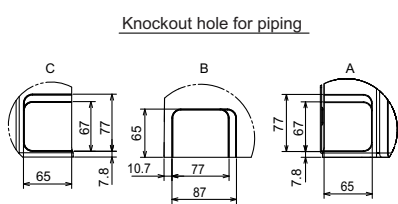

108 mm or greater with left or rear left piping or drain-up mechanism installation

PKFY

PKFY-P-VBM-E, VHM-E, VKM-E

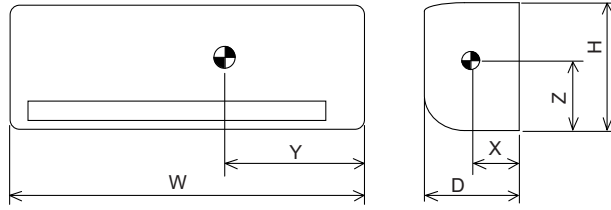

Model	W	D	H	X	Y	Z
PKFY-P15VBM-E	815	225	295	120	300	150
PKFY-P20VBM-E	815	225	295	120	300	150
PKFY-P25VBM-E	815	225	295	120	300	150
PKFY-P32VHM-E	898	249	295	120	390	160
PKFY-P40VHM-E	898	249	295	120	390	160
PKFY-P50VHM-E	898	249	295	120	390	160
PKFY-P63VKM-E	1170	295	365	190	460	190
PKFY-P100VKM-E	1170	295	365	190	460	190

PKFY-P15, 20, 25VBM-E

Legend

Symbol	Name	Symbol	Name	Symbol	Name
I.B	Indoor controller board	MV	Vane motor	SW5	Switch
CN32	Connector	LEV	Linear expansion valve	SW11	Address setting 1s digit
CN51	Centrally control	TB2	Terminal block	SW12	Address setting 10ths digit
CN52	Remote indication	TB5	Terminal block	SW14	Branch No.
CN105	IT Terminal	TH21	Thermistor	W.B	Wireless remote controller board
SW2	Switch	TH22	Room temp,detection (0°C/15kΩ,25°C/5.4kΩ)	RU	Receiving unit
SW3	Capacity code	TH23	Pipe temp,detection/Liquid (0°C/15kΩ,25°C/5.4kΩ)	BZ	Buzzer
P.B	Indoor power board	TH23	Pipe temp,detection/Gas (0°C/15kΩ,25°C/5.4kΩ)	LED1	LED (Operation indicator:Green)
FUSE	Fuse (T6.3AL 250V)	A.B	Address board	LED2	LED (Preparation for heating:Orange)
F.C	Fan phase control	SW1	Switch	SW1	Emergency operation (Heat)
C1	Capacitor (Fan motor)	SW2	Mode selection	SW2	Emergency operation (Cool)
MF	Fan motor				

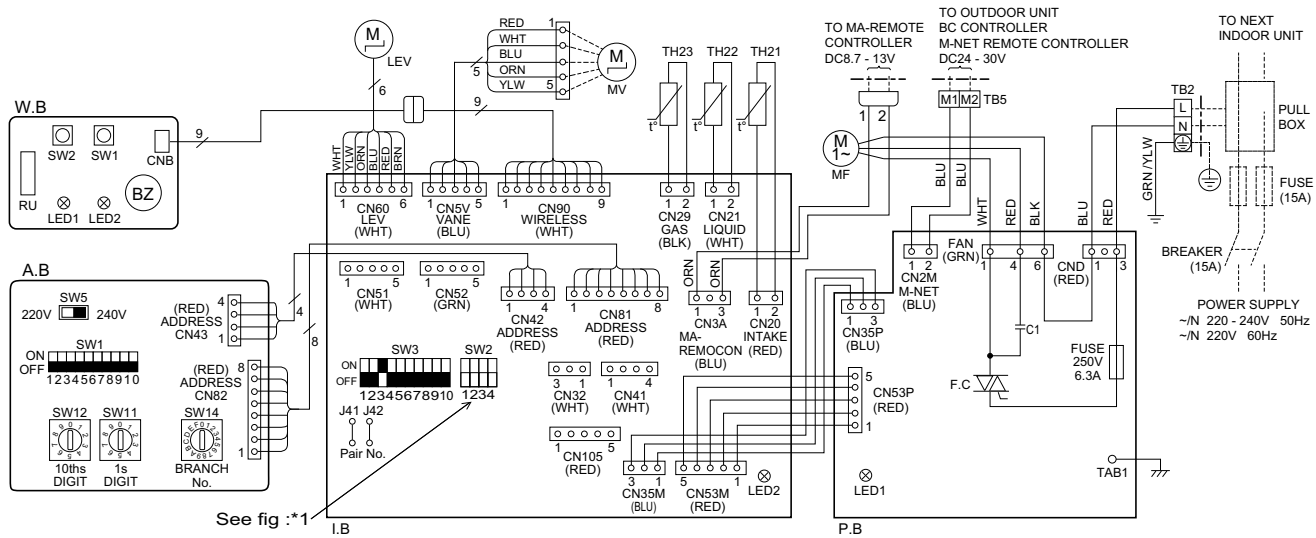

Note

- At servicing for outdoor unit, always follow the wiring diagram of outdoor unit.
- In case of using MA-remote controller, please connect MA remote controller cable in an accessory to the connector (Remote controller wire is non-polar.)
- In case of using M-NET, please connect to TB5 (Transmission line is non-polar.)
- Symbols used in wiring diagram above are, : terminal block, : connector
- The setting of the SW2 dip switches differs in the capacity. For the detail, refer to the fig : *1.
- Please set the switch SW5 according to the power supply voltage.
Set SW5 to 240V side when the power supply is 230 and 240 volts.
When the power supply is 220 volts, set SW5 to 220V side.

LED on indoor board for service

Mark	Meaning	Function
LED1	Main power supply	Main power supply (Indoor unit : 220-240V) power on → lamp is lit
LED2	Power supply for MA-Remote controller	Power supply for MA-Remote controller on → lamp is lit

The black square (■) indicates a switch position. <*1>

Models	SW2	Models	SW2	Models	SW2
P15	ON OFF	P20	ON OFF	P25	ON OFF

PKFY-P32, 40, 50VHM-E

SYMBOL	NAME	SYMBOL	NAME
I.B	INDOOR CONTROLLER BOARD	TH21	THERMISTOR ROOM TEMP. DETECTION (0°C/15kΩ, 25°C/5.4kΩ)
CN32	CONNECTOR REMOTE SWITCH	TH22	PIPE TEMP. DETECTION / LIQUID (0°C/15kΩ, 25°C/5.4kΩ)
CN51	CENTRALLY CONTROL	TH23	PIPE TEMP. DETECTION / GAS1 (0°C/15kΩ, 25°C/5.4kΩ)
CN52	REMOTE INDICATION	TH24	PIPE TEMP. DETECTION / GAS2 (0°C/15kΩ, 25°C/5.4kΩ)
CN100	IT TERMINAL	A.B	ADDRESS BOARD
BZ1	BUZZER	SWA	SWITCH FAN SPEED SELECTOR
FUSE	FUSE (T3.15AL 250V)	SW1	SWITCH MODE SELECTION
LED1	POWER SUPPLY (I.B)	SW11	SWITCH ADDRESS SETTING 1s DIGIT
LED2	POWER SUPPLY (I.B)	SW12	SWITCH ADDRESS SETTING 10ths DIGIT
SW2	SWITCH CAPACITY CODE	SW14	SWITCH BRANCH No.
SW3	MODE SELECTION	S.B	SWITCH BOARD
SW4	MODEL SELECTOR	SWE1	EMERGENCY OPERATION (HEAT)
SWE	DRAIN PUMP (TEST MODE)	SWE2	EMERGENCY OPERATION (COOL)
X1	AUX.RELAY DRAIN PUMP (OPTION)	W.B	PCB FOR WIRELESS REMOTE CONTROLLER
LEV	LINEAR EXPANSION VALVE	LED1	LED (OPERATION INDICATOR: GREEN)
MF	FAN MOTOR	LED2	LED (PREPARATION FOR HEATING: ORANGE)
MV	VANE MOTOR	RU	RECEIVING UNIT
TB2	TERMINAL POWER SUPPLY	DP	DRAIN PUMP (OPTION)
TB5	BLOCK TRANSMISSION	FS	DRAIN FLOAT SWITCH (OPTION)
TB15	BLOCK MA-REMOTE CONTROLLER		

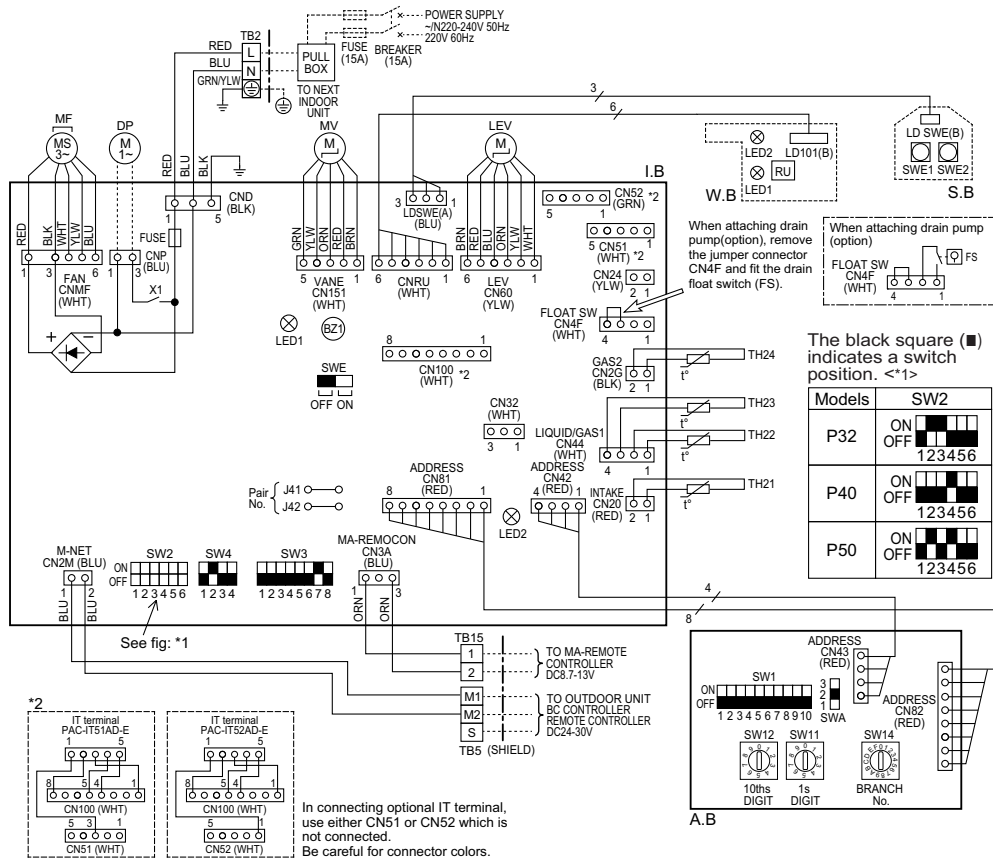

NOTES:

- At servicing for outdoor unit, always follow the wiring diagram of outdoor unit.
- In case of using MA-Remote controller, please connect to TB15. (Remote controller wire is non-polar.)
- In case of using M-NET, please connect to TB5. (Transmission line is non-polar.)
- Symbol [S] of TB5 is the shield wire connection.
- Symbols used in wiring diagram above are, [] : terminal block, [] : connector.
- The setting of the SW2 dip switches differs in the capacity. For the detail, refer to the fig: *1.

LED on indoor board for service

Mark	Meaning	Function
LED1	Main power supply	Main power supply (Indoor unit:220-240V) Power on → lamp is lit
LED2	Power supply for MA-Remote controller	Power supply for MA-Remote controller on → lamp is lit

PKFY

PKFY-P63, 100VKM-E

SYMBOL	NAME	SYMBOL	NAME
I.B	INDOOR CONTROLLER BOARD	TH21	THERMISTOR ROOM TEMP. DETECTION (0°C/15kΩ, 25°C/5.4kΩ)
CN32	CONNECTOR REMOTE SWITCH	TH22	PIPE TEMP. DETECTION / LIQUID (0°C/15kΩ, 25°C/5.4kΩ)
CN51	CENTRALLY CONTROL	TH23	PIPE TEMP. DETECTION / GAS1 (0°C/15kΩ, 25°C/5.4kΩ)
CN52	REMOTE INDICATION	TH24	PIPE TEMP. DETECTION / GAS2 (0°C/15kΩ, 25°C/5.4kΩ)
CN100	IT TERMINAL	A.B	ADDRESS BOARD
BZ1	BUZZER	SWA	SWITCH FAN SPEED SELECTOR
FUSE	FUSE (T3.15AL 250V)	SW1	MODE SELECTION
LED1	POWER SUPPLY(I.B)	SW11	ADDRESS SETTING 1s DIGIT
LED2	POWER SUPPLY(I.B)	SW12	ADDRESS SETTING 10ths DIGIT
SW2	SWITCH CAPACITY CODE	SW14	BRANCH No.
SW3	MODE SELECTION	S.B	SWITCH BOARD
SW4	MODEL SELECTOR	SWE1	EMERGENCY OPERATION(HEAT)
SWE	DRAIN PUMP(TEST MODE)	SWE2	EMERGENCY OPERATION(COOL)
X1	AUX.RELAY DRAIN PUMP(OPTION)	W.B	PCB FOR WIRELESS REMOTE CONTROLLER
LEV	LINEAR EXPANSION VALVE	LED1	LED(OPERATION INDICATOR:GREEN)
MF	FAN MOTOR	LED2	LED(PREPARATION FOR HEATING : ORANGE)
MV	VANE MOTOR	RU	RECEIVING UNIT
TB2	TERMINAL POWER SUPPLY	DP	DRAIN PUMP (OPTION)
TB5	BLOCK TRANSMISSION	FS	DRAIN FLOAT SWITCH (OPTION)
TB15	BLOCK MA-REMOTE CONTROLLER		

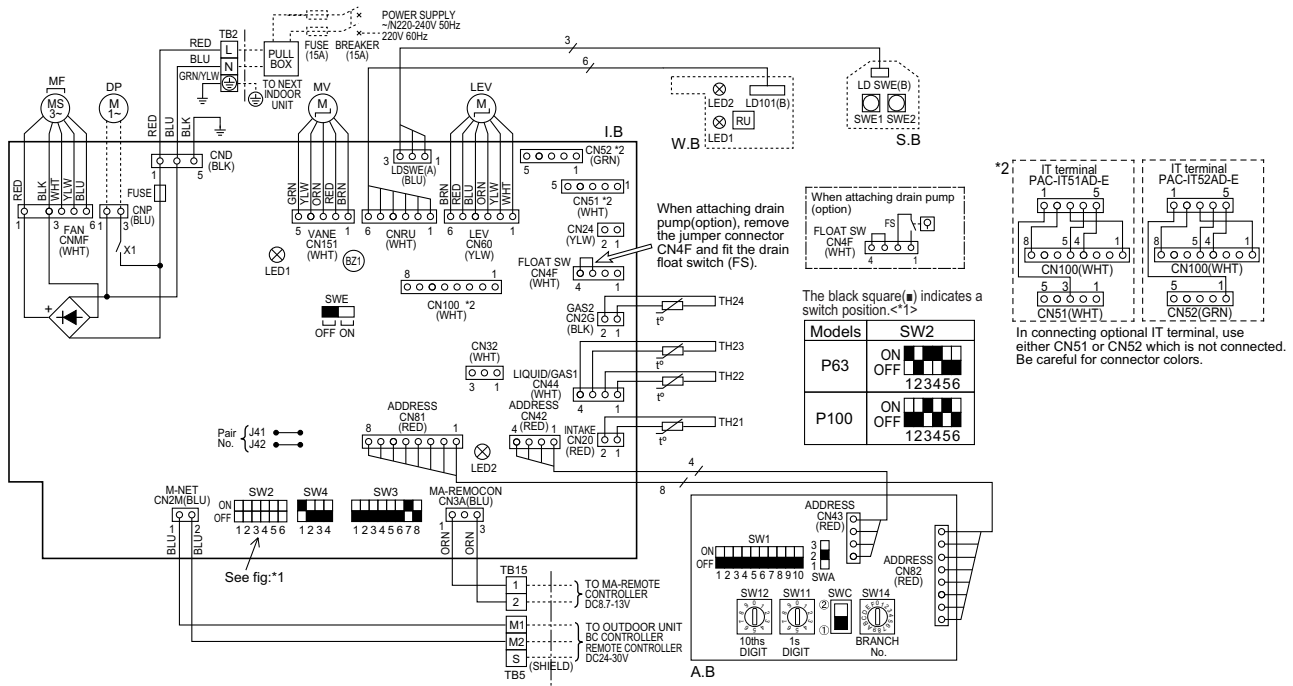

NOTES:

1. At servicing for outdoor unit, always follow the wiring diagram of outdoor unit.
2. In case of using MA-Remote controller, please connect to TB15. (Remote controller wire is non-polar.)
3. In case of using M-NET, please connect to TB5. (Transmission line is non-polar.)
4. Symbol [S] of TB5 is the shield wire connection.
5. Symbols used in wiring diagram above are, : terminal block, : connector.
6. The setting of the SW2 dip switches differs in the capacity. For the detail, refer to the fig.*1.

LED on indoor board for service

Mark	Meaning	Function
LED1	Main power supply	Main power supply (Indoor unit:220-240V) Power on → lamp is lit
LED2	Power supply for MA-Remote controller	Power supply for MA-Remote controller Power on → lamp is lit

5-1. Sound levels

Wall mounted

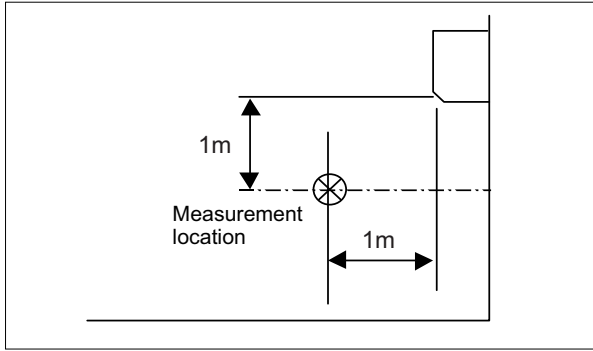

Sound level at anechoic room : Low-(Middle2-Middle)-High

Model	Sound level dB (A)
PKFY-P15VBM-E	29-31-32-33
PKFY-P20VBM-E PKFY-P25VBM-E	29-31-34-36
PKFY-P32VHM-E	34-37-41
PKFY-P40VHM-E	34-38-41
PKFY-P50VHM-E	34-39-43
PKFY-P63VKM-E	39-45
PKFY-P100VKM-E	41-49

* Measured in anechoic room.

5-2. NC curves

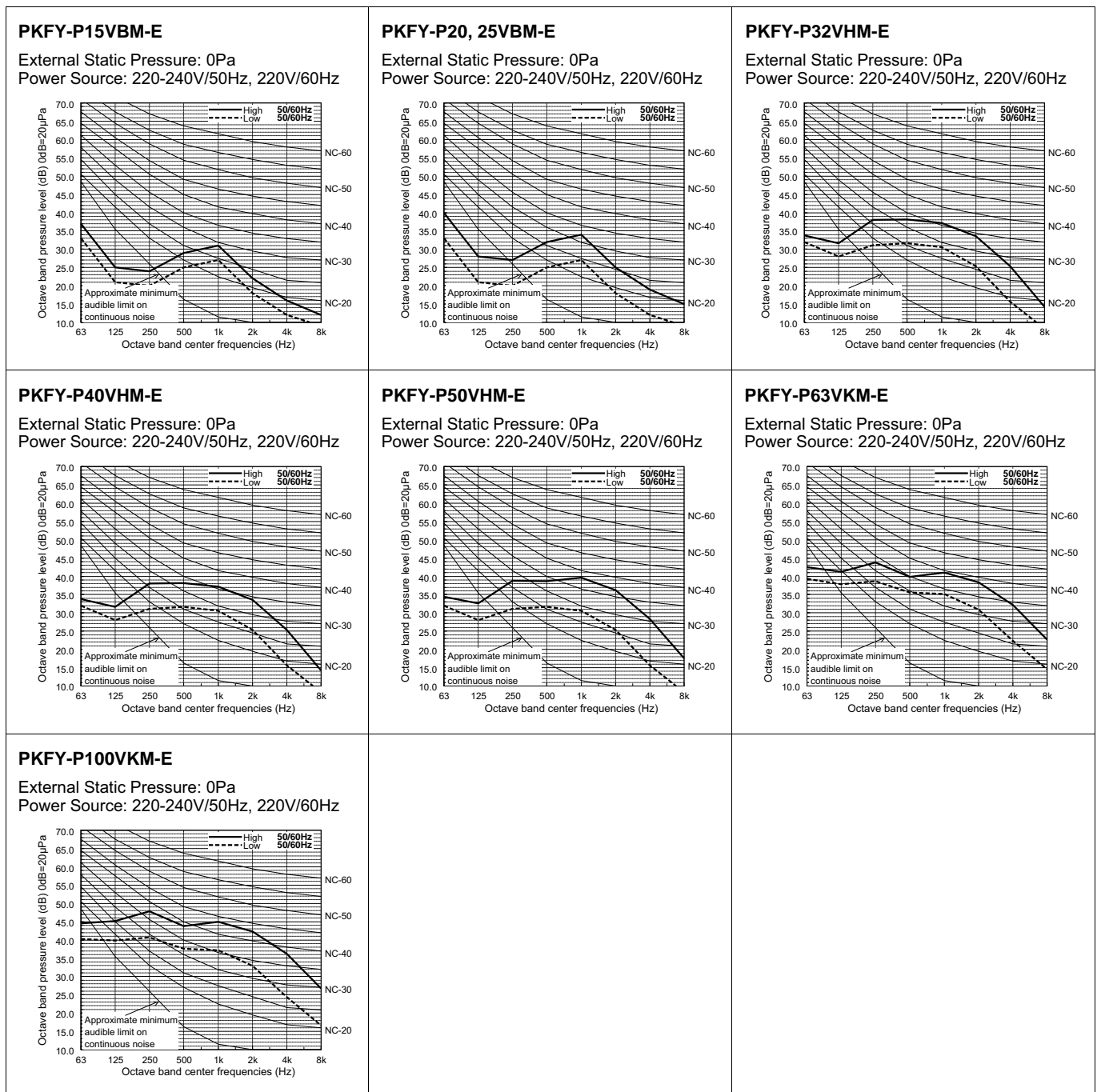

PKFY

6-1. Temperature distributions

PKFY-P15-25VBM-E

<Cooling mode>
Horizontal air flow

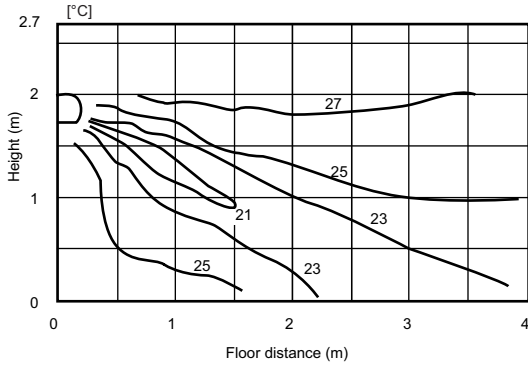

<Heating mode>
Downward air flow

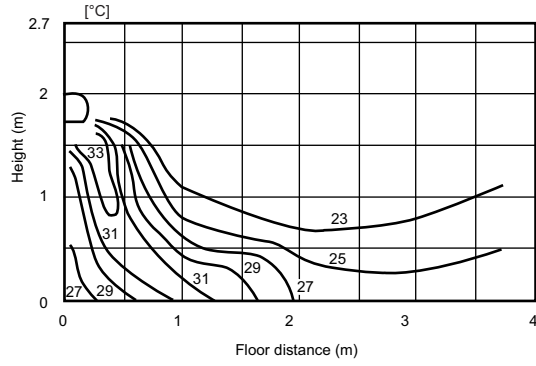

PKFY-P32-50VHM-E

<Cooling mode>
Horizontal air flow

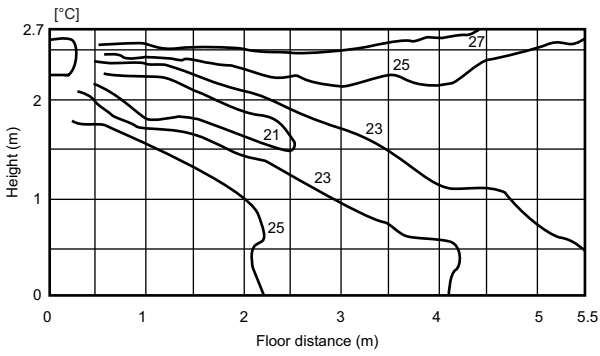

<Heating mode>
Downward air flow

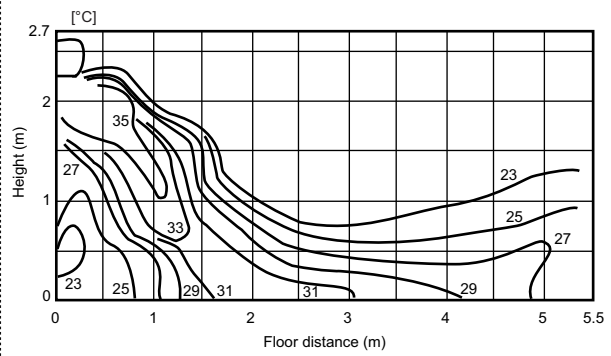

PKFY-P63, 100VKM-E

<Cooling mode>
Horizontal air flow

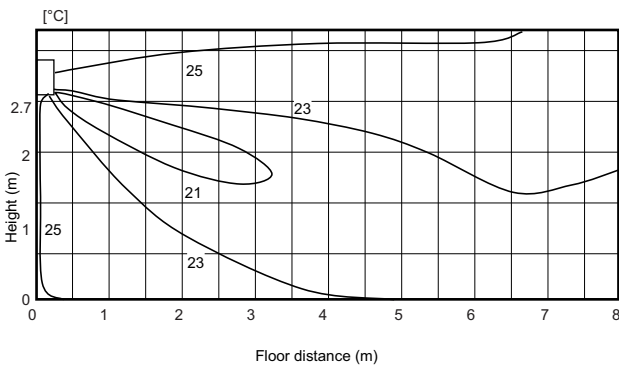

<Heating mode>
Downward air flow

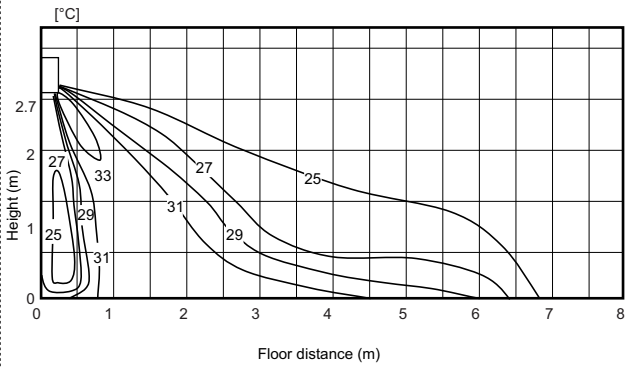

Note : These figures show typical temperature distributions in the conditions above. In the actual installation, they may differ from these figures under the influence of air temperature conditions, ceiling height, cooling/heating load, obstacles, etc.

PKFY

6-2. Airflow distributions

PKFY-P15-25VBM-E

<Fan mode>
Horizontal air flow

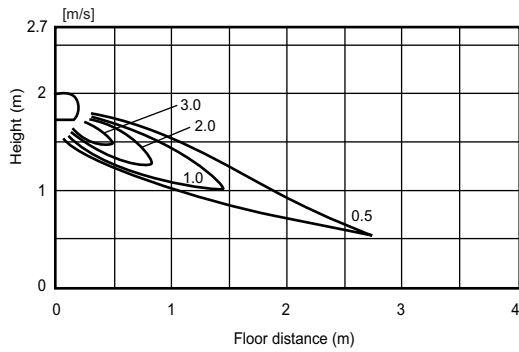

<Fan mode>
Downward air flow

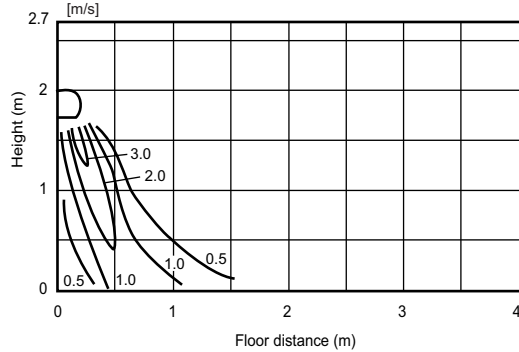

PKFY-P32-50VHM-E

<Fan mode>
Horizontal air flow

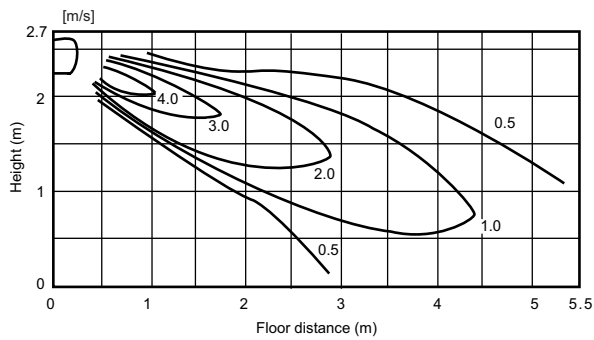

<Fan mode>
Downward air flow

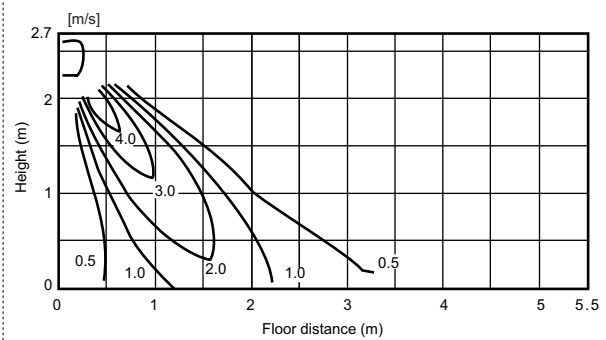

PKFY-P63, 100VKM-E

<Fan mode>
Horizontal air flow

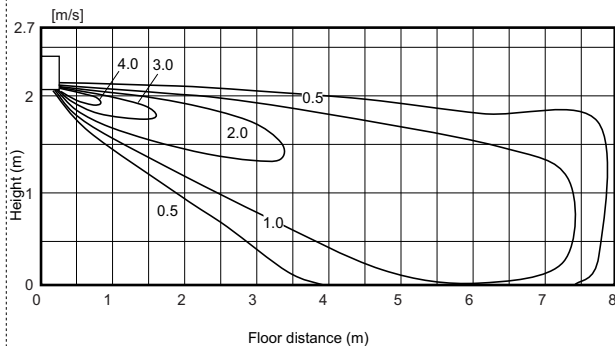

<Fan mode>
Downward air flow

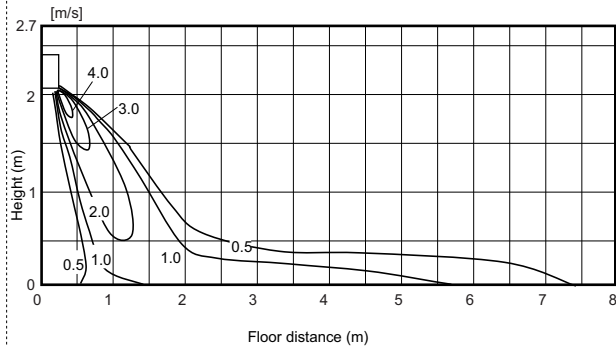

Note : These figures show typical airflow distributions in the conditions above. In the actual installation, they may differ from these figures under the influence of air temperature conditions, ceiling height, cooling/heating load, obstacles, etc.

7-1. Optional parts line up for the Indoor unit

	External LEV Box	Drain pump
PKFY-P15, 20, 25VBM-E	PAC-SG95LE-E	—
PKFY-P32, 40, 50VHM-E	PAC-SG95LE-E	PAC-SH75DM-E
PKFY-P63, 100VKM-E	PAC-SG95LE-E (For P63 only)	PAC-SH94DM-E

7-2. External LEV Box

Item	① External LEV Box	② Joint pipe	③ Pipe cover	④ Band	⑤ Fastener
Quantity	1	2	2	2	2
Shape					

Detailed installation information should be referred to its Installation Manual.

7-3. Drain pump

PAC-SH75DM-E

If drain water can not flow out the Indoor unit by gravity and gradient, a Drain-pump for draining is needed. Drain pump PAC-SH75DM-E can pump water up to 800mm high from the drain pan.

Item	① Drain pump	② Screw	③ Drain hose	④ Drain hose cover	⑤ Hose band
Quantity	1	(M4×16)×1, (M4×35)×6	1	1	1
Shape					
Item	⑥ Band	⑦ Installation plate	⑧ Wiring diagram		
Quantity	1	1	1		
Shape					

Detailed installation information should be referred to its Installation Manual.

PAC-SH94DM-E

If drain water can not flow out the Indoor unit by gravity and gradient, a Drain-pump for draining is needed. Drain pump PAC-SH94DM-E can pump water up to 800mm high from the drain pan.

Item	① Drain pump	② Screw	③ Drain hose	④ Drain hose cover	⑤ Hose band
Quantity	1	(M4×16)×1, (M4×35)×6	1	1	1
Shape					
Item	⑥ Band	⑦ Installation plate	⑧ Wiring diagram		
Quantity	1	1	1		
Shape					

Detailed installation information should be referred to its Installation Manual.

PKFY

PFFY-P-VKM-E2, PFFY-P-VLEM-E, PFFY-P-VLRM-E, PFFY-P-VLRMM-E

1. SPECIFICATIONS	1 - 180
2. EXTERNAL DIMENSIONS	1 - 186
3. CENTER OF GRAVITY	1 - 190
4. ELECTRICAL WIRING DIAGRAMS	1 - 192
5. SOUND LEVELS	1 - 195
5-1. Sound levels	1 - 195
5-2. NC curves	1 - 195
6. FAN CHARACTERISTICS CURVES.....	1 - 198
7. TEMPERATURE/AIRFLOW DISTRIBUTIONS	1 - 201
7-1. Temperature distributions	1 - 201
7-2. Airflow distributions.....	1 - 202

1. SPECIFICATIONS

YKB/YLM

Model			PFFY-P20VKM-E2	PFFY-P25VKM-E2	PFFY-P32VKM-E2	PFFY-P40VKM-E2	
Power source			1-phase 220-230-240V 50Hz				
Cooling capacity (Nominal)	*1	kW	2.2	2.8	3.6	4.5	
	*1	kcal / h	1,900	2,400	3,100	3,900	
	*1	BTU / h	7,500	9,600	12,300	15,400	
	*2	kcal / h	2,000	2,500	3,200	4,000	
	*4	Power input	kW	0.025	0.025	0.025	0.028
*4	Current input	A	0.20	0.20	0.20	0.24	
Heating capacity (Nominal)	*3	kW	2.5	3.2	4.0	5.0	
	*3	kcal / h	2,200	2,800	3,400	4,300	
	*3	BTU / h	8,500	10,900	13,600	17,100	
	*4	Power input	kW	0.025	0.025	0.025	0.028
	*4	Current input	A	0.20	0.20	0.20	0.24
External finish			Plastic (Pure White)				
External dimension H x W x D		mm	600 x 700 x 200				
		in.	23-5/8 x 27-9/16 x 7-7/8				
Net weight		kg (lbs)	15 (34)				
Heat exchanger			Cross fin (Aluminium fin and copper tube)				
FAN	Type x Quantity		Line flow fan x 2				
	External static press.	Pa	0				
		mmH ₂ O	0				
	Motor type		DC motor				
	Motor output		0.03 x 2				
	Driving mechanism		Direct-drive				
	Airflow rate (Low-Mid-High-SHigh)	m ³ / min	5.9 - 6.8 - 7.6 - 8.7	6.1 - 7.0 - 8.0 - 9.1	6.1 - 7.0 - 8.0 - 9.1	8.0 - 9.0 - 9.5 - 10.7	
L / s		98 - 113 - 127 - 145	102 - 117 - 133 - 152	102 - 117 - 133 - 152	133 - 150 - 158 - 178		
cfm		208 - 240 - 268 - 307	215 - 247 - 283 - 321	215 - 247 - 283 - 321	283 - 318 - 335 - 378		
Sound pressure level (Low-Mid-High-SHigh) (measured in anechoic room) *4		dB <A>	27 - 31 - 34 - 37	28 - 32 - 35 - 38	28 - 32 - 35 - 38	35 - 38 - 42 - 44	
Insulation material			Polyethylene sheet				
Air filter			PP honeycomb fabric (Catechin air filter)				
Protection device			Fuse				
Refrigerant control device			LEV				
Connectable outdoor unit			R410A CITY MULTI				
Diameter of refrigerant pipe	Liquid (R410A)	mm (in.)	ø6.35 (ø1/4) Flare				
	Gas (R410A)	mm (in.)	ø12.7 (ø1/2) Flare				
Field drain pipe size		mm (in.)	I.D. 16mm (5/8)				
Drawing	External		IU-BK01-B517				
	Wiring		IU-RG79-V367				
	Refrigerant cycle		-				
Standard attachment	Document		Installation Manual, Instruction Book				
	Accessory						
Remark	Optional parts		-				
	Installation		Details on foundation work, duct work, insulation work, electrical wiring, power source switch, and other items shall be referred to the Installation Manual.				
Note :			*1 Nominal cooling conditions	*2 Nominal cooling conditions	*3 Nominal heating conditions	Unit converter	
			Indoor : 27°CDB/19°CWB (81°FDB/66°FWB)	27°CDB/19.5°CWB (81°FDB/67°FWB)	20°CDB (68°FDB)	kcal/h = kW x 860	
			Outdoor : 35°CDB (95°FDB)	35°CDB (95°FDB)	7°CDB/6°CWB (45°FDB/43°FWB)	BTU/h = kW x 3,412	
			Pipe length : 7.5 m (24-9/16 ft)	5 m (16-3/8 ft)	7.5 m (24-9/16 ft)	cfm = m ³ /min x 35.31	
			Level difference : 0 m (0 ft)	0 m (0 ft)	0 m (0 ft)	lbs = kg / 0.4536	
			* Nominal conditions *1, *3 are subject to JIS B8615-1.			*Above specification data is subject to rounding variation.	
			* Due to continuing improvement, above specification may be subject to change without notice.				
			*4 The values are measured at the rated external static pressure.				

PFFY

1. SPECIFICATIONS

YKB/YLM

Model			PFFY-P20VLEM-E	PFFY-P25VLEM-E	PFFY-P32VLEM-E	PFFY-P40VLEM-E	
Power source			1-phase 220-240V 50Hz, 1-phase 208-230V 60Hz				
Cooling capacity (Nominal)	*1	kW	2.2	2.8	3.6	4.5	
	*1	kcal / h	1,900	2,400	3,100	3,900	
	*1	BTU / h	7,500	9,600	12,300	15,400	
	*2	kcal / h	2,000	2,500	3,150	4,000	
	*4	Power input	kW	0.04 / 0.06	0.04 / 0.06	0.06 / 0.07	0.065 / 0.075
*4	Current input	A	0.19 / 0.25	0.19 / 0.25	0.29/0.30	0.32 / 0.33	
Heating capacity (Nominal)	*3	kW	2.5	3.2	4.0	5.0	
	*3	kcal / h	2,200	2,800	3,400	4,300	
	*3	BTU / h	8,500	10,900	13,600	17,100	
	*4	Power input	kW	0.04 / 0.06	0.04 / 0.06	0.06 / 0.07	0.065 / 0.075
	*4	Current input	A	0.19 / 0.25	0.19 / 0.25	0.29 / 0.30	0.32 / 0.33
External finish			Acrylic painted, MUNSELL (5Y 8/1)				
External dimension H x W x D		mm	630 x 1,050 x 220	630 x 1,050 x 220	630 x 1,170 x 220	630 x 1,170 x 220	
		in.	24-13/16 x 41-3/8 x 8-11/16	24-13/16 x 41-3/8 x 8-11/16	24-13/16 x 46-1/8 x 8-11/16	24-13/16 x 46-1/8 x 8-11/16	
Net weight		kg (lbs)	28 (62)	28 (62)	30 (67)	32 (71)	
Heat exchanger			Cross fin (Aluminium fin and copper tube)				
FAN	Type x Quantity		Sirocco fan x 1	Sirocco fan x 1	Sirocco fan x 2	Sirocco fan x 2	
	External static press.	Pa	0	0	0	0	
		mmH ₂ O	0	0	0	0	
	Motor type		1-phase induction motor				
	Motor output	kW	0.015	0.015	0.018	0.030	
	Driving mechanism		Direct-driven by motor				
	Airflow rate (Low-High)	m ³ / min	5.5 - 6.5	5.5 - 6.5	7.0 - 9.0	9.0 - 11.0	
		L / s	92 - 108	92 - 108	117 - 150	150 - 183	
cfm		194 - 230	194 - 230	247 - 318	318 - 388		
Sound pressure level (Low-High) (measured in anechoic room)	dB <A>	32 - 38 (220V)	32 - 38 (220V)	33 - 38 (220V)	36 - 41 (220V)		
	dB <A>	33 - 39 (230V)	33 - 39 (230V)	34 - 39 (230V)	37 - 42 (230V)		
	*4 dB <A>	34 - 40 (240V)	34 - 40 (240V)	35 - 40 (240V)	38 - 43 (240V)		
Insulation material			Polyethylene foam, Urethane foam				
Air filter			PP honeycomb fabric (washable)				
Protection device			Fuse				
Refrigerant control device			LEV				
Connectable outdoor unit			R410A CITY MULTI				
Diameter of refrigerant pipe	Liquid (R410A)	mm (in.)	ø6.35 (ø1/4) Flare	ø6.35 (ø1/4) Flare	ø6.35 (ø1/4) Flare	ø6.35 (ø1/4) Flare	
	Gas (R410A)	mm (in.)	ø12.7 (ø1/2) Flare	ø12.7 (ø1/2) Flare	ø12.7 (ø1/2) Flare	ø12.7 (ø1/2) Flare	
Field drain pipe size		mm (in.)	I.D. 26mm (1)				
Drawing	External		IU-W65-3950				
	Wiring		IU-W65-3960				
	Refrigerant cycle		-				
Standard attachment	Document		Installation Manual, Instruction Book				
	Accessory		Drain hose (O.D.27mm(1-3/32), (End O.D.20mm(13/16))) (flexible joint)				
Remark	Optional parts		-				
	Installation		Details on foundation work, duct work, insulation work, electrical wiring, power source switch, and other items shall be referred to the Installation Manual.				
Note :			*1 Nominal cooling conditions	*2 Nominal cooling conditions	*3 Nominal heating conditions	Unit converter	
Indoor :			27°CDB/19°CWB (81°FDB/66°FWB)	27°CDB/19.5°CWB (81°FDB/67°FWB)	20°CDB (68°FDB)	kcal/h = kW x 860	
Outdoor :			35°CDB (95°FDB)	35°CDB (95°FDB)	7°CDB/6°CWB (45°FDB/43°FWB)	BTU/h = kW x 3,412	
Pipe length :			7.5 m (24-9/16 ft)	5 m (16-3/8 ft)	7.5 m (24-9/16 ft)	cfm = m ³ /min x 35.31	
Level difference :			0 m (0 ft)	0 m (0 ft)	0 m (0 ft)	lbs = kg / 0.4536	
* Nominal conditions *1, *3 are subject to JIS B8615-1.							
* Due to continuing improvement, above specification may be subject to change without notice.							
*4 The values are measured at the rated external static pressure.							

PFFY

1. SPECIFICATIONS

YKB/YLM

Model		PFFY-P50VLEM-E	PFFY-P63VLEM-E	PFFY-P20VLRM-E	PFFY-P25VLRM-E		
Power source		1-phase 220-240V 50Hz, 1-phase 208-230V 60Hz					
Cooling capacity (Nominal)	*1	kW	5.6	7.1	2.2	2.8	
	*1	kcal / h	4,800	6,100	1,900	2,400	
		BTU / h	19,100	24,200	7,500	9,600	
	*2	kcal / h	5,000	6,300	2,000	2,500	
		*4	Power input	kW	0.085 / 0.09	0.1 / 0.11	0.04 / 0.06
*4	Current input	A	0.40 / 0.41	0.46 / 0.47	0.19 / 0.25	0.19 / 0.25	
Heating capacity (Nominal)	*3	kW	6.3	8.0	2.5	3.2	
	*3	kcal / h	5,400	6,900	2,200	2,800	
		BTU / h	21,500	27,300	8,500	10,900	
	*4	Power input	kW	0.085 / 0.09	0.1 / 0.11	0.04 / 0.06	0.04 / 0.06
		*4	Current input	A	0.40 / 0.41	0.46 / 0.47	0.19 / 0.25
External finish		Acrylic painted, MUNSELL (5Y 8/1)			Galvanized		
External dimension H x W x D		mm	630 x 1,410 x 220	630 x 1,410 x 220	639 x 886 x 220	639 x 886 x 220	
		in.	24-13/16 x 55-9/16 x 8-11/16	24-13/16 x 55-9/16 x 8-11/16	25-3/16 x 34-15/16 x 8-11/16	25-3/16 x 34-15/16 x 8-11/16	
Net weight		kg (lbs)	36 (80)	37 (82)	22 (49)	22 (49)	
Heat exchanger		Cross fin (Aluminium fin and copper tube)					
FAN	Type x Quantity		Sirocco fan x 2	Sirocco fan x 2	Sirocco fan x 1	Sirocco fan x 1	
	External static press.	Pa	0	0	0	0	
		mmH ₂ O	0	0	0	0	
	Motor type		1-phase induction motor				
	Motor output		kW	0.035	0.050	0.015	0.015
	Driving mechanism		Direct-driven by motor				
	Airflow rate (Low-High)	m ³ / min		12.0 - 14.0	12.0 - 15.5	5.5 - 6.5	5.5 - 6.5
L / s		200 - 233	200 - 258	92 - 108	92 - 108		
cfm		424 - 494	424 - 547	194 - 230	194 - 230		
Sound pressure level (Low-High) (measured in anechoic room)	dB <A>		36 - 41 (220V)	38 - 44 (220V)	32 - 38 (220V)	32 - 38 (220V)	
	dB <A>		37 - 42 (230V)	39 - 45 (230V)	33 - 39 (230V)	33 - 39 (230V)	
	*4 dB <A>		38 - 43 (240V)	40 - 46 (240V)	34 - 40 (240V)	34 - 40 (240V)	
Insulation material		Polyethylene foam, Urethane foam					
Air filter		PP honeycomb fabric (washable)					
Protection device		Fuse					
Refrigerant control device		LEV					
Connectable outdoor unit		R410A CITY MULTI					
Diameter of refrigerant pipe	Liquid (R410A)	mm (in.)	ø6.35 (ø1/4) Flare	ø9.52 (ø3/8) Flare	ø6.35 (ø1/4) Flare	ø6.35 (ø1/4) Flare	
	Gas (R410A)	mm (in.)	ø12.7 (ø1/2) Flare	ø15.88 (ø5/8) Flare	ø12.7 (ø1/2) Flare	ø12.7 (ø1/2) Flare	
Field drain pipe size		mm (in.)	I.D. 26mm (1)				
Drawing	External		IU-W65-3950	IU-W65-3950	IU-W65-3951	IU-W65-3951	
	Wiring		IU-W65-3960	IU-W65-3960	IU-W65-3960	IU-W65-3960	
	Refrigerant cycle		-	-	-	-	
Standard attachment	Document		Installation Manual, Instruction Book				
	Accessory		Drain hose (O.D.27mm(1-3/32), (End O.D.20mm(13/16))) (flexible joint)				
Remark	Optional parts		-				
	Installation		Details on foundation work, duct work, insulation work, electrical wiring, power source switch, and other items shall be referred to the Installation Manual.				
Note :		*1 Nominal cooling conditions	*2 Nominal cooling conditions	*3 Nominal heating conditions	Unit converter		
Indoor :		27°CDB/19°CWB (81°FDB/66°FWB)	27°CDB/19.5°CWB (81°FDB/67°FWB)	20°CDB (68°FDB)	kcal/h = kW x 860		
Outdoor :		35°CDB (95°FDB)	35°CDB (95°FDB)	7°CDB/6°CWB (45°FDB/43°FWB)	BTU/h = kW x 3,412		
Pipe length :		7.5 m (24-9/16 ft)	5 m (16-3/8 ft)	7.5 m (24-9/16 ft)	cfm = m ³ /min x 35.31		
Level difference :		0 m (0 ft)	0 m (0 ft)	0 m (0 ft)	lbs = kg / 0.4536		
* Nominal conditions *1, *3 are subject to JIS B8615-1 or JIS B8615-2.						*Above specification data is subject to rounding variation.	
* Due to continuing improvement, above specification may be subject to change without notice.							
*4 The values are measured at the rated external static pressure.							

PFFY

1. SPECIFICATIONS

YKB/YLM

Model			PFFY-P32VLRM-E	PFFY-P40VLRM-E	PFFY-P50VLRM-E	PFFY-P63VLRM-E	
Power source			1-phase 220-240V 50Hz, 1-phase 208-230V 60Hz				
Cooling capacity (Nominal)	*1	kW	3.6	4.5	5.6	7.1	
	*1	kcal / h	3,100	3,900	4,800	6,100	
	*1	BTU / h	12,300	15,400	19,100	24,200	
	*2	kcal / h	3,150	4,000	5,000	6,300	
	*4	Power input	kW	0.06 / 0.07	0.065 / 0.075	0.085 / 0.09	0.1 / 0.11
*4	Current input	A	0.29 / 0.30	0.32 / 0.33	0.40 / 0.41	0.46 / 0.47	
Heating capacity (Nominal)	*3	kW	4.0	5.0	6.3	8.0	
	*3	kcal / h	3,400	4,300	5,400	6,900	
	*3	BTU / h	13,600	17,100	21,500	27,300	
	*4	Power input	kW	0.06 / 0.07	0.065 / 0.075	0.085 / 0.09	0.1 / 0.11
	*4	Current input	A	0.29 / 0.30	0.32 / 0.33	0.40 / 0.41	0.46 / 0.47
External finish			Galvanized				
External dimension H x W x D		mm	639 x 1,006 x 220	639 x 1,006 x 220	639 x 1,246 x 220	639 x 1,246 x 220	
		in.	25-3/16 x 39-5/8 x 8-11/16	25-3/16 x 39-5/8 x 8-11/16	25-3/16 x 49-1/16 x 8-11/16	25-3/16 x 49-1/16 x 8-11/16	
Net weight		kg (lbs)	24 (53)	25 (56)	29 (64)	30 (67)	
Heat exchanger			Cross fin (Aluminium fin and copper tube)				
FAN	Type x Quantity		Sirocco fan x 2	Sirocco fan x 2	Sirocco fan x 2	Sirocco fan x 2	
	External static press.	Pa	0	0	0	0	
		mmH ₂ O	0	0	0	0	
	Motor type		1-phase induction motor				
	Motor output	kW	0.018	0.030	0.035	0.050	
	Driving mechanism		Direct-driven by motor				
	Airflow rate (Low-High)	m ³ / min	7.0 - 9.0	9.0 - 11.0	12.0 - 14.0	12.0 - 15.5	
L / s		117 - 150	150 - 183	200 - 233	200 - 258		
cfm		247 - 318	318 - 388	424 - 494	424 - 547		
Sound pressure level (Low-High) (measured in anechoic room)	dB <A>	33 - 38 (220V)	36 - 41 (220V)	36 - 41 (220V)	38 - 44 (220V)		
	dB <A>	34 - 39 (230V)	37 - 42 (230V)	37 - 42 (230V)	39 - 45 (230V)		
	*4 dB <A>	35 - 40 (240V)	38 - 43 (240V)	38 - 43 (240V)	40 - 46 (240V)		
Insulation material			Polyethylene foam, Urethane foam				
Air filter			PP honeycomb fabric (washable)				
Protection device			Fuse				
Refrigerant control device			LEV				
Connectable outdoor unit			R410A CITY MULTI				
Diameter of refrigerant pipe	Liquid (R410A)	mm (in.)	ø6.35 (ø1/4) Flare	ø6.35 (ø1/4) Flare	ø6.35 (ø1/4) Flare	ø9.52 (ø3/8) Flare	
	Gas (R410A)	mm (in.)	ø12.7 (ø1/2) Flare	ø12.7 (ø1/2) Flare	ø12.7 (ø1/2) Flare	ø15.88 (ø5/8) Flare	
Field drain pipe size		mm (in.)	I.D. 26mm (1)				
Drawing	External		IU-W65-3951				
	Wiring		IU-W65-3960				
	Refrigerant cycle		-				
Standard attachment	Document		Installation Manual, Instruction Book				
	Accessory		Drain hose (O.D.27mm(1-3/32), (End O.D.20mm(13/16))) (flexible joint)				
Remark	Optional parts		-				
	Installation		Details on foundation work, duct work, insulation work, electrical wiring, power source switch, and other items shall be referred to the Installation Manual.				
Note :			*1 Nominal cooling conditions	*2 Nominal cooling conditions	*3 Nominal heating conditions	Unit converter	
			Indoor : 27°CDB/19°CWB (81°FDB/66°FWB)	27°CDB/19.5°CWB (81°FDB/67°FWB)	20°CDB (68°FDB)	kcal/h = kW x 860	
			Outdoor : 35°CDB (95°FDB)	35°CDB (95°FDB)	7°CDB/6°CWB (45°FDB/43°FWB)	BTU/h = kW x 3,412	
			Pipe length : 7.5 m (24-9/16 ft)	5 m (16-3/8 ft)	7.5 m (24-9/16 ft)	cfm = m ³ /min x 35.31	
			Level difference : 0 m (0 ft)	0 m (0 ft)	0 m (0 ft)	lbs = kg / 0.4536	
			* Nominal conditions *1, *3 are subject to JIS B8615-1 or JIS B8615-2.			*Above specification data is subject to rounding variation.	
			* Due to continuing improvement, above specification may be subject to change without notice.				
			*4 The values are measured at the factory setting of external static pressure.				

PFFY

1. SPECIFICATIONS

YKB/YLM

Model		PFFY-P20VLRMM-E	PFFY-P25VLRMM-E	PFFY-P32VLRMM-E	PFFY-P40VLRMM-E		
Power source		1-phase 220-240V (50/60Hz)					
Cooling capacity (Nominal)	*1	kW	2.2	2.8	3.6	4.5	
	*1	kcal / h	1,900	2,400	3,100	3,900	
		BTU / h	7,500	9,600	12,300	15,400	
	*2	kcal / h	2,000	2,500	3,150	4,000	
	*4	Power input	kW	0.04	0.04	0.04	0.05
*4	Current input	A	0.34	0.34	0.38	0.43	
Heating capacity (Nominal)	*3	kW	2.5	3.2	4.0	5.0	
	*3	kcal / h	2,200	2,800	3,400	4,300	
		BTU / h	8,500	10,900	13,600	17,100	
	*4	Power input	kW	0.04	0.04	0.04	0.05
	*4	Current input	A	0.34	0.34	0.38	0.43
External finish		Galvanized steel plate					
External dimension H x W x D		mm	639 x 886 x 220	639 x 886 x 220	639 x 1006 x 220	639 x 1006 x 220	
		in.	25-3/16 x 34-15/16 x 8-11/16	25-3/16 x 34-15/16 x 8-11/16	25-3/16 x 39-5/8 x 8-11/16	25-3/16 x 39-5/8 x 8-11/16	
Net weight		kg (lbs)	21 (47)	21 (47)	24 (53)	25 (56)	
Heat exchanger		Cross fin (Aluminium fin and copper tube)					
FAN	Type x Quantity		Sirocco fan x 1	Sirocco fan x 1	Sirocco fan x 2	Sirocco fan x 2	
	External static press.	Pa	20 - <40> - <60>	20 - <40> - <60>	20 - <40> - <60>	20 - <40> - <60>	
		mmH ₂ O	2.0 - <4.1> - <6.1>	2.0 - <4.1> - <6.1>	2.0 - <4.1> - <6.1>	2.0 - <4.1> - <6.1>	
	Motor type		DC brushless motor				
	Motor output		kW	0.096	0.096	0.096	0.096
	Driving mechanism		Direct-driven				
	Airflow rate (Low-Mid-High)	m ³ / min		4.5 - 5.5 - 6.5	4.5 - 5.5 - 6.5	6.5 - 7.5 - 9.0	8.0 - 9.5 - 11.0
		L / s		75 - 92 - 108	75 - 92 - 108	108 - 125 - 150	133 - 158 - 183
cfm		159 - 194 - 230	159 - 194 - 230	230 - 265 - 318	283 - 335 - 388		
Sound pressure level (Low-Mid-High) (measured in anechoic room)	dB <A>		31 - 36 - 40 (20Pa)	31 - 36 - 40 (20Pa)	27 - 32 - 37 (20Pa)	30 - 36 - 40 (20Pa)	
	dB <A>		34 - 39 - 42 (40Pa)	34 - 39 - 42 (40Pa)	30 - 35 - 41 (40Pa)	32 - 38 - 42 (40Pa)	
	*4	dB <A>	35 - 40 - 43 (60Pa)	35 - 40 - 43 (60Pa)	32 - 37 - 42 (60Pa)	35 - 39 - 44 (60Pa)	
Insulation material		Polyethylene foam, Urethane foam					
Air filter		PP honeycomb fabric (washable)					
Protection device		Fuse					
Refrigerant control device		LEV					
Connectable outdoor unit		R410A CITY MULTI					
Diameter of refrigerant pipe	Liquid (R410A)	mm (in.)	ø6.35 (ø1/4) Brazed	ø6.35 (ø1/4) Brazed	ø6.35 (ø1/4) Brazed	ø6.35 (ø1/4) Brazed	
	Gas (R410A)	mm (in.)	ø12.7 (ø1/2) Brazed	ø12.7 (ø1/2) Brazed	ø12.7 (ø1/2) Brazed	ø12.7 (ø1/2) Brazed	
Field drain pipe size		mm (in.)	I.D. 26mm (1)<Accessory hose O.D.27mm(top end:O.D.20mm)>				
Drawing	External		IU-KB94-L081	IU-KB94-L081	IU-KB94-L081	IU-KB94-L081	
	Wiring		IU-KB94-G985	IU-KB94-G985	IU-KB94-G985	IU-KB94-G985	
	Refrigerant cycle		-	-	-	-	
Standard attachment	Document		Installation Manual, Instruction Book				
	Accessory		Screw plate, Level adjusting screw, Strainer, Drain hose (flexible joint), Hose band				
Remark	Optional parts		-				
	Installation		Details on foundation work, duct work, insulation work, electrical wiring, power source switch, and other items shall be referred to the Installation Manual.				
Note :		*1 Nominal cooling conditions	*2 Nominal cooling conditions	*3 Nominal heating conditions	Unit converter		
Indoor :		27°CDB/19°CWB (81°FDB/66°FWB)	27°CDB/19.5°CWB (81°FDB/67°FWB)	20°CDB (68°FDB)	kcal/h = kW x 860		
Outdoor :		35°CDB (95°FDB)	35°CDB (95°FDB)	7°CDB/6°CWB (45°FDB/43°FWB)	BTU/h = kW x 3,412		
Pipe length :		7.5 m (24-9/16 ft)	5 m (16-3/8 ft)	7.5 m (24-9/16 ft)	cfm = m ³ /min x 35.31		
Level difference :		0 m (0 ft)	0 m (0 ft)	0 m (0 ft)	lbs = kg / 0.4536		
* Nominal conditions *1, *3 are subject to JIS B8615-1 or JIS B8615-2.						*Above specification data is subject to rounding variation.	
* Due to continuing improvement, above specification may be subject to change without notice.							
*4 The values are measured at the factory setting of external static pressure.							

PFFY

1. SPECIFICATIONS

YKB/YLM

Model			PFFY-P50VLRMM-E	PFFY-P63VLRMM-E						
Power source			1-phase 220-240V (50/60Hz)							
Cooling capacity (Nominal)	*1	kW	5.6	7.1						
	*1	kcal / h	4,800	6,100						
	*1	BTU / h	19,100	24,200						
	*2	kcal / h	5,000	6,300						
	*4	Power input	kW	0.05	0.07					
*4	Current input	A	0.48	0.59						
Heating capacity (Nominal)	*3	kW	6.3	8.0						
	*3	kcal / h	5,400	6,900						
	*3	BTU / h	21,500	27,300						
	*4	Power input	kW	0.05	0.07					
	*4	Current input	A	0.48	0.59					
External finish			Galvanized steel plate							
External dimension H x W x D		mm	639 x 1246 x 220	639 x 1246 x 220						
		in.	25-3/16 x 49-1/16 x 8-11/16	25-3/16 x 49-1/16 x 8-11/16						
Net weight		kg (lbs)	29 (64)	29 (64)						
Heat exchanger			Cross fin (Aluminium fin and copper tube)							
FAN	Type x Quantity		Sirocco fan x 2		Sirocco fan x 2					
	External static press.	Pa	20 - <40> - <60>		20 - <40> - <60>					
		mmH ₂ O	2.0 - <4.1> - <6.1>		2.0 - <4.1> - <6.1>					
	Motor type		DC brushless motor							
	Motor output		kW	0.096	0.096					
	Driving mechanism		Direct-driven							
	Airflow rate (Low-Mid-High)	m ³ / min		10.0 - 12.0 - 14.0	11.0 - 13.0-15.5					
L / s		167 - 200 - 233	183 - 217 - 258							
cfm		353 - 424 - 494	388 - 459 - 547							
Sound pressure level (Low-Mid-High) (measured in anechoic room)	dB <A>		32 - 37 - 41 (20Pa)	35 - 40 - 44 (20Pa)						
	dB <A>		35 - 40 - 44 (40Pa)	36 - 42 - 47 (40Pa)						
	*4	dB <A>	36 - 41 - 45 (60Pa)	38 - 43 - 48 (60Pa)						
Insulation material			Polyethylene foam, Urethane foam							
Air filter			PP honeycomb fabric (washable)							
Protection device			Fuse							
Refrigerant control device			LEV							
Connectable outdoor unit			R410A CITY MULTI							
Diameter of refrigerant pipe	Liquid (R410A)	mm (in.)	ø6.35 (ø1/4) Brazed	ø9.52 (ø3/8) Brazed						
	Gas (R410A)	mm (in.)	ø12.7 (ø1/2) Brazed	ø15.88 (ø5/8) Brazed						
Field drain pipe size		mm (in.)	I.D. 26mm (1)<Accessory hose O.D.27mm(top end:O.D.20mm)>							
Drawing	External		IU-KB94-L081	IU-KB94-L081						
	Wiring		IU-KB94-G985	IU-KB94-G985						
	Refrigerant cycle		-	-						
Standard attachment	Document		Installation Manual, Instruction Book							
	Accessory		Screw plate, Level adjusting screw, Strainer, Drain hose (flexible joint), Hose band							
Remark	Optional parts		-							
	Installation		Details on foundation work, duct work, insulation work, electrical wiring, power source switch, and other items shall be referred to the Installation Manual.							
Note : <table border="0" style="width:100%; border-collapse: collapse;"> <tr> <td style="width:33%; vertical-align: top;"> *1 Nominal cooling conditions Indoor : 27°CDB/19°CWB (81°FDB/66°FWB) Outdoor : 35°CDB (95°FDB) Pipe length : 7.5 m (24-9/16 ft) Level difference : 0 m (0 ft) </td> <td style="width:33%; vertical-align: top;"> *2 Nominal cooling conditions 27°CDB/19.5°CWB (81°FDB/67°FWB) 35°CDB (95°FDB) 5 m (16-3/8 ft) 0 m (0 ft) </td> <td style="width:33%; vertical-align: top;"> *3 Nominal heating conditions 20°CDB (68°FDB) 7°CDB/6°CWB (45°FDB/43°FWB) 7.5 m (24-9/16 ft) 0 m (0 ft) </td> <td style="width:15%; vertical-align: top;"> Unit converter kcal/h = kW x 860 BTU/h = kW x 3,412 cfm = m³/min x 35.31 lbs = kg / 0.4536 </td> </tr> </table>							*1 Nominal cooling conditions Indoor : 27°CDB/19°CWB (81°FDB/66°FWB) Outdoor : 35°CDB (95°FDB) Pipe length : 7.5 m (24-9/16 ft) Level difference : 0 m (0 ft)	*2 Nominal cooling conditions 27°CDB/19.5°CWB (81°FDB/67°FWB) 35°CDB (95°FDB) 5 m (16-3/8 ft) 0 m (0 ft)	*3 Nominal heating conditions 20°CDB (68°FDB) 7°CDB/6°CWB (45°FDB/43°FWB) 7.5 m (24-9/16 ft) 0 m (0 ft)	Unit converter kcal/h = kW x 860 BTU/h = kW x 3,412 cfm = m ³ /min x 35.31 lbs = kg / 0.4536
*1 Nominal cooling conditions Indoor : 27°CDB/19°CWB (81°FDB/66°FWB) Outdoor : 35°CDB (95°FDB) Pipe length : 7.5 m (24-9/16 ft) Level difference : 0 m (0 ft)	*2 Nominal cooling conditions 27°CDB/19.5°CWB (81°FDB/67°FWB) 35°CDB (95°FDB) 5 m (16-3/8 ft) 0 m (0 ft)	*3 Nominal heating conditions 20°CDB (68°FDB) 7°CDB/6°CWB (45°FDB/43°FWB) 7.5 m (24-9/16 ft) 0 m (0 ft)	Unit converter kcal/h = kW x 860 BTU/h = kW x 3,412 cfm = m ³ /min x 35.31 lbs = kg / 0.4536							
* Nominal conditions *1, *3 are subject to JIS B8615-1 or JIS B8615-2. * Due to continuing improvement, above specification may be subject to change without notice. *4 The values are measured at the factory setting of external static pressure.										
*Above specification data is subject to rounding variation.										

PFFY

PFFY-P20, 25, 32, 40VKM-E2

Unit : mm

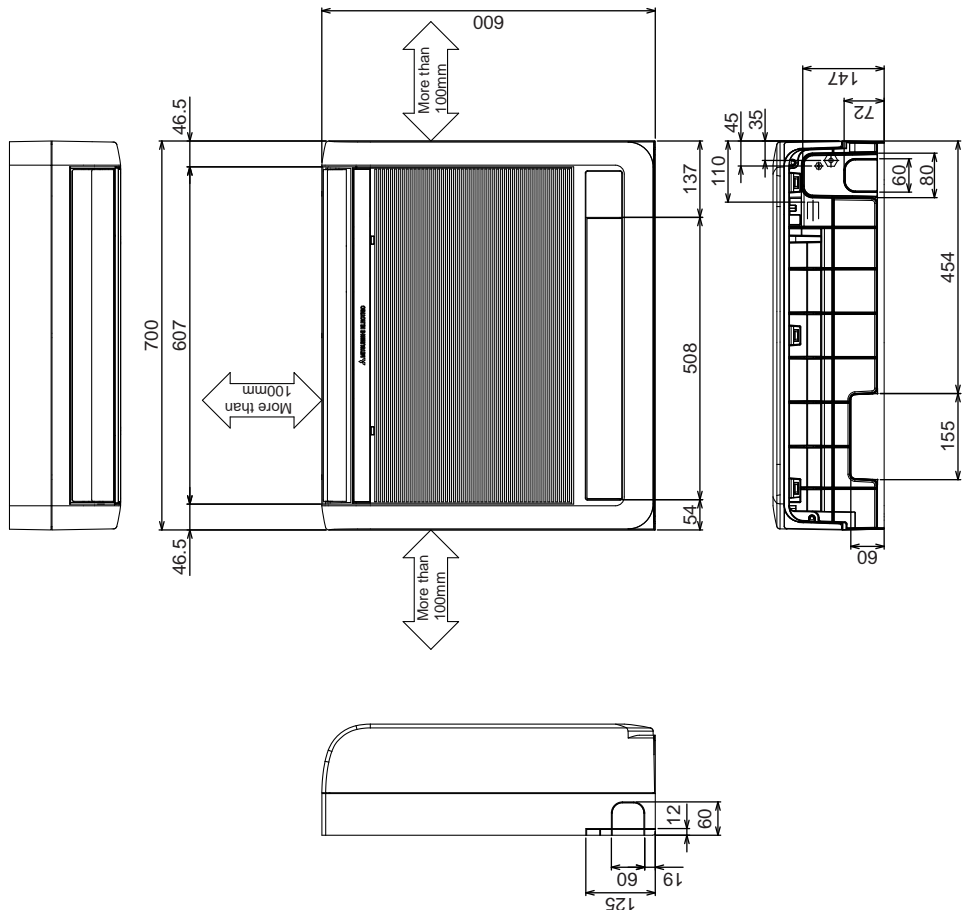
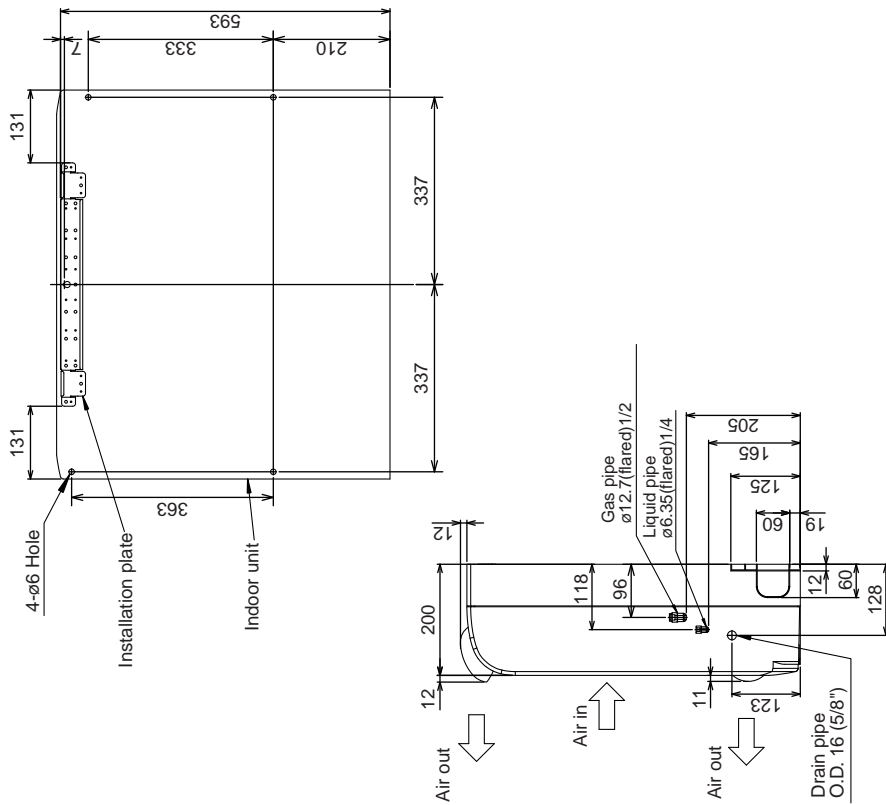

PFFY

PFFY-P20, 25, 32, 40, 50, 63VLEM-E

Unit : mm

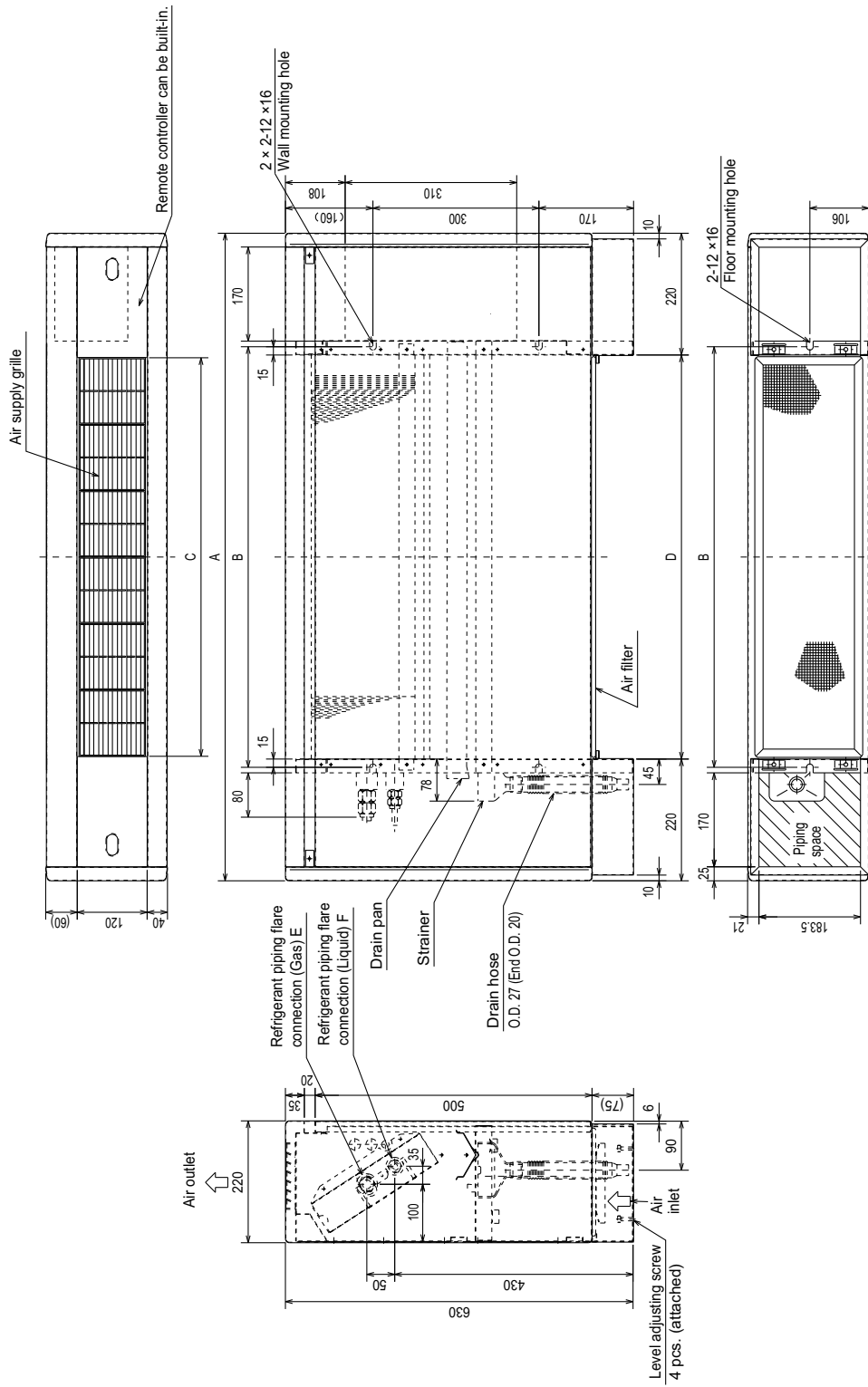

Dimensions

Model	A	B	C	D	E (Gas)	F (Liquid)
PFFY-P20VLEM-E	1050	640	600	610	Ø12.7	Ø6.35
PFFY-P25VLEM-E	1050	640	600	610	Ø12.7	Ø6.35
PFFY-P32VLEM-E	1170	760	720	730	Ø12.7	Ø6.35
PFFY-P40VLEM-E	1170	760	720	730	Ø12.7	Ø6.35
PFFY-P50VLEM-E	1410	1000	960	970	Ø12.7	Ø6.35
PFFY-P63VLEM-E	1410	1000	960	970	Ø15.88	Ø9.52

PFFY

PFFY-P20, 25, 32, 40, 50, 63VLRM-E

Unit : mm

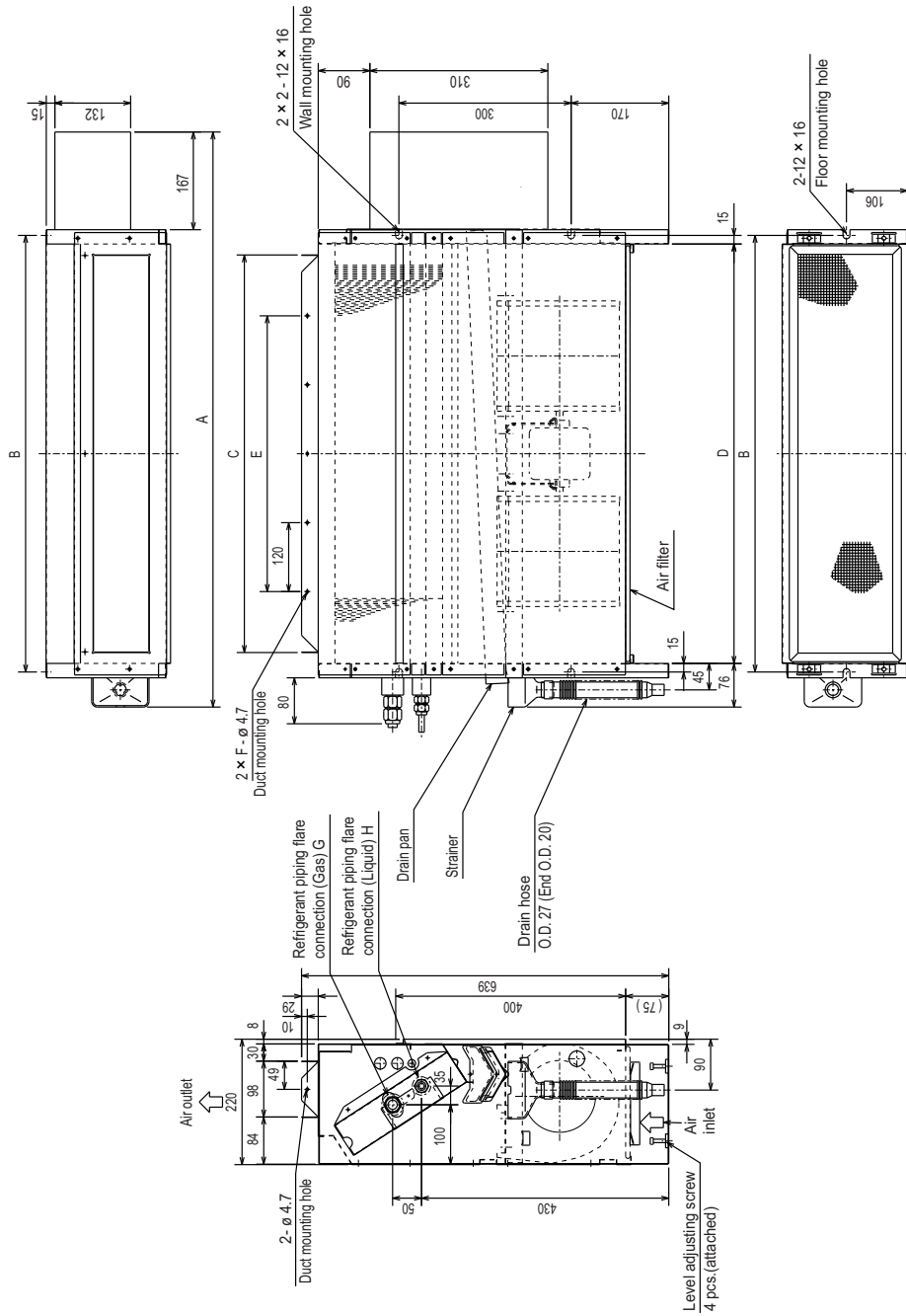

Dimensions

Model	A	B	C	D	E	F	G (Gas)	H (Liquid)
PFFY-P20VLRM-E	886	640	572	610	360	4	ø12.7	ø6.35
PFFY-P25VLRM-E	886	640	572	610	360	4	ø12.7	ø6.35
PFFY-P32VLRM-E	1006	760	692	730	480	5	ø12.7	ø6.35
PFFY-P40VLRM-E	1006	760	692	730	480	5	ø12.7	ø6.35
PFFY-P50VLRM-E	1246	1000	932	970	720	7	ø12.7	ø6.35
PFFY-P63VLRM-E	1246	1000	932	970	720	7	ø15.88	ø9.52

PFFY-P20, 25, 32, 40, 50, 63VLRMM-E

Unit : mm

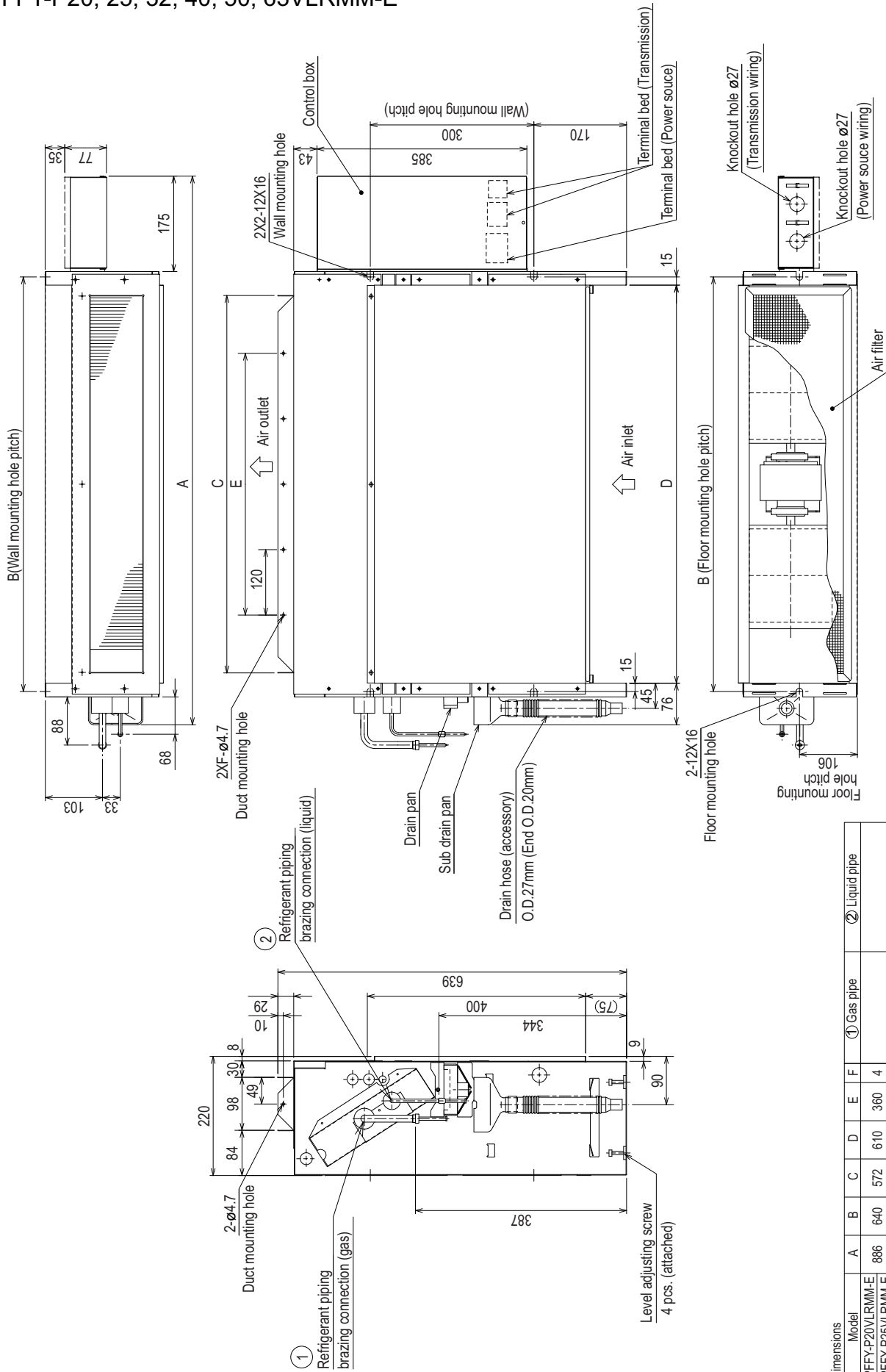

Dimensions		A	B	C	D	E	F	G	① Gas pipe	② Liquid pipe
Model										
PFFY-P20VLRMM-E	886	640	572	610	360	4			ø12.7	ø6.35
PFFY-P25VLRMM-E										
PFFY-P32VLRMM-E	1006	760	692	730	480	5				
PFFY-P40VLRMM-E										
PFFY-P50VLRMM-E	1246	1000	932	970	720	7				ø9.52
PFFY-P63VLRMM-E										

PFFY

PFFY-P20, 25, 32, 40VKM-E2

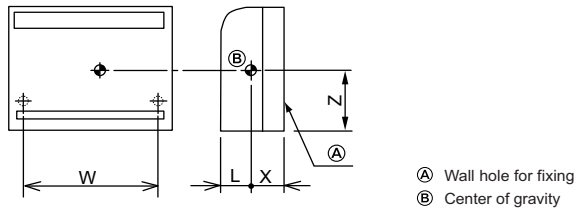

(mm)[in]

Model name	W	L	X	Z
PFFY-P20VKM-E2	674 [26-9/16]	85 [3-3/8]	115 [4-9/16]	330 [13]
PFFY-P25VKM-E2	674 [26-9/16]	85 [3-3/8]	115 [4-9/16]	330 [13]
PFFY-P32VKM-E2	674 [26-9/16]	85 [3-3/8]	115 [4-9/16]	330 [13]
PFFY-P40VKM-E2	674 [26-9/16]	85 [3-3/8]	115 [4-9/16]	330 [13]

PFFY-P20, 25, 32, 40, 50, 63VLEM-E

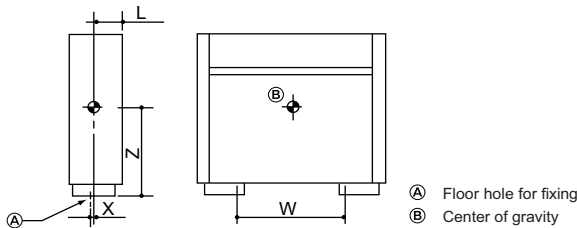

(mm)[in]

Model name	W	L	X	Z
PFFY-P20VLEM-E	640 [25-1/4]	100 [3-15/16]	17 [11/16]	335 [13-1/4]
PFFY-P25VLEM-E	640 [25-1/4]	100 [3-15/16]	17 [11/16]	335 [13-1/4]
PFFY-P32VLEM-E	760 [29-15/16]	100 [3-15/16]	17 [11/16]	335 [13-1/4]
PFFY-P40VLEM-E	760 [29-15/16]	100 [3-15/16]	17 [11/16]	335 [13-1/4]
PFFY-P50VLEM-E	1000 [39-3/8]	100 [3-15/16]	17 [11/16]	335 [13-1/4]
PFFY-P63VLEM-E	1000 [39-3/8]	100 [3-15/16]	17 [11/16]	335 [13-1/4]

PFFY-P20, 25, 32, 40, 50, 63VLRM-E

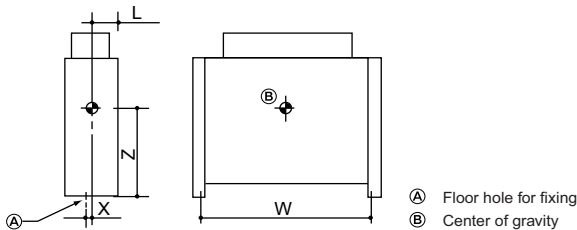

(mm)[in]

Model name	W	L	X	Z
PFFY-P20VLRM-E	640 [25-1/4]	100 [3-15/16]	17 [11/16]	335 [13-1/4]
PFFY-P25VLRM-E	640 [25-1/4]	100 [3-15/16]	17 [11/16]	335 [13-1/4]
PFFY-P32VLRM-E	760 [29-15/16]	100 [3-15/16]	17 [11/16]	335 [13-1/4]
PFFY-P40VLRM-E	760 [29-15/16]	100 [3-15/16]	17 [11/16]	335 [13-1/4]
PFFY-P50VLRM-E	1000 [39-3/8]	100 [3-15/16]	17 [11/16]	335 [13-1/4]
PFFY-P63VLRM-E	1000 [39-3/8]	100 [3-15/16]	17 [11/16]	335 [13-1/4]

PFFY-P20, 25, 32, 40, 50, 63VLRMM-E

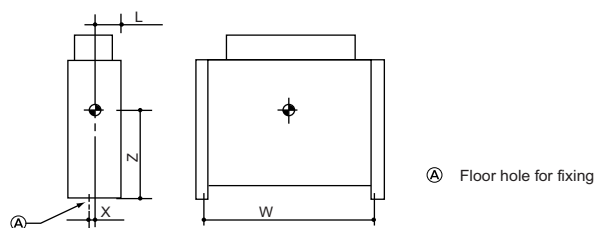

(mm)[in]

Model name	W	L	X	Z
PFFY-P20VLRMM-E	640 [25-1/4]	100 [3-15/16]	17 [11/16]	335 [13-1/4]
PFFY-P25VLRMM-E	640 [25-1/4]	100 [3-15/16]	17 [11/16]	335 [13-1/4]
PFFY-P32VLRMM-E	760 [29-15/16]	100 [3-15/16]	17 [11/16]	335 [13-1/4]
PFFY-P40VLRMM-E	760 [29-15/16]	100 [3-15/16]	17 [11/16]	335 [13-1/4]
PFFY-P50VLRMM-E	1000 [39-3/8]	100 [3-15/16]	17 [11/16]	335 [13-1/4]
PFFY-P63VLRMM-E	1000 [39-3/8]	100 [3-15/16]	17 [11/16]	335 [13-1/4]

PFFY-P20, 25, 32, 40VKM-E2

[LEGEND]

SYMBOL	NAME	SYMBOL	NAME	SYMBOL	NAME
I. B	INDOOR CONTROLLER BOARD	MF1	FAN MOTOR (UPPER)	TH23	PIPE TEMP. DETECTION/GAS (0°C/15kΩ, 25°C/5.4kΩ)
CN32	CONNECTOR	MF2	FAN MOTOR (LOWER)	A. B	ADDRESS BOARD
CN51		MV1	VANE MOTOR 1	SW1	SWITCH
CN52		MV2	VANE MOTOR 2	SW11	MODE SELECTION
CN105		LS	LIMIT SWITCH (CLOSE)	SW12	ADDRESS SETTING 1s DIGIT
SW2	SWITCH	LEV	LINEAR EXPANSION VALVE	SW14	ADDRESS SETTING 10ths DIGIT
SW3		TB2	TERMINAL BLOCK	SW4	BRANCH NO.
SW4		TB5	TERMINAL BLOCK	SWC	OPTION SELECTOR
FUSE	FUSE (T6.3AL250V)	TH21	THERMISTOR		
LED1	POWER SUPPLY (I.B)	TH22			
LED2	POWER SUPPLY (I.B)				

NOTES:

- At servicing for outdoor unit, always follow the wiring diagram of outdoor unit.
- In case of using MA-Remote controller, please connect to TB15.
(Remote controller wire is non-polar.)
- In case of using M-NET, please connect to TB5. (Transmission line is non-polar.)
- Symbol [S] of TB5 is the shield wire connection.
- Symbols used in wiring diagram below are, □ : terminal block, ○ : connector.
- The setting of the SW2 dip switches differs in the capacity. For the detail, refer to the table below.
- Please set the switch SW5 according to the power supply voltage.
Set SW5 to 240V side when the power supply is 230 and 240 volts.
When the power supply is 220 volts, set SW5 to 220V side.

The black square (■) indicates a switch position. <*1>

LED on indoor board for service

MARK	MEANING	FUNCTION
LED1	Main power supply	Main power supply (Indoor unit: 220-240V) power on → lamp is lit
LED2	Power supply for MA-Remote controller	Power supply for MA-remote controller on → lamp is lit

MODELS	SW2
P20VBM	ON OFF 123456
P25VBM	ON OFF 123456
P32VBM	ON OFF 123456
P40VBM	ON OFF 123456

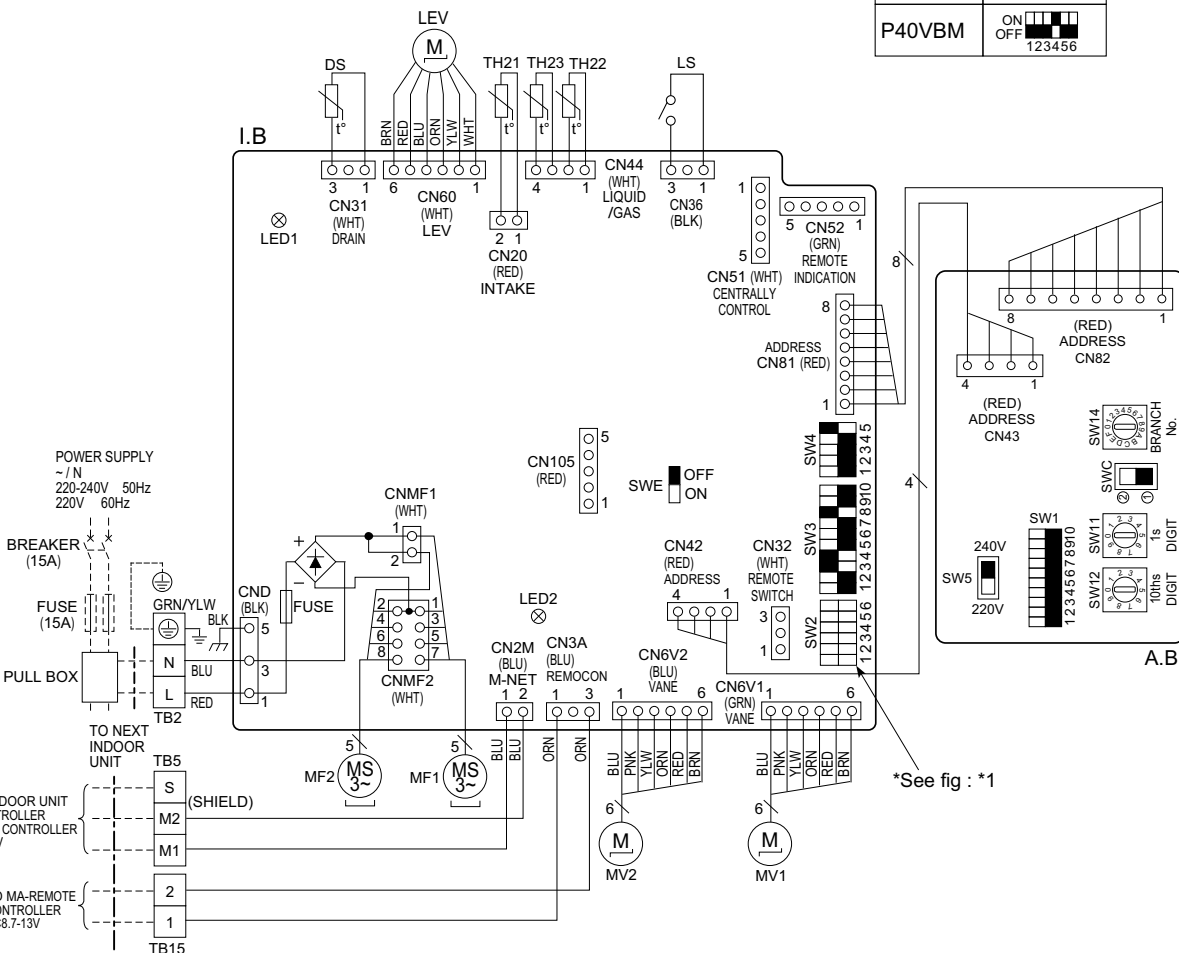

PFFY

PFFY-P20, 25, 32, 40, 50, 63VLEM-E, VLRM-E

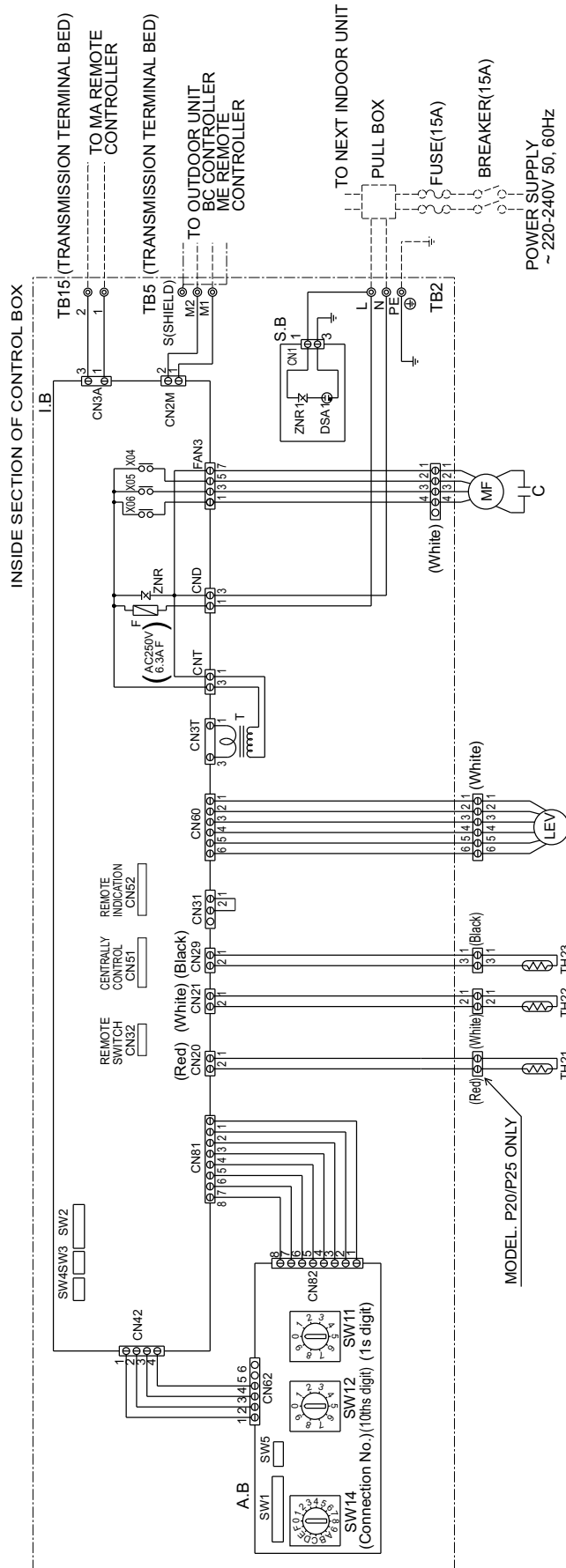

SYMBOL EXPLANATION

SYMBOL	NAME	SYMBOL	NAME
MF	Fan motor	TH22	Thermistor (inlet temp. detection)
C	Capacitor (for MF)	TH23	Thermistor (piping temp. detection/liquid)
I.B	Indoor controller board	SW11 (A.B)	Switch (1s digit address set)
A.B	Address board	SW12 (A.B)	Switch (10ths digit address set)
TB2	Power source terminal bed	SW14 (A.B)	Switch (connection No. set)
TB5	Transmission terminal bed	SW1 (A.B)	Switch (for mode selection)
TB15	Transmission terminal bed	SW2 (I.B)	Switch (for capacity code)
F	Fuse AC250V 6.3A F	SW3 (I.B)	Switch (for mode selection)
T	Transformer	SW4 (I.B)	Switch (for mode selection)
LEV	Electronic linear expan. valve	SW5 (A.B)	Switch (for voltage selection)
S.B	Surge absorber board	X04~06	Aux. relay
TH21	Thermistor (inlet temp. detection)		

PFFY-P20, 25, 32, 40, 50, 63VLRMM-E

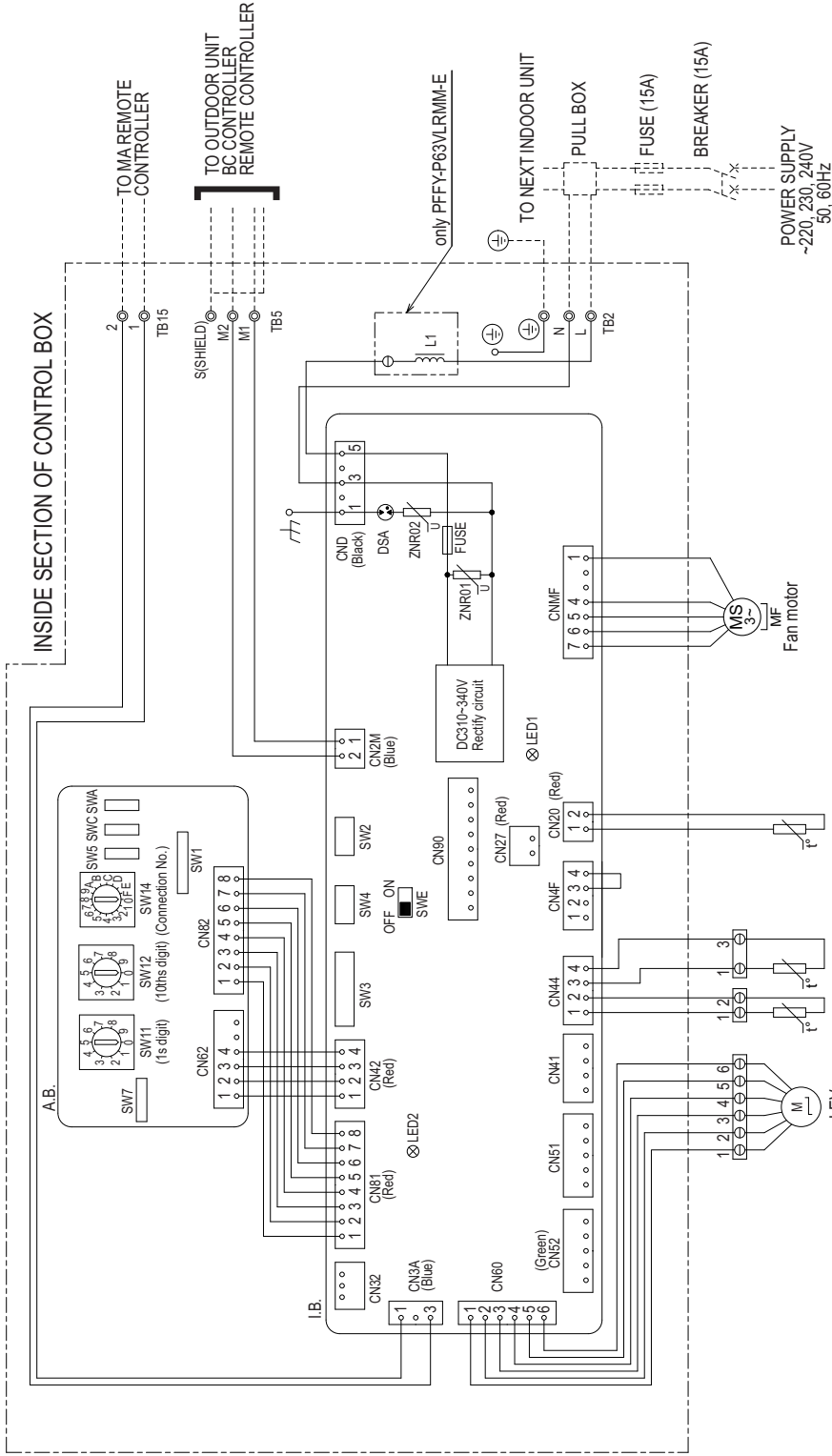

NOTE:1. The wirings to TB2, TB5, TB15 shown in dotted line are field work.
2. Mark ⊙ indicates terminal bed, ⊖ connector.

OPERATION OF LED FOR INDOOR CIRCUIT BOARD SERVICE

SYMBOL	LED operation under normal state
LED1	At applying main power source → Lighting
LED2	At receiving MA transmission power source → Lighting

SYMBOL EXPLANATION

SYMBOL	NAME	SYMBOL	NAME
I.B.	Indoor controller board	A.B.	Address board
FUSE	Fuse <AC250V 6.3A>	SW1	Switch (for mode selection)
ZNR01,02	Varistor	SW5	Switch (for mode selection)
DSA	Arrestor	SW7	Switch (for model selection)
CN27	Connector (Dampor)	SW11	Switch (1s digit address set)
CN32	Connector (Remote switch)	SW12	Switch (10ths digit address set)
CN41	Connector (HA terminal-A)	SW14	Switch (connection No.set)
CN51	Connector (Centrally control)	SWA	Switch (for static pressure selection)
CN52	Connector (Remote indication)	SWC	Switch (for static pressure selection)
CN90	Connector (Wireless)	TB2	Power source terminal bed
SW2	Switch (for capacity code)	TB5	Transmission terminal bed
SW3	Switch (for mode selection)	TB15	Transmission terminal bed
SW4	Switch (for model selection)	TH21	Thermistor (inlet air temp.detection)
SW5	Connector (emergency operation)	TH22	Thermistor (piping temp.detection/liquid)
L1	AC reactor(Power factor improvement)	TH23	Thermistor (piping temp.detection/gas)
		LEV	Electronic linear expans.valve

5-1. Sound levels

PFFY-P-VKM-E2, VLEM-E, VLRM-E

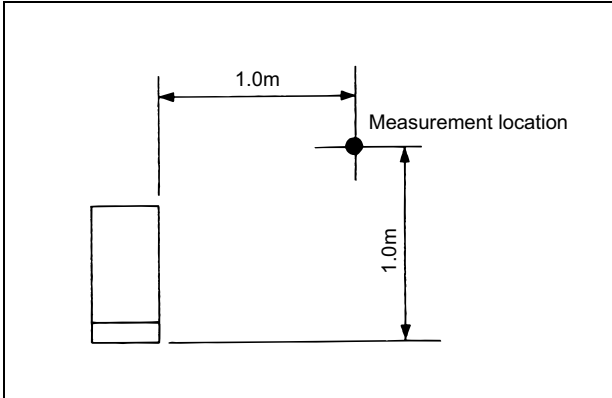

* Measured in anechoic room

Sound level at anechoic room : Low-High

	Sound level dB (A)
PFFY-P20VKM-E2	27-31-34-37
PFFY-P25VKM-E2	28-32-35-38
PFFY-P32VKM-E2	28-32-35-38
PFFY-P40VKM-E2	35-38-42-44
PFFY-P20VLEM-E	34-40
PFFY-P20VLRM-E	
PFFY-P25VLEM-E	
PFFY-P25VLRM-E	35-40
PFFY-P32VLEM-E	
PFFY-P32VLRM-E	38-43
PFFY-P40VLEM-E	
PFFY-P40VLRM-E	
PFFY-P50VLEM-E	40-46
PFFY-P50VLRM-E	
PFFY-P63VLEM-E	40-46
PFFY-P63VLRM-E	

PFFY-P-VLRMM-E

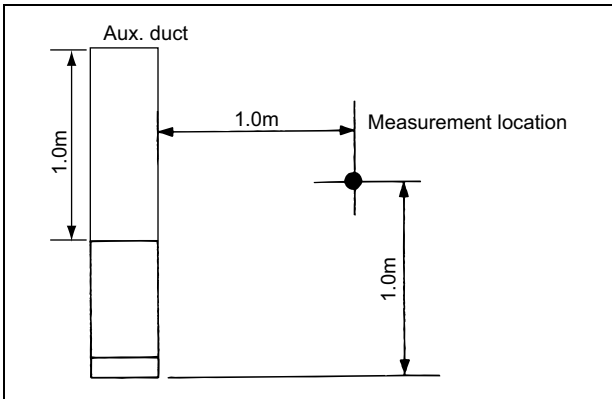

* Measured in anechoic room

Sound level at anechoic room : Low-Middle-High

	Sound level dB (A)		
	20Pa	40Pa	60Pa
PFFY-P20VLRMM-E	31-36-40	34-39-42	35-40-43
PFFY-P25VLRMM-E	31-36-40	34-39-42	35-40-43
PFFY-P32VLRMM-E	27-32-37	30-35-41	32-37-42
PFFY-P40VLRMM-E	30-36-40	32-38-42	35-39-44
PFFY-P50VLRMM-E	32-37-41	35-40-44	36-41-45
PFFY-P63VLRMM-E	35-40-44	36-42-47	38-43-48

5-2. NC curves

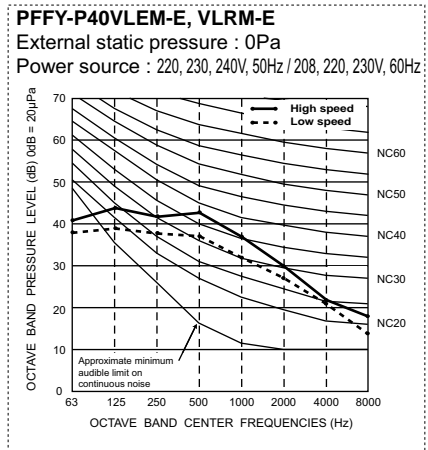
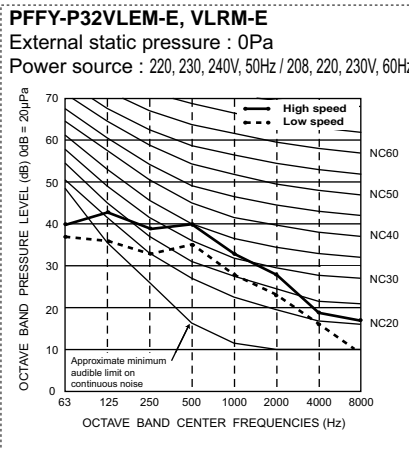
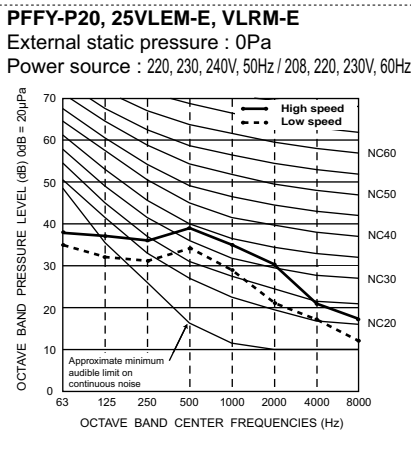
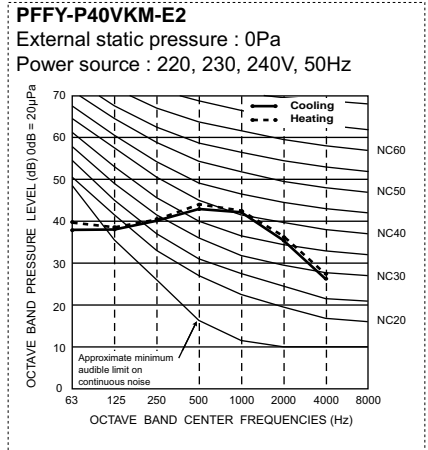
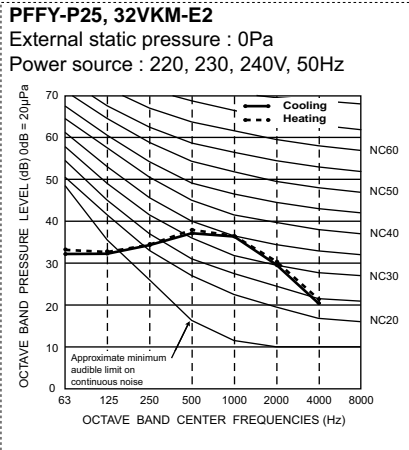
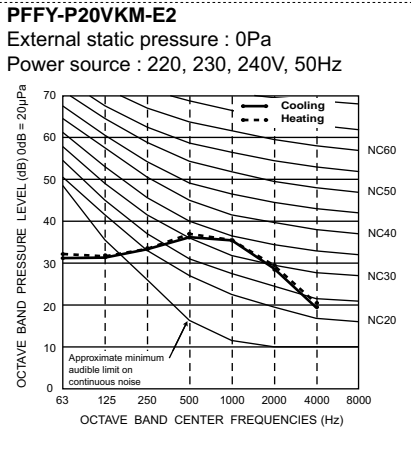

PFFY-P50VLEM-E2, VLRM-E
 External static pressure : 0Pa
 Power source : 220, 230, 240V, 50Hz / 208, 220, 230V, 60Hz

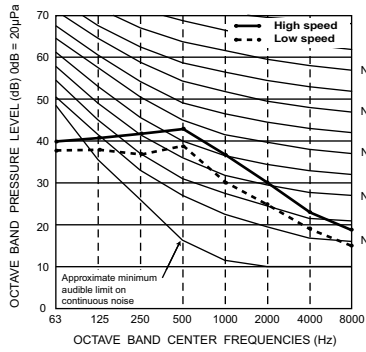

PFFY-P63VLEM-E, VLRM-E
 External static pressure : 0Pa
 Power source : 220, 230, 240V, 50Hz / 208, 220, 230V, 60Hz

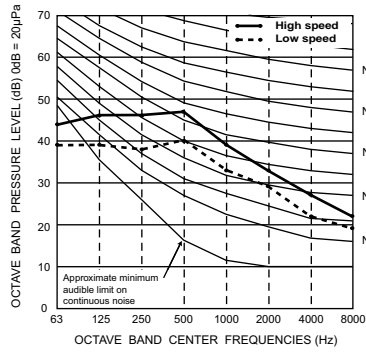

PFFY-P20, 25VLRMM-E
 External static pressure : 20Pa
 Power source : 220, 230, 240V, 50/60Hz

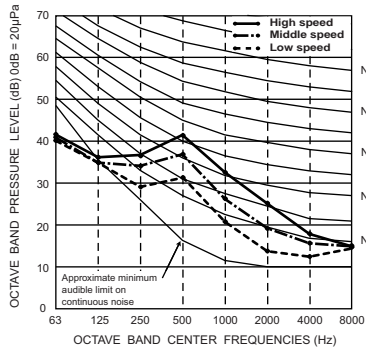

PFFY-P20, 25VLRMM-E
 External static pressure : 40Pa
 Power source : 220, 230, 240V, 50/60Hz

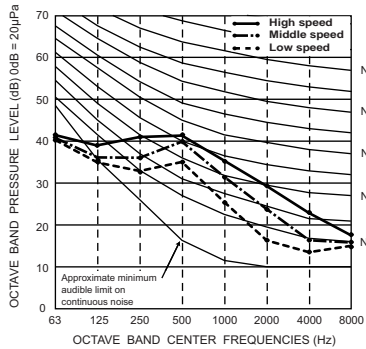

PFFY-P20, 25VLRMM-E
 External static pressure : 60Pa
 Power source : 220, 230, 240V, 50/60Hz

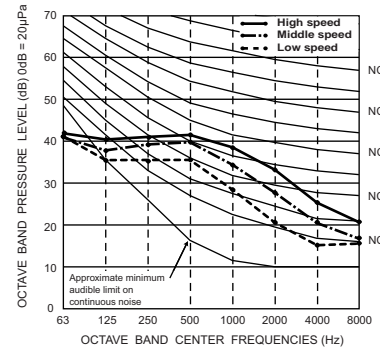

PFFY-P32VLRMM-E
 External static pressure : 20Pa
 Power source : 220, 230, 240V, 50/60Hz

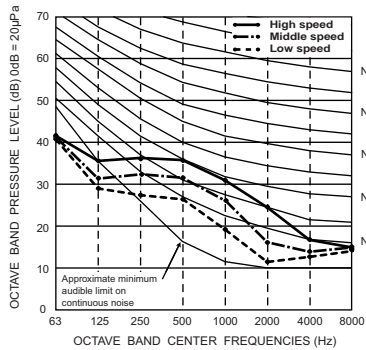

PFFY-P32VLRMM-E
 External static pressure : 40Pa
 Power source : 220, 230, 240V, 50/60Hz

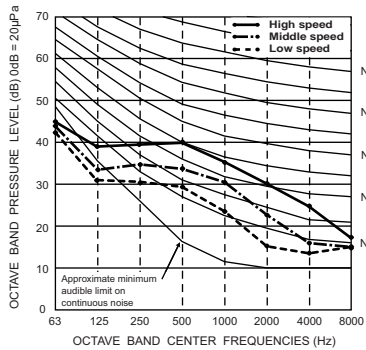

PFFY-P32VLRMM-E
 External static pressure : 60Pa
 Power source : 220, 230, 240V, 50/60Hz

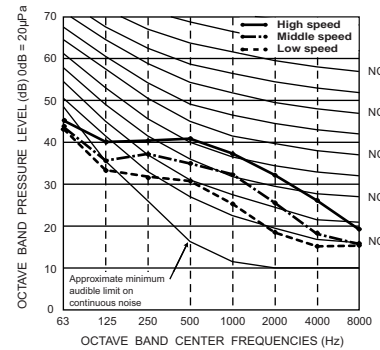

PFFY-P40VLRMM-E
 External static pressure : 20Pa
 Power source : 220, 230, 240V, 50/60Hz

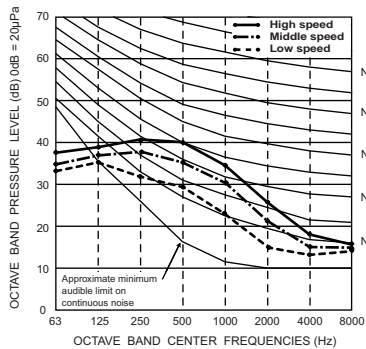

PFFY-P40VLRMM-E
 External static pressure : 40Pa
 Power source : 220, 230, 240V, 50/60Hz

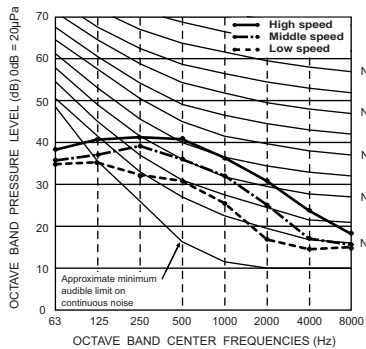

PFFY-P40VLRMM-E
 External static pressure : 60Pa
 Power source : 220, 230, 240V, 50/60Hz

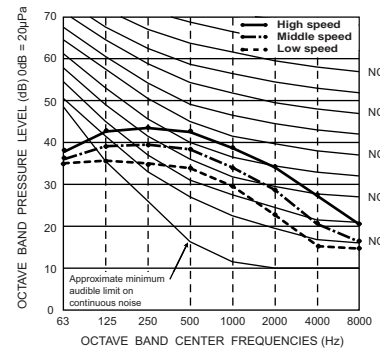

PFFY

PFFY-P50VLRMM-E
 External static pressure : 20Pa
 Power source : 220, 230, 240V, 50/60Hz

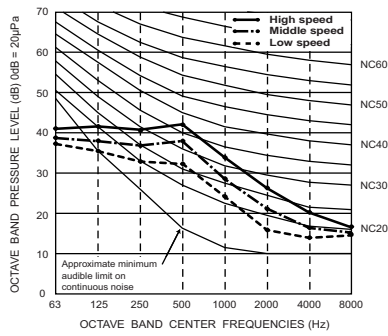

PFFY-P50VLRMM-E
 External static pressure : 40Pa
 Power source : 220, 230, 240V, 50/60Hz

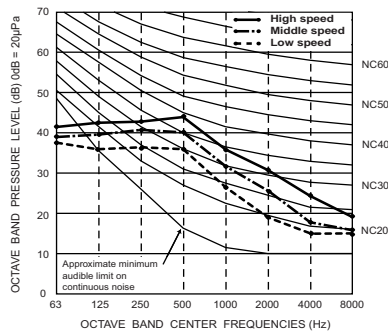

PFFY-P50VLRMM-E
 External static pressure : 60Pa
 Power source : 220, 230, 240V, 50/60Hz

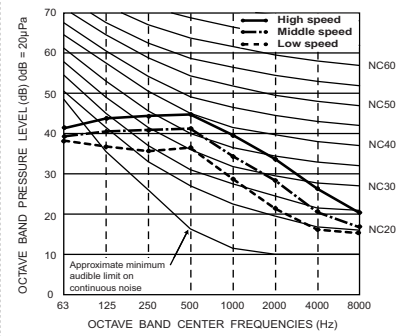

PFFY-P63VLRMM-E
 External static pressure : 20Pa
 Power source : 220, 230, 240V, 50/60Hz

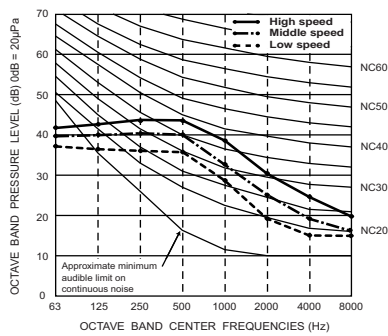

PFFY-P63VLRMM-E
 External static pressure : 40Pa
 Power source : 220, 230, 240V, 50/60Hz

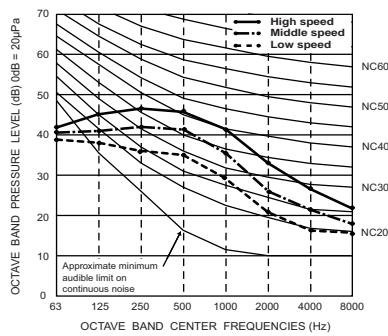

PFFY-P63VLRMM-E
 External static pressure : 60Pa
 Power source : 220, 230, 240V, 50/60Hz

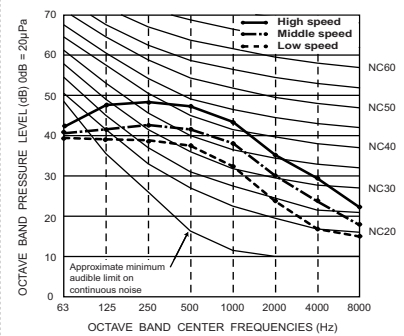

6. FAN CHARACTERISTICS CURVES

YKB/YLM

PFFY-P20, 25VLRMM-E

External static pressure : 20Pa
Power source : 220,230,240V, 50/60Hz

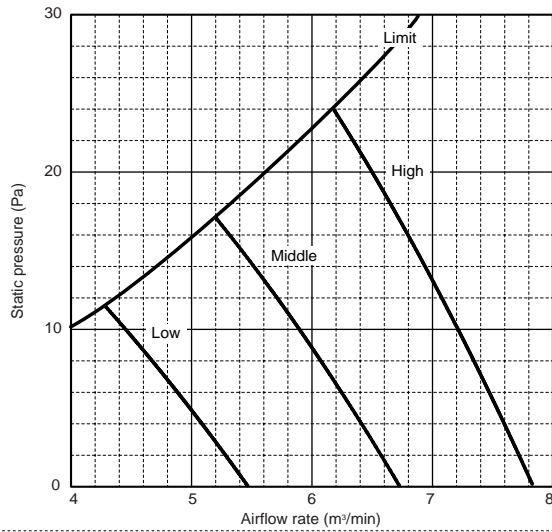

PFFY-P20, 25VLRMM-E

External static pressure : 40Pa
Power source : 220,230,240V, 50/60Hz

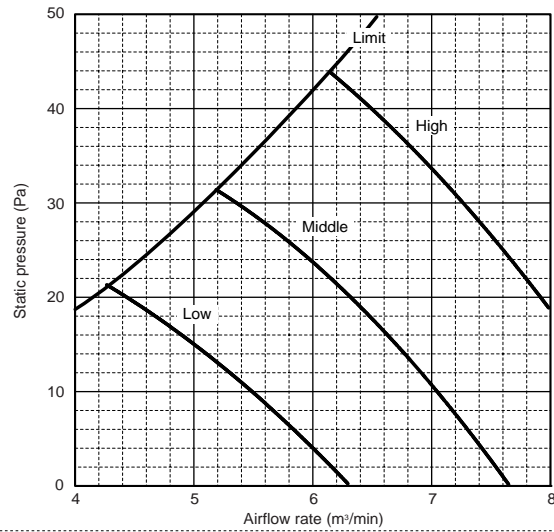

PFFY-P20, 25VLRMM-E

External static pressure : 60Pa
Power source : 220,230,240V, 50/60Hz

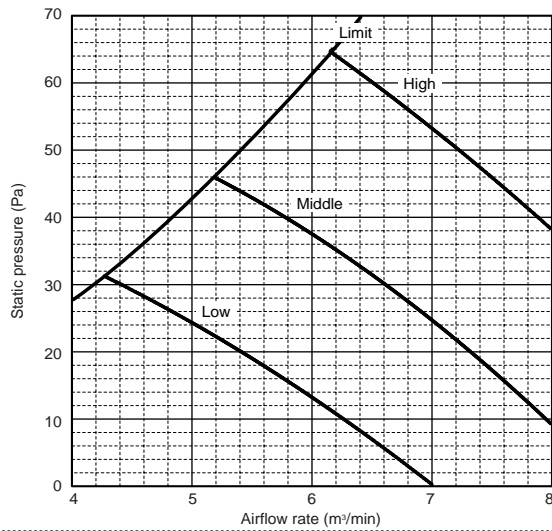

PFFY-P32VLRMM-E

External static pressure : 20Pa
Power source : 220,230,240V, 50/60Hz

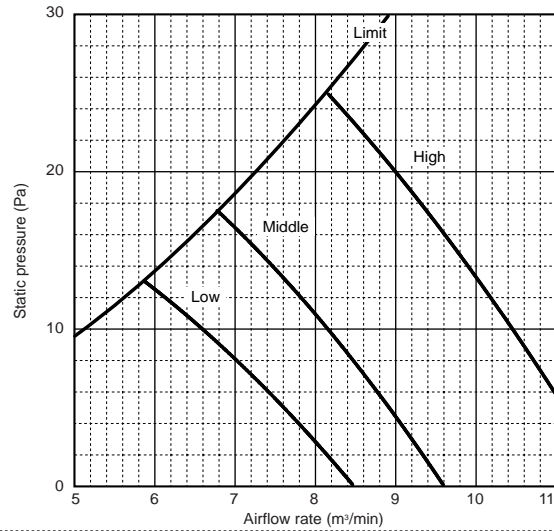

PFFY-P32VLRMM-E

External static pressure : 40Pa
Power source : 220,230,240V, 50/60Hz

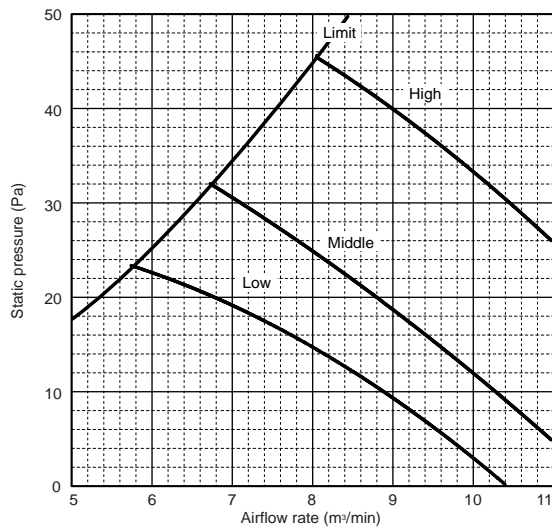

PFFY-P32VLRMM-E

External static pressure : 60Pa
Power source : 220,230,240V, 50/60Hz

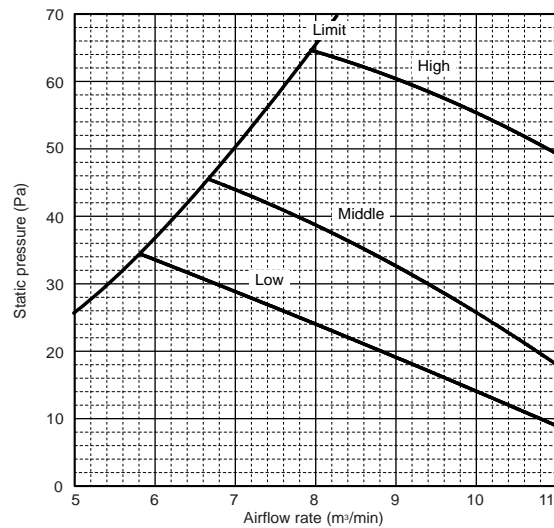

PFFY

PFFY-P40VLRMM-E

External static pressure : 20Pa
Power source : 220,230,240V, 50/60Hz

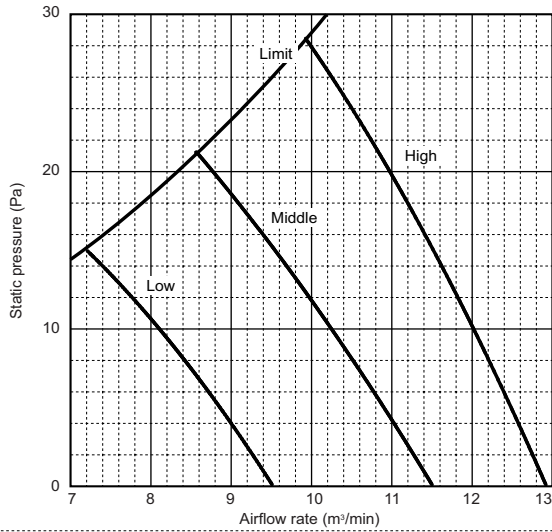

PFFY-P40VLRMM-E

External static pressure : 40Pa
Power source : 220,230,240V, 50/60Hz

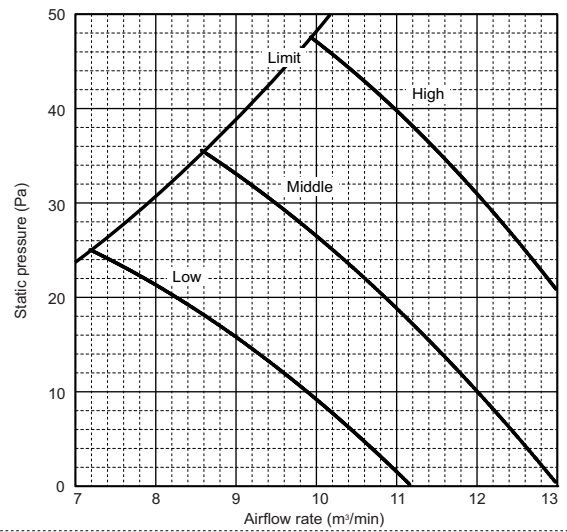

PFFY-P40VLRMM-E

External static pressure : 60Pa
Power source : 220,230,240V, 50/60Hz

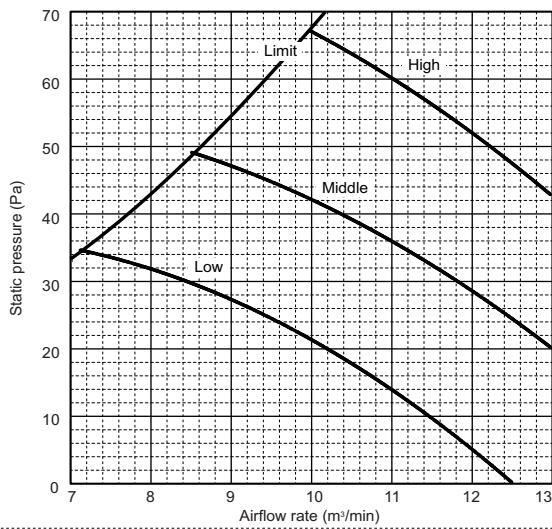

PFFY-P50VLRMM-E

External static pressure : 20Pa
Power source : 220,230,240V, 50/60Hz

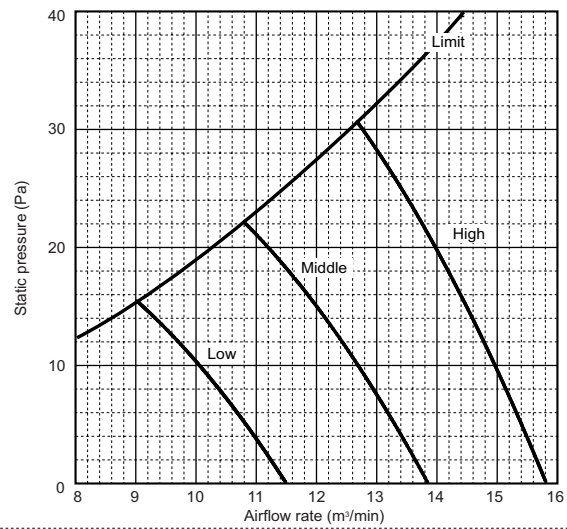

PFFY-P50VLRMM-E

External static pressure : 40Pa
Power source : 220,230,240V, 50/60Hz

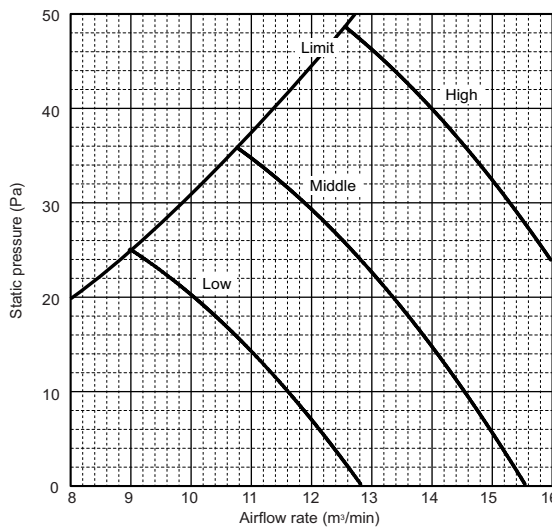

PFFY-P50VLRMM-E

External static pressure : 60Pa
Power source : 220,230,240V, 50/60Hz

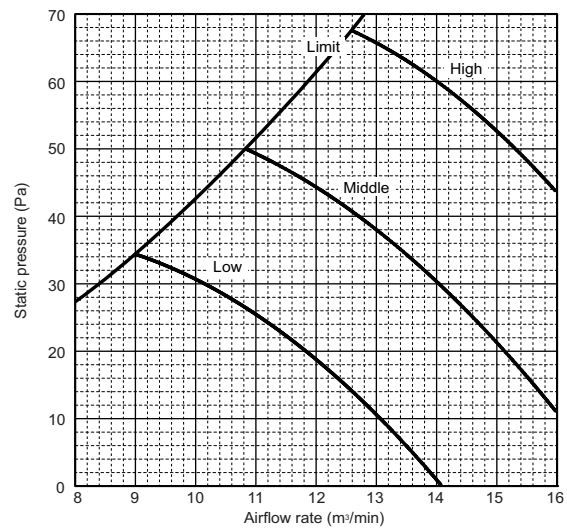

PFFY

6. FAN CHARACTERISTICS CURVES

YKB/YLM

PFFY-P63VLRMM-E

External static pressure : 20Pa
Power source : 220,230,240V, 50/60Hz

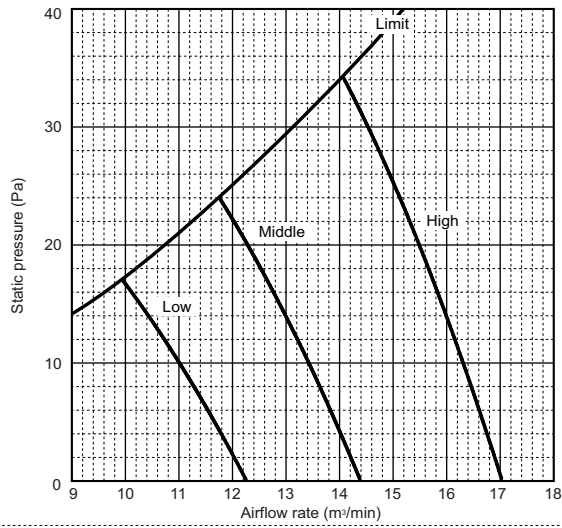

PFFY-P63VLRMM-E

External static pressure : 40Pa
Power source : 220,230,240V, 50/60Hz

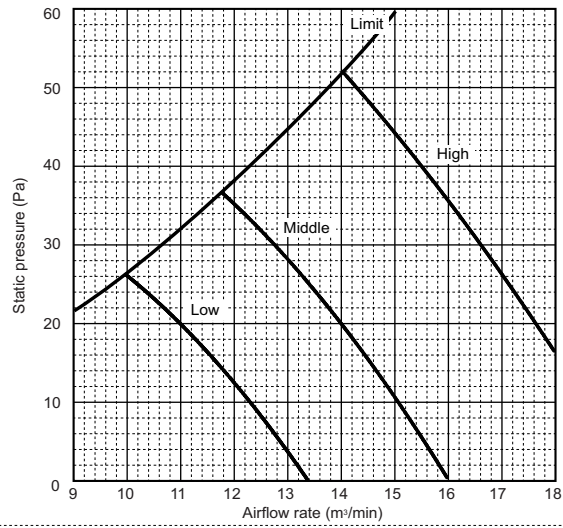

PFFY-P63VLRMM-E

External static pressure : 60Pa
Power source : 220,230,240V, 50/60Hz

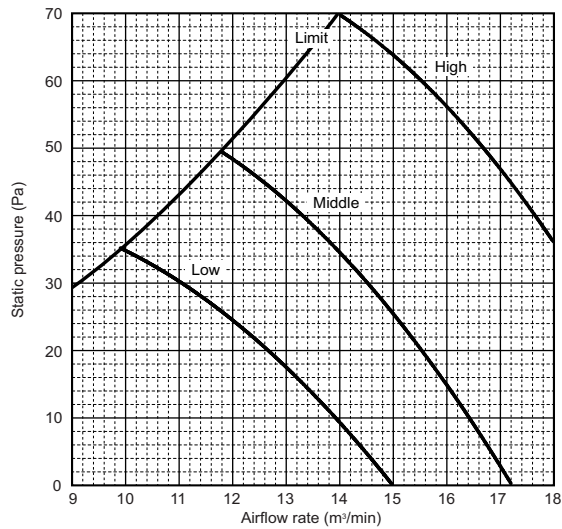

PFFY

7-1. Temperature distributions

PFFY-P20-63VLEM-E

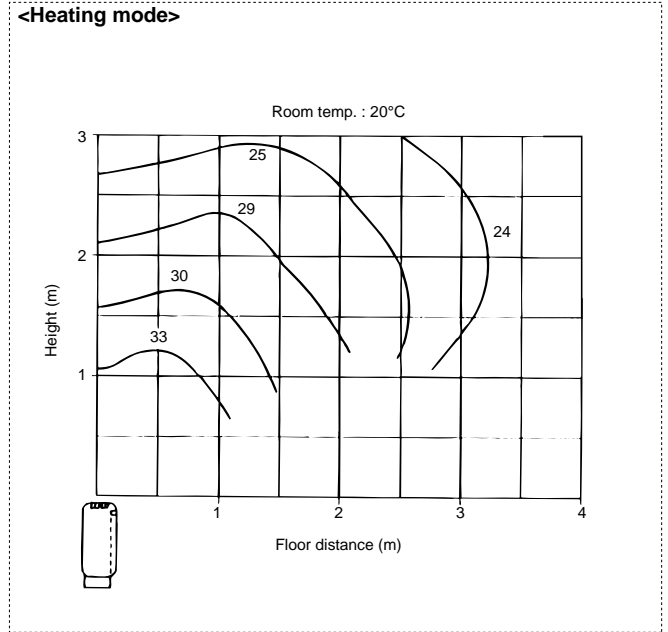
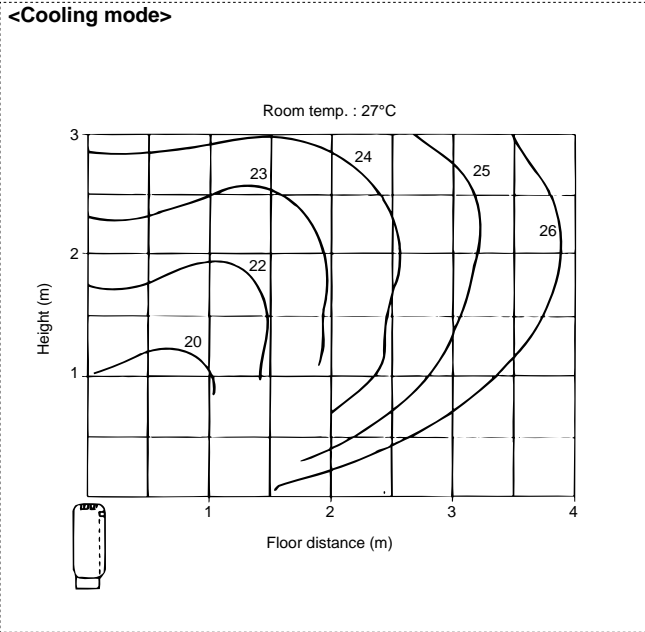

PFFY-P20-40VKM-E2

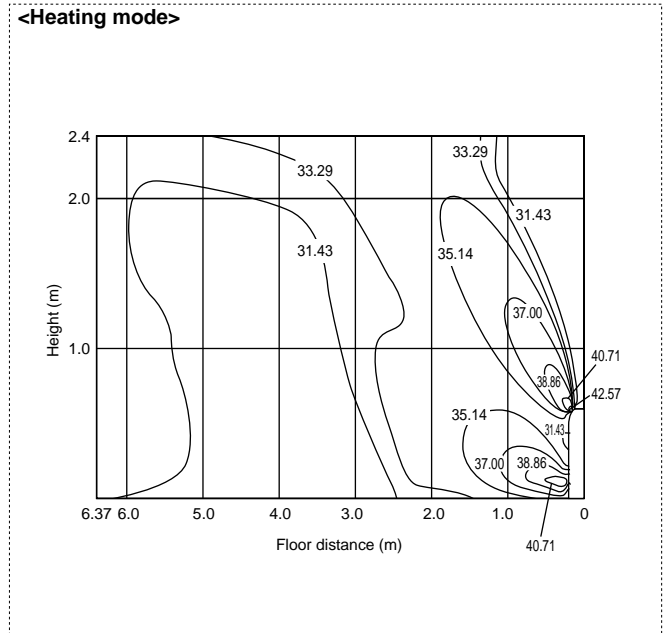
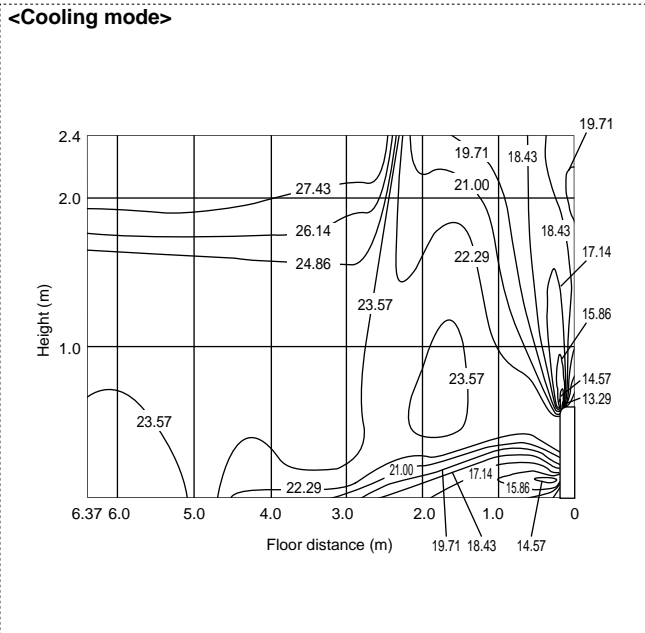

Note : These figures show typical temperature distributions in the conditions above. In the actual installation, the actual temperature distribution may differ from these figures under the influence of air temperature conditions, ceiling height, cooling/heating load, obstacles, etc.

PFFY

7-2. Airflow distributions

PFFY-P20-63VLEM-E

<Cooling mode>

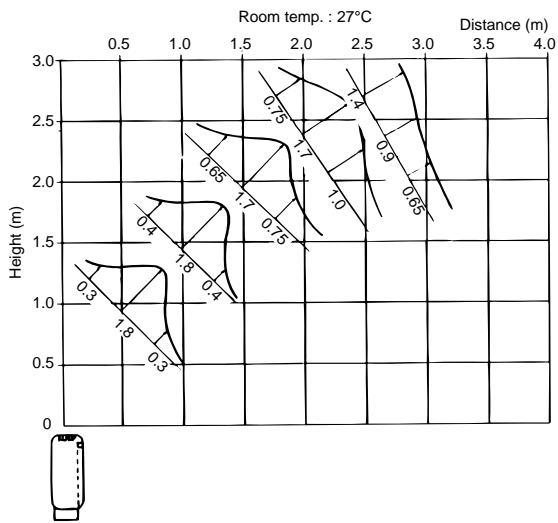

<Heating mode>

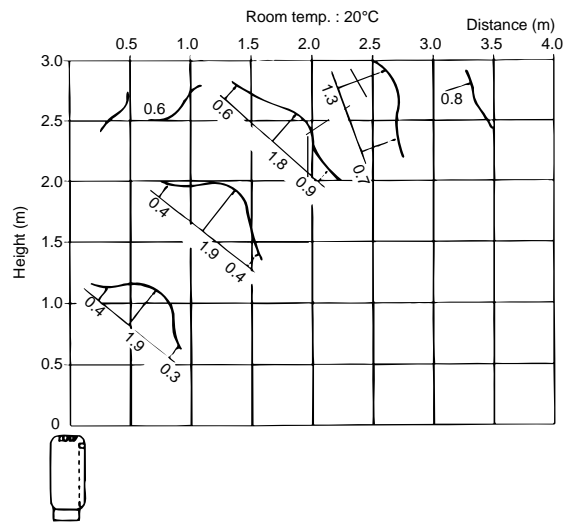

PFFY-P20-40VKM-E2

<Cooling mode>

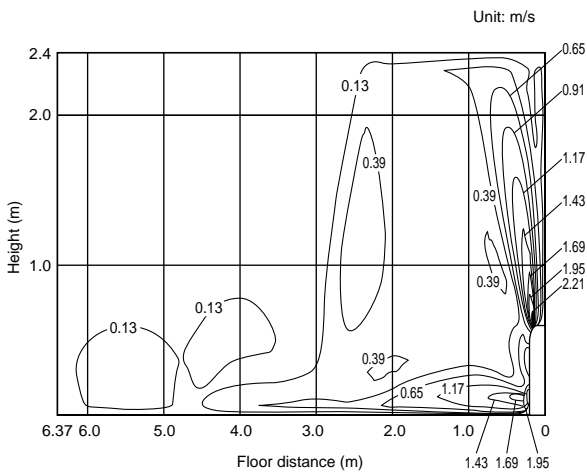

<Heating mode>

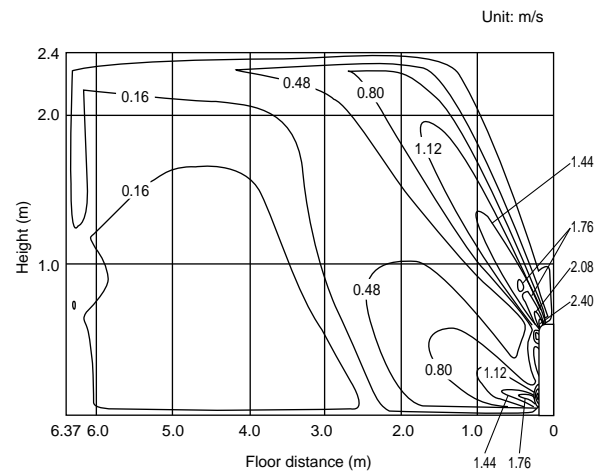

Note : These figures show typical airflow distributions in the conditions above. In the actual installation, the actual airflow distribution may differ from these figures under the influence of air temperature conditions, ceiling height, cooling/heating load, obstacles, etc.

LGH-RVX-E

1. EXTERNAL DIMENSIONS 1 - 205

2. PERFORMANCE 1 - 208

3. SPECIFICATIONS 1 - 210

4. SAMPLE INSTALLATIONS 1 - 213

5. ELECTRICAL WIRING DIAGRAMS 1 - 215

LOSSNAY

LOSSNAY is a perfect combination of heat recovery and ventilation, which is a leading edge product in the ventilation and air-conditioning field.

The LOSSNAY core is a special preserved paper made cross-flow and plate-fin structure, which is referable below.

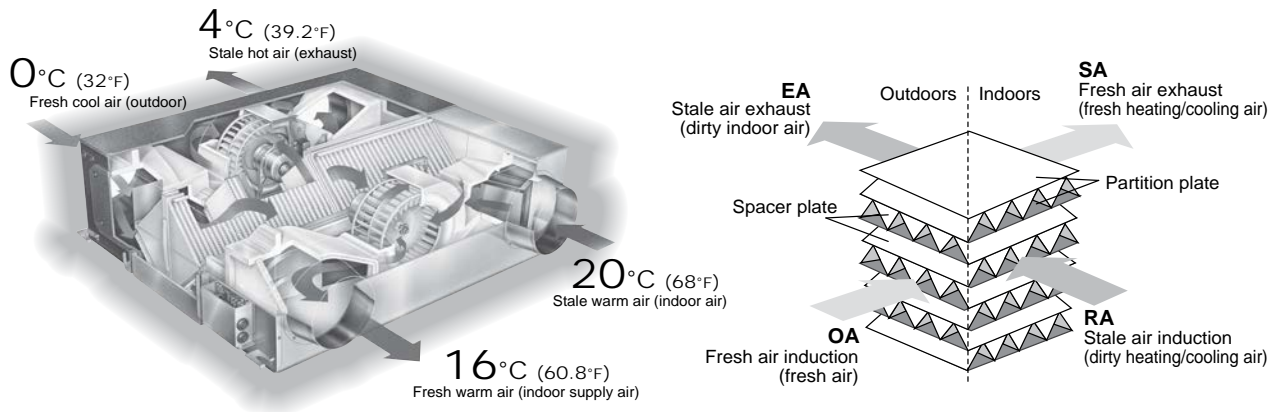

CITY MULTI can combine LOSSNAY into the air conditioning system, performing the best solution to ventilation and air-conditioning.

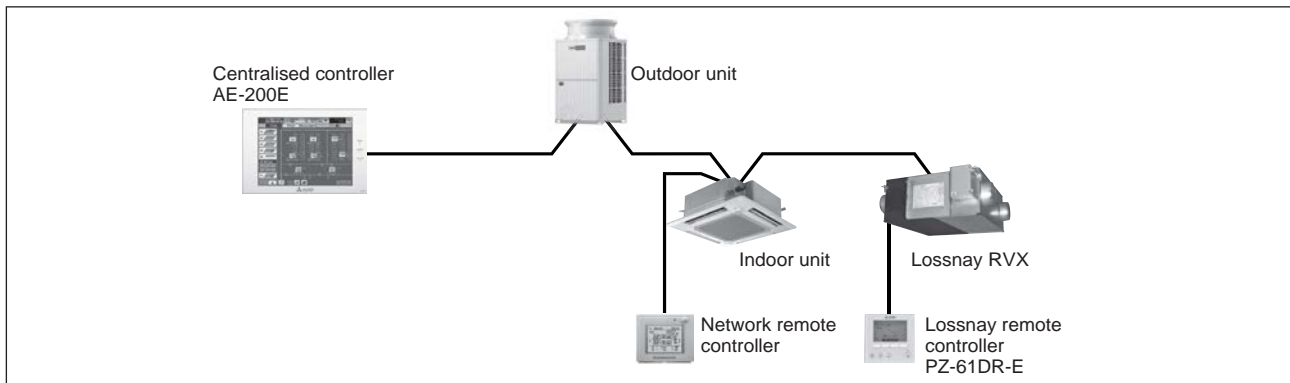

Line up of LOSSNAY units

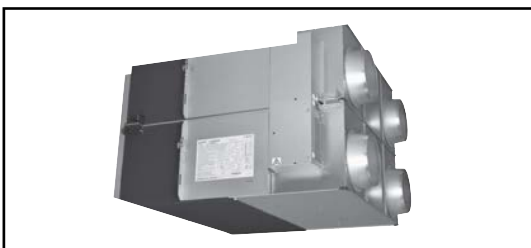

- LGH-15RVX-E [150m³/h Single phase 220-240V 50Hz/220V 60Hz]
- LGH-25RVX-E [250m³/h Single phase 220-240V 50Hz/220V 60Hz]
- LGH-35RVX-E [350m³/h Single phase 220-240V 50Hz/220V 60Hz]
- LGH-50RVX-E [500m³/h Single phase 220-240V 50Hz/220V 60Hz]
- LGH-65RVX-E [650m³/h Single phase 220-240V 50Hz/220V 60Hz]
- LGH-80RVX-E [800m³/h Single phase 220-240V 50Hz/220V 60Hz]
- LGH-100RVX-E [1000m³/h Single phase 220-240V 50Hz/220V 60Hz]
- LGH-150RVX-E [1500m³/h Single phase 220-240V 50Hz/220V 60Hz]
- LGH-200RVX-E [2000m³/h Single phase 220-240V 50Hz/220V 60Hz]

LOSSNAY

(Unit : mm)

LGH-15RVX-E

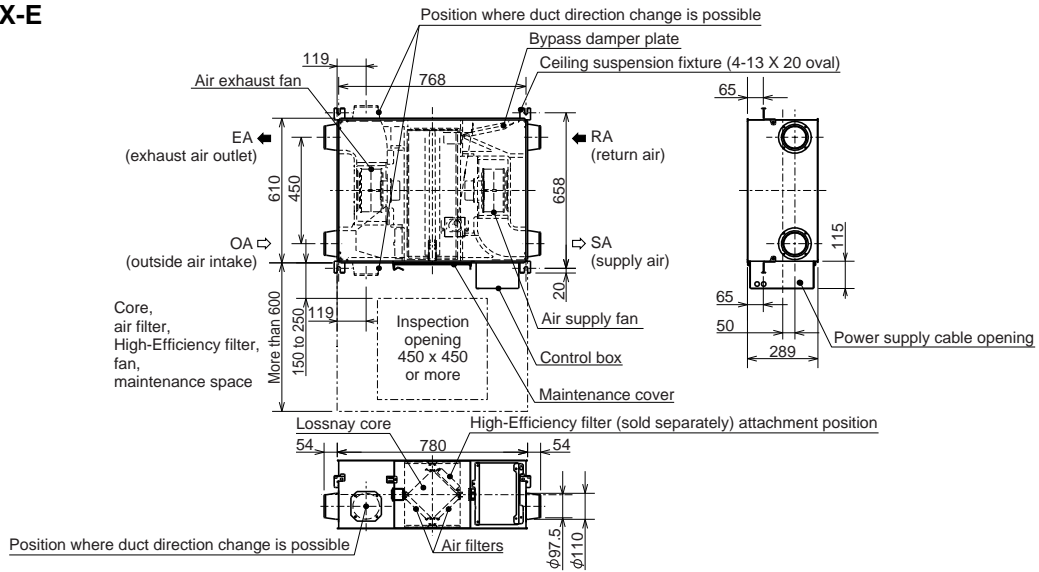

LGH-25RVX-E

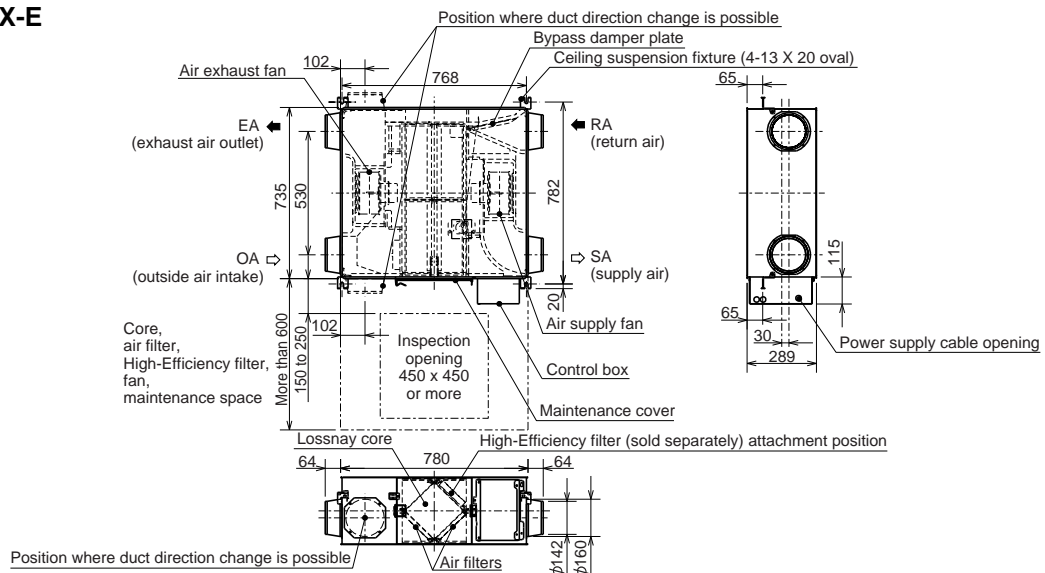

LGH-35RVX-E

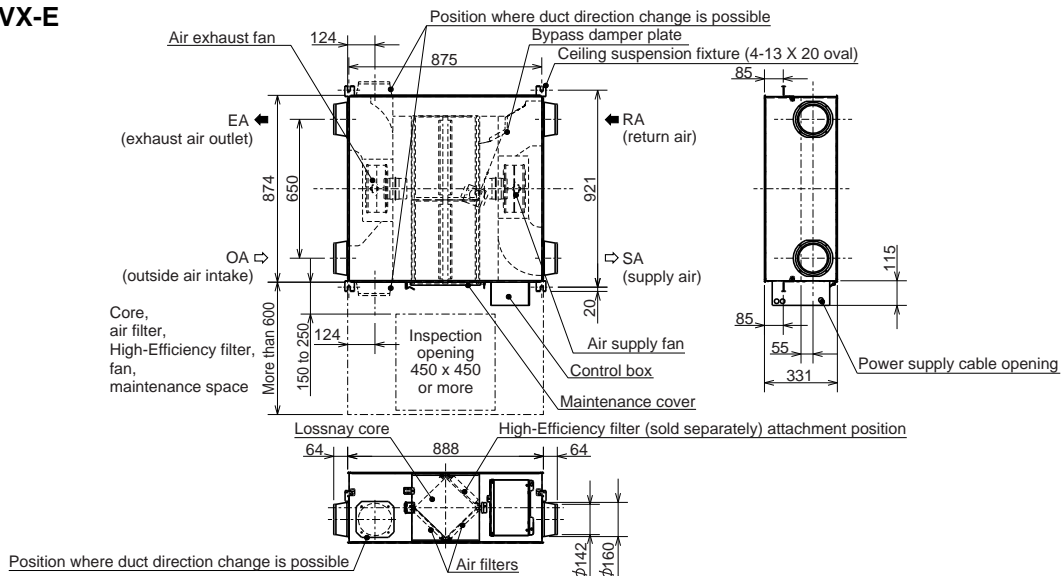

(Unit : mm)

LGH-50RVX-E

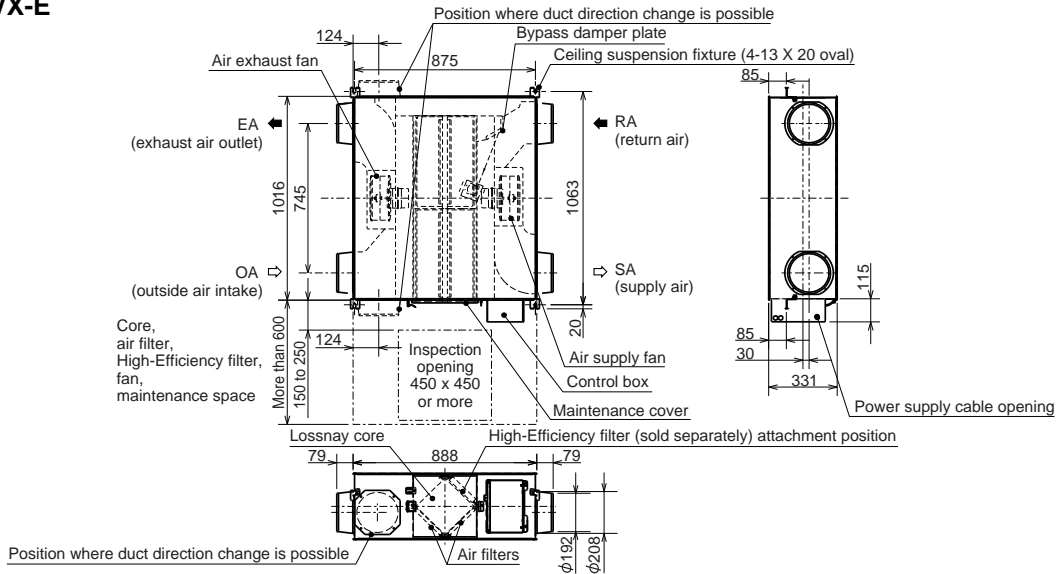

LGH-65RVX-E

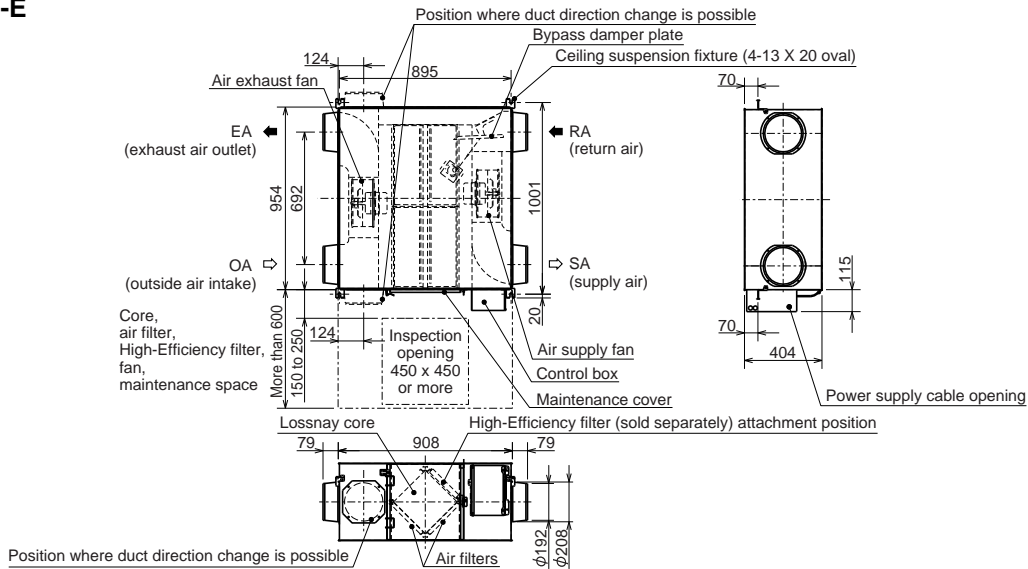

LGH-80RVX-E

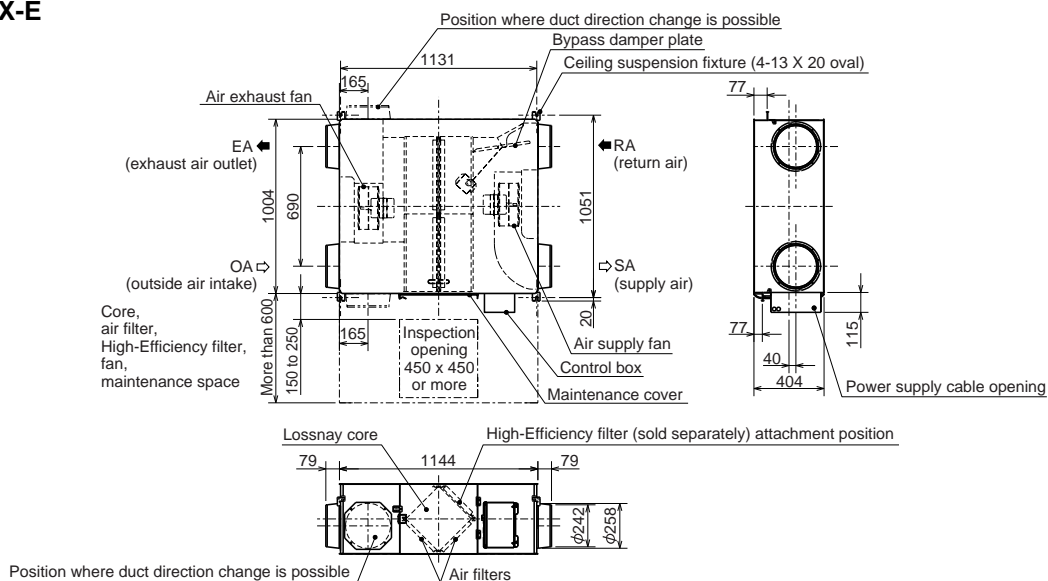

LOSSNAY

(Unit : mm)

LGH-100RVX-E

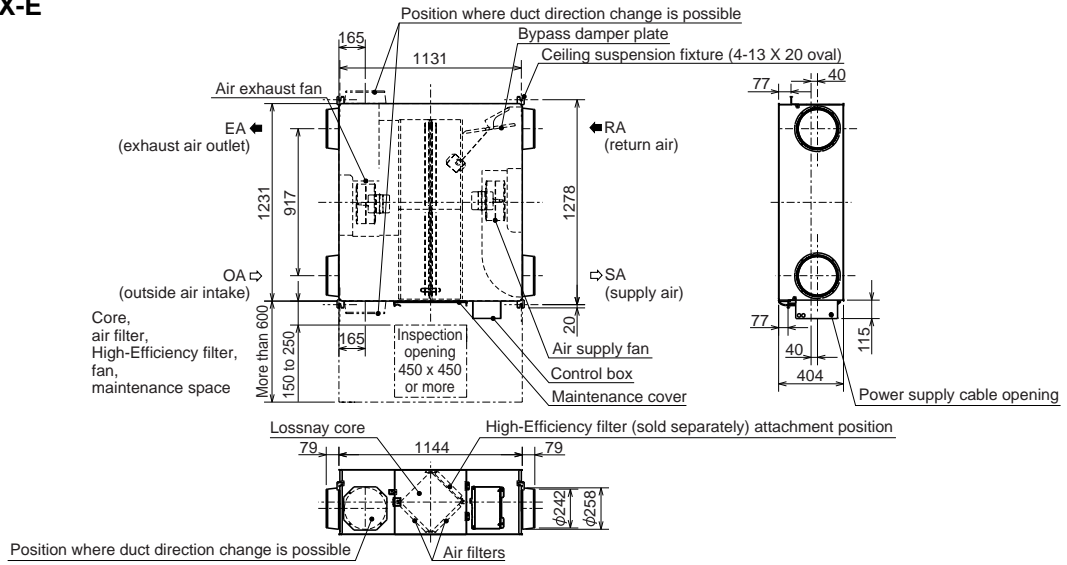

LGH-150RVX-E

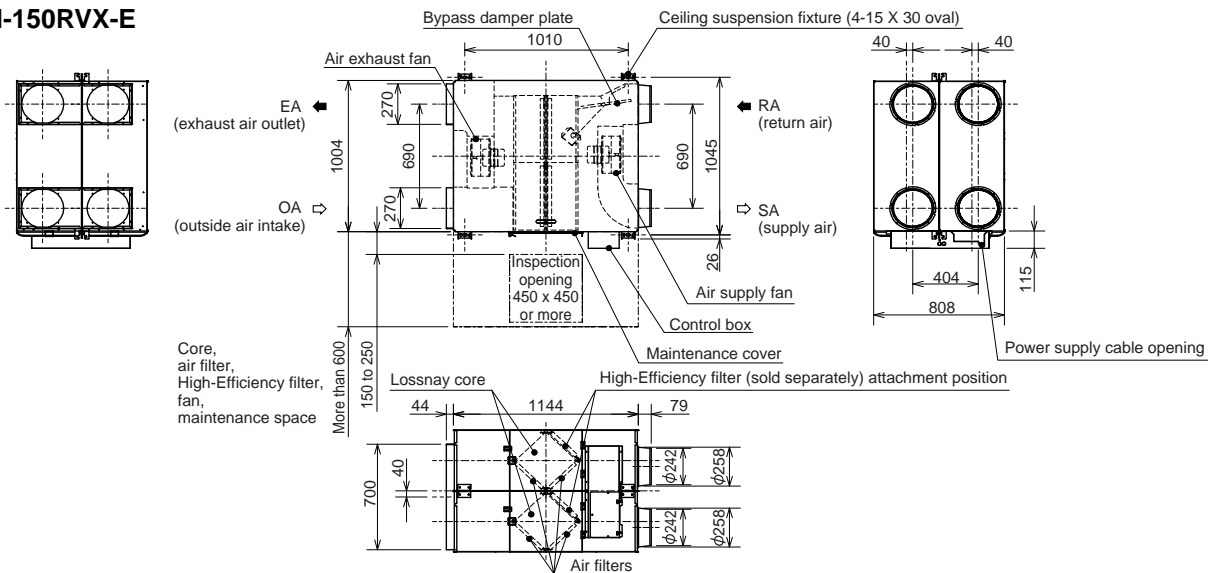

LGH-200RVX-E

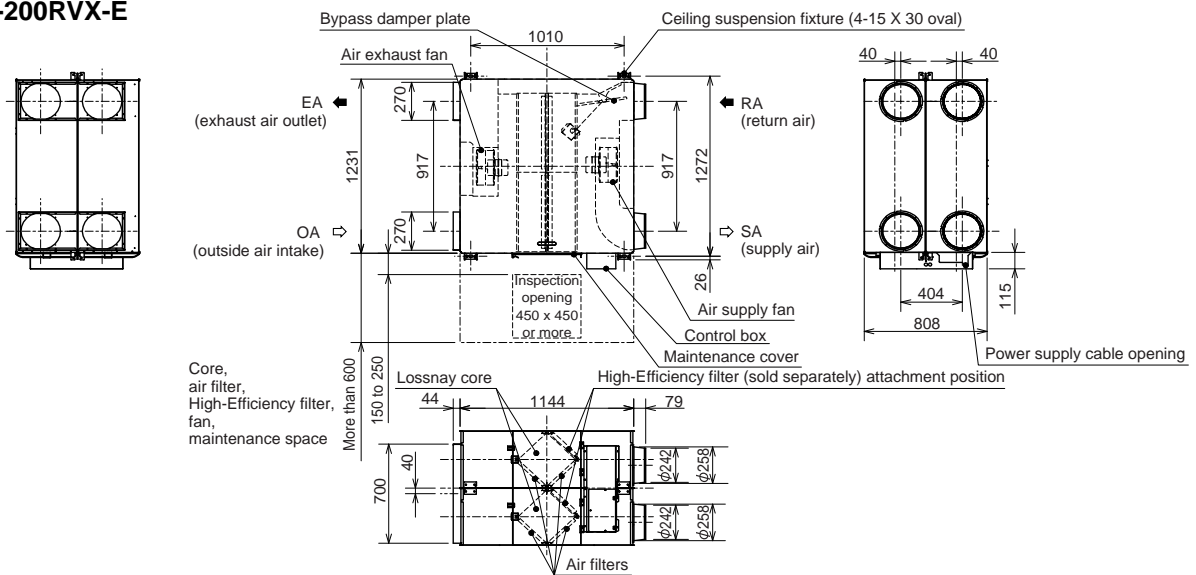

LOSSNAY

LGH-15RVX-E

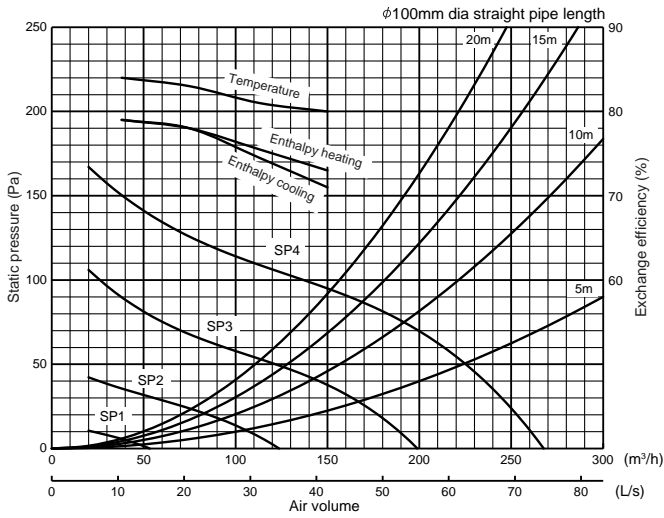

LGH-25RVX-E

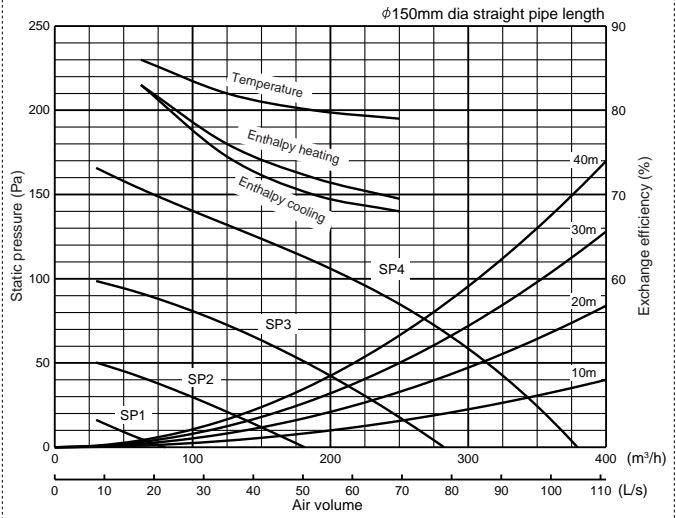

LGH-35RVX-E

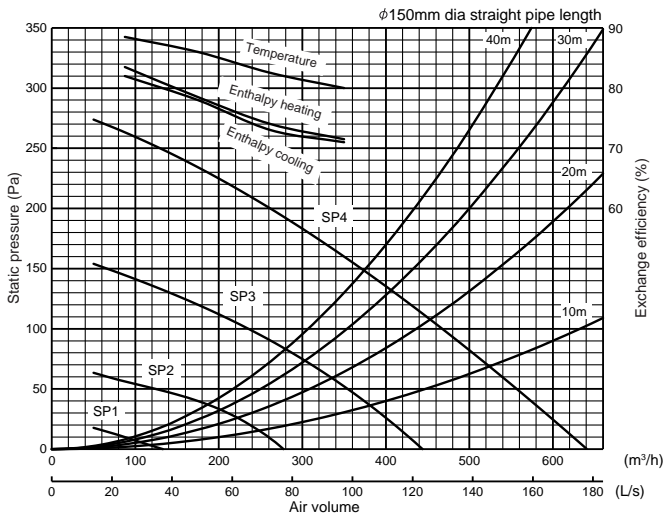

LGH-50RVX-E

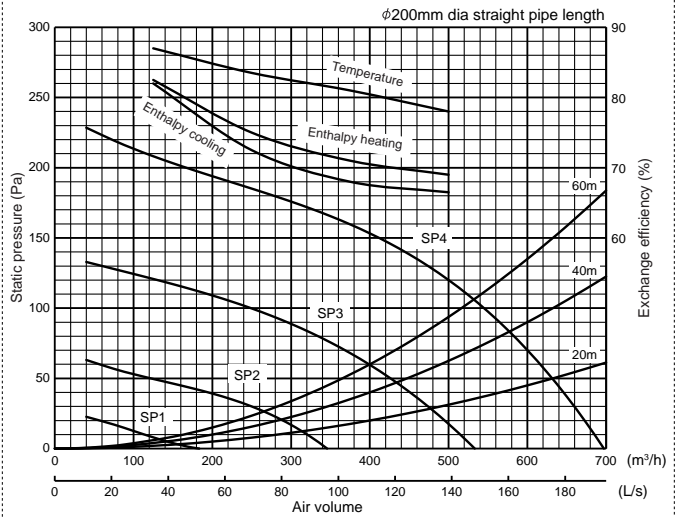

LGH-65RVX-E

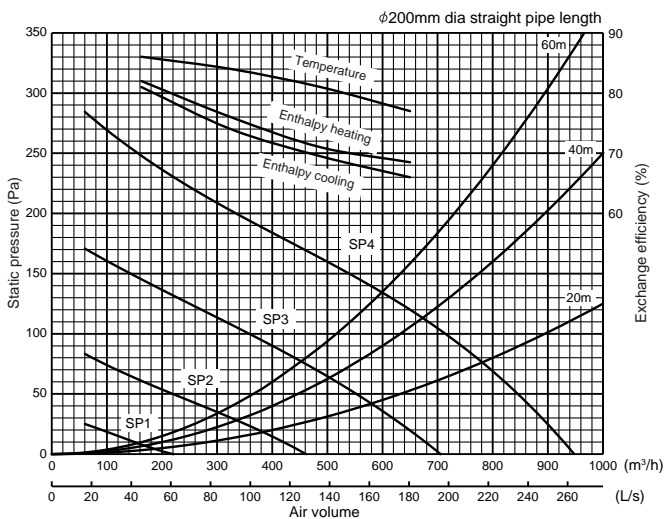

LGH-80RVX-E

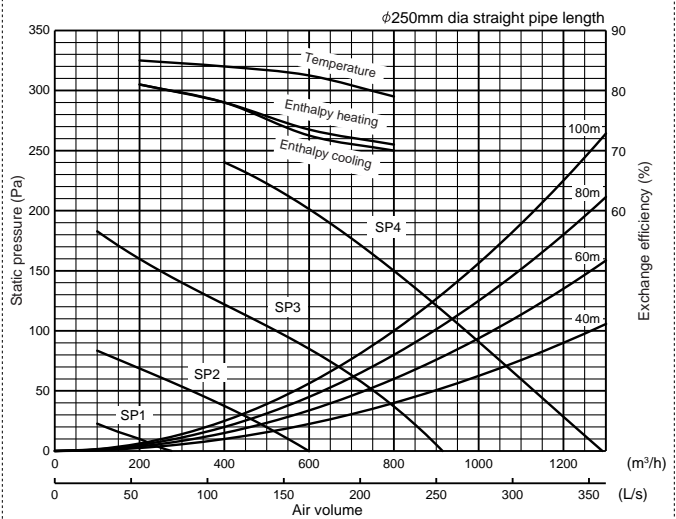

LOSSNAY

LGH-100RVX-E

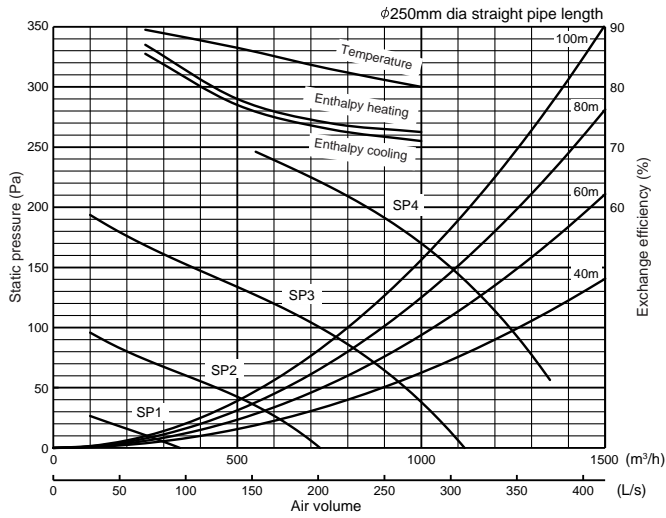

LGH-150RVX-E

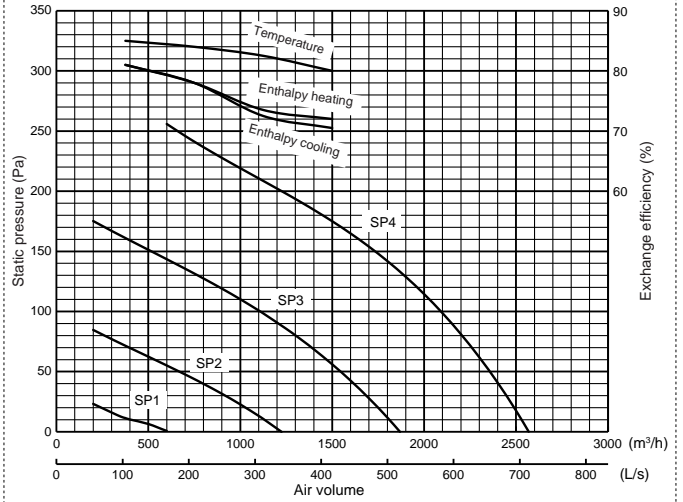

LGH-200RVX-E

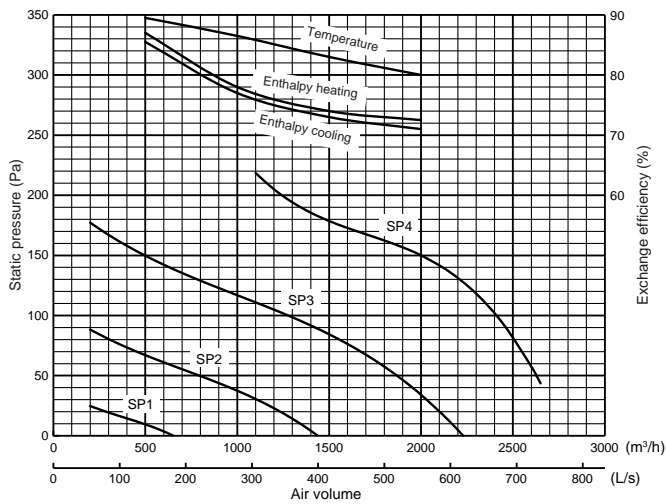

LOSSNAY

LGH-15RVX-E

Model		LGH-15RVX-E								
Electrical power supply		220-240V/50Hz, 220V/60Hz								
Ventilation mode		Heat recovery mode				Bypass mode				
Fan speed		SP4	SP3	SP2	SP1	SP4	SP3	SP2	SP1	
Running current (A)		0.40	0.24	0.15	0.10	0.41	0.25	0.15	0.10	
Input power (W)		49	28	14	7	52	28	14	8	
Air volume		(m ³ /h)	150	113	75	38	150	113	75	38
		(L/s)	42	31	21	10	42	31	21	10
External static pressure (Pa)		95	54	24	6	95	54	24	6	
Temperature exchange efficiency (%)		80.0	81.0	83.0	84.0	—	—	—	—	
Enthalpy exchange efficiency (%)		Heating	73.0	75.5	78.0	79.0	—	—	—	—
		Cooling	71.0	74.5	78.0	79.0	—	—	—	—
Noise (dB) (Measured at 1.5m under the center of unit in an anechoic chamber)		28.0	24.0	19.0	17.0	29.0	24.0	19.0	18.0	
Weight (kg)		20								

*The Air outlets noise (45° angle, 1.5meters in front of the unit) is about 13dB greater than the indicated value.(at Fan speed 4)

*The running current, the input power, the efficiency and the noise are based on the rating air volume, and 230V/50Hz.

*For the specification at the other frequency contact your dealer.

LGH-25RVX-E

Model		LGH-25RVX-E								
Electrical power supply		220-240V/50Hz, 220V/60Hz								
Ventilation mode		Heat recovery mode				Bypass mode				
Fan speed		SP4	SP3	SP2	SP1	SP4	SP3	SP2	SP1	
Running current (A)		0.48	0.28	0.16	0.10	0.48	0.29	0.16	0.11	
Input power (W)		62	33	16	7.5	63	35	17	9	
Air volume		(m ³ /h)	250	188	125	63	250	188	125	63
		(L/s)	69	52	35	17	69	52	35	17
External static pressure (Pa)		85	48	21	5	85	48	21	5	
Temperature exchange efficiency (%)		79.0	80.0	82.0	86.0	—	—	—	—	
Enthalpy exchange efficiency (%)		Heating	69.5	72.0	76.0	83.0	—	—	—	—
		Cooling	68.0	70.0	74.5	83.0	—	—	—	—
Noise (dB) (Measured at 1.5m under the center of unit in an anechoic chamber)		27.0	22.0	20.0	17.0	27.5	23.0	20.0	17.0	
Weight (kg)		23								

*The Air outlets noise (45° angle, 1.5meters in front of the unit) is about 15dB greater than the indicated value.(at Fan speed 4)

*The running current, the input power, the efficiency and the noise are based on the rating air volume, and 230V/50Hz.

*For the specification at the other frequency contact your dealer.

LGH-35RVX-E

Model		LGH-35RVX-E								
Electrical power supply		220-240V/50Hz, 220V/60Hz								
Ventilation mode		Heat recovery mode				Bypass mode				
Fan speed		SP4	SP3	SP2	SP1	SP4	SP3	SP2	SP1	
Running current (A)		0.98	0.54	0.26	0.12	0.98	0.56	0.28	0.13	
Input power (W)		140	70	31	11	145	72	35	13	
Air volume		(m ³ /h)	350	263	175	88	350	263	175	88
		(L/s)	97	73	49	24	97	73	49	24
External static pressure (Pa)		160	90	40	10	160	90	40	10	
Temperature exchange efficiency (%)		80.0	82.5	86.0	88.5	—	—	—	—	
Enthalpy exchange efficiency (%)		Heating	71.5	74.0	78.5	83.5	—	—	—	—
		Cooling	71.0	73.0	78.0	82.0	—	—	—	—
Noise (dB) (Measured at 1.5m under the center of unit in an anechoic chamber)		32.0	28.0	20.0	17.0	32.5	28.0	20.0	18.0	
Weight (kg)		30								

*The Air outlets noise (45° angle, 1.5meters in front of the unit) is about 12dB greater than the indicated value.(at Fan speed 4)

*The running current, the input power, the efficiency and the noise are based on the rating air volume, and 230V/50Hz.

*For the specification at the other frequency contact your dealer.

LGH-50RVX-E

Model		LGH-50RVX-E							
Electrical power supply		220-240V/50Hz, 220V/60Hz							
Ventilation mode		Heat recovery mode				Bypass mode			
Fan speed		SP4	SP3	SP2	SP1	SP4	SP3	SP2	SP1
Running current (A)		1.15	0.59	0.26	0.13	1.15	0.59	0.27	0.13
Input power (W)		165	78	32	12	173	81	35	14
Air volume	(m ³ /h)	500	375	250	125	500	375	250	125
	(L/s)	139	104	69	35	139	104	69	35
External static pressure (Pa)		120	68	30	8	120	68	30	8
Temperature exchange efficiency (%)		78.0	81.0	83.5	87.0	—	—	—	—
Enthalpy exchange efficiency (%)	Heating	69.0	71.0	75.0	82.5	—	—	—	—
	Cooling	66.5	68.0	72.5	82.0	—	—	—	—
Noise (dB) (Measured at 1.5m under the center of unit in an anechoic chamber)		34.0	28.0	19.0	18.0	35.0	29.0	20.0	18.0
Weight (kg)		33							

*The Air outlets noise (45° angle, 1.5meters in front of the unit) is about 18dB greater than the indicated value.(at Fan speed 4)

*The running current, the input power, the efficiency and the noise are based on the rating air volume, and 230V/50Hz.

*For the specification at the other frequency contact your dealer.

LGH-65RVX-E

Model		LGH-65RVX-E							
Electrical power supply		220-240V/50Hz, 220V/60Hz							
Ventilation mode		Heat recovery mode				Bypass mode			
Fan speed		SP4	SP3	SP2	SP1	SP4	SP3	SP2	SP1
Running current (A)		1.65	0.90	0.39	0.15	1.72	0.86	0.38	0.16
Input power (W)		252	131	49	15	262	131	47	17
Air volume	(m ³ /h)	650	488	325	163	650	488	325	163
	(L/s)	181	135	90	45	181	135	90	45
External static pressure (Pa)		120	68	30	8	120	68	30	8
Temperature exchange efficiency (%)		77.0	81.0	84.0	86.0	—	—	—	—
Enthalpy exchange efficiency (%)	Heating	68.5	71.0	76.0	82.0	—	—	—	—
	Cooling	66.0	69.5	74.0	81.0	—	—	—	—
Noise (dB) (Measured at 1.5m under the center of unit in an anechoic chamber)		34.5	29.0	22.0	18.0	35.5	29.0	22.0	18.0
Weight (kg)		38							

*The Air outlets noise (45° angle, 1.5meters in front of the unit) is about 16dB greater than the indicated value.(at Fan speed 4)

*The running current, the input power, the efficiency and the noise are based on the rating air volume, and 230V/50Hz.

*For the specification at the other frequency contact your dealer.

LGH-80RVX-E

Model		LGH-80RVX-E							
Electrical power supply		220-240V/50Hz, 220V/60Hz							
Ventilation mode		Heat recovery mode				Bypass mode			
Fan speed		SP4	SP3	SP2	SP1	SP4	SP3	SP2	SP1
Running current (A)		1.82	0.83	0.36	0.15	1.97	0.86	0.40	0.15
Input power (W)		335	151	60	18	340	151	64	20
Air volume	(m ³ /h)	800	600	400	200	800	600	400	200
	(L/s)	222	167	111	56	222	167	111	56
External static pressure (Pa)		150	85	38	10	150	85	38	10
Temperature exchange efficiency (%)		79.0	82.5	84.0	85.0	—	—	—	—
Enthalpy exchange efficiency (%)	Heating	71.0	73.5	78.0	81.0	—	—	—	—
	Cooling	70.0	72.5	78.0	81.0	—	—	—	—
Noise (dB) (Measured at 1.5m under the center of unit in an anechoic chamber)		34.5	30.0	23.0	18.0	36.0	30.0	23.0	18.0
Weight (kg)		48							

*The Air outlets noise (45° angle, 1.5meters in front of the unit) is about 24dB greater than the indicated value.(at Fan speed 4)

*The running current, the input power, the efficiency and the noise are based on the rating air volume, and 230V/50Hz.

*For the specification at the other frequency contact your dealer.

*Use this unit with static pressure 240Pa or less at Fan speed4. Otherwise the noise level might be larger.

LGH-100RVX-E

Model		LGH-100RVX-E								
Electrical power supply		220-240V/50Hz, 220V/60Hz								
Ventilation mode		Heat recovery mode				Bypass mode				
Fan speed		SP4	SP3	SP2	SP1	SP4	SP3	SP2	SP1	
Running current (A)		2.50	1.20	0.50	0.17	2.50	1.20	0.51	0.19	
Input power (W)		420	200	75	21	420	200	75	23	
Air volume		(m ³ /h)	1000	750	500	250	1000	750	500	250
		(L/s)	278	208	139	69	278	208	139	69
External static pressure (Pa)		170	96	43	11	170	96	43	11	
Temperature exchange efficiency (%)		80.0	83.0	86.5	89.5	—	—	—	—	
Enthalpy exchange efficiency (%)		Heating	72.5	74.0	78.0	87.0	—	—	—	—
		Cooling	71.0	73.0	77.0	85.5	—	—	—	—
Noise (dB) (Measured at 1.5m under the center of unit in an anechoic chamber)		37.0	31.0	23.0	18.0	38.0	32.0	24.0	18.0	
Weight (kg)		54								

*The Air outlets noise (45° angle, 1.5meters in front of the unit) is about 21dB greater than the indicated value.(at Fan speed 4)

*The running current, the input power, the efficiency and the noise are based on the rating air volume, and 230V/50Hz.

*For the specification at the other frequency contact your dealer.

*Use this unit between static pressure 60Pa and 240Pa at Fan speed4. Otherwise the motor protection may work and reduce its output or the noise level might be larger.

LGH-150RVX-E

Model		LGH-150RVX-E								
Electrical power supply		220-240V/50Hz, 220V/60Hz								
Ventilation mode		Heat recovery mode				Bypass mode				
Fan speed		SP4	SP3	SP2	SP1	SP4	SP3	SP2	SP1	
Running current (A)		3.71	1.75	0.70	0.29	3.85	1.78	0.78	0.30	
Input power (W)		670	311	123	38	698	311	124	44	
Air volume		(m ³ /h)	1500	1125	750	375	1500	1125	750	375
		(L/s)	417	313	208	104	417	313	208	104
External static pressure (Pa)		175	98	44	11	175	98	44	11	
Temperature exchange efficiency (%)		80.0	82.5	84.0	85.0	—	—	—	—	
Enthalpy exchange efficiency (%)		Heating	72.0	73.5	78.0	81.0	—	—	—	—
		Cooling	70.5	72.5	78.0	81.0	—	—	—	—
Noise (dB) (Measured at 1.5m under the center of unit in an anechoic chamber)		39.0	32.0	24.0	18.0	40.5	33.0	26.0	18.0	
Weight (kg)		98								

*The Air outlets noise (45° angle, 1.5meters in front of the unit) is about 22dB greater than the indicated value.(at Fan speed 4)

*The running current, the input power, the efficiency and the noise are based on the rating air volume, and 230V/50Hz.

*For the specification at the other frequency contact your dealer.

*Use this unit with static pressure 250Pa or less at Fan speed4. Otherwise the noise level might be larger.

LGH-200RVX-E

Model		LGH-200RVX-E								
Electrical power supply		220-240V/50Hz, 220V/60Hz								
Ventilation mode		Heat recovery mode				Bypass mode				
Fan speed		SP4	SP3	SP2	SP1	SP4	SP3	SP2	SP1	
Running current (A)		4.88	2.20	0.88	0.33	4.54	2.06	0.87	0.35	
Input power (W)		850	400	153	42	853	372	150	49	
Air volume		(m ³ /h)	2000	1500	1000	500	2000	1500	1000	500
		(L/s)	556	417	278	139	556	417	278	139
External static pressure (Pa)		150	84	38	10	150	84	38	10	
Temperature exchange efficiency (%)		80.0	83.0	86.5	89.5	—	—	—	—	
Enthalpy exchange efficiency (%)		Heating	72.5	74.0	78.0	87.0	—	—	—	—
		Cooling	71.0	73.0	77.0	85.5	—	—	—	—
Noise (dB) (Measured at 1.5m under the center of unit in an anechoic chamber)		40.0	36.0	28.0	18.0	41.0	36.0	27.0	19.0	
Weight (kg)		110								

*The Air outlets noise (45° angle, 1.5meters in front of the unit) is about 21dB greater than the indicated value.(at Fan speed 4)

*The running current, the input power, the efficiency and the noise are based on the rating air volume, and 230V/50Hz.

*For the specification at the other frequency contact your dealer.

*Use this unit between static pressure 50Pa and 220Pa at Fan speed4. Otherwise the motor protection may work and reduce its output or the noise level might be larger.

Standard installation examples

•Duct length

Model	Distance
LGH-15 to 65RVX-E	1 m or more
LGH-80 and 100RVX-E	2.5 m or more
LGH-150 and 200RVX-E	3 m or more

•The parts can also be installed upside down. Remove the maintenance cover, rotate the parts by 180°, and re-install.

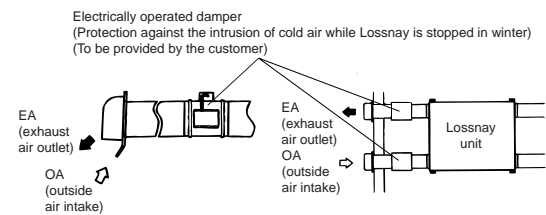
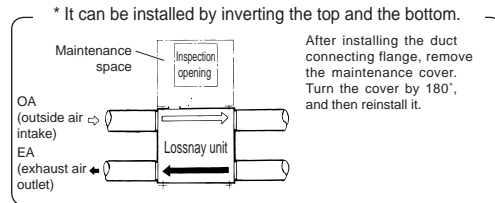

•In a region where there is risk of freezing in winter, it is recommended to install an Electrically operated damper, or the like, in order to prevent the intrusion of (cold) outdoor air while Lossnay is stopped.

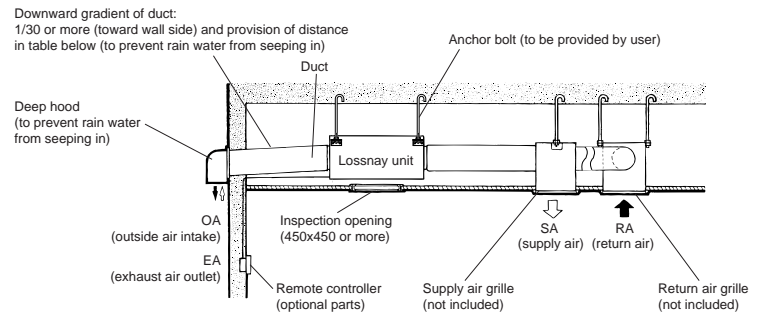
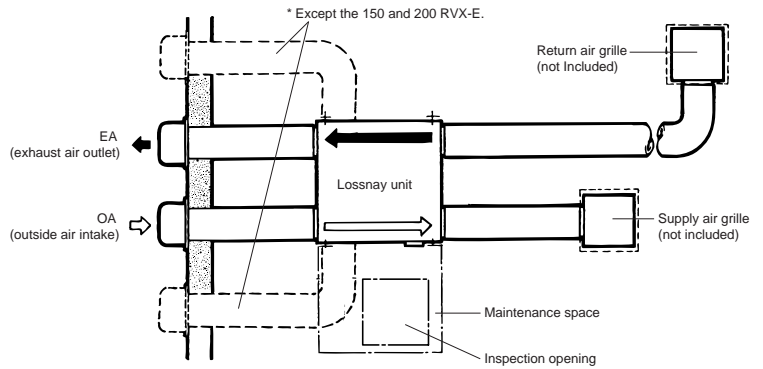

⚠ CAUTION

•Do not install Lossnay unit vertically or on an incline.

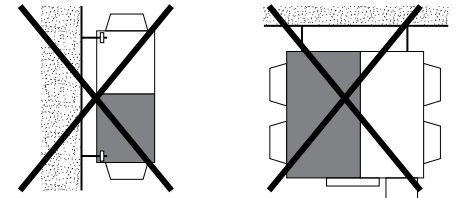

Attention for specifications

- Cold operation mode(*1) is to start repeating in the case that Lossnay's detected OA temperature is less than -10°C.
 - *1. Supply air(SA) in the operation for 60min. followed by stop operation for 10min.
- The current, power consumption and efficiency are based on the air flow rate in the specification.
- Fan speed is selectable by the remote controller from fan speed 1, 2, 3 and 4.
 - Multi Ventilation Mode should set on Lossnay unit or remote controller (PZ-61DR-E).
- Lossnay ventilation mode is to start automatically in the case that Lossnay's detected OA temperature is less than +8°C, even if Bypass ventilation is set by remote controller.
 - Remote controller continue to show "Bypass ventilation" in this case.
- Temperature Exchange efficiency(%) are based on winter condition.
- Mitsubishi Electric measures the machine according to the Japan Industrial Standards(JIS B 8628)

Attention

- When using the product where it is exposed to high temperatures and humidity (40°C or higher, RH 80% or higher), or where fog occurs frequently, moisture is likely to condense in the core, and may result in condensation build up in the unit. The product should not be used under such conditions.
- Outdoor air may enter the Lossnay owing to the pressure difference between indoor and outdoor or external winds even when the product is not operated. It is recommended to install an Electrically operated damper to block the outdoor air.
- In a cold weather area, an area with strong external winds or where fog occurs frequently, cold outdoor air, external winds or fog may be introduced into the product when its operation is stopped.
 - It is recommended to install an Electrically operated damper.
- In a cold weather area, or others, dewing or freezing could occur on the main unit, where the duct is connected, or other sections, depending on the conditions of outdoor air and indoor temperature and moisture, even if they are within the range of operating conditions. Make sure to confirm the operating conditions and other precautions, and do not use the product if dewing or freezing is anticipated.
- The outside ducts must be tilted at a gradient (1/30 or more) down toward the outdoor louvres from Lossnay, and properly insulated. (The entry of rain water may cause power leakage, fire, or damage to household property)
- The two outdoor ducts must be covered with heat-insulating material in order to prevent condensation from forming.
 - If it is expected that the ambient temperature around the place where the Lossnay unit is installed will be high during the summer air conditioning season, it is recommended that the indoor ductwork be covered with insulation material.
- Inspection opening (450 × 450 or more) must be installed on the filter and Lossnay core removing side.

Lossnay model selection advices

1. Operating environment
Install this product in an environment where the temperature ranges from -10°C to +40°C and the relative humidity is less than 80%RH. If condensation is expected to form, heat up the fresh outside air should be treated.
2. Do not use under high temperature and humidity condition
Condensation will occur and water will gather inside the Lossnay cores under high temperature and humidity condition, such as warm swimming pool, bathroom, greenhouse or foggy place.
3. Condition of outdoor, indoor and return air
Avoid using Lossnay under air condition with acid, alkalis, organic solvent, oil mist, paint, or harmful gas as pesticide, corrosive gas, etc.
4. Insulation failure caused by salt or sulphur air and hot spring steam, rust, fire or malfunction may occur.
Installing high quality filters inside outdoor air duct if the Lossnay operates in salt or sulphur air conditions.
5. Intake of mist or outdoor air during off-mode operation
Outdoor air or mist may flow through the duct into your room when Lossnay is in off-mode at windy and foggy area.
To prevent intake of outdoor air or fog, a damper is advised to be installed.
6. Entry of insects
When using the product in an environment where there is a window, or opening near the outdoor hood, so that insects are likely to gather around the interior or exterior light, take note that small insects may intrude into the Lossnay filters.
7. Bypass ventilation
In the case of "Bypass" ventilation, the supply air temperature slightly rises more than the outside air temperature because of the effect around the ducts or the unit motors.
8. Usage of M-NET.
When solely using Lossnay units, power supply unit is required to connect to centralized control.
Number of power supply units or the transmission boosters should correspond with the connected Lossnay units.

Caution for installation

1. Do not modify the unit as it may cause malfunction.
2. Do not install Lossnay unit vertically or on an incline. It may cause malfunction or deterioration of performance.
3. Leaving sufficient space for maintenance purpose.
4. The location of the air inlet
Take care in locating air inlet to prevent intake of dirty air or disgusting smell from exhaust gas of factory, air from rubbish disposal, etc.
5. Take precautions when using the product in a quiet location.
6. Heat insulation foam for duct
Take care as below to prevent the contaminate ceiling by duct condensation.
 - 1) The two outdoor ducts (OA and EA) must be covered with heat-insulating material in order to prevent condensation.
 - 2) If it is expected that the ambient temperature around the place where the Lossnay unit is installed will be high during the summer air conditioning season, it is recommended that the indoor ductwork should be covered with insulation material.
 - 3) Outdoor air may come into unit during not operating unit by the pressure difference between indoor and outdoor or the outdoor wind. In this case you should install a damper.
 - 4) It is possible for condensation and freezing to occur in the cold regions inside the unit because of the outdoor air condition or humidity condition above ceiling. Make sure to install supplemental insulation foam.
 - 5) In the case that air condition around Lossnay unit is high temperature in summer, it is recommended that there are heat insulation foam on indoor side duct to prevent heat recovery decreased by warming indoor duct. In winter, it is possible to cool indoor side duct without heat insulation foam on indoor side duct.
7. Prevent entry of rainwater into Lossnay unit
Install weather louver or "Weather cover" for OA inlet & EA outlet. This is to prevent rainwater entering the Lossnay unit. Ducts to outdoor (OA and EA) should decline by 1/30 or more.
8. Install the anchor bolts to ensure the product's weight or earthquake load. Correctly rated wire/chain may also be used.
9. Do not install this product in a place where it is exposed to ultraviolet light. UV may be damage covering insulation.
10. Electrical Work
A single pole isolator must be installed at the origins of mains power supply.
Use single flush box, to support remote controller.
Must connect ground wiring.
When connecting external devices (electrically operated damper, lamp, monitoring unit, etc.) using output signals of the Lossnay unit, make sure to install safety equipment for the external devices. (It could cause fire, damage, etc. without safety equipment)
11. Duct heater
In case of installing a duct heater interlock with Lossnay, be sure to observe followings.
 - 1) Select a duct heater in compliance with local and national laws, ordinances, and standards.
Select a duct heater that has obtained the CE mark.
 - 2) Always select a heater that is equipped with a non-self-resetting safety device. Do not directly supply power from the Lossnay unit to the duct heater. Doing so could cause fire.
 - 3) Install a circuit breaker for the duct heater in compliance with all applicable laws, ordinances, and standards.
 - 4) Install the duct heater separated from the product by a distance of 2 m or more.
Failure to do so may result in equipment damage due to the transmission of residual heat from the heater.
 - 5) When using a heater without a temperature control function, select a heater with a capacity that is matched to the air volume.
 - 6) Do not use the heater outside the set air volume.
If the heater's capacity is too larger, this may result in the heater frequently turning ON/OFF.
If the heater's capacity is too small, this may result an inability to heat.
 - 7) Ensure that the duct heater and Lossnay are wired and that the Lossnay function settings have been configured, and then always check operation by trial operation.

Maintenance and lifetime

Refer to each model's operation instructions for the suggested maintenance period and methods. General indication of lifetime of the main parts is as below. Time below is unrelated to guaranteed period for service. And parts exchange period varies with usage condition.

Lossnay cores	: Around 10 years with maintenance as stated periods
Air Filters	: Around 5 years with maintenance as stated periods
High efficiency filters	: 3000 hours
Motor	: 30000 hours

LGH-15 to 100RVX-E

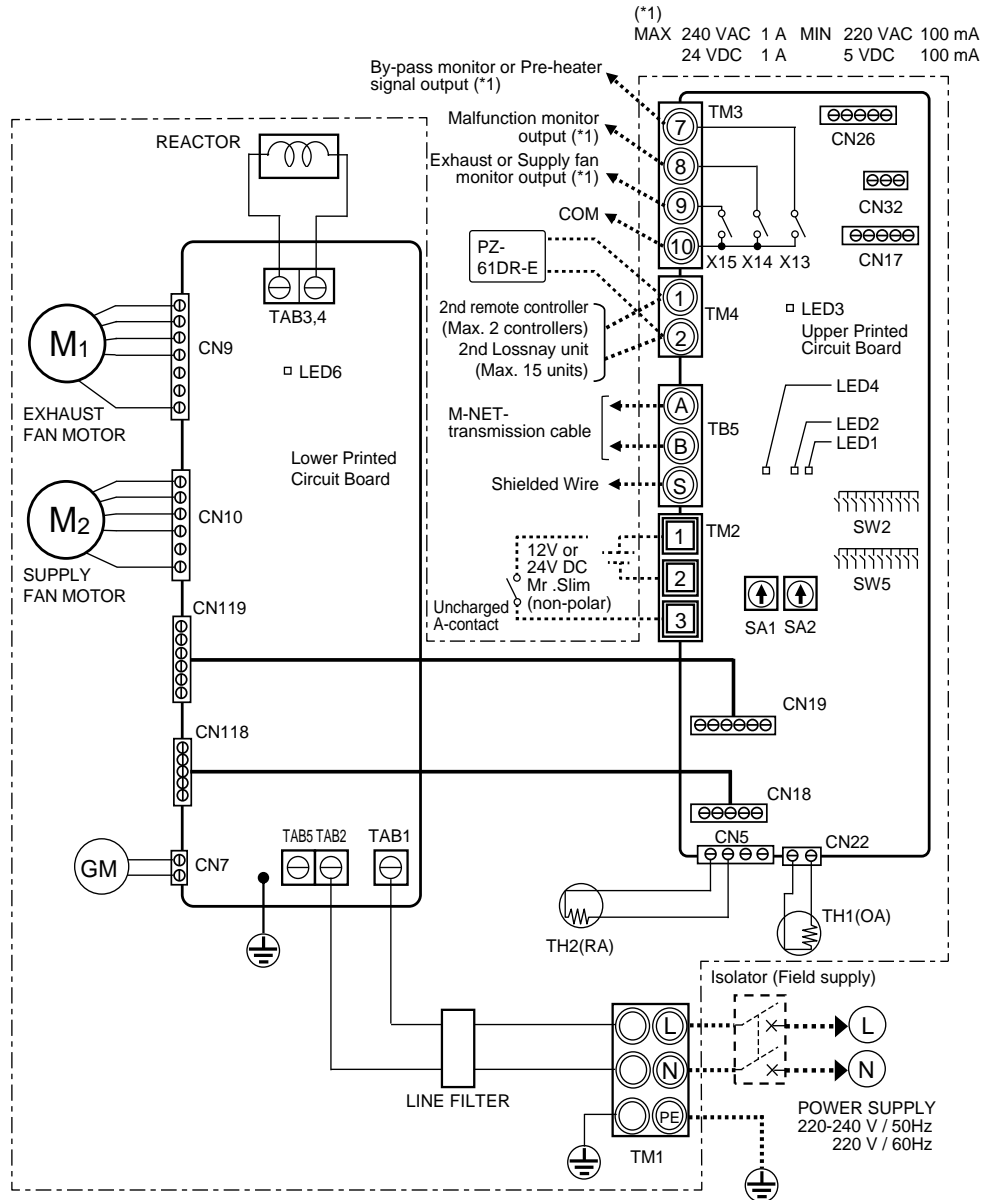

- * TM1, TM2, TM3, TM4, TB5 shown in dotted lines are field work.
- * Be sure to connect the ground wire.
- * A power supply isolator must be installed.
- * Always use an isolator for the main switch power connection.
- * Specifications may be subject to change without notice.

Definition of Symbols		
M1: Motor for exhaust fan	X13: Relay contact	CN26: Connector (By-pass, 0 - 10 VDC Fan speed control)
M2: Motor for supply fan	X14: Relay contact	CN32: Connector (Remote control selection)
GM: Motor for By-pass damper	X15: Relay contact	SA1: Address setting rotary switch (tens digit)
TH1: Thermistor for outside air	CN5: Connector (Thermistor RA)	SA2: Address setting rotary switch (ones digit)
TH2: Thermistor for return air	CN7: Connector (Motor for By-pass damper)	LED1 to LED3: Inspection indicator lamp
SW2,5: Switch (Function selection)	CN9: Connector (Fan motor)	LED4, LED6: Power supply indicator lamp
TM1: Terminal block (Power supply)	CN10: Connector (Fan motor)	SYMBOL ○ □ : Terminal block
TM2: Terminal block (External control input)	CN17: Connector (Fan speed 1/2/3/4)	Ⓜ : Connector on PCB
TM3: Terminal block (Monitor output)	CN18: Connector	
TM4: Terminal block (Transmission cable)	CN118: Connector	
TB5: Terminal block (M-NET Transmission cable)	CN19: Connector	
TAB1, TAB2, (TAB5): Connector (Power supply)	CN119: Connector	
TAB3, TAB4: Connector (Reactor)	CN22: Connector (Thermistor OA)	

LGH-150 and 200RVX-E

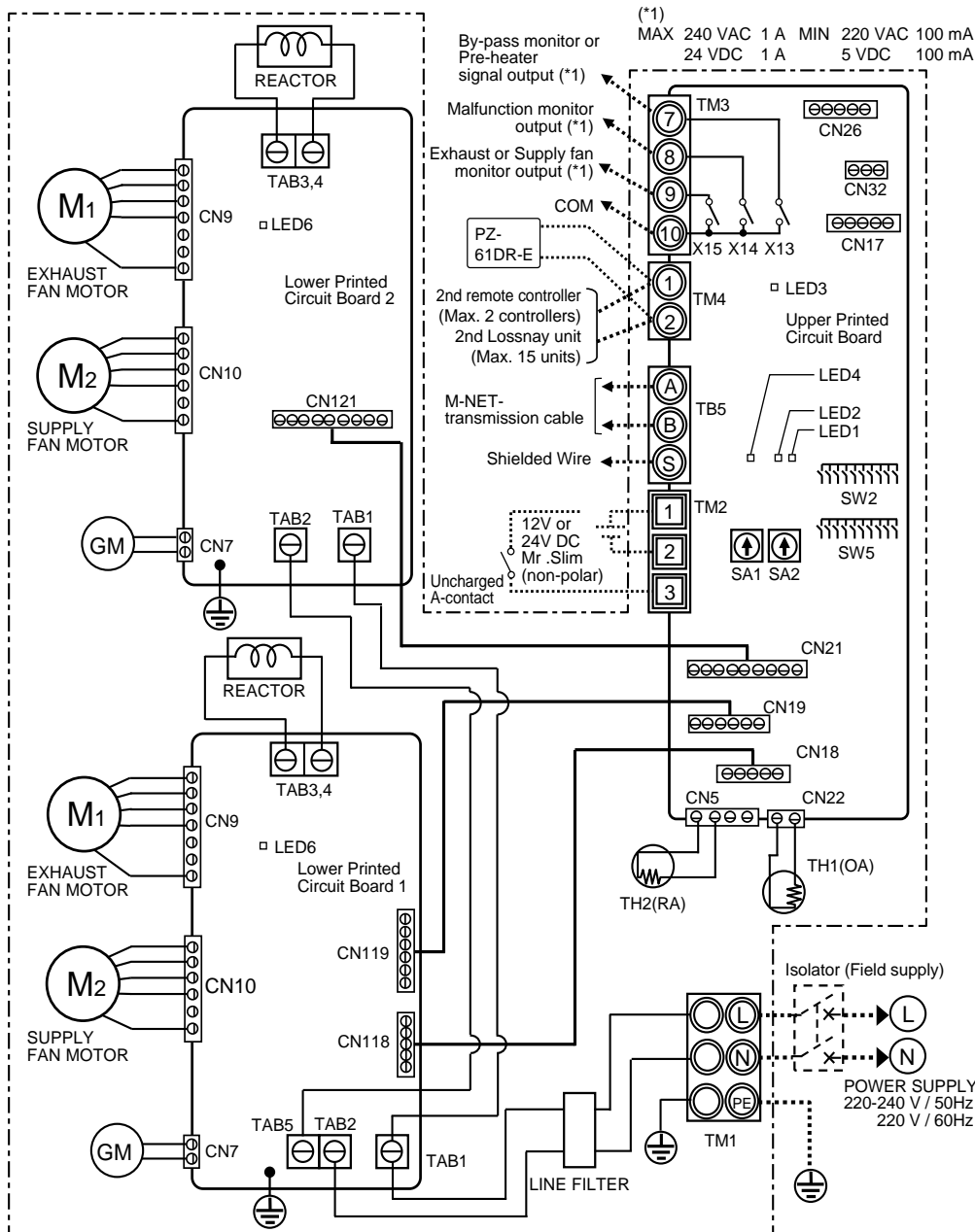

- * TM1, TM2, TM3, TM4, TB5 shown in dotted lines are field work.
- * Be sure to connect the ground wire.
- * A power supply isolator must be installed.
- * Always use an isolator for the main switch power connection.
- * Specifications may be subject to change without notice.

LOSSNAY

Definition of Symbols

M1: Motor for exhaust fan	X13: Relay contact	CN21: Connector
M2: Motor for supply fan	X14: Relay contact	CN121: Connector
GM: Motor for By-pass damper	X15: Relay contact	CN22: Connector (Thermistor OA)
TH1: Thermistor for outside air	CN5: Connector (Thermistor RA)	CN26: Connector (By-pass, 0 - 10 VDC Fan speed control)
TH2: Thermistor for return air	CN7: Connector (Motor for By-pass damper)	CN32: Connector (Remote control selection)
SW2, 5: Switch (Function selection)	CN9: Connector (Fan motor)	SA1: Address setting rotary switch (tens digit)
TM1: Terminal block (Power supply)	CN10: Connector (Fan motor)	SA2: Address setting rotary switch (ones digit)
TM2: Terminal block (External control input)	CN17: Connector (Fan speed 1/2/3/4)	LED1 to LED3: Inspection indicator lamp
TM3: Terminal block (Monitor output)	CN18: Connector	LED4, LED6: Power supply indicator lamp
TM4: Terminal block (Transmission cable)	CN118: Connector	SYMBOL ○ □ : Terminal block
TB5: Terminal block (M-NET Transmission cable)	CN19: Connector	Ⓜ : Connector on PCB
TAB1, TAB2, TAB5: Connector (Power supply)	CN119: Connector	
TAB3, TAB4: Connector (Reactor)		

GUF-RD4, GUF-RDH4

1. SPECIFICATIONS	1 - 219
2. SOUND LEVELS	1 - 220
2-1. Measurement Condition.....	1 - 220
2-2. NC curves	1 - 220
3. FAN CHARACTERISTICS CURVES.....	1 - 221
4. EXTERNAL DIMENSIONS	1 - 222
5. ELECTRICAL WIRING DIAGRAMS	1 - 223

OA Processing unit

OA Processing unit GUF-RD(H)₄ combines the characteristics of LOSSNAY and air conditioning function of indoor unit, offers perfect air conditioning in which fresh outdoor air, humidity, temperature adjustment are all considered. Moreover, GUF-RD(H)₄ realizes the air conditioning solution at the most energy saving method.

GUF Structure:

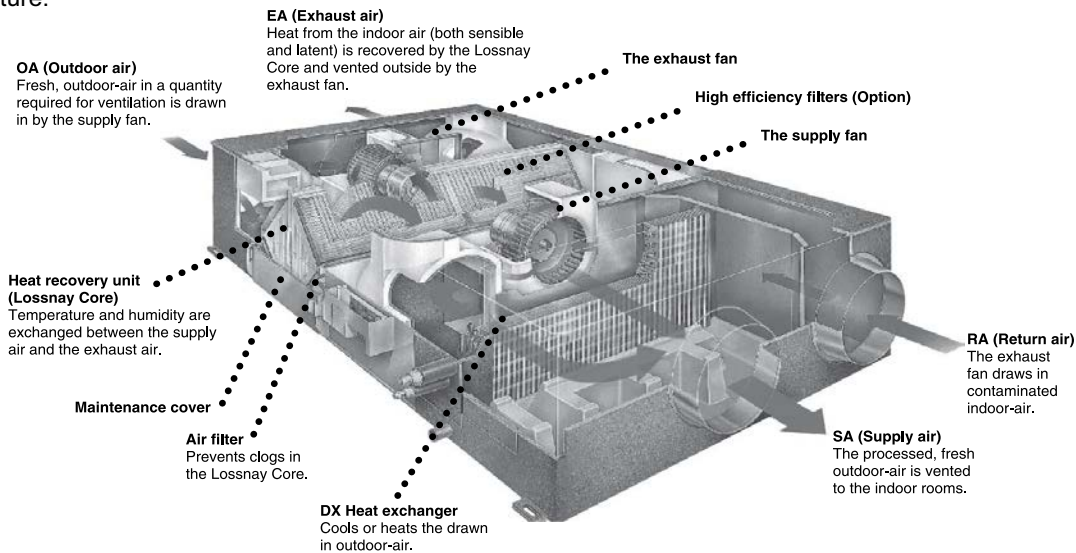

Permeable Film Humidifier (GUF-RDH Model)

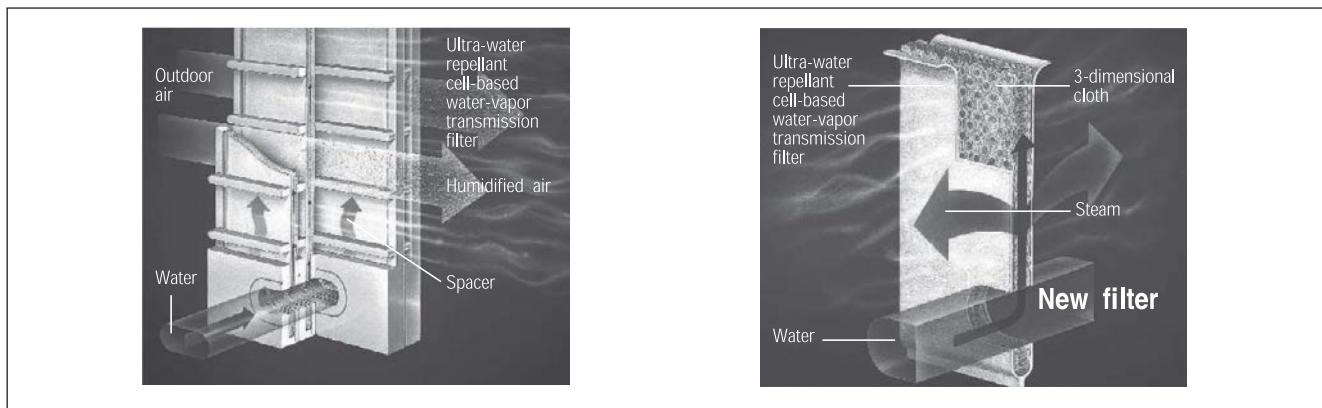

Line up of OA Processing units

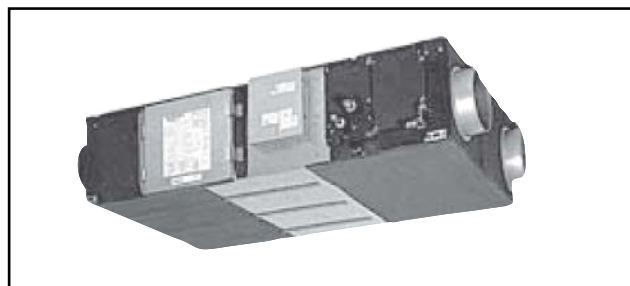

GUF-50RD ₄	500m ³ /h	1-phase 220-240V 50Hz
GUF-100RD ₄	1000m ³ /h	1-phase 220-240V 50Hz
GUF-50RDH ₄	500m ³ /h	1-phase 220-240V 50Hz
GUF-100RDH ₄	1000m ³ /h	1-phase 220-240V 50Hz

1. SPECIFICATIONS

YKB/YLM

Model			GUF-50RDH ₄	GUF-100RDH ₄	GUF-50RD ₄	GUF-100RD ₄					
Power source			1-phase 220-240V 50Hz								
Cooling capacity	*1	kW	5.57	<1.94>	11.44	<4.12>	5.57	<1.94>	11.44	<4.12>	
	Figure in < > is the recovery capacity by LOSSNAY core.	*1	kcal / h	4,800	<1,650>	9,800	<3,500>	4,800	<1,650>	9,800	<3,500>
		*1	BTU / h	19,000	<6,600>	39,000	<14,000>	19,000	<6,600>	39,000	<14,000>
		*3	Power input	W	235-265	480-505	235-265	480-505			
*3	Current input	A	1.15	2.20	1.15	2.20					
Heating capacity	*2	kW	6.21	<2.04>	12.56	<4.26>	6.21	<2.04>	12.56	<4.26>	
	Figure in < > is the recovery capacity by LOSSNAY core.	*2	kcal / h	5,340	<1,750>	10,800	<3,650>	5,340	<1,750>	10,800	<3,650>
		*2	BTU / h	21,200	<7,000>	42,850	<14,450>	21,200	<7,000>	42,850	<14,450>
		*3	Power input	W	235-265	480-505	235-265	480-505			
*3	Current input	A	1.15	2.20	1.15	2.20					
Capacity equivalent to indoor unit			P32	P63	P32	P63					
Humidifying capacity	kg / h		2.7	5.4	-	-					
	lbs / h		6.0	12.0	-	-					
Humidifier			Permeable film humidifier			-					
External finish			Galvanized, with grey insulation sheet								
External dimension H x W x D	mm		317 x 1,016 x 1,288	398 x 1,231 x 1,580	317 x 1,016 x 1,288	398 x 1,231 x 1,580					
	in.		12-1/2 x 40 x 50-3/4	15-11/16 x 48-1/2 x 62-1/4	12-1/2 x 40 x 50-3/4	15-11/16 x 48-1/2 x 62-1/4					
Net weight	kg (lbs)		51 (112)	88 (194)	48 (106)	82 (181)					
Heat exchanger	LOSSNAY core		Partition, Cross-flow structure, Special preserved paper-plate.								
	Refrigerant coil		Cross fin (Aluminium fin and copper tube)								
FAN	Type x Quantity		SA: Centrifugal fan (Sirocco fan) x 1 EA: Centrifugal fan (Sirocco fan) x 1								
	External static press. *4	Pa	125	135	140	140					
		mmH ₂ O	12.7	13.8	14.3	14.3					
	Motor type		Totally enclosed capacitor permanent split-phase induction motor, 4 poles, 2units								
	Motor output		kW								
	Driving mechanism		Direct-driven by motor								
	Airflow rate (High value)	m ³ / h		500	1,000	500	1,000				
L / s		139	278	139	278						
cfm		294	589	294	589						
Sound pressure level (Low-High) (measured in anechoic room) *3	dB <A>		33.5-34.5	38-39	33.5-34.5	38-39					
Insulation material			Polyester sheet								
Air filter	Supplying air		Non-woven fabrics filter (Gravitational method 82%) & Optional part: High efficiency filter (Colorimetric method 65%)								
	Exhausting air		Non-woven fabrics filter (Gravitational method 82%)								
Protection device			Fuse								
Refrigerant control device			LEV								
Connectable outdoor unit			R410A CITY MULTI								
Diameter of refrigerant pipe	Liquid	mm (in.)	ø6.35 (ø1/4) Flare	ø9.52 (ø3/8) Flare	ø6.35 (ø1/4) Flare	ø9.52 (ø3/8) Flare					
	Gas	mm (in.)	ø12.7 (ø1/2) Flare	ø15.88 (ø5/8) Flare	ø12.7 (ø1/2) Flare	ø15.88 (ø5/8) Flare					
Field drain pipe size		mm (in.)	Socket(L.D. 32mm (1-1/4))+O.D. 32mm (1-1/4)								
Drawing	External		-								
	Wiring		-								
	Refrigerant cycle		-								
Standard attachment	Document		Installation Manual, Instruction Book								
	Accessory										
Remark	Optional parts		High efficiency filter: PZ-50RFM-E (for GUF-50RDH ₄ , GUF-50RD ₄) PZ-100RFM-E (for GUF-100RDH ₄ , GUF-100RD ₄)								
	Installation		Details on foundation work, duct work, insulation work, electrical wiring, power source switch, and other items shall be referred to the Installation Manual.								
Note :			*1 Nominal cooling conditions			*2 Nominal heating conditions			Unit converter		
Indoor :			27°CDB/19°CWB (81°FDB/66°FWB)			20°CDB (68°FDB)			kcal/h = kW x 860		
Outdoor :			35°CDB (95°FDB)			7°CDB/6°CWB (45°FDB/43°FWB)			BTU/h = kW x 3,412		
Pipe length :			7.5 m (24-9/16 ft)			7.5 m (24-9/16 ft)			cfm = m ³ /min x 35.31		
Level difference :			0 m (0 ft)			0 m (0 ft)			lbs = kg / 0.4536		
* Nominal conditions *1, *2 are subject to JIS B8615-1.									*Above specification data is subject to rounding variation.		
* Due to continuing improvement, above specification may be subject to change without notice.											
*3 The values are measured at the rated external static pressure.											
*4 The figure in < > indicates the value when external static pressure is changed.											

OA

2-1. Measurement Condition

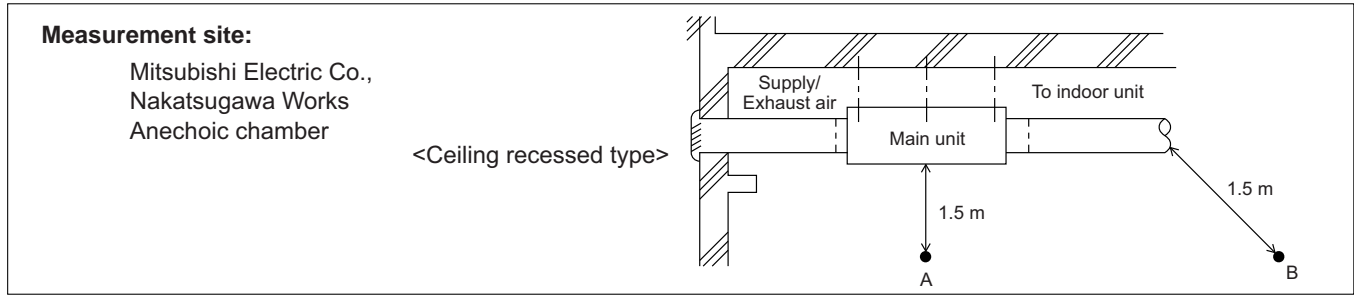

2-2. NC curves

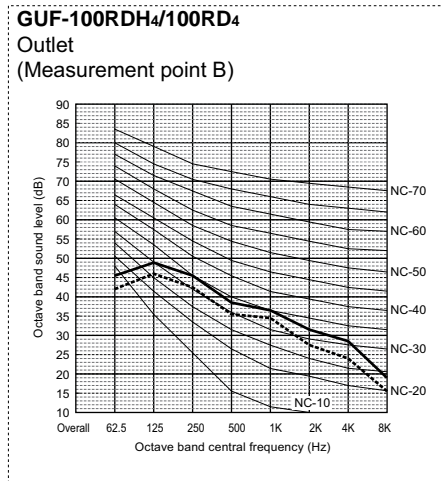
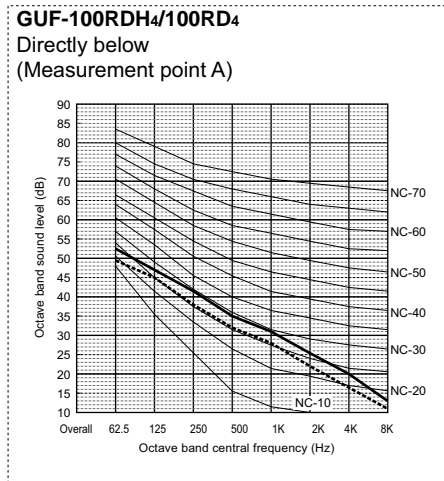
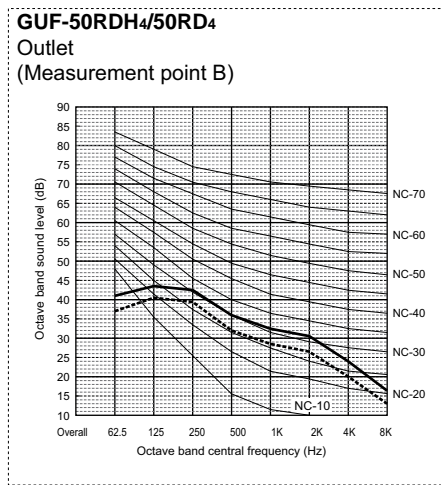
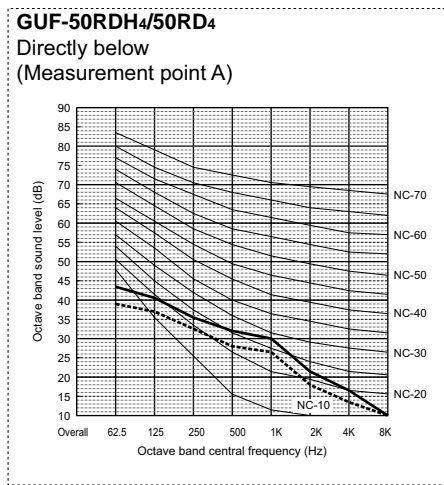

OA

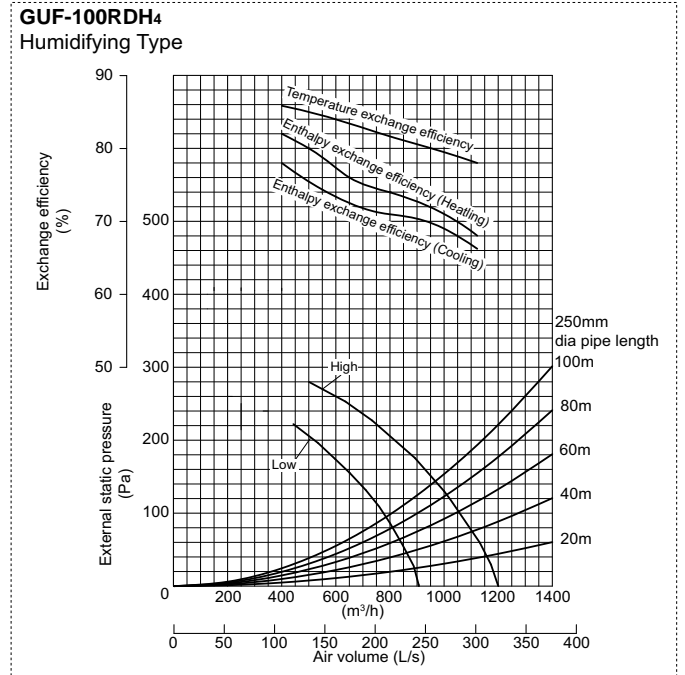
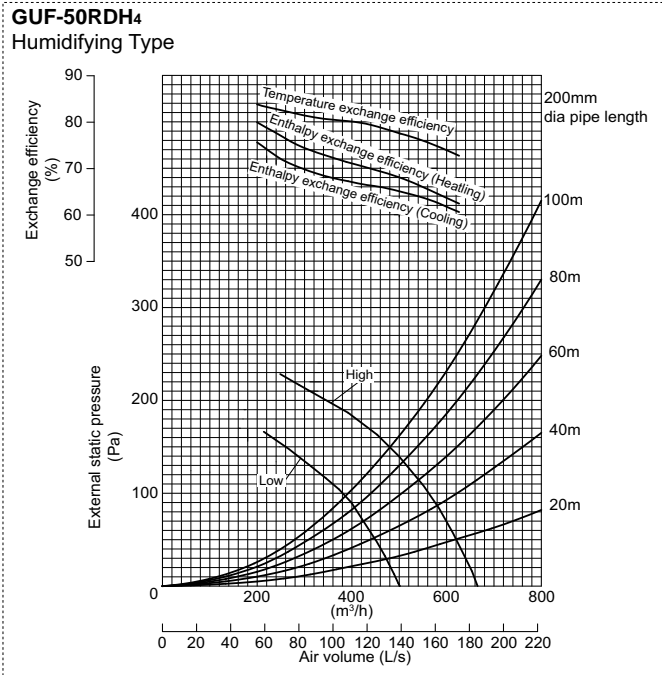
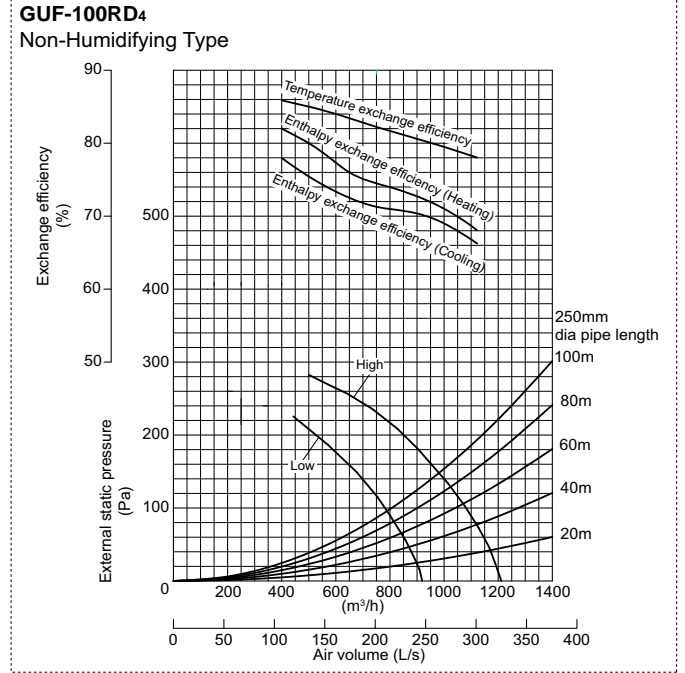
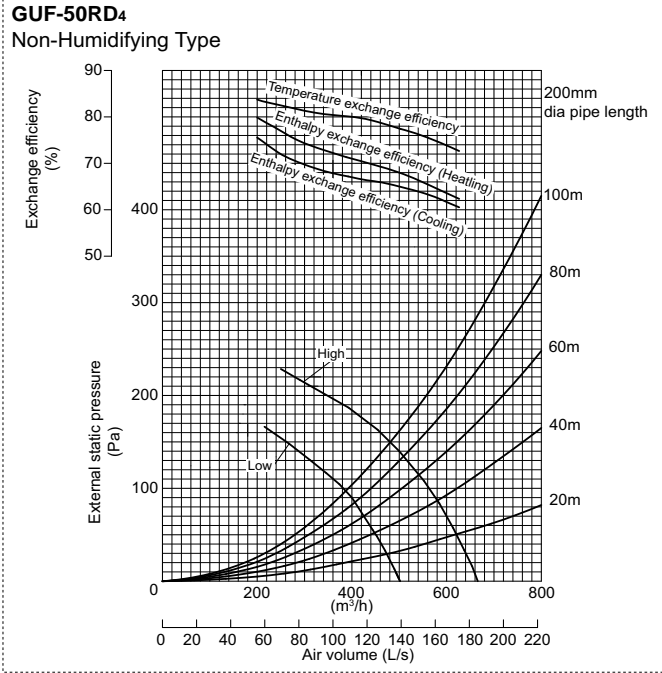

GUF-50,100RD(H)₄

Humidifying Type GUF-50/100RDH₄

Unit : mm

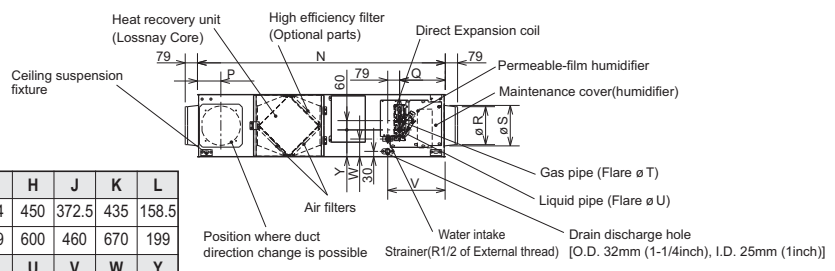
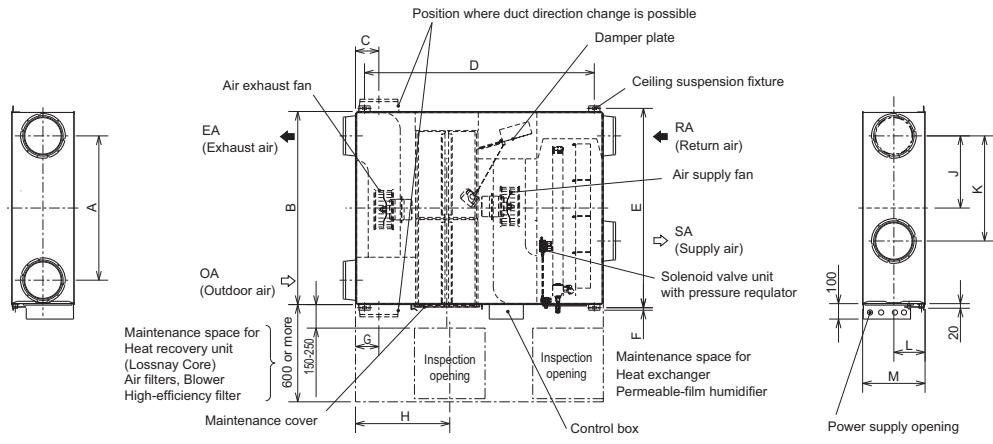

Model	A	B	C	D	E	F	G	H	J	K	L
GUF-50RDH ₄	745	1,016	124	1,185	1,048	22	124	450	372.5	435	158.5
GUF-100RDH ₄	920	1,231	149	1,465	1,271	16	149	600	460	670	199
Model	M	N	P	Q	R	S	T	U	V	W	Y
GUF-50RDH ₄	317	1,288	124	266	192	208	12.7	6.35	347	99	135
GUF-100RDH ₄	398	1,580	149	280	242	258	15.88	9.52	361	110	169

Non-Humidifying Type GUF-50/100RD₄

Unit : mm

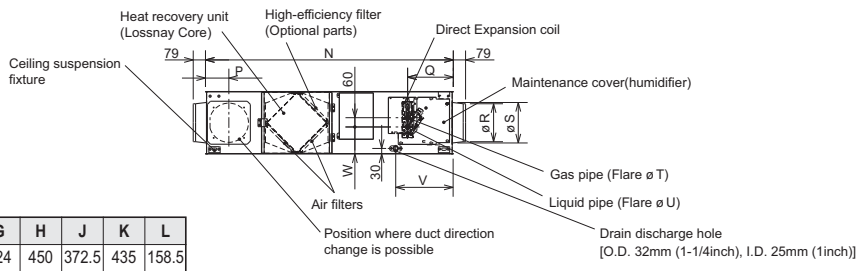
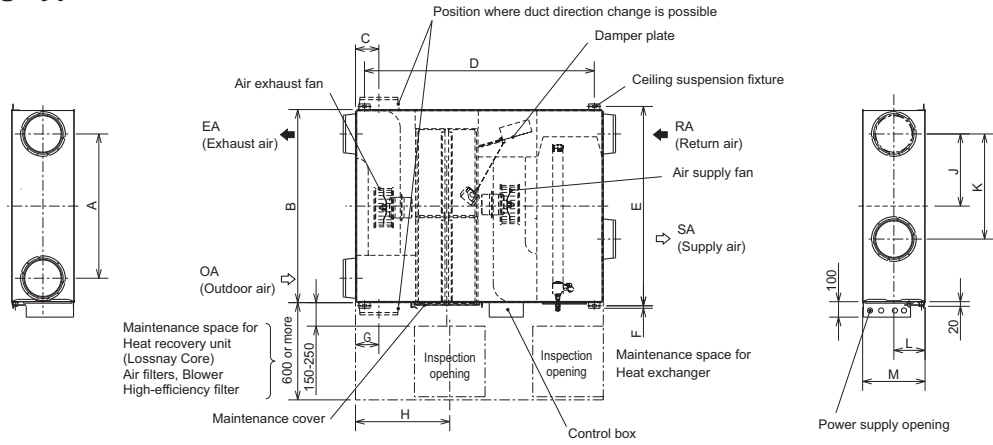

Model	A	B	C	D	E	F	G	H	J	K	L
GUF-50RD ₄	745	1,016	124	1,185	1,048	22	124	450	372.5	435	158.5
GUF-100RD ₄	920	1,231	149	1,465	1,271	16	149	600	460	670	199
Model	M	N	P	Q	R	S	T	U	V	W	
GUF-50RD ₄	317	1,288	124	266	192	208	12.7	6.35	347	135	
GUF-100RD ₄	398	1,580	149	280	242	258	15.88	9.52	361	169	

OA

Humidifying Type GUF-50/100RDH4

- TM1, TM2, TM3 shown in dotted lines are field work.
- Be sure to connect the grounding wire.
- Isolators should be supplied by the field.

Warning
Before obtaining access to terminals, all supply circuits must be disconnected.

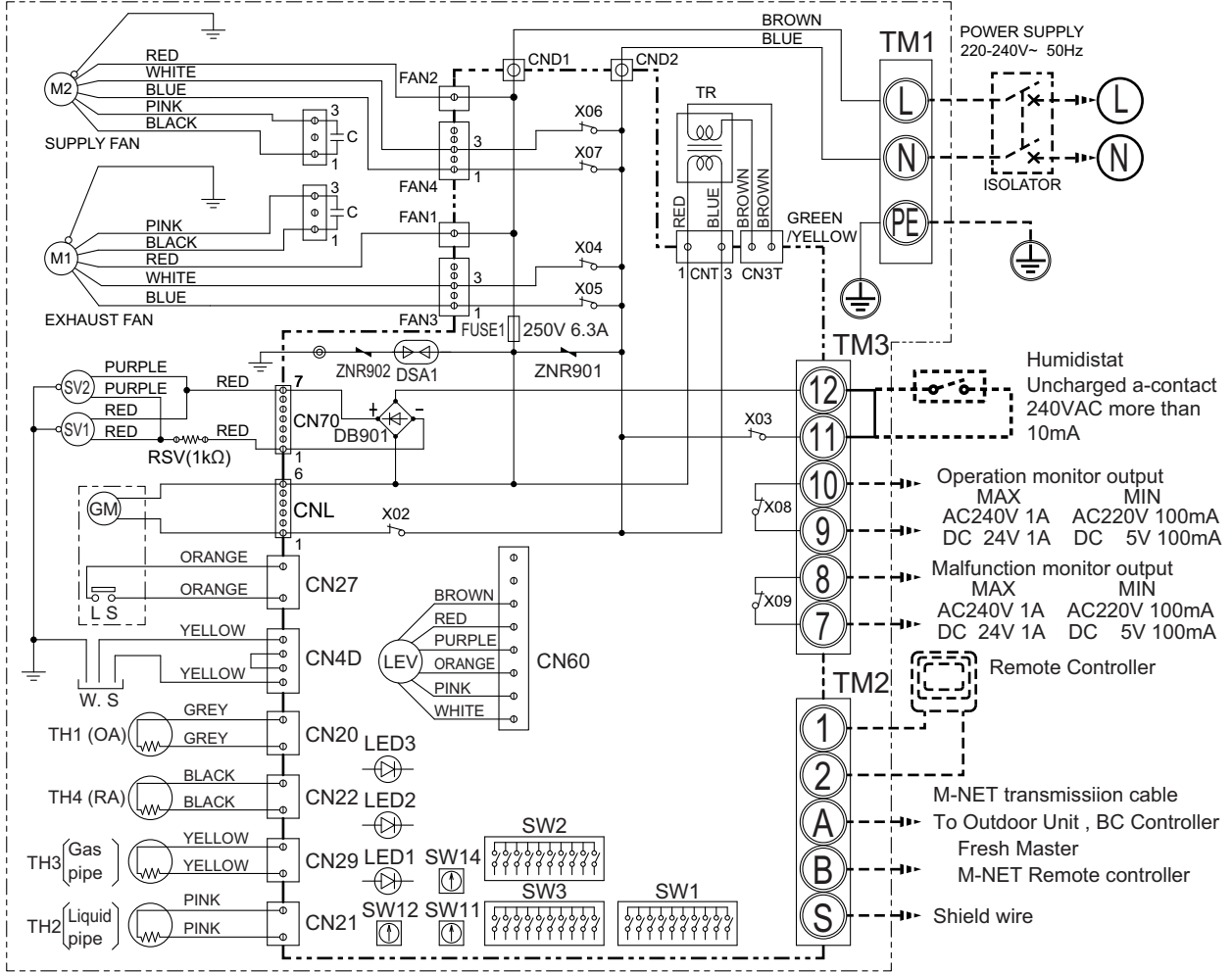

MARK ○ indicates terminal block, ⊕ connector
Ⓜ board insertion connector or fastening connector of control board.

Symbol Explanation

Symbol	Name	Symbol	Name	Symbol	Name
M1	Fan motor (exhaust)	RSV	Resistance (solenoid valve)	A, B	M-NET transmission terminal
M2	Fan motor (supply)	TM1	Terminal block (power supply)	S	Shield
C	Capacitor	TM2	Terminal block (transmission)	CND1, CND2	Connector (power supply)
W. S	Water sensor	TM3	Terminal block (humidistat, monitor)	X02-X09	Relay
SV1	Solenoid valve (pressure regulator)	SW1	Switch (function selection)	TR	Transformer
SV2	Solenoid valve (exhaust)	SW2	Switch (capacity code setting)	GM	Damper motor
TH1	Thermistor (outdoor air temp. detection)	SW3	Switch (function selection)	LS	Limit switch
TH2	Thermistor (pipe temp. detection/liquid)	SW11	Switch (ones digit address set)	LED1	Power supply monitor
TH3	Thermistor (pipe temp. detection/gas)	SW12	Switch (tens digit address set)	LED2	MA remote controller
TH4	Thermistor (room air temp. detection)	SW14	Switch (branch NO. set)	LED3	Power supply monitor
LEV	Electronic linear expansion valve	1, 2	Remote controller terminal		M-NET Power supply monitor

*Specifications may be subject to change without notice.

Non-Humidifying Type GUF-50/100RD4

- TM1, TM2, TM3 shown in dotted lines are field work.
- Be sure to connect the grounding wire.
- Isolators should be supplied by the field.

Warning
Before obtaining access to terminals, all supply circuits must be disconnected.

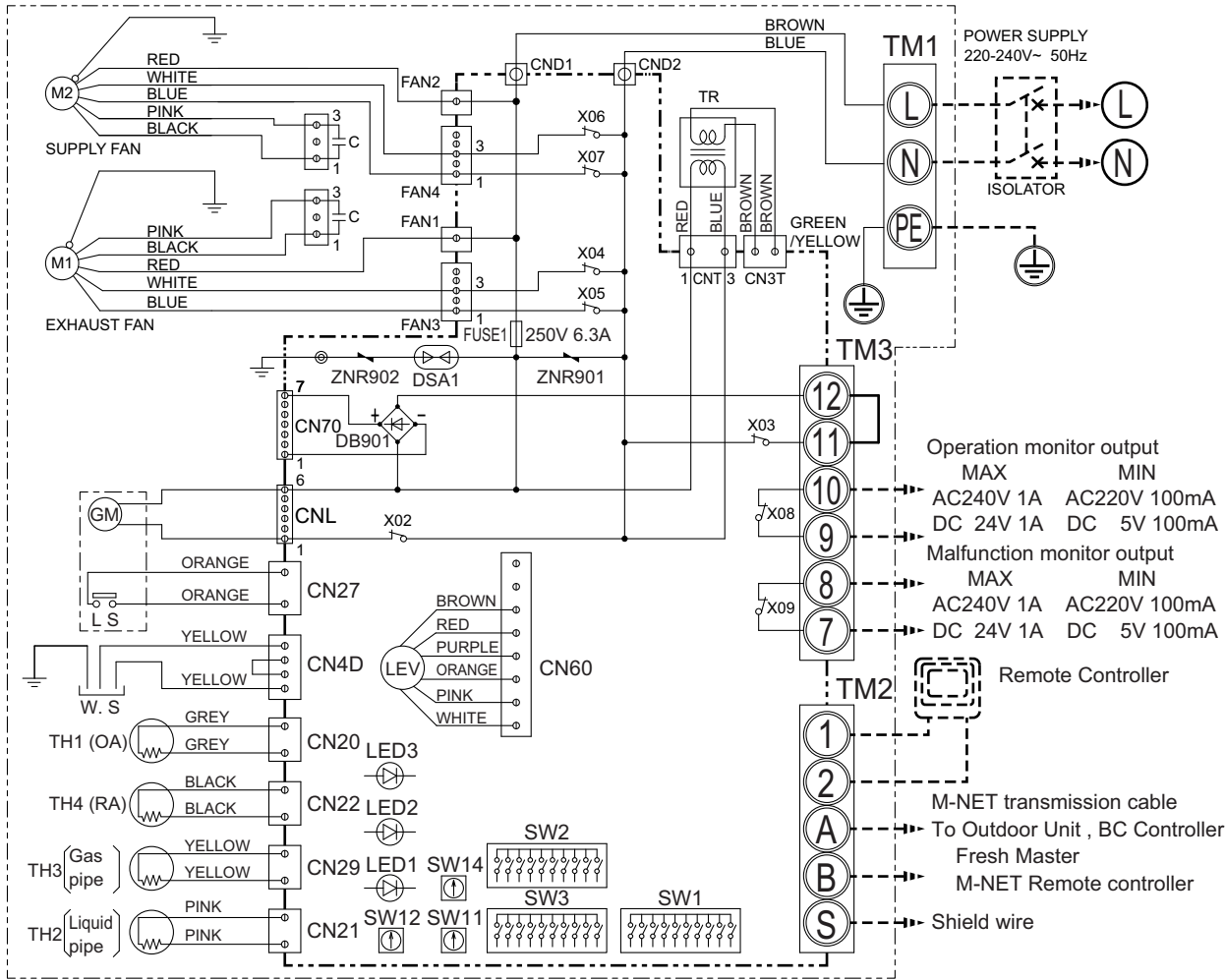

MARK ○ indicates terminal block, ⊕ connector
Ⓜ :board insertion connector or fastening connector of control board.

Symbol explanation

Symbol	Name	Symbol	Name	Symbol	Name
M1	Fan motor (exhaust)	TM1	Terminal block (power supply)	S	Shield
M2	Fan motor (supply)	TM2	Terminal block (transmission)	CND1, CND2	Connector (power supply)
C	Capacitor	TM3	Terminal block (humidistat, monitor)	X02-X09	Relay
W.S	Water sensor	SW1	Switch (function selection)	TR	Transformer
TH1	Thermistor (outdoor air temp. detection)	SW2	Switch (capacity code setting)	GM	Damper motor
TH2	Thermistor (pipe temp. detection/liquid)	SW3	Switch (function selection)	LS	Limit switch
TH3	Thermistor (pipe temp. detection/gas)	SW11	Switch (ones digit address set)	LED1	Power supply monitor
TH4	Thermistor (room air temp. detection)	SW12	Switch (tens digit address set)	LED2	MA remote controller
LEV	Electronic linear expansion valve	SW14	Switch (branch NO. set)	LED3	Power supply monitor
		1, 2	Remote controller terminal		M-NET Power supply monitor
		A, B	M-NET transmission terminal		

*Specifications may be subject to change without notice.

OA

CMB-P-V-G1, CMB-P-V-GA1, CMB-P-V-HA1, CMB-P-V-GB1, CMB-P-V-HB1

1. SPECIFICATIONS.....	1 - 226
2. EXTERNAL DIMENSIONS.....	1 - 235
3. ELECTRICAL WIRING DIAGRAMS.....	1 - 240

1. SPECIFICATIONS

YKB/YLM

Model name			CMB-P104V-G1		CMB-P105V-G1	
Number of branch			4		5	
Power source			1-phase 220/230/240V			
			50Hz	60Hz	50Hz	60Hz
Power input (220/230/240)	Cooling	kW	0.067/0.076/0.085	0.054/0.061/0.067	0.082/0.093/0.104	0.066/0.074/0.082
	Heating		0.030/0.034/0.038	0.024/0.027/0.030	0.038/0.043/0.048	0.030/0.034/0.038
Current (220/230/240)	Cooling	A	0.31/0.34/0.36	0.25/0.27/0.28	0.38/0.41/0.44	0.30/0.33/0.35
	Heating		0.14/0.15/0.16	0.11/0.12/0.13	0.18/0.19/0.20	0.14/0.15/0.16
External finish			Galvanized steel plate (Lower part drain pan painting N1.5)			
Connectable outdoor unit/heat source unit			PURY-(E)P200/250/300/350YLM-A(1)-(BS) PQRY-P200/250/300YHM-A			
Indoor unit capacity connectable to 1 branch			Model P80 or smaller (Use optional joint pipe combing 2 branches when the total unit capacity exceeds 81.)			
External dimension H x W x D		mm (in.)	284 x 648 x 432 (11-3/16 x 25-17/32 x 17-1/32)			
Refrigerant piping diameter	Connectable outdoor unit capacity		To outdoor unit			
			High press. pipe		Low press. pipe	
	to P200		15.88 (5/8)		19.05 (3/4)	
	mm (in.) O.D.		Brazed		Brazed	
	P250/P300		19.05 (3/4)		22.2 (7/8)	
	mm (in.) O.D.		Brazed		Brazed	
	to P350		19.05 (3/4)		28.58 (1-1/8)	
	mm (in.) O.D.		Brazed		Brazed	
			To indoor unit			
			Liquid pipe		Gas pipe	
mm (in.) O.D.		Indoor unit Model 50 or smaller 6.35 (1/4) Brazed bigger than 50 9.52 (3/8) Brazed (12.7 (1/2) with optional joint pipe used.)		Indoor unit Model 50 or smaller 12.7 (1/2) Brazed bigger than 50 15.88 (5/8) Brazed (19.05 (3/4) with optional joint pipe used.)		
Field drain pipe size		mm (in.) O.D.	32 (1-1/4)			
Net weight		kg (lbs)	26 (58)		27 (60)	
Accessories			Drain Connection pipe (with flexible hose and insulation) Reducer		Drain Connection pipe (with flexible hose and insulation) Reducer	
Remark						
Note:			<ol style="list-style-type: none"> 1. Installation/foundation work, electrical connection work, insulation work, power source switch, and other items shall be referred to the Installation Manual. 2. The equipment is for R410A refrigerant. 3. Install this product in a location where noise (refrigerant noise) emitted by the unit will not disturb the neighbors. (For use in quiet environments with low background noise, position the BC CONTROLLER at least 5m away from any indoor units.) 4. Indoor units P100, P125, P140 can be connected to 1 branch. (In this case, cooling capacity decrease a little.) 5. Refrigerant piping diameter for connection of plural indoor units with 1 branch shall be referred to the Installation Manual. 			

1. SPECIFICATIONS

YKB/YLM

Model name			CMB-P106V-G1		CMB-P108V-G1	
Number of branch			6		8	
Power source			1-phase 220/230/240V			
			50Hz	60Hz	50Hz	60Hz
Power input (220/230/240)	Cooling	kW	0.097/0.110/0.123	0.078/0.088/0.097	0.127/0.144/0.161	0.102/0.115/0.127
	Heating		0.045/0.051/0.057	0.036/0.041/0.045	0.060/0.068/0.076	0.048/0.054/0.060
Current (220/230/240)	Cooling	A	0.45/0.48/0.52	0.36/0.39/0.41	0.58/0.63/0.68	0.47/0.50/0.53
	Heating		0.21/0.23/0.24	0.17/0.18/0.19	0.28/0.30/0.32	0.22/0.24/0.25
External finish			Galvanized steel plate (Lower part drain pan painting N1.5)			
Connectable outdoor unit/heat source unit			PURY-(E)P200/250/300/350YLM-A(1)-(BS) PQRY-P200/250/300YHM-A			
Indoor unit capacity connectable to 1 branch			Model P80 or smaller (Use optional joint pipe combing 2 branches when the total unit capacity exceeds 81.)			
External dimension H x W x D		mm (in.)	284 x 648 x 432 (11-3/16 x 25-17/32 x 17-1/32)			
Refrigerant piping diameter	Connectable outdoor unit capacity		To outdoor unit			
			High press. pipe		Low press. pipe	
	to P200		15.88 (5/8)		19.05 (3/4)	
	mm (in.) O.D.		Braze		Braze	
	P250/P300		19.05 (3/4)		22.2 (7/8)	
	mm (in.) O.D.		Braze		Braze	
	to P350		19.05 (3/4)		28.58 (1-1/8)	
	mm (in.) O.D.		Braze		Braze	
			To indoor unit			
			Liquid pipe		Gas pipe	
mm (in.) O.D.		Indoor unit Model 50 or smaller 6.35 (1/4) Braze bigger than 50 9.52 (3/8) Braze (12.7 (1/2) with optional joint pipe used.)		Indoor unit Model 50 or smaller 12.7 (1/2) Braze bigger than 50 15.88 (5/8) Braze (19.05 (3/4) with optional joint pipe used.)		
Field drain pipe size		mm (in.) O.D.	32 (1-1/4)			
Net weight		kg (lbs)	28 (62)		33 (73)	
Accessories			Drain Connection pipe (with flexible hose and insulation) Reducer		Drain Connection pipe (with flexible hose and insulation) Reducer	
Remark						
Note:			<ol style="list-style-type: none"> 1. Installation/foundation work, electrical connection work, insulation work, power source switch, and other items shall be referred to the Installation Manual. 2. The equipment is for R410A refrigerant. 3. Install this product in a location where noise (refrigerant noise) emitted by the unit will not disturb the neighbors. (For use in quiet environments with low background noise, position the BC CONTROLLER at least 5m away from any indoor units.) 4. Indoor units P100, P125, P140 can be connected to 1 branch. (In this case, cooling capacity decrease a little.) 5. Refrigerant piping diameter for connection of plural indoor units with 1 branch shall be referred to the Installation Manual. 			

1. SPECIFICATIONS

YKB/YLM

Model name			CMB-P1010V-G1		CMB-P1013V-G1	
Number of branch			10		13	
Power source			1-phase 220/230/240V			
			50Hz	60Hz	50Hz	60Hz
Power input (220/230/240)	Cooling	kW	0.156/0.177/0.198	0.126/0.141/0.156	0.201/0.228/0.255	0.162/0.182/0.201
	Heating		0.075/0.085/0.095	0.060/0.068/0.075	0.097/0.110/0.123	0.078/0.088/0.097
Current (220/230/240)	Cooling	A	0.71/0.77/0.83	0.58/0.62/0.65	0.92/1.00/1.07	0.74/0.80/0.84
	Heating		0.35/0.37/0.40	0.28/0.30/0.32	0.45/0.48/0.52	0.36/0.39/0.41
External finish			Galvanized steel plate (Lower part drain pan painting N1.5)			
Connectable outdoor unit/heat source unit			PURY-(E)P200/250/300/350YLM-A(1)(-BS) PQRY-P200/250/300YHM-A			
Indoor unit capacity connectable to 1 branch			Model P80 or smaller (Use optional joint pipe combing 2 branches when the total unit capacity exceeds 81.)			
External dimension H x W x D		mm (in.)	284 x 648 x 432 (11-3/16 x 25-17/32 x 17-1/32)		284 x 1,098 x 432 (11-3/16 x 43-1/4 x 17-1/32)	
Refrigerant piping diameter	Connectable outdoor unit capacity		To outdoor unit			
			High press. pipe		Low press. pipe	
	to P200		15.88 (5/8)		19.05 (3/4)	
	mm (in.) O.D.		Braze		Braze	
	P250/P300		19.05 (3/4)		22.2 (7/8)	
	mm (in.) O.D.		Braze		Braze	
	to P350		19.05 (3/4)		28.58 (1-1/8)	
	mm (in.) O.D.		Braze		Braze	
			To indoor unit			
			Liquid pipe		Gas pipe	
mm (in.) O.D.		Indoor unit Model 50 or smaller 6.35 (1/4) Braze bigger than 50 9.52 (3/8) Braze (12.7 (1/2) with optional joint pipe used.)		Indoor unit Model 50 or smaller 12.7 (1/2) Braze bigger than 50 15.88 (5/8) Braze (19.05 (3/4) with optional joint pipe used.)		
Field drain pipe size		mm (in.) O.D.	32 (1-1/4)			
Net weight		kg (lbs)	38 (84)		49 (109)	
Accessories			Drain Connection pipe (with flexible hose and insulation) Reducer		Drain Connection pipe (with flexible hose and insulation) Reducer	
Remark						
Note:			<ol style="list-style-type: none"> 1. Installation/foundation work, electrical connection work, insulation work, power source switch, and other items shall be referred to the Installation Manual. 2. The equipment is for R410A refrigerant. 3. Install this product in a location where noise (refrigerant noise) emitted by the unit will not disturb the neighbors. (For use in quiet environments with low background noise, position the BC CONTROLLER at least 5m away from any indoor units.) 4. Indoor units P100, P125, P140 can be connected to 1 branch. (In this case, cooling capacity decrease a little.) 5. Refrigerant piping diameter for connection of plural indoor units with 1 branch shall be referred to the Installation Manual. 			

1. SPECIFICATIONS

YKB/YLM

Model name			CMB-P1016V-G1	
Number of branch			16	
Power source			1-phase 220/230/240V	
			50Hz	60Hz
Power input (220/230/240)	Cooling	kW	0.246/0.279/0.312	
	Heating		0.198/0.222/0.246	
Current (220/230/240)	Cooling	A	0.119/0.135/0.151	
	Heating		0.90/0.97/1.03	
			0.55/0.59/0.63	0.44/0.47/0.50
External finish			Galvanized steel plate (Lower part drain pan painting N1.5)	
Connectable outdoor unit/heat source unit			PURY-(E)P200/250/300/350YLM-A(1)-(BS) PQRY-P200/250/300YHM-A	
Indoor unit capacity connectable to 1 branch			Model P80 or smaller (Use optional joint pipe combing 2 branches when the total unit capacity exceeds 81.)	
External dimension H x W x D		mm (in.)	284 x 1,098 x 432 (11-3/16 x 43-1/4 x 17-1/32)	
Refrigerant piping diameter	Connectable outdoor unit capacity		To outdoor unit	
			High press. pipe	Low press. pipe
	to P200		15.88 (5/8)	19.05 (3/4)
	mm (in.) O.D.		Brazed	Brazed
	P250/P300		19.05 (3/4)	22.2 (7/8)
	mm (in.) O.D.		Brazed	Brazed
	to P350		19.05 (3/4)	28.58 (1-1/8)
	mm (in.) O.D.		Brazed	Brazed
			To indoor unit	
			Liquid pipe	Gas pipe
mm (in.) O.D.		Indoor unit Model 50 or smaller 6.35 (1/4) Brazed bigger than 50 9.52 (3/8) Brazed (12.7 (1/2) with optional joint pipe used.)	Indoor unit Model 50 or smaller 12.7 (1/2) Brazed bigger than 50 15.88 (5/8) Brazed (19.05 (3/4) with optional joint pipe used.)	
Field drain pipe size		mm (in.) O.D.	32 (1-1/4)	
Net weight		kg (lbs)	56 (124)	
Accessories			Drain Connection pipe (with flexible hose and insulation) Reducer	
Remark				
Note: <ol style="list-style-type: none"> 1. Installation/foundation work, electrical connection work, insulation work, power source switch, and other items shall be referred to the Installation Manual. 2. The equipment is for R410A refrigerant. 3. Install this product in a location where noise (refrigerant noise) emitted by the unit will not disturb the neighbors. (For use in quiet environments with low background noise, position the BC CONTROLLER at least 5m away from any indoor units.) 4. Indoor units P100, P125, P140 can be connected to 1 branch. (In this case, cooling capacity decrease a little.) 5. Refrigerant piping diameter for connection of plural indoor units with 1 branch shall be referred to the Installation Manual. 				

1. SPECIFICATIONS

YKB/YLM

Model name			CMB-P108V-GA1		CMB-P1010V-GA1	
Number of branch			8		10	
Power source			1-phase 220/230/240V			
			50Hz	60Hz	50Hz	60Hz
Power input (220/230/240)	Cooling	kW	0.127/0.144/0.161	0.102/0.115/0.127	0.156/0.177/0.198	0.126/0.141/0.156
	Heating		0.060/0.068/0.076	0.048/0.054/0.060	0.075/0.085/0.095	0.060/0.068/0.075
Current (220/230/240)	Cooling	A	0.58/0.63/0.68	0.47/0.50/0.53	0.71/0.77/0.83	0.58/0.62/0.65
	Heating		0.28/0.30/0.32	0.22/0.24/0.25	0.35/0.37/0.40	0.28/0.30/0.32
External finish			Galvanized steel plate (Lower part drain pan painting N1.5)			
Connectable outdoor unit/heat source unit			PURY-(E)P200/250/300/350/400/450/500/550/600/650Y(S)LM-A(1)(-BS) PQRY-P200/250/300/400/450/500/550/600Y(S)HM-A			
Indoor unit capacity connectable to 1 branch			Model P80 or smaller (Use optional joint pipe combing 2 branches when the total unit capacity exceeds 81.)			
External dimension H x W x D		mm (in.)	289 x 1,110 x 520 (11-13/32 x 43-23/32 x 20-1/2)			
Refrigerant piping diameter	Connectable outdoor unit capacity		To outdoor unit			
			High press. pipe		Low press. pipe	
	to P200		15.88 (5/8)		19.05 (3/4)	
	mm (in.) O.D.		Brazed		Brazed	
	P250/P300		19.05 (3/4)		22.2 (7/8)	
	mm (in.) O.D.		Brazed		Brazed	
	to P350		19.05 (3/4)		28.58 (1-1/8)	
	mm (in.) O.D.		Brazed		Brazed	
	P400 to P500		22.2 (7/8)		28.58 (1-1/8)	
	mm (in.) O.D.		Brazed		Brazed	
	P550 to P650		28.58 (1-1/8)		28.58 (1-1/8)	
	mm (in.) O.D.		Brazed		Brazed	
			To indoor unit			
			Liquid pipe		Gas pipe	
mm (in.) O.D.		Indoor unit Model 50 or smaller 6.35 (1/4) Brazed bigger than 50 9.52 (3/8) Brazed (12.7 (1/2) with optional joint pipe used.)		Indoor unit Model 50 or smaller 12.7 (1/2) Brazed bigger than 50 15.88 (5/8) Brazed (19.05 (3/4) with optional joint pipe used.)		
Total indoor unit capacity connected to this Sub BC controller		To other BC controller				
		High press. pipe		Low press. pipe		
		Liquid pipe				
to P200		15.88 (5/8) Brazed		19.05 (3/4) Brazed		
mm (in.) O.D.		9.52 (3/8) Brazed				
P201 to P300		19.05 (3/4) Brazed		22.2 (7/8) Brazed		
mm (in.) O.D.		9.52 (3/8) Brazed				
P301 to P350		19.05 (3/4) Brazed		28.58 (1-1/8) Brazed		
mm (in.) O.D.		12.7 (1/2) Brazed				
Field drain pipe size		mm (in.) O.D.	32 (1-1/4)			
Net weight		kg (lbs)	47 (104)		50 (111)	
Accessories			Drain Connection pipe (with flexible hose and insulation) Reducer		Drain Connection pipe (with flexible hose and insulation) Reducer	
Remark						
Note:			<ol style="list-style-type: none"> 1. Installation/foundation work, electrical connection work, insulation work, power source switch, and other items shall be referred to the Installation Manual. 2. The equipment is for R410A refrigerant. 3. Install this product in a location where noise (refrigerant noise) emitted by the unit will not disturb the neighbors. (For use in quiet environments with low background noise, position the BC CONTROLLER at least 5m away from any indoor units.) 4. Indoor units P100, P125, P140 can be connected to 1 branch. (In this case, cooling capacity decrease a little.) 5. Refrigerant piping diameter for connection of plural indoor units with 1 branch shall be referred to the Installation Manual. 			

BC

1. SPECIFICATIONS

YKB/YLM

Model name			CMB-P1013V-GA1		CMB-P1016V-GA1	
Number of branch			13		16	
Power source			1-phase 220/230/240V			
			50Hz	60Hz-	50Hz	60Hz-
Power input (220/230/240)	Cooling	kW	0.201/0.228/0.255	0.162/0.182/0.201	0.246/0.279/0.312	0.198/0.222/0.246
	Heating		0.097/0.110/0.123	0.078/0.088/0.097	0.119/0.135/0.151	0.096/0.108/0.119
Current (220/230/240)	Cooling	A	0.92/1.00/1.07	0.74/0.80/0.84	1.12/1.22/1.30	0.90/0.97/1.03
	Heating		0.45/0.48/0.52	0.36/0.39/0.41	0.55/0.59/0.63	0.44/0.47/0.50
External finish			Galvanized steel plate (Lower part drain pan painting N1.5)			
Connectable outdoor unit/heat source unit			PURY-(E)P200/250/300/350/400/450/500/550/600/650Y(S)LM-A(1)(-BS) PQRY-P200/250/300/400/450/500/550/600Y(S)HM-A			
Indoor unit capacity connectable to 1 branch			Model P80 or smaller (Use optional joint pipe combing 2 branches when the total unit capacity exceeds 81.)			
External dimension H x W x D		mm (in.)	289 x 1,110 x 520 (11-13/32 x 43-23/32 x 20-1/2)			
Refrigerant piping diameter	Connectable outdoor unit capacity		To outdoor unit			
			High press. pipe		Low press. pipe	
	to P200		15.88 (5/8)		19.05 (3/4)	
	mm (in.) O.D.		Braze		Braze	
	P250/P300		19.05 (3/4)		22.2 (7/8)	
	mm (in.) O.D.		Braze		Braze	
	to P350		19.05 (3/4)		28.58 (1-1/8)	
	mm (in.) O.D.		Braze		Braze	
	P400 to P500		22.2 (7/8)		28.58 (1-1/8)	
	mm (in.) O.D.		Braze		Braze	
	P550 to P650		28.58 (1-1/8)		28.58 (1-1/8)	
	mm (in.) O.D.		Braze		Braze	
			To indoor unit			
		Liquid pipe		Gas pipe		
mm (in.) O.D.		Indoor unit Model 50 or smaller 6.35 (1/4) Braze bigger than 50 9.52 (3/8) Braze (12.7 (1/2) with optional joint pipe used.)		Indoor unit Model 50 or smaller 12.7 (1/2) Braze bigger than 50 15.88 (5/8) Braze (19.05 (3/4) with optional joint pipe used.)		
Total indoor unit capacity connected to this Sub BC controller		To other BC controller				
		High press. pipe		Low press. pipe		
		Liquid pipe				
to P200		15.88 (5/8) Braze		19.05 (3/4) Braze		
mm (in.) O.D.		9.52 (3/8) Braze				
P201 to P300		19.05 (3/4) Braze		22.2 (7/8) Braze		
mm (in.) O.D.		9.52 (3/8) Braze				
P301 to P350		19.05 (3/4) Braze		28.58 (1-1/8) Braze		
mm (in.) O.D.		12.7 (1/2) Braze				
Field drain pipe size	mm (in.) O.D.	32 (1-1/4)				
Net weight	kg (lbs)	55 (122)		62 (137)		
Accessories			Drain Connection pipe (with flexible hose and insulation) Reducer		Drain Connection pipe (with flexible hose and insulation) Reducer	
Remark						
Note:			<ol style="list-style-type: none"> 1. Installation/foundation work, electrical connection work, insulation work, power source switch, and other items shall be referred to the Installation Manual. 2. The equipment is for R410A refrigerant. 3. Install this product in a location where noise (refrigerant noise) emitted by the unit will not disturb the neighbors. (For use in quiet environments with low background noise, position the BC CONTROLLER at least 5m away from any indoor units.) 4. Indoor units P100, P125, P140 can be connected to 1 branch. (In this case, cooling capacity decrease a little.) 5. Refrigerant piping diameter for connection of plural indoor units with 1 branch shall be referred to the Installation Manual. 			

BC

1. SPECIFICATIONS

YKB/YLM

Model name		CMB-P1016V-HA1	
Number of branch		16	
Power source		1-phase 220/230/240V	
		50Hz	60Hz
Power input (220/230/240)	Cooling	kW	0.246/0.279/0.312
	Heating		0.119/0.135/0.151
Current (220/230/240)	Cooling	A	1.12/1.22/1.30
	Heating		0.55/0.59/0.63
External finish		Galvanized steel plate (Lower part drain pan painting N1.5)	
Connectable outdoor unit/heat source unit		PURY-(E)P700/750/800/850/900YSLM-A(1)(-BS)	
Indoor unit capacity connectable to 1 branch		Model P80 or smaller (Use optional joint pipe combing 2 branches when the total unit capacity exceeds 81.)	
External dimension H x W x D		mm (in.) 289 x 1,110 x 520 (11-13/32 x 43-23/32 x 20-1/2)	
Refrigerant piping diameter	Connectable outdoor unit capacity		To outdoor unit
			High press. pipe
	P700/P750/ P800 mm (in.) O.D.		28.58 (1-1/8) Brazed
	P850/P900 mm (in.) O.D.		28.58 (1-1/8) Brazed
			Low press. pipe
			34.93 (1-3/8) Brazed
			41.28 (1-5/8) Brazed
			To indoor unit
			Liquid pipe
	mm (in.) O.D.		Indoor unit Model 50 or smaller 6.35 (1/4) Brazed bigger than 50 9.52 (3/8) Brazed (12.7 (1/2) with optional joint pipe used.)
		Gas pipe	
		Indoor unit Model 50 or smaller 12.7 (1/2) Brazed bigger than 50 15.88 (5/8) Brazed (19.05 (3/4), 22.2 (7/8) with optional joint pipe used.)	
Total indoor unit capacity connected to this Sub BC controller		To other BC controller	
		High press. pipe	Low press. pipe
		Liquid pipe	
to P200 mm (in.) O.D.		15.88 (5/8) Brazed 9.52 (3/8) Brazed	19.05 (3/4) Brazed
P201 to P300 mm (in.) O.D.		19.05 (3/4) Brazed 9.52 (3/8) Brazed	22.2 (7/8) Brazed
P301 to P350 mm (in.) O.D.		19.05 (3/4) Brazed 12.7 (1/2) Brazed	28.58 (1-1/8) Brazed
P351 to P400 mm (in.) O.D.		22.2 (7/8) Brazed 12.7 (1/2) Brazed	28.58 (1-1/8) Brazed
P401 to P450 mm (in.) O.D.		22.2 (7/8) Brazed 15.88 (5/8) Brazed	28.58 (1-1/8) Brazed
Field drain pipe size		mm (in.) O.D. 32 (1-1/4)	
Net weight		kg (lbs) 69 (153)	
Accessories		Drain Connection pipe (with flexible hose and insulation) Reducer	
Remark			
<p>Note:</p> <ol style="list-style-type: none"> 1. Installation/foundation work, electrical connection work, insulation work, power source switch, and other items shall be referred to the Installation Manual. 2. The equipment is for R410A refrigerant. 3. When using an outdoor unit -28HP(P700) or more, use this product. 4. Install this product in a location where noise (refrigerant noise) emitted by the unit will not disturb the neighbors. (For use in quiet environments with low background noise, position the BC CONTROLLER at least 5m away from any indoor units.) 5. Indoor units P100, P125, P140 can be connected to 1 branch. (In this case, cooling capacity decrease a little.) 6. Refrigerant piping diameter for connection of plural indoor units with 1 branch shall be referred to the Installation Manual. 			

BC

1. SPECIFICATIONS

Model name			CMB-P104V-GB1		CMB-P108V-GB1	
Number of branch			4		8	
Power source			1-phase 220/230/240V			
			50Hz	60Hz	50Hz	60Hz
Power input (220/230/240)	Cooling	kW	0.060/0.068/0.076	0.048/0.054/0.060	0.119/0.135/0.151	0.096/0.108/0.119
	Heating		0.030/0.034/0.038	0.024/0.027/0.030	0.060/0.068/0.076	0.048/0.054/0.060
Current (220/230/240)	Cooling	A	0.28/0.30/0.32	0.22/0.24/0.25	0.55/0.59/0.63	0.44/0.47/0.50
	Heating		0.14/0.15/0.16	0.11/0.12/0.13	0.28/0.30/0.32	0.22/0.24/0.25
External finish			Galvanized steel plate (Lower part drain pan painting N1.5)			
Connectable BC controller			CMB-P108/1010/1013/1016V-GA1, CMB-P1016V-HA1 CMB-P104/108V-GB1, CMB-P1016V-HB1			
Indoor unit capacity connectable to 1 branch			Model P80 or smaller (Use optional joint pipe combining 2 branches when the total unit capacity exceeds 81.)			
External dimension H x W x D		mm (in.)	284 x 648 x 432 (11-3/16 x 25-17/32 x 17-1/32)			
Refrigerant piping diameter			To indoor unit			
			Liquid pipe		Gas pipe	
	mm (in.) O.D.		Indoor unit Model 50 or smaller 6.35 (1/4) Brazed bigger than 50 9.52 (3/8) Brazed (12.7 (1/2) with optional joint pipe used.)		Indoor unit Model 50 or smaller 12.7 (1/2) Brazed bigger than 50 15.88 (5/8) Brazed (19.05 (3/4) with optional joint pipe used.)	
	Total indoor unit capacity connected to this Sub BC controller		To other BC controller			
			High press. pipe		Low press. pipe	
			Liquid pipe			
	to P200		15.88 (5/8) Brazed		19.05 (3/4) Brazed	
	mm (in.) O.D.		9.52 (3/8) Brazed			
	P201 to P300		19.05 (3/4) Brazed		22.2 (7/8) Brazed	
	mm (in.) O.D.		9.52 (3/8) Brazed			
P301 to P350		19.05 (3/4) Brazed		28.58 (1-1/8) Brazed		
mm (in.) O.D.		12.7 (1/2) Brazed				
Field drain pipe size		mm (in.) O.D.	32 (1-1/4)			
Net weight		kg (lbs)	22 (49)		32 (71)	
Accessories			Drain Connection pipe (with flexible hose and insulation) Reducer		Drain Connection pipe (with flexible hose and insulation) Reducer	
Remark						
<p>Note:</p> <ol style="list-style-type: none"> 1. Installation/foundation work, electrical connection work, insulation work, power source switch, and other items shall be referred to the Installation Manual. 2. The equipment is for R410A refrigerant. 3. For sub BC controller CMB-P-V-GB1 the connectable indoor unit capacities may sum to equal that of a P350 unit or less. However, if two sub controllers are used the TOTAL sum of connectable units connected to BOTH sub controllers must also not exceed that a P350 unit. 4. To use the Sub BC controller, the Main BC controller is necessary to be connected with. 5. Install this product in a location where noise (refrigerant noise) emitted by the unit will not disturb the neighbors. (For use in quiet environments with low background noise, position the BC CONTROLLER at least 5m away from any indoor units.) 6. Indoor units P100, P125, P140 can be connected to 1 branch. (In this case, cooling capacity decrease a little.) 7. Refrigerant piping diameter for connection of plural indoor units with 1 branch shall be referred to the Installation Manual. 						

1. SPECIFICATIONS

YKB/YLM

Model name		CMB-P1016V-HB1		
Number of branch		16		
Power source		1-phase 220/230/240V		
		50Hz	60Hz	
Power input (220/230/240)	Cooling	kW	0.237/0.269/0.301	
	Heating		0.192/0.216/0.237	
Current (220/230/240)	Cooling	A	0.119/0.135/0.151	
	Heating		0.096/0.108/0.120	
External finish		Galvanized steel plate (Lower part drain pan painting N1.5)		
Connectable BC controller		Main BC	CMB-P108/1010/1013/1016V-GA1, CMB-P1016V-HA1	
		Sub BC	CMB-P104/108V-GB1, CMB-P1016V-HB1	
Indoor unit capacity connectable to 1 branch		Model P80 or smaller (Use optional joint pipe combining 2 branches when the total unit capacity exceeds 81.)		
External dimension H x W x D		mm (in.)	284 x 1,098 x 432 (11-3/16 x 43-1/4 x 17-1/32)	
Refrigerant piping diameter	Connectable outdoor unit capacity		To outdoor unit	
			High press. pipe	
	mm (in.) O.D.		-	
			To indoor unit	
			Liquid pipe	
	mm (in.) O.D.		Indoor unit Model 50 or smaller 6.35 (1/4) Brazed bigger than 50 9.52 (3/8) Brazed (12.7 (1/2) with optional joint pipe used.)	
			Gas pipe	
	mm (in.) O.D.		Indoor unit Model 50 or smaller 12.7 (1/2) Brazed bigger than 50 15.88 (5/8) Brazed (19.05 (3/4), 22.2 (7/8) with optional joint pipe used.)	
	Total indoor unit capacity connected to this Sub BC controller		To other BC controller	
			High press. pipe	Low press. pipe
			Liquid pipe	
	to P200		15.88 (5/8) Brazed	19.05 (3/4) Brazed
mm (in.) O.D.		9.52 (3/8) Brazed		
P201 to P300		19.05 (3/4) Brazed	22.2 (7/8) Brazed	
mm (in.) O.D.		9.52 (3/8) Brazed		
P301 to P350		19.05 (3/4) Brazed	28.58 (1-1/8) Brazed	
mm (in.) O.D.		12.7 (1/2) Brazed		
P351 to P400		22.2 (7/8) Brazed	28.58 (1-1/8) Brazed	
mm (in.) O.D.		12.7 (1/2) Brazed		
P401 to P450		22.2 (7/8) Brazed	28.58 (1-1/8) Brazed	
mm (in.) O.D.		15.88 (5/8) Brazed		
Field drain pipe size		mm (in.) O.D.	32 (1-1/4)	
Net weight		kg (lbs)	55 (122)	
Accessories		Drain Connection pipe (with flexible hose and insulation) Reducer		
Remark				
<p>Note:</p> <ol style="list-style-type: none"> 1. Installation/foundation work, electrical connection work, insulation work, power source switch, and other items shall be referred to the Installation Manual. 2. The equipment is for R410A refrigerant. 3. For sub BC controller CMB-P1016V-HB1 the connectable indoor unit capacities may sum to equal that of a P350 unit or less. However, if two sub controllers are used the TOTAL sum of connectable units connected to BOTH sub controllers must also not exceed that of a P450 unit. 4. To use the Sub BC controller, the Main BC controller is necessary to be connected with. 5. Install this product in a location where noise (refrigerant noise) emitted by the unit will not disturb the neighbors. (For use in quiet environments with low background noise, position the BC CONTROLLER at least 5m away from any indoor units.) 6. Indoor units P100, P125, P140 can be connected to 1 branch. (In this case, cooling capacity decrease a little.) 7. Refrigerant piping diameter for connection of plural indoor units with 1 branch shall be referred to the Installation Manual. 				

BC

CMB-P104, 105, 106, 108, 1010, 1013, 1016V-G1

Unit : mm

- <Accessories>
- Refrigerant<Low pressure> conn.pipe.....2pcs.
 - Refrigerant<High pressure> conn.pipe.....1pc.
 - Drain hose I.D.32 (1-1/4").....1pc.
 - Hose band.....1pc.
 - Tie band.....1pc.

- Note 1. Suspension bolt(φ10), washer(M10), and nut(M10) prepare in the field.
 2. Take notice of service space as follows.
 (Please give attention not to occupy service space by letting ducts and pipes through.)
 3. Install this product in a location where noise (refrigerant noise) emitted by the unit will not disturb the neighbors.
 (For use in quiet environments with low background noise, position the BC CONTROLLER at least 5m away from any indoor units.)
 4. Refer to the Installation Manual for refrigerant piping diameter size when connecting plural indoor units with 1 branch.

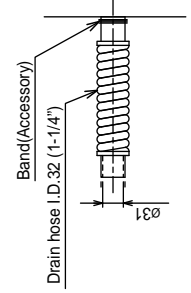
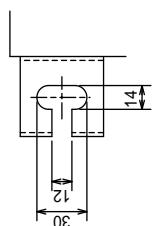
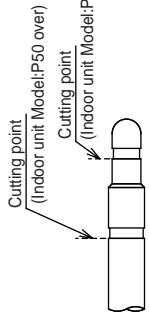

Connection pipe of outdoor unit(High pressure)
 P200:φ15.88<Brazed>(use attachment pipe)
 P250:P300;P350:φ19.05<Brazed>

Connection pipe of outdoor unit(Low pressure)
 P200:φ19.05<Brazed>(use attachment pipe)
 P250:P300;φ22.2<Brazed>
 P350:φ28.6<Brazed>(use attachment pipe)

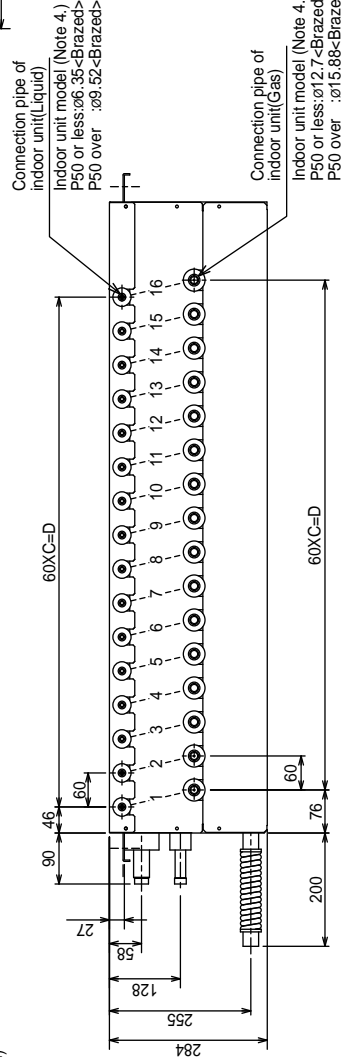
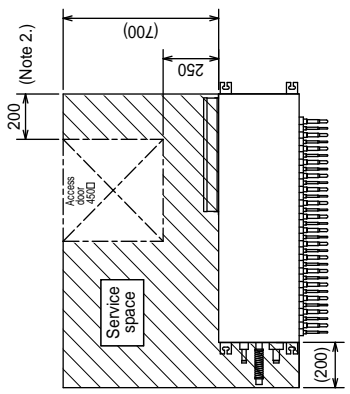
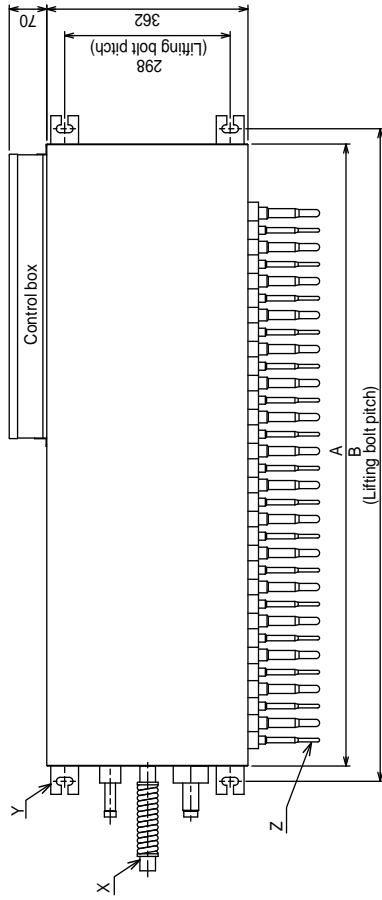

	A	B	C	D
CMB-P104V-G1			3	180
CMB-P105V-G1			4	240
CMB-P106V-G1	648	702	5	300
CMB-P108V-G1			7	420
CMB-P1010V-G1			9	540
CMB-P1013V-G1			12	720
CMB-P1016V-G1	1098	1152	15	900

CMB-P108, 1010, 1013, 1016V-GA1

Unit : mm

- <Accessories>
- Refrigerant<Low pressure> conn. pipe.....1pc.
- Refrigerant<high pressure> conn. pipe...2pcs.
- Drain hose I.D.32 (1-1/4").....1pc.
- Hose band.....1pc.
- Tie band.....1pc.

Connection pipe of SUB BC CONTROLLER (High pressure)

Total capacity of indoor unit at SUB BC CONTROLLER (use attachment pipe of SUB BC CONTROLLER)
 P200 or less:ø15.88<Brazed>
 P350 or less:ø19.05<Brazed>
 P350 over :ø22.2<Brazed> (use attachment pipe of JOINT<option>)

Connection pipe of SUB BC CONTROLLER (Liquid)

Total capacity of indoor unit at SUB BC CONTROLLER (use attachment pipe of SUB BC CONTROLLER)
 P300 or less :ø9.52<Brazed>
 P400 or less :ø12.7<Brazed> (use attachment pipe of SUB BC CONTROLLER)
 P400 over :ø15.88<Brazed> (use attachment pipe of JOINT<option>)

Connection pipe of SUB BC CONTROLLER (Low pressure)

Total capacity of indoor unit at SUB BC CONTROLLER (use attachment pipe of SUB BC CONTROLLER)
 P200 or less:ø19.05<Brazed>
 P300 or less:ø22.2<Brazed>
 P300 over:ø28.6<Brazed> (use attachment pipe of SUB BC CONTROLLER)

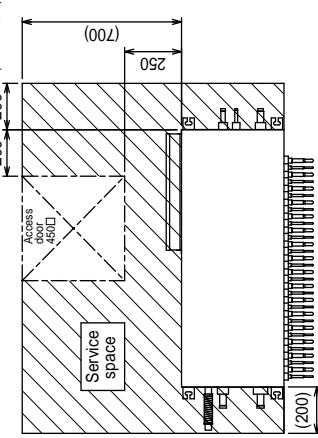

- Note 1, Suspension bolt(ø10), washer(M10), and nut(M10) prepare in the field.
2. Take notice of service space as follows.
 (Please give attention not to occupy service space by letting ducts and pipes through.)
3. Please take service space for connection pipe of SUB BC CONTROLLER.
4. Install this product in a location where noise (refrigerant noise) emitted by the unit will not disturb the neighbors.
 (For use in quiet environments with low background noise, position the BC CONTROLLER at least 5m away from any indoor units.)
5. Refer to the Installation Manual for refrigerant piping diameter size when connecting plural indoor units with 1 branch.



Detail of Z section

Detail of Y section

Detail of X section

Connection pipe of outdoor unit(High pressure)
 P250,300,350:ø19.05<Brazed> (use attachment pipe)
 P400,450,500:ø22.2 <Brazed>
 P550,600,650:ø28.6 <Brazed> (use attachment pipe)

Drain pipe O.D.32 (1-1/4")

Connection pipe of outdoor unit (Low pressure)
 P250,300:ø22.2<Brazed> (use attachment pipe)
 P350,400,450,500,550,600,650:ø28.6<Brazed>

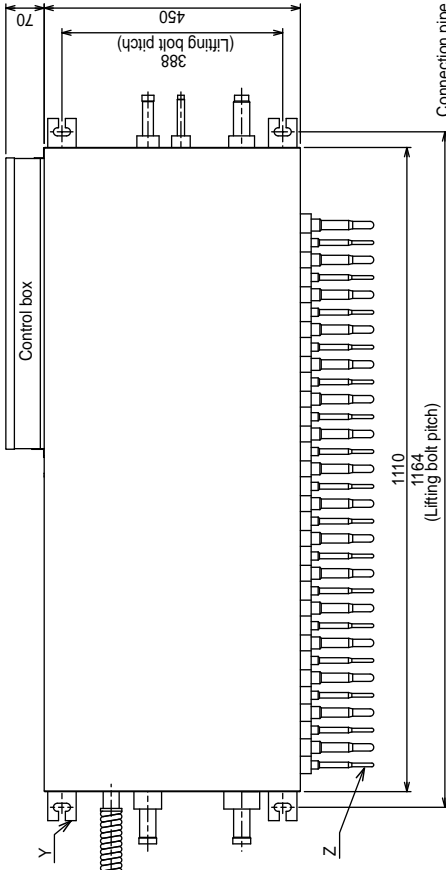

Connection pipe of indoor unit(Liquid)
 Indoor unit model (Note 5)
 P50 or less:ø6.35<Brazed>
 P50 over :ø9.52<Brazed>

Connection pipe of indoor unit(Gas)
 Indoor unit model (Note 5)
 P50 or less:ø12.7<Brazed>
 P50 over :ø15.88<Brazed>

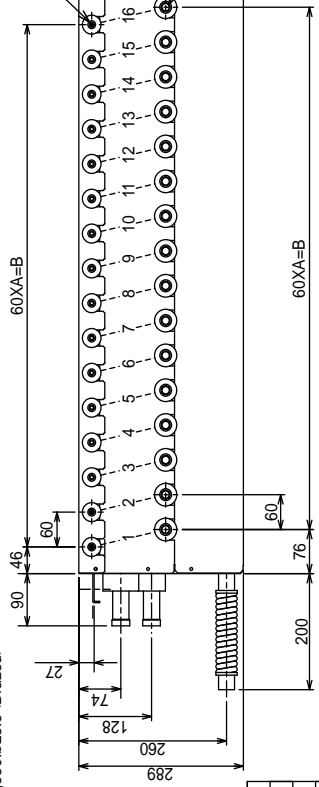

	A	B
CMB-P108V-GA1	7	420
CMB-P1010V-GA1	9	540
CMB-P1013V-GA1	12	720
CMB-P1016V-GA1	15	900

CMB-P1016V-HA1

Unit : mm

- <Accessories>
- Refrigerant<Low pressure> conn. pipe.....1pc.
 - Drain hose I.D.32 (1-1/4").....1pc.
 - Hose band.....1pc.
 - Tie band.....1pc.

- Note1. Suspension bolt(φ10), washer(M10), and nut(M10) prepare in the field.
 2. Take notice of service space as follows.
 (Please give attention not to occupy service space by letting ducts and pipes through.)
 3. Please take service space for connection pipe of SUB BC CONTROLLER.
 4. When using an outdoor unit-28HP(P700) or more, use this product.
 5. Install this product in a location where noise (refrigerant noise) emitted by the unit will not disturb the neighbors.
 (For use in quiet environments with low background noise, position the BC CONTROLLER at least 5m away from any indoor units.)
 6. Refer to the Installation Manual for refrigerant piping diameter size when connecting plural indoor units with 1 branch.

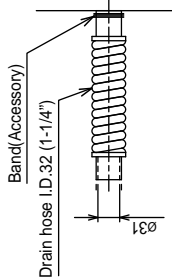
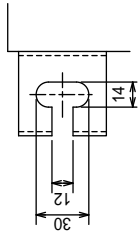
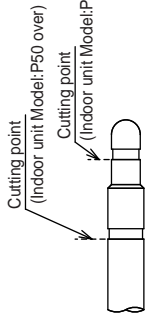

Connection pipe of SUB BC CONTROLLER (High pressure)
 Total capacity of indoor unit at SUB BC CONTROLLER P200 or less: ø15.88<Brazed> (use attachment pipe of SUB BC CONTROLLER)
 P300 or less: ø19.05<Brazed> (use attachment pipe of SUB BC CONTROLLER)
 P350 or less: ø22.2<Brazed> (use attachment pipe of JOINT-option)

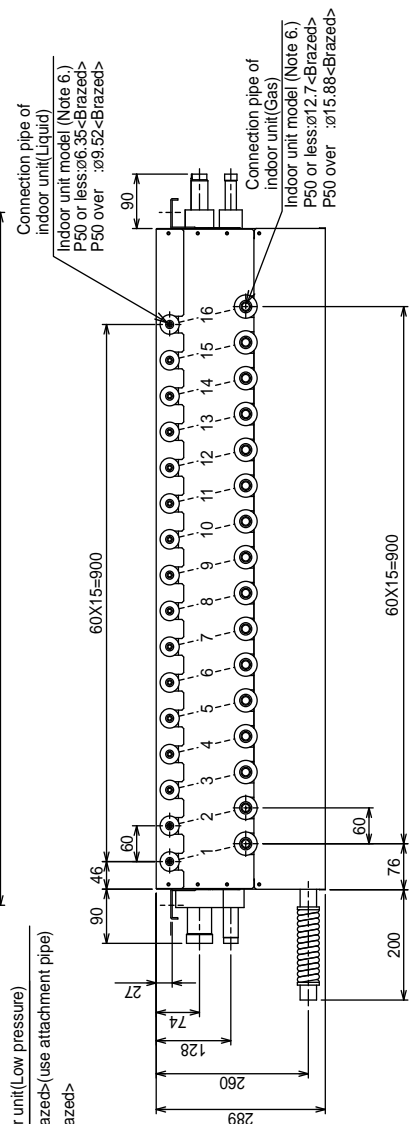
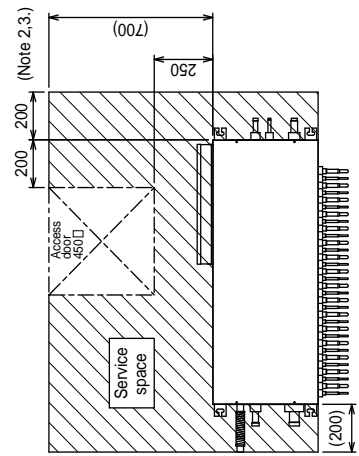
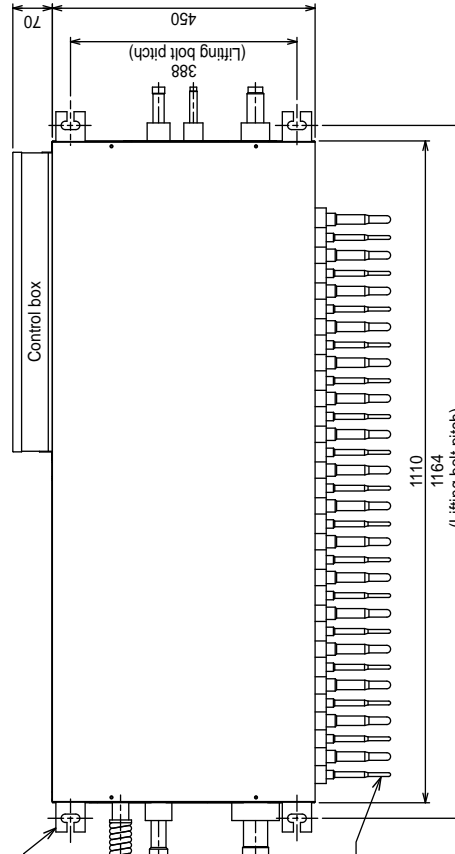
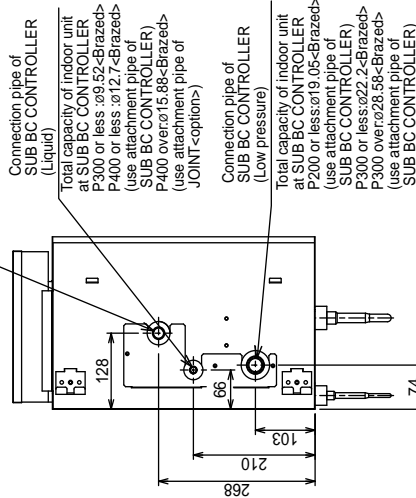

CMB-P104, 108V-GB1

Unit : mm

<Accessories>

- Refrigerant<Low pressure> conn. pipe.....4pcs.
- Refrigerant<High pressure> conn. pipe.....2pcs.
- Refrigerant<Liquid> conn. pipe.....2pcs.
- Drain hose I.D.32 (1-1/4).....1pc.
- Hose band.....1pc.
- Tie band.....1pc.

Note 1. Suspension bolt(φ10), washer(M10), and nut(M10) prepare in the field.

2. Take notice of service space as follows.
(Please give attention not to occupy service space by letting ducts and pipes through.)
3. Can't use singleness.(MAIN BC CONTROLLER is necessary.)
4. Install this product in a location where noise (refrigerant noise) emitted by the unit will not disturb the neighbors.
(For use in quiet environments with low background noise, position the BC CONTROLLER at least 5m away from any indoor units.)
5. Refer to the Installation Manual for refrigerant piping diameter size when connecting plural indoor units with 1 branch.

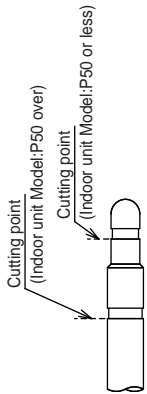

Detail of Z section

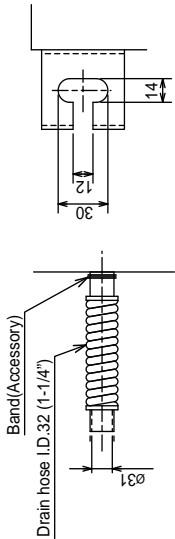

Detail of Y section

Connection pipe of MAIN BC CONTROLLER (High pressure)

Total capacity of indoor units at SUB BC CONTROLLER
P200 or less:φ15.88<Brazed>(use attachment pipe)
P200 over:φ19.05<Brazed>

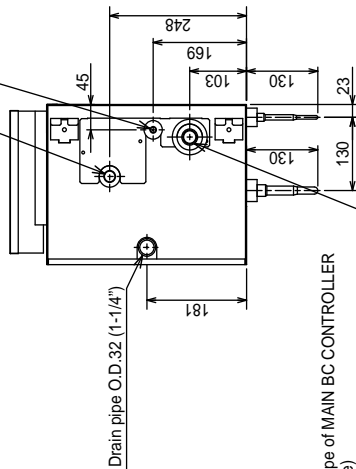

Connection pipe of MAIN BC CONTROLLER (Low pressure)

Total capacity of indoor units at SUB BC CONTROLLER
P200 or less:φ19.05<Brazed>(use attachment pipe)
P300 or less:φ22.2<Brazed>
P300 over:φ28.6<Brazed>(use attachment pipe)

Connection pipe of MAIN BC CONTROLLER(Liquid)

Total capacity of indoor units at SUB BC CONTROLLER
P300 or less:φ9.52<Brazed>
P300 over:φ12.7<Brazed>(use attachment pipe)

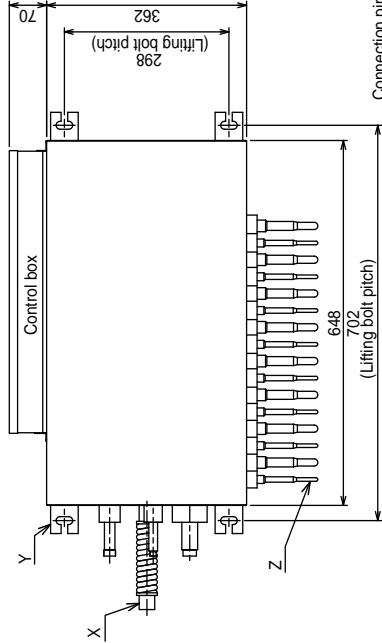

Connection pipe of indoor unit(Liquid)

Indoor unit model (Note 5.)
P50 or less:φ6.35<Brazed>
P50 over :φ9.52<Brazed>

Connection pipe of indoor unit(Gas)

Indoor unit model (Note 5.)
P50 or less:φ12.7<Brazed>
P50 over :φ15.88<Brazed>

60XA=B

60XA=B

60XA=B

60XA=B

60XA=B

60XA=B

60XA=B

60XA=B

60XA=B

	A	B
CMB-P104V-GB1	3	180
CMB-P108V-GB1	7	420

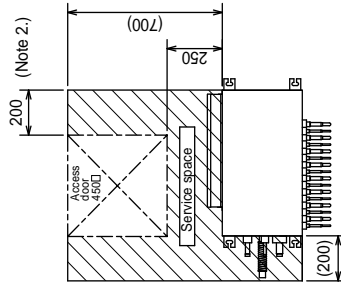

CMB-P1016V-HB1

Unit : mm

- <Accessories>
- Refrigerant<Low pressure> conn. pipe.....4pcs
 - Refrigerant<High pressure> conn. pipe.....2pcs
 - Refrigerant<Liquid> conn. pipe.....2pcs
 - Drain hose I.D.32 (1-1/4").....1pc
 - Hose band.....1pc
 - Tie band.....1pc

Note1.Suspension bolt(φ10),washer(M10),and nut(M10) prepare in the field.

2. Take notice of service space as follows.

(Please give attention not to occupy service space by letting ducts and pipes through.)

3.Can't use singleness.(MAIN BC CONTROLLER is necessary)

4. Install this product in a location where noise (refrigerant noise) emitted by the unit will not disturb the neighbors.

(For use in quiet environments with low background noise, position the BC CONTROLLER at least 5m away from any indoor units.)

5. Refer to the Installation Manual for refrigerant piping diameter size when connecting plural indoor units with 1 branch.

Cutting point
(Indoor unit Model:P50 over)

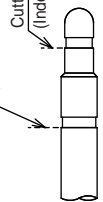

Detail of Z section

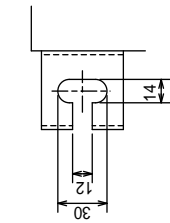

Detail of Y section

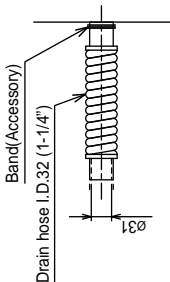

Detail of X section

Connection pipe of MAIN BC CONTROLLER (High pressure)

Total capacity of indoor units at SUB BC CONTROLLER
P200 or less:φ15.88<Brazed>(use attachment pipe)
P200 over :φ19.05<Brazed>

Connection pipe of MAIN BC CONTROLLER(Liquid)

Total capacity of indoor units at SUB BC CONTROLLER
P300 or less:φ9.52 <Brazed>
P300 over :φ12.7 <Brazed>(use attachment pipe)

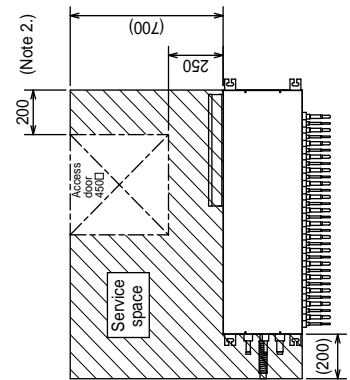
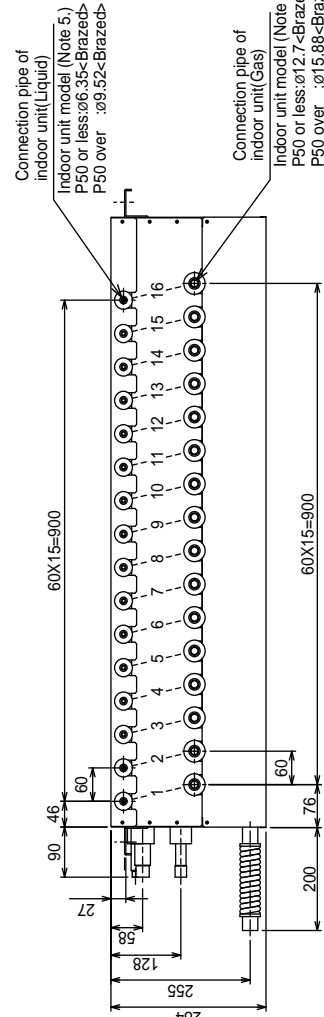
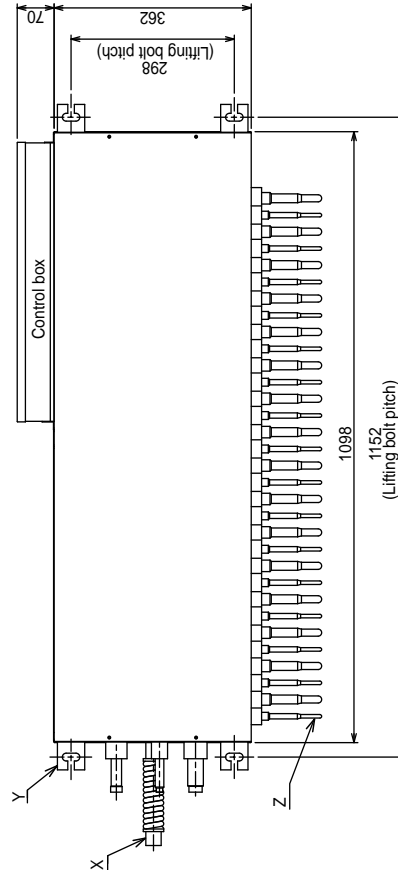

BC

CMB-P104V-G1

(Symbol explanation)	Name
TR	Transformer
TH11, 12, 15, 16	Thermister sensor
LEV1, 3	Expansion valve
PS1, 3	Pressure sensor
CONT.B	Circuit BC controller board
TB01	Terminal block (for power source)
TB02	Terminal block (for Transmission)
SV1-4A, B, C	Solenoid valve
SVM1	Solenoid valve
T1-4	Terminal
F01	Fuse AC250V 6.3A F

Note: 1. TB02 is transmission terminal block.
Never connect power line to it.
2. The initial set values of switch on CONT.B are as follows.
SW1:0
SW2:0

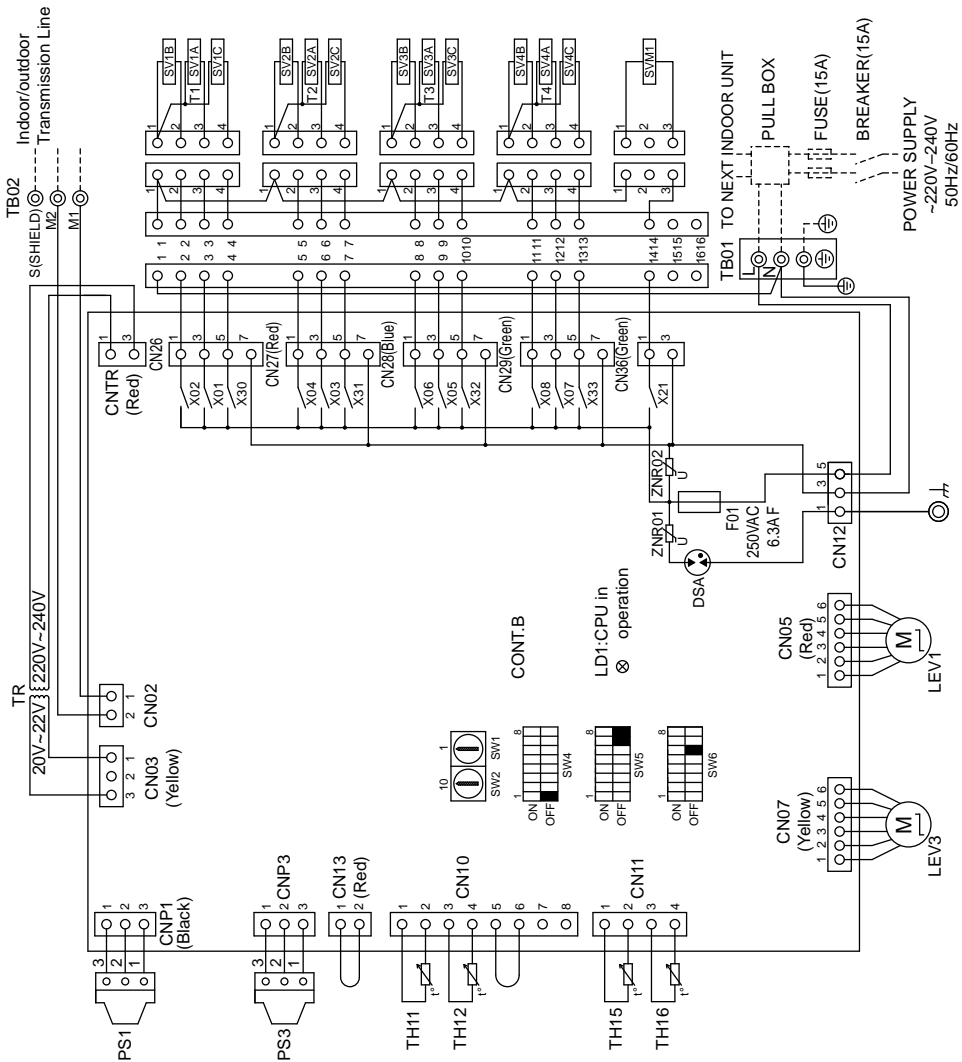

BC

CMB-P105,106V-G1

Symbol	Name
TR	Transformer
TH11,12,15,16	Thermister sensor
LEV1,3	Expansion valve
PS1,3	Pressure sensor
CONT.B	Circuit board
TB01	BC controller terminal block (for power source)
TB02	Terminal block (for Transmission)
SV1-6A,B,C	Solenoid valve
SVM1	Solenoid valve
T1-6	Terminal
F01	Fuse AC250V 6.3A F

Note: 1. TB02 is transmission terminal block.
Never connect power line to it.
2. The initial set values of switch on CONT.B are as follows.
SW1:0
SW2:0

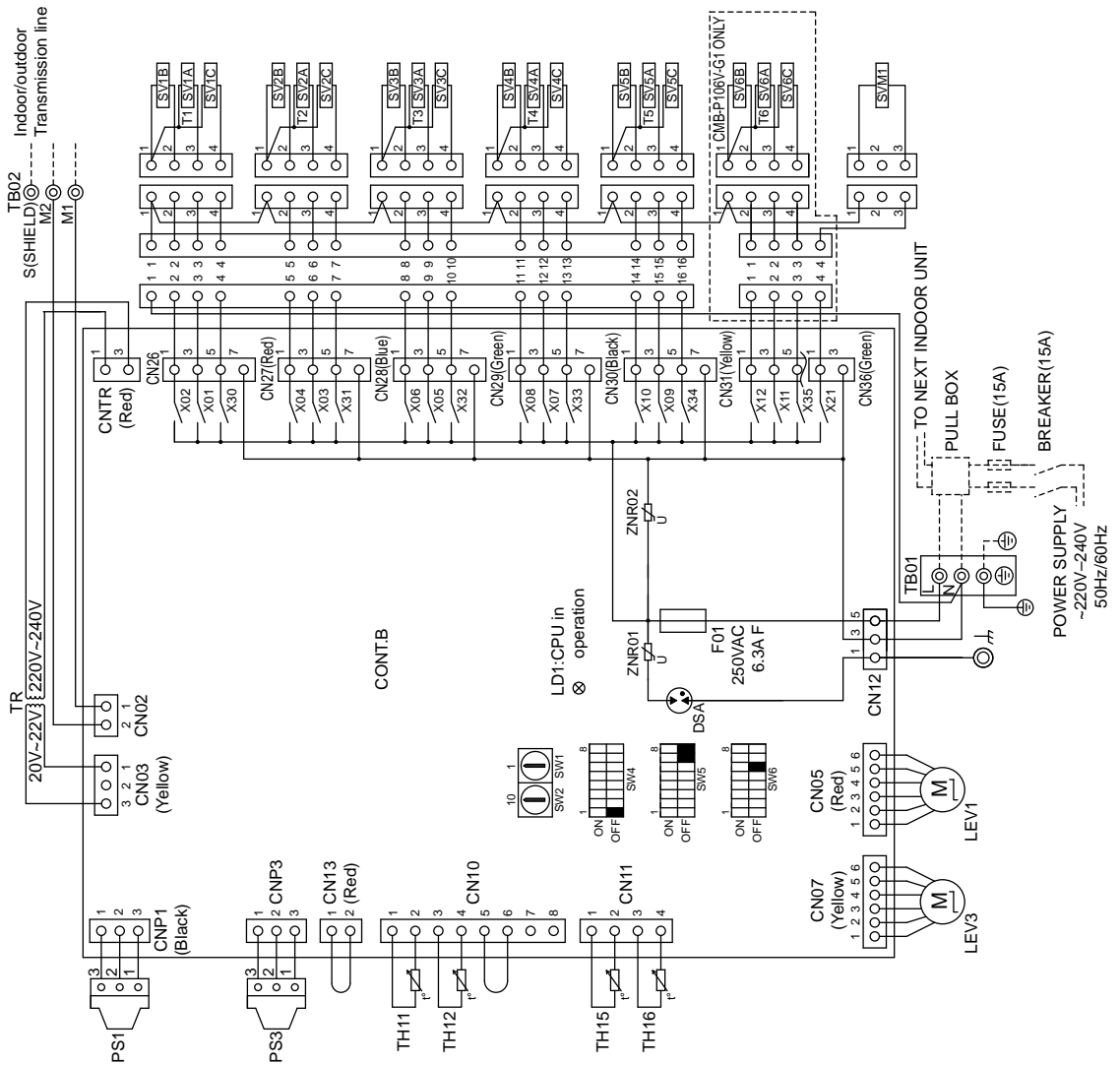

BC

CMB-P108,1010V-G1

Symbol	Name
TR	Transformer
TH11, 12, 15, 16	Thermister sensor
LEV1, 3	Expansion valve
PS1, 3	Pressure sensor
REL.B	Circuit Relay
CONT.B	BC controller board
TB01	Terminal block (for power source)
TB02	Terminal block (for Transmission)
SV1-10A, B, C	Solenoid valve
SVM1	Solenoid valve Terminal
T1-10	Terminal
F01	Fuse AC250V 6.3A F

Note: 1. TB02 is transmission terminal block.
Never connect power line to it.
2. The initial set values of switch on CONT.B are as follows.
SW1: 0
SW2: 0

Indoor/outdoor Transmission line
TB02
S(SHIELD) M2 M1

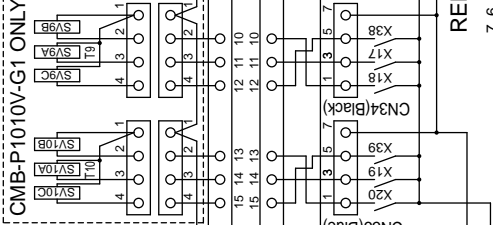
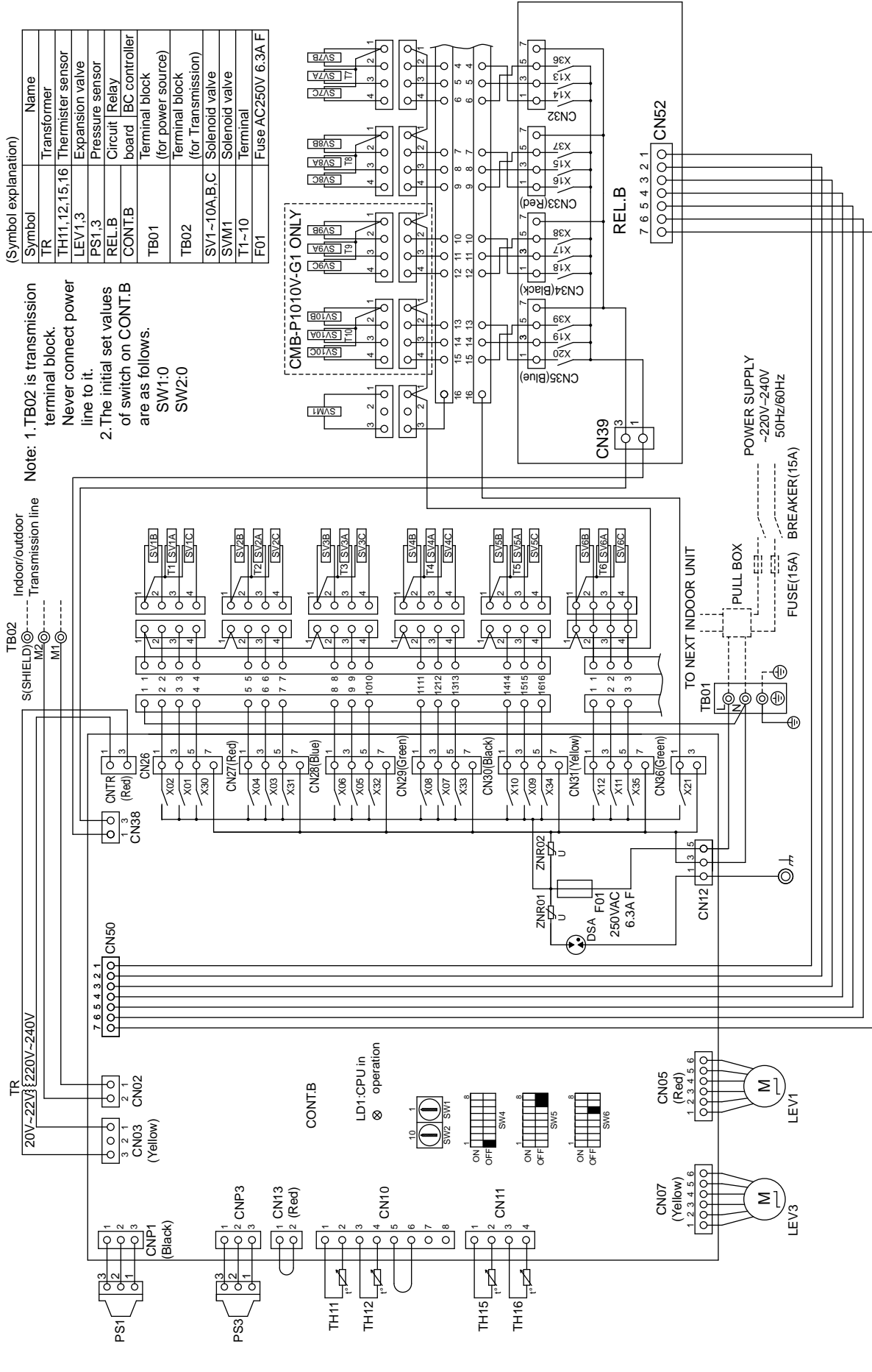

BC

CMB-P1013,1016V-G1

(Symbol explanation)

Symbol	Name
TR	Transformer
TH11,12,15,16	Thermister sensor
LEV1,3	Expansion valve
PS1,3	Pressure sensor
REL.B	Circuit Relay board
CONT.B	BC controller Terminal block
TB01	Terminal block (for power source)
TB02	Terminal block (for Transmission)
SV1~16A,B,C	Solenoid valve
SVM1	Solenoid valve
T1~16	Terminal
F01	Fuse AC250V 6.3A F

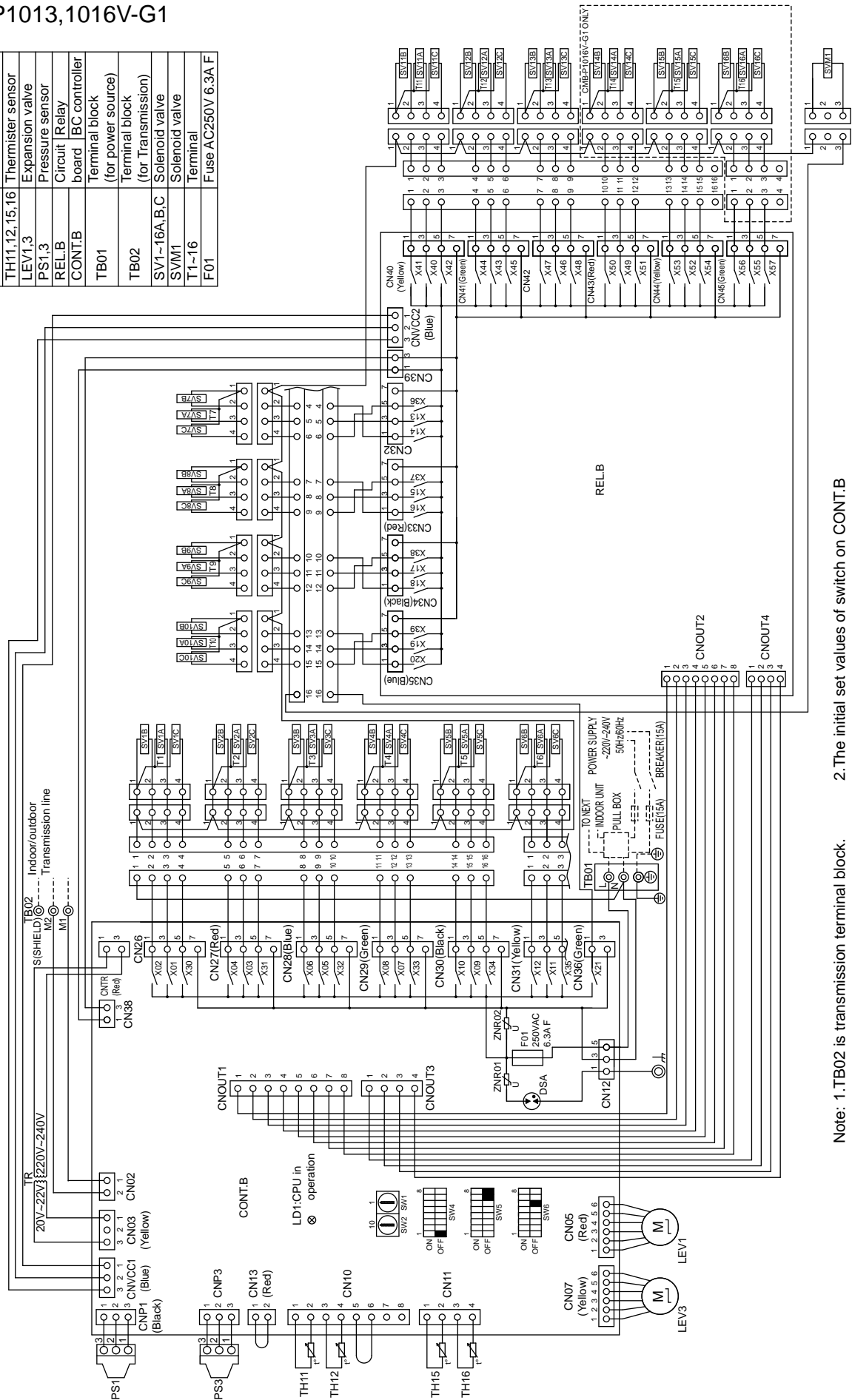

Note: 1. TB02 is transmission terminal block.
Never connect power line to it.

2. The initial set values of switch on CONT.B are as follows.
SW1:0
SW2:0

BC

CMB-P108,1010V-GA1

Symbol	Name
TR	Transformer
TH11, 12, 15, 16	Thermister sensor
LEV1, 3	Expansion valve
PS1, 3	Pressure sensor
REL.B	Circuit Relay
CONT.B	BC controller board
TB01	Terminal block (for power source)
TB02	Terminal block (for Transmission)
SV1-10A,B,C	Solenoid valve
SVM1,2	Solenoid valve
T1-10	Terminal
F01	Fuse AC250V 6.3A F

Note: 1. TB02 is transmission terminal block.
Never connect power line to it.
2. The initial set values of switch on CONT.B are as follows.
SW1:0
SW2:0

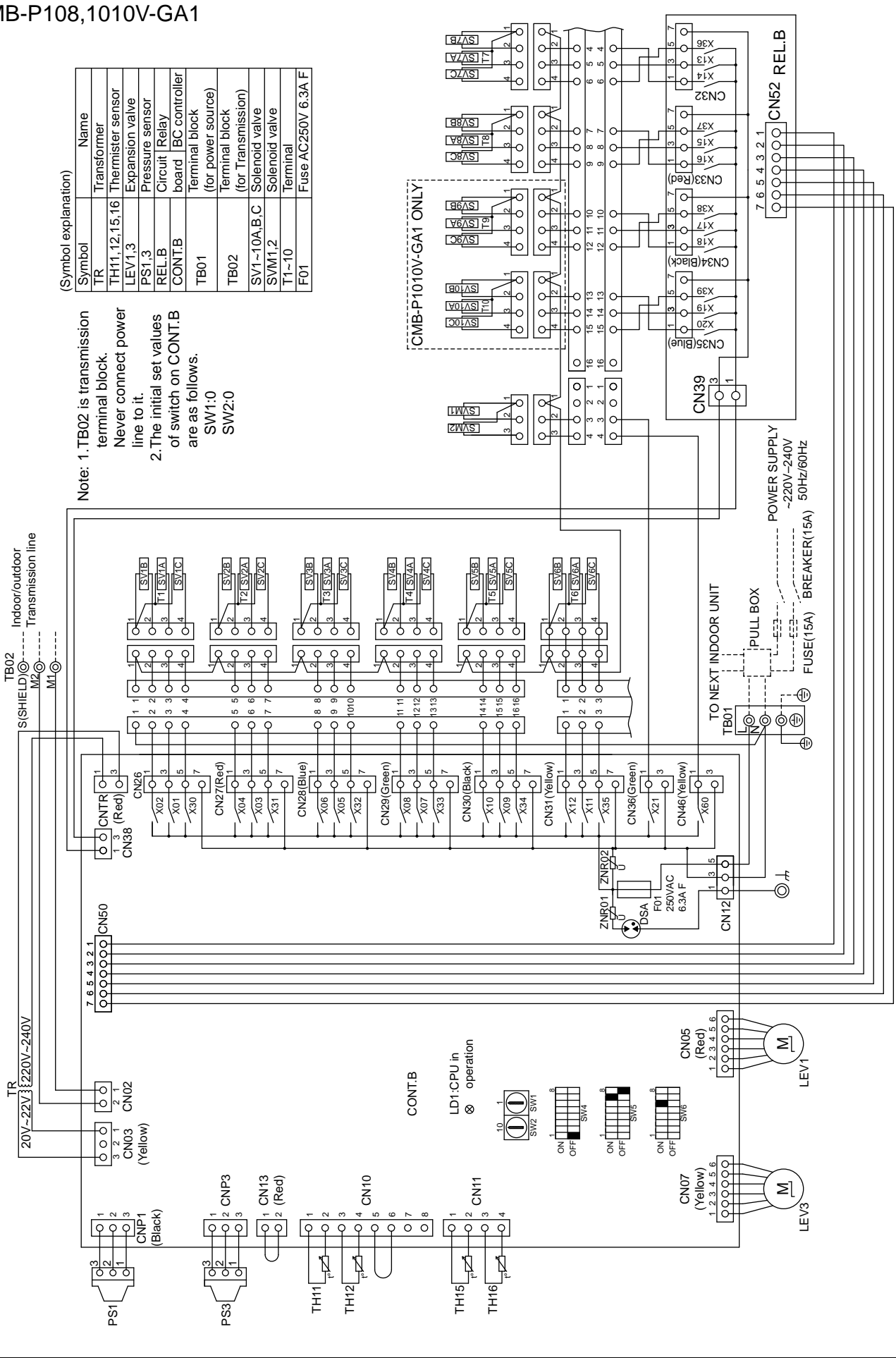

BC

CMB-P1013,1016V-GA1

(Symbol explanation)

Symbol	Name
TR	Transformer
TH11,12,15,16	Thermister sensor
LEV1,3	Expansion valve
PS1,3	Pressure sensor
RELB	Circuit Relay
CONT.B	board IC controller
TB01	Terminal block (for power source)
TB02	Terminal block (for Transmission)
SV1~16A,B,C	Solenoid valve
SVM1,2	Solenoid valve
T1~16	Terminal
F01	Fuse AC250V 6.3A F

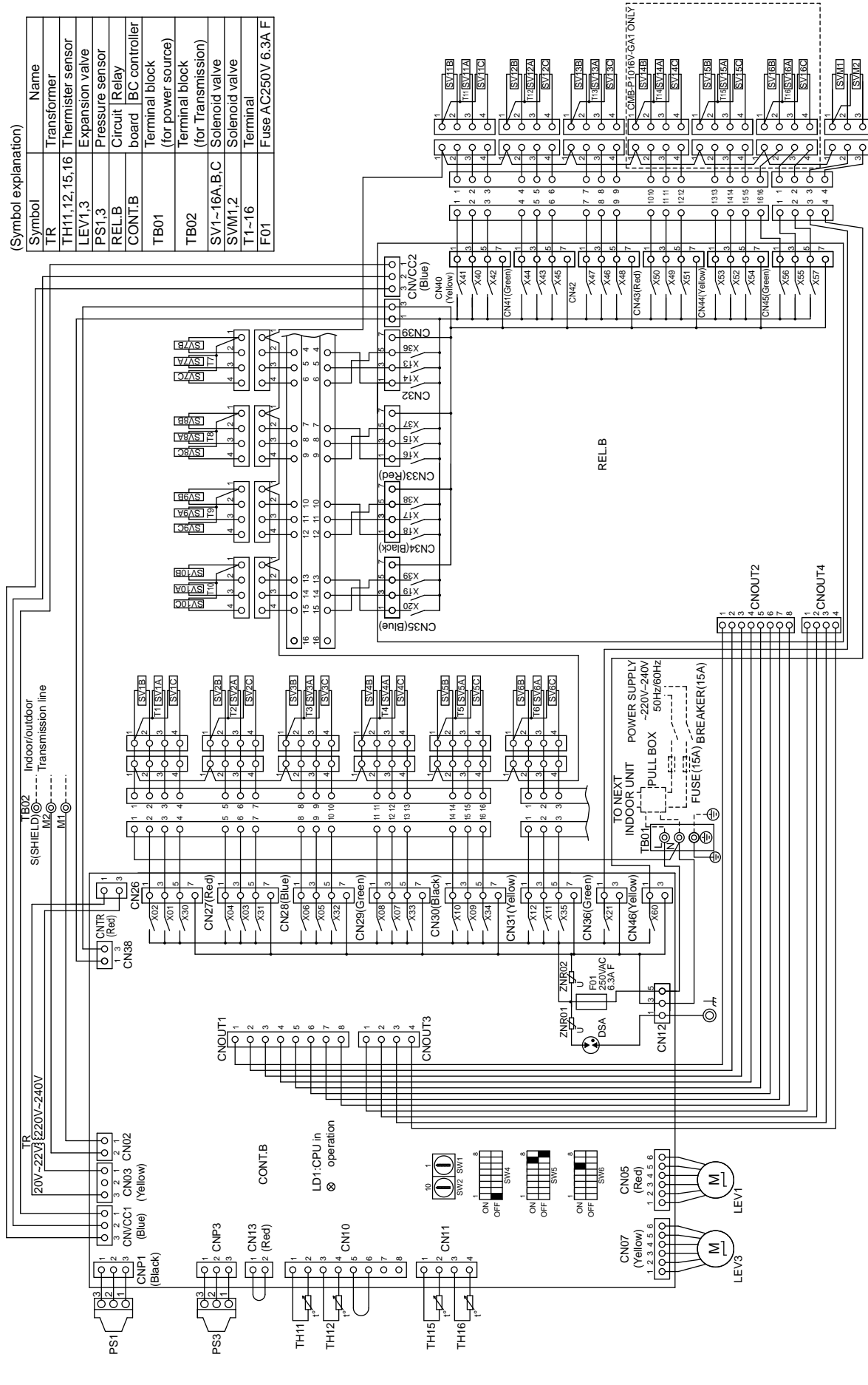

Note: 1. TB02 is transmission terminal block.
Never connect power line to it.

2. The initial set values of switch on CONT.B are as follows.
SW1:0
SW2:0

CMB-P1016V-HA1

Symbol	Name
TR	Transformer
TH1,12,15,16	Thermister sensor
LEV1,3	Expansion valve
PS1,3	Pressure sensor
REL.B	Circuit Relay board
CONTB	IBC controller terminal block
TB01	Terminal block (for power source)
TB02	Terminal block (for Transmission)
SV1~16A,B,C	Solenoid valve
SVM1,2,1b,2b	Solenoid valve
T1~16	Terminal
F01	Fuse AC250V 6.3A F

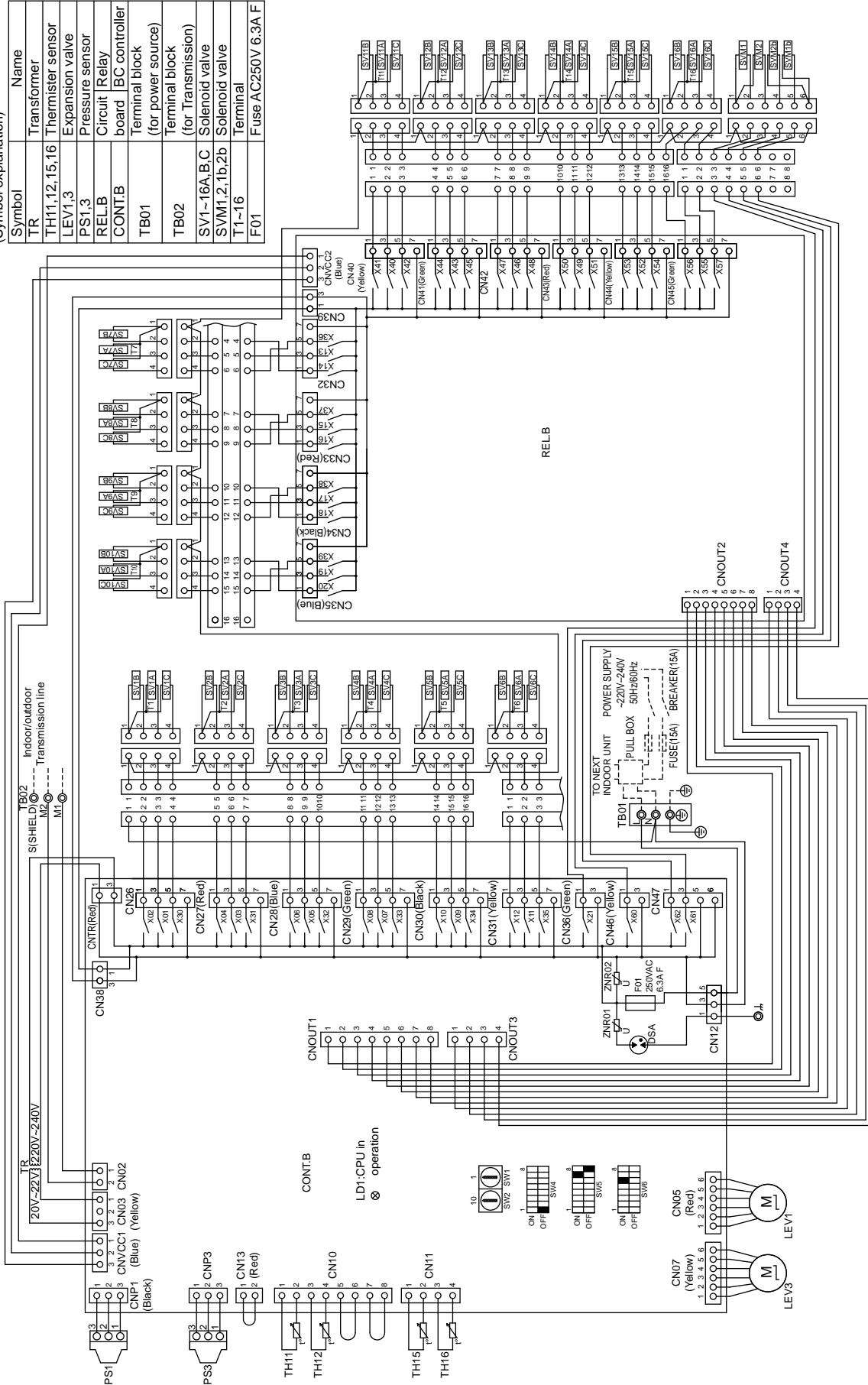

Note: 1. TB02 is transmission terminal block. Never connect power line to it.
 2. The initial set values of switch on CONT.B are as follows.
 SW1:0
 SW2:0

CMB-P104V-GB1

Symbol	Name
TR	Transformer
TH12.15	Thermister sensor
LEV3	Expansion valve
CONT.B	Circuit BC controller board
TB01	Terminal block (for power source)
TB02	Terminal block (for Transmission)
SV1-4A,B,C	Solenoid valve
T1-4	Terminal
F01	Fuse AC250V 6.3A F

Note: 1. TB02 is transmission terminal block.
 Never connect power line to it.
 2. The initial set values of switch on CONT.B are as follows.
 SW1:0
 SW2:0

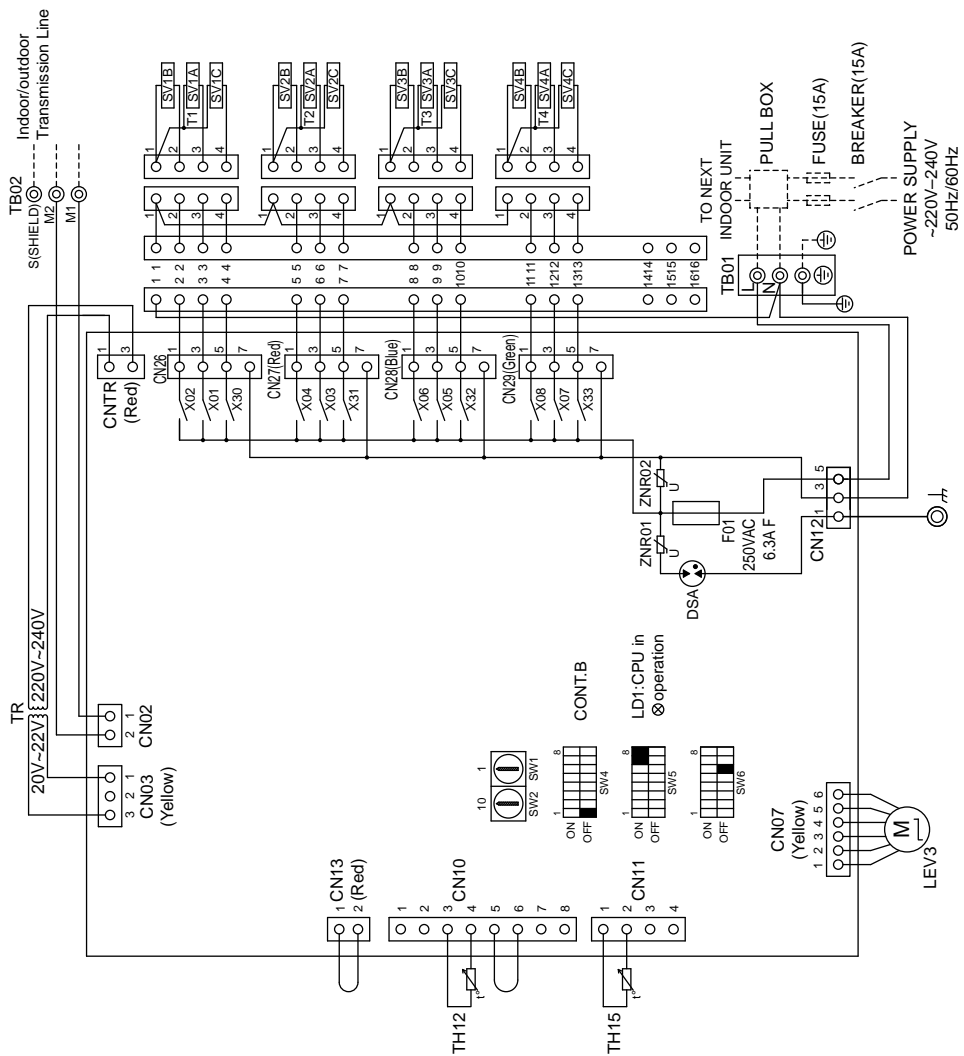

BC

CMB-P108V-GB1

(Symbol explanation)

Symbol	Name
TR	Transformer
TH12,15	Thermister sensor
LEV3	Expansion valve
REL.B	Circuit Relay
CONT.B	BC controller board
TB01	Terminal block (for power source)
TB02	Terminal block (for Transmission)
SV1-8A,B,C	Solenoid valve
T1-8	Terminal
F01	Fuse AC250V 6.3A F

Note: 1. TB02 is transmission terminal block.
Never connect power line to it.
2. The initial set values of switch on CONT.B are as follows.
SW1:0
SW2:0

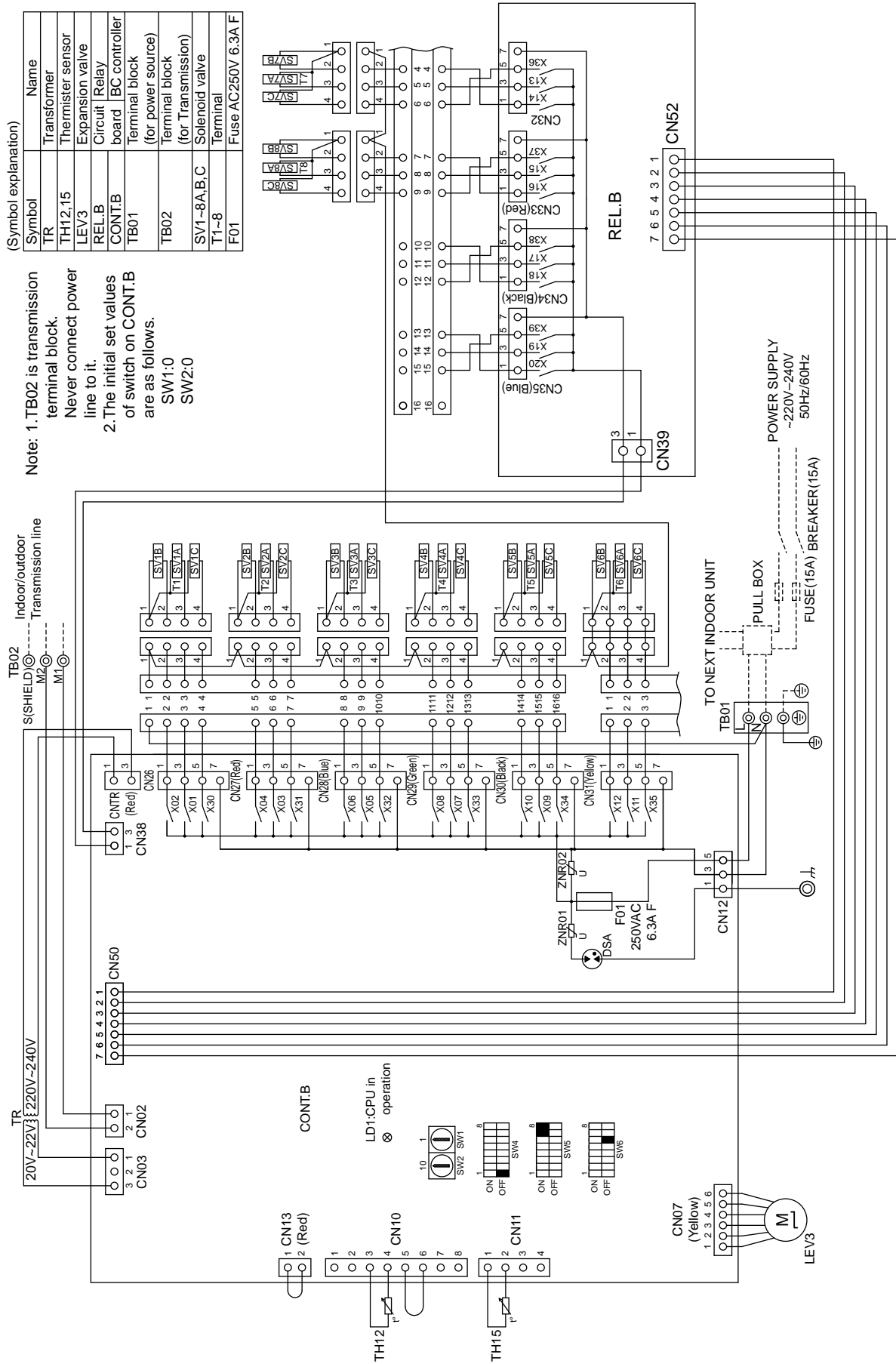

BC

CMB-P1016V-HB1

(Symbol explanation)

Symbol	Name
TR	Transformer
TH12,15	Thermister sensor
LEV3	Expansion valve
REL.B	Circuit Relay
CONT.B	board BC controller
TB01	Terminal block (for power source)
TB02	Terminal block (for Transmission)
SV1~16A,B,C	Solenoid valve
T1~16	Terminal
F01	Fuse AC250V 6.3A F

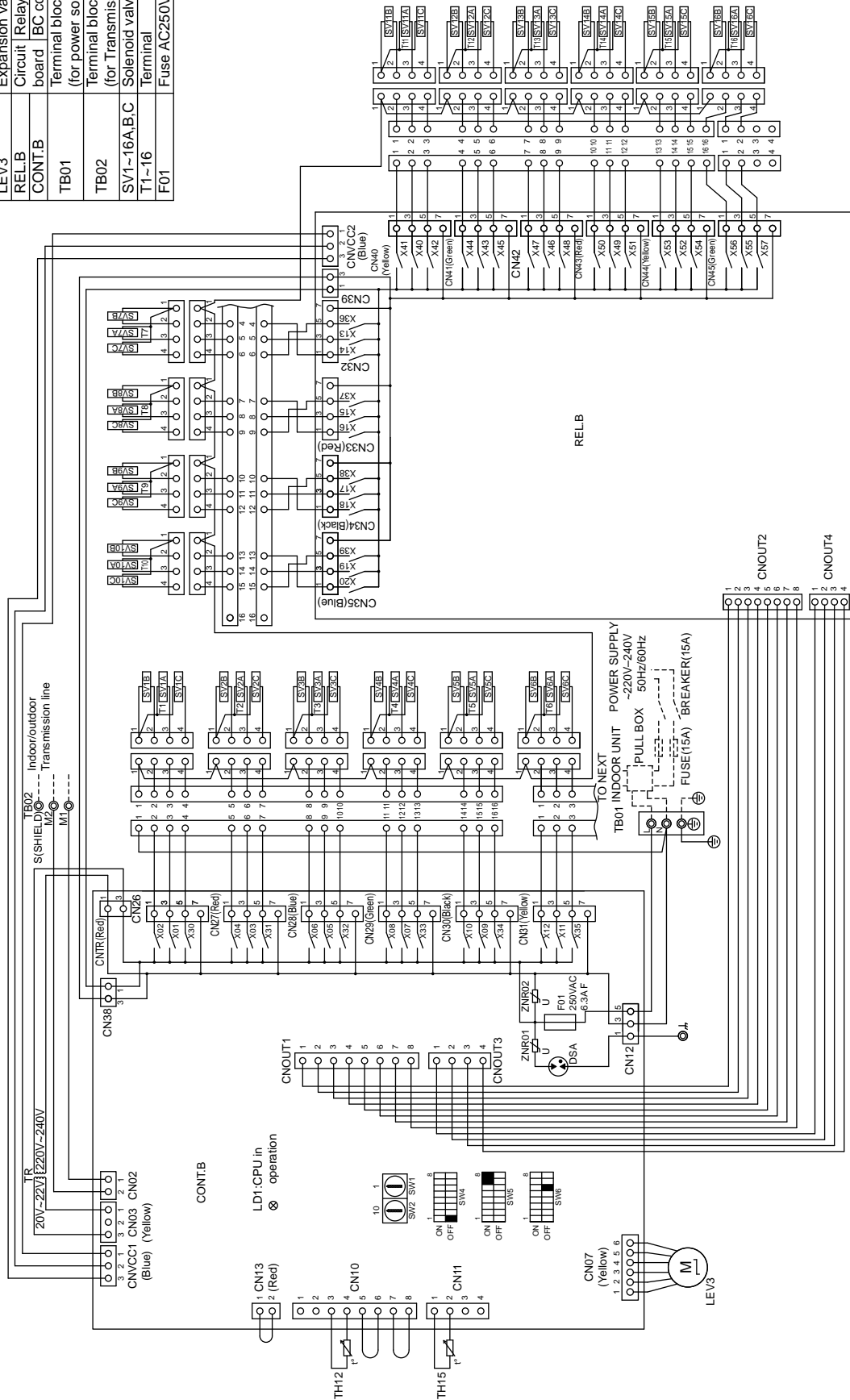

- Note: 1. TB02 is transmission terminal block. Never connect power line to it.
2. The initial set values of switch on CONT.B are as follows.
 SW1:0
 SW2:0

Capacity Table

1. Cooling [Ceiling concealed (Silent/Slim/High static pressure type)]	1 - 254
1-1. Cooling capacity with PUHY-P200-250YKB-A1, EP200-250YLM-A	1 - 254
1-2. Cooling capacity with PUHY-P300-400YKB-A1, EP300-350YLM-A	1 - 254
1-3. Cooling capacity with PUHY-P450-500YKB-A1, EP400-500YLM-A	1 - 255
1-4. Cooling capacity with PUHY-P400-650YSKB-A1, EP550-650YSLM-A	1 - 256
1-5. Cooling capacity with PUHY-P700-800YSKB-A1, EP700-800YSLM-A	1 - 257
1-6. Cooling capacity with PUHY-P850-1350YSKB-A1, EP850-1350YSLM-A	1 - 258
1-7. Cooling capacity with PURY-(E)P200-250YLM-A(1)	1 - 258
1-8. Cooling capacity with PURY-(E)P300-400Y(S)LM-A(1)	1 - 259
1-9. Cooling capacity with PURY-(E)P450-650Y(S)LM-A(1)	1 - 260
1-10. Cooling capacity with PURY-(E)P700-800YSLM-A(1)	1 - 261
1-11. Cooling capacity with PURY-(E)P850-900YSLM-A(1)	1 - 262
2. Cooling [Ceiling concealed (Middle static pressure type)]	1 - 263
2-1. Cooling capacity with PUHY-P200-250YKB-A1, EP200-250YLM-A	1 - 263
2-2. Cooling capacity with PUHY-P300-400YKB-A1, EP300-350YLM-A	1 - 263
2-3. Cooling capacity with PUHY-P450-500YKB-A1, EP400-500YLM-A	1 - 264
2-4. Cooling capacity with PUHY-P400-650YSKB-A1, EP550-650YSLM-A	1 - 264
2-5. Cooling capacity with PUHY-P700-800YSKB-A1, EP700-800YSLM-A	1 - 265
2-6. Cooling capacity with PUHY-P850-1350YSKB-A1, EP850-1350YSLM-A	1 - 265
2-7. Cooling capacity with PURY-(E)P200-250YLM-A(1)	1 - 266
2-8. Cooling capacity with PURY-(E)P300-400Y(S)LM-A(1)	1 - 266
2-9. Cooling capacity with PURY-(E)P450-650Y(S)LM-A(1)	1 - 267
2-10. Cooling capacity with PURY-(E)P700-800YSLM-A(1)	1 - 267
2-11. Cooling capacity with PURY-(E)P850-900YSLM-A(1)	1 - 268
3. Cooling [Ceiling cassette (1-way flow type)]	1 - 269
3-1. Cooling capacity with PUHY-P200-250YKB-A1, EP200-250YLM-A	1 - 269
3-2. Cooling capacity with PUHY-P300-400YKB-A1, EP300-350YLM-A	1 - 269
3-3. Cooling capacity with PUHY-P450-500YKB-A1, EP400-500YLM-A	1 - 269
3-4. Cooling capacity with PUHY-P400-650YSKB-A1, EP550-650YSLM-A	1 - 269
3-5. Cooling capacity with PUHY-P700-800YSKB-A1, EP700-800YSLM-A	1 - 269
3-6. Cooling capacity with PUHY-PUHY-P850-1350YSKB-A1, EP850-1350YSLM-A	1 - 270
3-7. Cooling capacity with PURY-(E)P200-250YLM-A(1)	1 - 270
3-8. Cooling capacity with PURY-(E)P300-400Y(S)LM-A(1)	1 - 270
3-9. Cooling capacity with PURY-(E)P450-650Y(S)LM-A(1)	1 - 270
3-10. Cooling capacity with PURY-(E)P700-800YSLM-A(1)	1 - 270
3-11. Cooling capacity with PURY-(E)P850-900YSLM-A(1)	1 - 271
4. Cooling [Ceiling cassette (2-way flow type)]	1 - 272
4-1. Cooling capacity with PUHY-P200-250YKB-A1, EP200-250YLM-A	1 - 272
4-2. Cooling capacity with PUHY-P300-400YKB-A1, EP300-350YLM-A	1 - 272
4-3. Cooling capacity with PUHY-P450-500YKB-A1, EP400-500YLM-A	1 - 272
4-4. Cooling capacity with PUHY-P400-650YSKB-A1, EP550-650YSLM-A	1 - 272
4-5. Cooling capacity with PUHY-P700-800YSKB-A1, EP700-800YSLM-A	1 - 273
4-6. Cooling capacity with PUHY-P850-1350YSKB-A1, PUHY-EP850-1350YSLM-A	1 - 273
4-7. Cooling capacity with PURY-(E)P200-250YLM-A(1)	1 - 273
4-8. Cooling capacity with PURY-(E)P300-400Y(S)LM-A(1)	1 - 273
4-9. Cooling capacity with PURY-(E)P450-650Y(S)LM-A(1)	1 - 274
4-10. Cooling capacity with PURY-EP700-800YSLM-A(1)	1 - 274
4-11. Cooling capacity with PURY-(E)P850-900YSLM-A(1)	1 - 274

5. Cooling [Ceiling cassette (4-way flow type)]	1 - 275
5-1. Cooling capacity with PUHY-P200-250YKB-A1, EP200-250YLM-A	1 - 275
5-2. Cooling capacity with PUHY-P300-400YKB-A1, EP300-350YLM-A	1 - 275
5-3. Cooling capacity with PUHY-P450-500YKB-A1, EP400-500YLM-A	1 - 276
5-4. Cooling capacity with PUHY-P400-650YSKB-A1, EP550-650YSLM-A	1 - 276
5-5. Cooling capacity with PUHY-P700-800YSKB-A1, EP700-800YSLM-A	1 - 277
5-6. Cooling capacity with PUHY-P850-1350YSKB-A1, EP850-1350YSLM-A	1 - 277
5-7. Cooling capacity with PURY-(E)P200-250YLM-A(1)	1 - 277
5-8. Cooling capacity with PURY-(E)P300-400Y(S)LM-A(1)	1 - 278
5-9. Cooling capacity with PURY-(E)P450-650Y(S)LM-A(1)	1 - 278
5-10. Cooling capacity with PURY-(E)P700-800YSLM-A(1)	1 - 279
5-11. Cooling capacity with PURY-(E)P850-900YSLM-A(1)	1 - 279
6. Cooling [Ceiling suspended]	1 - 281
6-1. Cooling capacity with PUHY-P200-250YKB-A1, EP200-250YLM-A	1 - 281
6-2. Cooling capacity with PUHY-P300-400YKB-A1, EP300-350YLM-A	1 - 281
6-3. Cooling capacity with PUHY-P450-500YKB-A1, EP400-500YLM-A	1 - 281
6-4. Cooling capacity with PUHY-P400-650YSKB-A1, EP550-650YSLM-A	1 - 281
6-5. Cooling capacity with PUHY-P700-800YSKB-A1, EP700-800YSLM-A	1 - 281
6-6. Cooling capacity with PUHY-P850-1350YSKB-A1, EP850-1350YSLM-A	1 - 282
6-7. Cooling capacity with PURY-(E)P200-250YLM-A(1)	1 - 282
6-8. Cooling capacity with PURY-(E)P300-400Y(S)LM-A(1)	1 - 282
6-9. Cooling capacity with PURY-(E)P450-650Y(S)LM-A(1)	1 - 282
6-10. Cooling capacity with PURY-(E)P700-800YSLM-A(1)	1 - 282
6-11. Cooling capacity with PURY-(E)P850-900YSLM-A(1)	1 - 283
7. Cooling [Wall mounted]	1 - 284
7-1. Cooling capacity with PUHY-P200-250YKB-A1, EP200-250YLM-A	1 - 284
7-2. Cooling capacity with PUHY-P300-400YKB-A1, EP300-350YLM-A	1 - 284
7-3. Cooling capacity with PUHY-P450-500YKB-A1, EP400-500YLM-A	1 - 284
7-4. Cooling capacity with PUHY-P400-650YSKB-A1, EP550-650YSLM-A	1 - 284
7-5. Cooling capacity with PUHY-P700-800YSKB-A1, EP700-800YSLM-A	1 - 285
7-6. Cooling capacity with PUHY-P850-1350YSKB-A1, EP850-1350YSLM-A	1 - 285
7-7. Cooling capacity with PURY-(E)P200-250YLM-A(1)	1 - 285
7-8. Cooling capacity with PURY-(E)P300-400Y(S)LM-A(1)	1 - 285
7-9. Cooling capacity with PURY-(E)P450-650Y(S)LM-A(1)	1 - 286
7-10. Cooling capacity with PURY-(E)P700-800YSLM-A(1)	1 - 286
7-11. Cooling capacity with PURY-(E)P850-900YSLM-A(1)	1 - 286
8. Cooling [Floor standing (Exposed 2-way/Exposed/Concealed type)]	1 - 287
8-1. Cooling capacity with PUHY-P200-250YKB-A1, EP200-250YLM-A	1 - 287
8-2. Cooling capacity with PUHY-P300-400YKB-A1, EP300-350YLM-A	1 - 287
8-3. Cooling capacity with PUHY-P450-500YKB-A1, EP400-500YLM-A	1 - 288
8-4. Cooling capacity with PUHY-P400-650YSKB-A1, EP550-650YSLM-A	1 - 288
8-5. Cooling capacity with PUHY-P700-800YSKB-A1, EP700-800YSLM-A	1 - 289
8-6. Cooling capacity with PUHY-P850-1350YSKB-A1, EP850-1350YSLM-A	1 - 290
8-7. Cooling capacity with PURY-(E)P200-250YLM-A(1)	1 - 290
8-8. Cooling capacity with PURY-(E)P300-400Y(S)LM-A(1)	1 - 291
8-9. Cooling capacity with PURY-(E)P450-650Y(S)LM-A(1)	1 - 291
8-10. Cooling capacity with PURY-(E)P700-800YSLM-A(1)	1 - 292
8-11. Cooling capacity with PURY-(E)P850-900YSLM-A(1)	1 - 293

9. Heating [All indoor units].....	1 - 294
9-1. Heating capacity with PUHY-P200-250YKB-A1, EP200-250YLM-A	1 - 294
9-2. Heating capacity with PUHY-P300-400YKB-A1, EP300-350YLM-A	1 - 294
9-3. Heating capacity with PUHY-P450-500YKB-A1, P400-650YSKB-A1, EP400-650Y(S)LM-A.....	1 - 294
9-4. Heating capacity with PUHY-P700-800YSKB-A1, EP700-800YSLM-A	1 - 295
9-5. Heating capacity with PUHY-P850-1350YSKB-A1, EP850-1350YSLM-A	1 - 295
9-6. Heating capacity with PURY-(E)P200-250YLM-A(1).....	1 - 295
9-7. Heating capacity with PURY-(E)P300-400Y(S)LM-A(1)	1 - 296
9-8. Heating capacity with PURY-(E)P450-650Y(S)LM-A(1)	1 - 296
9-9. Heating capacity with PURY-(E)P700-800YSLM-A(1)	1 - 296
9-10. Heating capacity with PURY-(E)P850-900YSLM-A(1)	1 - 297
9-11. Heating capacity with PUHY-P200-250YKB-A1, EP200-250YLM-A "COP priority mode"	1 - 297
9-12. Heating capacity with PUHY-P300-400YKB-A1, EP300-350YLM-A "COP priority mode"	1 - 297
9-13. Heating capacity with PUHY-P450-500YKB-A1, EP400-500YLM-A "COP priority mode"	1 - 298
9-14. Heating capacity with PUHY-P400-650YSKB-A1, EP550-650YSLM-A "COP priority mode"	1 - 298
9-15. Heating capacity with PUHY-P700-800YSKB-A1, EP700-800YSLM-A "COP priority mode"	1 - 298
9-16. Heating capacity with PUHY-P850-1350YSKB-A1, EP850-1350YSLM-A "COP priority mode"	1 - 299
9-17. Heating capacity with PURY-(E)P200-250YLM-A(1) "COP priority mode"	1 - 299
9-18. Heating capacity with PURY-(E)P300-400Y(S)LM-A(1) "COP priority mode"	1 - 299
9-19. Heating capacity with PURY-(E)P450-650Y(S)LM-A(1) "COP priority mode"	1 - 300
9-20. Heating capacity with PURY-(E)P700-800YSLM-A(1) "COP priority mode"	1 - 300
9-21. Heating capacity with PURY-(E)P850-900YSLM-A(1) "COP priority mode"	1 - 300

1. Cooling [Ceiling concealed (Silent/Slim/High static pressure type)]

YKB/YLM

CT

1-1. Cooling capacity with PUHY-P200-250YKB-A1, EP200-250YLM-A

PEFY-P-VMR-E-L/R

CA: Capacity (kW), SHC: Sensible Heat Capacity (kW)

Model size (Rated kW)	Indoor air temp.													
	21.5°C D.B. 15°C W.B.		23°C D.B. 16°C W.B.		25°C D.B. 18°C W.B.		27°C D.B. 19°C W.B.		28°C D.B. 20°C W.B.		30°C D.B. 22°C W.B.		32°C D.B. 24°C W.B.	
	CA	SHC	CA	SHC	CA	SHC	CA	SHC	CA	SHC	CA	SHC	CA	SHC
20 (2.2)	2.0	1.7	2.0	1.7	2.2	1.7	2.2	1.8	2.3	1.8	2.4	1.8	2.6	1.8
25 (2.8)	2.5	1.9	2.6	2.0	2.8	2.0	2.8	2.1	2.9	2.1	3.1	2.0	3.2	2.0
32 (3.6)	3.2	2.3	3.3	2.4	3.5	2.4	3.6	2.5	3.7	2.5	3.9	2.4	4.2	2.4

* The capacity does not depend on the outdoor temperature.

kcal/h = kW x 860, BTU/h = kW x 3,412

PEFY-P-VMS1(L)-E

CA: Capacity (kW), SHC: Sensible Heat Capacity (kW)

Model size (Rated kW)	Indoor air temp.													
	21.5°C D.B. 15°C W.B.		23°C D.B. 16°C W.B.		25°C D.B. 18°C W.B.		27°C D.B. 19°C W.B.		28°C D.B. 20°C W.B.		30°C D.B. 22°C W.B.		32°C D.B. 24°C W.B.	
	CA	SHC	CA	SHC	CA	SHC	CA	SHC	CA	SHC	CA	SHC	CA	SHC
15 (1.7)	1.5	1.4	1.6	1.5	1.7	1.5	1.7	1.6	1.8	1.6	1.9	1.6	2.0	1.5
20 (2.2)	2.0	1.7	2.0	1.8	2.2	1.8	2.2	1.9	2.3	1.9	2.4	1.9	2.6	1.8
25 (2.8)	2.5	2.1	2.6	2.1	2.8	2.1	2.8	2.2	2.9	2.2	3.1	2.2	3.2	2.2
32 (3.6)	3.2	2.5	3.3	2.6	3.5	2.5	3.6	2.7	3.7	2.7	3.9	2.6	4.2	2.6
40 (4.5)	4.1	3.0	4.2	3.1	4.4	3.1	4.5	3.2	4.7	3.2	4.9	3.2	5.2	3.1
50 (5.6)	5.0	3.7	5.2	3.8	5.5	3.8	5.6	4.0	5.8	4.0	6.1	3.9	6.5	3.8
63 (7.1)	6.4	4.7	6.6	4.8	7.0	4.8	7.1	5.0	7.4	5.0	7.8	4.9	8.2	4.8

* The capacity does not depend on the outdoor temperature.

kcal/h = kW x 860, BTU/h = kW x 3,412

PEFY-P-VMH-E

CA: Capacity (kW), SHC: Sensible Heat Capacity (kW)

Model size (Rated kW)	Indoor air temp.													
	21.5°C D.B. 15°C W.B.		23°C D.B. 16°C W.B.		25°C D.B. 18°C W.B.		27°C D.B. 19°C W.B.		28°C D.B. 20°C W.B.		30°C D.B. 22°C W.B.		32°C D.B. 24°C W.B.	
	CA	SHC	CA	SHC	CA	SHC	CA	SHC	CA	SHC	CA	SHC	CA	SHC
40 (4.5)	4.1	3.1	4.2	3.2	4.4	3.2	4.5	3.4	4.7	3.4	4.9	3.3	5.2	3.3
50 (5.6)	5.0	3.7	5.2	3.8	5.5	3.7	5.6	3.9	5.8	3.9	6.1	3.8	6.5	3.8
63 (7.1)	6.4	4.8	6.6	5.0	7.0	4.9	7.1	5.2	7.4	5.2	7.8	5.1	8.2	5.0
71 (8.0)	7.2	5.4	7.4	5.6	7.9	5.5	8.0	5.8	8.3	5.8	8.7	5.7	9.3	5.6
80 (9.0)	8.1	6.1	8.4	6.3	8.9	6.2	9.0	6.5	9.3	6.5	9.8	6.4	10.4	6.3
100 (11.2)	10.1	8.3	10.4	8.5	11.0	8.4	11.2	9.0	11.6	8.9	12.2	8.8	13.0	8.7
125 (14.0)	12.6	9.5	13.0	9.8	13.8	9.7	14.0	10.1	14.5	10.1	15.3	10.0	16.2	9.8
140 (16.0)	14.4	10.8	14.9	11.2	15.7	11.0	16.0	11.6	16.6	11.6	17.5	11.4	18.6	11.2
200 (22.4)	20.2	15.6	20.8	16.0	22.0	15.8	22.4	16.7	23.3	16.7	24.5	16.4	26.0	16.2
250 (28.0)	25.2	19.3	26.0	19.9	27.5	19.7	28.0	20.7	29.1	20.7	30.6	20.4	32.5	20.1

* The capacity does not depend on the outdoor temperature.

kcal/h = kW x 860, BTU/h = kW x 3,412

PEFY-P-VMHS-E

CA: Capacity (kW), SHC: Sensible Heat Capacity (kW)

Model size (Rated kW)	Indoor air temp.													
	21.5°C D.B. 15°C W.B.		23°C D.B. 16°C W.B.		25°C D.B. 18°C W.B.		27°C D.B. 19°C W.B.		28°C D.B. 20°C W.B.		30°C D.B. 22°C W.B.		32°C D.B. 24°C W.B.	
	CA	SHC	CA	SHC	CA	SHC	CA	SHC	CA	SHC	CA	SHC	CA	SHC
200 (22.4)	20.2	16.8	20.8	17.4	22.0	17.2	22.4	18.3	23.3	18.3	24.5	18.0	26.0	17.8
250 (28.0)	25.2	20.5	26.0	21.2	27.5	21.0	28.0	22.3	29.1	22.2	30.6	21.8	32.5	21.6

* The capacity does not depend on the outdoor temperature.

kcal/h = kW x 860, BTU/h = kW x 3,412

1-2. Cooling capacity with PUHY-P300-400YKB-A1, EP300-350YLM-A

PEFY-P-VMR-E-L/R

CA: Capacity (kW), SHC: Sensible Heat Capacity (kW)

Model size (Rated kW)	Indoor air temp.													
	21.5°C D.B. 15°C W.B.		23°C D.B. 16°C W.B.		25°C D.B. 18°C W.B.		27°C D.B. 19°C W.B.		28°C D.B. 20°C W.B.		30°C D.B. 22°C W.B.		32°C D.B. 24°C W.B.	
	CA	SHC	CA	SHC	CA	SHC	CA	SHC	CA	SHC	CA	SHC	CA	SHC
20 (2.2)	2.0	1.7	2.0	1.7	2.2	1.7	2.2	1.8	2.3	1.8	2.4	1.8	2.6	1.8
25 (2.8)	2.5	1.9	2.6	2.0	2.8	2.0	2.8	2.1	2.9	2.1	3.1	2.0	3.2	2.0
32 (3.6)	3.2	2.3	3.3	2.4	3.5	2.4	3.6	2.5	3.7	2.5	3.9	2.4	4.2	2.4

* The capacity does not depend on the outdoor temperature.

kcal/h = kW x 860, BTU/h = kW x 3,412

1. Cooling [Ceiling concealed (Silent/Slim/High static pressure type)]

YKB/YLM

CT

PEFY-P-VMS1(L)-E

CA: Capacity (kW), SHC: Sensible Heat Capacity (kW)

Model size (Rated kW)	Indoor air temp.													
	21.5°C D.B. 15°C W.B.		23°C D.B. 16°C W.B.		25°C D.B. 18°C W.B.		27°C D.B. 19°C W.B.		28°C D.B. 20°C W.B.		30°C D.B. 22°C W.B.		32°C D.B. 24°C W.B.	
	CA	SHC	CA	SHC	CA	SHC	CA	SHC	CA	SHC	CA	SHC	CA	SHC
15 (1.7)	1.5	1.4	1.6	1.5	1.7	1.5	1.7	1.6	1.8	1.6	1.9	1.6	2.0	1.5
20 (2.2)	2.0	1.7	2.0	1.8	2.2	1.8	2.2	1.9	2.3	1.9	2.4	1.9	2.6	1.8
25 (2.8)	2.5	2.1	2.6	2.1	2.8	2.1	2.8	2.2	2.9	2.2	3.1	2.2	3.2	2.2
32 (3.6)	3.2	2.5	3.3	2.6	3.5	2.5	3.6	2.7	3.7	2.7	3.9	2.6	4.2	2.6
40 (4.5)	4.1	3.0	4.2	3.1	4.4	3.1	4.5	3.2	4.7	3.2	4.9	3.2	5.2	3.1
50 (5.6)	5.0	3.7	5.2	3.8	5.5	3.8	5.6	4.0	5.8	4.0	6.1	3.9	6.5	3.8
63 (7.1)	6.4	4.7	6.6	4.8	7.0	4.8	7.1	5.0	7.4	5.0	7.8	4.9	8.2	4.8

* The capacity does not depend on the outdoor temperature.

kcal/h = kW x 860, BTU/h = kW x 3,412

PEFY-P-VMH-E

CA: Capacity (kW), SHC: Sensible Heat Capacity (kW)

Model size (Rated kW)	Indoor air temp.													
	21.5°C D.B. 15°C W.B.		23°C D.B. 16°C W.B.		25°C D.B. 18°C W.B.		27°C D.B. 19°C W.B.		28°C D.B. 20°C W.B.		30°C D.B. 22°C W.B.		32°C D.B. 24°C W.B.	
	CA	SHC	CA	SHC	CA	SHC	CA	SHC	CA	SHC	CA	SHC	CA	SHC
40 (4.5)	4.1	3.1	4.2	3.2	4.4	3.2	4.5	3.4	4.7	3.4	4.9	3.3	5.2	3.3
50 (5.6)	5.0	3.7	5.2	3.8	5.5	3.7	5.6	3.9	5.8	3.9	6.1	3.8	6.5	3.8
63 (7.1)	6.4	4.8	6.6	5.0	7.0	4.9	7.1	5.2	7.4	5.2	7.8	5.1	8.2	5.0
71 (8.0)	7.2	5.4	7.4	5.6	7.9	5.5	8.0	5.8	8.3	5.8	8.7	5.7	9.3	5.6
80 (9.0)	8.1	6.1	8.4	6.3	8.9	6.2	9.0	6.5	9.3	6.5	9.8	6.4	10.4	6.3
100 (11.2)	10.1	8.3	10.4	8.5	11.0	8.4	11.2	9.0	11.6	8.9	12.2	8.8	13.0	8.7
125 (14.0)	12.6	9.5	13.0	9.8	13.8	9.7	14.0	10.1	14.5	10.1	15.3	10.0	16.2	9.8
140 (16.0)	14.4	10.8	14.9	11.2	15.7	11.0	16.0	11.6	16.6	11.6	17.5	11.4	18.6	11.2
200 (22.4)	20.2	15.6	20.8	16.0	22.0	15.8	22.4	16.7	23.3	16.7	24.5	16.4	26.0	16.2
250 (28.0)	25.2	19.3	26.0	19.9	27.5	19.7	28.0	20.7	29.1	20.7	30.6	20.4	32.5	20.1

* The capacity does not depend on the outdoor temperature.

kcal/h = kW x 860, BTU/h = kW x 3,412

PEFY-P-VMHS-E

CA: Capacity (kW), SHC: Sensible Heat Capacity (kW)

Model size (Rated kW)	Indoor air temp.													
	21.5°C D.B. 15°C W.B.		23°C D.B. 16°C W.B.		25°C D.B. 18°C W.B.		27°C D.B. 19°C W.B.		28°C D.B. 20°C W.B.		30°C D.B. 22°C W.B.		32°C D.B. 24°C W.B.	
	CA	SHC	CA	SHC	CA	SHC	CA	SHC	CA	SHC	CA	SHC	CA	SHC
200 (22.4)	20.2	16.8	20.8	17.4	22.0	17.2	22.4	18.3	23.3	18.3	24.5	18.0	26.0	17.8
250 (28.0)	25.2	20.5	26.0	21.2	27.5	21.0	28.0	22.3	29.1	22.2	30.6	21.8	32.5	21.6

* The capacity does not depend on the outdoor temperature.

kcal/h = kW x 860, BTU/h = kW x 3,412

1-3. Cooling capacity with PUHY-P450-500YKB-A1, EP400-500YLM-A

PEFY-P-VMR-E-L/R

CA: Capacity (kW), SHC: Sensible Heat Capacity (kW)

Model size (Rated kW)	Indoor air temp.													
	21.5°C D.B. 15°C W.B.		23°C D.B. 16°C W.B.		25°C D.B. 18°C W.B.		27°C D.B. 19°C W.B.		28°C D.B. 20°C W.B.		30°C D.B. 22°C W.B.		32°C D.B. 24°C W.B.	
	CA	SHC	CA	SHC	CA	SHC	CA	SHC	CA	SHC	CA	SHC	CA	SHC
20 (2.2)	2.0	1.7	2.0	1.7	2.2	1.7	2.2	1.8	2.3	1.8	2.4	1.8	2.6	1.8
25 (2.8)	2.5	1.9	2.6	2.0	2.7	1.9	2.8	2.1	2.9	2.1	3.1	2.0	3.3	2.0
32 (3.6)	3.2	2.3	3.3	2.4	3.5	2.4	3.6	2.5	3.8	2.5	4.0	2.5	4.2	2.4

* The capacity does not depend on the outdoor temperature.

kcal/h = kW x 860, BTU/h = kW x 3,412

PEFY-P-VMS1(L)-E

CA: Capacity (kW), SHC: Sensible Heat Capacity (kW)

Model size (Rated kW)	Indoor air temp.													
	21.5°C D.B. 15°C W.B.		23°C D.B. 16°C W.B.		25°C D.B. 18°C W.B.		27°C D.B. 19°C W.B.		28°C D.B. 20°C W.B.		30°C D.B. 22°C W.B.		32°C D.B. 24°C W.B.	
	CA	SHC	CA	SHC	CA	SHC	CA	SHC	CA	SHC	CA	SHC	CA	SHC
15 (1.7)	1.5	1.4	1.6	1.5	1.7	1.5	1.7	1.6	1.8	1.6	1.9	1.6	2.0	1.5
20 (2.2)	2.0	1.7	2.0	1.8	2.2	1.8	2.2	1.9	2.3	1.9	2.4	1.9	2.6	1.9
25 (2.8)	2.5	2.1	2.6	2.1	2.7	2.1	2.8	2.2	2.9	2.3	3.1	2.2	3.3	2.2
32 (3.6)	3.2	2.5	3.3	2.6	3.5	2.5	3.6	2.7	3.8	2.7	4.0	2.7	4.2	2.6
40 (4.5)	4.1	3.0	4.1	3.1	4.4	3.1	4.5	3.2	4.7	3.3	5.0	3.2	5.3	3.2
50 (5.6)	5.0	3.7	5.1	3.8	5.5	3.8	5.6	4.0	5.8	4.0	6.2	3.9	6.6	3.9
63 (7.1)	6.4	4.7	6.5	4.8	6.9	4.8	7.1	5.0	7.4	5.0	7.9	5.0	8.4	4.9

* The capacity does not depend on the outdoor temperature.

kcal/h = kW x 860, BTU/h = kW x 3,412

1. Cooling [Ceiling concealed (Silent/Slim/High static pressure type)]

YKB/YLM

CT

PEFY-P-VMH-E

CA: Capacity (kW), SHC: Sensible Heat Capacity (kW)

Model size (Rated kW)	Indoor air temp.													
	21.5°C D.B. 15°C W.B.		23°C D.B. 16°C W.B.		25°C D.B. 18°C W.B.		27°C D.B. 19°C W.B.		28°C D.B. 20°C W.B.		30°C D.B. 22°C W.B.		32°C D.B. 24°C W.B.	
	CA	SHC	CA	SHC	CA	SHC	CA	SHC	CA	SHC	CA	SHC	CA	SHC
40 (4.5)	4.1	3.1	4.1	3.2	4.4	3.2	4.5	3.4	4.7	3.4	5.0	3.4	5.3	3.3
50 (5.6)	5.0	3.7	5.1	3.7	5.5	3.7	5.6	3.9	5.8	3.9	6.2	3.9	6.6	3.8
63 (7.1)	6.4	4.8	6.5	4.9	6.9	4.9	7.1	5.2	7.4	5.2	7.9	5.1	8.4	5.1
71 (8.0)	7.2	5.4	7.3	5.5	7.8	5.5	8.0	5.8	8.3	5.8	8.9	5.7	9.4	5.6
80 (9.0)	8.1	6.1	8.3	6.2	8.8	6.2	9.0	6.5	9.4	6.6	10.0	6.5	10.6	6.4
100 (11.2)	10.1	8.3	10.3	8.5	11.0	8.4	11.2	9.0	11.7	9.0	12.4	8.9	13.2	8.7
125 (14.0)	12.6	9.5	12.8	9.7	13.7	9.6	14.0	10.1	14.6	10.2	15.5	10.0	16.5	9.9
140 (16.0)	14.4	10.8	14.7	11.1	15.7	11.0	16.0	11.6	16.7	11.6	17.7	11.5	18.8	11.3
200 (22.4)	20.2	15.5	20.5	15.9	21.9	15.8	22.4	16.7	23.4	16.7	24.8	16.5	26.4	16.3
250 (28.0)	25.2	19.3	25.7	19.8	27.4	19.6	28.0	20.7	29.2	20.8	31.1	20.5	33.0	20.2

* The capacity does not depend on the outdoor temperature.

kcal/h = kW x 860, BTU/h = kW x 3,412

PEFY-P-VMHS-E

CA: Capacity (kW), SHC: Sensible Heat Capacity (kW)

Model size (Rated kW)	Indoor air temp.													
	21.5°C D.B. 15°C W.B.		23°C D.B. 16°C W.B.		25°C D.B. 18°C W.B.		27°C D.B. 19°C W.B.		28°C D.B. 20°C W.B.		30°C D.B. 22°C W.B.		32°C D.B. 24°C W.B.	
	CA	SHC	CA	SHC	CA	SHC	CA	SHC	CA	SHC	CA	SHC	CA	SHC
200 (22.4)	20.2	16.8	20.5	17.3	21.9	17.2	22.4	18.3	23.4	18.3	24.8	18.1	26.4	17.9
250 (28.0)	25.2	20.5	25.7	21.1	27.4	20.9	28.0	22.3	29.2	22.3	31.1	22.0	33.0	21.7

* The capacity does not depend on the outdoor temperature.

kcal/h = kW x 860, BTU/h = kW x 3,412

1-4. Cooling capacity with PUHY-P400-650YSKB-A1, EP550-650YSLM-A

PEFY-P-VMR-E-L/R

CA: Capacity (kW), SHC: Sensible Heat Capacity (kW)

Model size (Rated kW)	Indoor air temp.													
	21.5°C D.B. 15°C W.B.		23°C D.B. 16°C W.B.		25°C D.B. 18°C W.B.		27°C D.B. 19°C W.B.		28°C D.B. 20°C W.B.		30°C D.B. 22°C W.B.		32°C D.B. 24°C W.B.	
	CA	SHC	CA	SHC	CA	SHC	CA	SHC	CA	SHC	CA	SHC	CA	SHC
20 (2.2)	2.0	1.7	2.0	1.7	2.2	1.7	2.2	1.8	2.3	1.8	2.5	1.8	2.6	1.8
25 (2.8)	2.5	1.9	2.6	2.0	2.7	1.9	2.8	2.1	2.9	2.1	3.1	2.0	3.3	2.0
32 (3.6)	3.2	2.3	3.3	2.4	3.5	2.4	3.6	2.5	3.8	2.5	4.0	2.5	4.3	2.5

* The capacity does not depend on the outdoor temperature.

kcal/h = kW x 860, BTU/h = kW x 3,412

PEFY-P-VMS1(L)-E

CA: Capacity (kW), SHC: Sensible Heat Capacity (kW)

Model size (Rated kW)	Indoor air temp.													
	21.5°C D.B. 15°C W.B.		23°C D.B. 16°C W.B.		25°C D.B. 18°C W.B.		27°C D.B. 19°C W.B.		28°C D.B. 20°C W.B.		30°C D.B. 22°C W.B.		32°C D.B. 24°C W.B.	
	CA	SHC	CA	SHC	CA	SHC	CA	SHC	CA	SHC	CA	SHC	CA	SHC
15 (1.7)	1.5	1.4	1.5	1.5	1.7	1.5	1.7	1.6	1.8	1.6	1.9	1.6	2.0	1.6
20 (2.2)	2.0	1.7	2.0	1.8	2.2	1.8	2.2	1.9	2.3	1.9	2.5	1.9	2.6	1.9
25 (2.8)	2.5	2.1	2.6	2.1	2.7	2.1	2.8	2.2	2.9	2.3	3.1	2.2	3.3	2.2
32 (3.6)	3.2	2.5	3.3	2.5	3.5	2.5	3.6	2.7	3.8	2.7	4.0	2.7	4.3	2.6
40 (4.5)	4.0	3.0	4.1	3.1	4.4	3.1	4.5	3.2	4.7	3.3	5.0	3.2	5.4	3.2
50 (5.6)	5.0	3.7	5.1	3.8	5.5	3.8	5.6	4.0	5.9	4.0	6.3	3.9	6.7	3.9
63 (7.1)	6.3	4.7	6.5	4.8	6.9	4.8	7.1	5.0	7.4	5.0	7.9	5.0	8.5	4.9

* The capacity does not depend on the outdoor temperature.

kcal/h = kW x 860, BTU/h = kW x 3,412

PEFY-P-VMH-E

CA: Capacity (kW), SHC: Sensible Heat Capacity (kW)

Model size (Rated kW)	Indoor air temp.													
	21.5°C D.B. 15°C W.B.		23°C D.B. 16°C W.B.		25°C D.B. 18°C W.B.		27°C D.B. 19°C W.B.		28°C D.B. 20°C W.B.		30°C D.B. 22°C W.B.		32°C D.B. 24°C W.B.	
	CA	SHC	CA	SHC	CA	SHC	CA	SHC	CA	SHC	CA	SHC	CA	SHC
40 (4.5)	4.0	3.1	4.1	3.2	4.4	3.2	4.5	3.4	4.7	3.4	5.0	3.4	5.4	3.3
50 (5.6)	5.0	3.7	5.1	3.7	5.5	3.7	5.6	3.9	5.9	3.9	6.3	3.9	6.7	3.8
63 (7.1)	6.3	4.8	6.5	4.9	6.9	4.9	7.1	5.2	7.4	5.2	7.9	5.2	8.5	5.1
71 (8.0)	7.1	5.4	7.3	5.5	7.8	5.5	8.0	5.8	8.4	5.8	8.9	5.7	9.5	5.7
80 (9.0)	8.0	6.1	8.2	6.2	8.8	6.2	9.0	6.5	9.4	6.6	10.1	6.5	10.7	6.4
100 (11.2)	10.0	8.2	10.2	8.5	11.0	8.4	11.2	9.0	11.7	9.0	12.5	8.9	13.4	8.8
125 (14.0)	12.5	9.4	12.8	9.6	13.7	9.6	14.0	10.1	14.7	10.2	15.7	10.1	16.7	10.0
140 (16.0)	14.3	10.8	14.6	11.0	15.7	11.0	16.0	11.6	16.8	11.6	17.9	11.5	19.1	11.4
200 (22.4)	20.0	15.5	20.4	15.8	21.9	15.8	22.4	16.7	23.5	16.8	25.1	16.6	26.7	16.4
250 (28.0)	25.0	19.2	25.5	19.7	27.4	19.6	28.0	20.7	29.3	20.8	31.3	20.6	33.4	20.4

* The capacity does not depend on the outdoor temperature.

kcal/h = kW x 860, BTU/h = kW x 3,412

1. Cooling [Ceiling concealed (Silent/Slim/High static pressure type)]

YKB/YLM

CT

PEFY-P-VMHS-E

CA: Capacity (kW), SHC: Sensible Heat Capacity (kW)

Model size (Rated kW)	Indoor air temp.													
	21.5°C D.B. 15°C W.B.		23°C D.B. 16°C W.B.		25°C D.B. 18°C W.B.		27°C D.B. 19°C W.B.		28°C D.B. 20°C W.B.		30°C D.B. 22°C W.B.		32°C D.B. 24°C W.B.	
	CA	SHC	CA	SHC	CA	SHC	CA	SHC	CA	SHC	CA	SHC	CA	SHC
200 (22.4)	20.0	16.8	20.4	17.3	21.9	17.2	22.4	18.3	23.5	18.4	25.1	18.2	26.7	18.0
250 (28.0)	25.0	20.4	25.5	21.0	27.4	20.9	28.0	22.3	29.3	22.3	31.3	22.1	33.4	21.9

* The capacity does not depend on the outdoor temperature.

kcal/h = kW x 860, BTU/h = kW x 3,412

1-5. Cooling capacity with PUHY-P700-800YSKB-A1, EP700-800YSLM-A

PEFY-P-VMR-E-L/R

CA: Capacity (kW), SHC: Sensible Heat Capacity (kW)

Model size (Rated kW)	Indoor air temp.													
	21.5°C D.B. 15°C W.B.		23°C D.B. 16°C W.B.		25°C D.B. 18°C W.B.		27°C D.B. 19°C W.B.		28°C D.B. 20°C W.B.		30°C D.B. 22°C W.B.		32°C D.B. 24°C W.B.	
	CA	SHC	CA	SHC	CA	SHC	CA	SHC	CA	SHC	CA	SHC	CA	SHC
20 (2.2)	1.9	1.6	2.0	1.7	2.1	1.7	2.2	1.8	2.3	1.8	2.4	1.8	2.6	1.8
25 (2.8)	2.5	1.9	2.5	1.9	2.7	1.9	2.8	2.1	2.9	2.1	3.1	2.0	3.3	2.0
32 (3.6)	3.2	2.3	3.3	2.4	3.5	2.4	3.6	2.5	3.7	2.5	4.0	2.5	4.2	2.4

* The capacity does not depend on the outdoor temperature.

kcal/h = kW x 860, BTU/h = kW x 3,412

PEFY-P-VMS1(L)-E

CA: Capacity (kW), SHC: Sensible Heat Capacity (kW)

Model size (Rated kW)	Indoor air temp.													
	21.5°C D.B. 15°C W.B.		23°C D.B. 16°C W.B.		25°C D.B. 18°C W.B.		27°C D.B. 19°C W.B.		28°C D.B. 20°C W.B.		30°C D.B. 22°C W.B.		32°C D.B. 24°C W.B.	
	CA	SHC	CA	SHC	CA	SHC	CA	SHC	CA	SHC	CA	SHC	CA	SHC
15 (1.7)	1.5	1.4	1.5	1.5	1.6	1.5	1.7	1.6	1.8	1.6	1.9	1.6	2.0	1.5
20 (2.2)	1.9	1.7	2.0	1.8	2.1	1.8	2.2	1.9	2.3	1.9	2.4	1.9	2.6	1.8
25 (2.8)	2.5	2.0	2.5	2.1	2.7	2.1	2.8	2.2	2.9	2.2	3.1	2.2	3.3	2.2
32 (3.6)	3.2	2.5	3.3	2.5	3.5	2.5	3.6	2.7	3.7	2.7	4.0	2.7	4.2	2.6
40 (4.5)	3.9	3.0	4.1	3.1	4.4	3.1	4.5	3.2	4.7	3.2	5.0	3.2	5.3	3.2
50 (5.6)	4.9	3.6	5.1	3.8	5.4	3.7	5.6	4.0	5.8	4.0	6.2	3.9	6.6	3.9
63 (7.1)	6.2	4.6	6.4	4.7	6.9	4.7	7.1	5.0	7.4	5.0	7.9	4.9	8.3	4.9

* The capacity does not depend on the outdoor temperature.

kcal/h = kW x 860, BTU/h = kW x 3,412

PEFY-P-VMH-E

CA: Capacity (kW), SHC: Sensible Heat Capacity (kW)

Model size (Rated kW)	Indoor air temp.													
	21.5°C D.B. 15°C W.B.		23°C D.B. 16°C W.B.		25°C D.B. 18°C W.B.		27°C D.B. 19°C W.B.		28°C D.B. 20°C W.B.		30°C D.B. 22°C W.B.		32°C D.B. 24°C W.B.	
	CA	SHC	CA	SHC	CA	SHC	CA	SHC	CA	SHC	CA	SHC	CA	SHC
40 (4.5)	3.9	3.1	4.1	3.2	4.4	3.2	4.5	3.4	4.7	3.4	5.0	3.3	5.3	3.3
50 (5.6)	4.9	3.6	5.1	3.7	5.4	3.7	5.6	3.9	5.8	3.9	6.2	3.9	6.6	3.8
63 (7.1)	6.2	4.8	6.4	4.9	6.9	4.9	7.1	5.2	7.4	5.2	7.9	5.1	8.3	5.1
71 (8.0)	7.0	5.3	7.2	5.5	7.8	5.4	8.0	5.8	8.3	5.8	8.8	5.7	9.4	5.6
80 (9.0)	7.9	6.0	8.1	6.2	8.7	6.2	9.0	6.5	9.3	6.5	10.0	6.5	10.6	6.4
100 (11.2)	9.8	8.1	10.1	8.4	10.9	8.4	11.2	9.0	11.6	8.9	12.4	8.9	13.2	8.7
125 (14.0)	12.3	9.3	12.7	9.6	13.6	9.6	14.0	10.1	14.5	10.1	15.5	10.0	16.5	9.9
140 (16.0)	14.0	10.6	14.5	11.0	15.5	10.9	16.0	11.6	16.6	11.6	17.7	11.5	18.8	11.3
200 (22.4)	19.6	15.3	20.2	15.8	21.7	15.7	22.4	16.7	23.2	16.7	24.8	16.5	26.3	16.3
250 (28.0)	24.5	19.0	25.3	19.6	27.2	19.5	28.0	20.7	29.0	20.7	31.0	20.5	32.9	20.2

* The capacity does not depend on the outdoor temperature.

kcal/h = kW x 860, BTU/h = kW x 3,412

PEFY-P-VMHS-E

CA: Capacity (kW), SHC: Sensible Heat Capacity (kW)

Model size (Rated kW)	Indoor air temp.													
	21.5°C D.B. 15°C W.B.		23°C D.B. 16°C W.B.		25°C D.B. 18°C W.B.		27°C D.B. 19°C W.B.		28°C D.B. 20°C W.B.		30°C D.B. 22°C W.B.		32°C D.B. 24°C W.B.	
	CA	SHC	CA	SHC	CA	SHC	CA	SHC	CA	SHC	CA	SHC	CA	SHC
200 (22.4)	19.6	16.6	20.2	17.2	21.7	17.1	22.4	18.3	23.2	18.3	24.8	18.1	26.3	17.9
250 (28.0)	24.5	20.2	25.3	20.9	27.2	20.8	28.0	22.3	29.0	22.2	31.0	22.0	32.9	21.7

* The capacity does not depend on the outdoor temperature.

kcal/h = kW x 860, BTU/h = kW x 3,412

1. Cooling [Ceiling concealed (Silent/Slim/High static pressure type)]

YKB/YLM

CT

1-6. Cooling capacity with PUHY-P850-1350YSKB-A1, EP850-1350YSLM-A

PEFY-P-VMR-E-L/R

CA: Capacity (kW), SHC: Sensible Heat Capacity (kW)

Model size (Rated kW)	Indoor air temp.													
	21.5°C D.B. 15°C W.B.		23°C D.B. 16°C W.B.		25°C D.B. 18°C W.B.		27°C D.B. 19°C W.B.		28°C D.B. 20°C W.B.		30°C D.B. 22°C W.B.		32°C D.B. 24°C W.B.	
	CA	SHC	CA	SHC	CA	SHC	CA	SHC	CA	SHC	CA	SHC	CA	SHC
20 (2.2)	2.0	1.7	2.0	1.7	2.2	1.7	2.2	1.8	2.3	1.8	2.5	1.8	2.6	1.8
25 (2.8)	2.5	1.9	2.6	2.0	2.7	1.9	2.8	2.1	2.9	2.1	3.1	2.0	3.3	2.0
32 (3.6)	3.2	2.3	3.3	2.4	3.5	2.4	3.6	2.5	3.8	2.5	4.0	2.5	4.3	2.5

* The capacity does not depend on the outdoor temperature.

kcal/h = kW x 860, BTU/h = kW x 3,412

PEFY-P-VMS1(L)-E

CA: Capacity (kW), SHC: Sensible Heat Capacity (kW)

Model size (Rated kW)	Indoor air temp.													
	21.5°C D.B. 15°C W.B.		23°C D.B. 16°C W.B.		25°C D.B. 18°C W.B.		27°C D.B. 19°C W.B.		28°C D.B. 20°C W.B.		30°C D.B. 22°C W.B.		32°C D.B. 24°C W.B.	
	CA	SHC	CA	SHC	CA	SHC	CA	SHC	CA	SHC	CA	SHC	CA	SHC
15 (1.7)	1.5	1.4	1.5	1.5	1.7	1.5	1.7	1.6	1.8	1.6	1.9	1.6	2.0	1.6
20 (2.2)	2.0	1.7	2.0	1.8	2.2	1.8	2.2	1.9	2.3	1.9	2.5	1.9	2.6	1.9
25 (2.8)	2.5	2.1	2.6	2.1	2.7	2.1	2.8	2.2	2.9	2.3	3.1	2.2	3.3	2.2
32 (3.6)	3.2	2.5	3.3	2.5	3.5	2.5	3.6	2.7	3.8	2.7	4.0	2.7	4.3	2.6
40 (4.5)	4.0	3.0	4.1	3.1	4.4	3.1	4.5	3.2	4.7	3.3	5.0	3.2	5.4	3.2
50 (5.6)	5.0	3.7	5.1	3.8	5.5	3.8	5.6	4.0	5.9	4.0	6.3	3.9	6.7	3.9
63 (7.1)	6.3	4.7	6.5	4.8	6.9	4.8	7.1	5.0	7.4	5.0	7.9	5.0	8.5	4.9

* The capacity does not depend on the outdoor temperature.

kcal/h = kW x 860, BTU/h = kW x 3,412

PEFY-P-VMH-E

CA: Capacity (kW), SHC: Sensible Heat Capacity (kW)

Model size (Rated kW)	Indoor air temp.													
	21.5°C D.B. 15°C W.B.		23°C D.B. 16°C W.B.		25°C D.B. 18°C W.B.		27°C D.B. 19°C W.B.		28°C D.B. 20°C W.B.		30°C D.B. 22°C W.B.		32°C D.B. 24°C W.B.	
	CA	SHC	CA	SHC	CA	SHC	CA	SHC	CA	SHC	CA	SHC	CA	SHC
40 (4.5)	4.0	3.1	4.1	3.2	4.4	3.2	4.5	3.4	4.7	3.4	5.0	3.4	5.4	3.3
50 (5.6)	5.0	3.7	5.1	3.7	5.5	3.7	5.6	3.9	5.9	3.9	6.3	3.9	6.7	3.8
63 (7.1)	6.3	4.8	6.5	4.9	6.9	4.9	7.1	5.2	7.4	5.2	7.9	5.2	8.5	5.1
71 (8.0)	7.1	5.4	7.3	5.5	7.8	5.5	8.0	5.8	8.4	5.8	8.9	5.7	9.5	5.7
80 (9.0)	8.0	6.1	8.2	6.2	8.8	6.2	9.0	6.5	9.4	6.6	10.1	6.5	10.7	6.4
100 (11.2)	10.0	8.2	10.2	8.5	11.0	8.4	11.2	9.0	11.7	9.0	12.5	8.9	13.4	8.8
125 (14.0)	12.5	9.4	12.8	9.6	13.7	9.6	14.0	10.1	14.7	10.2	15.7	10.1	16.7	10.0
140 (16.0)	14.3	10.8	14.6	11.0	15.7	11.0	16.0	11.6	16.8	11.6	17.9	11.5	19.1	11.4
200 (22.4)	20.0	15.5	20.4	15.8	21.9	15.8	22.4	16.7	23.5	16.8	25.1	16.6	26.7	16.4
250 (28.0)	25.0	19.2	25.5	19.7	27.4	19.6	28.0	20.7	29.3	20.8	31.3	20.6	33.4	20.4

* The capacity does not depend on the outdoor temperature.

kcal/h = kW x 860, BTU/h = kW x 3,412

PEFY-P-VMHS-E

CA: Capacity (kW), SHC: Sensible Heat Capacity (kW)

Model size (Rated kW)	Indoor air temp.													
	21.5°C D.B. 15°C W.B.		23°C D.B. 16°C W.B.		25°C D.B. 18°C W.B.		27°C D.B. 19°C W.B.		28°C D.B. 20°C W.B.		30°C D.B. 22°C W.B.		32°C D.B. 24°C W.B.	
	CA	SHC	CA	SHC	CA	SHC	CA	SHC	CA	SHC	CA	SHC	CA	SHC
200 (22.4)	20.0	16.8	20.4	17.3	21.9	17.2	22.4	18.3	23.5	18.4	25.1	18.2	26.7	18.0
250 (28.0)	25.0	20.4	25.5	21.0	27.4	20.9	28.0	22.3	29.3	22.3	31.3	22.1	33.4	21.9

* The capacity does not depend on the outdoor temperature.

kcal/h = kW x 860, BTU/h = kW x 3,412

1-7. Cooling capacity with PURY-(E)P200-250YLM-A(1)

PEFY-P-VMR-E-L/R

CA: Capacity (kW), SHC: Sensible Heat Capacity (kW)

Model size (Rated kW)	Indoor air temp.													
	21.5°C D.B. 15°C W.B.		23°C D.B. 16°C W.B.		25°C D.B. 18°C W.B.		27°C D.B. 19°C W.B.		28°C D.B. 20°C W.B.		30°C D.B. 22°C W.B.		32°C D.B. 24°C W.B.	
	CA	SHC	CA	SHC	CA	SHC	CA	SHC	CA	SHC	CA	SHC	CA	SHC
20 (2.2)	2.0	1.7	2.0	1.7	2.2	1.7	2.2	1.8	2.3	1.8	2.4	1.8	2.6	1.8
25 (2.8)	2.5	1.9	2.6	2.0	2.8	2.0	2.8	2.1	2.9	2.1	3.1	2.0	3.2	2.0
32 (3.6)	3.2	2.3	3.3	2.4	3.5	2.4	3.6	2.5	3.7	2.5	3.9	2.4	4.2	2.4

* The capacity does not depend on the outdoor temperature.

kcal/h = kW x 860, BTU/h = kW x 3,412

1. Cooling [Ceiling concealed (Silent/Slim/High static pressure type)]

YKB/YLM

CT

PEFY-P-VMS1(L)-E

CA: Capacity (kW), SHC: Sensible Heat Capacity (kW)

Model size (Rated kW)	Indoor air temp.													
	21.5°C D.B. 15°C W.B.		23°C D.B. 16°C W.B.		25°C D.B. 18°C W.B.		27°C D.B. 19°C W.B.		28°C D.B. 20°C W.B.		30°C D.B. 22°C W.B.		32°C D.B. 24°C W.B.	
	CA	SHC	CA	SHC	CA	SHC	CA	SHC	CA	SHC	CA	SHC	CA	SHC
15 (1.7)	1.5	1.4	1.6	1.5	1.7	1.5	1.7	1.6	1.8	1.6	1.9	1.6	2.0	1.5
20 (2.2)	2.0	1.7	2.0	1.8	2.2	1.8	2.2	1.9	2.3	1.9	2.4	1.9	2.6	1.8
25 (2.8)	2.5	2.1	2.6	2.1	2.8	2.1	2.8	2.2	2.9	2.2	3.1	2.2	3.2	2.2
32 (3.6)	3.2	2.5	3.3	2.6	3.5	2.5	3.6	2.7	3.7	2.7	3.9	2.6	4.2	2.6
40 (4.5)	4.1	3.0	4.2	3.1	4.4	3.1	4.5	3.2	4.7	3.2	4.9	3.2	5.2	3.1
50 (5.6)	5.0	3.7	5.2	3.8	5.5	3.8	5.6	4.0	5.8	4.0	6.1	3.9	6.5	3.8
63 (7.1)	6.4	4.7	6.6	4.8	7.0	4.8	7.1	5.0	7.4	5.0	7.8	4.9	8.2	4.8

* The capacity does not depend on the outdoor temperature.

kcal/h = kW x 860, BTU/h = kW x 3,412

PEFY-P-VMH-E

CA: Capacity (kW), SHC: Sensible Heat Capacity (kW)

Model size (Rated kW)	Indoor air temp.													
	21.5°C D.B. 15°C W.B.		23°C D.B. 16°C W.B.		25°C D.B. 18°C W.B.		27°C D.B. 19°C W.B.		28°C D.B. 20°C W.B.		30°C D.B. 22°C W.B.		32°C D.B. 24°C W.B.	
	CA	SHC	CA	SHC	CA	SHC	CA	SHC	CA	SHC	CA	SHC	CA	SHC
40 (4.5)	4.1	3.1	4.2	3.2	4.4	3.2	4.5	3.4	4.7	3.4	4.9	3.3	5.2	3.3
50 (5.6)	5.0	3.7	5.2	3.8	5.5	3.7	5.6	3.9	5.8	3.9	6.1	3.8	6.5	3.8
63 (7.1)	6.4	4.8	6.6	5.0	7.0	4.9	7.1	5.2	7.4	5.2	7.8	5.1	8.2	5.0
71 (8.0)	7.2	5.4	7.4	5.6	7.9	5.5	8.0	5.8	8.3	5.8	8.7	5.7	9.3	5.6
80 (9.0)	8.1	6.1	8.4	6.3	8.9	6.2	9.0	6.5	9.3	6.5	9.8	6.4	10.4	6.3
100 (11.2)	10.1	8.3	10.4	8.5	11.0	8.4	11.2	9.0	11.6	8.9	12.2	8.8	13.0	8.7
125 (14.0)	12.6	9.5	13.0	9.8	13.8	9.7	14.0	10.1	14.5	10.1	15.3	10.0	16.2	9.8
140 (16.0)	14.4	10.8	14.9	11.2	15.7	11.0	16.0	11.6	16.6	11.6	17.5	11.4	18.6	11.2
200 (22.4)	20.2	15.6	20.8	16.0	22.0	15.8	22.4	16.7	23.3	16.7	24.5	16.4	26.0	16.2
250 (28.0)	25.2	19.3	26.0	19.9	27.5	19.7	28.0	20.7	29.1	20.7	30.6	20.4	32.5	20.1

* The capacity does not depend on the outdoor temperature.

kcal/h = kW x 860, BTU/h = kW x 3,412

PEFY-P-VMHS-E

CA: Capacity (kW), SHC: Sensible Heat Capacity (kW)

Model size (Rated kW)	Indoor air temp.													
	21.5°C D.B. 15°C W.B.		23°C D.B. 16°C W.B.		25°C D.B. 18°C W.B.		27°C D.B. 19°C W.B.		28°C D.B. 20°C W.B.		30°C D.B. 22°C W.B.		32°C D.B. 24°C W.B.	
	CA	SHC	CA	SHC	CA	SHC	CA	SHC	CA	SHC	CA	SHC	CA	SHC
200 (22.4)	20.2	16.8	20.8	17.4	22.0	17.2	22.4	18.3	23.3	18.3	24.5	18.0	26.0	17.8
250 (28.0)	25.2	20.5	26.0	21.2	27.5	21.0	28.0	22.3	29.1	22.2	30.6	21.8	32.5	21.6

* The capacity does not depend on the outdoor temperature.

kcal/h = kW x 860, BTU/h = kW x 3,412

1-8. Cooling capacity with PURY-(E)P300-400Y(S)LM-A(1)

PEFY-P-VMR-E-L/R

CA: Capacity (kW), SHC: Sensible Heat Capacity (kW)

Model size (Rated kW)	Indoor air temp.													
	21.5°C D.B. 15°C W.B.		23°C D.B. 16°C W.B.		25°C D.B. 18°C W.B.		27°C D.B. 19°C W.B.		28°C D.B. 20°C W.B.		30°C D.B. 22°C W.B.		32°C D.B. 24°C W.B.	
	CA	SHC	CA	SHC	CA	SHC	CA	SHC	CA	SHC	CA	SHC	CA	SHC
20 (2.2)	2.0	1.7	2.0	1.7	2.2	1.7	2.2	1.8	2.3	1.8	2.4	1.8	2.6	1.8
25 (2.8)	2.5	1.9	2.6	2.0	2.7	1.9	2.8	2.1	2.9	2.1	3.1	2.0	3.3	2.0
32 (3.6)	3.2	2.3	3.3	2.4	3.5	2.4	3.6	2.5	3.8	2.5	4.0	2.5	4.2	2.4

* The capacity does not depend on the outdoor temperature.

kcal/h = kW x 860, BTU/h = kW x 3,412

PEFY-P-VMS1(L)-E

CA: Capacity (kW), SHC: Sensible Heat Capacity (kW)

Model size (Rated kW)	Indoor air temp.													
	21.5°C D.B. 15°C W.B.		23°C D.B. 16°C W.B.		25°C D.B. 18°C W.B.		27°C D.B. 19°C W.B.		28°C D.B. 20°C W.B.		30°C D.B. 22°C W.B.		32°C D.B. 24°C W.B.	
	CA	SHC	CA	SHC	CA	SHC	CA	SHC	CA	SHC	CA	SHC	CA	SHC
15 (1.7)	1.5	1.4	1.6	1.5	1.7	1.5	1.7	1.6	1.8	1.6	1.9	1.6	2.0	1.5
20 (2.2)	2.0	1.7	2.0	1.8	2.2	1.8	2.2	1.9	2.3	1.9	2.4	1.9	2.6	1.9
25 (2.8)	2.5	2.1	2.6	2.1	2.7	2.1	2.8	2.2	2.9	2.3	3.1	2.2	3.3	2.2
32 (3.6)	3.2	2.5	3.3	2.6	3.5	2.5	3.6	2.7	3.8	2.7	4.0	2.7	4.2	2.6
40 (4.5)	4.1	3.0	4.1	3.1	4.4	3.1	4.5	3.2	4.7	3.3	5.0	3.2	5.3	3.2
50 (5.6)	5.0	3.7	5.1	3.8	5.5	3.8	5.6	4.0	5.8	4.0	6.2	3.9	6.6	3.9
63 (7.1)	6.4	4.7	6.5	4.8	6.9	4.8	7.1	5.0	7.4	5.0	7.9	5.0	8.4	4.9

* The capacity does not depend on the outdoor temperature.

kcal/h = kW x 860, BTU/h = kW x 3,412

1. Cooling [Ceiling concealed (Silent/Slim/High static pressure type)]

YKB/YLM

CT

PEFY-P-VMH-E

CA: Capacity (kW), SHC: Sensible Heat Capacity (kW)

Model size (Rated kW)	Indoor air temp.													
	21.5°C D.B. 15°C W.B.		23°C D.B. 16°C W.B.		25°C D.B. 18°C W.B.		27°C D.B. 19°C W.B.		28°C D.B. 20°C W.B.		30°C D.B. 22°C W.B.		32°C D.B. 24°C W.B.	
	CA	SHC	CA	SHC	CA	SHC	CA	SHC	CA	SHC	CA	SHC	CA	SHC
40 (4.5)	4.1	3.1	4.1	3.2	4.4	3.2	4.5	3.4	4.7	3.4	5.0	3.4	5.3	3.3
50 (5.6)	5.0	3.7	5.1	3.7	5.5	3.7	5.6	3.9	5.8	3.9	6.2	3.9	6.6	3.8
63 (7.1)	6.4	4.8	6.5	4.9	6.9	4.9	7.1	5.2	7.4	5.2	7.9	5.1	8.4	5.1
71 (8.0)	7.2	5.4	7.3	5.5	7.8	5.5	8.0	5.8	8.3	5.8	8.9	5.7	9.4	5.6
80 (9.0)	8.1	6.1	8.3	6.2	8.8	6.2	9.0	6.5	9.4	6.6	10.0	6.5	10.6	6.4
100 (11.2)	10.1	8.3	10.3	8.5	11.0	8.4	11.2	9.0	11.7	9.0	12.4	8.9	13.2	8.7
125 (14.0)	12.6	9.5	12.8	9.7	13.7	9.6	14.0	10.1	14.6	10.2	15.5	10.0	16.5	9.9
140 (16.0)	14.4	10.8	14.7	11.1	15.7	11.0	16.0	11.6	16.7	11.6	17.7	11.5	18.8	11.3
200 (22.4)	20.2	15.5	20.5	15.9	21.9	15.8	22.4	16.7	23.4	16.7	24.8	16.5	26.4	16.3
250 (28.0)	25.2	19.3	25.7	19.8	27.4	19.6	28.0	20.7	29.2	20.8	31.1	20.5	33.0	20.2

* The capacity does not depend on the outdoor temperature.

kcal/h = kW x 860, BTU/h = kW x 3,412

PEFY-P-VMHS-E

CA: Capacity (kW), SHC: Sensible Heat Capacity (kW)

Model size (Rated kW)	Indoor air temp.													
	21.5°C D.B. 15°C W.B.		23°C D.B. 16°C W.B.		25°C D.B. 18°C W.B.		27°C D.B. 19°C W.B.		28°C D.B. 20°C W.B.		30°C D.B. 22°C W.B.		32°C D.B. 24°C W.B.	
	CA	SHC	CA	SHC	CA	SHC	CA	SHC	CA	SHC	CA	SHC	CA	SHC
200 (22.4)	20.2	16.8	20.5	17.3	21.9	17.2	22.4	18.3	23.4	18.3	24.8	18.1	26.4	17.9
250 (28.0)	25.2	20.5	25.7	21.1	27.4	20.9	28.0	22.3	29.2	22.3	31.1	22.0	33.0	21.7

* The capacity does not depend on the outdoor temperature.

kcal/h = kW x 860, BTU/h = kW x 3,412

1-9. Cooling capacity with PURY-(E)P450-650Y(S)LM-A(1)

PEFY-P-VMR-E-L/R

CA: Capacity (kW), SHC: Sensible Heat Capacity (kW)

Model size (Rated kW)	Indoor air temp.													
	21.5°C D.B. 15°C W.B.		23°C D.B. 16°C W.B.		25°C D.B. 18°C W.B.		27°C D.B. 19°C W.B.		28°C D.B. 20°C W.B.		30°C D.B. 22°C W.B.		32°C D.B. 24°C W.B.	
	CA	SHC	CA	SHC	CA	SHC	CA	SHC	CA	SHC	CA	SHC	CA	SHC
20 (2.2)	2.0	1.7	2.0	1.7	2.2	1.7	2.2	1.8	2.3	1.8	2.5	1.8	2.6	1.8
25 (2.8)	2.5	1.9	2.6	2.0	2.7	1.9	2.8	2.1	2.9	2.1	3.1	2.0	3.3	2.0
32 (3.6)	3.2	2.3	3.3	2.4	3.5	2.4	3.6	2.5	3.8	2.5	4.0	2.5	4.3	2.5

* The capacity does not depend on the outdoor temperature.

kcal/h = kW x 860, BTU/h = kW x 3,412

PEFY-P-VMS1(L)-E

CA: Capacity (kW), SHC: Sensible Heat Capacity (kW)

Model size (Rated kW)	Indoor air temp.													
	21.5°C D.B. 15°C W.B.		23°C D.B. 16°C W.B.		25°C D.B. 18°C W.B.		27°C D.B. 19°C W.B.		28°C D.B. 20°C W.B.		30°C D.B. 22°C W.B.		32°C D.B. 24°C W.B.	
	CA	SHC	CA	SHC	CA	SHC	CA	SHC	CA	SHC	CA	SHC	CA	SHC
15 (1.7)	1.5	1.4	1.5	1.5	1.7	1.5	1.7	1.6	1.8	1.6	1.9	1.6	2.0	1.6
20 (2.2)	2.0	1.7	2.0	1.8	2.2	1.8	2.2	1.9	2.3	1.9	2.5	1.9	2.6	1.9
25 (2.8)	2.5	2.1	2.6	2.1	2.7	2.1	2.8	2.2	2.9	2.3	3.1	2.2	3.3	2.2
32 (3.6)	3.2	2.5	3.3	2.5	3.5	2.5	3.6	2.7	3.8	2.7	4.0	2.7	4.3	2.6
40 (4.5)	4.0	3.0	4.1	3.1	4.4	3.1	4.5	3.2	4.7	3.3	5.0	3.2	5.4	3.2
50 (5.6)	5.0	3.7	5.1	3.8	5.5	3.8	5.6	4.0	5.9	4.0	6.3	3.9	6.7	3.9
63 (7.1)	6.3	4.7	6.5	4.8	6.9	4.8	7.1	5.0	7.4	5.0	7.9	5.0	8.5	4.9

* The capacity does not depend on the outdoor temperature.

kcal/h = kW x 860, BTU/h = kW x 3,412

PEFY-P-VMH-E

CA: Capacity (kW), SHC: Sensible Heat Capacity (kW)

Model size (Rated kW)	Indoor air temp.													
	21.5°C D.B. 15°C W.B.		23°C D.B. 16°C W.B.		25°C D.B. 18°C W.B.		27°C D.B. 19°C W.B.		28°C D.B. 20°C W.B.		30°C D.B. 22°C W.B.		32°C D.B. 24°C W.B.	
	CA	SHC	CA	SHC	CA	SHC	CA	SHC	CA	SHC	CA	SHC	CA	SHC
40 (4.5)	4.0	3.1	4.1	3.2	4.4	3.2	4.5	3.4	4.7	3.4	5.0	3.4	5.4	3.3
50 (5.6)	5.0	3.7	5.1	3.7	5.5	3.7	5.6	3.9	5.9	3.9	6.3	3.9	6.7	3.8
63 (7.1)	6.3	4.8	6.5	4.9	6.9	4.9	7.1	5.2	7.4	5.2	7.9	5.2	8.5	5.1
71 (8.0)	7.1	5.4	7.3	5.5	7.8	5.5	8.0	5.8	8.4	5.8	8.9	5.7	9.5	5.7
80 (9.0)	8.0	6.1	8.2	6.2	8.8	6.2	9.0	6.5	9.4	6.6	10.1	6.5	10.7	6.4
100 (11.2)	10.0	8.2	10.2	8.5	11.0	8.4	11.2	9.0	11.7	9.0	12.5	8.9	13.4	8.8
125 (14.0)	12.5	9.4	12.8	9.6	13.7	9.6	14.0	10.1	14.7	10.2	15.7	10.1	16.7	10.0
140 (16.0)	14.3	10.8	14.6	11.0	15.7	11.0	16.0	11.6	16.8	11.6	17.9	11.5	19.1	11.4
200 (22.4)	20.0	15.5	20.4	15.8	21.9	15.8	22.4	16.7	23.5	16.8	25.1	16.6	26.7	16.4
250 (28.0)	25.0	19.2	25.5	19.7	27.4	19.6	28.0	20.7	29.3	20.8	31.3	20.6	33.4	20.4

* The capacity does not depend on the outdoor temperature.

kcal/h = kW x 860, BTU/h = kW x 3,412

1. Cooling [Ceiling concealed (Silent/Slim/High static pressure type)]

YKB/YLM

CT

PEFY-P-VMHS-E

CA: Capacity (kW), SHC: Sensible Heat Capacity (kW)

Model size (Rated kW)	Indoor air temp.													
	21.5°C D.B. 15°C W.B.		23°C D.B. 16°C W.B.		25°C D.B. 18°C W.B.		27°C D.B. 19°C W.B.		28°C D.B. 20°C W.B.		30°C D.B. 22°C W.B.		32°C D.B. 24°C W.B.	
	CA	SHC	CA	SHC	CA	SHC	CA	SHC	CA	SHC	CA	SHC	CA	SHC
200 (22.4)	20.0	16.8	20.4	17.3	21.9	17.2	22.4	18.3	23.5	18.4	25.1	18.2	26.7	18.0
250 (28.0)	25.0	20.4	25.5	21.0	27.4	20.9	28.0	22.3	29.3	22.3	31.3	22.1	33.4	21.9

* The capacity does not depend on the outdoor temperature.

kcal/h = kW x 860, BTU/h = kW x 3,412

1-10. Cooling capacity with PURY-(E)P700-800YSLM-A(1)

PEFY-P-VMR-E-L/R

CA: Capacity (kW), SHC: Sensible Heat Capacity (kW)

Model size (Rated kW)	Indoor air temp.													
	21.5°C D.B. 15°C W.B.		23°C D.B. 16°C W.B.		25°C D.B. 18°C W.B.		27°C D.B. 19°C W.B.		28°C D.B. 20°C W.B.		30°C D.B. 22°C W.B.		32°C D.B. 24°C W.B.	
	CA	SHC	CA	SHC	CA	SHC	CA	SHC	CA	SHC	CA	SHC	CA	SHC
20 (2.2)	1.9	1.6	2.0	1.7	2.1	1.7	2.2	1.8	2.3	1.8	2.4	1.8	2.6	1.8
25 (2.8)	2.5	1.9	2.5	1.9	2.7	1.9	2.8	2.1	2.9	2.1	3.1	2.0	3.3	2.0
32 (3.6)	3.2	2.3	3.3	2.4	3.5	2.4	3.6	2.5	3.7	2.5	4.0	2.5	4.2	2.4

* The capacity does not depend on the outdoor temperature.

kcal/h = kW x 860, BTU/h = kW x 3,412

PEFY-P-VMS1(L)-E

CA: Capacity (kW), SHC: Sensible Heat Capacity (kW)

Model size (Rated kW)	Indoor air temp.													
	21.5°C D.B. 15°C W.B.		23°C D.B. 16°C W.B.		25°C D.B. 18°C W.B.		27°C D.B. 19°C W.B.		28°C D.B. 20°C W.B.		30°C D.B. 22°C W.B.		32°C D.B. 24°C W.B.	
	CA	SHC	CA	SHC	CA	SHC	CA	SHC	CA	SHC	CA	SHC	CA	SHC
15 (1.7)	1.5	1.4	1.5	1.5	1.6	1.5	1.7	1.6	1.8	1.6	1.9	1.6	2.0	1.5
20 (2.2)	1.9	1.7	2.0	1.8	2.1	1.8	2.2	1.9	2.3	1.9	2.4	1.9	2.6	1.8
25 (2.8)	2.5	2.0	2.5	2.1	2.7	2.1	2.8	2.2	2.9	2.2	3.1	2.2	3.3	2.2
32 (3.6)	3.2	2.5	3.3	2.5	3.5	2.5	3.6	2.7	3.7	2.7	4.0	2.7	4.2	2.6
40 (4.5)	3.9	3.0	4.1	3.1	4.4	3.1	4.5	3.2	4.7	3.2	5.0	3.2	5.3	3.2
50 (5.6)	4.9	3.6	5.1	3.8	5.4	3.7	5.6	4.0	5.8	4.0	6.2	3.9	6.6	3.9
63 (7.1)	6.2	4.6	6.4	4.7	6.9	4.7	7.1	5.0	7.4	5.0	7.9	4.9	8.3	4.9

* The capacity does not depend on the outdoor temperature.

kcal/h = kW x 860, BTU/h = kW x 3,412

PEFY-P-VMH-E

CA: Capacity (kW), SHC: Sensible Heat Capacity (kW)

Model size (Rated kW)	Indoor air temp.													
	21.5°C D.B. 15°C W.B.		23°C D.B. 16°C W.B.		25°C D.B. 18°C W.B.		27°C D.B. 19°C W.B.		28°C D.B. 20°C W.B.		30°C D.B. 22°C W.B.		32°C D.B. 24°C W.B.	
	CA	SHC	CA	SHC	CA	SHC	CA	SHC	CA	SHC	CA	SHC	CA	SHC
40 (4.5)	3.9	3.1	4.1	3.2	4.4	3.2	4.5	3.4	4.7	3.4	5.0	3.3	5.3	3.3
50 (5.6)	4.9	3.6	5.1	3.7	5.4	3.7	5.6	3.9	5.8	3.9	6.2	3.9	6.6	3.8
63 (7.1)	6.2	4.8	6.4	4.9	6.9	4.9	7.1	5.2	7.4	5.2	7.9	5.1	8.3	5.1
71 (8.0)	7.0	5.3	7.2	5.5	7.8	5.4	8.0	5.8	8.3	5.8	8.8	5.7	9.4	5.6
80 (9.0)	7.9	6.0	8.1	6.2	8.7	6.2	9.0	6.5	9.3	6.5	10.0	6.5	10.6	6.4
100 (11.2)	9.8	8.1	10.1	8.4	10.9	8.4	11.2	9.0	11.6	8.9	12.4	8.9	13.2	8.7
125 (14.0)	12.3	9.3	12.7	9.6	13.6	9.6	14.0	10.1	14.5	10.1	15.5	10.0	16.5	9.9
140 (16.0)	14.0	10.6	14.5	11.0	15.5	10.9	16.0	11.6	16.6	11.6	17.7	11.5	18.8	11.3
200 (22.4)	19.6	15.3	20.2	15.8	21.7	15.7	22.4	16.7	23.2	16.7	24.8	16.5	26.3	16.3
250 (28.0)	24.5	19.0	25.3	19.6	27.2	19.5	28.0	20.7	29.0	20.7	31.0	20.5	32.9	20.2

* The capacity does not depend on the outdoor temperature.

kcal/h = kW x 860, BTU/h = kW x 3,412

PEFY-P-VMHS-E

CA: Capacity (kW), SHC: Sensible Heat Capacity (kW)

Model size (Rated kW)	Indoor air temp.													
	21.5°C D.B. 15°C W.B.		23°C D.B. 16°C W.B.		25°C D.B. 18°C W.B.		27°C D.B. 19°C W.B.		28°C D.B. 20°C W.B.		30°C D.B. 22°C W.B.		32°C D.B. 24°C W.B.	
	CA	SHC	CA	SHC	CA	SHC	CA	SHC	CA	SHC	CA	SHC	CA	SHC
200 (22.4)	19.6	16.6	20.2	17.2	21.7	17.1	22.4	18.3	23.2	18.3	24.8	18.1	26.3	17.9
250 (28.0)	24.5	20.2	25.3	20.9	27.2	20.8	28.0	22.3	29.0	22.2	31.0	22.0	32.9	21.7

* The capacity does not depend on the outdoor temperature.

kcal/h = kW x 860, BTU/h = kW x 3,412

1. Cooling [Ceiling concealed (Silent/Slim/High static pressure type)]

YKB/YLM

CT

1-11. Cooling capacity with PURY-(E)P850-900YSLM-A(1)

PEFY-P-VMR-E-L/R

CA: Capacity (kW), SHC: Sensible Heat Capacity (kW)

Model size (Rated kW)	Indoor air temp.													
	21.5°C D.B. 15°C W.B.		23°C D.B. 16°C W.B.		25°C D.B. 18°C W.B.		27°C D.B. 19°C W.B.		28°C D.B. 20°C W.B.		30°C D.B. 22°C W.B.		32°C D.B. 24°C W.B.	
	CA	SHC	CA	SHC	CA	SHC	CA	SHC	CA	SHC	CA	SHC	CA	SHC
20 (2.2)	2.0	1.7	2.0	1.7	2.2	1.7	2.2	1.8	2.3	1.8	2.5	1.8	2.6	1.8
25 (2.8)	2.5	1.9	2.6	2.0	2.7	1.9	2.8	2.1	2.9	2.1	3.1	2.0	3.3	2.0
32 (3.6)	3.2	2.3	3.3	2.4	3.5	2.4	3.6	2.5	3.8	2.5	4.0	2.5	4.3	2.5

* The capacity does not depend on the outdoor temperature.

kcal/h = kW x 860, BTU/h = kW x 3,412

PEFY-P-VMS1(L)-E

CA: Capacity (kW), SHC: Sensible Heat Capacity (kW)

Model size (Rated kW)	Indoor air temp.													
	21.5°C D.B. 15°C W.B.		23°C D.B. 16°C W.B.		25°C D.B. 18°C W.B.		27°C D.B. 19°C W.B.		28°C D.B. 20°C W.B.		30°C D.B. 22°C W.B.		32°C D.B. 24°C W.B.	
	CA	SHC	CA	SHC	CA	SHC	CA	SHC	CA	SHC	CA	SHC	CA	SHC
15 (1.7)	1.5	1.4	1.5	1.5	1.7	1.5	1.7	1.6	1.8	1.6	1.9	1.6	2.0	1.6
20 (2.2)	2.0	1.7	2.0	1.8	2.2	1.8	2.2	1.9	2.3	1.9	2.5	1.9	2.6	1.9
25 (2.8)	2.5	2.1	2.6	2.1	2.7	2.1	2.8	2.2	2.9	2.3	3.1	2.2	3.3	2.2
32 (3.6)	3.2	2.5	3.3	2.5	3.5	2.5	3.6	2.7	3.8	2.7	4.0	2.7	4.3	2.6
40 (4.5)	4.0	3.0	4.1	3.1	4.4	3.1	4.5	3.2	4.7	3.3	5.0	3.2	5.4	3.2
50 (5.6)	5.0	3.7	5.1	3.8	5.5	3.8	5.6	4.0	5.9	4.0	6.3	3.9	6.7	3.9
63 (7.1)	6.3	4.7	6.5	4.8	6.9	4.8	7.1	5.0	7.4	5.0	7.9	5.0	8.5	4.9

* The capacity does not depend on the outdoor temperature.

kcal/h = kW x 860, BTU/h = kW x 3,412

PEFY-P-VMH-E

CA: Capacity (kW), SHC: Sensible Heat Capacity (kW)

Model size (Rated kW)	Indoor air temp.													
	21.5°C D.B. 15°C W.B.		23°C D.B. 16°C W.B.		25°C D.B. 18°C W.B.		27°C D.B. 19°C W.B.		28°C D.B. 20°C W.B.		30°C D.B. 22°C W.B.		32°C D.B. 24°C W.B.	
	CA	SHC	CA	SHC	CA	SHC	CA	SHC	CA	SHC	CA	SHC	CA	SHC
40 (4.5)	4.0	3.1	4.1	3.2	4.4	3.2	4.5	3.4	4.7	3.4	5.0	3.4	5.4	3.3
50 (5.6)	5.0	3.7	5.1	3.7	5.5	3.7	5.6	3.9	5.9	3.9	6.3	3.9	6.7	3.8
63 (7.1)	6.3	4.8	6.5	4.9	6.9	4.9	7.1	5.2	7.4	5.2	7.9	5.2	8.5	5.1
71 (8.0)	7.1	5.4	7.3	5.5	7.8	5.5	8.0	5.8	8.4	5.8	8.9	5.7	9.5	5.7
80 (9.0)	8.0	6.1	8.2	6.2	8.8	6.2	9.0	6.5	9.4	6.6	10.1	6.5	10.7	6.4
100 (11.2)	10.0	8.2	10.2	8.5	11.0	8.4	11.2	9.0	11.7	9.0	12.5	8.9	13.4	8.8
125 (14.0)	12.5	9.4	12.8	9.6	13.7	9.6	14.0	10.1	14.7	10.2	15.7	10.1	16.7	10.0
140 (16.0)	14.3	10.8	14.6	11.0	15.7	11.0	16.0	11.6	16.8	11.6	17.9	11.5	19.1	11.4
200 (22.4)	20.0	15.5	20.4	15.8	21.9	15.8	22.4	16.7	23.5	16.8	25.1	16.6	26.7	16.4
250 (28.0)	25.0	19.2	25.5	19.7	27.4	19.6	28.0	20.7	29.3	20.8	31.3	20.6	33.4	20.4

* The capacity does not depend on the outdoor temperature.

kcal/h = kW x 860, BTU/h = kW x 3,412

PEFY-P-VMHS-E

CA: Capacity (kW), SHC: Sensible Heat Capacity (kW)

Model size (Rated kW)	Indoor air temp.													
	21.5°C D.B. 15°C W.B.		23°C D.B. 16°C W.B.		25°C D.B. 18°C W.B.		27°C D.B. 19°C W.B.		28°C D.B. 20°C W.B.		30°C D.B. 22°C W.B.		32°C D.B. 24°C W.B.	
	CA	SHC	CA	SHC	CA	SHC	CA	SHC	CA	SHC	CA	SHC	CA	SHC
200 (22.4)	20.0	16.8	20.4	17.3	21.9	17.2	22.4	18.3	23.5	18.4	25.1	18.2	26.7	18.0
250 (28.0)	25.0	20.4	25.5	21.0	27.4	20.9	28.0	22.3	29.3	22.3	31.3	22.1	33.4	21.9

* The capacity does not depend on the outdoor temperature.

kcal/h = kW x 860, BTU/h = kW x 3,412

2. Cooling [Ceiling concealed (Middle static pressure type)]

YKB/YLM

CT

2-1. Cooling capacity with PUHY-P200-250YKB-A1, EP200-250YLM-A

PEFY-P-VMA(L)-E

CA: Capacity (kW), SHC: Sensible Heat Capacity (kW)

Model size (Rated kW)	Indoor air temp.													
	21.5°C D.B. 15°C W.B.		23°C D.B. 16°C W.B.		25°C D.B. 18°C W.B.		27°C D.B. 19°C W.B.		28°C D.B. 20°C W.B.		30°C D.B. 22°C W.B.		32°C D.B. 24°C W.B.	
	CA	SHC	CA	SHC	CA	SHC	CA	SHC	CA	SHC	CA	SHC	CA	SHC
20 (2.2)	2.0	1.8	2.0	1.9	2.2	1.9	2.2	2.0	2.3	2.0	2.4	2.0	2.6	1.9
25 (2.8)	2.5	2.0	2.6	2.1	2.8	2.1	2.8	2.2	2.9	2.2	3.1	2.2	3.2	2.1
32 (3.6)	3.2	2.5	3.3	2.5	3.5	2.5	3.6	2.6	3.7	2.6	3.9	2.6	4.2	2.6
40 (4.5)	4.1	3.3	4.2	3.4	4.4	3.4	4.5	3.6	4.7	3.6	4.9	3.5	5.2	3.5
50 (5.6)	5.0	4.1	5.2	4.2	5.5	4.2	5.6	4.4	5.8	4.4	6.1	4.4	6.5	4.3
63 (7.1)	6.4	5.1	6.6	5.2	7.0	5.2	7.1	5.5	7.4	5.4	7.8	5.4	8.2	5.3
71 (8.0)	7.2	5.5	7.4	5.7	7.9	5.6	8.0	5.9	8.3	5.9	8.7	5.8	9.3	5.7
80 (9.0)	8.1	5.9	8.4	6.1	8.9	6.0	9.0	6.3	9.3	6.3	9.8	6.2	10.4	6.1
100 (11.2)	10.1	8.1	10.4	8.4	11.0	8.3	11.2	8.8	11.6	8.8	12.2	8.7	13.0	8.5
125 (14.0)	12.6	9.9	13.0	10.2	13.8	10.1	14.0	10.7	14.5	10.7	15.3	10.5	16.2	10.3
140 (16.0)	14.4	11.2	14.9	11.5	15.7	11.4	16.0	12.0	16.6	12.0	17.5	11.8	18.6	11.7

* The capacity does not depend on the outdoor temperature.

kcal/h = kW x 860, BTU/h = kW x 3,412

PEFY-P-VMA3-E

CA: Capacity (kW), SHC: Sensible Heat Capacity (kW)

Model size (Rated kW)	Indoor air temp.													
	21.5°C D.B. 15°C W.B.		23°C D.B. 16°C W.B.		25°C D.B. 18°C W.B.		27°C D.B. 19°C W.B.		28°C D.B. 20°C W.B.		30°C D.B. 22°C W.B.		32°C D.B. 24°C W.B.	
	CA	SHC	CA	SHC	CA	SHC	CA	SHC	CA	SHC	CA	SHC	CA	SHC
20 (2.2)	2.0	1.8	2.0	1.9	2.2	1.9	2.2	2.0	2.3	2.0	2.4	2.0	2.6	2.0

* The capacity does not depend on the outdoor temperature.

kcal/h = kW x 860, BTU/h = kW x 3,412

2-2. Cooling capacity with PUHY-P300-400YKB-A1, EP300-350YLM-A

PEFY-P-VMA(L)-E

CA: Capacity (kW), SHC: Sensible Heat Capacity (kW)

Model size (Rated kW)	Indoor air temp.													
	21.5°C D.B. 15°C W.B.		23°C D.B. 16°C W.B.		25°C D.B. 18°C W.B.		27°C D.B. 19°C W.B.		28°C D.B. 20°C W.B.		30°C D.B. 22°C W.B.		32°C D.B. 24°C W.B.	
	CA	SHC	CA	SHC	CA	SHC	CA	SHC	CA	SHC	CA	SHC	CA	SHC
20 (2.2)	2.0	1.8	2.0	1.9	2.2	1.9	2.2	2.0	2.3	2.0	2.4	2.0	2.6	1.9
25 (2.8)	2.5	2.0	2.6	2.1	2.8	2.1	2.8	2.2	2.9	2.2	3.1	2.2	3.2	2.1
32 (3.6)	3.2	2.5	3.3	2.5	3.5	2.5	3.6	2.6	3.7	2.6	3.9	2.6	4.2	2.6
40 (4.5)	4.1	3.3	4.2	3.4	4.4	3.4	4.5	3.6	4.7	3.6	4.9	3.5	5.2	3.5
50 (5.6)	5.0	4.1	5.2	4.2	5.5	4.2	5.6	4.4	5.8	4.4	6.1	4.4	6.5	4.3
63 (7.1)	6.4	5.1	6.6	5.2	7.0	5.2	7.1	5.5	7.4	5.4	7.8	5.4	8.2	5.3
71 (8.0)	7.2	5.5	7.4	5.7	7.9	5.6	8.0	5.9	8.3	5.9	8.7	5.8	9.3	5.7
80 (9.0)	8.1	5.9	8.4	6.1	8.9	6.0	9.0	6.3	9.3	6.3	9.8	6.2	10.4	6.1
100 (11.2)	10.1	8.1	10.4	8.4	11.0	8.3	11.2	8.8	11.6	8.8	12.2	8.7	13.0	8.5
125 (14.0)	12.6	9.9	13.0	10.2	13.8	10.1	14.0	10.7	14.5	10.7	15.3	10.5	16.2	10.3
140 (16.0)	14.4	11.2	14.9	11.5	15.7	11.4	16.0	12.0	16.6	12.0	17.5	11.8	18.6	11.7

* The capacity does not depend on the outdoor temperature.

kcal/h = kW x 860, BTU/h = kW x 3,412

PEFY-P-VMA3-E

CA: Capacity (kW), SHC: Sensible Heat Capacity (kW)

Model size (Rated kW)	Indoor air temp.													
	21.5°C D.B. 15°C W.B.		23°C D.B. 16°C W.B.		25°C D.B. 18°C W.B.		27°C D.B. 19°C W.B.		28°C D.B. 20°C W.B.		30°C D.B. 22°C W.B.		32°C D.B. 24°C W.B.	
	CA	SHC	CA	SHC	CA	SHC	CA	SHC	CA	SHC	CA	SHC	CA	SHC
20 (2.2)	2.0	1.8	2.0	1.9	2.2	1.9	2.2	2.0	2.3	2.0	2.4	2.0	2.6	2.0

* The capacity does not depend on the outdoor temperature.

kcal/h = kW x 860, BTU/h = kW x 3,412

2. Cooling [Ceiling concealed (Middle static pressure type)]

YKB/YLM

2-3. Cooling capacity with PUHY-P450-500YKB-A1, EP400-500YLM-A

PEFY-P-VMA(L)-E

CA: Capacity (kW), SHC: Sensible Heat Capacity (kW)

Model size (Rated kW)	Indoor air temp.													
	21.5°C D.B. 15°C W.B.		23°C D.B. 16°C W.B.		25°C D.B. 18°C W.B.		27°C D.B. 19°C W.B.		28°C D.B. 20°C W.B.		30°C D.B. 22°C W.B.		32°C D.B. 24°C W.B.	
	CA	SHC	CA	SHC	CA	SHC	CA	SHC	CA	SHC	CA	SHC	CA	SHC
20 (2.2)	2.0	1.8	2.0	1.9	2.2	1.9	2.2	2.0	2.3	2.0	2.4	2.0	2.6	1.9
25 (2.8)	2.5	2.0	2.6	2.1	2.7	2.1	2.8	2.2	2.9	2.2	3.1	2.2	3.3	2.1
32 (3.6)	3.2	2.5	3.3	2.5	3.5	2.5	3.6	2.6	3.8	2.6	4.0	2.6	4.2	2.6
40 (4.5)	4.1	3.3	4.1	3.4	4.4	3.4	4.5	3.6	4.7	3.6	5.0	3.6	5.3	3.5
50 (5.6)	5.0	4.1	5.1	4.2	5.5	4.2	5.6	4.4	5.8	4.4	6.2	4.4	6.6	4.3
63 (7.1)	6.4	5.1	6.5	5.2	6.9	5.1	7.1	5.5	7.4	5.5	7.9	5.4	8.4	5.3
71 (8.0)	7.2	5.5	7.3	5.6	7.8	5.6	8.0	5.9	8.3	5.9	8.9	5.8	9.4	5.8
80 (9.0)	8.1	5.9	8.3	6.0	8.8	6.0	9.0	6.3	9.4	6.3	10.0	6.2	10.6	6.1
100 (11.2)	10.1	8.1	10.3	8.4	11.0	8.3	11.2	8.8	11.7	8.8	12.4	8.7	13.2	8.6
125 (14.0)	12.6	9.9	12.8	10.1	13.7	10.1	14.0	10.7	14.6	10.7	15.5	10.6	16.5	10.4
140 (16.0)	14.4	11.2	14.7	11.5	15.7	11.4	16.0	12.0	16.7	12.1	17.7	11.9	18.8	11.7

* The capacity does not depend on the outdoor temperature.

kcal/h = kW x 860, BTU/h = kW x 3,412

PEFY-P-VMA3-E

CA: Capacity (kW), SHC: Sensible Heat Capacity (kW)

Model size (Rated kW)	Indoor air temp.													
	21.5°C D.B. 15°C W.B.		23°C D.B. 16°C W.B.		25°C D.B. 18°C W.B.		27°C D.B. 19°C W.B.		28°C D.B. 20°C W.B.		30°C D.B. 22°C W.B.		32°C D.B. 24°C W.B.	
	CA	SHC	CA	SHC	CA	SHC	CA	SHC	CA	SHC	CA	SHC	CA	SHC
20 (2.2)	2.0	1.8	2.0	1.9	2.2	1.9	2.2	2.0	2.3	2.0	2.4	2.0	2.6	2.0

* The capacity does not depend on the outdoor temperature.

kcal/h = kW x 860, BTU/h = kW x 3,412

2-4. Cooling capacity with PUHY-P400-650YSKB-A1, EP550-650YSLM-A

PEFY-P-VMA(L)-E

CA: Capacity (kW), SHC: Sensible Heat Capacity (kW)

Model size (Rated kW)	Indoor air temp.													
	21.5°C D.B. 15°C W.B.		23°C D.B. 16°C W.B.		25°C D.B. 18°C W.B.		27°C D.B. 19°C W.B.		28°C D.B. 20°C W.B.		30°C D.B. 22°C W.B.		32°C D.B. 24°C W.B.	
	CA	SHC	CA	SHC	CA	SHC	CA	SHC	CA	SHC	CA	SHC	CA	SHC
20 (2.2)	2.0	1.8	2.0	1.9	2.2	1.9	2.2	2.0	2.3	2.0	2.5	2.0	2.6	2.0
25 (2.8)	2.5	2.0	2.6	2.1	2.7	2.1	2.8	2.2	2.9	2.2	3.1	2.2	3.3	2.2
32 (3.6)	3.2	2.4	3.3	2.5	3.5	2.5	3.6	2.6	3.8	2.6	4.0	2.6	4.3	2.6
40 (4.5)	4.0	3.3	4.1	3.4	4.4	3.4	4.5	3.6	4.7	3.6	5.0	3.6	5.4	3.5
50 (5.6)	5.0	4.1	5.1	4.2	5.5	4.2	5.6	4.4	5.9	4.4	6.3	4.4	6.7	4.4
63 (7.1)	6.3	5.0	6.5	5.2	6.9	5.1	7.1	5.5	7.4	5.5	7.9	5.4	8.5	5.4
71 (8.0)	7.1	5.5	7.3	5.6	7.8	5.6	8.0	5.9	8.4	5.9	8.9	5.9	9.5	5.8
80 (9.0)	8.0	5.9	8.2	6.0	8.8	6.0	9.0	6.3	9.4	6.3	10.1	6.3	10.7	6.2
100 (11.2)	10.0	8.1	10.2	8.3	11.0	8.3	11.2	8.8	11.7	8.8	12.5	8.8	13.4	8.7
125 (14.0)	12.5	9.9	12.8	10.1	13.7	10.1	14.0	10.7	14.7	10.7	15.7	10.6	16.7	10.5
140 (16.0)	14.3	11.1	14.6	11.4	15.7	11.4	16.0	12.0	16.8	12.1	17.9	12.0	19.1	11.8

* The capacity does not depend on the outdoor temperature.

kcal/h = kW x 860, BTU/h = kW x 3,412

PEFY-P-VMA3-E

CA: Capacity (kW), SHC: Sensible Heat Capacity (kW)

Model size (Rated kW)	Indoor air temp.													
	21.5°C D.B. 15°C W.B.		23°C D.B. 16°C W.B.		25°C D.B. 18°C W.B.		27°C D.B. 19°C W.B.		28°C D.B. 20°C W.B.		30°C D.B. 22°C W.B.		32°C D.B. 24°C W.B.	
	CA	SHC	CA	SHC	CA	SHC	CA	SHC	CA	SHC	CA	SHC	CA	SHC
20 (2.2)	2.0	1.8	2.0	1.9	2.2	1.9	2.2	2.0	2.3	2.0	2.5	2.0	2.6	2.0

* The capacity does not depend on the outdoor temperature.

kcal/h = kW x 860, BTU/h = kW x 3,412

2. Cooling [Ceiling concealed (Middle static pressure type)]

YKB/YLM

CT

2-5. Cooling capacity with PUHY-P700-800YSKB-A1, EP700-800YSLM-A

PEFY-P-VMA(L)-E

CA: Capacity (kW), SHC: Sensible Heat Capacity (kW)

Model size (Rated kW)	Indoor air temp.													
	21.5°C D.B. 15°C W.B.		23°C D.B. 16°C W.B.		25°C D.B. 18°C W.B.		27°C D.B. 19°C W.B.		28°C D.B. 20°C W.B.		30°C D.B. 22°C W.B.		32°C D.B. 24°C W.B.	
	CA	SHC	CA	SHC	CA	SHC	CA	SHC	CA	SHC	CA	SHC	CA	SHC
20 (2.2)	1.9	1.8	2.0	1.9	2.1	1.8	2.2	2.0	2.3	2.0	2.4	2.0	2.6	1.9
25 (2.8)	2.5	2.0	2.5	2.1	2.7	2.1	2.8	2.2	2.9	2.2	3.1	2.2	3.3	2.1
32 (3.6)	3.2	2.4	3.3	2.5	3.5	2.5	3.6	2.6	3.7	2.6	4.0	2.6	4.2	2.6
40 (4.5)	3.9	3.3	4.1	3.4	4.4	3.4	4.5	3.6	4.7	3.6	5.0	3.6	5.3	3.5
50 (5.6)	4.9	4.0	5.1	4.2	5.4	4.1	5.6	4.4	5.8	4.4	6.2	4.4	6.6	4.3
63 (7.1)	6.2	5.0	6.4	5.1	6.9	5.1	7.1	5.5	7.4	5.4	7.9	5.4	8.3	5.3
71 (8.0)	7.0	5.4	7.2	5.6	7.8	5.6	8.0	5.9	8.3	5.9	8.8	5.8	9.4	5.7
80 (9.0)	7.9	5.8	8.1	6.0	8.7	5.9	9.0	6.3	9.3	6.3	10.0	6.2	10.6	6.1
100 (11.2)	9.8	8.0	10.1	8.3	10.9	8.3	11.2	8.8	11.6	8.8	12.4	8.7	13.2	8.6
125 (14.0)	12.3	9.7	12.7	10.1	13.6	10.0	14.0	10.7	14.5	10.7	15.5	10.5	16.5	10.4
140 (16.0)	14.0	11.0	14.5	11.4	15.5	11.3	16.0	12.0	16.6	12.0	17.7	11.9	18.8	11.7

* The capacity does not depend on the outdoor temperature.

kcal/h = kW x 860, BTU/h = kW x 3,412

PEFY-P-VMA3-E

CA: Capacity (kW), SHC: Sensible Heat Capacity (kW)

Model size (Rated kW)	Indoor air temp.													
	21.5°C D.B. 15°C W.B.		23°C D.B. 16°C W.B.		25°C D.B. 18°C W.B.		27°C D.B. 19°C W.B.		28°C D.B. 20°C W.B.		30°C D.B. 22°C W.B.		32°C D.B. 24°C W.B.	
	CA	SHC	CA	SHC	CA	SHC	CA	SHC	CA	SHC	CA	SHC	CA	SHC
20 (2.2)	1.9	1.8	2.0	1.9	2.1	1.9	2.2	2.0	2.3	2.0	2.4	2.0	2.6	2.0

* The capacity does not depend on the outdoor temperature.

kcal/h = kW x 860, BTU/h = kW x 3,412

2-6. Cooling capacity with PUHY-P850-1350YSKB-A1, EP850-1350YSLM-A

PEFY-P-VMA(L)-E

CA: Capacity (kW), SHC: Sensible Heat Capacity (kW)

Model size (Rated kW)	Indoor air temp.													
	21.5°C D.B. 15°C W.B.		23°C D.B. 16°C W.B.		25°C D.B. 18°C W.B.		27°C D.B. 19°C W.B.		28°C D.B. 20°C W.B.		30°C D.B. 22°C W.B.		32°C D.B. 24°C W.B.	
	CA	SHC	CA	SHC	CA	SHC	CA	SHC	CA	SHC	CA	SHC	CA	SHC
20 (2.2)	2.0	1.8	2.0	1.9	2.2	1.9	2.2	2.0	2.3	2.0	2.5	2.0	2.6	2.0
25 (2.8)	2.5	2.0	2.6	2.1	2.7	2.1	2.8	2.2	2.9	2.2	3.1	2.2	3.3	2.2
32 (3.6)	3.2	2.4	3.3	2.5	3.5	2.5	3.6	2.6	3.8	2.6	4.0	2.6	4.3	2.6
40 (4.5)	4.0	3.3	4.1	3.4	4.4	3.4	4.5	3.6	4.7	3.6	5.0	3.6	5.4	3.5
50 (5.6)	5.0	4.1	5.1	4.2	5.5	4.2	5.6	4.4	5.9	4.4	6.3	4.4	6.7	4.4
63 (7.1)	6.3	5.0	6.5	5.2	6.9	5.1	7.1	5.5	7.4	5.5	7.9	5.4	8.5	5.4
71 (8.0)	7.1	5.5	7.3	5.6	7.8	5.6	8.0	5.9	8.4	5.9	8.9	5.9	9.5	5.8
80 (9.0)	8.0	5.9	8.2	6.0	8.8	6.0	9.0	6.3	9.4	6.3	10.1	6.3	10.7	6.2
100 (11.2)	10.0	8.1	10.2	8.3	11.0	8.3	11.2	8.8	11.7	8.8	12.5	8.8	13.4	8.7
125 (14.0)	12.5	9.9	12.8	10.1	13.7	10.1	14.0	10.7	14.7	10.7	15.7	10.6	16.7	10.5
140 (16.0)	14.3	11.1	14.6	11.4	15.7	11.4	16.0	12.0	16.8	12.1	17.9	12.0	19.1	11.8

* The capacity does not depend on the outdoor temperature.

kcal/h = kW x 860, BTU/h = kW x 3,412

PEFY-P-VMA3-E

CA: Capacity (kW), SHC: Sensible Heat Capacity (kW)

Model size (Rated kW)	Indoor air temp.													
	21.5°C D.B. 15°C W.B.		23°C D.B. 16°C W.B.		25°C D.B. 18°C W.B.		27°C D.B. 19°C W.B.		28°C D.B. 20°C W.B.		30°C D.B. 22°C W.B.		32°C D.B. 24°C W.B.	
	CA	SHC	CA	SHC	CA	SHC	CA	SHC	CA	SHC	CA	SHC	CA	SHC
20 (2.2)	2.0	1.8	2.0	1.9	2.2	1.9	2.2	2.0	2.3	2.0	2.5	2.0	2.6	2.0

* The capacity does not depend on the outdoor temperature.

kcal/h = kW x 860, BTU/h = kW x 3,412

2. Cooling [Ceiling concealed (Middle static pressure type)]

YKB/YLM

2-7. Cooling capacity with PURY-(E)P200-250YLM-A(1)

PEFY-P-VMA(L)-E

CA: Capacity (kW), SHC: Sensible Heat Capacity (kW)

Model size (Rated kW)	Indoor air temp.													
	21.5°C D.B. 15°C W.B.		23°C D.B. 16°C W.B.		25°C D.B. 18°C W.B.		27°C D.B. 19°C W.B.		28°C D.B. 20°C W.B.		30°C D.B. 22°C W.B.		32°C D.B. 24°C W.B.	
	CA	SHC	CA	SHC	CA	SHC	CA	SHC	CA	SHC	CA	SHC	CA	SHC
20 (2.2)	2.0	1.8	2.0	1.9	2.2	1.9	2.2	2.0	2.3	2.0	2.4	2.0	2.6	1.9
25 (2.8)	2.5	2.0	2.6	2.1	2.8	2.1	2.8	2.2	2.9	2.2	3.1	2.2	3.2	2.1
32 (3.6)	3.2	2.5	3.3	2.5	3.5	2.5	3.6	2.6	3.7	2.6	3.9	2.6	4.2	2.6
40 (4.5)	4.1	3.3	4.2	3.4	4.4	3.4	4.5	3.6	4.7	3.6	4.9	3.5	5.2	3.5
50 (5.6)	5.0	4.1	5.2	4.2	5.5	4.2	5.6	4.4	5.8	4.4	6.1	4.4	6.5	4.3
63 (7.1)	6.4	5.1	6.6	5.2	7.0	5.2	7.1	5.5	7.4	5.4	7.8	5.4	8.2	5.3
71 (8.0)	7.2	5.5	7.4	5.7	7.9	5.6	8.0	5.9	8.3	5.9	8.7	5.8	9.3	5.7
80 (9.0)	8.1	5.9	8.4	6.1	8.9	6.0	9.0	6.3	9.3	6.3	9.8	6.2	10.4	6.1
100 (11.2)	10.1	8.1	10.4	8.4	11.0	8.3	11.2	8.8	11.6	8.8	12.2	8.7	13.0	8.5
125 (14.0)	12.6	9.9	13.0	10.2	13.8	10.1	14.0	10.7	14.5	10.7	15.3	10.5	16.2	10.3
140 (16.0)	14.4	11.2	14.9	11.5	15.7	11.4	16.0	12.0	16.6	12.0	17.5	11.8	18.6	11.7

* The capacity does not depend on the outdoor temperature.

kcal/h = kW x 860, BTU/h = kW x 3,412

PEFY-P-VMA3-E

CA: Capacity (kW), SHC: Sensible Heat Capacity (kW)

Model size (Rated kW)	Indoor air temp.													
	21.5°C D.B. 15°C W.B.		23°C D.B. 16°C W.B.		25°C D.B. 18°C W.B.		27°C D.B. 19°C W.B.		28°C D.B. 20°C W.B.		30°C D.B. 22°C W.B.		32°C D.B. 24°C W.B.	
	CA	SHC	CA	SHC	CA	SHC	CA	SHC	CA	SHC	CA	SHC	CA	SHC
20 (2.2)	2.0	1.8	2.0	1.9	2.2	1.9	2.2	2.0	2.3	2.0	2.4	2.0	2.6	2.0

* The capacity does not depend on the outdoor temperature.

kcal/h = kW x 860, BTU/h = kW x 3,412

2-8. Cooling capacity with PURY-(E)P300-400Y(S)LM-A(1)

PEFY-P-VMA(L)-E

CA: Capacity (kW), SHC: Sensible Heat Capacity (kW)

Model size (Rated kW)	Indoor air temp.													
	21.5°C D.B. 15°C W.B.		23°C D.B. 16°C W.B.		25°C D.B. 18°C W.B.		27°C D.B. 19°C W.B.		28°C D.B. 20°C W.B.		30°C D.B. 22°C W.B.		32°C D.B. 24°C W.B.	
	CA	SHC	CA	SHC	CA	SHC	CA	SHC	CA	SHC	CA	SHC	CA	SHC
20 (2.2)	2.0	1.8	2.0	1.9	2.2	1.9	2.2	2.0	2.3	2.0	2.4	2.0	2.6	1.9
25 (2.8)	2.5	2.0	2.6	2.1	2.7	2.1	2.8	2.2	2.9	2.2	3.1	2.2	3.3	2.1
32 (3.6)	3.2	2.5	3.3	2.5	3.5	2.5	3.6	2.6	3.8	2.6	4.0	2.6	4.2	2.6
40 (4.5)	4.1	3.3	4.1	3.4	4.4	3.4	4.5	3.6	4.7	3.6	5.0	3.6	5.3	3.5
50 (5.6)	5.0	4.1	5.1	4.2	5.5	4.2	5.6	4.4	5.8	4.4	6.2	4.4	6.6	4.3
63 (7.1)	6.4	5.1	6.5	5.2	6.9	5.1	7.1	5.5	7.4	5.5	7.9	5.4	8.4	5.3
71 (8.0)	7.2	5.5	7.3	5.6	7.8	5.6	8.0	5.9	8.3	5.9	8.9	5.8	9.4	5.8
80 (9.0)	8.1	5.9	8.3	6.0	8.8	6.0	9.0	6.3	9.4	6.3	10.0	6.2	10.6	6.1
100 (11.2)	10.1	8.1	10.3	8.4	11.0	8.3	11.2	8.8	11.7	8.8	12.4	8.7	13.2	8.6
125 (14.0)	12.6	9.9	12.8	10.1	13.7	10.1	14.0	10.7	14.6	10.7	15.5	10.6	16.5	10.4
140 (16.0)	14.4	11.2	14.7	11.5	15.7	11.4	16.0	12.0	16.7	12.1	17.7	11.9	18.8	11.7

* The capacity does not depend on the outdoor temperature.

kcal/h = kW x 860, BTU/h = kW x 3,412

PEFY-P-VMA3-E

CA: Capacity (kW), SHC: Sensible Heat Capacity (kW)

Model size (Rated kW)	Indoor air temp.													
	21.5°C D.B. 15°C W.B.		23°C D.B. 16°C W.B.		25°C D.B. 18°C W.B.		27°C D.B. 19°C W.B.		28°C D.B. 20°C W.B.		30°C D.B. 22°C W.B.		32°C D.B. 24°C W.B.	
	CA	SHC	CA	SHC	CA	SHC	CA	SHC	CA	SHC	CA	SHC	CA	SHC
20 (2.2)	2.0	1.8	2.0	1.9	2.2	1.9	2.2	2.0	2.3	2.0	2.4	2.0	2.6	2.0

* The capacity does not depend on the outdoor temperature.

kcal/h = kW x 860, BTU/h = kW x 3,412

2. Cooling [Ceiling concealed (Middle static pressure type)]

YKB/YLM

CT

2-9. Cooling capacity with PURY-(E)P450-650Y(S)LM-A(1)

PEFY-P-VMA(L)-E

CA: Capacity (kW), SHC: Sensible Heat Capacity (kW)

Model size (Rated kW)	Indoor air temp.													
	21.5°C D.B. 15°C W.B.		23°C D.B. 16°C W.B.		25°C D.B. 18°C W.B.		27°C D.B. 19°C W.B.		28°C D.B. 20°C W.B.		30°C D.B. 22°C W.B.		32°C D.B. 24°C W.B.	
	CA	SHC	CA	SHC	CA	SHC	CA	SHC	CA	SHC	CA	SHC	CA	SHC
20 (2.2)	2.0	1.8	2.0	1.9	2.2	1.9	2.2	2.0	2.3	2.0	2.5	2.0	2.6	2.0
25 (2.8)	2.5	2.0	2.6	2.1	2.7	2.1	2.8	2.2	2.9	2.2	3.1	2.2	3.3	2.2
32 (3.6)	3.2	2.4	3.3	2.5	3.5	2.5	3.6	2.6	3.8	2.6	4.0	2.6	4.3	2.6
40 (4.5)	4.0	3.3	4.1	3.4	4.4	3.4	4.5	3.6	4.7	3.6	5.0	3.6	5.4	3.5
50 (5.6)	5.0	4.1	5.1	4.2	5.5	4.2	5.6	4.4	5.9	4.4	6.3	4.4	6.7	4.4
63 (7.1)	6.3	5.0	6.5	5.2	6.9	5.1	7.1	5.5	7.4	5.5	7.9	5.4	8.5	5.4
71 (8.0)	7.1	5.5	7.3	5.6	7.8	5.6	8.0	5.9	8.4	5.9	8.9	5.9	9.5	5.8
80 (9.0)	8.0	5.9	8.2	6.0	8.8	6.0	9.0	6.3	9.4	6.3	10.1	6.3	10.7	6.2
100 (11.2)	10.0	8.1	10.2	8.3	11.0	8.3	11.2	8.8	11.7	8.8	12.5	8.8	13.4	8.7
125 (14.0)	12.5	9.9	12.8	10.1	13.7	10.1	14.0	10.7	14.7	10.7	15.7	10.6	16.7	10.5
140 (16.0)	14.3	11.1	14.6	11.4	15.7	11.4	16.0	12.0	16.8	12.1	17.9	12.0	19.1	11.8

* The capacity does not depend on the outdoor temperature.

kcal/h = kW x 860, BTU/h = kW x 3,412

PEFY-P-VMA3-E

CA: Capacity (kW), SHC: Sensible Heat Capacity (kW)

Model size (Rated kW)	Indoor air temp.													
	21.5°C D.B. 15°C W.B.		23°C D.B. 16°C W.B.		25°C D.B. 18°C W.B.		27°C D.B. 19°C W.B.		28°C D.B. 20°C W.B.		30°C D.B. 22°C W.B.		32°C D.B. 24°C W.B.	
	CA	SHC	CA	SHC	CA	SHC	CA	SHC	CA	SHC	CA	SHC	CA	SHC
20 (2.2)	2.0	1.8	2.0	1.9	2.2	1.9	2.2	2.0	2.3	2.0	2.5	2.0	2.6	2.0

* The capacity does not depend on the outdoor temperature.

kcal/h = kW x 860, BTU/h = kW x 3,412

2-10. Cooling capacity with PURY-(E)P700-800YSLM-A(1)

PEFY-P-VMA(L)-E

CA: Capacity (kW), SHC: Sensible Heat Capacity (kW)

Model size (Rated kW)	Indoor air temp.													
	21.5°C D.B. 15°C W.B.		23°C D.B. 16°C W.B.		25°C D.B. 18°C W.B.		27°C D.B. 19°C W.B.		28°C D.B. 20°C W.B.		30°C D.B. 22°C W.B.		32°C D.B. 24°C W.B.	
	CA	SHC	CA	SHC	CA	SHC	CA	SHC	CA	SHC	CA	SHC	CA	SHC
20 (2.2)	1.9	1.8	2.0	1.9	2.1	1.8	2.2	2.0	2.3	2.0	2.4	2.0	2.6	1.9
25 (2.8)	2.5	2.0	2.5	2.1	2.7	2.1	2.8	2.2	2.9	2.2	3.1	2.2	3.3	2.1
32 (3.6)	3.2	2.4	3.3	2.5	3.5	2.5	3.6	2.6	3.7	2.6	4.0	2.6	4.2	2.6
40 (4.5)	3.9	3.3	4.1	3.4	4.4	3.4	4.5	3.6	4.7	3.6	5.0	3.6	5.3	3.5
50 (5.6)	4.9	4.0	5.1	4.2	5.4	4.1	5.6	4.4	5.8	4.4	6.2	4.4	6.6	4.3
63 (7.1)	6.2	5.0	6.4	5.1	6.9	5.1	7.1	5.5	7.4	5.4	7.9	5.4	8.3	5.3
71 (8.0)	7.0	5.4	7.2	5.6	7.8	5.6	8.0	5.9	8.3	5.9	8.8	5.8	9.4	5.7
80 (9.0)	7.9	5.8	8.1	6.0	8.7	5.9	9.0	6.3	9.3	6.3	10.0	6.2	10.6	6.1
100 (11.2)	9.8	8.0	10.1	8.3	10.9	8.3	11.2	8.8	11.6	8.8	12.4	8.7	13.2	8.6
125 (14.0)	12.3	9.7	12.7	10.1	13.6	10.0	14.0	10.7	14.5	10.7	15.5	10.5	16.5	10.4
140 (16.0)	14.0	11.0	14.5	11.4	15.5	11.3	16.0	12.0	16.6	12.0	17.7	11.9	18.8	11.7

* The capacity does not depend on the outdoor temperature.

kcal/h = kW x 860, BTU/h = kW x 3,412

PEFY-P-VMA3-E

CA: Capacity (kW), SHC: Sensible Heat Capacity (kW)

Model size (Rated kW)	Indoor air temp.													
	21.5°C D.B. 15°C W.B.		23°C D.B. 16°C W.B.		25°C D.B. 18°C W.B.		27°C D.B. 19°C W.B.		28°C D.B. 20°C W.B.		30°C D.B. 22°C W.B.		32°C D.B. 24°C W.B.	
	CA	SHC	CA	SHC	CA	SHC	CA	SHC	CA	SHC	CA	SHC	CA	SHC
20 (2.2)	1.9	1.8	2.0	1.9	2.1	1.9	2.2	2.0	2.3	2.0	2.4	2.0	2.6	2.0

* The capacity does not depend on the outdoor temperature.

kcal/h = kW x 860, BTU/h = kW x 3,412

2. Cooling [Ceiling concealed (Middle static pressure type)]

YKB/YLM

2-11. Cooling capacity with PURY-(E)P850-900YSLM-A(1)

PEFY-P-VMA(L)-E

CA: Capacity (kW), SHC: Sensible Heat Capacity (kW)

Model size (Rated kW)	Indoor air temp.													
	21.5°C D.B. 15°C W.B.		23°C D.B. 16°C W.B.		25°C D.B. 18°C W.B.		27°C D.B. 19°C W.B.		28°C D.B. 20°C W.B.		30°C D.B. 22°C W.B.		32°C D.B. 24°C W.B.	
	CA	SHC	CA	SHC	CA	SHC	CA	SHC	CA	SHC	CA	SHC	CA	SHC
20 (2.2)	2.0	1.8	2.0	1.9	2.2	1.9	2.2	2.0	2.3	2.0	2.5	2.0	2.6	2.0
25 (2.8)	2.5	2.0	2.6	2.1	2.7	2.1	2.8	2.2	2.9	2.2	3.1	2.2	3.3	2.2
32 (3.6)	3.2	2.4	3.3	2.5	3.5	2.5	3.6	2.6	3.8	2.6	4.0	2.6	4.3	2.6
40 (4.5)	4.0	3.3	4.1	3.4	4.4	3.4	4.5	3.6	4.7	3.6	5.0	3.6	5.4	3.5
50 (5.6)	5.0	4.1	5.1	4.2	5.5	4.2	5.6	4.4	5.9	4.4	6.3	4.4	6.7	4.4
63 (7.1)	6.3	5.0	6.5	5.2	6.9	5.1	7.1	5.5	7.4	5.5	7.9	5.4	8.5	5.4
71 (8.0)	7.1	5.5	7.3	5.6	7.8	5.6	8.0	5.9	8.4	5.9	8.9	5.9	9.5	5.8
80 (9.0)	8.0	5.9	8.2	6.0	8.8	6.0	9.0	6.3	9.4	6.3	10.1	6.3	10.7	6.2
100 (11.2)	10.0	8.1	10.2	8.3	11.0	8.3	11.2	8.8	11.7	8.8	12.5	8.8	13.4	8.7
125 (14.0)	12.5	9.9	12.8	10.1	13.7	10.1	14.0	10.7	14.7	10.7	15.7	10.6	16.7	10.5
140 (16.0)	14.3	11.1	14.6	11.4	15.7	11.4	16.0	12.0	16.8	12.1	17.9	12.0	19.1	11.8

* The capacity does not depend on the outdoor temperature.

kcal/h = kW x 860, BTU/h = kW x 3,412

PEFY-P-VMA3-E

CA: Capacity (kW), SHC: Sensible Heat Capacity (kW)

Model size (Rated kW)	Indoor air temp.													
	21.5°C D.B. 15°C W.B.		23°C D.B. 16°C W.B.		25°C D.B. 18°C W.B.		27°C D.B. 19°C W.B.		28°C D.B. 20°C W.B.		30°C D.B. 22°C W.B.		32°C D.B. 24°C W.B.	
	CA	SHC	CA	SHC	CA	SHC	CA	SHC	CA	SHC	CA	SHC	CA	SHC
20 (2.2)	2.0	1.8	2.0	1.9	2.2	1.9	2.2	2.0	2.3	2.0	2.5	2.0	2.6	2.0

* The capacity does not depend on the outdoor temperature.

kcal/h = kW x 860, BTU/h = kW x 3,412

3. Cooling [Ceiling cassette (1-way flow type)]

YKB/YLM

CT

3-1. Cooling capacity with PUHY-P200-250YKB-A1, EP200-250YLM-A

PMFY-P-VBM-E

CA: Capacity (kW), SHC: Sensible Heat Capacity (kW)

Model size (Rated kW)	Indoor air temp.													
	21.5°C D.B. 15°C W.B.		23°C D.B. 16°C W.B.		25°C D.B. 18°C W.B.		27°C D.B. 19°C W.B.		28°C D.B. 20°C W.B.		30°C D.B. 22°C W.B.		32°C D.B. 24°C W.B.	
	CA	SHC	CA	SHC	CA	SHC	CA	SHC	CA	SHC	CA	SHC	CA	SHC
20 (2.2)	2.0	1.8	2.0	1.8	2.2	1.8	2.2	1.9	2.3	1.9	2.4	1.9	2.6	1.9
25 (2.8)	2.5	2.2	2.6	2.2	2.8	2.2	2.8	2.4	2.9	2.4	3.1	2.3	3.2	2.3
32 (3.6)	3.2	2.5	3.3	2.6	3.5	2.5	3.6	2.7	3.7	2.7	3.9	2.6	4.2	2.6
40 (4.5)	4.1	3.0	4.2	3.1	4.4	3.1	4.5	3.2	4.7	3.2	4.9	3.2	5.2	3.1

* The capacity does not depend on the outdoor temperature.

kcal/h = kW x 860, BTU/h = kW x 3,412

3-2. Cooling capacity with PUHY-P300-400YKB-A1, EP300-350YLM-A

PMFY-P-VBM-E

CA: Capacity (kW), SHC: Sensible Heat Capacity (kW)

Model size (Rated kW)	Indoor air temp.													
	21.5°C D.B. 15°C W.B.		23°C D.B. 16°C W.B.		25°C D.B. 18°C W.B.		27°C D.B. 19°C W.B.		28°C D.B. 20°C W.B.		30°C D.B. 22°C W.B.		32°C D.B. 24°C W.B.	
	CA	SHC	CA	SHC	CA	SHC	CA	SHC	CA	SHC	CA	SHC	CA	SHC
20 (2.2)	2.0	1.8	2.0	1.8	2.2	1.8	2.2	1.9	2.3	1.9	2.4	1.9	2.6	1.9
25 (2.8)	2.5	2.2	2.6	2.2	2.8	2.2	2.8	2.4	2.9	2.4	3.1	2.3	3.2	2.3
32 (3.6)	3.2	2.5	3.3	2.6	3.5	2.5	3.6	2.7	3.7	2.7	3.9	2.6	4.2	2.6
40 (4.5)	4.1	3.0	4.2	3.1	4.4	3.1	4.5	3.2	4.7	3.2	4.9	3.2	5.2	3.1

* The capacity does not depend on the outdoor temperature.

kcal/h = kW x 860, BTU/h = kW x 3,412

3-3. Cooling capacity with PUHY-P450-500YKB-A1, EP400-500YLM-A

PMFY-P-VBM-E

CA: Capacity (kW), SHC: Sensible Heat Capacity (kW)

Model size (Rated kW)	Indoor air temp.													
	21.5°C D.B. 15°C W.B.		23°C D.B. 16°C W.B.		25°C D.B. 18°C W.B.		27°C D.B. 19°C W.B.		28°C D.B. 20°C W.B.		30°C D.B. 22°C W.B.		32°C D.B. 24°C W.B.	
	CA	SHC	CA	SHC	CA	SHC	CA	SHC	CA	SHC	CA	SHC	CA	SHC
20 (2.2)	2.0	1.8	2.0	1.8	2.2	1.8	2.2	1.9	2.3	1.9	2.4	1.9	2.6	1.9
25 (2.8)	2.5	2.2	2.6	2.2	2.7	2.2	2.8	2.4	2.9	2.4	3.1	2.3	3.3	2.3
32 (3.6)	3.2	2.5	3.3	2.5	3.5	2.5	3.6	2.7	3.8	2.7	4.0	2.6	4.2	2.6
40 (4.5)	4.1	3.0	4.1	3.1	4.4	3.1	4.5	3.2	4.7	3.2	5.0	3.2	5.3	3.2

* The capacity does not depend on the outdoor temperature.

kcal/h = kW x 860, BTU/h = kW x 3,412

3-4. Cooling capacity with PUHY-P400-650YSKB-A1, EP550-650YSLM-A

PMFY-P-VBM-E

CA: Capacity (kW), SHC: Sensible Heat Capacity (kW)

Model size (Rated kW)	Indoor air temp.													
	21.5°C D.B. 15°C W.B.		23°C D.B. 16°C W.B.		25°C D.B. 18°C W.B.		27°C D.B. 19°C W.B.		28°C D.B. 20°C W.B.		30°C D.B. 22°C W.B.		32°C D.B. 24°C W.B.	
	CA	SHC	CA	SHC	CA	SHC	CA	SHC	CA	SHC	CA	SHC	CA	SHC
20 (2.2)	2.0	1.8	2.0	1.8	2.2	1.8	2.2	1.9	2.3	1.9	2.5	1.9	2.6	1.9
25 (2.8)	2.5	2.1	2.6	2.2	2.7	2.2	2.8	2.4	2.9	2.4	3.1	2.3	3.3	2.3
32 (3.6)	3.2	2.5	3.3	2.5	3.5	2.5	3.6	2.7	3.8	2.7	4.0	2.6	4.3	2.6
40 (4.5)	4.0	3.0	4.1	3.1	4.4	3.1	4.5	3.2	4.7	3.3	5.0	3.2	5.4	3.2

* The capacity does not depend on the outdoor temperature.

kcal/h = kW x 860, BTU/h = kW x 3,412

3-5. Cooling capacity with PUHY-P700-800YSKB-A1, EP700-800YSLM-A

PMFY-P-VBM-E

CA: Capacity (kW), SHC: Sensible Heat Capacity (kW)

Model size (Rated kW)	Indoor air temp.													
	21.5°C D.B. 15°C W.B.		23°C D.B. 16°C W.B.		25°C D.B. 18°C W.B.		27°C D.B. 19°C W.B.		28°C D.B. 20°C W.B.		30°C D.B. 22°C W.B.		32°C D.B. 24°C W.B.	
	CA	SHC	CA	SHC	CA	SHC	CA	SHC	CA	SHC	CA	SHC	CA	SHC
20 (2.2)	1.9	1.7	2.0	1.8	2.1	1.8	2.2	1.9	2.3	1.9	2.4	1.9	2.6	1.9
25 (2.8)	2.5	2.1	2.5	2.2	2.7	2.2	2.8	2.4	2.9	2.4	3.1	2.3	3.3	2.3
32 (3.6)	3.2	2.4	3.3	2.5	3.5	2.5	3.6	2.7	3.7	2.7	4.0	2.6	4.2	2.6
40 (4.5)	3.9	3.0	4.1	3.1	4.4	3.1	4.5	3.2	4.7	3.2	5.0	3.2	5.3	3.2

* The capacity does not depend on the outdoor temperature.

kcal/h = kW x 860, BTU/h = kW x 3,412

3. Cooling [Ceiling cassette (1-way flow type)]

YKB/YLM

CT

3-6. Cooling capacity with PUHY-PUHY-P850-1350YSKB-A1, EP850-1350YSLM-A

PMFY-P-VBM-E

CA: Capacity (kW), SHC: Sensible Heat Capacity (kW)

Model size (Rated kW)	Indoor air temp.													
	21.5°C D.B. 15°C W.B.		23°C D.B. 16°C W.B.		25°C D.B. 18°C W.B.		27°C D.B. 19°C W.B.		28°C D.B. 20°C W.B.		30°C D.B. 22°C W.B.		32°C D.B. 24°C W.B.	
	CA	SHC	CA	SHC	CA	SHC	CA	SHC	CA	SHC	CA	SHC	CA	SHC
20 (2.2)	2.0	1.8	2.0	1.8	2.2	1.8	2.2	1.9	2.3	1.9	2.5	1.9	2.6	1.9
25 (2.8)	2.5	2.1	2.6	2.2	2.7	2.2	2.8	2.4	2.9	2.4	3.1	2.3	3.3	2.3
32 (3.6)	3.2	2.5	3.3	2.5	3.5	2.5	3.6	2.7	3.8	2.7	4.0	2.6	4.3	2.6
40 (4.5)	4.0	3.0	4.1	3.1	4.4	3.1	4.5	3.2	4.7	3.3	5.0	3.2	5.4	3.2

* The capacity does not depend on the outdoor temperature.

kcal/h = kW x 860, BTU/h = kW x 3,412

3-7. Cooling capacity with PURY-(E)P200-250YLM-A(1)

PMFY-P-VBM-E

CA: Capacity (kW), SHC: Sensible Heat Capacity (kW)

Model size (Rated kW)	Indoor air temp.													
	21.5°C D.B. 15°C W.B.		23°C D.B. 16°C W.B.		25°C D.B. 18°C W.B.		27°C D.B. 19°C W.B.		28°C D.B. 20°C W.B.		30°C D.B. 22°C W.B.		32°C D.B. 24°C W.B.	
	CA	SHC	CA	SHC	CA	SHC	CA	SHC	CA	SHC	CA	SHC	CA	SHC
20 (2.2)	2.0	1.8	2.0	1.8	2.2	1.8	2.2	1.9	2.3	1.9	2.4	1.9	2.6	1.9
25 (2.8)	2.5	2.2	2.6	2.2	2.8	2.2	2.8	2.4	2.9	2.4	3.1	2.3	3.2	2.3
32 (3.6)	3.2	2.5	3.3	2.6	3.5	2.5	3.6	2.7	3.7	2.7	3.9	2.6	4.2	2.6
40 (4.5)	4.1	3.0	4.2	3.1	4.4	3.1	4.5	3.2	4.7	3.2	4.9	3.2	5.2	3.1

* The capacity does not depend on the outdoor temperature.

kcal/h = kW x 860, BTU/h = kW x 3,412

3-8. Cooling capacity with PURY-(E)P300-400Y(S)LM-A(1)

PMFY-P-VBM-E

CA: Capacity (kW), SHC: Sensible Heat Capacity (kW)

Model size (Rated kW)	Indoor air temp.													
	21.5°C D.B. 15°C W.B.		23°C D.B. 16°C W.B.		25°C D.B. 18°C W.B.		27°C D.B. 19°C W.B.		28°C D.B. 20°C W.B.		30°C D.B. 22°C W.B.		32°C D.B. 24°C W.B.	
	CA	SHC	CA	SHC	CA	SHC	CA	SHC	CA	SHC	CA	SHC	CA	SHC
20 (2.2)	2.0	1.8	2.0	1.8	2.2	1.8	2.2	1.9	2.3	1.9	2.4	1.9	2.6	1.9
25 (2.8)	2.5	2.2	2.6	2.2	2.7	2.2	2.8	2.4	2.9	2.4	3.1	2.3	3.3	2.3
32 (3.6)	3.2	2.5	3.3	2.5	3.5	2.5	3.6	2.7	3.8	2.7	4.0	2.6	4.2	2.6
40 (4.5)	4.1	3.0	4.1	3.1	4.4	3.1	4.5	3.2	4.7	3.2	5.0	3.2	5.3	3.2

* The capacity does not depend on the outdoor temperature.

kcal/h = kW x 860, BTU/h = kW x 3,412

3-9. Cooling capacity with PURY-(E)P450-650Y(S)LM-A(1)

PMFY-P-VBM-E

CA: Capacity (kW), SHC: Sensible Heat Capacity (kW)

Model size (Rated kW)	Indoor air temp.													
	21.5°C D.B. 15°C W.B.		23°C D.B. 16°C W.B.		25°C D.B. 18°C W.B.		27°C D.B. 19°C W.B.		28°C D.B. 20°C W.B.		30°C D.B. 22°C W.B.		32°C D.B. 24°C W.B.	
	CA	SHC	CA	SHC	CA	SHC	CA	SHC	CA	SHC	CA	SHC	CA	SHC
20 (2.2)	2.0	1.8	2.0	1.8	2.2	1.8	2.2	1.9	2.3	1.9	2.5	1.9	2.6	1.9
25 (2.8)	2.5	2.1	2.6	2.2	2.7	2.2	2.8	2.4	2.9	2.4	3.1	2.3	3.3	2.3
32 (3.6)	3.2	2.5	3.3	2.5	3.5	2.5	3.6	2.7	3.8	2.7	4.0	2.6	4.3	2.6
40 (4.5)	4.0	3.0	4.1	3.1	4.4	3.1	4.5	3.2	4.7	3.3	5.0	3.2	5.4	3.2

* The capacity does not depend on the outdoor temperature.

kcal/h = kW x 860, BTU/h = kW x 3,412

3-10. Cooling capacity with PURY-(E)P700-800YSLM-A(1)

PMFY-P-VBM-E

CA: Capacity (kW), SHC: Sensible Heat Capacity (kW)

Model size (Rated kW)	Indoor air temp.													
	21.5°C D.B. 15°C W.B.		23°C D.B. 16°C W.B.		25°C D.B. 18°C W.B.		27°C D.B. 19°C W.B.		28°C D.B. 20°C W.B.		30°C D.B. 22°C W.B.		32°C D.B. 24°C W.B.	
	CA	SHC	CA	SHC	CA	SHC	CA	SHC	CA	SHC	CA	SHC	CA	SHC
20 (2.2)	1.9	1.7	2.0	1.8	2.1	1.8	2.2	1.9	2.3	1.9	2.4	1.9	2.6	1.9
25 (2.8)	2.5	2.1	2.5	2.2	2.7	2.2	2.8	2.4	2.9	2.4	3.1	2.3	3.3	2.3
32 (3.6)	3.2	2.4	3.3	2.5	3.5	2.5	3.6	2.7	3.7	2.7	4.0	2.6	4.2	2.6
40 (4.5)	3.9	3.0	4.1	3.1	4.4	3.1	4.5	3.2	4.7	3.2	5.0	3.2	5.3	3.2

* The capacity does not depend on the outdoor temperature.

kcal/h = kW x 860, BTU/h = kW x 3,412

3. Cooling [Ceiling cassette (1-way flow type)]

YKB/YLM

3-11. Cooling capacity with PURY-(E)P850-900YSLM-A(1)

PMFY-P-VBM-E

CA: Capacity (kW), SHC: Sensible Heat Capacity (kW)

Model size (Rated kW)	Indoor air temp.													
	21.5°C D.B. 15°C W.B.		23°C D.B. 16°C W.B.		25°C D.B. 18°C W.B.		27°C D.B. 19°C W.B.		28°C D.B. 20°C W.B.		30°C D.B. 22°C W.B.		32°C D.B. 24°C W.B.	
	CA	SHC	CA	SHC	CA	SHC	CA	SHC	CA	SHC	CA	SHC	CA	SHC
20 (2.2)	2.0	1.8	2.0	1.8	2.2	1.8	2.2	1.9	2.3	1.9	2.5	1.9	2.6	1.9
25 (2.8)	2.5	2.1	2.6	2.2	2.7	2.2	2.8	2.4	2.9	2.4	3.1	2.3	3.3	2.3
32 (3.6)	3.2	2.5	3.3	2.5	3.5	2.5	3.6	2.7	3.8	2.7	4.0	2.6	4.3	2.6
40 (4.5)	4.0	3.0	4.1	3.1	4.4	3.1	4.5	3.2	4.7	3.3	5.0	3.2	5.4	3.2

* The capacity does not depend on the outdoor temperature.

kcal/h = kW x 860, BTU/h = kW x 3,412

CT

4. Cooling [Ceiling cassette (2-way flow type)]

YKB/YLM

4-1. Cooling capacity with PUHY-P200-250YKB-A1, EP200-250YLM-A

PLFY-P-VLMD-E

CA: Capacity (kW), SHC: Sensible Heat Capacity (kW)

Model size (Rated kW)	Indoor air temp.													
	21.5°C D.B. 15°C W.B.		23°C D.B. 16°C W.B.		25°C D.B. 18°C W.B.		27°C D.B. 19°C W.B.		28°C D.B. 20°C W.B.		30°C D.B. 22°C W.B.		32°C D.B. 24°C W.B.	
	CA	SHC	CA	SHC	CA	SHC	CA	SHC	CA	SHC	CA	SHC	CA	SHC
20 (2.2)	2.0	1.8	2.0	1.9	2.2	1.9	2.2	2.0	2.3	2.0	2.4	2.0	2.6	1.9
25 (2.8)	2.5	2.1	2.6	2.1	2.8	2.1	2.8	2.2	2.9	2.2	3.1	2.2	3.2	2.2
32 (3.6)	3.2	2.5	3.3	2.5	3.5	2.5	3.6	2.6	3.7	2.6	3.9	2.6	4.2	2.6
40 (4.5)	4.1	2.9	4.2	2.9	4.4	2.9	4.5	3.0	4.7	3.0	4.9	3.0	5.2	2.9
50 (5.6)	5.0	3.7	5.2	3.8	5.5	3.7	5.6	3.9	5.8	3.9	6.1	3.8	6.5	3.8
63 (7.1)	6.4	4.5	6.6	4.7	7.0	4.6	7.1	4.8	7.4	4.8	7.8	4.7	8.2	4.7
80 (9.0)	8.1	6.0	8.4	6.2	8.9	6.1	9.0	6.4	9.3	6.4	9.8	6.3	10.4	6.2
100 (11.2)	10.1	7.4	10.4	7.6	11.0	7.5	11.2	7.9	11.6	7.9	12.2	7.7	13.0	7.6
125 (14.0)	12.6	9.4	13.0	9.7	13.8	9.6	14.0	10.1	14.5	10.0	15.3	9.9	16.2	9.7

* The capacity does not depend on the outdoor temperature.

kcal/h = kW x 860, BTU/h = kW x 3,412

4-2. Cooling capacity with PUHY-P300-400YKB-A1, EP300-350YLM-A

PLFY-P-VLMD-E

CA: Capacity (kW), SHC: Sensible Heat Capacity (kW)

Model size (Rated kW)	Indoor air temp.													
	21.5°C D.B. 15°C W.B.		23°C D.B. 16°C W.B.		25°C D.B. 18°C W.B.		27°C D.B. 19°C W.B.		28°C D.B. 20°C W.B.		30°C D.B. 22°C W.B.		32°C D.B. 24°C W.B.	
	CA	SHC	CA	SHC	CA	SHC	CA	SHC	CA	SHC	CA	SHC	CA	SHC
20 (2.2)	2.0	1.8	2.0	1.9	2.2	1.9	2.2	2.0	2.3	2.0	2.4	2.0	2.6	1.9
25 (2.8)	2.5	2.1	2.6	2.1	2.8	2.1	2.8	2.2	2.9	2.2	3.1	2.2	3.2	2.2
32 (3.6)	3.2	2.5	3.3	2.5	3.5	2.5	3.6	2.6	3.7	2.6	3.9	2.6	4.2	2.6
40 (4.5)	4.1	2.9	4.2	2.9	4.4	2.9	4.5	3.0	4.7	3.0	4.9	3.0	5.2	2.9
50 (5.6)	5.0	3.7	5.2	3.8	5.5	3.7	5.6	3.9	5.8	3.9	6.1	3.8	6.5	3.8
63 (7.1)	6.4	4.5	6.6	4.7	7.0	4.6	7.1	4.8	7.4	4.8	7.8	4.7	8.2	4.7
80 (9.0)	8.1	6.0	8.4	6.2	8.9	6.1	9.0	6.4	9.3	6.4	9.8	6.3	10.4	6.2
100 (11.2)	10.1	7.4	10.4	7.6	11.0	7.5	11.2	7.9	11.6	7.9	12.2	7.7	13.0	7.6
125 (14.0)	12.6	9.4	13.0	9.7	13.8	9.6	14.0	10.1	14.5	10.0	15.3	9.9	16.2	9.7

* The capacity does not depend on the outdoor temperature.

kcal/h = kW x 860, BTU/h = kW x 3,412

4-3. Cooling capacity with PUHY-P450-500YKB-A1, EP400-500YLM-A

PLFY-P-VLMD-E

CA: Capacity (kW), SHC: Sensible Heat Capacity (kW)

Model size (Rated kW)	Indoor air temp.													
	21.5°C D.B. 15°C W.B.		23°C D.B. 16°C W.B.		25°C D.B. 18°C W.B.		27°C D.B. 19°C W.B.		28°C D.B. 20°C W.B.		30°C D.B. 22°C W.B.		32°C D.B. 24°C W.B.	
	CA	SHC	CA	SHC	CA	SHC	CA	SHC	CA	SHC	CA	SHC	CA	SHC
20 (2.2)	2.0	1.8	2.0	1.9	2.2	1.9	2.2	2.0	2.3	2.0	2.4	2.0	2.6	2.0
25 (2.8)	2.5	2.1	2.6	2.1	2.7	2.1	2.8	2.2	2.9	2.2	3.1	2.2	3.3	2.2
32 (3.6)	3.2	2.5	3.3	2.5	3.5	2.5	3.6	2.6	3.8	2.6	4.0	2.6	4.2	2.6
40 (4.5)	4.1	2.9	4.1	2.9	4.4	2.9	4.5	3.0	4.7	3.0	5.0	3.0	5.3	3.0
50 (5.6)	5.0	3.7	5.1	3.7	5.5	3.7	5.6	3.9	5.8	3.9	6.2	3.9	6.6	3.8
63 (7.1)	6.4	4.5	6.5	4.6	6.9	4.6	7.1	4.8	7.4	4.8	7.9	4.8	8.4	4.7
80 (9.0)	8.1	6.0	8.3	6.2	8.8	6.1	9.0	6.4	9.4	6.4	10.0	6.4	10.6	6.3
100 (11.2)	10.1	7.4	10.3	7.5	11.0	7.5	11.2	7.9	11.7	7.9	12.4	7.8	13.2	7.7
125 (14.0)	12.6	9.4	12.8	9.6	13.7	9.5	14.0	10.1	14.6	10.1	15.5	10.0	16.5	9.8

* The capacity does not depend on the outdoor temperature.

kcal/h = kW x 860, BTU/h = kW x 3,412

4-4. Cooling capacity with PUHY-P400-650YSKB-A1, EP550-650YSLM-A

PLFY-P-VLMD-E

CA: Capacity (kW), SHC: Sensible Heat Capacity (kW)

Model size (Rated kW)	Indoor air temp.													
	21.5°C D.B. 15°C W.B.		23°C D.B. 16°C W.B.		25°C D.B. 18°C W.B.		27°C D.B. 19°C W.B.		28°C D.B. 20°C W.B.		30°C D.B. 22°C W.B.		32°C D.B. 24°C W.B.	
	CA	SHC	CA	SHC	CA	SHC	CA	SHC	CA	SHC	CA	SHC	CA	SHC
20 (2.2)	2.0	1.8	2.0	1.9	2.2	1.9	2.2	2.0	2.3	2.0	2.5	2.0	2.6	2.0
25 (2.8)	2.5	2.1	2.6	2.1	2.7	2.1	2.8	2.2	2.9	2.2	3.1	2.2	3.3	2.2
32 (3.6)	3.2	2.5	3.3	2.5	3.5	2.5	3.6	2.6	3.8	2.7	4.0	2.6	4.3	2.6
40 (4.5)	4.0	2.9	4.1	2.9	4.4	2.9	4.5	3.0	4.7	3.1	5.0	3.0	5.4	3.0
50 (5.6)	5.0	3.6	5.1	3.7	5.5	3.7	5.6	3.9	5.9	3.9	6.3	3.9	6.7	3.8
63 (7.1)	6.3	4.5	6.5	4.6	6.9	4.6	7.1	4.8	7.4	4.8	7.9	4.8	8.5	4.7
80 (9.0)	8.0	6.0	8.2	6.1	8.8	6.1	9.0	6.4	9.4	6.5	10.1	6.4	10.7	6.3
100 (11.2)	10.0	7.4	10.2	7.5	11.0	7.5	11.2	7.9	11.7	7.9	12.5	7.8	13.4	7.7
125 (14.0)	12.5	9.4	12.8	9.6	13.7	9.5	14.0	10.1	14.7	10.1	15.7	10.0	16.7	9.9

* The capacity does not depend on the outdoor temperature.

kcal/h = kW x 860, BTU/h = kW x 3,412

4. Cooling [Ceiling cassette (2-way flow type)]

YKB/YLM

CT

4-5. Cooling capacity with PUHY-P700-800YSKB-A1, EP700-800YSLM-A

PLFY-P-VLMD-E

CA: Capacity (kW), SHC: Sensible Heat Capacity (kW)

Model size (Rated kW)	Indoor air temp.													
	21.5°C D.B. 15°C W.B.		23°C D.B. 16°C W.B.		25°C D.B. 18°C W.B.		27°C D.B. 19°C W.B.		28°C D.B. 20°C W.B.		30°C D.B. 22°C W.B.		32°C D.B. 24°C W.B.	
	CA	SHC	CA	SHC	CA	SHC	CA	SHC	CA	SHC	CA	SHC	CA	SHC
20 (2.2)	1.9	1.8	2.0	1.9	2.1	1.9	2.2	2.0	2.3	2.0	2.4	2.0	2.6	2.0
25 (2.8)	2.5	2.0	2.5	2.1	2.7	2.1	2.8	2.2	2.9	2.2	3.1	2.2	3.3	2.2
32 (3.6)	3.2	2.4	3.3	2.5	3.5	2.5	3.6	2.6	3.7	2.6	4.0	2.6	4.2	2.6
40 (4.5)	3.9	2.8	4.1	2.9	4.4	2.9	4.5	3.0	4.7	3.0	5.0	3.0	5.3	3.0
50 (5.6)	4.9	3.6	5.1	3.7	5.4	3.7	5.6	3.9	5.8	3.9	6.2	3.9	6.6	3.8
63 (7.1)	6.2	4.5	6.4	4.6	6.9	4.6	7.1	4.8	7.4	4.8	7.9	4.8	8.3	4.7
80 (9.0)	7.9	5.9	8.1	6.1	8.7	6.1	9.0	6.4	9.3	6.4	10.0	6.4	10.6	6.3
100 (11.2)	9.8	7.3	10.1	7.5	10.9	7.4	11.2	7.9	11.6	7.9	12.4	7.8	13.2	7.7
125 (14.0)	12.3	9.2	12.7	9.5	13.6	9.5	14.0	10.1	14.5	10.0	15.5	9.9	16.5	9.8

* The capacity does not depend on the outdoor temperature.

kcal/h = kW x 860, BTU/h = kW x 3,412

4-6. Cooling capacity with PUHY-P850-1350YSKB-A1, PUHY-EP850-1350YSLM-A

PLFY-P-VLMD-E

CA: Capacity (kW), SHC: Sensible Heat Capacity (kW)

Model size (Rated kW)	Indoor air temp.													
	21.5°C D.B. 15°C W.B.		23°C D.B. 16°C W.B.		25°C D.B. 18°C W.B.		27°C D.B. 19°C W.B.		28°C D.B. 20°C W.B.		30°C D.B. 22°C W.B.		32°C D.B. 24°C W.B.	
	CA	SHC	CA	SHC	CA	SHC	CA	SHC	CA	SHC	CA	SHC	CA	SHC
20 (2.2)	2.0	1.8	2.0	1.9	2.2	1.9	2.2	2.0	2.3	2.0	2.5	2.0	2.6	2.0
25 (2.8)	2.5	2.1	2.6	2.1	2.7	2.1	2.8	2.2	2.9	2.2	3.1	2.2	3.3	2.2
32 (3.6)	3.2	2.5	3.3	2.5	3.5	2.5	3.6	2.6	3.8	2.7	4.0	2.6	4.3	2.6
40 (4.5)	4.0	2.9	4.1	2.9	4.4	2.9	4.5	3.0	4.7	3.1	5.0	3.0	5.4	3.0
50 (5.6)	5.0	3.6	5.1	3.7	5.5	3.7	5.6	3.9	5.9	3.9	6.3	3.9	6.7	3.8
63 (7.1)	6.3	4.5	6.5	4.6	6.9	4.6	7.1	4.8	7.4	4.8	7.9	4.8	8.5	4.7
80 (9.0)	8.0	6.0	8.2	6.1	8.8	6.1	9.0	6.4	9.4	6.5	10.1	6.4	10.7	6.3
100 (11.2)	10.0	7.4	10.2	7.5	11.0	7.5	11.2	7.9	11.7	7.9	12.5	7.8	13.4	7.7
125 (14.0)	12.5	9.4	12.8	9.6	13.7	9.5	14.0	10.1	14.7	10.1	15.7	10.0	16.7	9.9

* The capacity does not depend on the outdoor temperature.

kcal/h = kW x 860, BTU/h = kW x 3,412

4-7. Cooling capacity with PURY-(E)P200-250YLM-A(1)

PLFY-P-VLMD-E

CA: Capacity (kW), SHC: Sensible Heat Capacity (kW)

Model size (Rated kW)	Indoor air temp.													
	21.5°C D.B. 15°C W.B.		23°C D.B. 16°C W.B.		25°C D.B. 18°C W.B.		27°C D.B. 19°C W.B.		28°C D.B. 20°C W.B.		30°C D.B. 22°C W.B.		32°C D.B. 24°C W.B.	
	CA	SHC	CA	SHC	CA	SHC	CA	SHC	CA	SHC	CA	SHC	CA	SHC
20 (2.2)	2.0	1.8	2.0	1.9	2.2	1.9	2.2	2.0	2.3	2.0	2.4	2.0	2.6	1.9
25 (2.8)	2.5	2.1	2.6	2.1	2.8	2.1	2.8	2.2	2.9	2.2	3.1	2.2	3.2	2.2
32 (3.6)	3.2	2.5	3.3	2.5	3.5	2.5	3.6	2.6	3.7	2.6	3.9	2.6	4.2	2.6
40 (4.5)	4.1	2.9	4.2	2.9	4.4	2.9	4.5	3.0	4.7	3.0	4.9	3.0	5.2	2.9
50 (5.6)	5.0	3.7	5.2	3.8	5.5	3.7	5.6	3.9	5.8	3.9	6.1	3.8	6.5	3.8
63 (7.1)	6.4	4.5	6.6	4.7	7.0	4.6	7.1	4.8	7.4	4.8	7.8	4.7	8.2	4.7
80 (9.0)	8.1	6.0	8.4	6.2	8.9	6.1	9.0	6.4	9.3	6.4	9.8	6.3	10.4	6.2
100 (11.2)	10.1	7.4	10.4	7.6	11.0	7.5	11.2	7.9	11.6	7.9	12.2	7.7	13.0	7.6
125 (14.0)	12.6	9.4	13.0	9.7	13.8	9.6	14.0	10.1	14.5	10.0	15.3	9.9	16.2	9.7

* The capacity does not depend on the outdoor temperature.

kcal/h = kW x 860, BTU/h = kW x 3,412

4-8. Cooling capacity with PURY-(E)P300-400Y(S)LM-A(1)

PLFY-P-VLMD-E

CA: Capacity (kW), SHC: Sensible Heat Capacity (kW)

Model size (Rated kW)	Indoor air temp.													
	21.5°C D.B. 15°C W.B.		23°C D.B. 16°C W.B.		25°C D.B. 18°C W.B.		27°C D.B. 19°C W.B.		28°C D.B. 20°C W.B.		30°C D.B. 22°C W.B.		32°C D.B. 24°C W.B.	
	CA	SHC	CA	SHC	CA	SHC	CA	SHC	CA	SHC	CA	SHC	CA	SHC
20 (2.2)	2.0	1.8	2.0	1.9	2.2	1.9	2.2	2.0	2.3	2.0	2.4	2.0	2.6	2.0
25 (2.8)	2.5	2.1	2.6	2.1	2.7	2.1	2.8	2.2	2.9	2.2	3.1	2.2	3.3	2.2
32 (3.6)	3.2	2.5	3.3	2.5	3.5	2.5	3.6	2.6	3.8	2.6	4.0	2.6	4.2	2.6
40 (4.5)	4.1	2.9	4.1	2.9	4.4	2.9	4.5	3.0	4.7	3.0	5.0	3.0	5.3	3.0
50 (5.6)	5.0	3.7	5.1	3.7	5.5	3.7	5.6	3.9	5.8	3.9	6.2	3.9	6.6	3.8
63 (7.1)	6.4	4.5	6.5	4.6	6.9	4.6	7.1	4.8	7.4	4.8	7.9	4.8	8.4	4.7
80 (9.0)	8.1	6.0	8.3	6.2	8.8	6.1	9.0	6.4	9.4	6.4	10.0	6.4	10.6	6.3
100 (11.2)	10.1	7.4	10.3	7.5	11.0	7.5	11.2	7.9	11.7	7.9	12.4	7.8	13.2	7.7
125 (14.0)	12.6	9.4	12.8	9.6	13.7	9.5	14.0	10.1	14.6	10.1	15.5	10.0	16.5	9.8

* The capacity does not depend on the outdoor temperature.

kcal/h = kW x 860, BTU/h = kW x 3,412

4. Cooling [Ceiling cassette (2-way flow type)]

YKB/YLM

4-9. Cooling capacity with PURY-(E)P450-650Y(S)LM-A(1)

PLFY-P-VLMD-E

CA: Capacity (kW), SHC: Sensible Heat Capacity (kW)

Model size (Rated kW)	Indoor air temp.													
	21.5°C D.B. 15°C W.B.		23°C D.B. 16°C W.B.		25°C D.B. 18°C W.B.		27°C D.B. 19°C W.B.		28°C D.B. 20°C W.B.		30°C D.B. 22°C W.B.		32°C D.B. 24°C W.B.	
	CA	SHC	CA	SHC	CA	SHC	CA	SHC	CA	SHC	CA	SHC	CA	SHC
20 (2.2)	2.0	1.8	2.0	1.9	2.2	1.9	2.2	2.0	2.3	2.0	2.5	2.0	2.6	2.0
25 (2.8)	2.5	2.1	2.6	2.1	2.7	2.1	2.8	2.2	2.9	2.2	3.1	2.2	3.3	2.2
32 (3.6)	3.2	2.5	3.3	2.5	3.5	2.5	3.6	2.6	3.8	2.7	4.0	2.6	4.3	2.6
40 (4.5)	4.0	2.9	4.1	2.9	4.4	2.9	4.5	3.0	4.7	3.1	5.0	3.0	5.4	3.0
50 (5.6)	5.0	3.6	5.1	3.7	5.5	3.7	5.6	3.9	5.9	3.9	6.3	3.9	6.7	3.8
63 (7.1)	6.3	4.5	6.5	4.6	6.9	4.6	7.1	4.8	7.4	4.8	7.9	4.8	8.5	4.7
80 (9.0)	8.0	6.0	8.2	6.1	8.8	6.1	9.0	6.4	9.4	6.5	10.1	6.4	10.7	6.3
100 (11.2)	10.0	7.4	10.2	7.5	11.0	7.5	11.2	7.9	11.7	7.9	12.5	7.8	13.4	7.7
125 (14.0)	12.5	9.4	12.8	9.6	13.7	9.5	14.0	10.1	14.7	10.1	15.7	10.0	16.7	9.9

* The capacity does not depend on the outdoor temperature.

kcal/h = kW x 860, BTU/h = kW x 3,412

4-10. Cooling capacity with PURY-EP700-800YSLM-A(1)

PLFY-P-VLMD-E

CA: Capacity (kW), SHC: Sensible Heat Capacity (kW)

Model size (Rated kW)	Indoor air temp.													
	21.5°C D.B. 15°C W.B.		23°C D.B. 16°C W.B.		25°C D.B. 18°C W.B.		27°C D.B. 19°C W.B.		28°C D.B. 20°C W.B.		30°C D.B. 22°C W.B.		32°C D.B. 24°C W.B.	
	CA	SHC	CA	SHC	CA	SHC	CA	SHC	CA	SHC	CA	SHC	CA	SHC
20 (2.2)	1.9	1.8	2.0	1.9	2.1	1.9	2.2	2.0	2.3	2.0	2.4	2.0	2.6	2.0
25 (2.8)	2.5	2.0	2.5	2.1	2.7	2.1	2.8	2.2	2.9	2.2	3.1	2.2	3.3	2.2
32 (3.6)	3.2	2.4	3.3	2.5	3.5	2.5	3.6	2.6	3.7	2.6	4.0	2.6	4.2	2.6
40 (4.5)	3.9	2.8	4.1	2.9	4.4	2.9	4.5	3.0	4.7	3.0	5.0	3.0	5.3	3.0
50 (5.6)	4.9	3.6	5.1	3.7	5.4	3.7	5.6	3.9	5.8	3.9	6.2	3.9	6.6	3.8
63 (7.1)	6.2	4.5	6.4	4.6	6.9	4.6	7.1	4.8	7.4	4.8	7.9	4.8	8.3	4.7
80 (9.0)	7.9	5.9	8.1	6.1	8.7	6.1	9.0	6.4	9.3	6.4	10.0	6.4	10.6	6.3
100 (11.2)	9.8	7.3	10.1	7.5	10.9	7.4	11.2	7.9	11.6	7.9	12.4	7.8	13.2	7.7
125 (14.0)	12.3	9.2	12.7	9.5	13.6	9.5	14.0	10.1	14.5	10.0	15.5	9.9	16.5	9.8

* The capacity does not depend on the outdoor temperature.

kcal/h = kW x 860, BTU/h = kW x 3,412

4-11. Cooling capacity with PURY-(E)P850-900YSLM-A(1)

PLFY-P-VLMD-E

CA: Capacity (kW), SHC: Sensible Heat Capacity (kW)

Model size (Rated kW)	Indoor air temp.													
	21.5°C D.B. 15°C W.B.		23°C D.B. 16°C W.B.		25°C D.B. 18°C W.B.		27°C D.B. 19°C W.B.		28°C D.B. 20°C W.B.		30°C D.B. 22°C W.B.		32°C D.B. 24°C W.B.	
	CA	SHC	CA	SHC	CA	SHC	CA	SHC	CA	SHC	CA	SHC	CA	SHC
20 (2.2)	2.0	1.8	2.0	1.9	2.2	1.9	2.2	2.0	2.3	2.0	2.5	2.0	2.6	2.0
25 (2.8)	2.5	2.1	2.6	2.1	2.7	2.1	2.8	2.2	2.9	2.2	3.1	2.2	3.3	2.2
32 (3.6)	3.2	2.5	3.3	2.5	3.5	2.5	3.6	2.6	3.8	2.7	4.0	2.6	4.3	2.6
40 (4.5)	4.0	2.9	4.1	2.9	4.4	2.9	4.5	3.0	4.7	3.1	5.0	3.0	5.4	3.0
50 (5.6)	5.0	3.6	5.1	3.7	5.5	3.7	5.6	3.9	5.9	3.9	6.3	3.9	6.7	3.8
63 (7.1)	6.3	4.5	6.5	4.6	6.9	4.6	7.1	4.8	7.4	4.8	7.9	4.8	8.5	4.7
80 (9.0)	8.0	6.0	8.2	6.1	8.8	6.1	9.0	6.4	9.4	6.5	10.1	6.4	10.7	6.3
100 (11.2)	10.0	7.4	10.2	7.5	11.0	7.5	11.2	7.9	11.7	7.9	12.5	7.8	13.4	7.7
125 (14.0)	12.5	9.4	12.8	9.6	13.7	9.5	14.0	10.1	14.7	10.1	15.7	10.0	16.7	9.9

* The capacity does not depend on the outdoor temperature.

kcal/h = kW x 860, BTU/h = kW x 3,412

5. Cooling [Ceiling cassette (4-way flow type)]

YKB/YLM

CT

5-1. Cooling capacity with PUHY-P200-250YKB-A1, EP200-250YLM-A

PLFY-P-VCM-E2

CA: Capacity (kW), SHC: Sensible Heat Capacity (kW)

Model size (Rated kW)	Indoor air temp.													
	21.5°C D.B. 15°C W.B.		23°C D.B. 16°C W.B.		25°C D.B. 18°C W.B.		27°C D.B. 19°C W.B.		28°C D.B. 20°C W.B.		30°C D.B. 22°C W.B.		32°C D.B. 24°C W.B.	
	CA	SHC	CA	SHC	CA	SHC	CA	SHC	CA	SHC	CA	SHC	CA	SHC
15 (1.7)	1.5	1.4	1.6	1.5	1.7	1.5	1.7	1.6	1.8	1.6	1.9	1.6	2.0	1.5
20 (2.2)	2.0	1.7	2.0	1.8	2.2	1.8	2.2	1.9	2.3	1.9	2.4	1.9	2.6	1.8
25 (2.8)	2.5	2.1	2.6	2.1	2.8	2.1	2.8	2.3	2.9	2.2	3.1	2.2	3.2	2.2
32 (3.6)	3.2	2.5	3.3	2.6	3.5	2.6	3.6	2.7	3.7	2.7	3.9	2.7	4.2	2.6
40 (4.5)	4.1	2.9	4.2	3.0	4.4	3.0	4.5	3.1	4.7	3.1	4.9	3.1	5.2	3.0

* The capacity does not depend on the outdoor temperature.

kcal/h = kW x 860, BTU/h = kW x 3,412

PLFY-P-VBM-E

CA: Capacity (kW), SHC: Sensible Heat Capacity (kW)

Model size (Rated kW)	Indoor air temp.													
	21.5°C D.B. 15°C W.B.		23°C D.B. 16°C W.B.		25°C D.B. 18°C W.B.		27°C D.B. 19°C W.B.		28°C D.B. 20°C W.B.		30°C D.B. 22°C W.B.		32°C D.B. 24°C W.B.	
	CA	SHC	CA	SHC	CA	SHC	CA	SHC	CA	SHC	CA	SHC	CA	SHC
20 (2.2)	2.0	1.9	2.0	2.0	2.2	2.0	2.2	2.1	2.3	2.1	2.4	2.1	2.6	2.1
25 (2.8)	2.5	2.3	2.6	2.4	2.8	2.3	2.8	2.5	2.9	2.5	3.1	2.5	3.2	2.4
32 (3.6)	3.2	2.8	3.3	2.9	3.5	2.8	3.6	3.0	3.7	3.0	3.9	2.9	4.2	2.9
40 (4.5)	4.1	3.3	4.2	3.5	4.4	3.4	4.5	3.6	4.7	3.6	4.9	3.6	5.2	3.5
50 (5.6)	5.0	3.9	5.2	4.0	5.5	3.9	5.6	4.1	5.8	4.1	6.1	4.1	6.5	4.0
63 (7.1)	6.4	4.7	6.6	4.9	7.0	4.8	7.1	5.0	7.4	5.0	7.8	5.0	8.2	4.9
80 (9.0)	8.1	5.9	8.4	6.0	8.9	6.0	9.0	6.3	9.3	6.3	9.8	6.1	10.4	6.0
100 (11.2)	10.1	7.4	10.4	7.6	11.0	7.5	11.2	7.8	11.6	7.8	12.2	7.7	13.0	7.6
125 (14.0)	12.6	9.0	13.0	9.2	13.8	9.1	14.0	9.5	14.5	9.5	15.3	9.3	16.2	9.2

* The capacity does not depend on the outdoor temperature.

kcal/h = kW x 860, BTU/h = kW x 3,412

5-2. Cooling capacity with PUHY-P300-400YKB-A1, EP300-350YLM-A

PLFY-P-VCM-E2

CA: Capacity (kW), SHC: Sensible Heat Capacity (kW)

Model size (Rated kW)	Indoor air temp.													
	21.5°C D.B. 15°C W.B.		23°C D.B. 16°C W.B.		25°C D.B. 18°C W.B.		27°C D.B. 19°C W.B.		28°C D.B. 20°C W.B.		30°C D.B. 22°C W.B.		32°C D.B. 24°C W.B.	
	CA	SHC	CA	SHC	CA	SHC	CA	SHC	CA	SHC	CA	SHC	CA	SHC
15 (1.7)	1.5	1.4	1.6	1.5	1.7	1.5	1.7	1.6	1.8	1.6	1.9	1.6	2.0	1.5
20 (2.2)	2.0	1.7	2.0	1.8	2.2	1.8	2.2	1.9	2.3	1.9	2.4	1.9	2.6	1.8
25 (2.8)	2.5	2.1	2.6	2.1	2.8	2.1	2.8	2.3	2.9	2.2	3.1	2.2	3.2	2.2
32 (3.6)	3.2	2.5	3.3	2.6	3.5	2.6	3.6	2.7	3.7	2.7	3.9	2.7	4.2	2.6
40 (4.5)	4.1	2.9	4.2	3.0	4.4	3.0	4.5	3.1	4.7	3.1	4.9	3.1	5.2	3.0

* The capacity does not depend on the outdoor temperature.

kcal/h = kW x 860, BTU/h = kW x 3,412

PLFY-P-VBM-E

CA: Capacity (kW), SHC: Sensible Heat Capacity (kW)

Model size (Rated kW)	Indoor air temp.													
	21.5°C D.B. 15°C W.B.		23°C D.B. 16°C W.B.		25°C D.B. 18°C W.B.		27°C D.B. 19°C W.B.		28°C D.B. 20°C W.B.		30°C D.B. 22°C W.B.		32°C D.B. 24°C W.B.	
	CA	SHC	CA	SHC	CA	SHC	CA	SHC	CA	SHC	CA	SHC	CA	SHC
20 (2.2)	2.0	1.9	2.0	2.0	2.2	2.0	2.2	2.1	2.3	2.1	2.4	2.1	2.6	2.1
25 (2.8)	2.5	2.3	2.6	2.4	2.8	2.3	2.8	2.5	2.9	2.5	3.1	2.5	3.2	2.4
32 (3.6)	3.2	2.8	3.3	2.9	3.5	2.8	3.6	3.0	3.7	3.0	3.9	2.9	4.2	2.9
40 (4.5)	4.1	3.3	4.2	3.5	4.4	3.4	4.5	3.6	4.7	3.6	4.9	3.6	5.2	3.5
50 (5.6)	5.0	3.9	5.2	4.0	5.5	3.9	5.6	4.1	5.8	4.1	6.1	4.1	6.5	4.0
63 (7.1)	6.4	4.7	6.6	4.9	7.0	4.8	7.1	5.0	7.4	5.0	7.8	5.0	8.2	4.9
80 (9.0)	8.1	5.9	8.4	6.0	8.9	6.0	9.0	6.3	9.3	6.3	9.8	6.1	10.4	6.0
100 (11.2)	10.1	7.4	10.4	7.6	11.0	7.5	11.2	7.8	11.6	7.8	12.2	7.7	13.0	7.6
125 (14.0)	12.6	9.0	13.0	9.2	13.8	9.1	14.0	9.5	14.5	9.5	15.3	9.3	16.2	9.2

* The capacity does not depend on the outdoor temperature.

kcal/h = kW x 860, BTU/h = kW x 3,412

5. Cooling [Ceiling cassette (4-way flow type)]

YKB/YLM

5-3. Cooling capacity with PUHY-P450-500YKB-A1, EP400-500YLM-A

PLFY-P-VCM-E2

CA: Capacity (kW), SHC: Sensible Heat Capacity (kW)

Model size (Rated kW)	Indoor air temp.													
	21.5°C D.B. 15°C W.B.		23°C D.B. 16°C W.B.		25°C D.B. 18°C W.B.		27°C D.B. 19°C W.B.		28°C D.B. 20°C W.B.		30°C D.B. 22°C W.B.		32°C D.B. 24°C W.B.	
	CA	SHC	CA	SHC	CA	SHC	CA	SHC	CA	SHC	CA	SHC	CA	SHC
15 (1.7)	1.5	1.4	1.6	1.5	1.7	1.5	1.7	1.6	1.8	1.6	1.9	1.6	2.0	1.5
20 (2.2)	2.0	1.7	2.0	1.8	2.2	1.8	2.2	1.9	2.3	1.9	2.4	1.9	2.6	1.8
25 (2.8)	2.5	2.1	2.6	2.1	2.7	2.1	2.8	2.3	2.9	2.3	3.1	2.2	3.3	2.2
32 (3.6)	3.2	2.5	3.3	2.6	3.5	2.6	3.6	2.7	3.8	2.7	4.0	2.7	4.2	2.6
40 (4.5)	4.1	2.9	4.1	3.0	4.4	3.0	4.5	3.1	4.7	3.1	5.0	3.1	5.3	3.0

* The capacity does not depend on the outdoor temperature.

kcal/h = kW x 860, BTU/h = kW x 3,412

PLFY-P-VBM-E

CA: Capacity (kW), SHC: Sensible Heat Capacity (kW)

Model size (Rated kW)	Indoor air temp.													
	21.5°C D.B. 15°C W.B.		23°C D.B. 16°C W.B.		25°C D.B. 18°C W.B.		27°C D.B. 19°C W.B.		28°C D.B. 20°C W.B.		30°C D.B. 22°C W.B.		32°C D.B. 24°C W.B.	
	CA	SHC	CA	SHC	CA	SHC	CA	SHC	CA	SHC	CA	SHC	CA	SHC
20 (2.2)	2.0	1.9	2.0	2.0	2.2	2.0	2.2	2.1	2.3	2.1	2.4	2.1	2.6	2.1
25 (2.8)	2.5	2.3	2.6	2.3	2.7	2.3	2.8	2.5	2.9	2.5	3.1	2.5	3.3	2.4
32 (3.6)	3.2	2.8	3.3	2.8	3.5	2.8	3.6	3.0	3.8	3.0	4.0	3.0	4.2	2.9
40 (4.5)	4.1	3.3	4.1	3.4	4.4	3.4	4.5	3.6	4.7	3.6	5.0	3.6	5.3	3.5
50 (5.6)	5.0	3.9	5.1	3.9	5.5	3.9	5.6	4.1	5.8	4.1	6.2	4.1	6.6	4.0
63 (7.1)	6.4	4.7	6.5	4.8	6.9	4.8	7.1	5.0	7.4	5.1	7.9	5.0	8.4	4.9
80 (9.0)	8.1	5.9	8.3	6.0	8.8	6.0	9.0	6.3	9.4	6.3	10.0	6.2	10.6	6.1
100 (11.2)	10.1	7.4	10.3	7.5	11.0	7.5	11.2	7.8	11.7	7.9	12.4	7.8	13.2	7.6
125 (14.0)	12.6	9.0	12.8	9.1	13.7	9.0	14.0	9.5	14.6	9.5	15.5	9.4	16.5	9.2

* The capacity does not depend on the outdoor temperature.

kcal/h = kW x 860, BTU/h = kW x 3,412

5-4. Cooling capacity with PUHY-P400-650YSKB-A1, EP550-650YSLM-A

PLFY-P-VCM-E2

CA: Capacity (kW), SHC: Sensible Heat Capacity (kW)

Model size (Rated kW)	Indoor air temp.													
	21.5°C D.B. 15°C W.B.		23°C D.B. 16°C W.B.		25°C D.B. 18°C W.B.		27°C D.B. 19°C W.B.		28°C D.B. 20°C W.B.		30°C D.B. 22°C W.B.		32°C D.B. 24°C W.B.	
	CA	SHC	CA	SHC	CA	SHC	CA	SHC	CA	SHC	CA	SHC	CA	SHC
15 (1.7)	1.5	1.4	1.5	1.5	1.7	1.5	1.7	1.6	1.8	1.6	1.9	1.6	2.0	1.6
20 (2.2)	2.0	1.7	2.0	1.8	2.2	1.8	2.2	1.9	2.3	1.9	2.5	1.9	2.6	1.9
25 (2.8)	2.5	2.1	2.6	2.1	2.7	2.1	2.8	2.3	2.9	2.3	3.1	2.2	3.3	2.2
32 (3.6)	3.2	2.5	3.3	2.6	3.5	2.6	3.6	2.7	3.8	2.7	4.0	2.7	4.3	2.7
40 (4.5)	4.0	2.9	4.1	3.0	4.4	3.0	4.5	3.1	4.7	3.1	5.0	3.1	5.4	3.1

* The capacity does not depend on the outdoor temperature.

kcal/h = kW x 860, BTU/h = kW x 3,412

PLFY-P-VBM-E

CA: Capacity (kW), SHC: Sensible Heat Capacity (kW)

Model size (Rated kW)	Indoor air temp.													
	21.5°C D.B. 15°C W.B.		23°C D.B. 16°C W.B.		25°C D.B. 18°C W.B.		27°C D.B. 19°C W.B.		28°C D.B. 20°C W.B.		30°C D.B. 22°C W.B.		32°C D.B. 24°C W.B.	
	CA	SHC	CA	SHC	CA	SHC	CA	SHC	CA	SHC	CA	SHC	CA	SHC
20 (2.2)	2.0	1.9	2.0	2.0	2.2	2.0	2.2	2.1	2.3	2.1	2.5	2.1	2.6	2.1
25 (2.8)	2.5	2.3	2.6	2.3	2.7	2.3	2.8	2.5	2.9	2.5	3.1	2.5	3.3	2.4
32 (3.6)	3.2	2.7	3.3	2.8	3.5	2.8	3.6	3.0	3.8	3.0	4.0	3.0	4.3	2.9
40 (4.5)	4.0	3.3	4.1	3.4	4.4	3.4	4.5	3.6	4.7	3.6	5.0	3.6	5.4	3.6
50 (5.6)	5.0	3.8	5.1	3.9	5.5	3.9	5.6	4.1	5.9	4.2	6.3	4.1	6.7	4.1
63 (7.1)	6.3	4.7	6.5	4.8	6.9	4.8	7.1	5.0	7.4	5.1	7.9	5.0	8.5	5.0
80 (9.0)	8.0	5.9	8.2	6.0	8.8	6.0	9.0	6.3	9.4	6.3	10.1	6.2	10.7	6.2
100 (11.2)	10.0	7.3	10.2	7.5	11.0	7.5	11.2	7.8	11.7	7.9	12.5	7.8	13.4	7.7
125 (14.0)	12.5	8.9	12.8	9.1	13.7	9.0	14.0	9.5	14.7	9.5	15.7	9.4	16.7	9.3

* The capacity does not depend on the outdoor temperature.

kcal/h = kW x 860, BTU/h = kW x 3,412

5. Cooling [Ceiling cassette (4-way flow type)]

YKB/YLM

CT

5-5. Cooling capacity with PUHY-P700-800YSKB-A1, EP700-800YSLM-A

PLFY-P-VCM-E2

CA: Capacity (kW), SHC: Sensible Heat Capacity (kW)

Model size (Rated kW)	Indoor air temp.													
	21.5°C D.B. 15°C W.B.		23°C D.B. 16°C W.B.		25°C D.B. 18°C W.B.		27°C D.B. 19°C W.B.		28°C D.B. 20°C W.B.		30°C D.B. 22°C W.B.		32°C D.B. 24°C W.B.	
	CA	SHC	CA	SHC	CA	SHC	CA	SHC	CA	SHC	CA	SHC	CA	SHC
15 (1.7)	1.5	1.4	1.5	1.5	1.6	1.5	1.7	1.6	1.8	1.6	1.9	1.6	2.0	1.5
20 (2.2)	1.9	1.7	2.0	1.8	2.1	1.8	2.2	1.9	2.3	1.9	2.4	1.9	2.6	1.8
25 (2.8)	2.5	2.0	2.5	2.1	2.7	2.1	2.8	2.3	2.9	2.2	3.1	2.2	3.3	2.2
32 (3.6)	3.2	2.5	3.3	2.6	3.5	2.5	3.6	2.7	3.7	2.7	4.0	2.7	4.2	2.6
40 (4.5)	3.9	2.9	4.1	3.0	4.4	2.9	4.5	3.1	4.7	3.1	5.0	3.1	5.3	3.0

* The capacity does not depend on the outdoor temperature.

kcal/h = kW x 860, BTU/h = kW x 3,412

PLFY-P-VBM-E

CA: Capacity (kW), SHC: Sensible Heat Capacity (kW)

Model size (Rated kW)	Indoor air temp.													
	21.5°C D.B. 15°C W.B.		23°C D.B. 16°C W.B.		25°C D.B. 18°C W.B.		27°C D.B. 19°C W.B.		28°C D.B. 20°C W.B.		30°C D.B. 22°C W.B.		32°C D.B. 24°C W.B.	
	CA	SHC	CA	SHC	CA	SHC	CA	SHC	CA	SHC	CA	SHC	CA	SHC
20 (2.2)	1.9	1.9	2.0	2.0	2.1	2.0	2.2	2.1	2.3	2.1	2.4	2.1	2.6	2.1
25 (2.8)	2.5	2.2	2.5	2.3	2.7	2.3	2.8	2.5	2.9	2.5	3.1	2.5	3.3	2.4
32 (3.6)	3.2	2.7	3.3	2.8	3.5	2.8	3.6	3.0	3.7	3.0	4.0	3.0	4.2	2.9
40 (4.5)	3.9	3.3	4.1	3.4	4.4	3.4	4.5	3.6	4.7	3.6	5.0	3.6	5.3	3.5
50 (5.6)	4.9	3.8	5.1	3.9	5.4	3.9	5.6	4.1	5.8	4.1	6.2	4.1	6.6	4.0
63 (7.1)	6.2	4.6	6.4	4.8	6.9	4.8	7.1	5.0	7.4	5.0	7.9	5.0	8.3	4.9
80 (9.0)	7.9	5.8	8.1	5.9	8.7	5.9	9.0	6.3	9.3	6.2	10.0	6.2	10.6	6.1
100 (11.2)	9.8	7.2	10.1	7.4	10.9	7.4	11.2	7.8	11.6	7.8	12.4	7.7	13.2	7.6
125 (14.0)	12.3	8.8	12.7	9.0	13.6	9.0	14.0	9.5	14.5	9.5	15.5	9.4	16.5	9.2

* The capacity does not depend on the outdoor temperature.

kcal/h = kW x 860, BTU/h = kW x 3,412

5-6. Cooling capacity with PUHY-P850-1350YSKB-A1, EP850-1350YSLM-A

PLFY-P-VCM-E2

CA: Capacity (kW), SHC: Sensible Heat Capacity (kW)

Model size (Rated kW)	Indoor air temp.													
	21.5°C D.B. 15°C W.B.		23°C D.B. 16°C W.B.		25°C D.B. 18°C W.B.		27°C D.B. 19°C W.B.		28°C D.B. 20°C W.B.		30°C D.B. 22°C W.B.		32°C D.B. 24°C W.B.	
	CA	SHC	CA	SHC	CA	SHC	CA	SHC	CA	SHC	CA	SHC	CA	SHC
15 (1.7)	1.5	1.4	1.5	1.5	1.7	1.5	1.7	1.6	1.8	1.6	1.9	1.6	2.0	1.6
20 (2.2)	2.0	1.7	2.0	1.8	2.2	1.8	2.2	1.9	2.3	1.9	2.5	1.9	2.6	1.9
25 (2.8)	2.5	2.1	2.6	2.1	2.7	2.1	2.8	2.3	2.9	2.3	3.1	2.2	3.3	2.2
32 (3.6)	3.2	2.5	3.3	2.6	3.5	2.6	3.6	2.7	3.8	2.7	4.0	2.7	4.3	2.7
40 (4.5)	4.0	2.9	4.1	3.0	4.4	3.0	4.5	3.1	4.7	3.1	5.0	3.1	5.4	3.1

* The capacity does not depend on the outdoor temperature.

kcal/h = kW x 860, BTU/h = kW x 3,412

PLFY-P-VBM-E

CA: Capacity (kW), SHC: Sensible Heat Capacity (kW)

Model size (Rated kW)	Indoor air temp.													
	21.5°C D.B. 15°C W.B.		23°C D.B. 16°C W.B.		25°C D.B. 18°C W.B.		27°C D.B. 19°C W.B.		28°C D.B. 20°C W.B.		30°C D.B. 22°C W.B.		32°C D.B. 24°C W.B.	
	CA	SHC	CA	SHC	CA	SHC	CA	SHC	CA	SHC	CA	SHC	CA	SHC
20 (2.2)	2.0	1.9	2.0	2.0	2.2	2.0	2.2	2.1	2.3	2.1	2.5	2.1	2.6	2.1
25 (2.8)	2.5	2.3	2.6	2.3	2.7	2.3	2.8	2.5	2.9	2.5	3.1	2.5	3.3	2.4
32 (3.6)	3.2	2.7	3.3	2.8	3.5	2.8	3.6	3.0	3.8	3.0	4.0	3.0	4.3	2.9
40 (4.5)	4.0	3.3	4.1	3.4	4.4	3.4	4.5	3.6	4.7	3.6	5.0	3.6	5.4	3.6
50 (5.6)	5.0	3.8	5.1	3.9	5.5	3.9	5.6	4.1	5.9	4.2	6.3	4.1	6.7	4.1
63 (7.1)	6.3	4.7	6.5	4.8	6.9	4.8	7.1	5.0	7.4	5.1	7.9	5.0	8.5	5.0
80 (9.0)	8.0	5.9	8.2	6.0	8.8	6.0	9.0	6.3	9.4	6.3	10.1	6.2	10.7	6.2
100 (11.2)	10.0	7.3	10.2	7.5	11.0	7.5	11.2	7.8	11.7	7.9	12.5	7.8	13.4	7.7
125 (14.0)	12.5	8.9	12.8	9.1	13.7	9.0	14.0	9.5	14.7	9.5	15.7	9.4	16.7	9.3

* The capacity does not depend on the outdoor temperature.

kcal/h = kW x 860, BTU/h = kW x 3,412

5-7. Cooling capacity with PURY-(E)P200-250YLM-A(1)

PLFY-P-VCM-E2

CA: Capacity (kW), SHC: Sensible Heat Capacity (kW)

Model size (Rated kW)	Indoor air temp.													
	21.5°C D.B. 15°C W.B.		23°C D.B. 16°C W.B.		25°C D.B. 18°C W.B.		27°C D.B. 19°C W.B.		28°C D.B. 20°C W.B.		30°C D.B. 22°C W.B.		32°C D.B. 24°C W.B.	
	CA	SHC	CA	SHC	CA	SHC	CA	SHC	CA	SHC	CA	SHC	CA	SHC
15 (1.7)	1.5	1.4	1.6	1.5	1.7	1.5	1.7	1.6	1.8	1.6	1.9	1.6	2.0	1.5
20 (2.2)	2.0	1.7	2.0	1.8	2.2	1.8	2.2	1.9	2.3	1.9	2.4	1.9	2.6	1.8
25 (2.8)	2.5	2.1	2.6	2.1	2.8	2.1	2.8	2.3	2.9	2.2	3.1	2.2	3.2	2.2
32 (3.6)	3.2	2.5	3.3	2.6	3.5	2.6	3.6	2.7	3.7	2.7	3.9	2.7	4.2	2.6
40 (4.5)	4.1	2.9	4.2	3.0	4.4	3.0	4.5	3.1	4.7	3.1	4.9	3.1	5.2	3.0

* The capacity does not depend on the outdoor temperature.

kcal/h = kW x 860, BTU/h = kW x 3,412

5. Cooling [Ceiling cassette (4-way flow type)]

YKB/YLM

PLFY-P-VBM-E

CA: Capacity (kW), SHC: Sensible Heat Capacity (kW)

Model size (Rated kW)	Indoor air temp.													
	21.5°C D.B. 15°C W.B.		23°C D.B. 16°C W.B.		25°C D.B. 18°C W.B.		27°C D.B. 19°C W.B.		28°C D.B. 20°C W.B.		30°C D.B. 22°C W.B.		32°C D.B. 24°C W.B.	
	CA	SHC	CA	SHC	CA	SHC	CA	SHC	CA	SHC	CA	SHC	CA	SHC
20 (2.2)	2.0	1.9	2.0	2.0	2.2	2.0	2.2	2.1	2.3	2.1	2.4	2.1	2.6	2.1
25 (2.8)	2.5	2.3	2.6	2.4	2.8	2.3	2.8	2.5	2.9	2.5	3.1	2.5	3.2	2.4
32 (3.6)	3.2	2.8	3.3	2.9	3.5	2.8	3.6	3.0	3.7	3.0	3.9	2.9	4.2	2.9
40 (4.5)	4.1	3.3	4.2	3.5	4.4	3.4	4.5	3.6	4.7	3.6	4.9	3.6	5.2	3.5
50 (5.6)	5.0	3.9	5.2	4.0	5.5	3.9	5.6	4.1	5.8	4.1	6.1	4.1	6.5	4.0
63 (7.1)	6.4	4.7	6.6	4.9	7.0	4.8	7.1	5.0	7.4	5.0	7.8	5.0	8.2	4.9
80 (9.0)	8.1	5.9	8.4	6.0	8.9	6.0	9.0	6.3	9.3	6.3	9.8	6.1	10.4	6.0
100 (11.2)	10.1	7.4	10.4	7.6	11.0	7.5	11.2	7.8	11.6	7.8	12.2	7.7	13.0	7.6
125 (14.0)	12.6	9.0	13.0	9.2	13.8	9.1	14.0	9.5	14.5	9.5	15.3	9.3	16.2	9.2

* The capacity does not depend on the outdoor temperature.

kcal/h = kW x 860, BTU/h = kW x 3,412

5-8. Cooling capacity with PURY-(E)P300-400Y(S)LM-A(1)

PLFY-P-VCM-E2

CA: Capacity (kW), SHC: Sensible Heat Capacity (kW)

Model size (Rated kW)	Indoor air temp.													
	21.5°C D.B. 15°C W.B.		23°C D.B. 16°C W.B.		25°C D.B. 18°C W.B.		27°C D.B. 19°C W.B.		28°C D.B. 20°C W.B.		30°C D.B. 22°C W.B.		32°C D.B. 24°C W.B.	
	CA	SHC	CA	SHC	CA	SHC	CA	SHC	CA	SHC	CA	SHC	CA	SHC
15 (1.7)	1.5	1.4	1.6	1.5	1.7	1.5	1.7	1.6	1.8	1.6	1.9	1.6	2.0	1.5
20 (2.2)	2.0	1.7	2.0	1.8	2.2	1.8	2.2	1.9	2.3	1.9	2.4	1.9	2.6	1.8
25 (2.8)	2.5	2.1	2.6	2.1	2.7	2.1	2.8	2.3	2.9	2.3	3.1	2.2	3.3	2.2
32 (3.6)	3.2	2.5	3.3	2.6	3.5	2.6	3.6	2.7	3.8	2.7	4.0	2.7	4.2	2.6
40 (4.5)	4.1	2.9	4.1	3.0	4.4	3.0	4.5	3.1	4.7	3.1	5.0	3.1	5.3	3.0

* The capacity does not depend on the outdoor temperature.

kcal/h = kW x 860, BTU/h = kW x 3,412

PLFY-P-VBM-E

CA: Capacity (kW), SHC: Sensible Heat Capacity (kW)

Model size (Rated kW)	Indoor air temp.													
	21.5°C D.B. 15°C W.B.		23°C D.B. 16°C W.B.		25°C D.B. 18°C W.B.		27°C D.B. 19°C W.B.		28°C D.B. 20°C W.B.		30°C D.B. 22°C W.B.		32°C D.B. 24°C W.B.	
	CA	SHC	CA	SHC	CA	SHC	CA	SHC	CA	SHC	CA	SHC	CA	SHC
20 (2.2)	2.0	1.9	2.0	2.0	2.2	2.0	2.2	2.1	2.3	2.1	2.4	2.1	2.6	2.1
25 (2.8)	2.5	2.3	2.6	2.3	2.7	2.3	2.8	2.5	2.9	2.5	3.1	2.5	3.3	2.4
32 (3.6)	3.2	2.8	3.3	2.8	3.5	2.8	3.6	3.0	3.8	3.0	4.0	3.0	4.2	2.9
40 (4.5)	4.1	3.3	4.1	3.4	4.4	3.4	4.5	3.6	4.7	3.6	5.0	3.6	5.3	3.5
50 (5.6)	5.0	3.9	5.1	3.9	5.5	3.9	5.6	4.1	5.8	4.1	6.2	4.1	6.6	4.0
63 (7.1)	6.4	4.7	6.5	4.8	6.9	4.8	7.1	5.0	7.4	5.1	7.9	5.0	8.4	4.9
80 (9.0)	8.1	5.9	8.3	6.0	8.8	6.0	9.0	6.3	9.4	6.3	10.0	6.2	10.6	6.1
100 (11.2)	10.1	7.4	10.3	7.5	11.0	7.5	11.2	7.8	11.7	7.9	12.4	7.8	13.2	7.6
125 (14.0)	12.6	9.0	12.8	9.1	13.7	9.0	14.0	9.5	14.6	9.5	15.5	9.4	16.5	9.2

* The capacity does not depend on the outdoor temperature.

kcal/h = kW x 860, BTU/h = kW x 3,412

5-9. Cooling capacity with PURY-(E)P450-650Y(S)LM-A(1)

PLFY-P-VCM-E2

CA: Capacity (kW), SHC: Sensible Heat Capacity (kW)

Model size (Rated kW)	Indoor air temp.													
	21.5°C D.B. 15°C W.B.		23°C D.B. 16°C W.B.		25°C D.B. 18°C W.B.		27°C D.B. 19°C W.B.		28°C D.B. 20°C W.B.		30°C D.B. 22°C W.B.		32°C D.B. 24°C W.B.	
	CA	SHC	CA	SHC	CA	SHC	CA	SHC	CA	SHC	CA	SHC	CA	SHC
15 (1.7)	1.5	1.4	1.5	1.5	1.7	1.5	1.7	1.6	1.8	1.6	1.9	1.6	2.0	1.6
20 (2.2)	2.0	1.7	2.0	1.8	2.2	1.8	2.2	1.9	2.3	1.9	2.5	1.9	2.6	1.9
25 (2.8)	2.5	2.1	2.6	2.1	2.7	2.1	2.8	2.3	2.9	2.3	3.1	2.2	3.3	2.2
32 (3.6)	3.2	2.5	3.3	2.6	3.5	2.6	3.6	2.7	3.8	2.7	4.0	2.7	4.3	2.7
40 (4.5)	4.0	2.9	4.1	3.0	4.4	3.0	4.5	3.1	4.7	3.1	5.0	3.1	5.4	3.1

* The capacity does not depend on the outdoor temperature.

kcal/h = kW x 860, BTU/h = kW x 3,412

5. Cooling [Ceiling cassette (4-way flow type)]

YKB/YLM

CT

PLFY-P-VBM-E

CA: Capacity (kW), SHC: Sensible Heat Capacity (kW)

Model size (Rated kW)	Indoor air temp.													
	21.5°C D.B. 15°C W.B.		23°C D.B. 16°C W.B.		25°C D.B. 18°C W.B.		27°C D.B. 19°C W.B.		28°C D.B. 20°C W.B.		30°C D.B. 22°C W.B.		32°C D.B. 24°C W.B.	
	CA	SHC	CA	SHC	CA	SHC	CA	SHC	CA	SHC	CA	SHC	CA	SHC
20 (2.2)	2.0	1.9	2.0	2.0	2.2	2.0	2.2	2.1	2.3	2.1	2.5	2.1	2.6	2.1
25 (2.8)	2.5	2.3	2.6	2.3	2.7	2.3	2.8	2.5	2.9	2.5	3.1	2.5	3.3	2.4
32 (3.6)	3.2	2.7	3.3	2.8	3.5	2.8	3.6	3.0	3.8	3.0	4.0	3.0	4.3	2.9
40 (4.5)	4.0	3.3	4.1	3.4	4.4	3.4	4.5	3.6	4.7	3.6	5.0	3.6	5.4	3.6
50 (5.6)	5.0	3.8	5.1	3.9	5.5	3.9	5.6	4.1	5.9	4.2	6.3	4.1	6.7	4.1
63 (7.1)	6.3	4.7	6.5	4.8	6.9	4.8	7.1	5.0	7.4	5.1	7.9	5.0	8.5	5.0
80 (9.0)	8.0	5.9	8.2	6.0	8.8	6.0	9.0	6.3	9.4	6.3	10.1	6.2	10.7	6.2
100 (11.2)	10.0	7.3	10.2	7.5	11.0	7.5	11.2	7.8	11.7	7.9	12.5	7.8	13.4	7.7
125 (14.0)	12.5	8.9	12.8	9.1	13.7	9.0	14.0	9.5	14.7	9.5	15.7	9.4	16.7	9.3

* The capacity does not depend on the outdoor temperature.

kcal/h = kW x 860, BTU/h = kW x 3,412

5-10. Cooling capacity with PURY-(E)P700-800YSLM-A(1)

PLFY-P-VCM-E2

CA: Capacity (kW), SHC: Sensible Heat Capacity (kW)

Model size (Rated kW)	Indoor air temp.													
	21.5°C D.B. 15°C W.B.		23°C D.B. 16°C W.B.		25°C D.B. 18°C W.B.		27°C D.B. 19°C W.B.		28°C D.B. 20°C W.B.		30°C D.B. 22°C W.B.		32°C D.B. 24°C W.B.	
	CA	SHC	CA	SHC	CA	SHC	CA	SHC	CA	SHC	CA	SHC	CA	SHC
15 (1.7)	1.5	1.4	1.5	1.5	1.6	1.5	1.7	1.6	1.8	1.6	1.9	1.6	2.0	1.5
20 (2.2)	1.9	1.7	2.0	1.8	2.1	1.8	2.2	1.9	2.3	1.9	2.4	1.9	2.6	1.8
25 (2.8)	2.5	2.0	2.5	2.1	2.7	2.1	2.8	2.3	2.9	2.2	3.1	2.2	3.3	2.2
32 (3.6)	3.2	2.5	3.3	2.6	3.5	2.5	3.6	2.7	3.7	2.7	4.0	2.7	4.2	2.6
40 (4.5)	3.9	2.9	4.1	3.0	4.4	2.9	4.5	3.1	4.7	3.1	5.0	3.1	5.3	3.0

* The capacity does not depend on the outdoor temperature.

kcal/h = kW x 860, BTU/h = kW x 3,412

PLFY-P-VBM-E

CA: Capacity (kW), SHC: Sensible Heat Capacity (kW)

Model size (Rated kW)	Indoor air temp.													
	21.5°C D.B. 15°C W.B.		23°C D.B. 16°C W.B.		25°C D.B. 18°C W.B.		27°C D.B. 19°C W.B.		28°C D.B. 20°C W.B.		30°C D.B. 22°C W.B.		32°C D.B. 24°C W.B.	
	CA	SHC	CA	SHC	CA	SHC	CA	SHC	CA	SHC	CA	SHC	CA	SHC
20 (2.2)	1.9	1.9	2.0	2.0	2.1	2.0	2.2	2.1	2.3	2.1	2.4	2.1	2.6	2.1
25 (2.8)	2.5	2.2	2.5	2.3	2.7	2.3	2.8	2.5	2.9	2.5	3.1	2.5	3.3	2.4
32 (3.6)	3.2	2.7	3.3	2.8	3.5	2.8	3.6	3.0	3.7	3.0	4.0	3.0	4.2	2.9
40 (4.5)	3.9	3.3	4.1	3.4	4.4	3.4	4.5	3.6	4.7	3.6	5.0	3.6	5.3	3.5
50 (5.6)	4.9	3.8	5.1	3.9	5.4	3.9	5.6	4.1	5.8	4.1	6.2	4.1	6.6	4.0
63 (7.1)	6.2	4.6	6.4	4.8	6.9	4.8	7.1	5.0	7.4	5.0	7.9	5.0	8.3	4.9
80 (9.0)	7.9	5.8	8.1	5.9	8.7	5.9	9.0	6.3	9.3	6.2	10.0	6.2	10.6	6.1
100 (11.2)	9.8	7.2	10.1	7.4	10.9	7.4	11.2	7.8	11.6	7.8	12.4	7.7	13.2	7.6
125 (14.0)	12.3	8.8	12.7	9.0	13.6	9.0	14.0	9.5	14.5	9.5	15.5	9.4	16.5	9.2

* The capacity does not depend on the outdoor temperature.

kcal/h = kW x 860, BTU/h = kW x 3,412

5-11. Cooling capacity with PURY-(E)P850-900YSLM-A(1)

PLFY-P-VCM-E2

CA: Capacity (kW), SHC: Sensible Heat Capacity (kW)

Model size (Rated kW)	Indoor air temp.													
	21.5°C D.B. 15°C W.B.		23°C D.B. 16°C W.B.		25°C D.B. 18°C W.B.		27°C D.B. 19°C W.B.		28°C D.B. 20°C W.B.		30°C D.B. 22°C W.B.		32°C D.B. 24°C W.B.	
	CA	SHC	CA	SHC	CA	SHC	CA	SHC	CA	SHC	CA	SHC	CA	SHC
15 (1.7)	1.5	1.4	1.5	1.5	1.7	1.5	1.7	1.6	1.8	1.6	1.9	1.6	2.0	1.6
20 (2.2)	2.0	1.7	2.0	1.8	2.2	1.8	2.2	1.9	2.3	1.9	2.5	1.9	2.6	1.9
25 (2.8)	2.5	2.1	2.6	2.1	2.7	2.1	2.8	2.3	2.9	2.3	3.1	2.2	3.3	2.2
32 (3.6)	3.2	2.5	3.3	2.6	3.5	2.6	3.6	2.7	3.8	2.7	4.0	2.7	4.3	2.7
40 (4.5)	4.0	2.9	4.1	3.0	4.4	3.0	4.5	3.1	4.7	3.1	5.0	3.1	5.4	3.1

* The capacity does not depend on the outdoor temperature.

kcal/h = kW x 860, BTU/h = kW x 3,412

5. Cooling [Ceiling cassette (4-way flow type)]

YKB/YLM

CT

PLFY-P-VBM-E

CA: Capacity (kW), SHC: Sensible Heat Capacity (kW)

Model size (Rated kW)	Indoor air temp.													
	21.5°C D.B. 15°C W.B.		23°C D.B. 16°C W.B.		25°C D.B. 18°C W.B.		27°C D.B. 19°C W.B.		28°C D.B. 20°C W.B.		30°C D.B. 22°C W.B.		32°C D.B. 24°C W.B.	
	CA	SHC	CA	SHC	CA	SHC	CA	SHC	CA	SHC	CA	SHC	CA	SHC
20 (2.2)	2.0	1.9	2.0	2.0	2.2	2.0	2.2	2.1	2.3	2.1	2.5	2.1	2.6	2.1
25 (2.8)	2.5	2.3	2.6	2.3	2.7	2.3	2.8	2.5	2.9	2.5	3.1	2.5	3.3	2.4
32 (3.6)	3.2	2.7	3.3	2.8	3.5	2.8	3.6	3.0	3.8	3.0	4.0	3.0	4.3	2.9
40 (4.5)	4.0	3.3	4.1	3.4	4.4	3.4	4.5	3.6	4.7	3.6	5.0	3.6	5.4	3.6
50 (5.6)	5.0	3.8	5.1	3.9	5.5	3.9	5.6	4.1	5.9	4.2	6.3	4.1	6.7	4.1
63 (7.1)	6.3	4.7	6.5	4.8	6.9	4.8	7.1	5.0	7.4	5.1	7.9	5.0	8.5	5.0
80 (9.0)	8.0	5.9	8.2	6.0	8.8	6.0	9.0	6.3	9.4	6.3	10.1	6.2	10.7	6.2
100 (11.2)	10.0	7.3	10.2	7.5	11.0	7.5	11.2	7.8	11.7	7.9	12.5	7.8	13.4	7.7
125 (14.0)	12.5	8.9	12.8	9.1	13.7	9.0	14.0	9.5	14.7	9.5	15.7	9.4	16.7	9.3

* The capacity does not depend on the outdoor temperature.

kcal/h = kW x 860, BTU/h = kW x 3,412

6-1. Cooling capacity with PUHY-P200-250YKB-A1, EP200-250YLM-A

PCFY-P-VKM-E

CA: Capacity (kW), SHC: Sensible Heat Capacity (kW)

Model size (Rated kW)	Indoor air temp.													
	21.5°C D.B. 15°C W.B.		23°C D.B. 16°C W.B.		25°C D.B. 18°C W.B.		27°C D.B. 19°C W.B.		28°C D.B. 20°C W.B.		30°C D.B. 22°C W.B.		32°C D.B. 24°C W.B.	
	CA	SHC	CA	SHC	CA	SHC	CA	SHC	CA	SHC	CA	SHC	CA	SHC
40 (4.5)	4.1	3.0	4.2	3.0	4.4	3.0	4.5	3.2	4.7	3.2	4.9	3.1	5.2	3.1
63 (7.1)	6.4	4.6	6.6	4.7	7.0	4.7	7.1	4.9	7.4	4.9	7.8	4.8	8.2	4.7
100 (11.2)	10.1	7.1	10.4	7.3	11.0	7.2	11.2	7.5	11.6	7.5	12.2	7.4	13.0	7.3
125 (14.0)	12.6	8.9	13.0	9.1	13.8	9.0	14.0	9.4	14.5	9.4	15.3	9.2	16.2	9.1

* The capacity does not depend on the outdoor temperature.

kcal/h = kW x 860, BTU/h = kW x 3,412

6-2. Cooling capacity with PUHY-P300-400YKB-A1, EP300-350YLM-A

PCFY-P-VKM-E

CA: Capacity (kW), SHC: Sensible Heat Capacity (kW)

Model size (Rated kW)	Indoor air temp.													
	21.5°C D.B. 15°C W.B.		23°C D.B. 16°C W.B.		25°C D.B. 18°C W.B.		27°C D.B. 19°C W.B.		28°C D.B. 20°C W.B.		30°C D.B. 22°C W.B.		32°C D.B. 24°C W.B.	
	CA	SHC	CA	SHC	CA	SHC	CA	SHC	CA	SHC	CA	SHC	CA	SHC
40 (4.5)	4.1	3.0	4.2	3.0	4.4	3.0	4.5	3.2	4.7	3.2	4.9	3.1	5.2	3.1
63 (7.1)	6.4	4.6	6.6	4.7	7.0	4.7	7.1	4.9	7.4	4.9	7.8	4.8	8.2	4.7
100 (11.2)	10.1	7.1	10.4	7.3	11.0	7.2	11.2	7.5	11.6	7.5	12.2	7.4	13.0	7.3
125 (14.0)	12.6	8.9	13.0	9.1	13.8	9.0	14.0	9.4	14.5	9.4	15.3	9.2	16.2	9.1

* The capacity does not depend on the outdoor temperature.

kcal/h = kW x 860, BTU/h = kW x 3,412

6-3. Cooling capacity with PUHY-P450-500YKB-A1, EP400-500YLM-A

PCFY-P-VKM-E

CA: Capacity (kW), SHC: Sensible Heat Capacity (kW)

Model size (Rated kW)	Indoor air temp.													
	21.5°C D.B. 15°C W.B.		23°C D.B. 16°C W.B.		25°C D.B. 18°C W.B.		27°C D.B. 19°C W.B.		28°C D.B. 20°C W.B.		30°C D.B. 22°C W.B.		32°C D.B. 24°C W.B.	
	CA	SHC	CA	SHC	CA	SHC	CA	SHC	CA	SHC	CA	SHC	CA	SHC
40 (4.5)	4.1	3.0	4.1	3.0	4.4	3.0	4.5	3.2	4.7	3.2	5.0	3.1	5.3	3.1
63 (7.1)	6.4	4.6	6.5	4.7	6.9	4.7	7.1	4.9	7.4	4.9	7.9	4.8	8.4	4.8
100 (11.2)	10.1	7.1	10.3	7.3	11.0	7.2	11.2	7.5	11.7	7.6	12.4	7.5	13.2	7.4
125 (14.0)	12.6	8.9	12.8	9.0	13.7	9.0	14.0	9.4	14.6	9.4	15.5	9.3	16.5	9.2

* The capacity does not depend on the outdoor temperature.

kcal/h = kW x 860, BTU/h = kW x 3,412

6-4. Cooling capacity with PUHY-P400-650YSKB-A1, EP550-650YSLM-A

PCFY-P-VKM-E

CA: Capacity (kW), SHC: Sensible Heat Capacity (kW)

Model size (Rated kW)	Indoor air temp.													
	21.5°C D.B. 15°C W.B.		23°C D.B. 16°C W.B.		25°C D.B. 18°C W.B.		27°C D.B. 19°C W.B.		28°C D.B. 20°C W.B.		30°C D.B. 22°C W.B.		32°C D.B. 24°C W.B.	
	CA	SHC	CA	SHC	CA	SHC	CA	SHC	CA	SHC	CA	SHC	CA	SHC
40 (4.5)	4.0	2.9	4.1	3.0	4.4	3.0	4.5	3.2	4.7	3.2	5.0	3.1	5.4	3.1
63 (7.1)	6.3	4.6	6.5	4.7	6.9	4.7	7.1	4.9	7.4	4.9	7.9	4.9	8.5	4.8
100 (11.2)	10.0	7.1	10.2	7.2	11.0	7.2	11.2	7.5	11.7	7.6	12.5	7.5	13.4	7.4
125 (14.0)	12.5	8.8	12.8	9.0	13.7	9.0	14.0	9.4	14.7	9.4	15.7	9.3	16.7	9.2

* The capacity does not depend on the outdoor temperature.

kcal/h = kW x 860, BTU/h = kW x 3,412

6-5. Cooling capacity with PUHY-P700-800YSKB-A1, EP700-800YSLM-A

PCFY-P-VKM-E

CA: Capacity (kW), SHC: Sensible Heat Capacity (kW)

Model size (Rated kW)	Indoor air temp.													
	21.5°C D.B. 15°C W.B.		23°C D.B. 16°C W.B.		25°C D.B. 18°C W.B.		27°C D.B. 19°C W.B.		28°C D.B. 20°C W.B.		30°C D.B. 22°C W.B.		32°C D.B. 24°C W.B.	
	CA	SHC	CA	SHC	CA	SHC	CA	SHC	CA	SHC	CA	SHC	CA	SHC
40 (4.5)	3.9	2.9	4.1	3.0	4.4	3.0	4.5	3.2	4.7	3.1	5.0	3.1	5.3	3.1
63 (7.1)	6.2	4.5	6.4	4.6	6.9	4.6	7.1	4.9	7.4	4.9	7.9	4.8	8.3	4.8
100 (11.2)	9.8	7.0	10.1	7.2	10.9	7.2	11.2	7.5	11.6	7.5	12.4	7.5	13.2	7.4
125 (14.0)	12.3	8.7	12.7	8.9	13.6	8.9	14.0	9.4	14.5	9.4	15.5	9.3	16.5	9.1

* The capacity does not depend on the outdoor temperature.

kcal/h = kW x 860, BTU/h = kW x 3,412

CT

6-6. Cooling capacity with PUHY-P850-1350YSKB-A1, EP850-1350YSLM-A

PCFY-P-VKM-E

CA: Capacity (kW), SHC: Sensible Heat Capacity (kW)

Model size (Rated kW)	Indoor air temp.													
	21.5°C D.B. 15°C W.B.		23°C D.B. 16°C W.B.		25°C D.B. 18°C W.B.		27°C D.B. 19°C W.B.		28°C D.B. 20°C W.B.		30°C D.B. 22°C W.B.		32°C D.B. 24°C W.B.	
	CA	SHC	CA	SHC	CA	SHC	CA	SHC	CA	SHC	CA	SHC	CA	SHC
40 (4.5)	4.0	2.9	4.1	3.0	4.4	3.0	4.5	3.2	4.7	3.2	5.0	3.1	5.4	3.1
63 (7.1)	6.3	4.6	6.5	4.7	6.9	4.7	7.1	4.9	7.4	4.9	7.9	4.9	8.5	4.8
100 (11.2)	10.0	7.1	10.2	7.2	11.0	7.2	11.2	7.5	11.7	7.6	12.5	7.5	13.4	7.4
125 (14.0)	12.5	8.8	12.8	9.0	13.7	9.0	14.0	9.4	14.7	9.4	15.7	9.3	16.7	9.2

* The capacity does not depend on the outdoor temperature.

kcal/h = kW x 860, BTU/h = kW x 3,412

6-7. Cooling capacity with PURY-(E)P200-250YLM-A(1)

PCFY-P-VKM-E

CA: Capacity (kW), SHC: Sensible Heat Capacity (kW)

Model size (Rated kW)	Indoor air temp.													
	21.5°C D.B. 15°C W.B.		23°C D.B. 16°C W.B.		25°C D.B. 18°C W.B.		27°C D.B. 19°C W.B.		28°C D.B. 20°C W.B.		30°C D.B. 22°C W.B.		32°C D.B. 24°C W.B.	
	CA	SHC	CA	SHC	CA	SHC	CA	SHC	CA	SHC	CA	SHC	CA	SHC
40 (4.5)	4.1	3.0	4.2	3.0	4.4	3.0	4.5	3.2	4.7	3.2	4.9	3.1	5.2	3.1
63 (7.1)	6.4	4.6	6.6	4.7	7.0	4.7	7.1	4.9	7.4	4.9	7.8	4.8	8.2	4.7
100 (11.2)	10.1	7.1	10.4	7.3	11.0	7.2	11.2	7.5	11.6	7.5	12.2	7.4	13.0	7.3
125 (14.0)	12.6	8.9	13.0	9.1	13.8	9.0	14.0	9.4	14.5	9.4	15.3	9.2	16.2	9.1

* The capacity does not depend on the outdoor temperature.

kcal/h = kW x 860, BTU/h = kW x 3,412

6-8. Cooling capacity with PURY-(E)P300-400Y(S)LM-A(1)

PCFY-P-VKM-E

CA: Capacity (kW), SHC: Sensible Heat Capacity (kW)

Model size (Rated kW)	Indoor air temp.													
	21.5°C D.B. 15°C W.B.		23°C D.B. 16°C W.B.		25°C D.B. 18°C W.B.		27°C D.B. 19°C W.B.		28°C D.B. 20°C W.B.		30°C D.B. 22°C W.B.		32°C D.B. 24°C W.B.	
	CA	SHC	CA	SHC	CA	SHC	CA	SHC	CA	SHC	CA	SHC	CA	SHC
40 (4.5)	4.1	3.0	4.1	3.0	4.4	3.0	4.5	3.2	4.7	3.2	5.0	3.1	5.3	3.1
63 (7.1)	6.4	4.6	6.5	4.7	6.9	4.7	7.1	4.9	7.4	4.9	7.9	4.8	8.4	4.8
100 (11.2)	10.1	7.1	10.3	7.3	11.0	7.2	11.2	7.5	11.7	7.6	12.4	7.5	13.2	7.4
125 (14.0)	12.6	8.9	12.8	9.0	13.7	9.0	14.0	9.4	14.6	9.4	15.5	9.3	16.5	9.2

* The capacity does not depend on the outdoor temperature.

kcal/h = kW x 860, BTU/h = kW x 3,412

6-9. Cooling capacity with PURY-(E)P450-650Y(S)LM-A(1)

PCFY-P-VKM-E

CA: Capacity (kW), SHC: Sensible Heat Capacity (kW)

Model size (Rated kW)	Indoor air temp.													
	21.5°C D.B. 15°C W.B.		23°C D.B. 16°C W.B.		25°C D.B. 18°C W.B.		27°C D.B. 19°C W.B.		28°C D.B. 20°C W.B.		30°C D.B. 22°C W.B.		32°C D.B. 24°C W.B.	
	CA	SHC	CA	SHC	CA	SHC	CA	SHC	CA	SHC	CA	SHC	CA	SHC
40 (4.5)	4.0	2.9	4.1	3.0	4.4	3.0	4.5	3.2	4.7	3.2	5.0	3.1	5.4	3.1
63 (7.1)	6.3	4.6	6.5	4.7	6.9	4.7	7.1	4.9	7.4	4.9	7.9	4.9	8.5	4.8
100 (11.2)	10.0	7.1	10.2	7.2	11.0	7.2	11.2	7.5	11.7	7.6	12.5	7.5	13.4	7.4
125 (14.0)	12.5	8.8	12.8	9.0	13.7	9.0	14.0	9.4	14.7	9.4	15.7	9.3	16.7	9.2

* The capacity does not depend on the outdoor temperature.

kcal/h = kW x 860, BTU/h = kW x 3,412

6-10. Cooling capacity with PURY-(E)P700-800YSLM-A(1)

PCFY-P-VKM-E

CA: Capacity (kW), SHC: Sensible Heat Capacity (kW)

Model size (Rated kW)	Indoor air temp.													
	21.5°C D.B. 15°C W.B.		23°C D.B. 16°C W.B.		25°C D.B. 18°C W.B.		27°C D.B. 19°C W.B.		28°C D.B. 20°C W.B.		30°C D.B. 22°C W.B.		32°C D.B. 24°C W.B.	
	CA	SHC	CA	SHC	CA	SHC	CA	SHC	CA	SHC	CA	SHC	CA	SHC
40 (4.5)	3.9	2.9	4.1	3.0	4.4	3.0	4.5	3.2	4.7	3.1	5.0	3.1	5.3	3.1
63 (7.1)	6.2	4.5	6.4	4.6	6.9	4.6	7.1	4.9	7.4	4.9	7.9	4.8	8.3	4.8
100 (11.2)	9.8	7.0	10.1	7.2	10.9	7.2	11.2	7.5	11.6	7.5	12.4	7.5	13.2	7.4
125 (14.0)	12.3	8.7	12.7	8.9	13.6	8.9	14.0	9.4	14.5	9.4	15.5	9.3	16.5	9.1

* The capacity does not depend on the outdoor temperature.

kcal/h = kW x 860, BTU/h = kW x 3,412

6-11. Cooling capacity with PURY-(E)P850-900YSLM-A(1)

PCFY-P-VKM-E

CA: Capacity (kW), SHC: Sensible Heat Capacity (kW)

Model size (Rated kW)	Indoor air temp.													
	21.5°C D.B. 15°C W.B.		23°C D.B. 16°C W.B.		25°C D.B. 18°C W.B.		27°C D.B. 19°C W.B.		28°C D.B. 20°C W.B.		30°C D.B. 22°C W.B.		32°C D.B. 24°C W.B.	
	CA	SHC	CA	SHC	CA	SHC	CA	SHC	CA	SHC	CA	SHC	CA	SHC
40 (4.5)	4.0	2.9	4.1	3.0	4.4	3.0	4.5	3.2	4.7	3.2	5.0	3.1	5.4	3.1
63 (7.1)	6.3	4.6	6.5	4.7	6.9	4.7	7.1	4.9	7.4	4.9	7.9	4.9	8.5	4.8
100 (11.2)	10.0	7.1	10.2	7.2	11.0	7.2	11.2	7.5	11.7	7.6	12.5	7.5	13.4	7.4
125 (14.0)	12.5	8.8	12.8	9.0	13.7	9.0	14.0	9.4	14.7	9.4	15.7	9.3	16.7	9.2

* The capacity does not depend on the outdoor temperature.

kcal/h = kW x 860, BTU/h = kW x 3,412

7. Cooling [Wall mounted]

YKB/YLM

7-1. Cooling capacity with PUHY-P200-250YKB-A1, EP200-250YLM-A

PKFY-P-VBM-E,VHM-E,VKM-E

CA: Capacity (kW), SHC: Sensible Heat Capacity (kW)

Model size (Rated kW)	Indoor air temp.													
	21.5°C D.B. 15°C W.B.		23°C D.B. 16°C W.B.		25°C D.B. 18°C W.B.		27°C D.B. 19°C W.B.		28°C D.B. 20°C W.B.		30°C D.B. 22°C W.B.		32°C D.B. 24°C W.B.	
	CA	SHC	CA	SHC	CA	SHC	CA	SHC	CA	SHC	CA	SHC	CA	SHC
15 (1.7)	1.5	1.1	1.6	1.2	1.7	1.1	1.7	1.2	1.8	1.2	1.9	1.2	2.0	1.2
20 (2.2)	2.0	1.4	2.0	1.5	2.2	1.5	2.2	1.5	2.3	1.5	2.4	1.5	2.6	1.5
25 (2.8)	2.5	1.8	2.6	1.8	2.8	1.8	2.8	1.9	2.9	1.9	3.1	1.9	3.2	1.8
32 (3.6)	3.2	2.5	3.3	2.6	3.5	2.6	3.6	2.7	3.7	2.7	3.9	2.7	4.2	2.6
40 (4.5)	4.1	3.1	4.2	3.2	4.4	3.1	4.5	3.3	4.7	3.3	4.9	3.2	5.2	3.2
50 (5.6)	5.0	3.6	5.2	3.7	5.5	3.7	5.6	3.9	5.8	3.9	6.1	3.8	6.5	3.7
63 (7.1)	6.4	5.0	6.6	5.2	7.0	5.1	7.1	5.4	7.4	5.4	7.8	5.3	8.2	5.2
100 (11.2)	10.1	7.4	10.4	7.6	11.0	7.5	11.2	7.8	11.6	7.8	12.2	7.7	13.0	7.6

* The capacity does not depend on the outdoor temperature.

kcal/h = kW x 860, BTU/h = kW x 3,412

7-2. Cooling capacity with PUHY-P300-400YKB-A1, EP300-350YLM-A

PKFY-P-VBM-E,VHM-E,VKM-E

CA: Capacity (kW), SHC: Sensible Heat Capacity (kW)

Model size (Rated kW)	Indoor air temp.													
	21.5°C D.B. 15°C W.B.		23°C D.B. 16°C W.B.		25°C D.B. 18°C W.B.		27°C D.B. 19°C W.B.		28°C D.B. 20°C W.B.		30°C D.B. 22°C W.B.		32°C D.B. 24°C W.B.	
	CA	SHC	CA	SHC	CA	SHC	CA	SHC	CA	SHC	CA	SHC	CA	SHC
15 (1.7)	1.5	1.1	1.6	1.2	1.7	1.1	1.7	1.2	1.8	1.2	1.9	1.2	2.0	1.2
20 (2.2)	2.0	1.4	2.0	1.5	2.2	1.5	2.2	1.5	2.3	1.5	2.4	1.5	2.6	1.5
25 (2.8)	2.5	1.8	2.6	1.8	2.8	1.8	2.8	1.9	2.9	1.9	3.1	1.9	3.2	1.8
32 (3.6)	3.2	2.5	3.3	2.6	3.5	2.6	3.6	2.7	3.7	2.7	3.9	2.7	4.2	2.6
40 (4.5)	4.1	3.1	4.2	3.2	4.4	3.1	4.5	3.3	4.7	3.3	4.9	3.2	5.2	3.2
50 (5.6)	5.0	3.6	5.2	3.7	5.5	3.7	5.6	3.9	5.8	3.9	6.1	3.8	6.5	3.7
63 (7.1)	6.4	5.0	6.6	5.2	7.0	5.1	7.1	5.4	7.4	5.4	7.8	5.3	8.2	5.2
100 (11.2)	10.1	7.4	10.4	7.6	11.0	7.5	11.2	7.8	11.6	7.8	12.2	7.7	13.0	7.6

* The capacity does not depend on the outdoor temperature.

kcal/h = kW x 860, BTU/h = kW x 3,412

7-3. Cooling capacity with PUHY-P450-500YKB-A1, EP400-500YLM-A

PKFY-P-VBM-E,VHM-E,VKM-E

CA: Capacity (kW), SHC: Sensible Heat Capacity (kW)

Model size (Rated kW)	Indoor air temp.													
	21.5°C D.B. 15°C W.B.		23°C D.B. 16°C W.B.		25°C D.B. 18°C W.B.		27°C D.B. 19°C W.B.		28°C D.B. 20°C W.B.		30°C D.B. 22°C W.B.		32°C D.B. 24°C W.B.	
	CA	SHC	CA	SHC	CA	SHC	CA	SHC	CA	SHC	CA	SHC	CA	SHC
15 (1.7)	1.5	1.1	1.6	1.1	1.7	1.1	1.7	1.2	1.8	1.2	1.9	1.2	2.0	1.2
20 (2.2)	2.0	1.4	2.0	1.5	2.2	1.4	2.2	1.5	2.3	1.5	2.4	1.5	2.6	1.5
25 (2.8)	2.5	1.8	2.6	1.8	2.7	1.8	2.8	1.9	2.9	1.9	3.1	1.9	3.3	1.9
32 (3.6)	3.2	2.5	3.3	2.6	3.5	2.6	3.6	2.7	3.8	2.7	4.0	2.7	4.2	2.7
40 (4.5)	4.1	3.1	4.1	3.2	4.4	3.1	4.5	3.3	4.7	3.3	5.0	3.3	5.3	3.2
50 (5.6)	5.0	3.6	5.1	3.7	5.5	3.7	5.6	3.9	5.8	3.9	6.2	3.8	6.6	3.8
63 (7.1)	6.4	5.0	6.5	5.1	6.9	5.1	7.1	5.4	7.4	5.4	7.9	5.4	8.4	5.3
100 (11.2)	10.1	7.4	10.3	7.5	11.0	7.4	11.2	7.8	11.7	7.8	12.4	7.7	13.2	7.6

* The capacity does not depend on the outdoor temperature.

kcal/h = kW x 860, BTU/h = kW x 3,412

7-4. Cooling capacity with PUHY-P400-650YSKB-A1, EP550-650YSLM-A

PKFY-P-VBM-E,VHM-E,VKM-E

CA: Capacity (kW), SHC: Sensible Heat Capacity (kW)

Model size (Rated kW)	Indoor air temp.													
	21.5°C D.B. 15°C W.B.		23°C D.B. 16°C W.B.		25°C D.B. 18°C W.B.		27°C D.B. 19°C W.B.		28°C D.B. 20°C W.B.		30°C D.B. 22°C W.B.		32°C D.B. 24°C W.B.	
	CA	SHC	CA	SHC	CA	SHC	CA	SHC	CA	SHC	CA	SHC	CA	SHC
15 (1.7)	1.5	1.1	1.5	1.1	1.7	1.1	1.7	1.2	1.8	1.2	1.9	1.2	2.0	1.2
20 (2.2)	2.0	1.4	2.0	1.5	2.2	1.4	2.2	1.5	2.3	1.5	2.5	1.5	2.6	1.5
25 (2.8)	2.5	1.8	2.6	1.8	2.7	1.8	2.8	1.9	2.9	1.9	3.1	1.9	3.3	1.9
32 (3.6)	3.2	2.5	3.3	2.6	3.5	2.6	3.6	2.7	3.8	2.7	4.0	2.7	4.3	2.7
40 (4.5)	4.0	3.1	4.1	3.1	4.4	3.1	4.5	3.3	4.7	3.3	5.0	3.3	5.4	3.3
50 (5.6)	5.0	3.6	5.1	3.7	5.5	3.7	5.6	3.9	5.9	3.9	6.3	3.8	6.7	3.8
63 (7.1)	6.3	5.0	6.5	5.1	6.9	5.1	7.1	5.4	7.4	5.4	7.9	5.4	8.5	5.3
100 (11.2)	10.0	7.3	10.2	7.5	11.0	7.4	11.2	7.8	11.7	7.9	12.5	7.8	13.4	7.7

* The capacity does not depend on the outdoor temperature.

kcal/h = kW x 860, BTU/h = kW x 3,412

7-5. Cooling capacity with PUHY-P700-800YSKB-A1, EP700-800YSLM-A

PKFY-P-VBM-E,VHM-E,VKM-E

CA: Capacity (kW), SHC: Sensible Heat Capacity (kW)

Model size (Rated kW)	Indoor air temp.													
	21.5°C D.B. 15°C W.B.		23°C D.B. 16°C W.B.		25°C D.B. 18°C W.B.		27°C D.B. 19°C W.B.		28°C D.B. 20°C W.B.		30°C D.B. 22°C W.B.		32°C D.B. 24°C W.B.	
	CA	SHC	CA	SHC	CA	SHC	CA	SHC	CA	SHC	CA	SHC	CA	SHC
15 (1.7)	1.5	1.1	1.5	1.1	1.6	1.1	1.7	1.2	1.8	1.2	1.9	1.2	2.0	1.2
20 (2.2)	1.9	1.4	2.0	1.4	2.1	1.4	2.2	1.5	2.3	1.5	2.4	1.5	2.6	1.5
25 (2.8)	2.5	1.8	2.5	1.8	2.7	1.8	2.8	1.9	2.9	1.9	3.1	1.9	3.3	1.9
32 (3.6)	3.2	2.5	3.3	2.6	3.5	2.6	3.6	2.7	3.7	2.7	4.0	2.7	4.2	2.7
40 (4.5)	3.9	3.0	4.1	3.1	4.4	3.1	4.5	3.3	4.7	3.3	5.0	3.3	5.3	3.2
50 (5.6)	4.9	3.6	5.1	3.7	5.4	3.7	5.6	3.9	5.8	3.9	6.2	3.8	6.6	3.8
63 (7.1)	6.2	4.9	6.4	5.1	6.9	5.1	7.1	5.4	7.4	5.4	7.9	5.4	8.3	5.3
100 (11.2)	9.8	7.2	10.1	7.4	10.9	7.4	11.2	7.8	11.6	7.8	12.4	7.7	13.2	7.6

* The capacity does not depend on the outdoor temperature.

kcal/h = kW x 860, BTU/h = kW x 3,412

7-6. Cooling capacity with PUHY-P850-1350YSKB-A1, EP850-1350YSLM-A

PKFY-P-VBM-E,VHM-E,VKM-E

CA: Capacity (kW), SHC: Sensible Heat Capacity (kW)

Model size (Rated kW)	Indoor air temp.													
	21.5°C D.B. 15°C W.B.		23°C D.B. 16°C W.B.		25°C D.B. 18°C W.B.		27°C D.B. 19°C W.B.		28°C D.B. 20°C W.B.		30°C D.B. 22°C W.B.		32°C D.B. 24°C W.B.	
	CA	SHC	CA	SHC	CA	SHC	CA	SHC	CA	SHC	CA	SHC	CA	SHC
15 (1.7)	1.5	1.1	1.5	1.1	1.7	1.1	1.7	1.2	1.8	1.2	1.9	1.2	2.0	1.2
20 (2.2)	2.0	1.4	2.0	1.5	2.2	1.4	2.2	1.5	2.3	1.5	2.5	1.5	2.6	1.5
25 (2.8)	2.5	1.8	2.6	1.8	2.7	1.8	2.8	1.9	2.9	1.9	3.1	1.9	3.3	1.9
32 (3.6)	3.2	2.5	3.3	2.6	3.5	2.6	3.6	2.7	3.8	2.7	4.0	2.7	4.3	2.7
40 (4.5)	4.0	3.1	4.1	3.1	4.4	3.1	4.5	3.3	4.7	3.3	5.0	3.3	5.4	3.3
50 (5.6)	5.0	3.6	5.1	3.7	5.5	3.7	5.6	3.9	5.9	3.9	6.3	3.8	6.7	3.8
63 (7.1)	6.3	5.0	6.5	5.1	6.9	5.1	7.1	5.4	7.4	5.4	7.9	5.4	8.5	5.3
100 (11.2)	10.0	7.3	10.2	7.5	11.0	7.4	11.2	7.8	11.7	7.9	12.5	7.8	13.4	7.7

* The capacity does not depend on the outdoor temperature.

kcal/h = kW x 860, BTU/h = kW x 3,412

7-7. Cooling capacity with PURY-(E)P200-250YLM-A(1)

PKFY-P-VBM-E,VHM-E,VKM-E

CA: Capacity (kW), SHC: Sensible Heat Capacity (kW)

Model size (Rated kW)	Indoor air temp.													
	21.5°C D.B. 15°C W.B.		23°C D.B. 16°C W.B.		25°C D.B. 18°C W.B.		27°C D.B. 19°C W.B.		28°C D.B. 20°C W.B.		30°C D.B. 22°C W.B.		32°C D.B. 24°C W.B.	
	CA	SHC	CA	SHC	CA	SHC	CA	SHC	CA	SHC	CA	SHC	CA	SHC
15 (1.7)	1.5	1.1	1.6	1.2	1.7	1.1	1.7	1.2	1.8	1.2	1.9	1.2	2.0	1.2
20 (2.2)	2.0	1.4	2.0	1.5	2.2	1.5	2.2	1.5	2.3	1.5	2.4	1.5	2.6	1.5
25 (2.8)	2.5	1.8	2.6	1.8	2.8	1.8	2.8	1.9	2.9	1.9	3.1	1.9	3.2	1.8
32 (3.6)	3.2	2.5	3.3	2.6	3.5	2.6	3.6	2.7	3.7	2.7	3.9	2.7	4.2	2.6
40 (4.5)	4.1	3.1	4.2	3.2	4.4	3.1	4.5	3.3	4.7	3.3	4.9	3.2	5.2	3.2
50 (5.6)	5.0	3.6	5.2	3.7	5.5	3.7	5.6	3.9	5.8	3.9	6.1	3.8	6.5	3.7
63 (7.1)	6.4	5.0	6.6	5.2	7.0	5.1	7.1	5.4	7.4	5.4	7.8	5.3	8.2	5.2
100 (11.2)	10.1	7.4	10.4	7.6	11.0	7.5	11.2	7.8	11.6	7.8	12.2	7.7	13.0	7.6

* The capacity does not depend on the outdoor temperature.

kcal/h = kW x 860, BTU/h = kW x 3,412

7-8. Cooling capacity with PURY-(E)P300-400Y(S)LM-A(1)

PKFY-P-VBM-E,VHM-E,VKM-E

CA: Capacity (kW), SHC: Sensible Heat Capacity (kW)

Model size (Rated kW)	Indoor air temp.													
	21.5°C D.B. 15°C W.B.		23°C D.B. 16°C W.B.		25°C D.B. 18°C W.B.		27°C D.B. 19°C W.B.		28°C D.B. 20°C W.B.		30°C D.B. 22°C W.B.		32°C D.B. 24°C W.B.	
	CA	SHC	CA	SHC	CA	SHC	CA	SHC	CA	SHC	CA	SHC	CA	SHC
15 (1.7)	1.5	1.1	1.6	1.1	1.7	1.1	1.7	1.2	1.8	1.2	1.9	1.2	2.0	1.2
20 (2.2)	2.0	1.4	2.0	1.5	2.2	1.4	2.2	1.5	2.3	1.5	2.4	1.5	2.6	1.5
25 (2.8)	2.5	1.8	2.6	1.8	2.7	1.8	2.8	1.9	2.9	1.9	3.1	1.9	3.3	1.9
32 (3.6)	3.2	2.5	3.3	2.6	3.5	2.6	3.6	2.7	3.8	2.7	4.0	2.7	4.2	2.7
40 (4.5)	4.1	3.1	4.1	3.2	4.4	3.1	4.5	3.3	4.7	3.3	5.0	3.3	5.3	3.2
50 (5.6)	5.0	3.6	5.1	3.7	5.5	3.7	5.6	3.9	5.8	3.9	6.2	3.8	6.6	3.8
63 (7.1)	6.4	5.0	6.5	5.1	6.9	5.1	7.1	5.4	7.4	5.4	7.9	5.4	8.4	5.3
100 (11.2)	10.1	7.4	10.3	7.5	11.0	7.4	11.2	7.8	11.7	7.8	12.4	7.7	13.2	7.6

* The capacity does not depend on the outdoor temperature.

kcal/h = kW x 860, BTU/h = kW x 3,412

CT

7-9. Cooling capacity with PURY-(E)P450-650Y(S)LM-A(1)

PKFY-P-VBM-E,VHM-E,VKM-E

CA: Capacity (kW), SHC: Sensible Heat Capacity (kW)

Model size (Rated kW)	Indoor air temp.													
	21.5°C D.B. 15°C W.B.		23°C D.B. 16°C W.B.		25°C D.B. 18°C W.B.		27°C D.B. 19°C W.B.		28°C D.B. 20°C W.B.		30°C D.B. 22°C W.B.		32°C D.B. 24°C W.B.	
	CA	SHC	CA	SHC	CA	SHC	CA	SHC	CA	SHC	CA	SHC	CA	SHC
15 (1.7)	1.5	1.1	1.5	1.1	1.7	1.1	1.7	1.2	1.8	1.2	1.9	1.2	2.0	1.2
20 (2.2)	2.0	1.4	2.0	1.5	2.2	1.4	2.2	1.5	2.3	1.5	2.5	1.5	2.6	1.5
25 (2.8)	2.5	1.8	2.6	1.8	2.7	1.8	2.8	1.9	2.9	1.9	3.1	1.9	3.3	1.9
32 (3.6)	3.2	2.5	3.3	2.6	3.5	2.6	3.6	2.7	3.8	2.7	4.0	2.7	4.3	2.7
40 (4.5)	4.0	3.1	4.1	3.1	4.4	3.1	4.5	3.3	4.7	3.3	5.0	3.3	5.4	3.3
50 (5.6)	5.0	3.6	5.1	3.7	5.5	3.7	5.6	3.9	5.9	3.9	6.3	3.8	6.7	3.8
63 (7.1)	6.3	5.0	6.5	5.1	6.9	5.1	7.1	5.4	7.4	5.4	7.9	5.4	8.5	5.3
100 (11.2)	10.0	7.3	10.2	7.5	11.0	7.4	11.2	7.8	11.7	7.9	12.5	7.8	13.4	7.7

* The capacity does not depend on the outdoor temperature.

kcal/h = kW x 860, BTU/h = kW x 3,412

7-10. Cooling capacity with PURY-(E)P700-800YSLM-A(1)

PKFY-P-VBM-E,VHM-E,VKM-E

CA: Capacity (kW), SHC: Sensible Heat Capacity (kW)

Model size (Rated kW)	Indoor air temp.													
	21.5°C D.B. 15°C W.B.		23°C D.B. 16°C W.B.		25°C D.B. 18°C W.B.		27°C D.B. 19°C W.B.		28°C D.B. 20°C W.B.		30°C D.B. 22°C W.B.		32°C D.B. 24°C W.B.	
	CA	SHC	CA	SHC	CA	SHC	CA	SHC	CA	SHC	CA	SHC	CA	SHC
15 (1.7)	1.5	1.1	1.5	1.1	1.6	1.1	1.7	1.2	1.8	1.2	1.9	1.2	2.0	1.2
20 (2.2)	1.9	1.4	2.0	1.4	2.1	1.4	2.2	1.5	2.3	1.5	2.4	1.5	2.6	1.5
25 (2.8)	2.5	1.8	2.5	1.8	2.7	1.8	2.8	1.9	2.9	1.9	3.1	1.9	3.3	1.9
32 (3.6)	3.2	2.5	3.3	2.6	3.5	2.6	3.6	2.7	3.7	2.7	4.0	2.7	4.2	2.7
40 (4.5)	3.9	3.0	4.1	3.1	4.4	3.1	4.5	3.3	4.7	3.3	5.0	3.3	5.3	3.2
50 (5.6)	4.9	3.6	5.1	3.7	5.4	3.7	5.6	3.9	5.8	3.9	6.2	3.8	6.6	3.8
63 (7.1)	6.2	4.9	6.4	5.1	6.9	5.1	7.1	5.4	7.4	5.4	7.9	5.4	8.3	5.3
100 (11.2)	9.8	7.2	10.1	7.4	10.9	7.4	11.2	7.8	11.6	7.8	12.4	7.7	13.2	7.6

* The capacity does not depend on the outdoor temperature.

kcal/h = kW x 860, BTU/h = kW x 3,412

7-11. Cooling capacity with PURY-(E)P850-900YSLM-A(1)

PKFY-P-VBM-E,VHM-E,VKM-E

CA: Capacity (kW), SHC: Sensible Heat Capacity (kW)

Model size (Rated kW)	Indoor air temp.													
	21.5°C D.B. 15°C W.B.		23°C D.B. 16°C W.B.		25°C D.B. 18°C W.B.		27°C D.B. 19°C W.B.		28°C D.B. 20°C W.B.		30°C D.B. 22°C W.B.		32°C D.B. 24°C W.B.	
	CA	SHC	CA	SHC	CA	SHC	CA	SHC	CA	SHC	CA	SHC	CA	SHC
15 (1.7)	1.5	1.1	1.5	1.1	1.7	1.1	1.7	1.2	1.8	1.2	1.9	1.2	2.0	1.2
20 (2.2)	2.0	1.4	2.0	1.5	2.2	1.4	2.2	1.5	2.3	1.5	2.5	1.5	2.6	1.5
25 (2.8)	2.5	1.8	2.6	1.8	2.7	1.8	2.8	1.9	2.9	1.9	3.1	1.9	3.3	1.9
32 (3.6)	3.2	2.5	3.3	2.6	3.5	2.6	3.6	2.7	3.8	2.7	4.0	2.7	4.3	2.7
40 (4.5)	4.0	3.1	4.1	3.1	4.4	3.1	4.5	3.3	4.7	3.3	5.0	3.3	5.4	3.3
50 (5.6)	5.0	3.6	5.1	3.7	5.5	3.7	5.6	3.9	5.9	3.9	6.3	3.8	6.7	3.8
63 (7.1)	6.3	5.0	6.5	5.1	6.9	5.1	7.1	5.4	7.4	5.4	7.9	5.4	8.5	5.3
100 (11.2)	10.0	7.3	10.2	7.5	11.0	7.4	11.2	7.8	11.7	7.9	12.5	7.8	13.4	7.7

* The capacity does not depend on the outdoor temperature.

kcal/h = kW x 860, BTU/h = kW x 3,412

8. Cooling [Floor standing (Exposed 2-way/Exposed/Concealed type)]

YKB/YLM

CT

8-1. Cooling capacity with PUHY-P200-250YKB-A1, EP200-250YLM-A

PFFY-P-VKM-E2

CA: Capacity (kW), SHC: Sensible Heat Capacity (kW)

Model size (Rated kW)	Indoor air temp.													
	21.5°C D.B. 15°C W.B.		23°C D.B. 16°C W.B.		25°C D.B. 18°C W.B.		27°C D.B. 19°C W.B.		28°C D.B. 20°C W.B.		30°C D.B. 22°C W.B.		32°C D.B. 24°C W.B.	
	CA	SHC	CA	SHC	CA	SHC	CA	SHC	CA	SHC	CA	SHC	CA	SHC
20 (2.2)	2.0	1.6	2.0	1.7	2.2	1.7	2.2	1.8	2.3	1.8	2.4	1.7	2.6	1.7
25 (2.8)	2.5	1.9	2.6	2.0	2.8	2.0	2.8	2.1	2.9	2.1	3.1	2.0	3.2	2.0
32 (3.6)	3.2	2.3	3.3	2.4	3.5	2.4	3.6	2.5	3.7	2.5	3.9	2.4	4.2	2.4
40 (4.5)	4.1	2.9	4.2	3.0	4.4	2.9	4.5	3.0	4.7	3.0	4.9	3.0	5.2	2.9

* The capacity does not depend on the outdoor temperature.

kcal/h = kW x 860, BTU/h = kW x 3,412

PFFY-P-VLEM-E, VLRM-E

CA: Capacity (kW), SHC: Sensible Heat Capacity (kW)

Model size (Rated kW)	Indoor air temp.													
	21.5°C D.B. 15°C W.B.		23°C D.B. 16°C W.B.		25°C D.B. 18°C W.B.		27°C D.B. 19°C W.B.		28°C D.B. 20°C W.B.		30°C D.B. 22°C W.B.		32°C D.B. 24°C W.B.	
	CA	SHC	CA	SHC	CA	SHC	CA	SHC	CA	SHC	CA	SHC	CA	SHC
20 (2.2)	2.0	1.6	2.0	1.7	2.2	1.6	2.2	1.7	2.3	1.7	2.4	1.7	2.6	1.7
25 (2.8)	2.5	1.9	2.6	1.9	2.8	1.9	2.8	2.0	2.9	2.0	3.1	2.0	3.2	1.9
32 (3.6)	3.2	2.4	3.3	2.5	3.5	2.4	3.6	2.5	3.7	2.5	3.9	2.5	4.2	2.5
40 (4.5)	4.1	3.0	4.2	3.1	4.4	3.1	4.5	3.2	4.7	3.2	4.9	3.1	5.2	3.1
50 (5.6)	5.0	3.8	5.2	3.9	5.5	3.9	5.6	4.1	5.8	4.1	6.1	4.0	6.5	3.9
63 (7.1)	6.4	4.7	6.6	4.8	7.0	4.8	7.1	5.0	7.4	5.0	7.8	4.9	8.2	4.8

* The capacity does not depend on the outdoor temperature.

kcal/h = kW x 860, BTU/h = kW x 3,412

PFFY-P-VLRMM-E

CA: Capacity (kW), SHC: Sensible Heat Capacity (kW)

Model size (Rated kW)	Indoor air temp.													
	21.5°C D.B. 15°C W.B.		23°C D.B. 16°C W.B.		25°C D.B. 18°C W.B.		27°C D.B. 19°C W.B.		28°C D.B. 20°C W.B.		30°C D.B. 22°C W.B.		32°C D.B. 24°C W.B.	
	CA	SHC	CA	SHC	CA	SHC	CA	SHC	CA	SHC	CA	SHC	CA	SHC
20 (2.2)	2.0	1.6	2.0	1.7	2.2	1.6	2.2	1.7	2.3	1.7	2.4	1.7	2.6	1.7
25 (2.8)	2.5	1.9	2.6	1.9	2.8	1.9	2.8	2.0	2.9	2.0	3.1	2.0	3.2	1.9
32 (3.6)	3.2	2.4	3.3	2.5	3.5	2.4	3.6	2.5	3.7	2.5	3.9	2.5	4.2	2.5
40 (4.5)	4.1	3.0	4.2	3.1	4.4	3.1	4.5	3.2	4.7	3.2	4.9	3.1	5.2	3.1
50 (5.6)	5.0	3.8	5.2	3.9	5.5	3.9	5.6	4.1	5.8	4.1	6.1	4.0	6.5	3.9
63 (7.1)	6.4	4.7	6.6	4.8	7.0	4.8	7.1	5.0	7.4	5.0	7.8	4.9	8.2	4.8

* The capacity does not depend on the outdoor temperature.

kcal/h = kW x 860, BTU/h = kW x 3,412

8-2. Cooling capacity with PUHY-P300-400YKB-A1, EP300-350YLM-A

PFFY-P-VKM-E2

CA: Capacity (kW), SHC: Sensible Heat Capacity (kW)

Model size (Rated kW)	Indoor air temp.													
	21.5°C D.B. 15°C W.B.		23°C D.B. 16°C W.B.		25°C D.B. 18°C W.B.		27°C D.B. 19°C W.B.		28°C D.B. 20°C W.B.		30°C D.B. 22°C W.B.		32°C D.B. 24°C W.B.	
	CA	SHC	CA	SHC	CA	SHC	CA	SHC	CA	SHC	CA	SHC	CA	SHC
20 (2.2)	2.0	1.6	2.0	1.7	2.2	1.7	2.2	1.8	2.3	1.8	2.4	1.7	2.6	1.7
25 (2.8)	2.5	1.9	2.6	2.0	2.8	2.0	2.8	2.1	2.9	2.1	3.1	2.0	3.2	2.0
32 (3.6)	3.2	2.3	3.3	2.4	3.5	2.4	3.6	2.5	3.7	2.5	3.9	2.4	4.2	2.4
40 (4.5)	4.1	2.9	4.2	3.0	4.4	2.9	4.5	3.0	4.7	3.0	4.9	3.0	5.2	2.9

* The capacity does not depend on the outdoor temperature.

kcal/h = kW x 860, BTU/h = kW x 3,412

PFFY-P-VLEM-E, VLRM-E

CA: Capacity (kW), SHC: Sensible Heat Capacity (kW)

Model size (Rated kW)	Indoor air temp.													
	21.5°C D.B. 15°C W.B.		23°C D.B. 16°C W.B.		25°C D.B. 18°C W.B.		27°C D.B. 19°C W.B.		28°C D.B. 20°C W.B.		30°C D.B. 22°C W.B.		32°C D.B. 24°C W.B.	
	CA	SHC	CA	SHC	CA	SHC	CA	SHC	CA	SHC	CA	SHC	CA	SHC
20 (2.2)	2.0	1.6	2.0	1.7	2.2	1.6	2.2	1.7	2.3	1.7	2.4	1.7	2.6	1.7
25 (2.8)	2.5	1.9	2.6	1.9	2.8	1.9	2.8	2.0	2.9	2.0	3.1	2.0	3.2	1.9
32 (3.6)	3.2	2.4	3.3	2.5	3.5	2.4	3.6	2.5	3.7	2.5	3.9	2.5	4.2	2.5
40 (4.5)	4.1	3.0	4.2	3.1	4.4	3.1	4.5	3.2	4.7	3.2	4.9	3.1	5.2	3.1
50 (5.6)	5.0	3.8	5.2	3.9	5.5	3.9	5.6	4.1	5.8	4.1	6.1	4.0	6.5	3.9
63 (7.1)	6.4	4.7	6.6	4.8	7.0	4.8	7.1	5.0	7.4	5.0	7.8	4.9	8.2	4.8

* The capacity does not depend on the outdoor temperature.

kcal/h = kW x 860, BTU/h = kW x 3,412

8. Cooling [Floor standing (Exposed 2-way/Exposed/Concealed type)]

YKB/YLM

PFFY-P-VLRMM-E

CA: Capacity (kW), SHC: Sensible Heat Capacity (kW)

Model size (Rated kW)	Indoor air temp.													
	21.5°C D.B. 15°C W.B.		23°C D.B. 16°C W.B.		25°C D.B. 18°C W.B.		27°C D.B. 19°C W.B.		28°C D.B. 20°C W.B.		30°C D.B. 22°C W.B.		32°C D.B. 24°C W.B.	
	CA	SHC	CA	SHC	CA	SHC	CA	SHC	CA	SHC	CA	SHC	CA	SHC
20 (2.2)	2.0	1.6	2.0	1.7	2.2	1.6	2.2	1.7	2.3	1.7	2.4	1.7	2.6	1.7
25 (2.8)	2.5	1.9	2.6	1.9	2.8	1.9	2.8	2.0	2.9	2.0	3.1	2.0	3.2	1.9
32 (3.6)	3.2	2.4	3.3	2.5	3.5	2.4	3.6	2.5	3.7	2.5	3.9	2.5	4.2	2.5
40 (4.5)	4.1	3.0	4.2	3.1	4.4	3.1	4.5	3.2	4.7	3.2	4.9	3.1	5.2	3.1
50 (5.6)	5.0	3.8	5.2	3.9	5.5	3.9	5.6	4.1	5.8	4.1	6.1	4.0	6.5	3.9
63 (7.1)	6.4	4.7	6.6	4.8	7.0	4.8	7.1	5.0	7.4	5.0	7.8	4.9	8.2	4.8

* The capacity does not depend on the outdoor temperature.

kcal/h = kW x 860, BTU/h = kW x 3,412

8-3. Cooling capacity with PUHY-P450-500YKB-A1, EP400-500YLM-A

PFFY-P-VKM-E2

CA: Capacity (kW), SHC: Sensible Heat Capacity (kW)

Model size (Rated kW)	Indoor air temp.													
	21.5°C D.B. 15°C W.B.		23°C D.B. 16°C W.B.		25°C D.B. 18°C W.B.		27°C D.B. 19°C W.B.		28°C D.B. 20°C W.B.		30°C D.B. 22°C W.B.		32°C D.B. 24°C W.B.	
	CA	SHC	CA	SHC	CA	SHC	CA	SHC	CA	SHC	CA	SHC	CA	SHC
20 (2.2)	2.0	1.6	2.0	1.7	2.2	1.7	2.2	1.8	2.3	1.8	2.4	1.7	2.6	1.7
25 (2.8)	2.5	1.9	2.6	2.0	2.7	2.0	2.8	2.1	2.9	2.1	3.1	2.0	3.3	2.0
32 (3.6)	3.2	2.3	3.3	2.4	3.5	2.4	3.6	2.5	3.8	2.5	4.0	2.4	4.2	2.4
40 (4.5)	4.1	2.9	4.1	2.9	4.4	2.9	4.5	3.0	4.7	3.1	5.0	3.0	5.3	3.0

* The capacity does not depend on the outdoor temperature.

kcal/h = kW x 860, BTU/h = kW x 3,412

PFFY-P-VLEM-E, VLRM-E

CA: Capacity (kW), SHC: Sensible Heat Capacity (kW)

Model size (Rated kW)	Indoor air temp.													
	21.5°C D.B. 15°C W.B.		23°C D.B. 16°C W.B.		25°C D.B. 18°C W.B.		27°C D.B. 19°C W.B.		28°C D.B. 20°C W.B.		30°C D.B. 22°C W.B.		32°C D.B. 24°C W.B.	
	CA	SHC	CA	SHC	CA	SHC	CA	SHC	CA	SHC	CA	SHC	CA	SHC
20 (2.2)	2.0	1.6	2.0	1.7	2.2	1.6	2.2	1.7	2.3	1.7	2.4	1.7	2.6	1.7
25 (2.8)	2.5	1.9	2.6	1.9	2.7	1.9	2.8	2.0	2.9	2.0	3.1	2.0	3.3	1.9
32 (3.6)	3.2	2.4	3.3	2.4	3.5	2.4	3.6	2.5	3.8	2.6	4.0	2.5	4.2	2.5
40 (4.5)	4.1	3.0	4.1	3.1	4.4	3.0	4.5	3.2	4.7	3.2	5.0	3.2	5.3	3.1
50 (5.6)	5.0	3.8	5.1	3.9	5.5	3.8	5.6	4.1	5.8	4.1	6.2	4.0	6.6	4.0
63 (7.1)	6.4	4.7	6.5	4.8	6.9	4.7	7.1	5.0	7.4	5.0	7.9	4.9	8.4	4.9

* The capacity does not depend on the outdoor temperature.

kcal/h = kW x 860, BTU/h = kW x 3,412

PFFY-P-VLRMM-E

CA: Capacity (kW), SHC: Sensible Heat Capacity (kW)

Model size (Rated kW)	Indoor air temp.													
	21.5°C D.B. 15°C W.B.		23°C D.B. 16°C W.B.		25°C D.B. 18°C W.B.		27°C D.B. 19°C W.B.		28°C D.B. 20°C W.B.		30°C D.B. 22°C W.B.		32°C D.B. 24°C W.B.	
	CA	SHC	CA	SHC	CA	SHC	CA	SHC	CA	SHC	CA	SHC	CA	SHC
20 (2.2)	2.0	1.6	2.0	1.7	2.2	1.6	2.2	1.7	2.3	1.7	2.4	1.7	2.6	1.7
25 (2.8)	2.5	1.9	2.6	1.9	2.7	1.9	2.8	2.0	2.9	2.0	3.1	2.0	3.3	1.9
32 (3.6)	3.2	2.4	3.3	2.4	3.5	2.4	3.6	2.5	3.8	2.6	4.0	2.5	4.2	2.5
40 (4.5)	4.1	3.0	4.1	3.1	4.4	3.0	4.5	3.2	4.7	3.2	5.0	3.2	5.3	3.1
50 (5.6)	5.0	3.8	5.1	3.9	5.5	3.8	5.6	4.1	5.8	4.1	6.2	4.0	6.6	4.0
63 (7.1)	6.4	4.7	6.5	4.8	6.9	4.7	7.1	5.0	7.4	5.0	7.9	4.9	8.4	4.9

* The capacity does not depend on the outdoor temperature.

kcal/h = kW x 860, BTU/h = kW x 3,412

8-4. Cooling capacity with PUHY-P400-650YSKB-A1, EP550-650YSLM-A

PFFY-P-VKM-E2

CA: Capacity (kW), SHC: Sensible Heat Capacity (kW)

Model size (Rated kW)	Indoor air temp.													
	21.5°C D.B. 15°C W.B.		23°C D.B. 16°C W.B.		25°C D.B. 18°C W.B.		27°C D.B. 19°C W.B.		28°C D.B. 20°C W.B.		30°C D.B. 22°C W.B.		32°C D.B. 24°C W.B.	
	CA	SHC	CA	SHC	CA	SHC	CA	SHC	CA	SHC	CA	SHC	CA	SHC
20 (2.2)	2.0	1.6	2.0	1.7	2.2	1.7	2.2	1.8	2.3	1.8	2.5	1.7	2.6	1.7
25 (2.8)	2.5	1.9	2.6	2.0	2.7	2.0	2.8	2.1	2.9	2.1	3.1	2.1	3.3	2.0
32 (3.6)	3.2	2.3	3.3	2.4	3.5	2.4	3.6	2.5	3.8	2.5	4.0	2.5	4.3	2.4
40 (4.5)	4.0	2.9	4.1	2.9	4.4	2.9	4.5	3.0	4.7	3.1	5.0	3.0	5.4	3.0

* The capacity does not depend on the outdoor temperature.

kcal/h = kW x 860, BTU/h = kW x 3,412

8. Cooling [Floor standing (Exposed 2-way/Exposed/Concealed type)]

YKB/YLM

CT

PFFY-P-VLEM-E,VLRM-E

CA: Capacity (kW), SHC: Sensible Heat Capacity (kW)

Model size (Rated kW)	Indoor air temp.													
	21.5°C D.B. 15°C W.B.		23°C D.B. 16°C W.B.		25°C D.B. 18°C W.B.		27°C D.B. 19°C W.B.		28°C D.B. 20°C W.B.		30°C D.B. 22°C W.B.		32°C D.B. 24°C W.B.	
	CA	SHC	CA	SHC	CA	SHC	CA	SHC	CA	SHC	CA	SHC	CA	SHC
20 (2.2)	2.0	1.6	2.0	1.6	2.2	1.6	2.2	1.7	2.3	1.8	2.5	1.7	2.6	1.7
25 (2.8)	2.5	1.9	2.6	1.9	2.7	1.9	2.8	2.0	2.9	2.0	3.1	2.0	3.3	2.0
32 (3.6)	3.2	2.4	3.3	2.4	3.5	2.4	3.6	2.5	3.8	2.6	4.0	2.5	4.3	2.5
40 (4.5)	4.0	3.0	4.1	3.0	4.4	3.0	4.5	3.2	4.7	3.2	5.0	3.2	5.4	3.1
50 (5.6)	5.0	3.8	5.1	3.9	5.5	3.8	5.6	4.1	5.9	4.1	6.3	4.0	6.7	4.0
63 (7.1)	6.3	4.7	6.5	4.8	6.9	4.7	7.1	5.0	7.4	5.0	7.9	5.0	8.5	4.9

* The capacity does not depend on the outdoor temperature.

kcal/h = kW x 860, BTU/h = kW x 3,412

PFFY-P-VLRMM-E

CA: Capacity (kW), SHC: Sensible Heat Capacity (kW)

Model size (Rated kW)	Indoor air temp.													
	21.5°C D.B. 15°C W.B.		23°C D.B. 16°C W.B.		25°C D.B. 18°C W.B.		27°C D.B. 19°C W.B.		28°C D.B. 20°C W.B.		30°C D.B. 22°C W.B.		32°C D.B. 24°C W.B.	
	CA	SHC	CA	SHC	CA	SHC	CA	SHC	CA	SHC	CA	SHC	CA	SHC
20 (2.2)	2.0	1.6	2.0	1.6	2.2	1.6	2.2	1.7	2.3	1.8	2.5	1.7	2.6	1.7
25 (2.8)	2.5	1.9	2.6	1.9	2.7	1.9	2.8	2.0	2.9	2.0	3.1	2.0	3.3	2.0
32 (3.6)	3.2	2.4	3.3	2.4	3.5	2.4	3.6	2.5	3.8	2.6	4.0	2.5	4.3	2.5
40 (4.5)	4.0	3.0	4.1	3.0	4.4	3.0	4.5	3.2	4.7	3.2	5.0	3.2	5.4	3.1
50 (5.6)	5.0	3.8	5.1	3.9	5.5	3.8	5.6	4.1	5.9	4.1	6.3	4.0	6.7	4.0
63 (7.1)	6.3	4.7	6.5	4.8	6.9	4.7	7.1	5.0	7.4	5.0	7.9	5.0	8.5	4.9

* The capacity does not depend on the outdoor temperature.

kcal/h = kW x 860, BTU/h = kW x 3,412

8-5. Cooling capacity with PUHY-P700-800YSKB-A1, EP700-800YSLM-A

PFFY-P-VKM-E2

CA: Capacity (kW), SHC: Sensible Heat Capacity (kW)

Model size (Rated kW)	Indoor air temp.													
	21.5°C D.B. 15°C W.B.		23°C D.B. 16°C W.B.		25°C D.B. 18°C W.B.		27°C D.B. 19°C W.B.		28°C D.B. 20°C W.B.		30°C D.B. 22°C W.B.		32°C D.B. 24°C W.B.	
	CA	SHC	CA	SHC	CA	SHC	CA	SHC	CA	SHC	CA	SHC	CA	SHC
20 (2.2)	1.9	1.6	2.0	1.7	2.1	1.6	2.2	1.8	2.3	1.8	2.4	1.7	2.6	1.7
25 (2.8)	2.5	1.9	2.5	1.9	2.7	1.9	2.8	2.1	2.9	2.1	3.1	2.0	3.3	2.0
32 (3.6)	3.2	2.3	3.3	2.3	3.5	2.3	3.6	2.5	3.7	2.5	4.0	2.4	4.2	2.4
40 (4.5)	3.9	2.8	4.1	2.9	4.4	2.9	4.5	3.0	4.7	3.0	5.0	3.0	5.3	3.0

* The capacity does not depend on the outdoor temperature.

kcal/h = kW x 860, BTU/h = kW x 3,412

PFFY-P-VLEM-E,VLRM-E

CA: Capacity (kW), SHC: Sensible Heat Capacity (kW)

Model size (Rated kW)	Indoor air temp.													
	21.5°C D.B. 15°C W.B.		23°C D.B. 16°C W.B.		25°C D.B. 18°C W.B.		27°C D.B. 19°C W.B.		28°C D.B. 20°C W.B.		30°C D.B. 22°C W.B.		32°C D.B. 24°C W.B.	
	CA	SHC	CA	SHC	CA	SHC	CA	SHC	CA	SHC	CA	SHC	CA	SHC
20 (2.2)	1.9	1.6	2.0	1.6	2.1	1.6	2.2	1.7	2.3	1.7	2.4	1.7	2.6	1.7
25 (2.8)	2.5	1.8	2.5	1.9	2.7	1.9	2.8	2.0	2.9	2.0	3.1	2.0	3.3	1.9
32 (3.6)	3.2	2.3	3.3	2.4	3.5	2.4	3.6	2.5	3.7	2.5	4.0	2.5	4.2	2.5
40 (4.5)	3.9	2.9	4.1	3.0	4.4	3.0	4.5	3.2	4.7	3.2	5.0	3.2	5.3	3.1
50 (5.6)	4.9	3.7	5.1	3.8	5.4	3.8	5.6	4.1	5.8	4.1	6.2	4.0	6.6	4.0
63 (7.1)	6.2	4.6	6.4	4.7	6.9	4.7	7.1	5.0	7.4	5.0	7.9	4.9	8.3	4.9

* The capacity does not depend on the outdoor temperature.

kcal/h = kW x 860, BTU/h = kW x 3,412

PFFY-P-VLRMM-E

CA: Capacity (kW), SHC: Sensible Heat Capacity (kW)

Model size (Rated kW)	Indoor air temp.													
	21.5°C D.B. 15°C W.B.		23°C D.B. 16°C W.B.		25°C D.B. 18°C W.B.		27°C D.B. 19°C W.B.		28°C D.B. 20°C W.B.		30°C D.B. 22°C W.B.		32°C D.B. 24°C W.B.	
	CA	SHC	CA	SHC	CA	SHC	CA	SHC	CA	SHC	CA	SHC	CA	SHC
20 (2.2)	1.9	1.6	2.0	1.6	2.1	1.6	2.2	1.7	2.3	1.7	2.4	1.7	2.6	1.7
25 (2.8)	2.5	1.8	2.5	1.9	2.7	1.9	2.8	2.0	2.9	2.0	3.1	2.0	3.3	1.9
32 (3.6)	3.2	2.3	3.3	2.4	3.5	2.4	3.6	2.5	3.7	2.5	4.0	2.5	4.2	2.5
40 (4.5)	3.9	2.9	4.1	3.0	4.4	3.0	4.5	3.2	4.7	3.2	5.0	3.2	5.3	3.1
50 (5.6)	4.9	3.7	5.1	3.8	5.4	3.8	5.6	4.1	5.8	4.1	6.2	4.0	6.6	4.0
63 (7.1)	6.2	4.6	6.4	4.7	6.9	4.7	7.1	5.0	7.4	5.0	7.9	4.9	8.3	4.9

* The capacity does not depend on the outdoor temperature.

kcal/h = kW x 860, BTU/h = kW x 3,412

8. Cooling [Floor standing (Exposed 2-way/Exposed/Concealed type)]

YKB/YLM

8-6. Cooling capacity with PUHY-P850-1350YSKB-A1, EP850-1350YSLM-A

PFFY-P-VKM-E2

CA: Capacity (kW), SHC: Sensible Heat Capacity (kW)

Model size (Rated kW)	Indoor air temp.													
	21.5°C D.B. 15°C W.B.		23°C D.B. 16°C W.B.		25°C D.B. 18°C W.B.		27°C D.B. 19°C W.B.		28°C D.B. 20°C W.B.		30°C D.B. 22°C W.B.		32°C D.B. 24°C W.B.	
	CA	SHC	CA	SHC	CA	SHC	CA	SHC	CA	SHC	CA	SHC	CA	SHC
20 (2.2)	2.0	1.6	2.0	1.7	2.2	1.7	2.2	1.8	2.3	1.8	2.5	1.7	2.6	1.7
25 (2.8)	2.5	1.9	2.6	2.0	2.7	2.0	2.8	2.1	2.9	2.1	3.1	2.1	3.3	2.0
32 (3.6)	3.2	2.3	3.3	2.4	3.5	2.4	3.6	2.5	3.8	2.5	4.0	2.5	4.3	2.4
40 (4.5)	4.0	2.9	4.1	2.9	4.4	2.9	4.5	3.0	4.7	3.1	5.0	3.0	5.4	3.0

* The capacity does not depend on the outdoor temperature.

kcal/h = kW x 860, BTU/h = kW x 3,412

PFFY-P-VLEM-E, VLRM-E

CA: Capacity (kW), SHC: Sensible Heat Capacity (kW)

Model size (Rated kW)	Indoor air temp.													
	21.5°C D.B. 15°C W.B.		23°C D.B. 16°C W.B.		25°C D.B. 18°C W.B.		27°C D.B. 19°C W.B.		28°C D.B. 20°C W.B.		30°C D.B. 22°C W.B.		32°C D.B. 24°C W.B.	
	CA	SHC	CA	SHC	CA	SHC	CA	SHC	CA	SHC	CA	SHC	CA	SHC
20 (2.2)	2.0	1.6	2.0	1.6	2.2	1.6	2.2	1.7	2.3	1.8	2.5	1.7	2.6	1.7
25 (2.8)	2.5	1.9	2.6	1.9	2.7	1.9	2.8	2.0	2.9	2.0	3.1	2.0	3.3	2.0
32 (3.6)	3.2	2.4	3.3	2.4	3.5	2.4	3.6	2.5	3.8	2.6	4.0	2.5	4.3	2.5
40 (4.5)	4.0	3.0	4.1	3.0	4.4	3.0	4.5	3.2	4.7	3.2	5.0	3.2	5.4	3.1
50 (5.6)	5.0	3.8	5.1	3.9	5.5	3.8	5.6	4.1	5.9	4.1	6.3	4.0	6.7	4.0
63 (7.1)	6.3	4.7	6.5	4.8	6.9	4.7	7.1	5.0	7.4	5.0	7.9	5.0	8.5	4.9

* The capacity does not depend on the outdoor temperature.

kcal/h = kW x 860, BTU/h = kW x 3,412

PFFY-P-VLRMM-E

CA: Capacity (kW), SHC: Sensible Heat Capacity (kW)

Model size (Rated kW)	Indoor air temp.													
	21.5°C D.B. 15°C W.B.		23°C D.B. 16°C W.B.		25°C D.B. 18°C W.B.		27°C D.B. 19°C W.B.		28°C D.B. 20°C W.B.		30°C D.B. 22°C W.B.		32°C D.B. 24°C W.B.	
	CA	SHC	CA	SHC	CA	SHC	CA	SHC	CA	SHC	CA	SHC	CA	SHC
20 (2.2)	2.0	1.6	2.0	1.6	2.2	1.6	2.2	1.7	2.3	1.8	2.5	1.7	2.6	1.7
25 (2.8)	2.5	1.9	2.6	1.9	2.7	1.9	2.8	2.0	2.9	2.0	3.1	2.0	3.3	2.0
32 (3.6)	3.2	2.4	3.3	2.4	3.5	2.4	3.6	2.5	3.8	2.6	4.0	2.5	4.3	2.5
40 (4.5)	4.0	3.0	4.1	3.0	4.4	3.0	4.5	3.2	4.7	3.2	5.0	3.2	5.4	3.1
50 (5.6)	5.0	3.8	5.1	3.9	5.5	3.8	5.6	4.1	5.9	4.1	6.3	4.0	6.7	4.0
63 (7.1)	6.3	4.7	6.5	4.8	6.9	4.7	7.1	5.0	7.4	5.0	7.9	5.0	8.5	4.9

* The capacity does not depend on the outdoor temperature.

kcal/h = kW x 860, BTU/h = kW x 3,412

8-7. Cooling capacity with PURY-(E)P200-250YLM-A(1)

PFFY-P-VKM-E2

CA: Capacity (kW), SHC: Sensible Heat Capacity (kW)

Model size (Rated kW)	Indoor air temp.													
	21.5°C D.B. 15°C W.B.		23°C D.B. 16°C W.B.		25°C D.B. 18°C W.B.		27°C D.B. 19°C W.B.		28°C D.B. 20°C W.B.		30°C D.B. 22°C W.B.		32°C D.B. 24°C W.B.	
	CA	SHC	CA	SHC	CA	SHC	CA	SHC	CA	SHC	CA	SHC	CA	SHC
20 (2.2)	2.0	1.6	2.0	1.7	2.2	1.7	2.2	1.8	2.3	1.8	2.4	1.7	2.6	1.7
25 (2.8)	2.5	1.9	2.6	2.0	2.8	2.0	2.8	2.1	2.9	2.1	3.1	2.0	3.2	2.0
32 (3.6)	3.2	2.3	3.3	2.4	3.5	2.4	3.6	2.5	3.7	2.5	3.9	2.4	4.2	2.4
40 (4.5)	4.1	2.9	4.2	3.0	4.4	2.9	4.5	3.0	4.7	3.0	4.9	3.0	5.2	2.9

* The capacity does not depend on the outdoor temperature.

kcal/h = kW x 860, BTU/h = kW x 3,412

PFFY-P-VLEM-E, VLRM-E

CA: Capacity (kW), SHC: Sensible Heat Capacity (kW)

Model size (Rated kW)	Indoor air temp.													
	21.5°C D.B. 15°C W.B.		23°C D.B. 16°C W.B.		25°C D.B. 18°C W.B.		27°C D.B. 19°C W.B.		28°C D.B. 20°C W.B.		30°C D.B. 22°C W.B.		32°C D.B. 24°C W.B.	
	CA	SHC	CA	SHC	CA	SHC	CA	SHC	CA	SHC	CA	SHC	CA	SHC
20 (2.2)	2.0	1.6	2.0	1.7	2.2	1.6	2.2	1.7	2.3	1.7	2.4	1.7	2.6	1.7
25 (2.8)	2.5	1.9	2.6	1.9	2.8	1.9	2.8	2.0	2.9	2.0	3.1	2.0	3.2	1.9
32 (3.6)	3.2	2.4	3.3	2.5	3.5	2.4	3.6	2.5	3.7	2.5	3.9	2.5	4.2	2.5
40 (4.5)	4.1	3.0	4.2	3.1	4.4	3.1	4.5	3.2	4.7	3.2	4.9	3.1	5.2	3.1
50 (5.6)	5.0	3.8	5.2	3.9	5.5	3.9	5.6	4.1	5.8	4.1	6.1	4.0	6.5	3.9
63 (7.1)	6.4	4.7	6.6	4.8	7.0	4.8	7.1	5.0	7.4	5.0	7.8	4.9	8.2	4.8

* The capacity does not depend on the outdoor temperature.

kcal/h = kW x 860, BTU/h = kW x 3,412

8. Cooling [Floor standing (Exposed 2-way/Exposed/Concealed type)]

YKB/YLM

CT

PFFY-P-VLRMM-E

CA: Capacity (kW), SHC: Sensible Heat Capacity (kW)

Model size (Rated kW)	Indoor air temp.													
	21.5°C D.B. 15°C W.B.		23°C D.B. 16°C W.B.		25°C D.B. 18°C W.B.		27°C D.B. 19°C W.B.		28°C D.B. 20°C W.B.		30°C D.B. 22°C W.B.		32°C D.B. 24°C W.B.	
	CA	SHC	CA	SHC	CA	SHC	CA	SHC	CA	SHC	CA	SHC	CA	SHC
20 (2.2)	2.0	1.6	2.0	1.7	2.2	1.6	2.2	1.7	2.3	1.7	2.4	1.7	2.6	1.7
25 (2.8)	2.5	1.9	2.6	1.9	2.8	1.9	2.8	2.0	2.9	2.0	3.1	2.0	3.2	1.9
32 (3.6)	3.2	2.4	3.3	2.5	3.5	2.4	3.6	2.5	3.7	2.5	3.9	2.5	4.2	2.5
40 (4.5)	4.1	3.0	4.2	3.1	4.4	3.1	4.5	3.2	4.7	3.2	4.9	3.1	5.2	3.1
50 (5.6)	5.0	3.8	5.2	3.9	5.5	3.9	5.6	4.1	5.8	4.1	6.1	4.0	6.5	3.9
63 (7.1)	6.4	4.7	6.6	4.8	7.0	4.8	7.1	5.0	7.4	5.0	7.8	4.9	8.2	4.8

* The capacity does not depend on the outdoor temperature.

kcal/h = kW x 860, BTU/h = kW x 3,412

8-8. Cooling capacity with PURY-(E)P300-400Y(S)LM-A(1)

PFFY-P-VKM-E2

CA: Capacity (kW), SHC: Sensible Heat Capacity (kW)

Model size (Rated kW)	Indoor air temp.													
	21.5°C D.B. 15°C W.B.		23°C D.B. 16°C W.B.		25°C D.B. 18°C W.B.		27°C D.B. 19°C W.B.		28°C D.B. 20°C W.B.		30°C D.B. 22°C W.B.		32°C D.B. 24°C W.B.	
	CA	SHC	CA	SHC	CA	SHC	CA	SHC	CA	SHC	CA	SHC	CA	SHC
20 (2.2)	2.0	1.6	2.0	1.7	2.2	1.7	2.2	1.8	2.3	1.8	2.4	1.7	2.6	1.7
25 (2.8)	2.5	1.9	2.6	2.0	2.7	2.0	2.8	2.1	2.9	2.1	3.1	2.0	3.3	2.0
32 (3.6)	3.2	2.3	3.3	2.4	3.5	2.4	3.6	2.5	3.8	2.5	4.0	2.4	4.2	2.4
40 (4.5)	4.1	2.9	4.1	2.9	4.4	2.9	4.5	3.0	4.7	3.1	5.0	3.0	5.3	3.0

* The capacity does not depend on the outdoor temperature.

kcal/h = kW x 860, BTU/h = kW x 3,412

PFFY-P-VLEM-E,VLRM-E

CA: Capacity (kW), SHC: Sensible Heat Capacity (kW)

Model size (Rated kW)	Indoor air temp.													
	21.5°C D.B. 15°C W.B.		23°C D.B. 16°C W.B.		25°C D.B. 18°C W.B.		27°C D.B. 19°C W.B.		28°C D.B. 20°C W.B.		30°C D.B. 22°C W.B.		32°C D.B. 24°C W.B.	
	CA	SHC	CA	SHC	CA	SHC	CA	SHC	CA	SHC	CA	SHC	CA	SHC
20 (2.2)	2.0	1.6	2.0	1.7	2.2	1.6	2.2	1.7	2.3	1.7	2.4	1.7	2.6	1.7
25 (2.8)	2.5	1.9	2.6	1.9	2.7	1.9	2.8	2.0	2.9	2.0	3.1	2.0	3.3	1.9
32 (3.6)	3.2	2.4	3.3	2.4	3.5	2.4	3.6	2.5	3.8	2.6	4.0	2.5	4.2	2.5
40 (4.5)	4.1	3.0	4.1	3.1	4.4	3.0	4.5	3.2	4.7	3.2	5.0	3.2	5.3	3.1
50 (5.6)	5.0	3.8	5.1	3.9	5.5	3.8	5.6	4.1	5.8	4.1	6.2	4.0	6.6	4.0
63 (7.1)	6.4	4.7	6.5	4.8	6.9	4.7	7.1	5.0	7.4	5.0	7.9	4.9	8.4	4.9

* The capacity does not depend on the outdoor temperature.

kcal/h = kW x 860, BTU/h = kW x 3,412

PFFY-P-VLRMM-E

CA: Capacity (kW), SHC: Sensible Heat Capacity (kW)

Model size (Rated kW)	Indoor air temp.													
	21.5°C D.B. 15°C W.B.		23°C D.B. 16°C W.B.		25°C D.B. 18°C W.B.		27°C D.B. 19°C W.B.		28°C D.B. 20°C W.B.		30°C D.B. 22°C W.B.		32°C D.B. 24°C W.B.	
	CA	SHC	CA	SHC	CA	SHC	CA	SHC	CA	SHC	CA	SHC	CA	SHC
20 (2.2)	2.0	1.6	2.0	1.7	2.2	1.6	2.2	1.7	2.3	1.7	2.4	1.7	2.6	1.7
25 (2.8)	2.5	1.9	2.6	1.9	2.7	1.9	2.8	2.0	2.9	2.0	3.1	2.0	3.3	1.9
32 (3.6)	3.2	2.4	3.3	2.4	3.5	2.4	3.6	2.5	3.8	2.6	4.0	2.5	4.2	2.5
40 (4.5)	4.1	3.0	4.1	3.1	4.4	3.0	4.5	3.2	4.7	3.2	5.0	3.2	5.3	3.1
50 (5.6)	5.0	3.8	5.1	3.9	5.5	3.8	5.6	4.1	5.8	4.1	6.2	4.0	6.6	4.0
63 (7.1)	6.4	4.7	6.5	4.8	6.9	4.7	7.1	5.0	7.4	5.0	7.9	4.9	8.4	4.9

* The capacity does not depend on the outdoor temperature.

kcal/h = kW x 860, BTU/h = kW x 3,412

8-9. Cooling capacity with PURY-(E)P450-650Y(S)LM-A(1)

PFFY-P-VKM-E2

CA: Capacity (kW), SHC: Sensible Heat Capacity (kW)

Model size (Rated kW)	Indoor air temp.													
	21.5°C D.B. 15°C W.B.		23°C D.B. 16°C W.B.		25°C D.B. 18°C W.B.		27°C D.B. 19°C W.B.		28°C D.B. 20°C W.B.		30°C D.B. 22°C W.B.		32°C D.B. 24°C W.B.	
	CA	SHC	CA	SHC	CA	SHC	CA	SHC	CA	SHC	CA	SHC	CA	SHC
20 (2.2)	2.0	1.6	2.0	1.7	2.2	1.7	2.2	1.8	2.3	1.8	2.5	1.7	2.6	1.7
25 (2.8)	2.5	1.9	2.6	2.0	2.7	2.0	2.8	2.1	2.9	2.1	3.1	2.1	3.3	2.0
32 (3.6)	3.2	2.3	3.3	2.4	3.5	2.4	3.6	2.5	3.8	2.5	4.0	2.5	4.3	2.4
40 (4.5)	4.0	2.9	4.1	2.9	4.4	2.9	4.5	3.0	4.7	3.1	5.0	3.0	5.4	3.0

* The capacity does not depend on the outdoor temperature.

kcal/h = kW x 860, BTU/h = kW x 3,412

8. Cooling [Floor standing (Exposed 2-way/Exposed/Concealed type)]

YKB/YLM

CT

PFFY-P-VLEM-E,VLRM-E

CA: Capacity (kW), SHC: Sensible Heat Capacity (kW)

Model size (Rated kW)	Indoor air temp.													
	21.5°C D.B. 15°C W.B.		23°C D.B. 16°C W.B.		25°C D.B. 18°C W.B.		27°C D.B. 19°C W.B.		28°C D.B. 20°C W.B.		30°C D.B. 22°C W.B.		32°C D.B. 24°C W.B.	
	CA	SHC	CA	SHC	CA	SHC	CA	SHC	CA	SHC	CA	SHC	CA	SHC
20 (2.2)	2.0	1.6	2.0	1.6	2.2	1.6	2.2	1.7	2.3	1.8	2.5	1.7	2.6	1.7
25 (2.8)	2.5	1.9	2.6	1.9	2.7	1.9	2.8	2.0	2.9	2.0	3.1	2.0	3.3	2.0
32 (3.6)	3.2	2.4	3.3	2.4	3.5	2.4	3.6	2.5	3.8	2.6	4.0	2.5	4.3	2.5
40 (4.5)	4.0	3.0	4.1	3.0	4.4	3.0	4.5	3.2	4.7	3.2	5.0	3.2	5.4	3.1
50 (5.6)	5.0	3.8	5.1	3.9	5.5	3.8	5.6	4.1	5.9	4.1	6.3	4.0	6.7	4.0
63 (7.1)	6.3	4.7	6.5	4.8	6.9	4.7	7.1	5.0	7.4	5.0	7.9	5.0	8.5	4.9

* The capacity does not depend on the outdoor temperature.

kcal/h = kW x 860, BTU/h = kW x 3,412

PFFY-P-VLRMM-E

CA: Capacity (kW), SHC: Sensible Heat Capacity (kW)

Model size (Rated kW)	Indoor air temp.													
	21.5°C D.B. 15°C W.B.		23°C D.B. 16°C W.B.		25°C D.B. 18°C W.B.		27°C D.B. 19°C W.B.		28°C D.B. 20°C W.B.		30°C D.B. 22°C W.B.		32°C D.B. 24°C W.B.	
	CA	SHC	CA	SHC	CA	SHC	CA	SHC	CA	SHC	CA	SHC	CA	SHC
20 (2.2)	2.0	1.6	2.0	1.6	2.2	1.6	2.2	1.7	2.3	1.8	2.5	1.7	2.6	1.7
25 (2.8)	2.5	1.9	2.6	1.9	2.7	1.9	2.8	2.0	2.9	2.0	3.1	2.0	3.3	2.0
32 (3.6)	3.2	2.4	3.3	2.4	3.5	2.4	3.6	2.5	3.8	2.6	4.0	2.5	4.3	2.5
40 (4.5)	4.0	3.0	4.1	3.0	4.4	3.0	4.5	3.2	4.7	3.2	5.0	3.2	5.4	3.1
50 (5.6)	5.0	3.8	5.1	3.9	5.5	3.8	5.6	4.1	5.9	4.1	6.3	4.0	6.7	4.0
63 (7.1)	6.3	4.7	6.5	4.8	6.9	4.7	7.1	5.0	7.4	5.0	7.9	5.0	8.5	4.9

* The capacity does not depend on the outdoor temperature.

kcal/h = kW x 860, BTU/h = kW x 3,412

8-10. Cooling capacity with PURY-(E)P700-800YSLM-A(1)

PFFY-P-VKM-E2

CA: Capacity (kW), SHC: Sensible Heat Capacity (kW)

Model size (Rated kW)	Indoor air temp.													
	21.5°C D.B. 15°C W.B.		23°C D.B. 16°C W.B.		25°C D.B. 18°C W.B.		27°C D.B. 19°C W.B.		28°C D.B. 20°C W.B.		30°C D.B. 22°C W.B.		32°C D.B. 24°C W.B.	
	CA	SHC	CA	SHC	CA	SHC	CA	SHC	CA	SHC	CA	SHC	CA	SHC
20 (2.2)	1.9	1.6	2.0	1.7	2.1	1.6	2.2	1.8	2.3	1.8	2.4	1.7	2.6	1.7
25 (2.8)	2.5	1.9	2.5	1.9	2.7	1.9	2.8	2.1	2.9	2.1	3.1	2.0	3.3	2.0
32 (3.6)	3.2	2.3	3.3	2.3	3.5	2.3	3.6	2.5	3.7	2.5	4.0	2.4	4.2	2.4
40 (4.5)	3.9	2.8	4.1	2.9	4.4	2.9	4.5	3.0	4.7	3.0	5.0	3.0	5.3	3.0

* The capacity does not depend on the outdoor temperature.

kcal/h = kW x 860, BTU/h = kW x 3,412

PFFY-P-VLEM-E,VLRM-E

CA: Capacity (kW), SHC: Sensible Heat Capacity (kW)

Model size (Rated kW)	Indoor air temp.													
	21.5°C D.B. 15°C W.B.		23°C D.B. 16°C W.B.		25°C D.B. 18°C W.B.		27°C D.B. 19°C W.B.		28°C D.B. 20°C W.B.		30°C D.B. 22°C W.B.		32°C D.B. 24°C W.B.	
	CA	SHC	CA	SHC	CA	SHC	CA	SHC	CA	SHC	CA	SHC	CA	SHC
20 (2.2)	1.9	1.6	2.0	1.6	2.1	1.6	2.2	1.7	2.3	1.7	2.4	1.7	2.6	1.7
25 (2.8)	2.5	1.8	2.5	1.9	2.7	1.9	2.8	2.0	2.9	2.0	3.1	2.0	3.3	1.9
32 (3.6)	3.2	2.3	3.3	2.4	3.5	2.4	3.6	2.5	3.7	2.5	4.0	2.5	4.2	2.5
40 (4.5)	3.9	2.9	4.1	3.0	4.4	3.0	4.5	3.2	4.7	3.2	5.0	3.2	5.3	3.1
50 (5.6)	4.9	3.7	5.1	3.8	5.4	3.8	5.6	4.1	5.8	4.1	6.2	4.0	6.6	4.0
63 (7.1)	6.2	4.6	6.4	4.7	6.9	4.7	7.1	5.0	7.4	5.0	7.9	4.9	8.3	4.9

* The capacity does not depend on the outdoor temperature.

kcal/h = kW x 860, BTU/h = kW x 3,412

PFFY-P-VLRMM-E

CA: Capacity (kW), SHC: Sensible Heat Capacity (kW)

Model size (Rated kW)	Indoor air temp.													
	21.5°C D.B. 15°C W.B.		23°C D.B. 16°C W.B.		25°C D.B. 18°C W.B.		27°C D.B. 19°C W.B.		28°C D.B. 20°C W.B.		30°C D.B. 22°C W.B.		32°C D.B. 24°C W.B.	
	CA	SHC	CA	SHC	CA	SHC	CA	SHC	CA	SHC	CA	SHC	CA	SHC
20 (2.2)	1.9	1.6	2.0	1.6	2.1	1.6	2.2	1.7	2.3	1.7	2.4	1.7	2.6	1.7
25 (2.8)	2.5	1.8	2.5	1.9	2.7	1.9	2.8	2.0	2.9	2.0	3.1	2.0	3.3	1.9
32 (3.6)	3.2	2.3	3.3	2.4	3.5	2.4	3.6	2.5	3.7	2.5	4.0	2.5	4.2	2.5
40 (4.5)	3.9	2.9	4.1	3.0	4.4	3.0	4.5	3.2	4.7	3.2	5.0	3.2	5.3	3.1
50 (5.6)	4.9	3.7	5.1	3.8	5.4	3.8	5.6	4.1	5.8	4.1	6.2	4.0	6.6	4.0
63 (7.1)	6.2	4.6	6.4	4.7	6.9	4.7	7.1	5.0	7.4	5.0	7.9	4.9	8.3	4.9

* The capacity does not depend on the outdoor temperature.

kcal/h = kW x 860, BTU/h = kW x 3,412

8-11. Cooling capacity with PURY-(E)P850-900YSLM-A(1)

PFFY-P-VKM-E2

CA: Capacity (kW), SHC: Sensible Heat Capacity (kW)

Model size (Rated kW)	Indoor air temp.													
	21.5°C D.B. 15°C W.B.		23°C D.B. 16°C W.B.		25°C D.B. 18°C W.B.		27°C D.B. 19°C W.B.		28°C D.B. 20°C W.B.		30°C D.B. 22°C W.B.		32°C D.B. 24°C W.B.	
	CA	SHC	CA	SHC	CA	SHC	CA	SHC	CA	SHC	CA	SHC	CA	SHC
20 (2.2)	2.0	1.6	2.0	1.7	2.2	1.7	2.2	1.8	2.3	1.8	2.5	1.7	2.6	1.7
25 (2.8)	2.5	1.9	2.6	2.0	2.7	2.0	2.8	2.1	2.9	2.1	3.1	2.1	3.3	2.0
32 (3.6)	3.2	2.3	3.3	2.4	3.5	2.4	3.6	2.5	3.8	2.5	4.0	2.5	4.3	2.4
40 (4.5)	4.0	2.9	4.1	2.9	4.4	2.9	4.5	3.0	4.7	3.1	5.0	3.0	5.4	3.0

* The capacity does not depend on the outdoor temperature.

kcal/h = kW x 860, BTU/h = kW x 3,412

PFFY-P-VLEM-E, VLRM-E

CA: Capacity (kW), SHC: Sensible Heat Capacity (kW)

Model size (Rated kW)	Indoor air temp.													
	21.5°C D.B. 15°C W.B.		23°C D.B. 16°C W.B.		25°C D.B. 18°C W.B.		27°C D.B. 19°C W.B.		28°C D.B. 20°C W.B.		30°C D.B. 22°C W.B.		32°C D.B. 24°C W.B.	
	CA	SHC	CA	SHC	CA	SHC	CA	SHC	CA	SHC	CA	SHC	CA	SHC
20 (2.2)	2.0	1.6	2.0	1.6	2.2	1.6	2.2	1.7	2.3	1.8	2.5	1.7	2.6	1.7
25 (2.8)	2.5	1.9	2.6	1.9	2.7	1.9	2.8	2.0	2.9	2.0	3.1	2.0	3.3	2.0
32 (3.6)	3.2	2.4	3.3	2.4	3.5	2.4	3.6	2.5	3.8	2.6	4.0	2.5	4.3	2.5
40 (4.5)	4.0	3.0	4.1	3.0	4.4	3.0	4.5	3.2	4.7	3.2	5.0	3.2	5.4	3.1
50 (5.6)	5.0	3.8	5.1	3.9	5.5	3.8	5.6	4.1	5.9	4.1	6.3	4.0	6.7	4.0
63 (7.1)	6.3	4.7	6.5	4.8	6.9	4.7	7.1	5.0	7.4	5.0	7.9	5.0	8.5	4.9

* The capacity does not depend on the outdoor temperature.

kcal/h = kW x 860, BTU/h = kW x 3,412

PFFY-P-VLRMM-E

CA: Capacity (kW), SHC: Sensible Heat Capacity (kW)

Model size (Rated kW)	Indoor air temp.													
	21.5°C D.B. 15°C W.B.		23°C D.B. 16°C W.B.		25°C D.B. 18°C W.B.		27°C D.B. 19°C W.B.		28°C D.B. 20°C W.B.		30°C D.B. 22°C W.B.		32°C D.B. 24°C W.B.	
	CA	SHC	CA	SHC	CA	SHC	CA	SHC	CA	SHC	CA	SHC	CA	SHC
20 (2.2)	2.0	1.6	2.0	1.6	2.2	1.6	2.2	1.7	2.3	1.8	2.5	1.7	2.6	1.7
25 (2.8)	2.5	1.9	2.6	1.9	2.7	1.9	2.8	2.0	2.9	2.0	3.1	2.0	3.3	2.0
32 (3.6)	3.2	2.4	3.3	2.4	3.5	2.4	3.6	2.5	3.8	2.6	4.0	2.5	4.3	2.5
40 (4.5)	4.0	3.0	4.1	3.0	4.4	3.0	4.5	3.2	4.7	3.2	5.0	3.2	5.4	3.1
50 (5.6)	5.0	3.8	5.1	3.9	5.5	3.8	5.6	4.1	5.9	4.1	6.3	4.0	6.7	4.0
63 (7.1)	6.3	4.7	6.5	4.8	6.9	4.7	7.1	5.0	7.4	5.0	7.9	5.0	8.5	4.9

* The capacity does not depend on the outdoor temperature.

kcal/h = kW x 860, BTU/h = kW x 3,412

CT

9-1. Heating capacity with PUHY-P200-250YKB-A1, EP200-250YLM-A

All indoor units

SHC: Sensible Heat Capacity (kW)

Model size (Rated kW)	Indoor air temp.			
	15°C D.B.	20°C D.B.	25°C D.B.	27°C D.B.
	SHC	SHC	SHC	SHC
15 (1.9)	1.9	1.9	1.5	1.3
20 (2.5)	2.5	2.5	2.0	1.8
25 (3.2)	3.2	3.2	2.6	2.2
32 (4.0)	4.0	4.0	3.2	2.8
40 (5.0)	5.1	5.0	4.0	3.5
50 (6.3)	6.4	6.3	5.0	4.4
63 (8.0)	8.1	8.0	6.4	5.6
71 (9.0)	9.1	9.0	7.2	6.3
80 (10.0)	10.1	10.0	8.0	7.0
100 (12.5)	12.6	12.5	10.0	8.7
125 (16.0)	16.2	16.0	12.8	11.2
140 (18.0)	18.2	18.0	14.4	12.6
200 (25.0)	25.3	25.0	20.0	17.5
250 (31.5)	31.8	31.5	25.2	22.1

* The capacity does not depend on the outdoor temperature.

kcal/h = kW x 860, BTU/h = kW x 3,412

9-2. Heating capacity with PUHY-P300-400YKB-A1, EP300-350YLM-A

All indoor units

SHC: Sensible Heat Capacity (kW)

Model size (Rated kW)	Indoor air temp.			
	15°C D.B.	20°C D.B.	25°C D.B.	27°C D.B.
	SHC	SHC	SHC	SHC
15 (1.9)	1.9	1.9	1.4	1.2
20 (2.5)	2.6	2.5	1.9	1.6
25 (3.2)	3.3	3.2	2.4	2.0
32 (4.0)	4.1	4.0	3.0	2.6
40 (5.0)	5.1	5.0	3.7	3.2
50 (6.3)	6.5	6.3	4.7	4.0
63 (8.0)	8.2	8.0	6.0	5.1
71 (9.0)	9.2	9.0	6.7	5.8
80 (10.0)	10.2	10.0	7.5	6.4
100 (12.5)	12.8	12.5	9.3	8.0
125 (16.0)	16.4	16.0	11.9	10.2
140 (18.0)	18.4	18.0	13.4	11.5
200 (25.0)	25.6	25.0	18.6	16.0
250 (31.5)	32.3	31.5	23.5	20.2

* The capacity does not depend on the outdoor temperature.

kcal/h = kW x 860, BTU/h = kW x 3,412

9-3. Heating capacity with PUHY-P450-500YKB-A1, P400-650YSKB-A1, EP400-650Y(S)LM-A

All indoor units

SHC: Sensible Heat Capacity (kW)

Model size (Rated kW)	Indoor air temp.			
	15°C D.B.	20°C D.B.	25°C D.B.	27°C D.B.
	SHC	SHC	SHC	SHC
15 (1.9)	1.9	1.9	1.5	1.3
20 (2.5)	2.5	2.5	2.0	1.8
25 (3.2)	3.3	3.2	2.5	2.3
32 (4.0)	4.1	4.0	3.2	2.8
40 (5.0)	5.1	5.0	4.0	3.5
50 (6.3)	6.4	6.3	5.0	4.5
63 (8.0)	8.2	8.0	6.3	5.7
71 (9.0)	9.2	9.0	7.1	6.4
80 (10.0)	10.2	10.0	7.9	7.1
100 (12.5)	12.7	12.5	9.9	8.9
125 (16.0)	16.3	16.0	12.7	11.3
140 (18.0)	18.4	18.0	14.3	12.8
200 (25.0)	25.5	25.0	19.8	17.7
250 (31.5)	32.1	31.5	25.0	22.3

* The capacity does not depend on the outdoor temperature.

kcal/h = kW x 860, BTU/h = kW x 3,412

9-4. Heating capacity with PUHY-P700-800YSKB-A1, EP700-800YSLM-A

All indoor units

SHC: Sensible Heat Capacity (kW)

Model size (Rated kW)	Indoor air temp.			
	15°C D.B.	20°C D.B.	25°C D.B.	27°C D.B.
	SHC	SHC	SHC	SHC
15 (1.9)	1.9	1.9	1.5	1.3
20 (2.5)	2.5	2.5	2.0	1.8
25 (3.2)	3.2	3.2	2.6	2.2
32 (4.0)	4.0	4.0	3.2	2.8
40 (5.0)	5.1	5.0	4.0	3.5
50 (6.3)	6.4	6.3	5.0	4.4
63 (8.0)	8.1	8.0	6.4	5.6
71 (9.0)	9.1	9.0	7.2	6.3
80 (10.0)	10.1	10.0	8.0	7.0
100 (12.5)	12.6	12.5	10.0	8.7
125 (16.0)	16.2	16.0	12.8	11.2
140 (18.0)	18.2	18.0	14.4	12.6
200 (25.0)	25.3	25.0	20.0	17.5
250 (31.5)	31.8	31.5	25.2	22.1

* The capacity does not depend on the outdoor temperature.

kcal/h = kW x 860, BTU/h = kW x 3,412

9-5. Heating capacity with PUHY-P850-1350YSKB-A1, EP850-1350YSLM-A

All indoor units

SHC: Sensible Heat Capacity (kW)

Model size (Rated kW)	Indoor air temp.			
	15°C D.B.	20°C D.B.	25°C D.B.	27°C D.B.
	SHC	SHC	SHC	SHC
15 (1.9)	1.9	1.9	1.4	1.2
20 (2.5)	2.6	2.5	1.9	1.6
25 (3.2)	3.3	3.2	2.4	2.0
32 (4.0)	4.1	4.0	3.0	2.6
40 (5.0)	5.1	5.0	3.7	3.2
50 (6.3)	6.5	6.3	4.7	4.0
63 (8.0)	8.2	8.0	6.0	5.1
71 (9.0)	9.2	9.0	6.7	5.8
80 (10.0)	10.2	10.0	7.5	6.4
100 (12.5)	12.8	12.5	9.3	8.0
125 (16.0)	16.4	16.0	11.9	10.2
140 (18.0)	18.4	18.0	13.4	11.5
200 (25.0)	25.6	25.0	18.6	16.0
250 (31.5)	32.3	31.5	23.5	20.2

* The capacity does not depend on the outdoor temperature.

kcal/h = kW x 860, BTU/h = kW x 3,412

9-6. Heating capacity with PURY-(E)P200-250YLM-A(1)

All indoor units

SHC: Sensible Heat Capacity (kW)

Model size (Rated kW)	Indoor air temp.			
	15°C D.B.	20°C D.B.	25°C D.B.	27°C D.B.
	SHC	SHC	SHC	SHC
15 (1.9)	1.9	1.9	1.5	1.3
20 (2.5)	2.5	2.5	2.0	1.8
25 (3.2)	3.2	3.2	2.6	2.2
32 (4.0)	4.0	4.0	3.2	2.8
40 (5.0)	5.1	5.0	4.0	3.5
50 (6.3)	6.4	6.3	5.0	4.4
63 (8.0)	8.1	8.0	6.4	5.6
71 (9.0)	9.1	9.0	7.2	6.3
80 (10.0)	10.1	10.0	8.0	7.0
100 (12.5)	12.6	12.5	10.0	8.7
125 (16.0)	16.2	16.0	12.8	11.2
140 (18.0)	18.2	18.0	14.4	12.6
200 (25.0)	25.3	25.0	20.0	17.5
250 (31.5)	31.8	31.5	25.2	22.1

* The capacity does not depend on the outdoor temperature.

kcal/h = kW x 860, BTU/h = kW x 3,412

CT

9-7. Heating capacity with PURY-(E)P300-400Y(S)LM-A(1)

All indoor units SHC: Sensible Heat Capacity (kW)

Model size (Rated kW)	Indoor air temp.			
	15°C D.B.	20°C D.B.	25°C D.B.	27°C D.B.
	SHC	SHC	SHC	SHC
15 (1.9)	1.9	1.9	1.4	1.2
20 (2.5)	2.6	2.5	1.9	1.6
25 (3.2)	3.3	3.2	2.4	2.0
32 (4.0)	4.1	4.0	3.0	2.6
40 (5.0)	5.1	5.0	3.7	3.2
50 (6.3)	6.5	6.3	4.7	4.0
63 (8.0)	8.2	8.0	6.0	5.1
71 (9.0)	9.2	9.0	6.7	5.8
80 (10.0)	10.2	10.0	7.5	6.4
100 (12.5)	12.8	12.5	9.3	8.0
125 (16.0)	16.4	16.0	11.9	10.2
140 (18.0)	18.4	18.0	13.4	11.5
200 (25.0)	25.6	25.0	18.6	16.0
250 (31.5)	32.3	31.5	23.5	20.2

* The capacity does not depend on the outdoor temperature.

kcal/h = kW x 860, BTU/h = kW x 3,412

9-8. Heating capacity with PURY-(E)P450-650Y(S)LM-A(1)

All indoor units SHC: Sensible Heat Capacity (kW)

Model size (Rated kW)	Indoor air temp.			
	15°C D.B.	20°C D.B.	25°C D.B.	27°C D.B.
	SHC	SHC	SHC	SHC
15 (1.9)	1.9	1.9	1.5	1.3
20 (2.5)	2.6	2.5	2.0	1.8
25 (3.2)	3.3	3.2	2.5	2.3
32 (4.0)	4.1	4.0	3.2	2.8
40 (5.0)	5.1	5.0	4.0	3.5
50 (6.3)	6.4	6.3	5.0	4.5
63 (8.0)	8.2	8.0	6.3	5.7
71 (9.0)	9.2	9.0	7.1	6.4
80 (10.0)	10.2	10.0	7.9	7.1
100 (12.5)	12.8	12.5	9.9	8.9
125 (16.0)	16.3	16.0	12.7	11.3
140 (18.0)	18.4	18.0	14.3	12.8
200 (25.0)	25.5	25.0	19.8	17.7
250 (31.5)	32.2	31.5	25.0	22.3

* The capacity does not depend on the outdoor temperature.

kcal/h = kW x 860, BTU/h = kW x 3,412

9-9. Heating capacity with PURY-(E)P700-800YSLM-A(1)

All indoor units SHC: Sensible Heat Capacity (kW)

Model size (Rated kW)	Indoor air temp.			
	15°C D.B.	20°C D.B.	25°C D.B.	27°C D.B.
	SHC	SHC	SHC	SHC
15 (1.9)	1.9	1.9	1.5	1.3
20 (2.5)	2.5	2.5	2.0	1.8
25 (3.2)	3.2	3.2	2.6	2.2
32 (4.0)	4.0	4.0	3.2	2.8
40 (5.0)	5.1	5.0	4.0	3.5
50 (6.3)	6.4	6.3	5.0	4.4
63 (8.0)	8.1	8.0	6.4	5.6
71 (9.0)	9.1	9.0	7.2	6.3
80 (10.0)	10.1	10.0	8.0	7.0
100 (12.5)	12.6	12.5	10.0	8.7
125 (16.0)	16.2	16.0	12.8	11.2
140 (18.0)	18.2	18.0	14.4	12.6
200 (25.0)	25.3	25.0	20.0	17.5
250 (31.5)	31.8	31.5	25.2	22.1

* The capacity does not depend on the outdoor temperature.

kcal/h = kW x 860, BTU/h = kW x 3,412

9-10. Heating capacity with PURY-(E)P850-900YSLM-A(1)

All indoor units

SHC: Sensible Heat Capacity (kW)

Model size (Rated kW)	Indoor air temp.			
	15°C D.B.	20°C D.B.	25°C D.B.	27°C D.B.
	SHC	SHC	SHC	SHC
15 (1.9)	1.9	1.9	1.4	1.2
20 (2.5)	2.6	2.5	1.9	1.6
25 (3.2)	3.3	3.2	2.4	2.0
32 (4.0)	4.1	4.0	3.0	2.6
40 (5.0)	5.1	5.0	3.7	3.2
50 (6.3)	6.5	6.3	4.7	4.0
63 (8.0)	8.2	8.0	6.0	5.1
71 (9.0)	9.2	9.0	6.7	5.8
80 (10.0)	10.2	10.0	7.5	6.4
100 (12.5)	12.8	12.5	9.3	8.0
125 (16.0)	16.4	16.0	11.9	10.2
140 (18.0)	18.4	18.0	13.4	11.5
200 (25.0)	25.6	25.0	18.6	16.0
250 (31.5)	32.3	31.5	23.5	20.2

* The capacity does not depend on the outdoor temperature.

kcal/h = kW x 860, BTU/h = kW x 3,412

9-11. Heating capacity with PUHY-P200-250YKB-A1, EP200-250YLM-A
"COP priority mode"

All indoor units

SHC: Sensible Heat Capacity (kW)

Model size (Rated kW)	Indoor air temp.			
	15°C D.B.	20°C D.B.	25°C D.B.	27°C D.B.
	SHC	SHC	SHC	SHC
15 (1.9)	1.9	1.9	1.5	1.3
20 (2.5)	2.6	2.5	2.0	1.8
25 (3.2)	3.3	3.2	2.6	2.2
32 (4.0)	4.1	4.0	3.2	2.8
40 (5.0)	5.1	5.0	4.0	3.5
50 (6.3)	6.5	6.3	5.0	4.4
63 (8.0)	8.2	8.0	6.4	5.6
71 (9.0)	9.2	9.0	7.2	6.3
80 (10.0)	10.2	10.0	8.0	7.0
100 (12.5)	12.8	12.5	10.0	8.8
125 (16.0)	16.4	16.0	12.8	11.2
140 (18.0)	18.4	18.0	14.4	12.6
200 (25.0)	25.6	25.0	20.0	17.5
250 (31.5)	32.3	31.5	25.2	22.1

* The capacity does not depend on the outdoor temperature.

kcal/h = kW x 860, BTU/h = kW x 3,412

9-12. Heating capacity with PUHY-P300-400YKB-A1, EP300-350YLM-A
"COP priority mode"

All indoor units

SHC: Sensible Heat Capacity (kW)

Model size (Rated kW)	Indoor air temp.			
	15°C D.B.	20°C D.B.	25°C D.B.	27°C D.B.
	SHC	SHC	SHC	SHC
15 (1.9)	1.9	1.9	1.5	1.3
20 (2.5)	2.6	2.5	2.0	1.8
25 (3.2)	3.3	3.2	2.6	2.2
32 (4.0)	4.1	4.0	3.2	2.8
40 (5.0)	5.1	5.0	4.0	3.5
50 (6.3)	6.5	6.3	5.0	4.4
63 (8.0)	8.2	8.0	6.4	5.6
71 (9.0)	9.2	9.0	7.2	6.3
80 (10.0)	10.2	10.0	8.0	7.0
100 (12.5)	12.8	12.5	10.0	8.8
125 (16.0)	16.4	16.0	12.8	11.2
140 (18.0)	18.4	18.0	14.4	12.6
200 (25.0)	25.6	25.0	20.0	17.5
250 (31.5)	32.3	31.5	25.2	22.1

* The capacity does not depend on the outdoor temperature.

kcal/h = kW x 860, BTU/h = kW x 3,412

CT

**9-13. Heating capacity with PUHY-P450-500YKB-A1, EP400-500YLM-A
"COP priority mode"**

All indoor units

SHC: Sensible Heat Capacity (kW)

Model size (Rated kW)	Indoor air temp.			
	15°C D.B.	20°C D.B.	25°C D.B.	27°C D.B.
	SHC	SHC	SHC	SHC
15 (1.9)	3.6	1.9	1.4	1.2
20 (2.5)	4.7	2.5	1.9	1.6
25 (3.2)	6.0	3.2	2.4	2.0
32 (4.0)	7.5	4.0	3.0	2.6
40 (5.0)	9.4	5.0	3.7	3.2
50 (6.3)	11.8	6.3	4.7	4.0
63 (8.0)	15.0	8.0	6.0	5.1
71 (9.0)	16.8	9.0	6.7	5.8
80 (10.0)	18.7	10.0	7.4	6.4
100 (12.5)	23.4	12.5	9.3	8.0
125 (16.0)	29.9	16.0	11.9	10.2
140 (18.0)	33.7	18.0	13.4	11.5
200 (25.0)	46.8	25.0	18.6	16.0
250 (31.5)	59.0	31.5	23.4	20.2

* The capacity does not depend on the outdoor temperature.

kcal/h = kW x 860, BTU/h = kW x 3,412

**9-14. Heating capacity with PUHY-P400-650YSKB-A1, EP550-650YSLM-A
"COP priority mode"**

All indoor units

SHC: Sensible Heat Capacity (kW)

Model size (Rated kW)	Indoor air temp.			
	15°C D.B.	20°C D.B.	25°C D.B.	27°C D.B.
	SHC	SHC	SHC	SHC
15 (1.9)	4.0	1.9	1.5	1.3
20 (2.5)	5.2	2.5	2.0	1.8
25 (3.2)	6.7	3.2	2.5	2.3
32 (4.0)	8.3	4.0	3.2	2.8
40 (5.0)	10.4	5.0	4.0	3.5
50 (6.3)	13.1	6.3	5.0	4.5
63 (8.0)	16.7	8.0	6.3	5.7
71 (9.0)	18.8	9.0	7.1	6.4
80 (10.0)	20.8	10.0	7.9	7.1
100 (12.5)	26.1	12.5	9.9	8.9
125 (16.0)	33.4	16.0	12.7	11.4
140 (18.0)	37.5	18.0	14.3	12.8
200 (25.0)	52.1	25.0	19.8	17.7
250 (31.5)	65.7	31.5	25.0	22.3

* The capacity does not depend on the outdoor temperature.

kcal/h = kW x 860, BTU/h = kW x 3,412

**9-15. Heating capacity with PUHY-P700-800YSKB-A1, EP700-800YSLM-A
"COP priority mode"**

All indoor units

SHC: Sensible Heat Capacity (kW)

Model size (Rated kW)	Indoor air temp.			
	15°C D.B.	20°C D.B.	25°C D.B.	27°C D.B.
	SHC	SHC	SHC	SHC
15 (1.9)	3.8	1.9	1.5	1.4
20 (2.5)	5.1	2.5	2.0	1.8
25 (3.2)	6.5	3.2	2.5	2.4
32 (4.0)	8.1	4.0	3.2	2.9
40 (5.0)	10.1	5.0	4.0	3.7
50 (6.3)	12.8	6.3	5.0	4.6
63 (8.0)	16.2	8.0	6.3	5.9
71 (9.0)	18.2	9.0	7.1	6.6
80 (10.0)	20.2	10.0	7.9	7.3
100 (12.5)	25.3	12.5	9.9	9.2
125 (16.0)	32.4	16.0	12.7	11.8
140 (18.0)	36.4	18.0	14.3	13.2
200 (25.0)	50.6	25.0	19.8	18.4
250 (31.5)	63.8	31.5	25.0	23.1

* The capacity does not depend on the outdoor temperature.

kcal/h = kW x 860, BTU/h = kW x 3,412

9-16. Heating capacity with PUHY-P850-1350YSKB-A1, EP850-1350YSLM-A "COP priority mode"

All indoor units

SHC: Sensible Heat Capacity (kW)

Model size (Rated kW)	Indoor air temp.			
	15°C D.B.	20°C D.B.	25°C D.B.	27°C D.B.
	SHC	SHC	SHC	SHC
15 (1.9)	4.0	1.9	1.5	1.3
20 (2.5)	5.2	2.5	2.0	1.8
25 (3.2)	6.7	3.2	2.5	2.3
32 (4.0)	8.3	4.0	3.2	2.8
40 (5.0)	10.4	5.0	4.0	3.5
50 (6.3)	13.1	6.3	5.0	4.5
63 (8.0)	16.7	8.0	6.3	5.7
71 (9.0)	18.8	9.0	7.1	6.4
80 (10.0)	20.8	10.0	7.9	7.1
100 (12.5)	26.1	12.5	9.9	8.9
125 (16.0)	33.4	16.0	12.7	11.4
140 (18.0)	37.5	18.0	14.3	12.8
200 (25.0)	52.1	25.0	19.8	17.7
250 (31.5)	65.7	31.5	25.0	22.3

* The capacity does not depend on the outdoor temperature.

kcal/h = kW x 860, BTU/h = kW x 3,412

9-17. Heating capacity with PURY-(E)P200-250YLM-A(1) "COP priority mode"

All indoor units

SHC: Sensible Heat Capacity (kW)

Model size (Rated kW)	Indoor air temp.			
	15°C D.B.	20°C D.B.	25°C D.B.	27°C D.B.
	SHC	SHC	SHC	SHC
15 (1.9)	1.9	1.9	1.5	1.3
20 (2.5)	2.5	2.5	2.0	1.8
25 (3.2)	3.3	3.2	2.6	2.2
32 (4.0)	4.1	4.0	3.2	2.8
40 (5.0)	5.1	5.0	4.0	3.5
50 (6.3)	6.4	6.3	5.0	4.4
63 (8.0)	8.1	8.0	6.4	5.6
71 (9.0)	9.2	9.0	7.2	6.3
80 (10.0)	10.2	10.0	8.0	7.0
100 (12.5)	12.7	12.5	10.0	8.8
125 (16.0)	16.3	16.0	12.8	11.2
140 (18.0)	18.3	18.0	14.4	12.6
200 (25.0)	25.4	25.0	20.0	17.5
250 (31.5)	32.0	31.5	25.2	22.1

* The capacity does not depend on the outdoor temperature.

kcal/h = kW x 860, BTU/h = kW x 3,412

9-18. Heating capacity with PURY-(E)P300-400Y(S)LM-A(1) "COP priority mode"

All indoor units

SHC: Sensible Heat Capacity (kW)

Model size (Rated kW)	Indoor air temp.			
	15°C D.B.	20°C D.B.	25°C D.B.	27°C D.B.
	SHC	SHC	SHC	SHC
15 (1.9)	3.6	1.9	1.4	1.2
20 (2.5)	4.7	2.5	1.9	1.6
25 (3.2)	6.0	3.2	2.4	2.0
32 (4.0)	7.5	4.0	3.0	2.6
40 (5.0)	9.4	5.0	3.7	3.2
50 (6.3)	11.8	6.3	4.7	4.0
63 (8.0)	15.0	8.0	6.0	5.1
71 (9.0)	16.8	9.0	6.7	5.8
80 (10.0)	18.7	10.0	7.4	6.4
100 (12.5)	23.4	12.5	9.3	8.0
125 (16.0)	29.9	16.0	11.9	10.2
140 (18.0)	33.7	18.0	13.4	11.5
200 (25.0)	46.8	25.0	18.6	16.0
250 (31.5)	59.0	31.5	23.4	20.2

* The capacity does not depend on the outdoor temperature.

kcal/h = kW x 860, BTU/h = kW x 3,412

CT

9-19. Heating capacity with PURY-(E)P450-650Y(S)LM-A(1) "COP priority mode"

All indoor units SHC: Sensible Heat Capacity (kW)

Model size (Rated kW)	Indoor air temp.			
	15°C D.B.	20°C D.B.	25°C D.B.	27°C D.B.
	SHC	SHC	SHC	SHC
15 (1.9)	4.0	1.9	1.5	1.3
20 (2.5)	5.2	2.5	2.0	1.8
25 (3.2)	6.7	3.2	2.5	2.3
32 (4.0)	8.3	4.0	3.2	2.8
40 (5.0)	10.4	5.0	4.0	3.5
50 (6.3)	13.1	6.3	5.0	4.5
63 (8.0)	16.7	8.0	6.3	5.7
71 (9.0)	18.8	9.0	7.1	6.4
80 (10.0)	20.8	10.0	7.9	7.1
100 (12.5)	26.1	12.5	9.9	8.9
125 (16.0)	33.4	16.0	12.7	11.4
140 (18.0)	37.5	18.0	14.3	12.8
200 (25.0)	52.1	25.0	19.8	17.7
250 (31.5)	65.7	31.5	25.0	22.3

* The capacity does not depend on the outdoor temperature.

kcal/h = kW x 860, BTU/h = kW x 3,412

9-20. Heating capacity with PURY-(E)P700-800YSLM-A(1) "COP priority mode"

All indoor units SHC: Sensible Heat Capacity (kW)

Model size (Rated kW)	Indoor air temp.			
	15°C D.B.	20°C D.B.	25°C D.B.	27°C D.B.
	SHC	SHC	SHC	SHC
15 (1.9)	3.8	1.9	1.5	1.4
20 (2.5)	5.1	2.5	2.0	1.8
25 (3.2)	6.5	3.2	2.5	2.4
32 (4.0)	8.1	4.0	3.2	2.9
40 (5.0)	10.1	5.0	4.0	3.7
50 (6.3)	12.8	6.3	5.0	4.6
63 (8.0)	16.2	8.0	6.3	5.9
71 (9.0)	18.2	9.0	7.1	6.6
80 (10.0)	20.2	10.0	7.9	7.3
100 (12.5)	25.3	12.5	9.9	9.2
125 (16.0)	32.4	16.0	12.7	11.8
140 (18.0)	36.4	18.0	14.3	13.2
200 (25.0)	50.6	25.0	19.8	18.4
250 (31.5)	63.8	31.5	25.0	23.1

* The capacity does not depend on the outdoor temperature.

kcal/h = kW x 860, BTU/h = kW x 3,412

9-21. Heating capacity with PURY-(E)P850-900YSLM-A(1) "COP priority mode"

All indoor units SHC: Sensible Heat Capacity (kW)

Model size (Rated kW)	Indoor air temp.			
	15°C D.B.	20°C D.B.	25°C D.B.	27°C D.B.
	SHC	SHC	SHC	SHC
15 (1.9)	4.0	1.9	1.5	1.3
20 (2.5)	5.2	2.5	2.0	1.8
25 (3.2)	6.7	3.2	2.5	2.3
32 (4.0)	8.3	4.0	3.2	2.8
40 (5.0)	10.4	5.0	4.0	3.5
50 (6.3)	13.1	6.3	5.0	4.5
63 (8.0)	16.7	8.0	6.3	5.7
71 (9.0)	18.8	9.0	7.1	6.4
80 (10.0)	20.8	10.0	7.9	7.1
100 (12.5)	26.1	12.5	9.9	8.9
125 (16.0)	33.4	16.0	12.7	11.4
140 (18.0)	37.5	18.0	14.3	12.8
200 (25.0)	52.1	25.0	19.8	17.7
250 (31.5)	65.7	31.5	25.0	22.3

* The capacity does not depend on the outdoor temperature.

kcal/h = kW x 860, BTU/h = kW x 3,412

CITY MULTI

2. OUTDOOR UNITS

GENERAL LINE-UP.....	2 - 2
Y SERIES	2 - 7
Y (High COP) SERIES.....	2 - 113
R2 SERIES	2 - 213
R2 (High COP) SERIES.....	2 - 293

Line-up of Outdoor Units of R410A CITY MULTI

Heat Pump Y Series



PUHY-P200YKB-A1(-BS)

PUHY-P250YKB-A1(-BS)

8, 10HP



PUHY-P300YKB-A1(-BS)
PUHY-P400YKB-A1(-BS)

PUHY-P350YKB-A1(-BS)

12, 14, 16HP



PUHY-P450YKB-A1(-BS)

PUHY-P500YKB-A1(-BS)

18, 20HP



PUHY-P400YSKB-A1(-BS)
PUHY-P500YSKB-A1(-BS)

PUHY-P450YSKB-A1(-BS)

16, 18, 20HP



PUHY-P550YSKB-A1(-BS)

PUHY-P600YSKB-A1(-BS)

22, 24HP



PUHY-P650YSKB-A1(-BS)
PUHY-P750YSKB-A1(-BS)

PUHY-P700YSKB-A1(-BS)

26, 28, 30HP



PUHY-P800YSKB-A1(-BS)

PUHY-P850YSKB-A1(-BS)

32, 34HP



PUHY-P900YSKB-A1(-BS)

36HP



PUHY-P950YSKB-A1(-BS)

38HP



PUHY-P1000YSKB-A1(-BS)
PUHY-P1100YSKB-A1(-BS)

PUHY-P1050YSKB-A1(-BS)

40, 42, 44HP



PUHY-P1150YSKB-A1(-BS)

PUHY-P1200YSKB-A1(-BS)

46, 48HP



PUHY-P1250YSKB-A1(-BS)

PUHY-P1300YSKB-A1(-BS)

50, 52HP



PUHY-P1350YSKB-A1(-BS)

54HP

Heat Pump High COP Y Series



PUHY-EP200YLM-A(-BS)

PUHY-EP250YLM-A(-BS)

8, 10HP



PUHY-EP300YLM-A(-BS)

PUHY-EP350YLM-A(-BS)

12, 14HP



PUHY-EP400YLM-A(-BS)

PUHY-EP450YLM-A(-BS)

PUHY-EP500YLM-A(-BS)

16, 18, 20HP



PUHY-EP550YSLM-A(-BS)

22HP



PUHY-EP600YSLM-A(-BS)

24HP



PUHY-EP650YSLM-A(-BS)

26HP



PUHY-EP700YSLM-A(-BS) PUHY-EP750YSLM-A(-BS)

28, 30HP



PUHY-EP800YSLM-A(-BS) PUHY-EP850YSLM-A(-BS)

32, 34HP



PUHY-EP900YSLM-A(-BS) PUHY-EP950YSLM-A(-BS)

36, 38HP



PUHY-EP1000YSLM-A(-BS) PUHY-EP1050YSLM-A(-BS)
PUHY-EP1100YSLM-A(-BS) PUHY-EP1150YSLM-A(-BS)

40, 42, 44, 46HP



PUHY-EP1200YSLM-A(-BS) PUHY-EP1250YSLM-A(-BS)

48, 50HP



PUHY-EP1300YSLM-A(-BS) PUHY-EP1350YSLM-A(-BS)

52, 54HP

Heat Recovery R2 Series



PURY-P200YLM-A1(-BS) PURY-P250YLM-A1(-BS)

8, 10HP



PURY-P300YLM-A1(-BS) PURY-P350YLM-A1(-BS)
PURY-P400YLM-A1(-BS)

12, 14, 16HP



PURY-P450YLM-A1(-BS) PURY-P500YLM-A1(-BS)

18, 20HP



PURY-P400YSLM-A1(-BS) PURY-P450YSLM-A1(-BS)
PURY-P500YSLM-A1(-BS)

16, 18, 20HP



PURY-P550YSLM-A1(-BS)

22HP



PURY-P600YSLM-A1(-BS) PURY-P650YSLM-A1(-BS)
PURY-P700YSLM-A1(-BS) PURY-P750YSLM-A1(-BS)
PURY-P800YSLM-A1(-BS)

24, 26, 28, 30, 32HP



PURY-P850YSLM-A1(-BS)

34HP



PURY-P900YSLM-A1(-BS)

36HP

Heat Recovery High COP R2 Series



PURY-EP200YLM-A(-BS) PURY-EP250YLM-A(-BS)

8, 10HP



PURY-EP300YLM-A(-BS) PURY-EP350YLM-A(-BS)

12, 14HP



PURY-EP400YLM-A(-BS) PURY-EP450YLM-A(-BS)
PURY-EP500YLM-A(-BS)

16, 18, 20HP



PURY-EP550YSLM-A(-BS)

22HP



PURY-EP600YSLM-A(-BS) PURY-EP650YSLM-A(-BS)
PURY-EP700YSLM-A(-BS)

24, 26, 28HP



PURY-EP750YSLM-A(-BS)

30HP



PURY-EP800YSLM-A(-BS) PURY-EP850YSLM-A(-BS)
PURY-EP900YSLM-A(-BS)

32, 34, 36HP

OUTDOOR UNITS

1. SPECIFICATIONS	2 - 8
2. EXTERNAL DIMENSIONS	2 - 32
3. CENTER OF GRAVITY	2 - 48
4. ELECTRICAL WIRING DIAGRAMS	2 - 49
5. SOUND LEVELS	2 - 51
6. VIBRATION LEVEL	2 - 60
7. OPERATION TEMPERATURE RANGE	2 - 61
8. CAPACITY TABLES	2 - 62
8-1. Selection of Cooling/Heating Units	2 - 62
8-2. Correction by temperature	2 - 64
8-3. Correction by total indoor	2 - 88
8-4. Correction by refrigerant piping length	2 - 102
8-5. Correction at frost and defrost	2 - 106
9. OPTIONAL PARTS	2 - 107
9-1. JOINT	2 - 107
9-2. HEADER	2 - 108
9-3. OUTDOOR TWINNING KIT	2 - 109
9-4. RELAY BOX	2 - 110
9-5. BASE HEATER	2 - 111

1. SPECIFICATIONS

YKB/YLM

Model			PUHY-P200YKB-A1 (-BS)	PUHY-P250YKB-A1 (-BS)	
Power source			3-phase 4-wire 380-400-415 V 50/60 Hz	3-phase 4-wire 380-400-415 V 50/60 Hz	
Cooling capacity (Nominal)	*1	kW	22.4	28.0	
		kcal/h	20,000	25,000	
		BTU/h	76,400	95,500	
	*1	Power input	kW	5.19	6.88
		Current input	A	8.7-8.3-8.0	11.6-11.0-10.6
		EER	kW/kW	4.31	4.06
Temp. range of cooling	Indoor	W.B.	15.0~24.0°C (59~75°F)	15.0~24.0°C (59~75°F)	
	Outdoor	D.B.	-5.0~52.0°C (23~126°F)	-5.0~52.0°C (23~126°F)	
Heating capacity (Nominal)	*2	kW	25.0	31.5	
		kcal/h	21,500	27,100	
		BTU/h	85,300	107,500	
	*2	Power input	kW	5.81	7.34
		Current input	A	9.8-9.3-8.9	12.3-11.7-11.3
		COP	kW/kW	4.30	4.29
Temp. range of heating	Indoor	D.B.	15.0~27.0°C (59~81°F)	15.0~27.0°C (59~81°F)	
	Outdoor	W.B.	-20.0~15.5°C (-4~60°F)	-20.0~15.5°C (-4~60°F)	
Indoor unit connectable	Total capacity		50~130% of outdoor unit capacity	50~130% of outdoor unit capacity	
	Model/Quantity		P15~P250/1~17	P15~P250/1~21	
Sound pressure level (measured in anechoic room)	dB <A>		57	59	
Sound power level (measured in anechoic room)	dB <A>		78	79	
Refrigerant piping diameter	Liquid pipe	mm (in.)	9.52 (3/8) Brazed	9.52 (3/8) Brazed (12.7 (1/2) Brazed, farthest length >= 90 m)	
	Gas pipe	mm (in.)	22.2 (7/8) Brazed	22.2 (7/8) Brazed	
FAN	Type x Quantity		Propeller fan x 1	Propeller fan x 1	
	Air flow rate	m ³ /min	175	175	
		L/s	2,917	2,917	
		cfm	6,179	6,179	
	Control, Driving mechanism		Inverter-control, Direct-driven by motor	Inverter-control, Direct-driven by motor	
	Motor output	kW	0.92 x 1	0.92 x 1	
*3 External static press.		0 Pa (0 mmH ₂ O)	0 Pa (0 mmH ₂ O)		
Compressor	Type x Quantity		Inverter scroll hermetic compressor	Inverter scroll hermetic compressor	
	Manufacture		AC&R Works, MITSUBISHI ELECTRIC CORPORATION	AC&R Works, MITSUBISHI ELECTRIC CORPORATION	
	Starting method		Inverter	Inverter	
	Motor output	kW	5.5	6.9	
	Case heater	kW	-	-	
	Lubricant		MEL32	MEL32	
External finish			Pre-coated galvanized steel sheets (+powder coating for -BS type) <MUNSELL 5Y 8/1 or similar>	Pre-coated galvanized steel sheets (+powder coating for -BS type) <MUNSELL 5Y 8/1 or similar>	
External dimension H x W x D		mm	1,710 (1,650 without legs) x 920 x 740	1,710 (1,650 without legs) x 920 x 740	
		in.	67-3/8 (65 without legs) x 36-1/4 x 29-3/16	67-3/8 (65 without legs) x 36-1/4 x 29-3/16	
Protection devices	High pressure protection		High pressure sensor, High pressure switch at 4.15 MPa (601 psi)	High pressure sensor, High pressure switch at 4.15 MPa (601 psi)	
	Inverter circuit (COMP./FAN)		Over-heat protection, Over-current protection	Over-heat protection, Over-current protection	
	Compressor		-	-	
	Fan motor		-	-	
Refrigerant	Type x original charge		R410A x 6.5 kg (15 lbs)	R410A x 8.0 kg (18 lbs)	
	Control		LEV and HIC circuit	LEV and HIC circuit	
Net weight		kg (lbs)	190 (419)	199 (439)	
Heat exchanger			Salt-resistant cross fin & copper tube	Salt-resistant cross fin & copper tube	
HIC circuit (HIC: Heat Inter-Changer)			Copper pipe, tube-in-tube structure	Copper pipe, tube-in-tube structure	
Defrosting method			Auto-defrost mode (Reversed refrigerant cycle, Hot gas)	Auto-defrost mode (Reversed refrigerant cycle, Hot gas)	
Drawing	External		KJ94R996	KJ94R996	
	Wiring		KE94G038	KE94G038	
Standard attachment	Document		Installation Manual	Installation Manual	
	Accessory		Refrigerant conn. pipe	Refrigerant conn. pipe	
Optional parts			Joint: CMY-Y102SS/LS-G2 Header: CMY-Y104/108/1010-G	Joint: CMY-Y102SS/LS-G2 Header: CMY-Y104/108/1010-G	
Remarks			Details on foundation work, duct work, insulation work, electrical wiring, power source switch, and other items shall be referred to the Installation Manual. Due to continuing improvement, above specifications may be subject to change without notice.		

Notes:	Unit converter
1.Nominal cooling conditions (subject to JIS B8615-2) Indoor: 27°C D.B./19°C W.B. (81°F D.B./66°F W.B.), Outdoor: 35°C D.B./24°C W.B. (95°F D.B./75°F W.B.) Pipe length: 7.5 m (24-9/16 ft.), Level difference: 0 m (0 ft.)	BTU/h =kW x 3,412
2.Nominal heating conditions (subject to JIS B8615-2) Indoor: 20°C D.B. (68°F D.B.), Outdoor: 7°C D.B./6°C W.B. (45°F D.B./43°F W.B.) Pipe length: 7.5 m (24-9/16 ft.), Level difference: 0 m (0 ft.)	cfm =m ³ /min x 35.31
3.External static pressure option is available (30Pa, 60Pa/3.1mmH ₂ O, 6.1mmH ₂ O).	lbs =kg/0.4536
	*Above specification data is subject to rounding variation.

1. SPECIFICATIONS

YKB/YLM

Model		PUHY-P300YKB-A1 (-BS)		PUHY-P350YKB-A1 (-BS)	
Power source		3-phase 4-wire 380-400-415 V 50/60 Hz		3-phase 4-wire 380-400-415 V 50/60 Hz	
Cooling capacity (Nominal)	*1	kW	33.5	40.0	
		kcal/h	30,000	35,000	
		BTU/h	114,300	136,500	
	Power input	kW	8.56	11.69	
		A	14.4-13.7-13.2	19.7-18.7-18.0	
EER	kW/kW	3.91	3.42		
Temp. range of cooling	Indoor	W.B.	15.0~24.0°C (59~75°F)	15.0~24.0°C (59~75°F)	
	Outdoor	D.B.	-5.0~52.0°C (23~126°F)	-5.0~52.0°C (23~126°F)	
Heating capacity (Nominal)	*2	kW	37.5	45.0	
		kcal/h	32,300	38,700	
		BTU/h	128,000	153,500	
	Power input	kW	9.07	11.13	
		A	15.3-14.5-14.0	18.7-17.8-17.2	
COP	kW/kW	4.13	4.04		
Temp. range of heating	Indoor	D.B.	15.0~27.0°C (59~81°F)	15.0~27.0°C (59~81°F)	
	Outdoor	W.B.	-20.0~15.5°C (-4~60°F)	-20.0~15.5°C (-4~60°F)	
Indoor unit connectable	Total capacity	50~130% of outdoor unit capacity		50~130% of outdoor unit capacity	
	Model/Quantity	P15-P250/1~26		P15-P250/1~30	
Sound pressure level (measured in anechoic room)	dB <A>	61		61	
Sound power level (measured in anechoic room)	dB <A>	83		83	
Refrigerant piping diameter	Liquid pipe	mm (in.)	9.52 (3/8) Brazed (12.7 (1/2) Brazed, farthest length >= 40 m)	12.7 (1/2) Brazed	
	Gas pipe	mm (in.)	22.2 (7/8) Brazed	28.58 (1-1/8) Brazed	
FAN	Type x Quantity		Propeller fan x 1		
	Air flow rate	m ³ /min	210	210	
		L/s	3,500	3,500	
		cfm	7,415	7,415	
	Control, Driving mechanism		Inverter-control, Direct-driven by motor		
Motor output	kW	0.92 x 1	0.92 x 1		
*3 External static press.		0 Pa (0 mmH ₂ O)		0 Pa (0 mmH ₂ O)	
Compressor	Type x Quantity		Inverter scroll hermetic compressor		
	Manufacture		AC&R Works, MITSUBISHI ELECTRIC CORPORATION		
	Starting method		Inverter		
	Motor output	kW	8.1	10.5	
	Case heater	kW	-	-	
Lubricant		MEL32		MEL32	
External finish		Pre-coated galvanized steel sheets (+powder coating for -BS type) <MUNSELL 5Y 8/1 or similar>		Pre-coated galvanized steel sheets (+powder coating for -BS type) <MUNSELL 5Y 8/1 or similar>	
External dimension H x W x D	mm		1,710 (1,650 without legs) x 1,220 x 740		
	in.		67-3/8 (65 without legs) x 48-1/16 x 29-3/16		
Protection devices	High pressure protection		High pressure sensor, High pressure switch at 4.15 MPa (601 psi)		
	Inverter circuit (COMP./FAN)		Over-heat protection, Over-current protection		
	Compressor		-		
	Fan motor		-		
Refrigerant	Type x original charge		R410A x 11.5 kg (26 lbs)		
	Control		LEV and HIC circuit		
Net weight	kg (lbs)	251 (554)		251 (554)	
Heat exchanger		Salt-resistant cross fin & aluminium tube		Salt-resistant cross fin & copper tube	
HIC circuit (HIC: Heat Inter-Changer)		Copper pipe, tube-in-tube structure		Copper pipe, tube-in-tube structure	
Defrosting method		Auto-defrost mode (Reversed refrigerant cycle, Hot gas)		Auto-defrost mode (Reversed refrigerant cycle, Hot gas)	
Drawing	External	KJ94R997		KJ94R997	
	Wiring	KE94G038		KE94G038	
Standard attachment	Document	Installation Manual		Installation Manual	
	Accessory	Refrigerant conn. pipe		Refrigerant conn. pipe	
Optional parts		Joint: CMY-Y102SS/LS-G2 Header: CMY-Y104/108/1010-G		Joint: CMY-Y102SS/LS-G2, CMY-Y202S-G2 Header: CMY-Y104/108/1010-G	
Remarks		Details on foundation work, duct work, insulation work, electrical wiring, power source switch, and other items shall be referred to the Installation Manual. Due to continuing improvement, above specifications may be subject to change without notice.			

Notes:	Unit converter
1.Nominal cooling conditions (subject to JIS B8615-2) Indoor: 27°C D.B./19°C W.B. (81°F D.B./66°F W.B.), Outdoor: 35°C D.B./24°C W.B. (95°F D.B./75°F W.B.) Pipe length: 7.5 m (24-9/16 ft.), Level difference: 0 m (0 ft.)	BTU/h =kW x 3,412 cfm =m ³ /min x 35.31 lbs =kg/0.4536
2.Nominal heating conditions (subject to JIS B8615-2) Indoor: 20°C D.B. (68°F D.B.), Outdoor: 7°C D.B./6°C W.B. (45°F D.B./43°F W.B.) Pipe length: 7.5 m (24-9/16 ft.), Level difference: 0 m (0 ft.)	
3.External static pressure option is available (30Pa, 60Pa/3.1mmH ₂ O, 6.1mmH ₂ O).	
	*Above specification data is subject to rounding variation.

1. SPECIFICATIONS

YKB/YLM

Model			PUHY-P400YKB-A1 (-BS)	PUHY-P450YKB-A1 (-BS)	
Power source			3-phase 4-wire 380-400-415 V 50/60 Hz		
Cooling capacity (Nominal)	*1	kW	45.0	50.0	
		kcal/h	40,000	45,000	
		BTU/h	153,500	170,600	
	*1	Power input	kW	13.55	14.79
		Current input	A	22.8-21.7-20.9	24.9-23.7-22.8
		EER	kW/kW	3.32	3.38
Temp. range of cooling	Indoor	W.B.	15.0~24.0°C (59~75°F)	15.0~24.0°C (59~75°F)	
	Outdoor	D.B.	-5.0~52.0°C (23~126°F)	-5.0~52.0°C (23~126°F)	
Heating capacity (Nominal)	*2	kW	50.0	56.0	
		kcal/h	45,000	50,000	
		BTU/h	170,600	191,100	
	*2	Power input	kW	12.50	15.55
		Current input	A	21.1-20.0-19.3	26.2-24.9-24.0
		COP	kW/kW	4.00	3.60
Temp. range of heating	Indoor	D.B.	15.0~27.0°C (59~81°F)	15.0~27.0°C (59~81°F)	
	Outdoor	W.B.	-20.0~15.5°C (-4~60°F)	-20.0~15.5°C (-4~60°F)	
Indoor unit connectable	Total capacity		50~130% of outdoor unit capacity		
	Model/Quantity		P15~P250/1~34		
Sound pressure level (measured in anechoic room)		dB <A>	63	66	
Sound power level (measured in anechoic room)		dB <A>	83	85	
Refrigerant piping diameter	Liquid pipe	mm (in.)	12.7 (1/2) Brazed	15.88 (5/8) Brazed	
	Gas pipe	mm (in.)	28.58 (1-1/8) Brazed	28.58 (1-1/8) Brazed	
FAN	Type x Quantity		Propeller fan x 1		
	Air flow rate	m ³ /min	210	360	
		L/s	3,500	6,000	
		cfm	7,415	12,712	
	Control, Driving mechanism		Inverter-control, Direct-driven by motor		
	Motor output	kW	0.92 x 1	0.92 x 2	
*3 External static press.		0 Pa (0 mmH ₂ O)			
Compressor	Type x Quantity		Inverter scroll hermetic compressor		
	Manufacture		AC&R Works, MITSUBISHI ELECTRIC CORPORATION		
	Starting method		Inverter		
	Motor output	kW	10.8	12.4	
	Case heater	kW	-	0.045	
	Lubricant		MEL32		
External finish		Pre-coated galvanized steel sheets (+powder coating for -BS type) <MUNSELL 5Y 8/1 or similar>			
External dimension H x W x D	mm		1,710 (1,650 without legs) x 1,220 x 740		
	in.		67-3/8 (65 without legs) x 48-1/16 x 29-3/16		
Protection devices	High pressure protection		High pressure sensor, High pressure switch at 4.15 MPa (601 psi)		
	Inverter circuit (COMP./FAN)		Over-heat protection, Over-current protection		
	Compressor		-		
	Fan motor		-		
Refrigerant	Type x original charge		R410A x 11.5 kg (26 lbs)		
	Control		LEV and HIC circuit		
Net weight		kg (lbs)	251 (554)	304 (671)	
Heat exchanger		Salt-resistant cross fin & copper tube			
HIC circuit (HIC: Heat Inter-Changer)		Copper pipe, tube-in-tube structure			
Defrosting method		Auto-defrost mode (Reversed refrigerant cycle, Hot gas)			
Drawing	External		KJ94R997		
	Wiring		KE94G038		
Standard attachment	Document		Installation Manual		
	Accessory		Refrigerant conn. pipe		
Optional parts		Joint: CMY-Y102SS/LS-G2, CMY-Y202S-G2 Header: CMY-Y104/108/1010-G			
Remarks		Details on foundation work, duct work, insulation work, electrical wiring, power source switch, and other items shall be referred to the Installation Manual. Due to continuing improvement, above specifications may be subject to change without notice.			

Notes:	Unit converter
1. Nominal cooling conditions (subject to JIS B8615-2) Indoor: 27°C D.B./19°C W.B. (81°F D.B./66°F W.B.), Outdoor: 35°C D.B./24°C W.B. (95°F D.B./75°F W.B.) Pipe length: 7.5 m (24-9/16 ft.), Level difference: 0 m (0 ft.)	BTU/h = kW x 3,412
2. Nominal heating conditions (subject to JIS B8615-2) Indoor: 20°C D.B. (68°F D.B.), Outdoor: 7°C D.B./6°C W.B. (45°F D.B./43°F W.B.) Pipe length: 7.5 m (24-9/16 ft.), Level difference: 0 m (0 ft.)	cfm = m ³ /min x 35.31
3. External static pressure option is available (30Pa, 60Pa/3.1mmH ₂ O, 6.1mmH ₂ O).	lbs = kg/0.4536
	*Above specification data is subject to rounding variation.

1. SPECIFICATIONS

YKB/YLM

Model		PUHY-P500YKB-A1 (-BS)		
Power source		3-phase 4-wire 380-400-415 V 50/60 Hz		
Cooling capacity (Nominal)	*1	kW	55.0	
		kcal/h	50,000	
	*1	BTU/h	187,700	
		Power input	kW	18.39
		Current input	A	31.0-29.4-28.4
	EER	kW/kW	2.99	
Temp. range of cooling	Indoor	W.B.	15.0~24.0°C (59~75°F)	
	Outdoor	D.B.	-5.0~52.0°C (23~126°F)	
Heating capacity (Nominal)	*2	kW	63.0	
		kcal/h	54,200	
	*2	BTU/h	215,000	
		Power input	kW	18.52
		Current input	A	31.2-29.7-28.6
	COP	kW/kW	3.40	
Temp. range of heating	Indoor	D.B.	15.0~27.0°C (59~81°F)	
	Outdoor	W.B.	-20.0~15.5°C (-4~60°F)	
Indoor unit connectable	Total capacity		50~130% of outdoor unit capacity	
	Model/Quantity		P15~P250/1~43	
Sound pressure level (measured in anechoic room)		dB <A>	66	
Sound power level (measured in anechoic room)		dB <A>	86	
Refrigerant piping diameter	Liquid pipe	mm (in.)	15.88 (5/8) Brazed	
	Gas pipe	mm (in.)	28.58 (1-1/8) Brazed	
FAN	Type x Quantity		Propeller fan x 2	
	Air flow rate	m ³ /min	360	
		L/s	6,000	
		cfm	12,712	
	Control, Driving mechanism		Inverter-control, Direct-driven by motor	
*3	Motor output	kW	0.92 x 2	
External static press.		0 Pa (0 mmH ₂ O)		
Compressor	Type x Quantity		Inverter scroll hermetic compressor	
	Manufacture		AC&R Works, MITSUBISHI ELECTRIC CORPORATION	
	Starting method		Inverter	
	Motor output	kW	13.3	
	Case heater	kW	0.045	
Lubricant		MEL32		
External finish		Pre-coated galvanized steel sheets (+powder coating for -BS type) <MUNSELL 5Y 8/1 or similar>		
External dimension H x W x D		mm	1,710 (1,650 without legs) x 1,750 x 740	
		in.	67-3/8 (65 without legs) x 68-15/16 x 29-3/16	
Protection devices	High pressure protection		High pressure sensor, High pressure switch at 4.15 MPa (601 psi)	
	Inverter circuit (COMP./FAN)		Over-heat protection, Over-current protection	
	Compressor		-	
	Fan motor		-	
Refrigerant	Type x original charge		R410A x 11.8 kg (27 lbs)	
	Control		LEV and HIC circuit	
Net weight		kg (lbs)	304 (671)	
Heat exchanger		Salt-resistant cross fin & copper tube		
HIC circuit (HIC: Heat Inter-Changer)		Copper pipe, tube-in-tube structure		
Defrosting method		Auto-defrost mode (Reversed refrigerant cycle, Hot gas)		
Drawing	External	KJ94R998		
	Wiring	KE94C967		
Standard attachment	Document	Installation Manual		
	Accessory	Refrigerant conn. pipe		
Optional parts		Joint: CMY-Y102SS/LS-G2, CMY-Y202S-G2 Header: CMY-Y104/108/1010-G		
Remarks		Details on foundation work, duct work, insulation work, electrical wiring, power source switch, and other items shall be referred to the Installation Manual. Due to continuing improvement, above specifications may be subject to change without notice.		

Notes:	Unit converter
1.Nominal cooling conditions (subject to JIS B8615-2) Indoor: 27°C D.B./19°C W.B. (81°F D.B./66°F W.B.), Outdoor: 35°C D.B./24°C W.B. (95°F D.B./75°F W.B.) Pipe length: 7.5 m (24-9/16 ft.), Level difference: 0 m (0 ft.)	BTU/h =kW x 3,412 cfm =m ³ /min x 35.31 lbs =kg/0.4536
2.Nominal heating conditions (subject to JIS B8615-2) Indoor: 20°C D.B. (68°F D.B.), Outdoor: 7°C D.B./6°C W.B. (45°F D.B./43°F W.B.) Pipe length: 7.5 m (24-9/16 ft.), Level difference: 0 m (0 ft.)	
3.External static pressure option is available (30Pa, 60Pa/3.1mmH ₂ O, 6.1mmH ₂ O).	
	*Above specification data is subject to rounding variation.

1. SPECIFICATIONS

YKB/YLM

Model			PUHY-P400YSKB-A1 (-BS)
Power source			3-phase 4-wire 380-400-415 V 50/60 Hz
Cooling capacity (Nominal)	*1	kW	45.0
		kcal/h	40,000
		BTU/h	153,500
	Power input	kW	11.00
		Current input	A
EER	kW/kW	4.09	
Temp. range of cooling	Indoor	W.B.	15.0~24.0°C (59~75°F)
	Outdoor	D.B.	-5.0~52.0°C (23~126°F)
Heating capacity (Nominal)	*2	kW	50.0
		kcal/h	45,000
		BTU/h	170,600
	Power input	kW	12.24
		Current input	A
COP	kW/kW	4.08	
Temp. range of heating	Indoor	D.B.	15.0~27.0°C (59~81°F)
	Outdoor	W.B.	-20.0~15.5°C (-4~60°F)
Indoor unit connectable	Total capacity		50~130% of outdoor unit capacity
	Model/Quantity		P15~P250/1~34
Sound pressure level (measured in anechoic room)		dB <A>	60
Sound power level (measured in anechoic room)		dB <A>	81
Refrigerant piping diameter	Liquid pipe	mm (in.)	12.7 (1/2) Brazed
	Gas pipe	mm (in.)	28.58 (1-1/8) Brazed

Set Model

Model			PUHY-P200YKB-A1 (-BS)	PUHY-P200YKB-A1 (-BS)
FAN	Type x Quantity		Propeller fan x 1	Propeller fan x 1
	Air flow rate	m ³ /min	175	175
		L/s	2,917	2,917
		cfm	6,179	6,179
	Control, Driving mechanism		Inverter-control, Direct-driven by motor	Inverter-control, Direct-driven by motor
	Motor output	kW	0.92 x 1	0.92 x 1
*3 External static press.		0 Pa (0 mmH ₂ O)	0 Pa (0 mmH ₂ O)	
Compressor	Type x Quantity		Inverter scroll hermetic compressor	Inverter scroll hermetic compressor
	Manufacture		AC&R Works, MITSUBISHI ELECTRIC CORPORATION	AC&R Works, MITSUBISHI ELECTRIC CORPORATION
	Starting method		Inverter	Inverter
	Motor output	kW	5.5	5.5
	Case heater	kW	-	-
Lubricant		MEL32	MEL32	
External finish			Pre-coated galvanized steel sheets (+powder coating for -BS type) <MUNSELL 5Y 8/1 or similar>	Pre-coated galvanized steel sheets (+powder coating for -BS type) <MUNSELL 5Y 8/1 or similar>
External dimension H x W x D			mm 1,710 (1,650 without legs) x 920 x 740	mm 1,710 (1,650 without legs) x 920 x 740
			in. 67-3/8 (65 without legs) x 36-1/4 x 29-3/16	in. 67-3/8 (65 without legs) x 36-1/4 x 29-3/16
Protection devices	High pressure protection		High pressure sensor, High pressure switch at 4.15 MPa (601 psi)	High pressure sensor, High pressure switch at 4.15 MPa (601 psi)
	Inverter circuit (COMP./FAN)		Over-heat protection, Over-current protection	Over-heat protection, Over-current protection
	Compressor		-	-
	Fan motor		-	-
Refrigerant	Type x original charge		R410A x 6.5 kg (15 lbs)	R410A x 6.5 kg (15 lbs)
	Control		LEV and HIC circuit	
Net weight	kg (lbs)	190 (419)	190 (419)	
Heat exchanger			Salt-resistant cross fin & copper tube	Salt-resistant cross fin & copper tube
HIC circuit (HIC: Heat Inter-Changer)			Copper pipe, tube-in-tube structure	Copper pipe, tube-in-tube structure
Pipe between unit and distributor	Liquid pipe	mm (in.)	9.52 (3/8) Brazed	9.52 (3/8) Brazed
	Gas pipe	mm (in.)	22.2 (7/8) Brazed	22.2 (7/8) Brazed
Defrosting method			Auto-defrost mode (Reversed refrigerant cycle, Hot gas)	
Drawing	External		KJ94T009	
	Wiring		KE94G038	KE94G038
Standard attachment	Installation Manual			
	Refrigerant conn. pipe			
Optional parts			Outdoor Twinning kit: CMY-Y100VBK3 Joint: CMY-Y102SS/LS-G2, CMY-Y202S/302S-G2 Header: CMY-Y104/108/1010-G	
Remarks			Details on foundation work, duct work, insulation work, electrical wiring, power source switch, and other items shall be referred to the Installation Manual. Due to continuing improvement, above specifications may be subject to change without notice.	

Notes:

- Nominal cooling conditions (subject to JIS B8615-2)
Indoor: 27°C D.B./19°C W.B. (81°F D.B./66°F W.B.), Outdoor: 35°C D.B./24°C W.B. (95°F D.B./75°F W.B.)
Pipe length: 7.5 m (24-9/16 ft.), Level difference: 0 m (0 ft.)
- Nominal heating conditions (subject to JIS B8615-2)
Indoor: 20°C D.B. (68°F D.B.), Outdoor: 7°C D.B./6°C W.B. (45°F D.B./43°F W.B.)
Pipe length: 7.5 m (24-9/16 ft.), Level difference: 0 m (0 ft.)
- External static pressure option is available (30Pa, 60Pa/3.1mmH₂O, 6.1mmH₂O).

Unit converter

BTU/h	=kW x 3,412
cfm	=m ³ /min x 35.31
lbs	=kg/0.4536

*Above specification data is subject to rounding variation.

1. SPECIFICATIONS

Model		PUHY-P450YSKB-A1 (-BS)	
Power source		3-phase 4-wire 380-400-415 V 50/60 Hz	
Cooling capacity (Nominal)	*1 kW	50.0	
	kcal/h	45,000	
	*1 BTU/h	170,600	
	Power input kW	12.59	
	Current input A	21.2-20.1-19.4	
Temp. range of cooling	EER kW/kW	3.97	
	Indoor W.B.	15.0~24.0°C (59~75°F)	
Outdoor D.B.	-5.0~52.0°C (23~126°F)		
Heating capacity (Nominal)	*2 kW	56.0	
	kcal/h	50,000	
	*2 BTU/h	191,100	
	Power input kW	13.72	
	Current input A	23.1-22.0-21.2	
Temp. range of heating	COP kW/kW	4.08	
	Indoor D.B.	15.0~27.0°C (59~81°F)	
Outdoor W.B.	-20.0~15.5°C (-4~60°F)		
Indoor unit connectable	Total capacity	50~130% of outdoor unit capacity	
	Model/Quantity	P15-P250/1~39	
Sound pressure level (measured in anechoic room)	dB <A>	61.5	
Sound power level (measured in anechoic room)	dB <A>	82	
Refrigerant piping diameter	Liquid pipe mm (in.)	15.88 (5/8) Brazed	
	Gas pipe mm (in.)	28.58 (1-1/8) Brazed	

Set Model

Model		PUHY-P200YKB-A1 (-BS)		PUHY-P250YKB-A1 (-BS)		
FAN	Type x Quantity	Propeller fan x 1		Propeller fan x 1		
	Air flow rate	m ³ /min	175		175	
		L/s	2,917		2,917	
		cfm	6,179		6,179	
	Control, Driving mechanism	Inverter-control, Direct-driven by motor		Inverter-control, Direct-driven by motor		
	Motor output kW	0.92 x 1		0.92 x 1		
*3 External static press.	0 Pa (0 mmH ₂ O)		0 Pa (0 mmH ₂ O)			
Compressor	Type x Quantity	Inverter scroll hermetic compressor		Inverter scroll hermetic compressor		
	Manufacture	AC&R Works, MITSUBISHI ELECTRIC CORPORATION		AC&R Works, MITSUBISHI ELECTRIC CORPORATION		
	Starting method	Inverter		Inverter		
	Motor output kW	5.5		6.9		
	Case heater kW	-		-		
Lubricant	MEL32		MEL32			
External finish	Pre-coated galvanized steel sheets (+powder coating for -BS type) <MUNSELL 5Y 8/1 or similar>		Pre-coated galvanized steel sheets (+powder coating for -BS type) <MUNSELL 5Y 8/1 or similar>			
External dimension H x W x D	mm	1,710 (1,650 without legs) x 920 x 740		1,710 (1,650 without legs) x 920 x 740		
		in.	67-3/8 (65 without legs) x 36-1/4 x 29-3/16		67-3/8 (65 without legs) x 36-1/4 x 29-3/16	
Protection devices	High pressure protection		High pressure sensor, High pressure switch at 4.15 MPa (601 psi)		High pressure sensor, High pressure switch at 4.15 MPa (601 psi)	
	Inverter circuit (COMP./FAN)	Over-heat protection, Over-current protection		Over-heat protection, Over-current protection		
	Compressor	-		-		
	Fan motor	-		-		
Refrigerant	Type x original charge	R410A x 6.5 kg (15 lbs)		R410A x 8.0 kg (18 lbs)		
	Control	LEV and HIC circuit				
Net weight	kg (lbs)	190 (419)		199 (439)		
Heat exchanger	Salt-resistant cross fin & copper tube		Salt-resistant cross fin & copper tube			
HIC circuit (HIC: Heat Inter-Changer)	Copper pipe, tube-in-tube structure		Copper pipe, tube-in-tube structure			
Pipe between unit and distributor	Liquid pipe mm (in.)	9.52 (3/8) Brazed		9.52 (3/8) Brazed		
	Gas pipe mm (in.)	22.2 (7/8) Brazed		22.2 (7/8) Brazed		
Defrosting method	Auto-defrost mode (Reversed refrigerant cycle, Hot gas)					
Drawing	External	KJ94T009				
	Wiring	KE94G038		KE94G038		
Standard attachment	Document	Installation Manual				
	Accessory	Refrigerant conn. pipe				
Optional parts	Outdoor Twinning kit: CMY-Y100VBK3 Joint: CMY-Y102SS/LS-G2, CMY-Y202S/302S-G2 Header: CMY-Y104/108/1010-G					
Remarks	Details on foundation work, duct work, insulation work, electrical wiring, power source switch, and other items shall be referred to the Installation Manual. Due to continuing improvement, above specifications may be subject to change without notice.					

Notes:

- Nominal cooling conditions (subject to JIS B8615-2)
Indoor: 27°C D.B./19°C W.B. (81°F D.B./66°F W.B.), Outdoor: 35°C D.B./24°C W.B. (95°F D.B./75°F W.B.)
Pipe length: 7.5 m (24-9/16 ft.), Level difference: 0 m (0 ft.)
- Nominal heating conditions (subject to JIS B8615-2)
Indoor: 20°C D.B. (68°F D.B.), Outdoor: 7°C D.B./6°C W.B. (45°F D.B./43°F W.B.)
Pipe length: 7.5 m (24-9/16 ft.), Level difference: 0 m (0 ft.)
- External static pressure option is available (30Pa, 60Pa/3.1mmH₂O, 6.1mmH₂O).

Unit converter	
BTU/h	=kW x 3,412
cfm	=m ³ /min x 35.31
lbs	=kg/0.4536
*Above specification data is subject to rounding variation.	

1. SPECIFICATIONS

YKB/YLM

Model			PUHY-P500YSKB-A1 (-BS)		
Power source			3-phase 4-wire 380-400-415 V 50/60 Hz		
Cooling capacity (Nominal)	*1	kW	56.0		
		kcal/h	50,000		
		BTU/h	191,100		
	Power input	kW	14.54		
		Current input	A	24.5-23.3-22.4	
EER	kW/kW	3.85			
Temp. range of cooling	Indoor	W.B.	15.0~24.0°C (59~75°F)		
	Outdoor	D.B.	-5.0~52.0°C (23~126°F)		
Heating capacity (Nominal)	*2	kW	63.0		
		kcal/h	54,200		
		BTU/h	215,000		
	Power input	kW	15.46		
		Current input	A	26.0-24.7-23.8	
COP	kW/kW	4.07			
Temp. range of heating	Indoor	D.B.	15.0~27.0°C (59~81°F)		
	Outdoor	W.B.	-20.0~15.5°C (-4~60°F)		
Indoor unit connectable	Total capacity		50~130% of outdoor unit capacity		
	Model/Quantity		P15~P250/1~43		
Sound pressure level (measured in anechoic room)	dB <A>		62		
Sound power level (measured in anechoic room)	dB <A>		82		
Refrigerant	Liquid pipe	mm (in.)	15.88 (5/8) Brazed		
piping diameter	Gas pipe	mm (in.)	28.58 (1-1/8) Brazed		

Set Model

Model			PUHY-P250YKB-A1 (-BS)			PUHY-P250YKB-A1 (-BS)		
FAN	Type x Quantity		Propeller fan x 1			Propeller fan x 1		
	Air flow rate	m ³ /min	175			175		
		L/s	2,917			2,917		
		cfm	6,179			6,179		
	Control, Driving mechanism		Inverter-control, Direct-driven by motor			Inverter-control, Direct-driven by motor		
	Motor output	kW	0.92 x 1			0.92 x 1		
*3 External static press.		0 Pa (0 mmH ₂ O)			0 Pa (0 mmH ₂ O)			
Compressor	Type x Quantity		Inverter scroll hermetic compressor			Inverter scroll hermetic compressor		
	Manufacture		AC&R Works, MITSUBISHI ELECTRIC CORPORATION			AC&R Works, MITSUBISHI ELECTRIC CORPORATION		
	Starting method		Inverter			Inverter		
	Motor output	kW	6.9			6.9		
	Case heater	kW	-			-		
	Lubricant		MEL32			MEL32		
External finish			Pre-coated galvanized steel sheets (+powder coating for -BS type) <MUNSELL 5Y 8/1 or similar>			Pre-coated galvanized steel sheets (+powder coating for -BS type) <MUNSELL 5Y 8/1 or similar>		
External dimension H x W x D			mm 1,710 (1,650 without legs) x 920 x 740			mm 1,710 (1,650 without legs) x 920 x 740		
			in. 67-3/8 (65 without legs) x 36-1/4 x 29-3/16			in. 67-3/8 (65 without legs) x 36-1/4 x 29-3/16		
Protection devices	High pressure protection		High pressure sensor, High pressure switch at 4.15 MPa (601 psi)			High pressure sensor, High pressure switch at 4.15 MPa (601 psi)		
	Inverter circuit (COMP./FAN)		Over-heat protection, Over-current protection			Over-heat protection, Over-current protection		
	Compressor		-			-		
	Fan motor		-			-		
Refrigerant	Type x original charge		R410A x 8.0 kg (18 lbs)			R410A x 8.0 kg (18 lbs)		
	Control		LEV and HIC circuit			LEV and HIC circuit		
Net weight			kg (lbs) 199 (439)			kg (lbs) 199 (439)		
Heat exchanger			Salt-resistant cross fin & copper tube			Salt-resistant cross fin & copper tube		
HIC circuit (HIC: Heat Inter-Changer)			Copper pipe, tube-in-tube structure			Copper pipe, tube-in-tube structure		
Pipe between unit and distributor	Liquid pipe	mm (in.)	9.52 (3/8) Brazed			9.52 (3/8) Brazed		
	Gas pipe	mm (in.)	22.2 (7/8) Brazed			22.2 (7/8) Brazed		
Defrosting method			Auto-defrost mode (Reversed refrigerant cycle, Hot gas)			Auto-defrost mode (Reversed refrigerant cycle, Hot gas)		
Drawing	External		KJ94T009			KJ94T009		
	Wiring		KE94G038			KE94G038		
Standard attachment	Document		Installation Manual			Installation Manual		
	Accessory		Refrigerant conn. pipe			Refrigerant conn. pipe		
Optional parts			Outdoor Twinning kit: CMY-Y100VBK3 Joint: CMY-Y102SS/LS-G2, CMY-Y202S/302S-G2 Header: CMY-Y104/108/1010-G			Outdoor Twinning kit: CMY-Y100VBK3 Joint: CMY-Y102SS/LS-G2, CMY-Y202S/302S-G2 Header: CMY-Y104/108/1010-G		
Remarks			Details on foundation work, duct work, insulation work, electrical wiring, power source switch, and other items shall be referred to the Installation Manual. Due to continuing improvement, above specifications may be subject to change without notice.			Details on foundation work, duct work, insulation work, electrical wiring, power source switch, and other items shall be referred to the Installation Manual. Due to continuing improvement, above specifications may be subject to change without notice.		

Notes:

- Nominal cooling conditions (subject to JIS B8615-2)
Indoor: 27°C D.B./19°C W.B. (81°F D.B./66°F W.B.), Outdoor: 35°C D.B./24°C W.B. (95°F D.B./75°F W.B.)
Pipe length: 7.5 m (24-9/16 ft.), Level difference: 0 m (0 ft.)
- Nominal heating conditions (subject to JIS B8615-2)
Indoor: 20°C D.B. (68°F D.B.), Outdoor: 7°C D.B./6°C W.B. (45°F D.B./43°F W.B.)
Pipe length: 7.5 m (24-9/16 ft.), Level difference: 0 m (0 ft.)
- External static pressure option is available (30Pa, 60Pa/3.1mmH₂O, 6.1mmH₂O).

Unit converter

BTU/h =kW x 3.412
cfm =m³/min x 35.31
lbs =kg/0.4536

*Above specification data is subject to rounding variation.

1. SPECIFICATIONS

Model		PUHY-P550YSKB-A1 (-BS)	
Power source		3-phase 4-wire 380-400-415 V 50/60 Hz	
Cooling capacity (Nominal)	*1 kW	63.0	
	kcal/h	54,200	
	*1 BTU/h	215,000	
	Power input kW	16.66	
	Current input A	28.1-26.7-25.7	
Temp. range of cooling	EER	3.78	
	Indoor	W.B.	15.0~24.0°C (59~75°F)
	Outdoor	D.B.	-5.0~52.0°C (23~126°F)
Heating capacity (Nominal)	*2 kW	69.0	
	kcal/h	59,300	
	*2 BTU/h	235,400	
	Power input kW	17.29	
	Current input A	29.1-27.7-26.7	
Temp. range of heating	COP	3.99	
	Indoor	D.B.	15.0~27.0°C (59~81°F)
	Outdoor	W.B.	-20.0~15.5°C (-4~60°F)
Indoor unit connectable	Total capacity	50~130% of outdoor unit capacity	
	Model/Quantity	P15-P250/2-47	
Sound pressure level (measured in anechoic room)	dB <A>	63.5	
Sound power level (measured in anechoic room)	dB <A>	84.5	
Refrigerant piping diameter	Liquid pipe	mm (in.)	15.88 (5/8) Brazed
	Gas pipe	mm (in.)	28.58 (1-1/8) Brazed

Set Model

Model		PUHY-P250YKB-A1 (-BS)		PUHY-P300YKB-A1 (-BS)	
FAN	Type x Quantity	Propeller fan x 1		Propeller fan x 1	
	Air flow rate	m ³ /min	175	210	
		L/s	2,917	3,500	
		cfm	6,179	7,415	
	Control, Driving mechanism	Inverter-control, Direct-driven by motor		Inverter-control, Direct-driven by motor	
	Motor output	kW	0.92 x 1	0.92 x 1	
*3 External static press.	0 Pa (0 mmH ₂ O)		0 Pa (0 mmH ₂ O)		
Compressor	Type x Quantity	Inverter scroll hermetic compressor		Inverter scroll hermetic compressor	
	Manufacture	AC&R Works, MITSUBISHI ELECTRIC CORPORATION		AC&R Works, MITSUBISHI ELECTRIC CORPORATION	
	Starting method	Inverter		Inverter	
	Motor output	kW	6.9	8.1	
	Case heater	kW	-	-	
Lubricant	MEL32		MEL32		
External finish	Pre-coated galvanized steel sheets (+powder coating for -BS type) <MUNSELL 5Y 8/1 or similar>		Pre-coated galvanized steel sheets (+powder coating for -BS type) <MUNSELL 5Y 8/1 or similar>		
External dimension H x W x D	mm	1,710 (1,650 without legs) x 920 x 740		1,710 (1,650 without legs) x 1,220 x 740	
		in.	67-3/8 (65 without legs) x 36-1/4 x 29-3/16		67-3/8 (65 without legs) x 48-1/16 x 29-3/16
Protection devices	High pressure protection		High pressure sensor, High pressure switch at 4.15 MPa (601 psi)		High pressure sensor, High pressure switch at 4.15 MPa (601 psi)
	Inverter circuit (COMP./FAN)	Over-heat protection, Over-current protection		Over-heat protection, Over-current protection	
	Compressor	-		-	
	Fan motor	-		-	
Refrigerant	Type x original charge	R410A x 8.0 kg (18 lbs)		R410A x 11.5 kg (26 lbs)	
	Control	LEV and HIC circuit			
Net weight	kg (lbs)	199 (439)		251 (554)	
Heat exchanger	Salt-resistant cross fin & copper tube		Salt-resistant cross fin & copper tube		
HIC circuit (HIC: Heat Inter-Changer)	Copper pipe, tube-in-tube structure		Copper pipe, tube-in-tube structure		
Pipe between unit and distributor	Liquid pipe	mm (in.)	9.52 (3/8) Brazed	12.7 (1/2) Brazed	
	Gas pipe	mm (in.)	22.2 (7/8) Brazed	22.2 (7/8) Brazed	
Defrosting method	Auto-defrost mode (Reversed refrigerant cycle, Hot gas)				
Drawing	External	KJ94R999			
	Wiring	KE94G038		KE94G038	
Standard attachment	Document	Installation Manual			
	Accessory	Refrigerant conn. pipe			
Optional parts	Outdoor Twinning kit: CMY-Y100VBK3 Joint: CMY-Y102SS/LS-G2, CMY-Y202S/302S-G2 Header: CMY-Y104/108/1010-G				
Remarks	Details on foundation work, duct work, insulation work, electrical wiring, power source switch, and other items shall be referred to the Installation Manual. Due to continuing improvement, above specifications may be subject to change without notice.				

Notes:

- Nominal cooling conditions (subject to JIS B8615-2)
Indoor: 27°C D.B./19°C W.B. (81°F D.B./66°F W.B.), Outdoor: 35°C D.B./24°C W.B. (95°F D.B./75°F W.B.)
Pipe length: 7.5 m (24-9/16 ft.), Level difference: 0 m (0 ft.)
- Nominal heating conditions (subject to JIS B8615-2)
Indoor: 20°C D.B. (68°F D.B.), Outdoor: 7°C D.B./6°C W.B. (45°F D.B./43°F W.B.)
Pipe length: 7.5 m (24-9/16 ft.), Level difference: 0 m (0 ft.)
- External static pressure option is available (30Pa, 60Pa/3.1mmH₂O, 6.1mmH₂O).

Unit converter	
BTU/h	=kW x 3,412
cfm	=m ³ /min x 35.31
lbs	=kg/0.4536
*Above specification data is subject to rounding variation.	

1. SPECIFICATIONS

YKB/YLM

Model			PUHY-P600YSKB-A1 (-BS)		
Power source			3-phase 4-wire 380-400-415 V 50/60 Hz		
Cooling capacity (Nominal)	*1	kW	69.0		
		kcal/h	59,300		
		BTU/h	235,400		
	Power input	kW	19.43		
		Current input	A	32.8-31.1-30.0	
EER	kW/kW	3.55			
Temp. range of cooling	Indoor	W.B.	15.0~24.0°C (59~75°F)		
	Outdoor	D.B.	-5.0~52.0°C (23~126°F)		
Heating capacity (Nominal)	*2	kW	76.5		
		kcal/h	65,800		
		BTU/h	261,000		
	Power input	kW	19.36		
		Current input	A	32.6-31.0-29.9	
COP	kW/kW	3.95			
Temp. range of heating	Indoor	D.B.	15.0~27.0°C (59~81°F)		
	Outdoor	W.B.	-20.0~15.5°C (-4~60°F)		
Indoor unit connectable	Total capacity		50~130% of outdoor unit capacity		
	Model/Quantity		P15~P250/2~50		
Sound pressure level (measured in anechoic room)	dB <A>		63.5		
Sound power level (measured in anechoic room)	dB <A>		84.5		
Refrigerant piping diameter	Liquid pipe	mm (in.)	15.88 (5/8) Brazed		
	Gas pipe	mm (in.)	28.58 (1-1/8) Brazed		

Set Model

Model			PUHY-P250YKB-A1 (-BS)			PUHY-P350YKB-A1 (-BS)		
FAN	Type x Quantity		Propeller fan x 1			Propeller fan x 1		
	Air flow rate	m ³ /min	175			210		
		L/s	2,917			3,500		
		cfm	6,179			7,415		
	Control, Driving mechanism		Inverter-control, Direct-driven by motor			Inverter-control, Direct-driven by motor		
	Motor output	kW	0.92 x 1			0.92 x 1		
*3 External static press.		0 Pa (0 mmH ₂ O)			0 Pa (0 mmH ₂ O)			
Compressor	Type x Quantity		Inverter scroll hermetic compressor			Inverter scroll hermetic compressor		
	Manufacture		AC&R Works, MITSUBISHI ELECTRIC CORPORATION			AC&R Works, MITSUBISHI ELECTRIC CORPORATION		
	Starting method		Inverter			Inverter		
	Motor output	kW	6.9			10.5		
	Case heater	kW	-			-		
	Lubricant		MEL32			MEL32		
External finish			Pre-coated galvanized steel sheets (+powder coating for -BS type) <MUNSELL 5Y 8/1 or similar>			Pre-coated galvanized steel sheets (+powder coating for -BS type) <MUNSELL 5Y 8/1 or similar>		
External dimension H x W x D			mm 1,710 (1,650 without legs) x 920 x 740			mm 1,710 (1,650 without legs) x 1,220 x 740		
			in. 67-3/8 (65 without legs) x 36-1/4 x 29-3/16			in. 67-3/8 (65 without legs) x 48-1/16 x 29-3/16		
Protection devices	High pressure protection		High pressure sensor, High pressure switch at 4.15 MPa (601 psi)			High pressure sensor, High pressure switch at 4.15 MPa (601 psi)		
	Inverter circuit (COMP./FAN)		Over-heat protection, Over-current protection			Over-heat protection, Over-current protection		
	Compressor		-			-		
	Fan motor		-			-		
Refrigerant	Type x original charge		R410A x 8.0 kg (18 lbs)			R410A x 11.5 kg (26 lbs)		
	Control		LEV and HIC circuit					
Net weight			kg (lbs) 199 (439)			kg (lbs) 251 (554)		
Heat exchanger			Salt-resistant cross fin & copper tube			Salt-resistant cross fin & copper tube		
HIC circuit (HIC: Heat Inter-Changer)			Copper pipe, tube-in-tube structure			Copper pipe, tube-in-tube structure		
Pipe between unit and distributor	Liquid pipe	mm (in.)	9.52 (3/8) Brazed			12.7 (1/2) Brazed		
	Gas pipe	mm (in.)	22.2 (7/8) Brazed			28.58 (1-1/8) Brazed		
Defrosting method			Auto-defrost mode (Reversed refrigerant cycle, Hot gas)					
Drawing	External		KJ94R999					
	Wiring		KE94G038			KE94G038		
Standard attachment	Document		Installation Manual					
	Accessory		Refrigerant conn. pipe					
Optional parts			Outdoor Twinning kit: CMY-Y100VBK3 Joint: CMY-Y102SS/LS-G2, CMY-Y202S/302S-G2 Header: CMY-Y104/108/1010-G					
Remarks			Details on foundation work, duct work, insulation work, electrical wiring, power source switch, and other items shall be referred to the Installation Manual. Due to continuing improvement, above specifications may be subject to change without notice.					

Notes:

- Nominal cooling conditions (subject to JIS B8615-2)
Indoor: 27°C D.B./19°C W.B. (81°F D.B./66°F W.B.), Outdoor: 35°C D.B./24°C W.B. (95°F D.B./75°F W.B.)
Pipe length: 7.5 m (24-9/16 ft.), Level difference: 0 m (0 ft.)
- Nominal heating conditions (subject to JIS B8615-2)
Indoor: 20°C D.B. (68°F D.B.), Outdoor: 7°C D.B./6°C W.B. (45°F D.B./43°F W.B.)
Pipe length: 7.5 m (24-9/16 ft.), Level difference: 0 m (0 ft.)
- External static pressure option is available (30Pa, 60Pa/3.1mmH₂O, 6.1mmH₂O).

Unit converter

BTU/h	=kW x 3.412
cfm	=m ³ /min x 35.31
lbs	=kg/0.4536

*Above specification data is subject to rounding variation.

1. SPECIFICATIONS

Model			PUHY-P650YSKB-A1 (-BS)	
Power source			3-phase 4-wire 380-400-415 V 50/60 Hz	
Cooling capacity (Nominal)	*1	kW	73.0	
		kcal/h	62,800	
		BTU/h	249,100	
	Power input	kW	20.97	
		Current input	A	35.4-33.6-32.4
EER		kW/kW	3.48	
Temp. range of cooling	Indoor	W.B.	15.0~24.0°C (59~75°F)	
	Outdoor	D.B.	-5.0~52.0°C (23~126°F)	
Heating capacity (Nominal)	*2	kW	81.5	
		kcal/h	70,100	
		BTU/h	278,100	
	Power input	kW	21.00	
		Current input	A	35.4-33.6-32.4
COP		kW/kW	3.88	
Temp. range of heating	Indoor	D.B.	15.0~27.0°C (59~81°F)	
	Outdoor	W.B.	-20.0~15.5°C (-4~60°F)	
Indoor unit connectable	Total capacity	50~130% of outdoor unit capacity		
	Model/Quantity	P15~P250/2~50		
Sound pressure level (measured in anechoic room)		dB <A>	64	
Sound power level (measured in anechoic room)		dB <A>	86	
Refrigerant piping diameter	Liquid pipe	mm (in.)	15.88 (5/8) Brazed	
	Gas pipe	mm (in.)	28.58 (1-1/8) Brazed	

Model			PUHY-P300YKB-A1 (-BS)		PUHY-P350YKB-A1 (-BS)	
FAN	Type x Quantity		Propeller fan x 1		Propeller fan x 1	
	Air flow rate	m ³ /min	210		210	
		L/s	3,500		3,500	
		cfm	7,415		7,415	
	Control, Driving mechanism		Inverter-control, Direct-driven by motor		Inverter-control, Direct-driven by motor	
	Motor output	kW	0.92 x 1		0.92 x 1	
*3	External static press.		0 Pa (0 mmH ₂ O)		0 Pa (0 mmH ₂ O)	
Compressor	Type x Quantity		Inverter scroll hermetic compressor		Inverter scroll hermetic compressor	
	Manufacture		AC&R Works, MITSUBISHI ELECTRIC CORPORATION		AC&R Works, MITSUBISHI ELECTRIC CORPORATION	
	Starting method		Inverter		Inverter	
	Motor output	kW	8.1		10.5	
	Case heater	kW	-		-	
Lubricant		MEL32		MEL32		
External finish			Pre-coated galvanized steel sheets (+powder coating for -BS type) <MUNSELL 5Y 8/1 or similar>		Pre-coated galvanized steel sheets (+powder coating for -BS type) <MUNSELL 5Y 8/1 or similar>	
External dimension H x W x D			mm 1,710 (1,650 without legs) x 1,220 x 740 67-3/8 (65 without legs) x 48-1/16 x 29-3/16		mm 1,710 (1,650 without legs) x 1,220 x 740 67-3/8 (65 without legs) x 48-1/16 x 29-3/16	
Protection devices	High pressure protection		High pressure sensor, High pressure switch at 4.15 MPa (601 psi)		High pressure sensor, High pressure switch at 4.15 MPa (601 psi)	
	Inverter circuit (COMP./FAN)		Over-heat protection, Over-current protection		Over-heat protection, Over-current protection	
	Compressor		-		-	
	Fan motor		-		-	
Refrigerant	Type x original charge		R410A x 11.5 kg (26 lbs)		R410A x 11.5 kg (26 lbs)	
	Control		LEV and HIC circuit			
Net weight		kg (lbs)	251 (554)		251 (554)	
Heat exchanger			Salt-resistant cross fin & copper tube		Salt-resistant cross fin & copper tube	
HIC circuit (HIC: Heat Inter-Changer)			Copper pipe, tube-in-tube structure		Copper pipe, tube-in-tube structure	
Pipe between unit and distributor	Liquid pipe	mm (in.)	12.7 (1/2) Brazed		12.7 (1/2) Brazed	
	Gas pipe	mm (in.)	22.2 (7/8) Brazed		28.58 (1-1/8) Brazed	
Defrosting method			Auto-defrost mode (Reversed refrigerant cycle, Hot gas)			
Drawing	External		KJ94T001			
	Wiring		KE94G038		KE94G038	
Standard attachment	Document		Installation Manual			
	Accessory		Refrigerant conn. pipe			
Optional parts			Outdoor Twinning kit: CMY-Y100VBK3 Joint: CMY-Y102SS/LS-G2, CMY-Y202S/302S-G2 Header: CMY-Y104/108/1010-G			
Remarks			Details on foundation work, duct work, insulation work, electrical wiring, power source switch, and other items shall be referred to the Installation Manual. Due to continuing improvement, above specifications may be subject to change without notice.			

Notes:	Unit converter
1.Nominal cooling conditions (subject to JIS B8615-2) Indoor: 27°C D.B./19°C W.B. (81°F D.B./66°F W.B.), Outdoor: 35°C D.B./24°C W.B. (95°F D.B./75°F W.B.) Pipe length: 7.5 m (24-9/16 ft.), Level difference: 0 m (0 ft.)	BTU/h =kW x 3,412
2.Nominal heating conditions (subject to JIS B8615-2) Indoor: 20°C D.B. (68°F D.B.), Outdoor: 7°C D.B./6°C W.B. (45°F D.B./43°F W.B.) Pipe length: 7.5 m (24-9/16 ft.), Level difference: 0 m (0 ft.)	cfm =m ³ /min x 35.31
3.External static pressure option is available (30Pa, 60Pa/3.1mmH ₂ O, 6.1mmH ₂ O).	lbs =kg/0.4536
	*Above specification data is subject to rounding variation.

1. SPECIFICATIONS

YKB/YLM

Model			PUHY-P700YSKB-A1 (-BS)		
Power source			3-phase 4-wire 380-400-415 V 50/60 Hz		
Cooling capacity (Nominal)	*1	kW	80.0		
		kcal/h	68,800		
		BTU/h	273,000		
	Power input	kW	24.69		
		Current input	A	41.6-39.5-38.1	
EER	kW/kW	3.24			
Temp. range of cooling	Indoor	W.B.	15.0~24.0°C (59~75°F)		
	Outdoor	D.B.	-5.0~52.0°C (23~126°F)		
Heating capacity (Nominal)	*2	kW	88.0		
		kcal/h	75,700		
		BTU/h	300,300		
	Power input	kW	22.97		
		Current input	A	38.7-36.8-35.5	
COP	kW/kW	3.83			
Temp. range of heating	Indoor	D.B.	15.0~27.0°C (59~81°F)		
	Outdoor	W.B.	-20.0~15.5°C (-4~60°F)		
Indoor unit connectable	Total capacity		50~130% of outdoor unit capacity		
	Model/Quantity		P15~P250/2~50		
Sound pressure level (measured in anechoic room)	dB <A>		64		
Sound power level (measured in anechoic room)	dB <A>		86		
Refrigerant piping diameter	Liquid pipe	mm (in.)	19.05 (3/4) Brazed		
	Gas pipe	mm (in.)	34.93 (1-3/8) Brazed		

Set Model

Model			PUHY-P350YKB-A1 (-BS)			PUHY-P350YKB-A1 (-BS)		
FAN	Type x Quantity		Propeller fan x 1			Propeller fan x 1		
	Air flow rate	m ³ /min	210			210		
		L/s	3,500			3,500		
		cfm	7,415			7,415		
	Control, Driving mechanism		Inverter-control, Direct-driven by motor			Inverter-control, Direct-driven by motor		
	Motor output	kW	0.92 x 1			0.92 x 1		
*3 External static press.		0 Pa (0 mmH ₂ O)			0 Pa (0 mmH ₂ O)			
Compressor	Type x Quantity		Inverter scroll hermetic compressor			Inverter scroll hermetic compressor		
	Manufacture		AC&R Works, MITSUBISHI ELECTRIC CORPORATION			AC&R Works, MITSUBISHI ELECTRIC CORPORATION		
	Starting method		Inverter			Inverter		
	Motor output	kW	10.5			10.5		
	Case heater	kW	-			-		
Lubricant		MEL32			MEL32			
External finish			Pre-coated galvanized steel sheets (+powder coating for -BS type) <MUNSELL 5Y 8/1 or similar>			Pre-coated galvanized steel sheets (+powder coating for -BS type) <MUNSELL 5Y 8/1 or similar>		
External dimension H x W x D			mm 1,710 (1,650 without legs) x 1,220 x 740			mm 1,710 (1,650 without legs) x 1,220 x 740		
			in. 67-3/8 (65 without legs) x 48-1/16 x 29-3/16			in. 67-3/8 (65 without legs) x 48-1/16 x 29-3/16		
Protection devices	High pressure protection		High pressure sensor, High pressure switch at 4.15 MPa (601 psi)			High pressure sensor, High pressure switch at 4.15 MPa (601 psi)		
	Inverter circuit (COMP./FAN)		Over-heat protection, Over-current protection			Over-heat protection, Over-current protection		
	Compressor		-			-		
	Fan motor		-			-		
Refrigerant	Type x original charge		R410A x 11.5 kg (26 lbs)			R410A x 11.5 kg (26 lbs)		
	Control		LEV and HIC circuit			LEV and HIC circuit		
Net weight			kg (lbs) 251 (554)			kg (lbs) 251 (554)		
Heat exchanger			Salt-resistant cross fin & copper tube			Salt-resistant cross fin & copper tube		
HIC circuit (HIC: Heat Inter-Changer)			Copper pipe, tube-in-tube structure			Copper pipe, tube-in-tube structure		
Pipe between unit and distributor	Liquid pipe	mm (in.)	12.7 (1/2) Brazed			12.7 (1/2) Brazed		
	Gas pipe	mm (in.)	28.58 (1-1/8) Brazed			28.58 (1-1/8) Brazed		
Defrosting method			Auto-defrost mode (Reversed refrigerant cycle, Hot gas)			Auto-defrost mode (Reversed refrigerant cycle, Hot gas)		
Drawing	External		KJ94T001			KJ94T001		
	Wiring		KE94G038			KE94G038		
Standard attachment	Document		Installation Manual			Installation Manual		
	Accessory		Refrigerant conn. pipe			Refrigerant conn. pipe		
Optional parts			Outdoor Twinning kit: CMY-Y200VBK2 Joint: CMY-Y102SS/LS-G2, CMY-Y202S/302S-G2 Header: CMY-Y104/108/1010-G			Outdoor Twinning kit: CMY-Y200VBK2 Joint: CMY-Y102SS/LS-G2, CMY-Y202S/302S-G2 Header: CMY-Y104/108/1010-G		
Remarks			Details on foundation work, duct work, insulation work, electrical wiring, power source switch, and other items shall be referred to the Installation Manual. Due to continuing improvement, above specifications may be subject to change without notice.			Details on foundation work, duct work, insulation work, electrical wiring, power source switch, and other items shall be referred to the Installation Manual. Due to continuing improvement, above specifications may be subject to change without notice.		

Notes:

- Nominal cooling conditions (subject to JIS B8615-2)
Indoor: 27°C D.B./19°C W.B. (81°F D.B./66°F W.B.), Outdoor: 35°C D.B./24°C W.B. (95°F D.B./75°F W.B.)
Pipe length: 7.5 m (24-9/16 ft.), Level difference: 0 m (0 ft.)
- Nominal heating conditions (subject to JIS B8615-2)
Indoor: 20°C D.B. (68°F D.B.), Outdoor: 7°C D.B./6°C W.B. (45°F D.B./43°F W.B.)
Pipe length: 7.5 m (24-9/16 ft.), Level difference: 0 m (0 ft.)
- External static pressure option is available (30Pa, 60Pa/3.1mmH₂O, 6.1mmH₂O).

Unit converter

BTU/h =kW x 3.412
cfm =m³/min x 35.31
lbs =kg/0.4536

*Above specification data is subject to rounding variation.

1. SPECIFICATIONS

Model		PUHY-P750YSKB-A1 (-BS)	
Power source		3-phase 4-wire 380-400-415 V 50/60 Hz	
Cooling capacity (Nominal)	*1 kW	85.0	
	kcal/h	73,100	
	*1 BTU/h	290,000	
	Power input kW	26.56	
	Current input A	44.8-42.5-41.0	
Temp. range of cooling	EER	3.20	
	Indoor	W.B.	15.0~24.0°C (59~75°F)
	Outdoor	D.B.	-5.0~52.0°C (23~126°F)
Heating capacity (Nominal)	*2 kW	95.0	
	kcal/h	81,700	
	*2 BTU/h	324,100	
	Power input kW	24.93	
	Current input A	42.0-39.9-38.5	
Temp. range of heating	COP	3.81	
	Indoor	D.B.	15.0~27.0°C (59~81°F)
	Outdoor	W.B.	-20.0~15.5°C (-4~60°F)
Indoor unit connectable	Total capacity	50~130% of outdoor unit capacity	
	Model/Quantity	P15-P250/2-50	
Sound pressure level (measured in anechoic room)	dB <A>	65.5	
Sound power level (measured in anechoic room)	dB <A>	86	
Refrigerant piping diameter	Liquid pipe	mm (in.)	19.05 (3/4) Brazed
	Gas pipe	mm (in.)	34.93 (1-3/8) Brazed

Set Model

Model		PUHY-P350YKB-A1 (-BS)		PUHY-P400YKB-A1 (-BS)		
FAN	Type x Quantity	Propeller fan x 1		Propeller fan x 1		
	Air flow rate	m ³ /min	210		210	
		L/s	3,500		3,500	
		cfm	7,415		7,415	
	Control, Driving mechanism	Inverter-control, Direct-driven by motor		Inverter-control, Direct-driven by motor		
	Motor output	kW	0.92 x 1		0.92 x 1	
*3 External static press.		0 Pa (0 mmH ₂ O)		0 Pa (0 mmH ₂ O)		
Compressor	Type x Quantity	Inverter scroll hermetic compressor		Inverter scroll hermetic compressor		
	Manufacture	AC&R Works, MITSUBISHI ELECTRIC CORPORATION		AC&R Works, MITSUBISHI ELECTRIC CORPORATION		
	Starting method	Inverter		Inverter		
	Motor output	kW	10.5		10.8	
	Case heater	kW	-		-	
Lubricant		MEL32		MEL32		
External finish		Pre-coated galvanized steel sheets (+powder coating for -BS type) <MUNSELL 5Y 8/1 or similar>		Pre-coated galvanized steel sheets (+powder coating for -BS type) <MUNSELL 5Y 8/1 or similar>		
External dimension H x W x D	mm	1,710 (1,650 without legs) x 1,220 x 740		1,710 (1,650 without legs) x 1,220 x 740		
		in.	67-3/8 (65 without legs) x 48-1/16 x 29-3/16		67-3/8 (65 without legs) x 48-1/16 x 29-3/16	
Protection devices	High pressure protection		High pressure sensor, High pressure switch at 4.15 MPa (601 psi)		High pressure sensor, High pressure switch at 4.15 MPa (601 psi)	
	Inverter circuit (COMP./FAN)	Over-heat protection, Over-current protection		Over-heat protection, Over-current protection		
	Compressor	-		-		
	Fan motor	-		-		
Refrigerant	Type x original charge	R410A x 11.5 kg (26 lbs)		R410A x 11.5 kg (26 lbs)		
	Control	LEV and HIC circuit				
Net weight	kg (lbs)	251 (554)		251 (554)		
Heat exchanger		Salt-resistant cross fin & copper tube		Salt-resistant cross fin & copper tube		
HIC circuit (HIC: Heat Inter-Changer)		Copper pipe, tube-in-tube structure		Copper pipe, tube-in-tube structure		
Pipe between unit and distributor	Liquid pipe	mm (in.)	12.7 (1/2) Brazed		15.88 (5/8) Brazed	
	Gas pipe	mm (in.)	28.58 (1-1/8) Brazed		28.58 (1-1/8) Brazed	
Defrosting method		Auto-defrost mode (Reversed refrigerant cycle, Hot gas)				
Drawing	External	KJ94T001				
	Wiring	KE94G038		KE94G038		
Standard attachment	Document	Installation Manual				
	Accessory	Refrigerant conn. pipe				
Optional parts		Outdoor Twinning kit: CMY-Y200VBK2 Joint: CMY-Y102SS/LS-G2, CMY-Y202S/302S-G2 Header: CMY-Y104/108/1010-G				
Remarks		Details on foundation work, duct work, insulation work, electrical wiring, power source switch, and other items shall be referred to the Installation Manual. Due to continuing improvement, above specifications may be subject to change without notice.				

Notes:

- Nominal cooling conditions (subject to JIS B8615-2)
Indoor: 27°C D.B./19°C W.B. (81°F D.B./66°F W.B.), Outdoor: 35°C D.B./24°C W.B. (95°F D.B./75°F W.B.)
Pipe length: 7.5 m (24-9/16 ft.), Level difference: 0 m (0 ft.)
- Nominal heating conditions (subject to JIS B8615-2)
Indoor: 20°C D.B. (68°F D.B.), Outdoor: 7°C D.B./6°C W.B. (45°F D.B./43°F W.B.)
Pipe length: 7.5 m (24-9/16 ft.), Level difference: 0 m (0 ft.)
- External static pressure option is available (30Pa, 60Pa/3.1mmH₂O, 6.1mmH₂O).

Unit converter	
BTU/h	=kW x 3,412
cfm	=m ³ /min x 35.31
lbs	=kg/0.4536
*Above specification data is subject to rounding variation.	

1. SPECIFICATIONS

YKB/YLM

Model			PUHY-P800YSKB-A1 (-BS)		
Power source			3-phase 4-wire 380-400-415 V 50/60 Hz		
Cooling capacity (Nominal)	*1	kW	90.0		
		kcal/h	77,400		
		BTU/h	307,100		
	Power input	kW	27.86		
		Current input	A	47.0-44.6-43.0	
EER	kW/kW	3.23			
Temp. range of cooling	Indoor	W.B.	15.0~24.0°C (59~75°F)		
	Outdoor	D.B.	-5.0~52.0°C (23~126°F)		
Heating capacity (Nominal)	*2	kW	100.0		
		kcal/h	86,000		
		BTU/h	341,200		
	Power input	kW	27.62		
		Current input	A	46.6-44.2-42.6	
COP	kW/kW	3.62			
Temp. range of heating	Indoor	D.B.	15.0~27.0°C (59~81°F)		
	Outdoor	W.B.	-20.0~15.5°C (-4~60°F)		
Indoor unit connectable	Total capacity		50~130% of outdoor unit capacity		
	Model/Quantity		P15~P250/2~50		
Sound pressure level (measured in anechoic room)	dB <A>		67.5		
Sound power level (measured in anechoic room)	dB <A>		87.5		
Refrigerant	Liquid pipe	mm (in.)	19.05 (3/4) Brazed		
piping diameter	Gas pipe	mm (in.)	34.93 (1-3/8) Brazed		

Set Model

Model			PUHY-P350YKB-A1 (-BS)			PUHY-P450YKB-A1 (-BS)		
FAN	Type x Quantity		Propeller fan x 1			Propeller fan x 2		
	Air flow rate	m ³ /min	210			360		
		L/s	3,500			6,000		
		cfm	7,415			12,712		
	Control, Driving mechanism		Inverter-control, Direct-driven by motor			Inverter-control, Direct-driven by motor		
	Motor output	kW	0.92 x 1			0.92 x 2		
*3	External static press.		0 Pa (0 mmH ₂ O)			0 Pa (0 mmH ₂ O)		
Compressor	Type x Quantity		Inverter scroll hermetic compressor			Inverter scroll hermetic compressor		
	Manufacture		AC&R Works, MITSUBISHI ELECTRIC CORPORATION			AC&R Works, MITSUBISHI ELECTRIC CORPORATION		
	Starting method		Inverter			Inverter		
	Motor output	kW	10.5			12.4		
	Case heater	kW	-			0.045		
	Lubricant		MEL32			MEL32		
External finish			Pre-coated galvanized steel sheets (+powder coating for -BS type) <MUNSELL 5Y 8/1 or similar>			Pre-coated galvanized steel sheets (+powder coating for -BS type) <MUNSELL 5Y 8/1 or similar>		
External dimension H x W x D			mm 1,710 (1,650 without legs) x 1,220 x 740			mm 1,710 (1,650 without legs) x 1,750 x 740		
			in. 67-3/8 (65 without legs) x 48-1/16 x 29-3/16			in. 67-3/8 (65 without legs) x 68-15/16 x 29-3/16		
Protection devices	High pressure protection		High pressure sensor, High pressure switch at 4.15 MPa (601 psi)			High pressure sensor, High pressure switch at 4.15 MPa (601 psi)		
	Inverter circuit (COMP./FAN)		Over-heat protection, Over-current protection			Over-heat protection, Over-current protection		
	Compressor		-			-		
	Fan motor		-			-		
Refrigerant	Type x original charge		R410A x 11.5 kg (26 lbs)			R410A x 11.8 kg (27 lbs)		
	Control		LEV and HIC circuit					
Net weight			kg (lbs) 251 (554)			kg (lbs) 304 (671)		
Heat exchanger			Salt-resistant cross fin & copper tube			Salt-resistant cross fin & copper tube		
HIC circuit (HIC: Heat Inter-Changer)			Copper pipe, tube-in-tube structure			Copper pipe, tube-in-tube structure		
Pipe between unit and distributor	Liquid pipe	mm (in.)	12.7 (1/2) Brazed			15.88 (5/8) Brazed		
	Gas pipe	mm (in.)	28.58 (1-1/8) Brazed			28.58 (1-1/8) Brazed		
Defrosting method			Auto-defrost mode (Reversed refrigerant cycle, Hot gas)					
Drawing	External		KJ94T002					
	Wiring		KE94G038			KE94C967		
Standard attachment	Document		Installation Manual					
	Accessory		Refrigerant conn. pipe					
Optional parts			Outdoor Twinning kit: CMY-Y200VBK2 Joint: CMY-Y102SS/LS-G2, CMY-Y202S/302S-G2 Header: CMY-Y104/108/1010-G					
Remarks			Details on foundation work, duct work, insulation work, electrical wiring, power source switch, and other items shall be referred to the Installation Manual. Due to continuing improvement, above specifications may be subject to change without notice.					

Notes:

- Nominal cooling conditions (subject to JIS B8615-2)
Indoor: 27°C D.B./19°C W.B. (81°F D.B./66°F W.B.), Outdoor: 35°C D.B./24°C W.B. (95°F D.B./75°F W.B.)
Pipe length: 7.5 m (24-9/16 ft.), Level difference: 0 m (0 ft.)
- Nominal heating conditions (subject to JIS B8615-2)
Indoor: 20°C D.B. (68°F D.B.), Outdoor: 7°C D.B./6°C W.B. (45°F D.B./43°F W.B.)
Pipe length: 7.5 m (24-9/16 ft.), Level difference: 0 m (0 ft.)
- External static pressure option is available (30Pa, 60Pa/3.1mmH₂O, 6.1mmH₂O).

Unit converter

BTU/h =kW x 3.412
cfm =m³/min x 35.31
lbs =kg/0.4536

*Above specification data is subject to rounding variation.

1. SPECIFICATIONS

Model		PUHY-P850YSKB-A1 (-BS)	
Power source		3-phase 4-wire 380-400-415 V 50/60 Hz	
Cooling capacity (Nominal)	*1 kW	96.0	
	kcal/h	82,600	
	*1 BTU/h	327,600	
	Power input kW	30.18	
	Current input A	50.9-48.4-46.6	
Temp. range of cooling	Indoor	W.B.	15.0~24.0°C (59~75°F)
	Outdoor	D.B.	-5.0~52.0°C (23~126°F)
Heating capacity (Nominal)	*2 kW	108.0	
	kcal/h	92,900	
	*2 BTU/h	368,500	
	Power input kW	29.90	
	Current input A	50.4-47.9-46.2	
Temp. range of heating	Indoor	D.B.	15.0~27.0°C (59~81°F)
	Outdoor	W.B.	-20.0~15.5°C (-4~60°F)
Indoor unit connectable	Total capacity	50~130% of outdoor unit capacity	
	Model/Quantity	P15-P250/2-50	
Sound pressure level (measured in anechoic room)	dB <A>	68	
Sound power level (measured in anechoic room)	dB <A>	87.5	
Refrigerant piping diameter	Liquid pipe	mm (in.)	19.05 (3/4) Brazed
	Gas pipe	mm (in.)	41.28 (1-5/8) Brazed

Set Model

Model		PUHY-P400YKB-A1 (-BS)		PUHY-P450YKB-A1 (-BS)		
FAN	Type x Quantity	Propeller fan x 1		Propeller fan x 2		
	Air flow rate	m ³ /min	210		360	
		L/s	3,500		6,000	
		cfm	7,415		12,712	
	Control, Driving mechanism	Inverter-control, Direct-driven by motor		Inverter-control, Direct-driven by motor		
*3 Motor output	kW	0.92 x 1		0.92 x 2		
External static press.		0 Pa (0 mmH ₂ O)		0 Pa (0 mmH ₂ O)		
Compressor	Type x Quantity	Inverter scroll hermetic compressor		Inverter scroll hermetic compressor		
	Manufacture	AC&R Works, MITSUBISHI ELECTRIC CORPORATION		AC&R Works, MITSUBISHI ELECTRIC CORPORATION		
	Starting method	Inverter		Inverter		
	Motor output	kW	10.8		12.4	
	Case heater	kW	-		0.045	
Lubricant		MEL32		MEL32		
External finish		Pre-coated galvanized steel sheets (+powder coating for -BS type) <MUNSELL 5Y 8/1 or similar>		Pre-coated galvanized steel sheets (+powder coating for -BS type) <MUNSELL 5Y 8/1 or similar>		
External dimension H x W x D	mm	1,710 (1,650 without legs) x 1,220 x 740		1,710 (1,650 without legs) x 1,750 x 740		
		in. 67-3/8 (65 without legs) x 48-1/16 x 29-3/16		67-3/8 (65 without legs) x 68-15/16 x 29-3/16		
Protection devices	High pressure protection	High pressure sensor, High pressure switch at 4.15 MPa (601 psi)		High pressure sensor, High pressure switch at 4.15 MPa (601 psi)		
	Inverter circuit (COMP./FAN)	Over-heat protection, Over-current protection		Over-heat protection, Over-current protection		
	Compressor	-		-		
	Fan motor	-		-		
Refrigerant	Type x original charge	R410A x 11.5 kg (26 lbs)		R410A x 11.8 kg (27 lbs)		
	Control	LEV and HIC circuit				
Net weight	kg (lbs)	251 (554)		304 (671)		
Heat exchanger		Salt-resistant cross fin & copper tube		Salt-resistant cross fin & copper tube		
HIC circuit (HIC: Heat Inter-Changer)		Copper pipe, tube-in-tube structure		Copper pipe, tube-in-tube structure		
Pipe between unit and distributor	Liquid pipe	mm (in.)	15.88 (5/8) Brazed		15.88 (5/8) Brazed	
	Gas pipe	mm (in.)	28.58 (1-1/8) Brazed		28.58 (1-1/8) Brazed	
Defrosting method		Auto-defrost mode (Reversed refrigerant cycle, Hot gas)				
Drawing	External	KJ94T002				
	Wiring	KE94G038		KE94C967		
Standard attachment	Document	Installation Manual				
	Accessory	Refrigerant conn. pipe				
Optional parts		Outdoor Twinning kit: CMY-Y200VBK2 Joint: CMY-Y102SS/LS-G2, CMY-Y202S/302S-G2 Header: CMY-Y104/108/1010-G				
Remarks		Details on foundation work, duct work, insulation work, electrical wiring, power source switch, and other items shall be referred to the Installation Manual. Due to continuing improvement, above specifications may be subject to change without notice.				

Notes:

- Nominal cooling conditions (subject to JIS B8615-2)
Indoor: 27°C D.B./19°C W.B. (81°F D.B./66°F W.B.), Outdoor: 35°C D.B./24°C W.B. (95°F D.B./75°F W.B.)
Pipe length: 7.5 m (24-9/16 ft.), Level difference: 0 m (0 ft.)
- Nominal heating conditions (subject to JIS B8615-2)
Indoor: 20°C D.B. (68°F D.B.), Outdoor: 7°C D.B./6°C W.B. (45°F D.B./43°F W.B.)
Pipe length: 7.5 m (24-9/16 ft.), Level difference: 0 m (0 ft.)
- External static pressure option is available (30Pa, 60Pa/3.1mmH₂O, 6.1mmH₂O).

Unit converter	
BTU/h	=kW x 3,412
cfm	=m ³ /min x 35.31
lbs	=kg/0.4536
*Above specification data is subject to rounding variation.	

1. SPECIFICATIONS

YKB/YLM

Model			PUHY-P900YSKB-A1 (-BS)		
Power source			3-phase 4-wire 380-400-415 V 50/60 Hz		
Cooling capacity (Nominal)	*1	kW	101.0		
		kcal/h	86,900		
		BTU/h	344,600		
	Power input	kW	31.46		
		Current input	A	53.1-50.4-48.6	
EER		kW/kW	3.21		
Temp. range of cooling	Indoor	W.B.	15.0~24.0°C (59~75°F)		
	Outdoor	D.B.	-5.0~52.0°C (23~126°F)		
Heating capacity (Nominal)	*2	kW	113.0		
		kcal/h	97,200		
		BTU/h	385,600		
	Power input	kW	33.00		
		Current input	A	55.7-52.9-51.0	
COP		kW/kW	3.42		
Temp. range of heating	Indoor	D.B.	15.0~27.0°C (59~81°F)		
	Outdoor	W.B.	-20.0~15.5°C (-4~60°F)		
Indoor unit connectable	Total capacity		50~130% of outdoor unit capacity		
	Model/Quantity		P15-P250/2~50		
Sound pressure level (measured in anechoic room)	dB <A>		69		
Sound power level (measured in anechoic room)	dB <A>		88		
Refrigerant	Liquid pipe	mm (in.)	19.05 (3/4) Brazed		
piping diameter	Gas pipe	mm (in.)	41.28 (1-5/8) Brazed		

Set Model

Model			PUHY-P450YKB-A1 (-BS)			PUHY-P450YKB-A1 (-BS)		
FAN	Type x Quantity		Propeller fan x 2			Propeller fan x 2		
	Air flow rate	m ³ /min	360			360		
		L/s	6,000			6,000		
		cfm	12,712			12,712		
	Control, Driving mechanism		Inverter-control, Direct-driven by motor			Inverter-control, Direct-driven by motor		
	Motor output	kW	0.92 x 2			0.92 x 2		
*3 External static press.		0 Pa (0 mmH ₂ O)			0 Pa (0 mmH ₂ O)			
Compressor	Type x Quantity		Inverter scroll hermetic compressor			Inverter scroll hermetic compressor		
	Manufacture		AC&R Works, MITSUBISHI ELECTRIC CORPORATION			AC&R Works, MITSUBISHI ELECTRIC CORPORATION		
	Starting method		Inverter			Inverter		
	Motor output	kW	12.4			12.4		
	Case heater	kW	0.045			0.045		
	Lubricant		MEL32			MEL32		
External finish			Pre-coated galvanized steel sheets (+powder coating for -BS type) <MUNSELL 5Y 8/1 or similar>			Pre-coated galvanized steel sheets (+powder coating for -BS type) <MUNSELL 5Y 8/1 or similar>		
External dimension H x W x D			mm 1,710 (1,650 without legs) x 1,750 x 740			mm 1,710 (1,650 without legs) x 1,750 x 740		
			in. 67-3/8 (65 without legs) x 68-15/16 x 29-3/16			in. 67-3/8 (65 without legs) x 68-15/16 x 29-3/16		
Protection devices	High pressure protection		High pressure sensor, High pressure switch at 4.15 MPa (601 psi)			High pressure sensor, High pressure switch at 4.15 MPa (601 psi)		
	Inverter circuit (COMP./FAN)		Over-heat protection, Over-current protection			Over-heat protection, Over-current protection		
	Compressor		-			-		
	Fan motor		-			-		
Refrigerant	Type x original charge		R410A x 11.8 kg (27 lbs)			R410A x 11.8 kg (27 lbs)		
	Control		LEV and HIC circuit			LEV and HIC circuit		
Net weight			kg (lbs) 304 (671)			kg (lbs) 304 (671)		
Heat exchanger			Salt-resistant cross fin & copper tube			Salt-resistant cross fin & copper tube		
HIC circuit (HIC: Heat Inter-Changer)			Copper pipe, tube-in-tube structure			Copper pipe, tube-in-tube structure		
Pipe between unit and distributor	Liquid pipe	mm (in.)	15.88 (5/8) Brazed			15.88 (5/8) Brazed		
	Gas pipe	mm (in.)	28.58 (1-1/8) Brazed			28.58 (1-1/8) Brazed		
Defrosting method			Auto-defrost mode (Reversed refrigerant cycle, Hot gas)			Auto-defrost mode (Reversed refrigerant cycle, Hot gas)		
Drawing	External		KJ94T003			KJ94T003		
	Wiring		KE94C967			KE94C967		
Standard attachment	Document		Installation Manual			Installation Manual		
	Accessory		Refrigerant conn. pipe			Refrigerant conn. pipe		
Optional parts			Outdoor Twinning kit: CMY-Y200VBK2 Joint: CMY-Y102SS/LS-G2, CMY-Y202S/302S-G2 Header: CMY-Y104/108/1010-G			Outdoor Twinning kit: CMY-Y200VBK2 Joint: CMY-Y102SS/LS-G2, CMY-Y202S/302S-G2 Header: CMY-Y104/108/1010-G		
Remarks			Details on foundation work, duct work, insulation work, electrical wiring, power source switch, and other items shall be referred to the Installation Manual. Due to continuing improvement, above specifications may be subject to change without notice.			Details on foundation work, duct work, insulation work, electrical wiring, power source switch, and other items shall be referred to the Installation Manual. Due to continuing improvement, above specifications may be subject to change without notice.		

Notes:

- Nominal cooling conditions (subject to JIS B8615-2)
Indoor: 27°C D.B./19°C W.B. (81°F D.B./66°F W.B.), Outdoor: 35°C D.B./24°C W.B. (95°F D.B./75°F W.B.)
Pipe length: 7.5 m (24-9/16 ft.), Level difference: 0 m (0 ft.)
- Nominal heating conditions (subject to JIS B8615-2)
Indoor: 20°C D.B. (68°F D.B.), Outdoor: 7°C D.B./6°C W.B. (45°F D.B./43°F W.B.)
Pipe length: 7.5 m (24-9/16 ft.), Level difference: 0 m (0 ft.)
- External static pressure option is available (30Pa, 60Pa/3.1mmH₂O, 6.1mmH₂O).

Unit converter

BTU/h =kW x 3.412
cfm =m³/min x 35.31
lbs =kg/0.4536

*Above specification data is subject to rounding variation.

1. SPECIFICATIONS

Model			PUHY-P950YSKB-A1 (-BS)	
Power source			3-phase 4-wire 380-400-415 V 50/60 Hz	
Cooling capacity (Nominal)	*1	kW	108.0	
		kcal/h	92,900	
		BTU/h	368,500	
	Power input	kW	30.25	
		A	51.0-48.5-46.7	
EER	kW/kW	3.57		
Temp. range of cooling	Indoor	W.B.	15.0~24.0°C (59~75°F)	
	Outdoor	D.B.	-5.0~52.0°C (23~126°F)	
Heating capacity (Nominal)	*2	kW	119.5	
		kcal/h	102,800	
		BTU/h	407,700	
	Power input	kW	30.40	
		A	51.3-48.7-46.9	
COP	kW/kW	3.93		
Temp. range of heating	Indoor	D.B.	15.0~27.0°C (59~81°F)	
	Outdoor	W.B.	-20.0~15.5°C (-4~60°F)	
Indoor unit connectable	Total capacity	50~130% of outdoor unit capacity		
	Model/Quantity	P15-P250/2-50		
Sound pressure level (measured in anechoic room)	dB <A>	66.5		
Sound power level (measured in anechoic room)	dB <A>	87		
Refrigerant piping diameter	Liquid pipe	mm (in.)	19.05 (3/4) Brazed	
	Gas pipe	mm (in.)	41.28 (1-5/8) Brazed	

Set Model			PUHY-P250YKB-A1 (-BS)		PUHY-P300YKB-A1 (-BS)		PUHY-P400YKB-A1 (-BS)	
FAN	Type x Quantity		Propeller fan x 1		Propeller fan x 1		Propeller fan x 1	
	Air flow rate	m ³ /min	175		210		210	
		L/s	2,917		3,500		3,500	
		cfm	6,179		7,415		7,415	
	Control, Driving mechanism		Inverter-control, Direct-driven by motor		Inverter-control, Direct-driven by motor		Inverter-control, Direct-driven by motor	
	Motor output	kW	0.92 x 1		0.92 x 1		0.92 x 1	
*3	External static press.		0 Pa (0 mmH ₂ O)		0 Pa (0 mmH ₂ O)		0 Pa (0 mmH ₂ O)	
Compressor	Type x Quantity		Inverter scroll hermetic compressor		Inverter scroll hermetic compressor		Inverter scroll hermetic compressor	
	Manufacture		AC&R Works, MITSUBISHI ELECTRIC CORPORATION		AC&R Works, MITSUBISHI ELECTRIC CORPORATION		AC&R Works, MITSUBISHI ELECTRIC CORPORATION	
	Starting method		Inverter		Inverter		Inverter	
	Motor output	kW	6.9		8.1		10.8	
	Case heater	kW	-		-		-	
Lubricant		MEL32		MEL32		MEL32		
External finish			Pre-coated galvanized steel sheets (+powder coating for -BS type) <MUNSELL 5Y 8/1 or similar>		Pre-coated galvanized steel sheets (+powder coating for -BS type) <MUNSELL 5Y 8/1 or similar>		Pre-coated galvanized steel sheets (+powder coating for -BS type) <MUNSELL 5Y 8/1 or similar>	
External dimension H x W x D			mm 1,710 (1,650 without legs) x 920 x 740		mm 1,710 (1,650 without legs) x 1,220 x 740		mm 1,710 (1,650 without legs) x 1,220 x 740	
			in. 67-3/8 (65 without legs) x 36-1/4 x 29-3/16		in. 67-3/8 (65 without legs) x 48-1/16 x 29-3/16		in. 67-3/8 (65 without legs) x 48-1/16 x 29-3/16	
Protection devices	High pressure protection		High pressure sensor, High pressure switch at 4.15 MPa (601 psi)		High pressure sensor, High pressure switch at 4.15 MPa (601 psi)		High pressure sensor, High pressure switch at 4.15 MPa (601 psi)	
	Inverter circuit (COMP./FAN)		Over-heat protection, Over-current protection		Over-heat protection, Over-current protection		Over-heat protection, Over-current protection	
	Compressor		-		-		-	
	Fan motor		-		-		-	
Refrigerant	Type x original charge		R410A x 8.0 kg (18 lbs)		R410A x 11.5 kg (26 lbs)		R410A x 11.5 kg (26 lbs)	
	Control		LEV and HIC circuit					
Net weight			kg (lbs) 199 (439)		kg (lbs) 251 (554)		kg (lbs) 251 (554)	
Heat exchanger			Salt-resistant cross fin & copper tube		Salt-resistant cross fin & copper tube		Salt-resistant cross fin & copper tube	
HIC circuit (HIC: Heat Inter-Changer)			Copper pipe, tube-in-tube structure		Copper pipe, tube-in-tube structure		Copper pipe, tube-in-tube structure	
Pipe between unit and distributor	Liquid pipe	mm (in.)	9.52 (3/8) Brazed		12.7 (1/2) Brazed		15.88 (5/8) Brazed	
	Gas pipe	mm (in.)	22.2 (7/8) Brazed		22.2 (7/8) Brazed		28.58 (1-1/8) Brazed	
Defrosting method			Auto-defrost mode (Reversed refrigerant cycle, Hot gas)					
Drawing	External		KJ94T004					
	Wiring		KE94G038		KE94G038		KE94G038	
Standard attachment	Document		Installation Manual					
	Accessory		Refrigerant conn. pipe					
Optional parts			Outdoor Twinning kit: CMY-Y300VBK3 Joint: CMY-Y102SS/LS-G2, CMY-Y202/302S-G2 Header: CMY-Y104/108/1010-G					
Remarks			Details on foundation work, duct work, insulation work, electrical wiring, power source switch, and other items shall be referred to the Installation Manual. Due to continuing improvement, above specifications may be subject to change without notice.					

Notes:	Unit converter
1.Nominal cooling conditions (subject to JIS B8615-2) Indoor: 27°C D.B./19°C W.B. (81°F D.B./66°F W.B.), Outdoor: 35°C D.B./24°C W.B. (95°F D.B./75°F W.B.) Pipe length: 7.5 m (24-9/16 ft.), Level difference: 0 m (0 ft.)	BTU/h =kW x 3,412
2.Nominal heating conditions (subject to JIS B8615-2) Indoor: 20°C D.B. (68°F D.B.), Outdoor: 7°C D.B./6°C W.B. (45°F D.B./43°F W.B.) Pipe length: 7.5 m (24-9/16 ft.), Level difference: 0 m (0 ft.)	cfm =m ³ /min x 35.31
3.External static pressure option is available (30Pa, 60Pa/3.1mmH ₂ O, 6.1mmH ₂ O).	lbs =kg/0.4536
	*Above specification data is subject to rounding variation.

1. SPECIFICATIONS

YKB/YLM

Model			PUHY-P1000YSKB-A1 (-BS)	
Power source			3-phase 4-wire 380-400-415 V 50/60 Hz	
Cooling capacity (Nominal)	*1	kW	113.0	
		kcal/h	97,200	
		BTU/h	385,600	
	Power input	kW	32.10	
		Current input	A	54.1-51.4-49.6
EER	kW/kW	3.52		
Temp. range of cooling	Indoor	W.B.	15.0~24.0°C (59~75°F)	
	Outdoor	D.B.	-5.0~52.0°C (23~126°F)	
Heating capacity (Nominal)	*2	kW	127.0	
		kcal/h	109,200	
		BTU/h	433,300	
	Power input	kW	32.70	
		Current input	A	55.2-52.4-50.5
COP	kW/kW	3.88		
Temp. range of heating	Indoor	D.B.	15.0~27.0°C (59~81°F)	
	Outdoor	W.B.	-20.0~15.5°C (-4~60°F)	
Indoor unit connectable	Total capacity	50~130% of outdoor unit capacity		
	Model/Quantity	P15~P250/2~50		
Sound pressure level (measured in anechoic room)	dB <A>	66.5		
Sound power level (measured in anechoic room)	dB <A>	88		
Refrigerant piping diameter	Liquid pipe	mm (in.)	19.05 (3/4) Brazed	
	Gas pipe	mm (in.)	41.28 (1-5/8) Brazed	

Set Model

Model			PUHY-P300YKB-A1 (-BS)		PUHY-P300YKB-A1 (-BS)		PUHY-P400YKB-A1 (-BS)	
FAN	Type x Quantity		Propeller fan x 1		Propeller fan x 1		Propeller fan x 1	
	Air flow rate	m ³ /min	210		210		210	
		L/s	3,500		3,500		3,500	
		cfm	7,415		7,415		7,415	
	Control, Driving mechanism		Inverter-control, Direct-driven by motor		Inverter-control, Direct-driven by motor		Inverter-control, Direct-driven by motor	
	Motor output	kW	0.92 x 1		0.92 x 1		0.92 x 1	
*3 External static press.		0 Pa (0 mmH ₂ O)		0 Pa (0 mmH ₂ O)		0 Pa (0 mmH ₂ O)		
Compressor	Type x Quantity		Inverter scroll hermetic compressor		Inverter scroll hermetic compressor		Inverter scroll hermetic compressor	
	Manufacture		AC&R Works, MITSUBISHI ELECTRIC CORPORATION		AC&R Works, MITSUBISHI ELECTRIC CORPORATION		AC&R Works, MITSUBISHI ELECTRIC CORPORATION	
	Starting method		Inverter		Inverter		Inverter	
	Motor output	kW	8.1		8.1		10.8	
	Case heater	kW	-		-		-	
	Lubricant		MEL32		MEL32		MEL32	
External finish			Pre-coated galvanized steel sheets (+powder coating for -BS type) <MUNSELL 5Y 8/1 or similar>		Pre-coated galvanized steel sheets (+powder coating for -BS type) <MUNSELL 5Y 8/1 or similar>		Pre-coated galvanized steel sheets (+powder coating for -BS type) <MUNSELL 5Y 8/1 or similar>	
External dimension H x W x D			mm	1,710 (1,650 without legs) x 1,220 x 740	1,710 (1,650 without legs) x 1,220 x 740	1,710 (1,650 without legs) x 1,220 x 740	1,710 (1,650 without legs) x 1,220 x 740	
			in.	67-3/8 (65 without legs) x 48-1/16 x 29-3/16	67-3/8 (65 without legs) x 48-1/16 x 29-3/16	67-3/8 (65 without legs) x 48-1/16 x 29-3/16	67-3/8 (65 without legs) x 48-1/16 x 29-3/16	
Protection devices	High pressure protection		High pressure sensor, High pressure switch at 4.15 MPa (601 psi)		High pressure sensor, High pressure switch at 4.15 MPa (601 psi)		High pressure sensor, High pressure switch at 4.15 MPa (601 psi)	
	Inverter circuit (COMP./FAN)		Over-heat protection, Over-current protection		Over-heat protection, Over-current protection		Over-heat protection, Over-current protection	
	Compressor		-		-		-	
	Fan motor		-		-		-	
Refrigerant	Type x original charge		R410A x 11.5 kg (26 lbs)		R410A x 11.5 kg (26 lbs)		R410A x 11.5 kg (26 lbs)	
	Control		LEV and HIC circuit					
Net weight			kg (lbs)	251 (554)	251 (554)	251 (554)	251 (554)	
Heat exchanger			Salt-resistant cross fin & copper tube		Salt-resistant cross fin & copper tube		Salt-resistant cross fin & copper tube	
HIC circuit (HIC: Heat Inter-Changer)			Copper pipe, tube-in-tube structure		Copper pipe, tube-in-tube structure		Copper pipe, tube-in-tube structure	
Pipe between unit and distributor	Liquid pipe	mm (in.)	12.7 (1/2) Brazed		12.7 (1/2) Brazed		15.88 (5/8) Brazed	
	Gas pipe	mm (in.)	22.2 (7/8) Brazed		22.2 (7/8) Brazed		28.58 (1-1/8) Brazed	
Defrosting method			Auto-defrost mode (Reversed refrigerant cycle, Hot gas)					
Drawing	External		KJ94T005					
	Wiring		KE94G038		KE94G038		KE94G038	
Standard attachment	Document		Installation Manual					
	Accessory		Refrigerant conn. pipe					
Optional parts			Outdoor Twinning kit: CMY-Y300VBK3 Joint: CMY-Y102SS/LS-G2, CMY-Y202/302S-G2 Header: CMY-Y104/108/1010-G					
Remarks			Details on foundation work, duct work, insulation work, electrical wiring, power source switch, and other items shall be referred to the Installation Manual. Due to continuing improvement, above specifications may be subject to change without notice.					

Notes:

- Nominal cooling conditions (subject to JIS B8615-2)
Indoor: 27°C D.B./19°C W.B. (81°F D.B./66°F W.B.), Outdoor: 35°C D.B./24°C W.B. (95°F D.B./75°F W.B.)
Pipe length: 7.5 m (24-9/16 ft.), Level difference: 0 m (0 ft.)
- Nominal heating conditions (subject to JIS B8615-2)
Indoor: 20°C D.B. (68°F D.B.), Outdoor: 7°C D.B./6°C W.B. (45°F D.B./43°F W.B.)
Pipe length: 7.5 m (24-9/16 ft.), Level difference: 0 m (0 ft.)
- External static pressure option is available (30Pa, 60Pa/3.1mmH₂O, 6.1mmH₂O).

Unit converter

BTU/h	=kW x 3,412
cfm	=m ³ /min x 35.31
lbs	=kg/0.4536

*Above specification data is subject to rounding variation.

1. SPECIFICATIONS

YKB/YLM

Model		PUHY-P1050YSKB-A1 (-BS)	
Power source		3-phase 4-wire 380-400-415 V 50/60 Hz	
Cooling capacity (Nominal)	*1 kW	118.0	
	kcal/h	101,500	
	*1 BTU/h	402,600	
	Power input kW	35.01	
	Current input A	59.1-56.1-54.1	
Temp. range of cooling	EER	3.37	
	Indoor	W.B.	15.0~24.0°C (59~75°F)
	Outdoor	D.B.	-5.0~52.0°C (23~126°F)
Heating capacity (Nominal)	*2 kW	132.0	
	kcal/h	113,500	
	*2 BTU/h	450,400	
	Power input kW	34.25	
	Current input A	57.8-54.9-52.9	
Temp. range of heating	COP	3.85	
	Indoor	D.B.	15.0~27.0°C (59~81°F)
	Outdoor	W.B.	-20.0~15.5°C (-4~60°F)
Indoor unit connectable	Total capacity	50~130% of outdoor unit capacity	
	Model/Quantity	P15~P250/2~50	
Sound pressure level (measured in anechoic room)	dB <A>	66.5	
Sound power level (measured in anechoic room)	dB <A>	88	
Refrigerant piping diameter	Liquid pipe	mm (in.)	19.05 (3/4) Brazed
	Gas pipe	mm (in.)	41.28 (1-5/8) Brazed

Set Model

Model		PUHY-P300YKB-A1 (-BS)		PUHY-P350YKB-A1 (-BS)		PUHY-P400YKB-A1 (-BS)		
FAN	Type x Quantity		Propeller fan x 1		Propeller fan x 1		Propeller fan x 1	
	Air flow rate	m ³ /min	210		210		210	
		L/s	3,500		3,500		3,500	
		cfm	7,415		7,415		7,415	
	Control, Driving mechanism		Inverter-control, Direct-driven by motor		Inverter-control, Direct-driven by motor		Inverter-control, Direct-driven by motor	
	Motor output	kW	0.92 x 1		0.92 x 1		0.92 x 1	
*3 External static press.		0 Pa (0 mmH ₂ O)		0 Pa (0 mmH ₂ O)		0 Pa (0 mmH ₂ O)		
Compressor	Type x Quantity		Inverter scroll hermetic compressor		Inverter scroll hermetic compressor		Inverter scroll hermetic compressor	
	Manufacture		AC&R Works, MITSUBISHI ELECTRIC CORPORATION		AC&R Works, MITSUBISHI ELECTRIC CORPORATION		AC&R Works, MITSUBISHI ELECTRIC CORPORATION	
	Starting method		Inverter		Inverter		Inverter	
	Motor output	kW	8.1		10.5		10.8	
	Case heater	kW	-		-		-	
	Lubricant		MEL32		MEL32		MEL32	
External finish		Pre-coated galvanized steel sheets (+powder coating for -BS type) <MUNSELL 5Y 8/1 or similar>		Pre-coated galvanized steel sheets (+powder coating for -BS type) <MUNSELL 5Y 8/1 or similar>		Pre-coated galvanized steel sheets (+powder coating for -BS type) <MUNSELL 5Y 8/1 or similar>		
External dimension H x W x D		mm	1,710 (1,650 without legs) x 1,220 x 740		1,710 (1,650 without legs) x 1,220 x 740		1,710 (1,650 without legs) x 1,220 x 740	
		in.	67-3/8 (65 without legs) x 48-1/16 x 29-3/16		67-3/8 (65 without legs) x 48-1/16 x 29-3/16		67-3/8 (65 without legs) x 48-1/16 x 29-3/16	
Protection devices	High pressure protection		High pressure sensor, High pressure switch at 4.15 MPa (601 psi)		High pressure sensor, High pressure switch at 4.15 MPa (601 psi)		High pressure sensor, High pressure switch at 4.15 MPa (601 psi)	
	Inverter circuit (COMP./FAN)		Over-heat protection, Over-current protection		Over-heat protection, Over-current protection		Over-heat protection, Over-current protection	
	Compressor		-		-		-	
	Fan motor		-		-		-	
Refrigerant	Type x original charge		R410A x 11.5 kg (26 lbs)		R410A x 11.5 kg (26 lbs)		R410A x 11.5 kg (26 lbs)	
	Control		LEV and HIC circuit		LEV and HIC circuit		LEV and HIC circuit	
Net weight		kg (lbs)	251 (554)		251 (554)		251 (554)	
Heat exchanger		Salt-resistant cross fin & copper tube		Salt-resistant cross fin & copper tube		Salt-resistant cross fin & copper tube		
HIC circuit (HIC: Heat Inter-Changer)		Copper pipe, tube-in-tube structure		Copper pipe, tube-in-tube structure		Copper pipe, tube-in-tube structure		
Pipe between unit and distributor	Liquid pipe	mm (in.)	12.7 (1/2) Brazed		12.7 (1/2) Brazed		15.88 (5/8) Brazed	
	Gas pipe	mm (in.)	22.2 (7/8) Brazed		28.58 (1-1/8) Brazed		28.58 (1-1/8) Brazed	
Defrosting method		Auto-defrost mode (Reversed refrigerant cycle, Hot gas)		Auto-defrost mode (Reversed refrigerant cycle, Hot gas)		Auto-defrost mode (Reversed refrigerant cycle, Hot gas)		
Drawing	External		KJ94T005		KJ94T005		KJ94T005	
	Wiring		KE94G038		KE94G038		KE94G038	
Standard attachment	Document		Installation Manual		Installation Manual		Installation Manual	
	Accessory		Refrigerant conn. pipe		Refrigerant conn. pipe		Refrigerant conn. pipe	
Optional parts		Outdoor Twinning kit: CMY-Y300VBK3 Joint: CMY-Y102SS/LS-G2, CMY-Y202/302S-G2 Header: CMY-Y104/108/1010-G		Outdoor Twinning kit: CMY-Y300VBK3 Joint: CMY-Y102SS/LS-G2, CMY-Y202/302S-G2 Header: CMY-Y104/108/1010-G		Outdoor Twinning kit: CMY-Y300VBK3 Joint: CMY-Y102SS/LS-G2, CMY-Y202/302S-G2 Header: CMY-Y104/108/1010-G		
Remarks		Details on foundation work, duct work, insulation work, electrical wiring, power source switch, and other items shall be referred to the Installation Manual. Due to continuing improvement, above specifications may be subject to change without notice.		Details on foundation work, duct work, insulation work, electrical wiring, power source switch, and other items shall be referred to the Installation Manual. Due to continuing improvement, above specifications may be subject to change without notice.		Details on foundation work, duct work, insulation work, electrical wiring, power source switch, and other items shall be referred to the Installation Manual. Due to continuing improvement, above specifications may be subject to change without notice.		

Notes:

- Nominal cooling conditions (subject to JIS B8615-2)
Indoor: 27°C D.B./19°C W.B. (81°F D.B./66°F W.B.), Outdoor: 35°C D.B./24°C W.B. (95°F D.B./75°F W.B.)
Pipe length: 7.5 m (24-9/16 ft.), Level difference: 0 m (0 ft.)
- Nominal heating conditions (subject to JIS B8615-2)
Indoor: 20°C D.B. (68°F D.B.), Outdoor: 7°C D.B./6°C W.B. (45°F D.B./43°F W.B.)
Pipe length: 7.5 m (24-9/16 ft.), Level difference: 0 m (0 ft.)
- External static pressure option is available (30Pa, 60Pa/3.1mmH₂O, 6.1mmH₂O).

Unit converter	
BTU/h	=kW x 3,412
cfm	=m ³ /min x 35.31
lbs	=kg/0.4536
*Above specification data is subject to rounding variation.	

1. SPECIFICATIONS

YKB/YLM

Model			PUHY-P1100YSKB-A1 (-BS)		
Power source			3-phase 4-wire 380-400-415 V 50/60 Hz		
Cooling capacity (Nominal)	*1	kW	124.0		
		kcal/h	106,600		
		BTU/h	423,100		
	Power input	kW	38.62		
		Current input	A	65.1-61.9-59.6	
EER	kW/kW	3.21			
Temp. range of cooling	Indoor	W.B.	15.0~24.0°C (59~75°F)		
	Outdoor	D.B.	-5.0~52.0°C (23~126°F)		
Heating capacity (Nominal)	*2	kW	140.0		
		kcal/h	120,400		
		BTU/h	477,700		
	Power input	kW	36.60		
		Current input	A	61.7-58.6-56.5	
COP	kW/kW	3.82			
Temp. range of heating	Indoor	D.B.	15.0~27.0°C (59~81°F)		
	Outdoor	W.B.	-20.0~15.5°C (-4~60°F)		
Indoor unit connectable	Total capacity	50~130% of outdoor unit capacity			
	Model/Quantity	P15~P250/2~50			
Sound pressure level (measured in anechoic room)	dB <A>	66.5			
Sound power level (measured in anechoic room)	dB <A>	88			
Refrigerant piping diameter	Liquid pipe	mm (in.)	19.05 (3/4) Brazed		
	Gas pipe	mm (in.)	41.28 (1-5/8) Brazed		

Set Model

Model			PUHY-P350YKB-A1 (-BS)	PUHY-P350YKB-A1 (-BS)	PUHY-P400YKB-A1 (-BS)
FAN	Type x Quantity		Propeller fan x 1		
	Air flow rate	m ³ /min	210		
		L/s	3,500		
		cfm	7,415		
	Control, Driving mechanism		Inverter-control, Direct-driven by motor		
	Motor output	kW	0.92 x 1		
*3 External static press.		0 Pa (0 mmH ₂ O)			
Compressor	Type x Quantity		Inverter scroll hermetic compressor		
	Manufacture		AC&R Works, MITSUBISHI ELECTRIC CORPORATION		
	Starting method		Inverter		
	Motor output	kW	10.5		
	Case heater	kW	-		
	Lubricant		MEL32		
External finish			Pre-coated galvanized steel sheets (+powder coating for -BS type) <MUNSELL 5Y 8/1 or similar>		Pre-coated galvanized steel sheets (+powder coating for -BS type) <MUNSELL 5Y 8/1 or similar>
External dimension H x W x D			mm 1,710 (1,650 without legs) x 1,220 x 740 67-3/8 (65 without legs) x 48-1/16 x 29-3/16		mm 1,710 (1,650 without legs) x 1,220 x 740 67-3/8 (65 without legs) x 48-1/16 x 29-3/16
Protection devices	High pressure protection		High pressure sensor, High pressure switch at 4.15 MPa (601 psi)		High pressure sensor, High pressure switch at 4.15 MPa (601 psi)
	Inverter circuit (COMP./FAN)		Over-heat protection, Over-current protection		Over-heat protection, Over-current protection
	Compressor		-		-
	Fan motor		-		-
Refrigerant	Type x original charge		R410A x 11.5 kg (26 lbs)		R410A x 11.5 kg (26 lbs)
	Control		LEV and HIC circuit		
Net weight		kg (lbs)	251 (554)		251 (554)
Heat exchanger			Salt-resistant cross fin & copper tube		Salt-resistant cross fin & copper tube
HIC circuit (HIC: Heat Inter-Changer)			Copper pipe, tube-in-tube structure		Copper pipe, tube-in-tube structure
Pipe between unit and distributor	Liquid pipe	mm (in.)	12.7 (1/2) Brazed		15.88 (5/8) Brazed
	Gas pipe	mm (in.)	28.58 (1-1/8) Brazed		28.58 (1-1/8) Brazed
Defrosting method			Auto-defrost mode (Reversed refrigerant cycle, Hot gas)		
Drawing	External		KJ94T005		
	Wiring		KE94G038		KE94G038
Standard attachment	Document		Installation Manual		
	Accessory		Refrigerant conn. pipe		
Optional parts			Outdoor Twinning kit: CMY-Y300VBK3 Joint: CMY-Y102SS/LS-G2, CMY-Y202/302S-G2 Header: CMY-Y104/108/1010-G		
Remarks			Details on foundation work, duct work, insulation work, electrical wiring, power source switch, and other items shall be referred to the Installation Manual. Due to continuing improvement, above specifications may be subject to change without notice.		

Notes:

- Nominal cooling conditions (subject to JIS B8615-2)
Indoor: 27°CDB./19°CWB. (81°FDB./66°FWB.), Outdoor: 35°CDB./24°CWB. (95°FDB./75°FWB.)
Pipe length: 7.5 m (24-9/16 ft.), Level difference: 0 m (0 ft.)
- Nominal heating conditions (subject to JIS B8615-2)
Indoor: 20°CDB. (68°FDB.), Outdoor: 7°CDB./6°CWB. (45°FDB./43°FWB.)
Pipe length: 7.5 m (24-9/16 ft.), Level difference: 0 m (0 ft.)
- External static pressure option is available (30Pa, 60Pa/3.1mmH₂O, 6.1mmH₂O).

Unit converter

BTU/h =kW x 3,412
cfm =m³/min x 35.31
lbs =kg/0.4536

*Above specification data is subject to rounding variation.

1. SPECIFICATIONS

YKB/YLM

Model		PUHY-P1150YSKB-A1 (-BS)	
Power source		3-phase 4-wire 380-400-415 V 50/60 Hz	
Cooling capacity (Nominal)	*1 kW	130.0	
	kcal/h	111,800	
	*1 BTU/h	443,600	
	Power input	40.24	
	Current input	A 67.9-64.5-62.2	
Temp. range of cooling	EER	kW/kW 3.23	
	Indoor	W.B. 15.0~24.0°C (59~75°F)	
	Outdoor	D.B. -5.0~52.0°C (23~126°F)	
Heating capacity (Nominal)	*2 kW	145.0	
	kcal/h	124,700	
	*2 BTU/h	494,700	
	Power input	kW 39.29	
	Current input	A 66.3-63.0-60.7	
Temp. range of heating	COP	kW/kW 3.69	
	Indoor	D.B. 15.0~27.0°C (59~81°F)	
	Outdoor	W.B. -20.0~15.5°C (-4~60°F)	
Indoor unit connectable	Total capacity	50~130% of outdoor unit capacity	
	Model/Quantity	P15~P250/2~50	
Sound pressure level (measured in anechoic room)	dB <A>	68.5	
Sound power level (measured in anechoic room)	dB <A>	88.5	
Refrigerant piping diameter	Liquid pipe	mm (in.) 19.05 (3/4) Brazed	
	Gas pipe	mm (in.) 41.28 (1-5/8) Brazed	

Set Model		PUHY-P350YKB-A1 (-BS)		PUHY-P350YKB-A1 (-BS)		PUHY-P450YKB-A1 (-BS)		
FAN	Type x Quantity	Propeller fan x 1		Propeller fan x 1		Propeller fan x 2		
	Air flow rate	m ³ /min	210		210		360	
		L/s	3,500		3,500		6,000	
		cfm	7,415		7,415		12,712	
	Control, Driving mechanism	Inverter-control, Direct-driven by motor		Inverter-control, Direct-driven by motor		Inverter-control, Direct-driven by motor		
	Motor output	kW	0.92 x 1		0.92 x 1		0.92 x 2	
*3 External static press.		0 Pa (0 mmH ₂ O)		0 Pa (0 mmH ₂ O)		0 Pa (0 mmH ₂ O)		
Compressor	Type x Quantity	Inverter scroll hermetic compressor		Inverter scroll hermetic compressor		Inverter scroll hermetic compressor		
	Manufacture	AC&R Works, MITSUBISHI ELECTRIC CORPORATION		AC&R Works, MITSUBISHI ELECTRIC CORPORATION		AC&R Works, MITSUBISHI ELECTRIC CORPORATION		
	Starting method	Inverter		Inverter		Inverter		
	Motor output	kW	10.5		10.5		12.4	
	Case heater	kW	-		-		0.045	
	Lubricant		MEL32		MEL32		MEL32	
External finish		Pre-coated galvanized steel sheets (+powder coating for -BS type) <MUNSELL 5Y 8/1 or similar>		Pre-coated galvanized steel sheets (+powder coating for -BS type) <MUNSELL 5Y 8/1 or similar>		Pre-coated galvanized steel sheets (+powder coating for -BS type) <MUNSELL 5Y 8/1 or similar>		
External dimension H x W x D	mm	1,710 (1,650 without legs) x 1,220 x 740		1,710 (1,650 without legs) x 1,220 x 740		1,710 (1,650 without legs) x 1,750 x 740		
	in.	67-3/8 (65 without legs) x 48-1/16 x 29-3/16		67-3/8 (65 without legs) x 48-1/16 x 29-3/16		67-3/8 (65 without legs) x 68-15/16 x 29-3/16		
Protection devices	High pressure protection	High pressure sensor, High pressure switch at 4.15 MPa (601 psi)		High pressure sensor, High pressure switch at 4.15 MPa (601 psi)		High pressure sensor, High pressure switch at 4.15 MPa (601 psi)		
	Inverter circuit (COMP./FAN)	Over-heat protection, Over-current protection		Over-heat protection, Over-current protection		Over-heat protection, Over-current protection		
	Compressor	-		-		-		
	Fan motor	-		-		-		
Refrigerant	Type x original charge	R410A x 11.5 kg (26 lbs)		R410A x 11.5 kg (26 lbs)		R410A x 11.8 kg (27 lbs)		
	Control			LEV and HIC circuit				
Net weight	kg (lbs)	251 (554)		251 (554)		304 (671)		
Heat exchanger		Salt-resistant cross fin & copper tube		Salt-resistant cross fin & copper tube		Salt-resistant cross fin & copper tube		
HIC circuit (HIC: Heat Inter-Changer)		Copper pipe, tube-in-tube structure		Copper pipe, tube-in-tube structure		Copper pipe, tube-in-tube structure		
Pipe between unit and distributor	Liquid pipe	mm (in.)	12.7 (1/2) Brazed		12.7 (1/2) Brazed		15.88 (5/8) Brazed	
	Gas pipe	mm (in.)	28.58 (1-1/8) Brazed		28.58 (1-1/8) Brazed		28.58 (1-1/8) Brazed	
Defrosting method		Auto-defrost mode (Reversed refrigerant cycle, Hot gas)						
Drawing	External	KJ94T006						
	Wiring	KE94G038		KE94G038		KE94C967		
Standard attachment	Document	Installation Manual						
	Accessory	Refrigerant conn. pipe						
Optional parts		Outdoor Twinning kit: CMY-Y300VBK3 Joint: CMY-Y102SS/LS-G2, CMY-Y202/302S-G2 Header: CMY-Y104/108/1010-G						
Remarks		Details on foundation work, duct work, insulation work, electrical wiring, power source switch, and other items shall be referred to the Installation Manual. Due to continuing improvement, above specifications may be subject to change without notice.						

Notes:	Unit converter
1.Nominal cooling conditions (subject to JIS B8615-2) Indoor: 27°C D.B./19°C W.B. (81°F D.B./66°F W.B.), Outdoor: 35°C D.B./24°C W.B. (95°F D.B./75°F W.B.) Pipe length: 7.5 m (24-9/16 ft.), Level difference: 0 m (0 ft.)	BTU/h =kW x 3,412
2.Nominal heating conditions (subject to JIS B8615-2) Indoor: 20°C D.B. (68°F D.B.), Outdoor: 7°C D.B./6°C W.B. (45°F D.B./43°F W.B.) Pipe length: 7.5 m (24-9/16 ft.), Level difference: 0 m (0 ft.)	cfm =m ³ /min x 35.31
3.External static pressure option is available (30Pa, 60Pa/3.1mmH ₂ O, 6.1mmH ₂ O).	lbs =kg/0.4536
	*Above specification data is subject to rounding variation.

1. SPECIFICATIONS

YKB/YLM

Model			PUHY-P1200YSKB-A1 (-BS)		
Power source			3-phase 4-wire 380-400-415 V 50/60 Hz		
Cooling capacity (Nominal)	*1	kW	136.0		
		kcal/h	117,000		
		BTU/h	464,000		
	Power input	kW	44.10		
		Current input	A	74.4-70.7-68.1	
EER	kW/kW	3.08			
Temp. range of cooling	Indoor	W.B.	15.0~24.0°C (59~75°F)		
	Outdoor	D.B.	-5.0~52.0°C (23~126°F)		
Heating capacity (Nominal)	*2	kW	150.0		
		kcal/h	129,000		
		BTU/h	511,800		
	Power input	kW	40.76		
		Current input	A	68.8-65.3-63.0	
COP	kW/kW	3.68			
Temp. range of heating	Indoor	D.B.	15.0~27.0°C (59~81°F)		
	Outdoor	W.B.	-20.0~15.5°C (-4~60°F)		
Indoor unit connectable	Total capacity		50~130% of outdoor unit capacity		
	Model/Quantity		P15~P250/2~50		
Sound pressure level (measured in anechoic room)	dB <A>		69		
Sound power level (measured in anechoic room)	dB <A>		88.5		
Refrigerant piping diameter	Liquid pipe	mm (in.)	19.05 (3/4) Brazed		
	Gas pipe	mm (in.)	41.28 (1-5/8) Brazed		

Set Model

Model			PUHY-P350YKB-A1 (-BS)	PUHY-P400YKB-A1 (-BS)	PUHY-P450YKB-A1 (-BS)
FAN	Type x Quantity		Propeller fan x 1	Propeller fan x 1	Propeller fan x 2
	Air flow rate	m ³ /min	210	210	360
		L/s	3,500	3,500	6,000
		cfm	7,415	7,415	12,712
	Control, Driving mechanism		Inverter-control, Direct-driven by motor	Inverter-control, Direct-driven by motor	Inverter-control, Direct-driven by motor
	Motor output	kW	0.92 x 1	0.92 x 1	0.92 x 2
*3 External static press.		0 Pa (0 mmH ₂ O)	0 Pa (0 mmH ₂ O)	0 Pa (0 mmH ₂ O)	
Compressor	Type x Quantity		Inverter scroll hermetic compressor	Inverter scroll hermetic compressor	Inverter scroll hermetic compressor
	Manufacture		AC&R Works, MITSUBISHI ELECTRIC CORPORATION	AC&R Works, MITSUBISHI ELECTRIC CORPORATION	AC&R Works, MITSUBISHI ELECTRIC CORPORATION
	Starting method		Inverter	Inverter	Inverter
	Motor output	kW	10.5	10.8	12.4
	Case heater	kW	-	-	0.045
	Lubricant		MEL32	MEL32	MEL32
External finish			Pre-coated galvanized steel sheets (+powder coating for -BS type) <MUNSELL 5Y 8/1 or similar>	Pre-coated galvanized steel sheets (+powder coating for -BS type) <MUNSELL 5Y 8/1 or similar>	Pre-coated galvanized steel sheets (+powder coating for -BS type) <MUNSELL 5Y 8/1 or similar>
External dimension H x W x D		mm	1,710 (1,650 without legs) x 1,220 x 740	1,710 (1,650 without legs) x 1,220 x 740	1,710 (1,650 without legs) x 1,750 x 740
		in.	67-3/8 (65 without legs) x 48-1/16 x 29-3/16	67-3/8 (65 without legs) x 48-1/16 x 29-3/16	67-3/8 (65 without legs) x 68-15/16 x 29-3/16
Protection devices	High pressure protection		High pressure sensor, High pressure switch at 4.15 MPa (601 psi)	High pressure sensor, High pressure switch at 4.15 MPa (601 psi)	High pressure sensor, High pressure switch at 4.15 MPa (601 psi)
	Inverter circuit (COMP./FAN)		Over-heat protection, Over-current protection	Over-heat protection, Over-current protection	Over-heat protection, Over-current protection
	Compressor		-	-	-
	Fan motor		-	-	-
Refrigerant	Type x original charge		R410A x 11.5 kg (26 lbs)	R410A x 11.5 kg (26 lbs)	R410A x 11.8 kg (27 lbs)
	Control		LEV and HIC circuit		
Net weight		kg (lbs)	251 (554)	251 (554)	304 (671)
Heat exchanger			Salt-resistant cross fin & copper tube	Salt-resistant cross fin & copper tube	Salt-resistant cross fin & copper tube
HIC circuit (HIC: Heat Inter-Changer)			Copper pipe, tube-in-tube structure	Copper pipe, tube-in-tube structure	Copper pipe, tube-in-tube structure
Pipe between unit and distributor	Liquid pipe	mm (in.)	12.7 (1/2) Brazed	15.88 (5/8) Brazed	15.88 (5/8) Brazed
	Gas pipe	mm (in.)	28.58 (1-1/8) Brazed	28.58 (1-1/8) Brazed	28.58 (1-1/8) Brazed
Defrosting method			Auto-defrost mode (Reversed refrigerant cycle, Hot gas)		
Drawing	External		KJ94T006		
	Wiring		KE94G038	KE94G038	KE94C967
Standard attachment	Document		Installation Manual		
	Accessory		Refrigerant conn. pipe		
Optional parts			Outdoor Twinning kit: CMY-Y300VBK3 Joint: CMY-Y102SS/LS-G2, CMY-Y202/302S-G2 Header: CMY-Y104/108/1010-G		
Remarks			Details on foundation work, duct work, insulation work, electrical wiring, power source switch, and other items shall be referred to the Installation Manual. Due to continuing improvement, above specifications may be subject to change without notice.		

Notes:

- Nominal cooling conditions (subject to JIS B8615-2)
Indoor: 27°C D.B./19°C W.B. (81°F D.B./66°F W.B.), Outdoor: 35°C D.B./24°C W.B. (95°F D.B./75°F W.B.)
Pipe length: 7.5 m (24-9/16 ft.), Level difference: 0 m (0 ft.)
- Nominal heating conditions (subject to JIS B8615-2)
Indoor: 20°C D.B. (68°F D.B.), Outdoor: 7°C D.B./6°C W.B. (45°F D.B./43°F W.B.)
Pipe length: 7.5 m (24-9/16 ft.), Level difference: 0 m (0 ft.)
- External static pressure option is available (30Pa, 60Pa/3.1mmH₂O, 6.1mmH₂O).

Unit converter

BTU/h	=kW x 3,412
cfm	=m ³ /min x 35.31
lbs	=kg/0.4536

*Above specification data is subject to rounding variation.

1. SPECIFICATIONS

YKB/YLM

Model		PUHY-P1250YSKB-A1 (-BS)	
Power source		3-phase 4-wire 380-400-415 V 50/60 Hz	
Cooling capacity (Nominal)	*1	kW	140.0
		kcal/h	120,400
		BTU/h	477,700
	Power input	kW	43.80
		Current input	A
EER	kW/kW	3.19	
Temp. range of cooling	Indoor	W.B.	15.0~24.0°C (59~75°F)
	Outdoor	D.B.	-5.0~52.0°C (23~126°F)
Heating capacity (Nominal)	*2	kW	156.5
		kcal/h	134,600
		BTU/h	534,000
	Power input	kW	44.08
		Current input	A
COP	kW/kW	3.55	
Temp. range of heating	Indoor	D.B.	15.0~27.0°C (59~81°F)
	Outdoor	W.B.	-20.0~15.5°C (-4~60°F)
Indoor unit connectable	Total capacity	50~130% of outdoor unit capacity	
	Model/Quantity	P15~P250/2~50	
Sound pressure level (measured in anechoic room)	dB <A>	70	
Sound power level (measured in anechoic room)	dB <A>	89.5	
Refrigerant piping diameter	Liquid pipe	mm (in.)	19.05 (3/4) Brazed
	Gas pipe	mm (in.)	41.28 (1-5/8) Brazed

Set Model

Model		PUHY-P350YKB-A1 (-BS)		PUHY-P450YKB-A1 (-BS)		PUHY-P450YKB-A1 (-BS)		
FAN	Type x Quantity	Propeller fan x 1		Propeller fan x 2		Propeller fan x 2		
	Air flow rate	m ³ /min	210	360	360			
		L/s	3,500	6,000	6,000			
		cfm	7,415	12,712	12,712			
	Control, Driving mechanism	Inverter-control, Direct-driven by motor		Inverter-control, Direct-driven by motor		Inverter-control, Direct-driven by motor		
	Motor output	kW	0.92 x 1	0.92 x 2	0.92 x 2			
*3 External static press.	0 Pa (0 mmH ₂ O)		0 Pa (0 mmH ₂ O)		0 Pa (0 mmH ₂ O)			
Compressor	Type x Quantity	Inverter scroll hermetic compressor		Inverter scroll hermetic compressor		Inverter scroll hermetic compressor		
	Manufacture	AC&R Works, MITSUBISHI ELECTRIC CORPORATION		AC&R Works, MITSUBISHI ELECTRIC CORPORATION		AC&R Works, MITSUBISHI ELECTRIC CORPORATION		
	Starting method	Inverter		Inverter		Inverter		
	Motor output	kW	10.5	12.4	12.4			
	Case heater	kW	-	0.045	0.045			
	Lubricant	MEL32		MEL32		MEL32		
External finish	Pre-coated galvanized steel sheets (+powder coating for -BS type) <MUNSELL 5Y 8/1 or similar>		Pre-coated galvanized steel sheets (+powder coating for -BS type) <MUNSELL 5Y 8/1 or similar>		Pre-coated galvanized steel sheets (+powder coating for -BS type) <MUNSELL 5Y 8/1 or similar>			
External dimension H x W x D	mm	1,710 (1,650 without legs) x 1,220 x 740		1,710 (1,650 without legs) x 1,750 x 740		1,710 (1,650 without legs) x 1,750 x 740		
		in.		67-3/8 (65 without legs) x 48-1/16 x 29-3/16		67-3/8 (65 without legs) x 68-15/16 x 29-3/16		
Protection devices	High pressure protection		High pressure sensor, High pressure switch at 4.15 MPa (601 psi)		High pressure sensor, High pressure switch at 4.15 MPa (601 psi)		High pressure sensor, High pressure switch at 4.15 MPa (601 psi)	
	Inverter circuit (COMP./FAN)		Over-heat protection, Over-current protection		Over-heat protection, Over-current protection		Over-heat protection, Over-current protection	
	Compressor		-		-		-	
	Fan motor		-		-		-	
Refrigerant	Type x original charge		R410A x 11.5 kg (26 lbs)		R410A x 11.8 kg (27 lbs)		R410A x 11.8 kg (27 lbs)	
	Control		LEV and HIC circuit					
Net weight	kg (lbs)	251 (554)		304 (671)		304 (671)		
Heat exchanger	Salt-resistant cross fin & copper tube		Salt-resistant cross fin & copper tube		Salt-resistant cross fin & copper tube		Salt-resistant cross fin & copper tube	
HIC circuit (HIC: Heat Inter-Changer)								
Pipe between unit and distributor	Liquid pipe	mm (in.)	12.7 (1/2) Brazed		15.88 (5/8) Brazed		15.88 (5/8) Brazed	
	Gas pipe	mm (in.)	28.58 (1-1/8) Brazed		28.58 (1-1/8) Brazed		28.58 (1-1/8) Brazed	
Defrosting method	Auto-defrost mode (Reversed refrigerant cycle, Hot gas)							
Drawing	External		KJ94T007					
	Wiring		KE94G038		KE94C967		KE94C967	
Standard attachment	Document		Installation Manual					
	Accessory		Refrigerant conn. pipe					
Optional parts	Outdoor Twinning kit: CMY-Y300VBK3 Joint: CMY-Y102SS/LS-G2, CMY-Y202/302S-G2 Header: CMY-Y104/108/1010-G							
Remarks	Details on foundation work, duct work, insulation work, electrical wiring, power source switch, and other items shall be referred to the Installation Manual. Due to continuing improvement, above specifications may be subject to change without notice.							

Notes:

- Nominal cooling conditions (subject to JIS B8615-2)
Indoor: 27°C D.B./19°C W.B. (81°F D.B./66°F W.B.), Outdoor: 35°C D.B./24°C W.B. (95°F D.B./75°F W.B.)
Pipe length: 7.5 m (24-9/16 ft.), Level difference: 0 m (0 ft.)
- Nominal heating conditions (subject to JIS B8615-2)
Indoor: 20°C D.B. (68°F D.B.), Outdoor: 7°C D.B./6°C W.B. (45°F D.B./43°F W.B.)
Pipe length: 7.5 m (24-9/16 ft.), Level difference: 0 m (0 ft.)
- External static pressure option is available (30Pa, 60Pa/3.1mmH₂O, 6.1mmH₂O).

Unit converter	
BTU/h	=kW x 3,412
cfm	=m ³ /min x 35.31
lbs	=kg/0.4536
*Above specification data is subject to rounding variation.	

1. SPECIFICATIONS

YKB/YLM

Model			PUHY-P1300YSKB-A1 (-BS)	
Power source			3-phase 4-wire 380-400-415 V 50/60 Hz	
Cooling capacity (Nominal)	*1	kW	146.0	
		kcal/h	125,600	
		BTU/h	498,200	
	Power input	kW	47.80	
		Current input	A	80.6-76.6-73.8
EER	kW/kW	3.05		
Temp. range of cooling	Indoor	W.B.	15.0~24.0°C (59~75°F)	
	Outdoor	D.B.	-5.0~52.0°C (23~126°F)	
Heating capacity (Nominal)	*2	kW	163.0	
		kcal/h	140,200	
		BTU/h	556,200	
	Power input	kW	46.04	
		Current input	A	77.7-73.8-71.1
COP	kW/kW	3.54		
Temp. range of heating	Indoor	D.B.	15.0~27.0°C (59~81°F)	
	Outdoor	W.B.	-20.0~15.5°C (-4~60°F)	
Indoor unit connectable	Total capacity		50~130% of outdoor unit capacity	
	Model/Quantity		P15~P250/2~50	
Sound pressure level (measured in anechoic room)	dB <A>		70	
Sound power level (measured in anechoic room)	dB <A>		89.5	
Refrigerant piping diameter	Liquid pipe	mm (in.)	19.05 (3/4) Brazed	
	Gas pipe	mm (in.)	41.28 (1-5/8) Brazed	

Set Model

Model			PUHY-P400YKB-A1 (-BS)	PUHY-P450YKB-A1 (-BS)	PUHY-P450YKB-A1 (-BS)
FAN	Type x Quantity		Propeller fan x 1	Propeller fan x 2	Propeller fan x 2
	Air flow rate	m ³ /min	210	360	360
		L/s	3,500	6,000	6,000
		cfm	7,415	12,712	12,712
	Control, Driving mechanism		Inverter-control, Direct-driven by motor	Inverter-control, Direct-driven by motor	Inverter-control, Direct-driven by motor
	Motor output	kW	0.92 x 1	0.92 x 2	0.92 x 2
*3 External static press.		0 Pa (0 mmH ₂ O)	0 Pa (0 mmH ₂ O)	0 Pa (0 mmH ₂ O)	
Compressor	Type x Quantity		Inverter scroll hermetic compressor	Inverter scroll hermetic compressor	Inverter scroll hermetic compressor
	Manufacture		AC&R Works, MITSUBISHI ELECTRIC CORPORATION	AC&R Works, MITSUBISHI ELECTRIC CORPORATION	AC&R Works, MITSUBISHI ELECTRIC CORPORATION
	Starting method		Inverter	Inverter	Inverter
	Motor output	kW	10.8	12.4	12.4
	Case heater	kW	-	0.045	0.045
	Lubricant		MEL32	MEL32	MEL32
External finish			Pre-coated galvanized steel sheets (+powder coating for -BS type) <MUNSELL 5Y 8/1 or similar>	Pre-coated galvanized steel sheets (+powder coating for -BS type) <MUNSELL 5Y 8/1 or similar>	Pre-coated galvanized steel sheets (+powder coating for -BS type) <MUNSELL 5Y 8/1 or similar>
External dimension H x W x D		mm	1,710 (1,650 without legs) x 1,220 x 740	1,710 (1,650 without legs) x 1,750 x 740	1,710 (1,650 without legs) x 1,750 x 740
		in.	67-3/8 (65 without legs) x 48-1/16 x 29-3/16	67-3/8 (65 without legs) x 68-15/16 x 29-3/16	67-3/8 (65 without legs) x 68-15/16 x 29-3/16
Protection devices	High pressure protection		High pressure sensor, High pressure switch at 4.15 MPa (601 psi)	High pressure sensor, High pressure switch at 4.15 MPa (601 psi)	High pressure sensor, High pressure switch at 4.15 MPa (601 psi)
	Inverter circuit (COMP./FAN)		Over-heat protection, Over-current protection	Over-heat protection, Over-current protection	Over-heat protection, Over-current protection
	Compressor		-	-	-
	Fan motor		-	-	-
Refrigerant	Type x original charge		R410A x 11.5 kg (26 lbs)	R410A x 11.8 kg (27 lbs)	R410A x 11.8 kg (27 lbs)
	Control		LEV and HIC circuit		
Net weight		kg (lbs)	251 (554)	304 (671)	304 (671)
Heat exchanger			Salt-resistant cross fin & copper tube	Salt-resistant cross fin & copper tube	Salt-resistant cross fin & copper tube
HIC circuit (HIC: Heat Inter-Changer)			Copper pipe, tube-in-tube structure	Copper pipe, tube-in-tube structure	Copper pipe, tube-in-tube structure
Pipe between unit and distributor	Liquid pipe	mm (in.)	15.88 (5/8) Brazed	15.88 (5/8) Brazed	15.88 (5/8) Brazed
	Gas pipe	mm (in.)	28.58 (1-1/8) Brazed	28.58 (1-1/8) Brazed	28.58 (1-1/8) Brazed
Defrosting method			Auto-defrost mode (Reversed refrigerant cycle, Hot gas)		
Drawing	External		KJ94T007		
	Wiring		KE94G038	KE94C967	KE94C967
Standard attachment	Document		Installation Manual		
	Accessory		Refrigerant conn. pipe		
Optional parts			Outdoor Twinning kit: CMY-Y300VBK3 Joint: CMY-Y102SS/LS-G2, CMY-Y202/302S-G2 Header: CMY-Y104/108/1010-G		
Remarks			Details on foundation work, duct work, insulation work, electrical wiring, power source switch, and other items shall be referred to the Installation Manual. Due to continuing improvement, above specifications may be subject to change without notice.		

Notes:

- Nominal cooling conditions (subject to JIS B8615-2)
Indoor: 27°C D.B./19°C W.B. (81°F D.B./66°F W.B.), Outdoor: 35°C D.B./24°C W.B. (95°F D.B./75°F W.B.)
Pipe length: 7.5 m (24-9/16 ft.), Level difference: 0 m (0 ft.)
- Nominal heating conditions (subject to JIS B8615-2)
Indoor: 20°C D.B. (68°F D.B.), Outdoor: 7°C D.B./6°C W.B. (45°F D.B./43°F W.B.)
Pipe length: 7.5 m (24-9/16 ft.), Level difference: 0 m (0 ft.)
- External static pressure option is available (30Pa, 60Pa/3.1mmH₂O, 6.1mmH₂O).

Unit converter

BTU/h =kW x 3,412
cfm =m³/min x 35.31
lbs =kg/0.4536

*Above specification data is subject to rounding variation.

1. SPECIFICATIONS

Model		PUHY-P1350YSKB-A1 (-BS)	
Power source		3-phase 4-wire 380-400-415 V 50/60 Hz	
Cooling capacity (Nominal)	*1 kW	150.0	
	kcal/h	129,000	
	*1 BTU/h	511,800	
	Power input kW	47.40	
	Current input A	80.0-76.0-73.2	
Temp. range of cooling	EER kW/kW	3.16	
	Indoor W.B.	15.0~24.0°C (59~75°F)	
	Outdoor D.B.	-5.0~52.0°C (23~126°F)	
Heating capacity (Nominal)	*2 kW	168.0	
	kcal/h	144,500	
	*2 BTU/h	573,200	
	Power input kW	49.12	
	Current input A	82.9-78.7-75.9	
Temp. range of heating	COP kW/kW	3.42	
	Indoor D.B.	15.0~27.0°C (59~81°F)	
	Outdoor W.B.	-20.0~15.5°C (-4~60°F)	
Indoor unit connectable	Total capacity	50~130% of outdoor unit capacity	
	Model/Quantity	P15~P250/2~50	
Sound pressure level (measured in anechoic room)	dB <A>	71	
Sound power level (measured in anechoic room)	dB <A>	90	
Refrigerant piping diameter	Liquid pipe mm (in.)	19.05 (3/4) Brazed	
	Gas pipe mm (in.)	41.28 (1-5/8) Brazed	

Set Model

Model		PUHY-P450YKB-A1 (-BS)		PUHY-P450YKB-A1 (-BS)		PUHY-P450YKB-A1 (-BS)		
FAN	Type x Quantity	Propeller fan x 2		Propeller fan x 2		Propeller fan x 2		
	Air flow rate	m ³ /min	360		360		360	
		L/s	6,000		6,000		6,000	
		cfm	12,712		12,712		12,712	
	Control, Driving mechanism	Inverter-control, Direct-driven by motor		Inverter-control, Direct-driven by motor		Inverter-control, Direct-driven by motor		
	*3 Motor output kW	0.92 x 2		0.92 x 2		0.92 x 2		
External static press.	0 Pa (0 mmH ₂ O)		0 Pa (0 mmH ₂ O)		0 Pa (0 mmH ₂ O)			
Compressor	Type x Quantity	Inverter scroll hermetic compressor		Inverter scroll hermetic compressor		Inverter scroll hermetic compressor		
	Manufacture	AC&R Works, MITSUBISHI ELECTRIC CORPORATION		AC&R Works, MITSUBISHI ELECTRIC CORPORATION		AC&R Works, MITSUBISHI ELECTRIC CORPORATION		
	Starting method	Inverter		Inverter		Inverter		
	Motor output kW	12.4		12.4		12.4		
	Case heater kW	0.045		0.045		0.045		
	Lubricant	MEL32		MEL32		MEL32		
External finish	Pre-coated galvanized steel sheets (+powder coating for -BS type) <MUNSELL 5Y 8/1 or similar>		Pre-coated galvanized steel sheets (+powder coating for -BS type) <MUNSELL 5Y 8/1 or similar>		Pre-coated galvanized steel sheets (+powder coating for -BS type) <MUNSELL 5Y 8/1 or similar>			
External dimension H x W x D	mm	1,710 (1,650 without legs) x 1,750 x 740		1,710 (1,650 without legs) x 1,750 x 740		1,710 (1,650 without legs) x 1,750 x 740		
	in.	67-3/8 (65 without legs) x 68-15/16 x 29-3/16		67-3/8 (65 without legs) x 68-15/16 x 29-3/16		67-3/8 (65 without legs) x 68-15/16 x 29-3/16		
Protection devices	High pressure protection	High pressure sensor, High pressure switch at 4.15 MPa (601 psi)		High pressure sensor, High pressure switch at 4.15 MPa (601 psi)		High pressure sensor, High pressure switch at 4.15 MPa (601 psi)		
	Inverter circuit (COMP./FAN)	Over-heat protection, Over-current protection		Over-heat protection, Over-current protection		Over-heat protection, Over-current protection		
	Compressor	-		-		-		
	Fan motor	-		-		-		
Refrigerant	Type x original charge	R410A x 11.8 kg (27 lbs)		R410A x 11.8 kg (27 lbs)		R410A x 11.8 kg (27 lbs)		
	Control	LEV and HIC circuit		LEV and HIC circuit		LEV and HIC circuit		
Net weight	kg (lbs)	304 (671)		304 (671)		304 (671)		
Heat exchanger	Salt-resistant cross fin & copper tube		Salt-resistant cross fin & copper tube		Salt-resistant cross fin & copper tube			
HIC circuit (HIC: Heat Inter-Changer)	Copper pipe, tube-in-tube structure		Copper pipe, tube-in-tube structure		Copper pipe, tube-in-tube structure			
Pipe between unit and distributor	Liquid pipe mm (in.)	15.88 (5/8) Brazed		15.88 (5/8) Brazed		15.88 (5/8) Brazed		
	Gas pipe mm (in.)	28.58 (1-1/8) Brazed		28.58 (1-1/8) Brazed		28.58 (1-1/8) Brazed		
Defrosting method	Auto-defrost mode (Reversed refrigerant cycle, Hot gas)		Auto-defrost mode (Reversed refrigerant cycle, Hot gas)		Auto-defrost mode (Reversed refrigerant cycle, Hot gas)			
Drawing	External	KJ94T008		KJ94T008		KJ94T008		
	Wiring	KE94C967		KE94C967		KE94C967		
Standard attachment	Document	Installation Manual		Installation Manual		Installation Manual		
	Accessory	Refrigerant conn. pipe		Refrigerant conn. pipe		Refrigerant conn. pipe		
Optional parts	Outdoor Twinning kit: CMY-Y300VBK3 Joint: CMY-Y102SS/LS-G2, CMY-Y202/302S-G2 Header: CMY-Y104/108/1010-G		Outdoor Twinning kit: CMY-Y300VBK3 Joint: CMY-Y102SS/LS-G2, CMY-Y202/302S-G2 Header: CMY-Y104/108/1010-G		Outdoor Twinning kit: CMY-Y300VBK3 Joint: CMY-Y102SS/LS-G2, CMY-Y202/302S-G2 Header: CMY-Y104/108/1010-G			
Remarks	Details on foundation work, duct work, insulation work, electrical wiring, power source switch, and other items shall be referred to the Installation Manual. Due to continuing improvement, above specifications may be subject to change without notice.		Details on foundation work, duct work, insulation work, electrical wiring, power source switch, and other items shall be referred to the Installation Manual. Due to continuing improvement, above specifications may be subject to change without notice.		Details on foundation work, duct work, insulation work, electrical wiring, power source switch, and other items shall be referred to the Installation Manual. Due to continuing improvement, above specifications may be subject to change without notice.			

Notes:

- Nominal cooling conditions (subject to JIS B8615-2)
Indoor: 27°C D.B./19°C W.B. (81°F D.B./66°F W.B.), Outdoor: 35°C D.B./24°C W.B. (95°F D.B./75°F W.B.)
Pipe length: 7.5 m (24-9/16 ft.), Level difference: 0 m (0 ft.)
- Nominal heating conditions (subject to JIS B8615-2)
Indoor: 20°C D.B. (68°F D.B.), Outdoor: 7°C D.B./6°C W.B. (45°F D.B./43°F W.B.)
Pipe length: 7.5 m (24-9/16 ft.), Level difference: 0 m (0 ft.)
- External static pressure option is available (30Pa, 60Pa/3.1mmH₂O, 6.1mmH₂O).

Unit converter	
BTU/h	=kW x 3,412
cfm	=m ³ /min x 35.31
lbs	=kg/0.4536
*Above specification data is subject to rounding variation.	

PUHY-P200, 250YKB-A1(-BS)

Unit : mm

- <Accessories>
 • Connecting pipe
 <Gas> · Elbow (ID28.58×OD28.58)····· P200,P250 1pc.
 · Pipe reducer (ID28.58×OD22.2)····· P200,P250 1pc.
 <Liquid> · Pipe (ID9.52×OD9.52)······ P200,P250 1pc.
 · Pipe reducer (ID9.52×OD12.7)······ P250 1pc.

Note 1. Please refer to the next page for information regarding necessary spacing around the unit and foundation work.
 2. At brazing of pipes, wrap the refrigerant service valve with wet cloth and keep the temperature of refrigerant service valve under 120°C.
 3. The detachable leg can be removed at site.

Connecting pipe specifications

Model	Refrigerant pipe *1		Diameter	
	Liquid	Gas	Liquid	Gas
PUHY-P200YKB-A1(-BS)	ø9.52 Brazed	ø22.2 Brazed	ø9.52	ø28.58
PUHY-P250YKB-A1(-BS)	ø9.52 Brazed (ø12.7 Brazed)*2	ø22.2 Brazed	ø9.52	ø28.58

*1 Connect by using the connecting pipes (for bottom piping and front piping) that are supplied.
 *2 Furthest piping length (OU from IU)≥90m

NO.	Usage	Specifications
①	For pipes	Front through hole 102 x 72 Knockout hole
②		Bottom through hole 150 x 94 Knockout hole
③	For wires	Front through hole ø65 or ø40 Knockout hole
④		Front through hole ø52 or ø27 Knockout hole
⑤		Bottom through hole ø65 Knockout hole
⑥	Bottom through hole ø52 Knockout hole	
⑦	For transmission cables	Front through hole ø34 Knockout hole

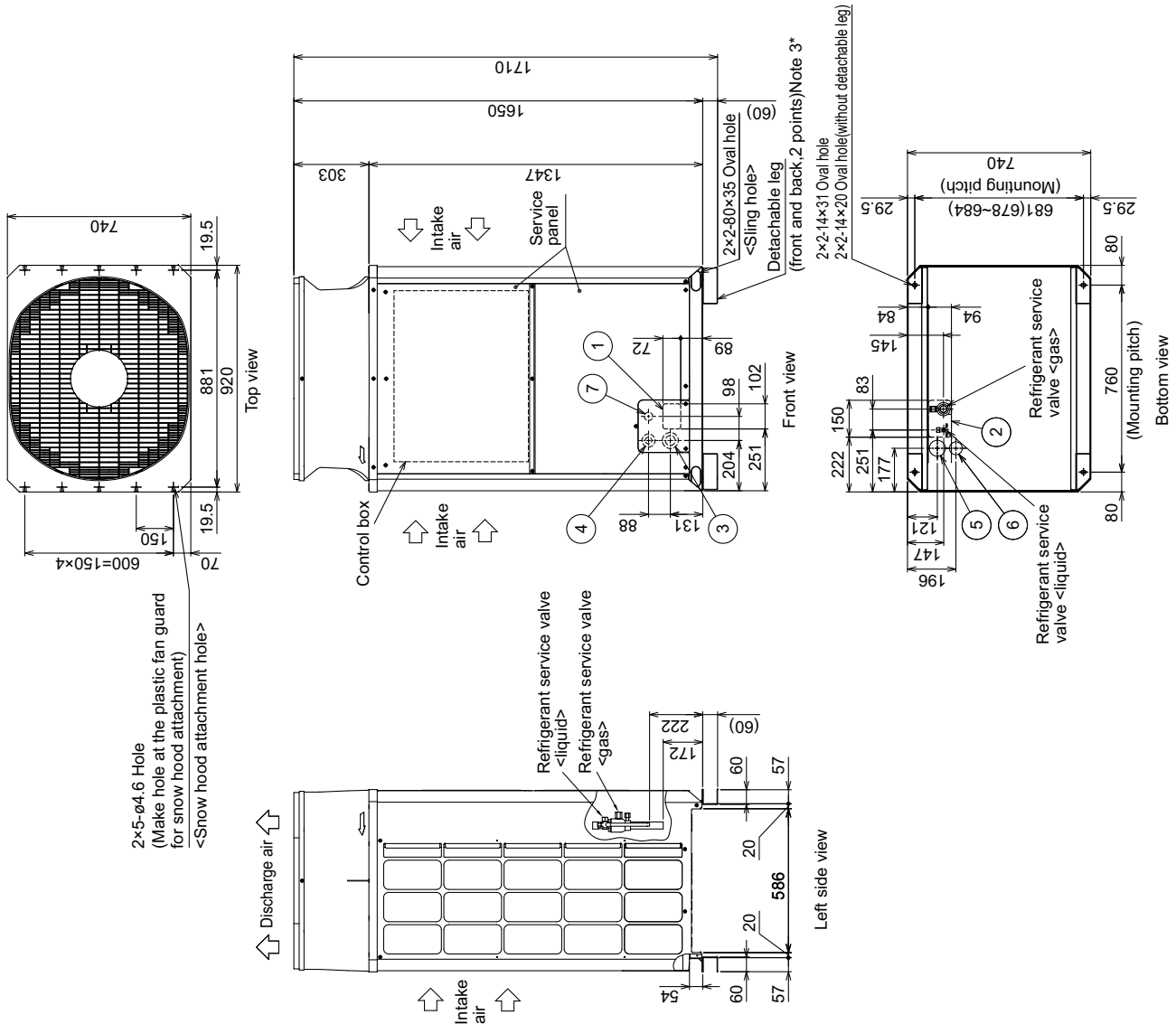

PUHY-P200, 250YKB-A1(-BS)

Unit : mm

1. Required space around the unit

In case of single installation

- ① Secure enough space around the unit as shown in the figure below.
 - With a space of at least 300mm to the wall on the back of the unit

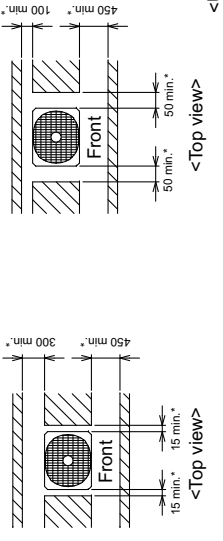

- ② When the height of the walls on the front, back or on the sides <H> exceeds the wall height limit as defined below add the height that exceeds the height limit <h> to the figures that are marked with an asterisk.

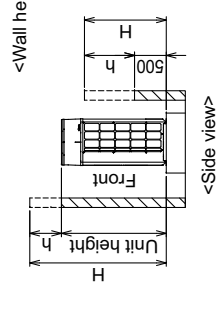

<Wall height limit> Front : Up to the unit height
 Back : Up to 500mm from the unit bottom
 Side : Up to the unit height

In case of collective installation

- ① When multiple units are installed adjacent to each other, secure enough space to allow for air circulation and walkway between groups of units as shown in the figures below.
- ② At least two sides must be left open.
- ③ As with the single installation, add the height that exceeds the height limit <h> to the figures that are marked with an asterisk.
- ④ If there is a wall at both the front and the rear of the unit, install up to six units consecutively in the side direction and provide a space of 1000mm or more as inlet space/ passage space for each six units.

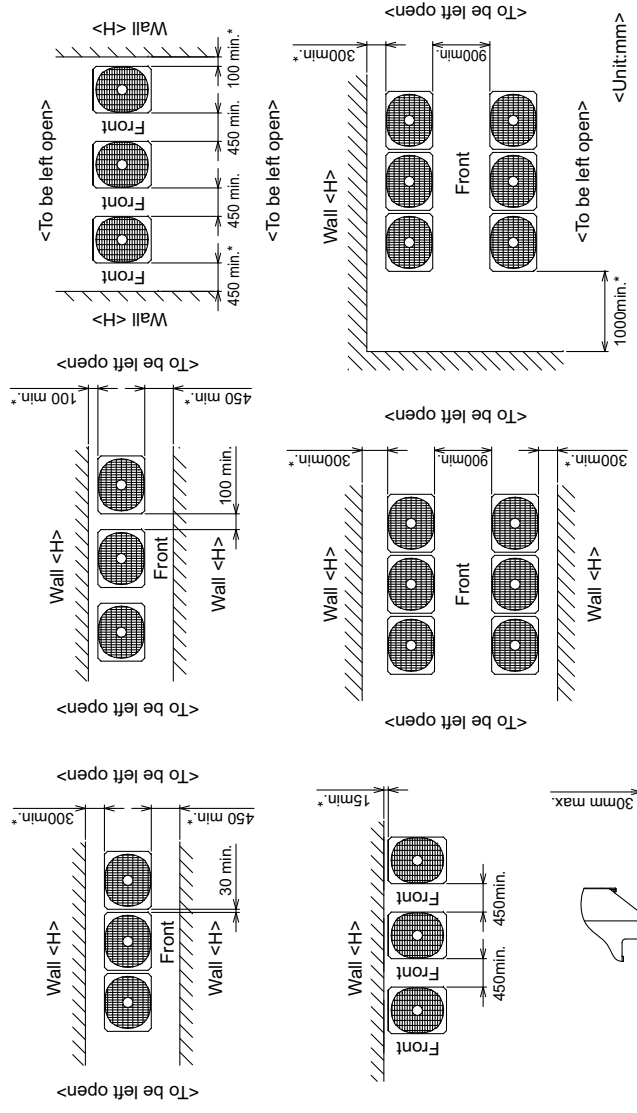

2. Foundation work

- ① Take into consideration the surface strength, water drainage route, piping route, and wiring route when preparing the installation site.
 - Note that the drain water comes out of the unit during operation.
- ② Build the foundation in such way that the corner of the installation leg is securely supported as shown in the right figure. (Fig.A,B)
 - When using a rubber isolating cushion, please ensure it is large enough to cover the entire width of each of the unit's legs.
- ③ The protrusion length of the anchor bolt must not exceed 30mm. (Fig.A,B)
- ④ Use four fixing plates as shown in the right figure <field supply required> when using post-installed anchor bolts. (Fig.C,D)
- ⑤ To prevent small animals and water and snow from entering the unit and damaging its parts, close the gap around the edges of through holes for pipes and wires with filler plates <field supply required>.
- ⑥ When the pipes or cables are routed at the bottom of the unit, make sure that the through hole at the base of the unit does not get blocked with the installation base.
- ⑦ Refer to the Installation Manual when installing units on an installation base.

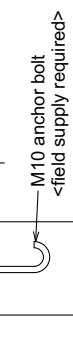

Fig.A (without detachable legs)

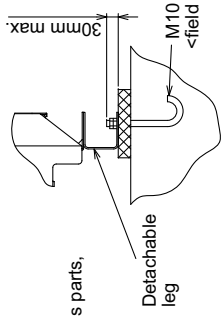

Fig.B (with detachable legs)

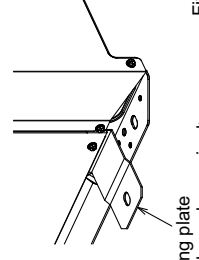

Fig.C (without detachable legs)

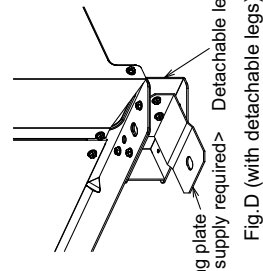

Fig.D (with detachable legs)

PUHY-P300, 350, 400YKB-A1(-BS)

Unit : mm

- <Accessories>
- Connecting pipe (ID28.58×OD28.58) ... P300,P350,P400 1pc.
 - <Gas> •Elbow (ID28.58×OD22.2) ... P300 1pc.
 - Pipe reducer (ID15.88×OD15.88) ... P300,P350,P400 1pc.
 - <Liquid> •Pipe (ID15.88×OD9.52) ... P300 1pc.
 - Pipe reducer (ID15.88×OD12.7) ... P300,P350,P400 1pc.

Note 1. Please refer to the next page for information regarding necessary spacing around the unit and foundation work.

2. At brazing of pipes, wrap the refrigerant service valve with wet cloth and keep the temperature of refrigerant service valve under 120°C.

3. The detachable leg can be removed at site.

Connecting pipe specifications

Model	Refrigerant pipe *1		Diameter	
	Liquid	Gas	Liquid	Gas
PUHY-P300YKB-A1(-BS)	ø9.52 Braze (ø12.7 Braze) *2,*3	ø22.2 Braze	ø15.88	ø28.58
PUHY-P350YKB-A1(-BS)	ø12.7 Braze	ø23.58 Braze	ø15.88	ø28.58
PUHY-P400YKB-A1(-BS)	ø12.7 Braze (ø15.88 Braze) *2	ø23.58 Braze	ø15.88	ø28.58

*1 Connect by using the connecting pipes (for bottom piping and front piping) that are supplied.

*2 Indicates dimensions and connection specifications in the case the unit is used in combination with other outdoor units.

*3 Furthest piping length (OU from IU)≥40m.

NO.	Usage	Specifications
①	For pipes	Front through hole 102 x 72 Knockout hole Bottom through hole 150 x 94 Knockout hole
②	For wires	Front through hole ø65 or ø40 Knockout hole Front through hole ø52 or ø27 Knockout hole Bottom through hole ø65 Knockout hole
③	For transmission cables	Front through hole ø52 Knockout hole Front through hole ø34 Knockout hole

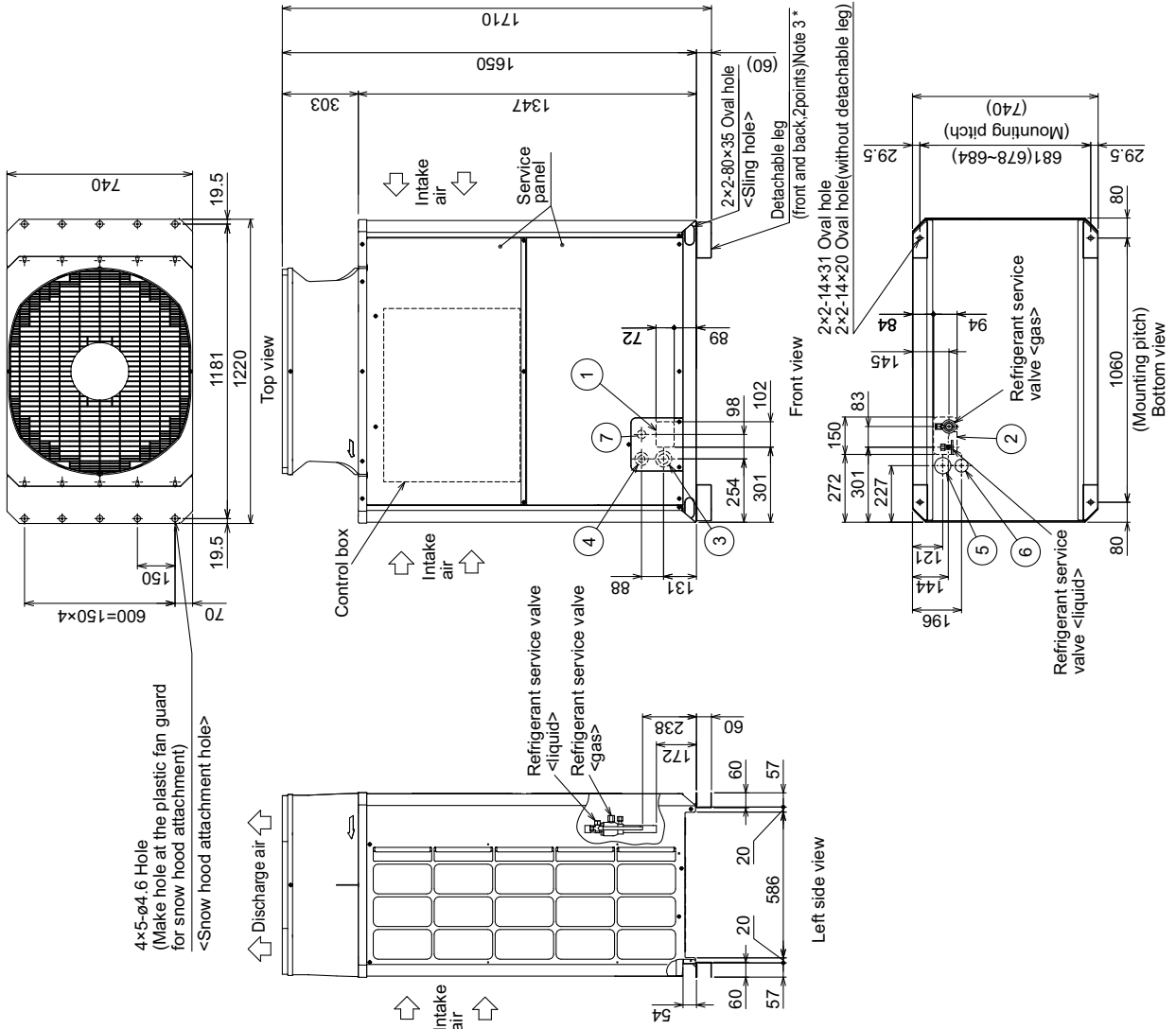

PUHY-P300, 350, 400YKB-A1(-BS)

Unit : mm

1. Required space around the unit

● In case of single installation

- ① Secure enough space around the unit as shown in the figure below.

· With a space of at least 300mm to the wall on the back of the unit

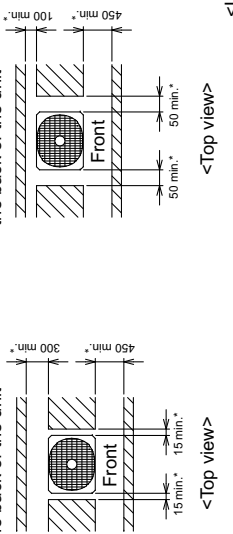

- ② When the height of the walls on the front, back or on the sides <H> exceeds the wall height limit as defined below add the height that exceeds the height limit <h> to the figures that are marked with an asterisk.

<Wall height limit> Front : Up to the unit height
Back : Up to 500mm from the unit bottom
Side : Up to the unit height

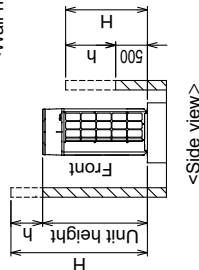

● In case of collective installation

- ① When multiple units are installed adjacent to each other, secure enough space to allow for air circulation and walkway between groups of units as shown in the figures below.
- ② At least two sides must be left open.
- ③ As with the single installation, add the height that exceeds the height limit <h> to the figures that are marked with an asterisk.
- ④ If there is a wall at both the front and the rear of the unit, install up to six units consecutively in the side direction and provide a space of 1000mm or more as inlet space/ passage space for each six units.

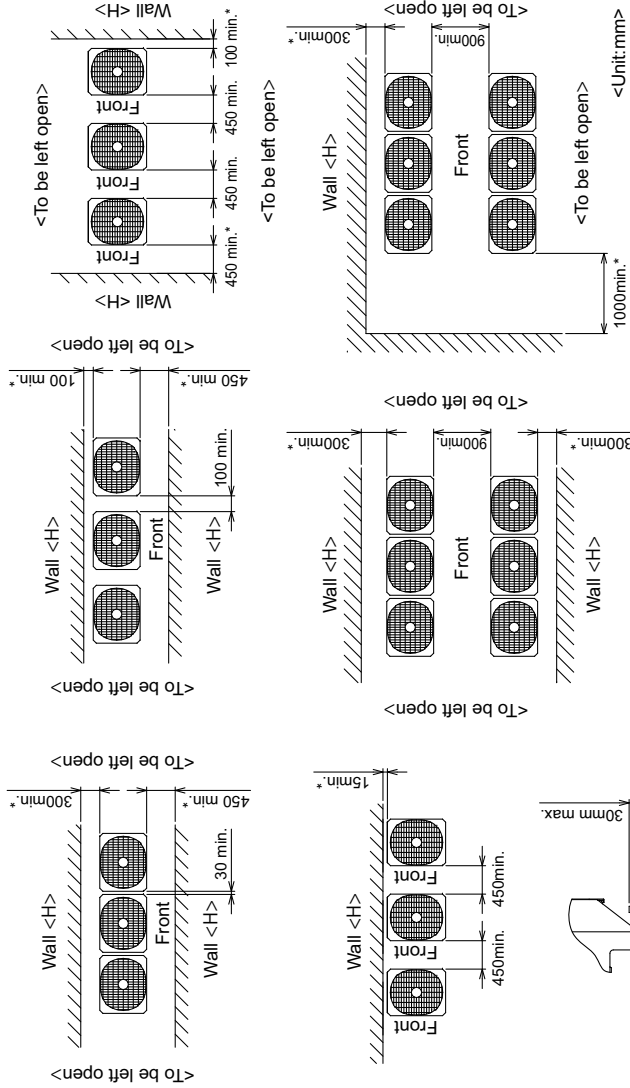

2. Foundation work

- ① Take into consideration the surface strength, water drainage route, piping route and wiring route when preparing the installation site.
<Note that the drain water comes out of the unit during operation.>
- ② Build the foundation in such way that the corner of the installation leg is securely supported as shown in the right figure.(Fig.A,B)
When using a rubber isolating cushion, please ensure it is large enough to cover the entire width of each of the unit's legs.
- ③ The protrusion length of the anchor bolt must not exceed 30mm.(Fig.A,B)
- ④ Use four fixing plates as shown in the right figure <field supply required> when using post-installed anchor bolts.(Fig.C,D)
- ⑤ To prevent small animals and water and snow from entering the unit and damaging its parts, close the gap around the edges of through holes for pipes and wires with filler plates <field supply required>.
- ⑥ When the pipes or cables are routed at the bottom of the unit, make sure that the through hole at the base of the unit does not get blocked with the installation base.
- ⑦ Refer to the Installation Manual when installing units on an installation base.

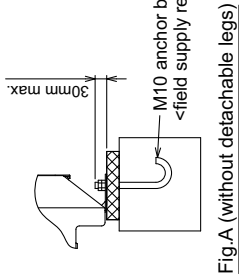

Fig.A (without detachable legs)

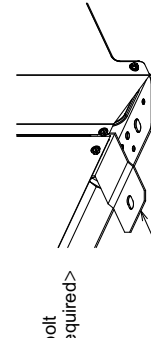

Fig.C (without detachable legs)

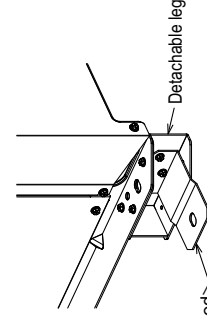

Fig.D (with detachable legs)

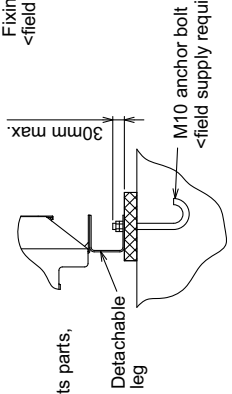

Fig.B (with detachable legs)

PUHY-P450, 500YKB-A1(-BS)

Unit : mm

- <Accessories>
- Connecting pipe (ID28.58×OD28.58).....P450.500 1pc.
 - <Gas> Elbow (ID15.88×OD15.88).....P450.500 1pc.
 - <Liquid> Pipe (ID15.88×OD15.88).....P450.500 1pc.

Note 1. Please refer to the next page for information regarding necessary spacing around the unit and foundation work.

2. At brazing of pipes, wrap the refrigerant service valve with wet cloth and keep the temperature of refrigerant service valve under 120°C.

3. The detachable leg can be removed at site.

Connecting pipe specifications

Model	Refrigerant pipe *1		Service valve	
	Liquid	Gas	Liquid	Gas
PUHY-P450YKB-A1(-BS)	ø15.88 Brazed	ø28.58 Brazed	ø15.88	ø28.58
PUHY-P500YKB-A1(-BS)	ø15.88 Brazed	ø28.58 Brazed	ø15.88	ø28.58

*1 Connect by using the connecting pipes (for bottom piping and front piping) that are supplied.

NO.	Usage	Specifications	
		Front through hole	Bottom through hole
①	For pipes	102 × 72 Knockout hole	150 × 94 Knockout hole
②		150 × 94 Knockout hole	ø65 or ø40 Knockout hole
③		ø65 or ø40 Knockout hole	ø52 or ø27 Knockout hole
④	For wires	ø65 Knockout hole	ø65 Knockout hole
⑤		ø52 Knockout hole	ø52 Knockout hole
⑥		ø34 Knockout hole	ø34 Knockout hole
⑦	For transmission cables	Front through hole	Front through hole

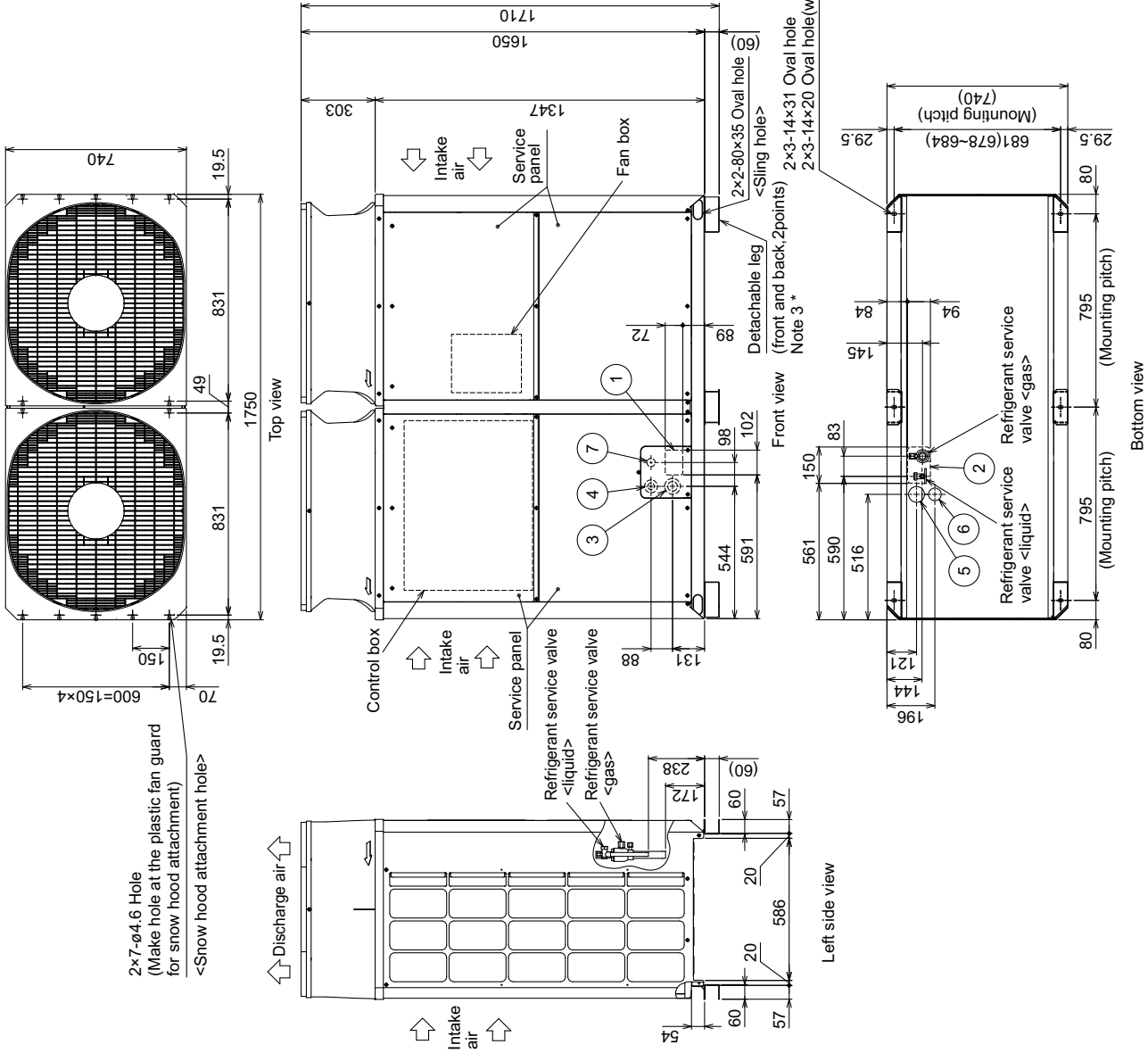

PUHY-P450, 500YKB-A1(-BS)

Unit : mm

1. Required space around the unit

● In case of single installation

- Secure enough space around the unit as shown in the figure below.
 - With a space of at least 100mm to the wall on the back of the unit
- With a space of at least 300mm to the wall on the back of the unit

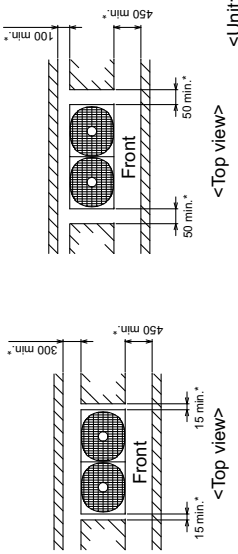

- When the height of the walls on the front, back or on the sides<H> exceeds the wall height limit as defined below add the height that exceeds the height limit <h> to the figures that are marked with an asterisk.

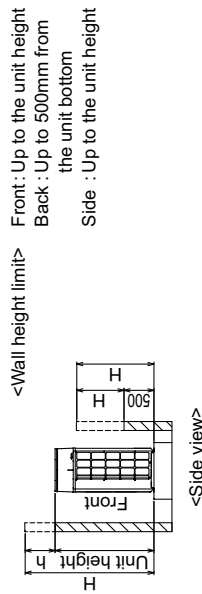

2. Foundation work

- Take into consideration the surface strength, water drainage route, piping route, and wiring route when preparing the installation site.
 - Note that the drain water comes out of the unit during operation. >
- Build the foundation in such way that the corner of the installation leg is securely supported as shown in the right figure.(Fig.A,B)
 - When using a rubber isolating cushion, please ensure it is large enough to cover the entire width of each of the unit's legs.
- The protrusion length of the anchor bolt must not exceed 30mm.(Fig.A,B)
- Use four fixing plates as shown in the right figure <field supply required> when using post-installed anchor bolts.(Fig.C,D)
- To prevent small animals and water and snow from entering the unit and damaging its parts, close the gap around the edges of through holes for pipes and wires with filler plates <field supply required>.
- When the pipes or cables are routed at the bottom of the unit, make sure that the through hole at the base of the unit does not get blocked with the installation base.
- Refer to the Installation Manual when installing units on an installation base.

● In case of collective installation

- When multiple units are installed adjacent to each other, secure enough space to allow for air circulation and walkway between groups of units as shown in the figures below.
- At least two sides must be left open.
- As with the single installation, add the height that exceeds the height limit<h> to the figures that are marked with an asterisk.
- If there is a wall at both the front and the rear of the unit, install up to three units consecutively in the side direction and provide a space of 1000mm or more as inlet space/ passage space for each three units.

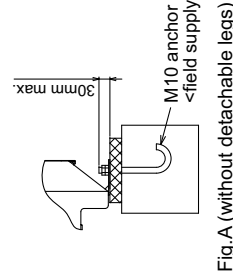
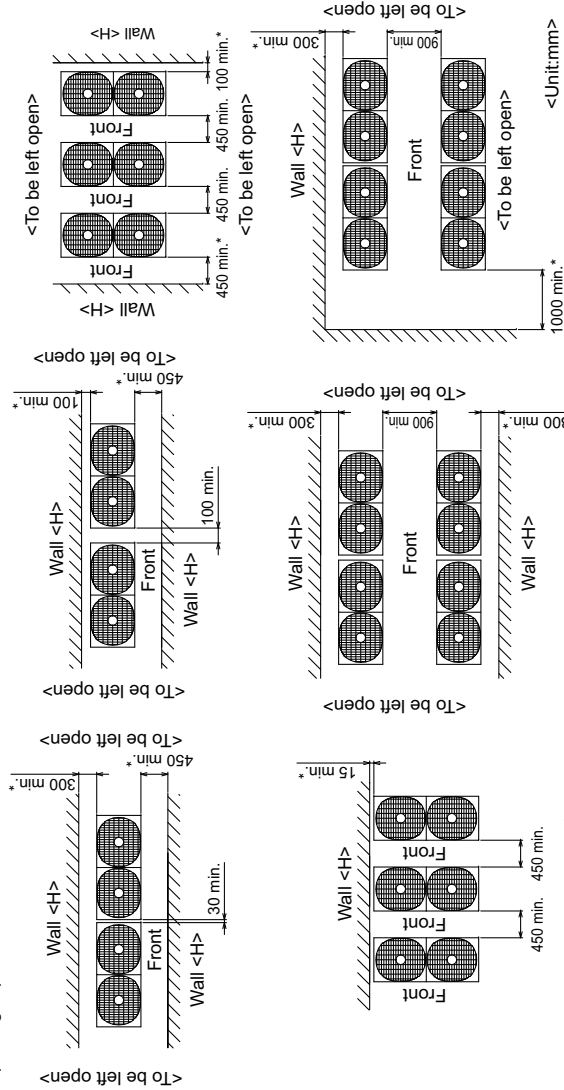

Fig.A (without detachable legs)

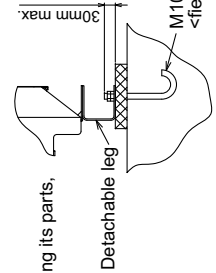

Fig.B (with detachable legs)

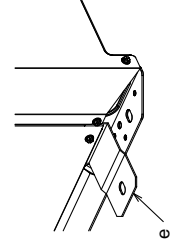

Fig.C (without detachable legs)

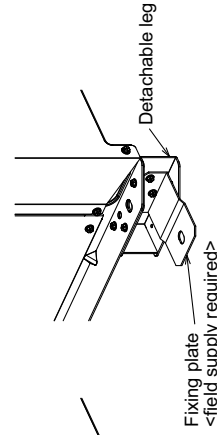
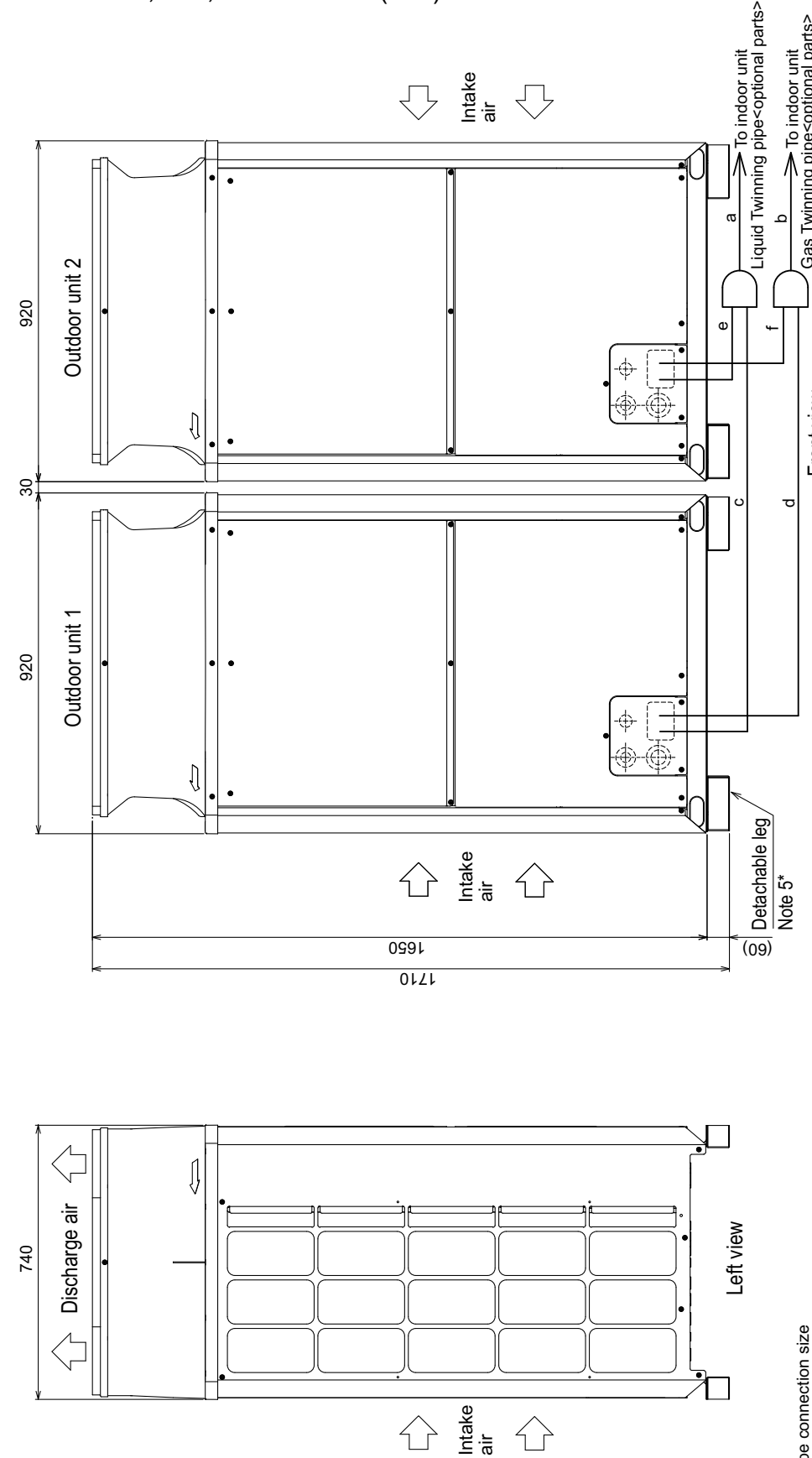

Fig.D (with detachable legs)

PUHY-P400, 450, 500YSKB-A1(-BS)



Twinning pipe~Outdoor unit	Unit model	Liquid	Gas
	P200 P250	c or e ø9.52	d or f ø22.2

Twinning pipe connection size		PUHY-P400YSKB-A1(-BS)	PUHY-P450YSKB-A1(-BS)	PUHY-P500YSKB-A1(-BS)
Package unit name		PUHY-P400YSKB-A1(-BS)	PUHY-P450YSKB-A1(-BS)	PUHY-P500YSKB-A1(-BS)
Component unit name		Outdoor unit 1	Outdoor unit 2	Outdoor unit 1
Outdoor Twinning Kit(optional parts)		PUHY-P200YKB-A1(-BS)	PUHY-P200YKB-A1(-BS)	PUHY-P250YKB-A1(-BS)
Indoor unit~Twinning pipe		CMY-Y100VBK3		
	Liquid	ø12.7		ø15.88
	Gas			ø28.58

- Note 1. Connect the pipes as shown in the figure above. Refer to the table above for the pipe size.
 2. Twinning pipes should not be tilted more than 15 degrees from the horizontal plane.
 Be sure to see the Installation Manual for details of Twinning pipe installation.
 3. The pipe section before the Twinning pipe (sections "a" and "b" in the figure) must have at least 500mm of straight section (*including the straight pipe that is supplied with the Twinning pipe).
 4. Only use the Twinning pipe by Mitsubishi (optional parts).
 5. The detachable leg can be removed at site.

Unit : mm

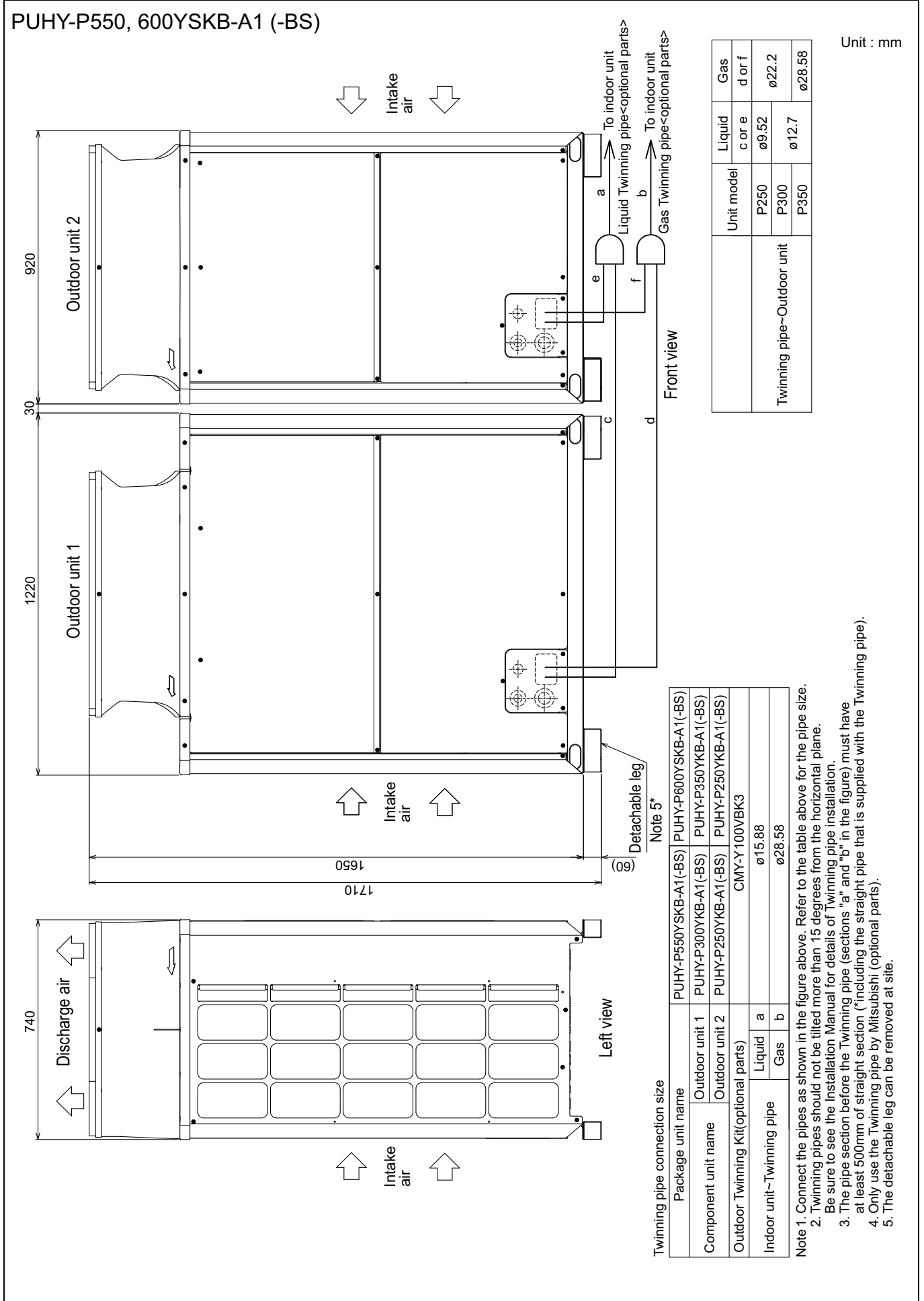

PUHY-P650, 700, 750YSKB-A1(-BS)

Unit : mm

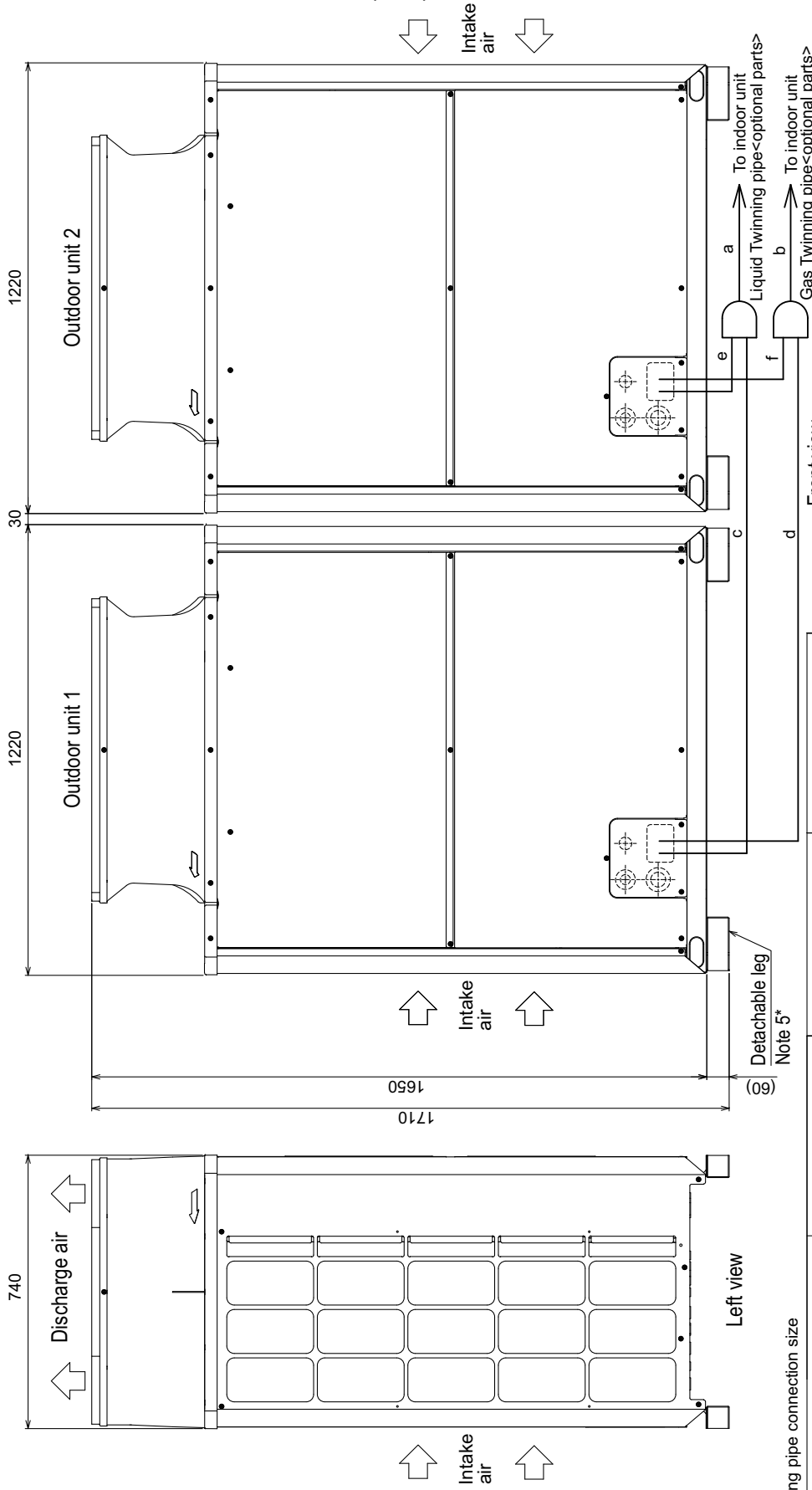

Front view

Twinning pipe~Outdoor unit	Unit model	Liquid	Gas
	P300	c or e	d or f
	P350	ø12.7	ø22.2
	P400	ø15.88	ø28.58

Twinning pipe connection size

Package unit name	PUHY-P650YSKB-A1(-BS)	PUHY-P700YSKB-A1(-BS)	PUHY-P750YSKB-A1(-BS)
Outdoor unit 1	PUHY-P350YKB-A1(-BS)	PUHY-P350YKB-A1(-BS)	PUHY-P400YKB-A1(-BS)
Outdoor unit 2	PUHY-P300YKB-A1(-BS)	PUHY-P350YKB-A1(-BS)	PUHY-P350YKB-A1(-BS)
Outdoor Twinning Kit(optional parts)	CMY-Y100VBK3	CMY-Y200VBK2	
Indoor unit~Twinning pipe	Liquid	a	ø15.88
	Gas	b	ø28.58
			ø19.05
			ø34.93

- Note 1. Connect the pipes as shown in the figure above. Refer to the table above for the pipe size.
 2. Twinning pipes should not be tilted more than 15 degrees from the horizontal plane. Be sure to see the Installation Manual for details of Twinning pipe installation.
 3. The pipe section before the Twinning pipe (sections "a" and "b" in the figure) must have at least 500mm of straight section (*including the straight pipe that is supplied with the Twinning pipe).
 4. Only use the Twinning pipe by Mitsubishi (optional parts).
 5. The detachable leg can be removed at site.

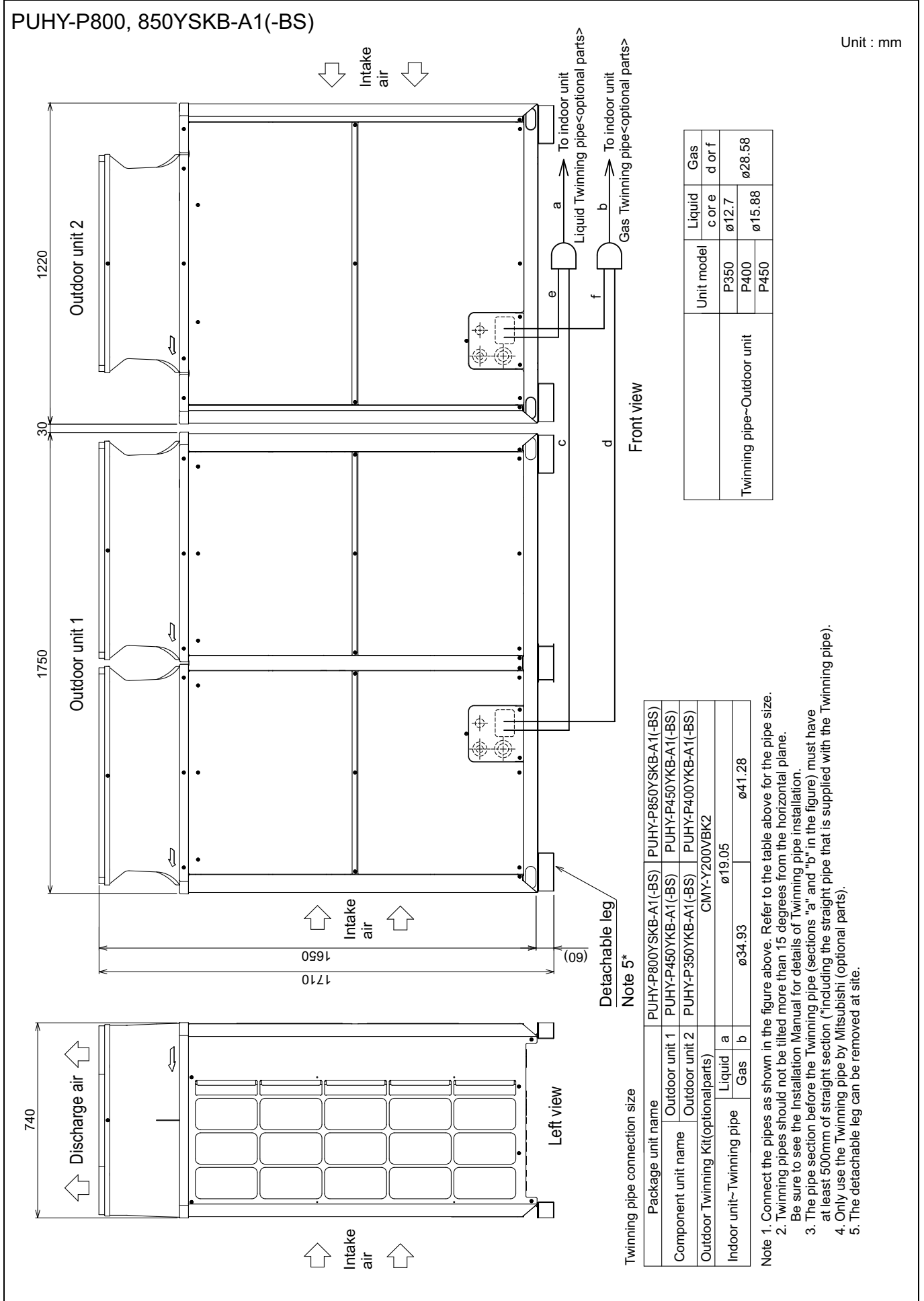

PUHY-P900YSKB-A1(-BS)

Unit : mm

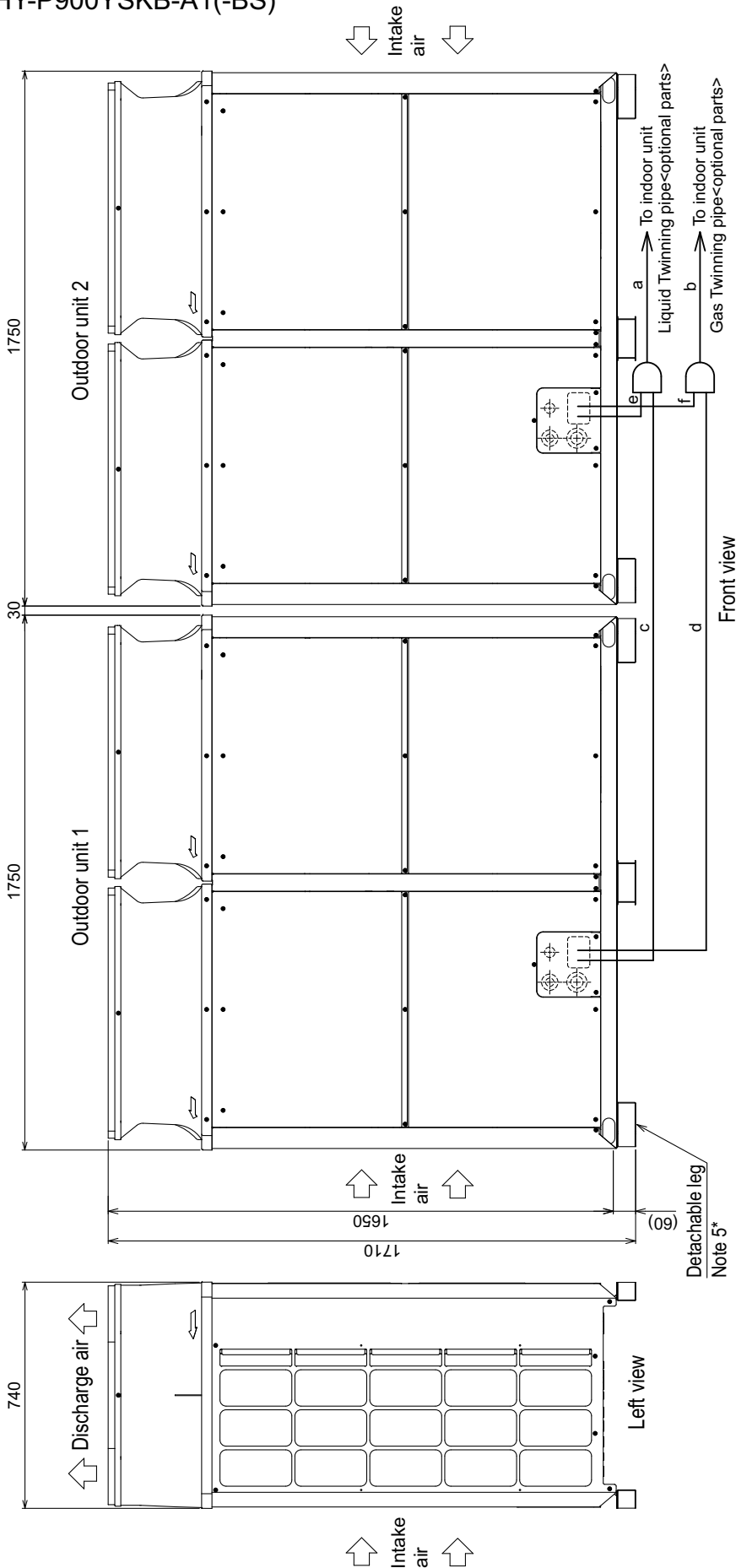

Front view

Left view

Twinning pipe connection size

Package unit name	PUHY-P900YSKB-A1(-BS)
Component unit name	Outdoor unit 1 Outdoor unit 2
Outdoor Twinning Kit(optional parts)	CMY-Y200V/BK2
Indoor unit~Twinning pipe	Liquid Gas
	a b
	ø19.05 ø41.28

	Unit model	Liquid c or e	Gas d or f
Twinning pipe~Outdoor unit	P450	ø15.88	ø28.58

- Note 1. Connect the pipes as shown in the figure above. Refer to the table above for the pipe size.
- Note 2. Twinning pipes should not be tilted more than 15 degrees from the horizontal plane. Be sure to see the Installation Manual for details of Twinning pipe installation.
- Note 3. The pipe section before the Twinning pipe (sections "a" and "b" in the figure) must have at least 500mm of straight section (*including the straight pipe that is supplied with the Twinning pipe).
- Note 4. Only use the Twinning pipe by Mitsubishi (optional parts).
- Note 5. The detachable leg can be removed at site.

Note 5*

Y

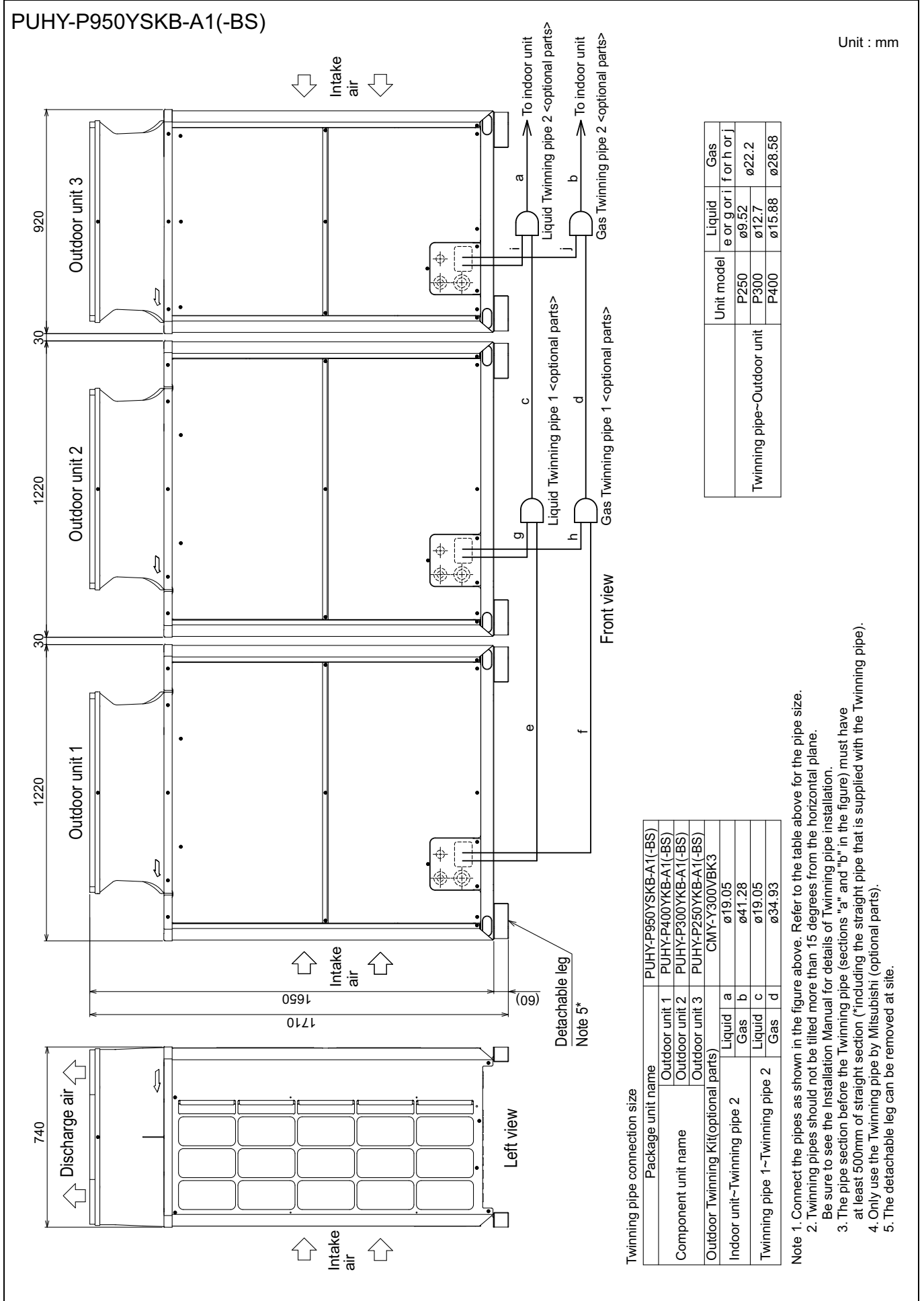

2. EXTERNAL DIMENSIONS

YKB/YLM

PUHY-P1000, 1050, 1100YSKB-A1(-BS)

Unit : mm

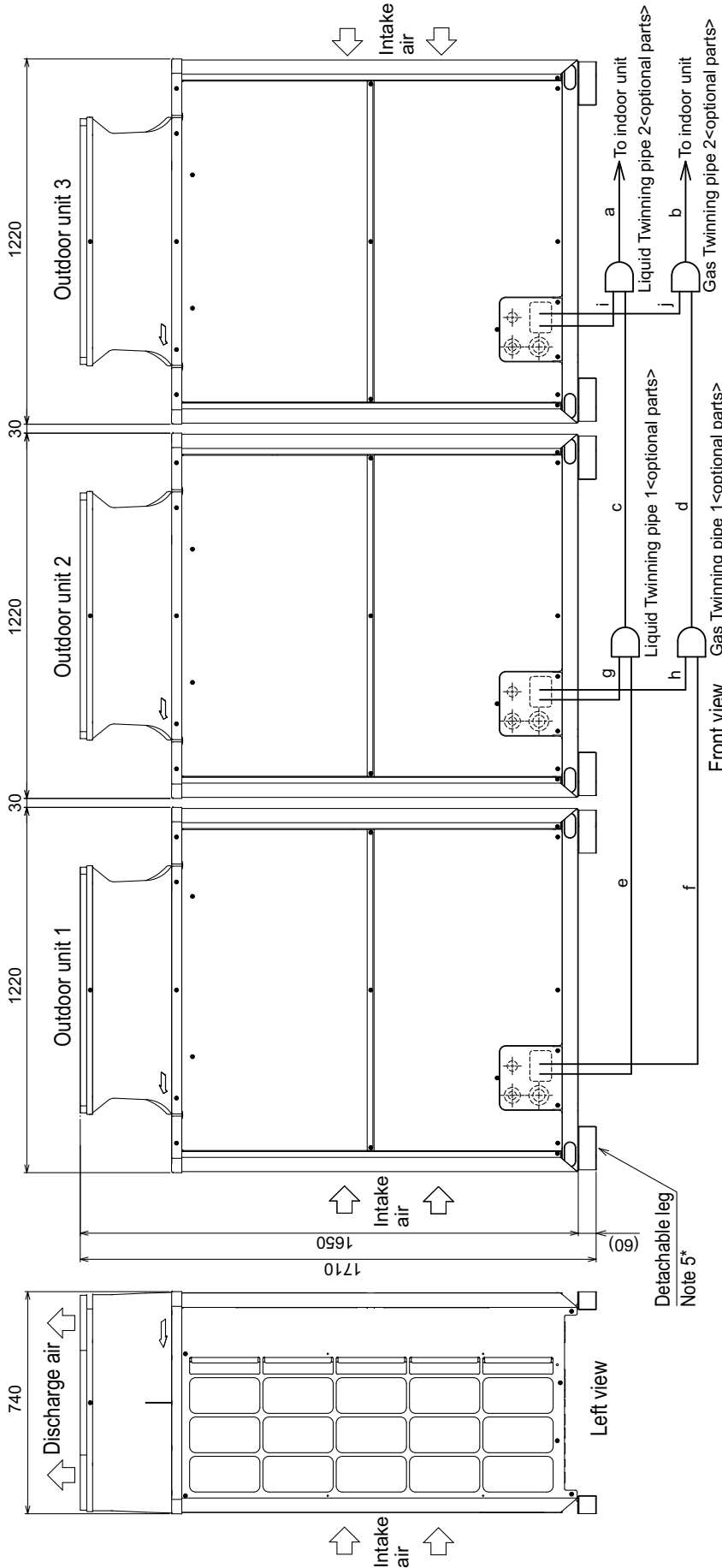

Twinning pipe connection size

Package unit name	PUHY-P1000YSKB-A1(-BS)	PUHY-P1050YSKB-A1(-BS)	PUHY-P1100YSKB-A1(-BS)
Outdoor unit 1	PUHY-P400YKB-A1(-BS)	PUHY-P400YKB-A1(-BS)	PUHY-P400YKB-A1(-BS)
Outdoor unit 2	PUHY-P300YKB-A1(-BS)	PUHY-P350YKB-A1(-BS)	PUHY-P350YKB-A1(-BS)
Outdoor unit 3	PUHY-P300YKB-A1(-BS)	PUHY-P300YKB-A1(-BS)	PUHY-P350YKB-A1(-BS)
Outdoor Twinning Kit(optional parts)	CMY-Y300VBK3		
Indoor unit~ Twinning pipe 2	Liquid	a	ø19.05
	Gas	b	ø41.28
Twinning pipe 1~Twinning pipe 2	Liquid	c	ø19.05
	Gas	d	ø34.93

Unit model	Liquid	Gas
P300	ø12.7	ø22.2
P350		ø28.58
P400	ø15.88	

- Note 1. Connect the pipes as shown in the figure above. Refer to the table above for the pipe size.
 2. Twinning pipes should not be tilted more than 15 degrees from the horizontal plane.
 Be sure to see the Installation Manual for details of Twinning pipe installation.
 3. The pipe section before the Twinning pipe (sections "a" and "b" in the figure) must have at least 500mm of straight section (*including the straight pipe that is supplied with the Twinning pipe).
 4. Only use the Twinning pipe by Mitsubishi (optional parts).
 5. The detachable leg can be removed at site.

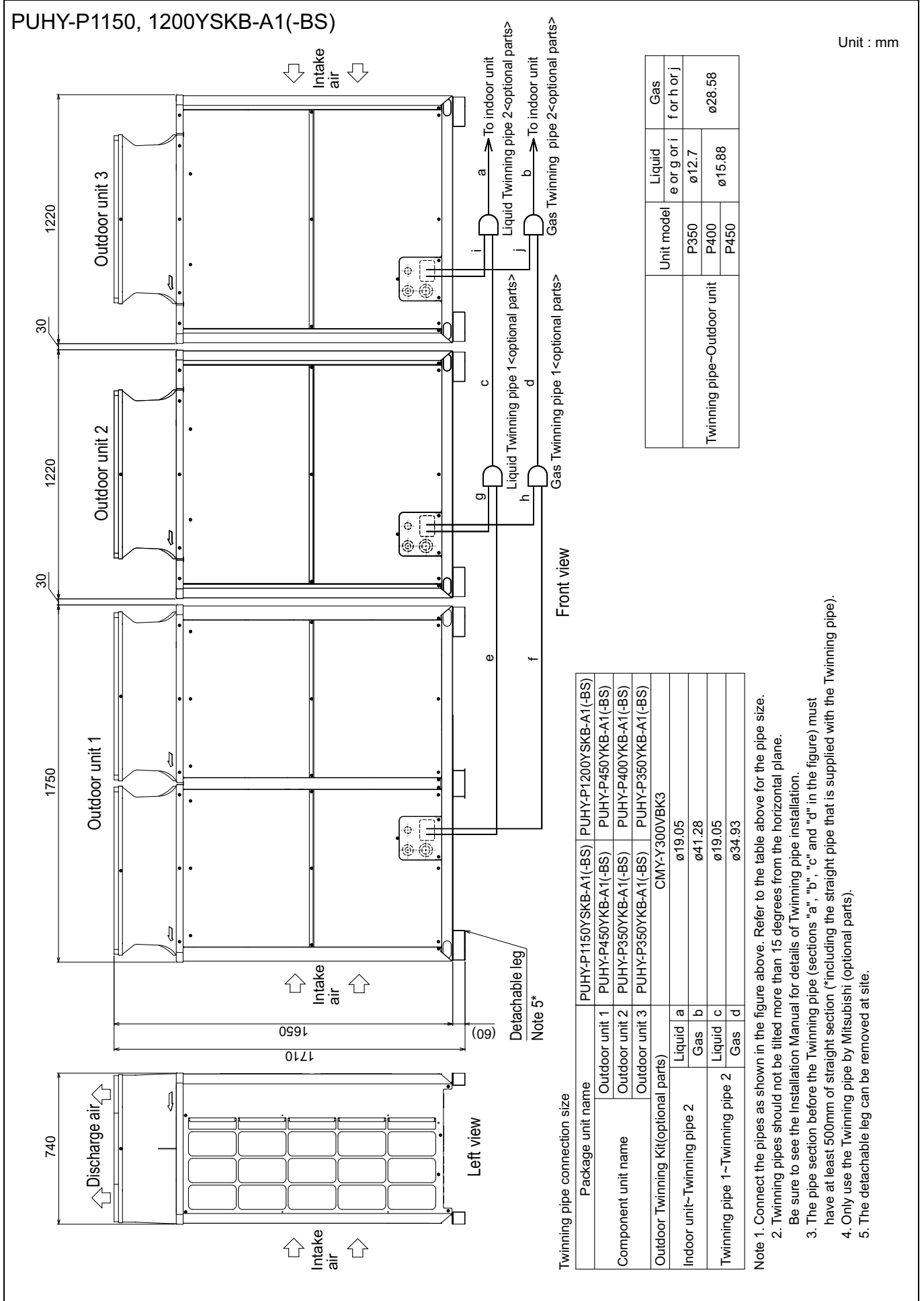

PUHY-P1250, 1300YSKB-A1(-BS)

Unit : mm

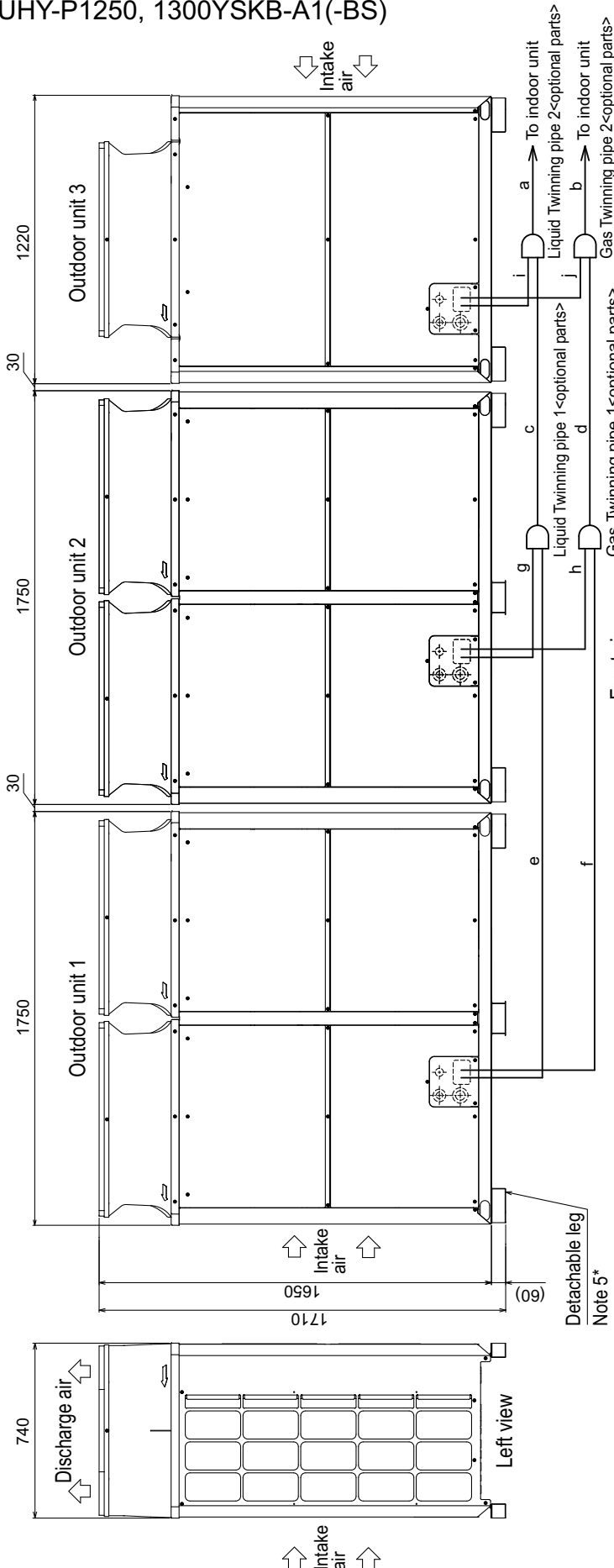

Twinning pipe connection size

Package unit name	PUHY-P1250YSKB-A1(-BS)	PUHY-P1300YSKB-A1(-BS)
Outdoor unit 1	PUHY-P450YKB-A1(-BS)	PUHY-P450YKB-A1(-BS)
Outdoor unit 2	PUHY-P450YKB-A1(-BS)	PUHY-P450YKB-A1(-BS)
Outdoor unit 3	PUHY-P350YKB-A1(-BS)	PUHY-P400YKB-A1(-BS)
Outdoor Twinning Kit(optional parts)	CMY-Y300VBK3	
Indoor unit~Twinning pipe 2	Liquid a	ø19.05
	Gas b	ø41.28
Twinning pipe 1~Twinning pipe 2	Liquid c	ø19.05
	Gas d	ø34.93

Twinning pipe~Outdoor unit	Unit model		Gas for h or j
	P350	P400	
Twinning pipe 1<optional parts>	Liquid e or g or i		ø28.58
	ø12.7		
Twinning pipe 2<optional parts>	Liquid j		ø15.88
	ø15.88		

- Note 1. Connect the pipes as shown in the figure above. Refer to the table above for the pipe size.
- Note 2. Twinning pipes should not be tilted more than 15 degrees from the horizontal plane. Be sure to see the Installation Manual for details of Twinning pipe installation.
- Note 3. The pipe section before the Twinning pipe (sections "a", "b", "c" and "d" in the figure) must have at least 500mm of straight section (*including the straight pipe that is supplied with the Twinning pipe).
- Note 4. Only use the Twinning pipe by Mitsubishi (optional parts).
- Note 5. The detachable leg can be removed at site.

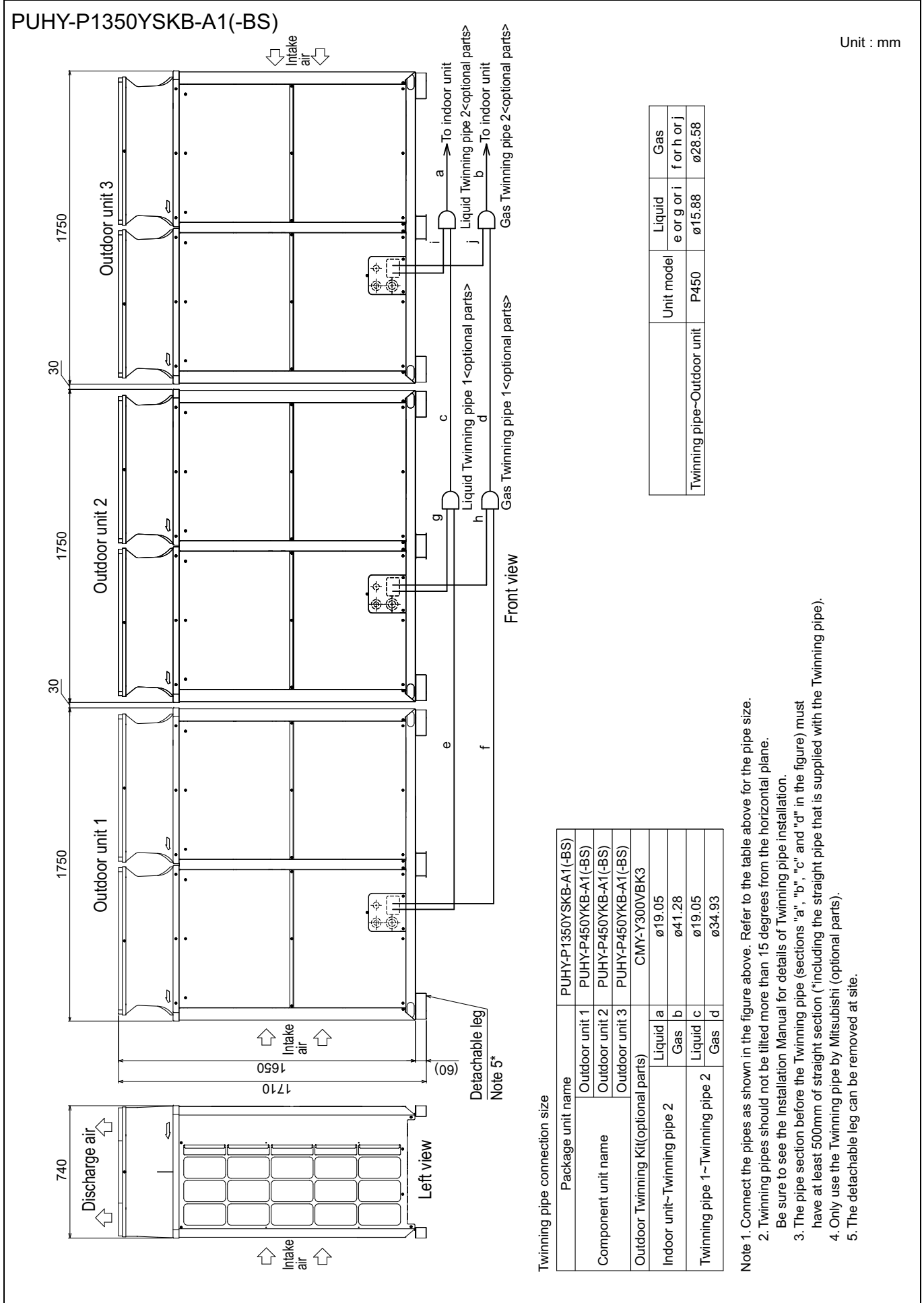

Y

PUHY-P200, 250YKB-A1 (-BS)

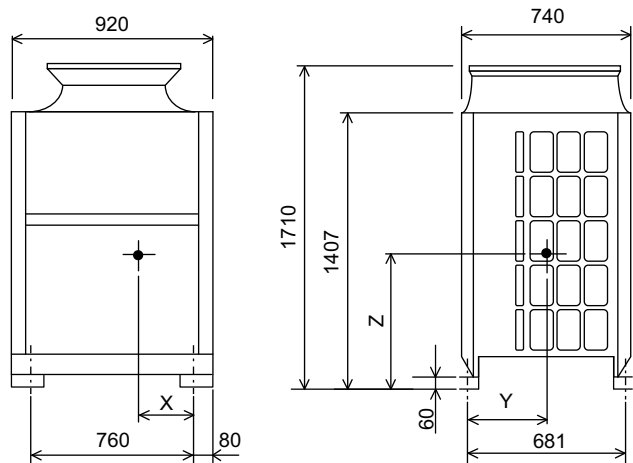

Unit : mm

Model	X	Y	Z
PUHY-P200YKB-A1(-BS)	338	300	667
PUHY-P250YKB-A1(-BS)	338	310	680

PUHY-P300, 350, 400YKB-A1 (-BS)

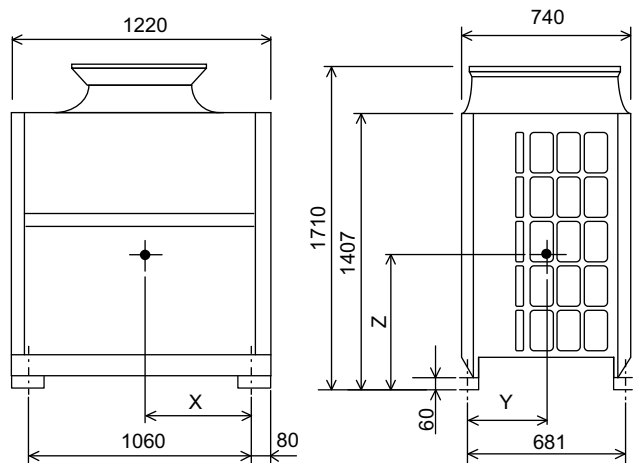

Unit : mm

Model	X	Y	Z
PUHY-P300YKB-A1(-BS)	446	317	636
PUHY-P350YKB-A1(-BS)	446	317	636
PUHY-P400YKB-A1(-BS)	446	317	636

PUHY-P450, 500YKB-A1 (-BS)

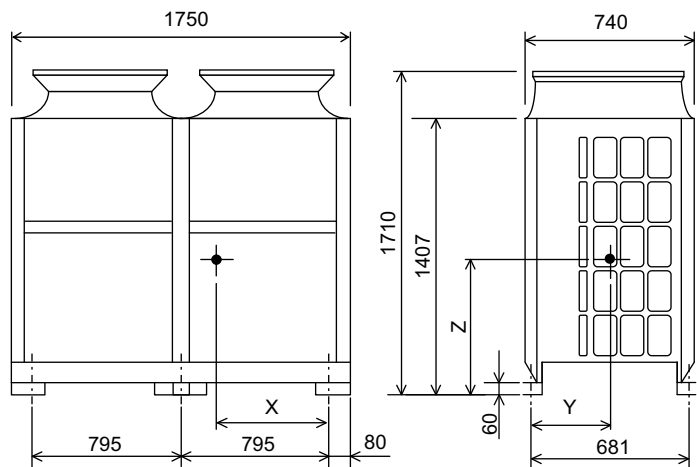

Unit : mm

Model	X	Y	Z
PUHY-P450YKB-A1(-BS)	707	319	718
PUHY-P500YKB-A1(-BS)	707	319	718

PUHY-P200, 250, 300, 350, 400YKB-A1(-BS)

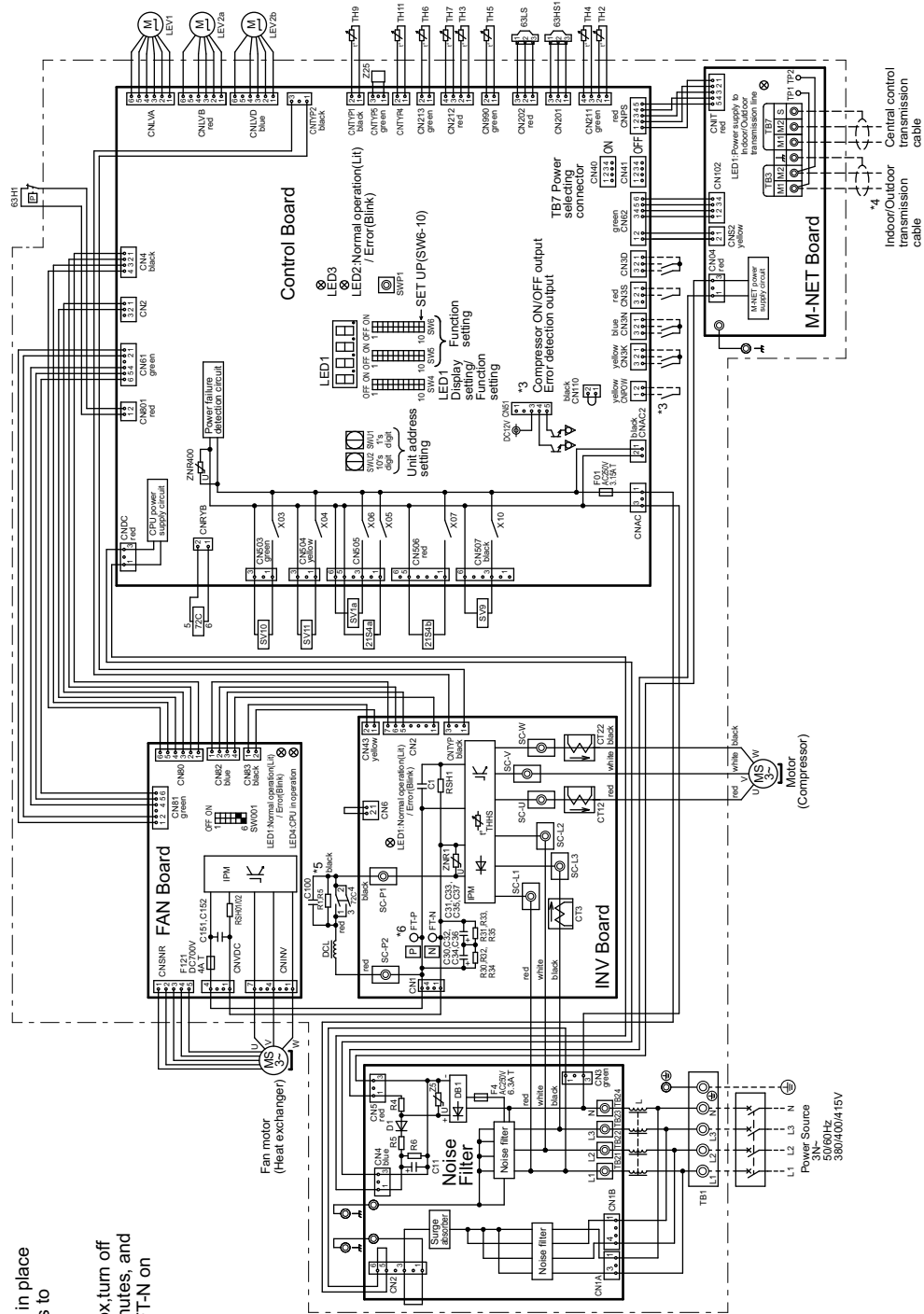

- *1 Single-dotted lines indicate wiring not supplied with the unit.
- *2 Dot-dash lines indicate the control box boundaries.
- *3 Refer to the Data book for connecting input/output signal connectors.
- *4 Daisy-chain terminals (TB3) on the outdoor units in the same refrigerant system together.
- *5 Faston terminals have a locking function. Make sure the terminals are securely locked in place after insertion. Press the tab on the terminals to removed them.
- *6 Control box houses high-voltage parts. Before inspecting the inside of the control box, turn off the power, keep the unit off for at least 10 minutes, and confirm that the voltage between FT-P and FT-N on INV Board has dropped to DC20V or less.

<Symbol explanation>

Symbol	Explanation
2/TS4a	Cooling/heating switching
2/TS4b	Heat exchanger capacity control
6/SH1	High pressure protection for the outdoor unit
6/SH1	Discharge pressure
6/SL3	Pressure
7/2C	Magnetic relay (inverter main circuit)
C/30-C/37	Capacitor (inverter main circuit)
C/12/C/22/C/3	Current sensor (AC)
DCL	DC reactor
L	Choke coil (for high frequency noise reduction)
LEV1	Linear expansion valve
LEV1a	HIC bypass Controls refrigerant flow in HIC circuit
LEV2a.b	Pressure control, Refrigerant flow rate control
R1.5	For inrush current prevention
SMH102/RSHT	For current detection
SV1a	For opening/closing the bypass circuit under the O/S
SV9	For opening/closing the bypass circuit
SV10, SV11	For opening/closing the defrost circuit
TB1	Power supply
TB3	Indoor/Outdoor transmission cable
TB7	Central control transmission cable
TH2	Subcool bypass outlet temperature
TH3	Pipe temperature
TH4	Discharge pipe temperature
TH5	ACC inlet pipe temperature
TH6	Subcooled liquid refrigerant temperature
TH7	OA temperature
TH9, TH11	Heat exchanger outlet pipe temperature
THHS	IPM temperature
ZZ5	Function setting connector

PUHY-P450, 500YKB-A1(-BS)

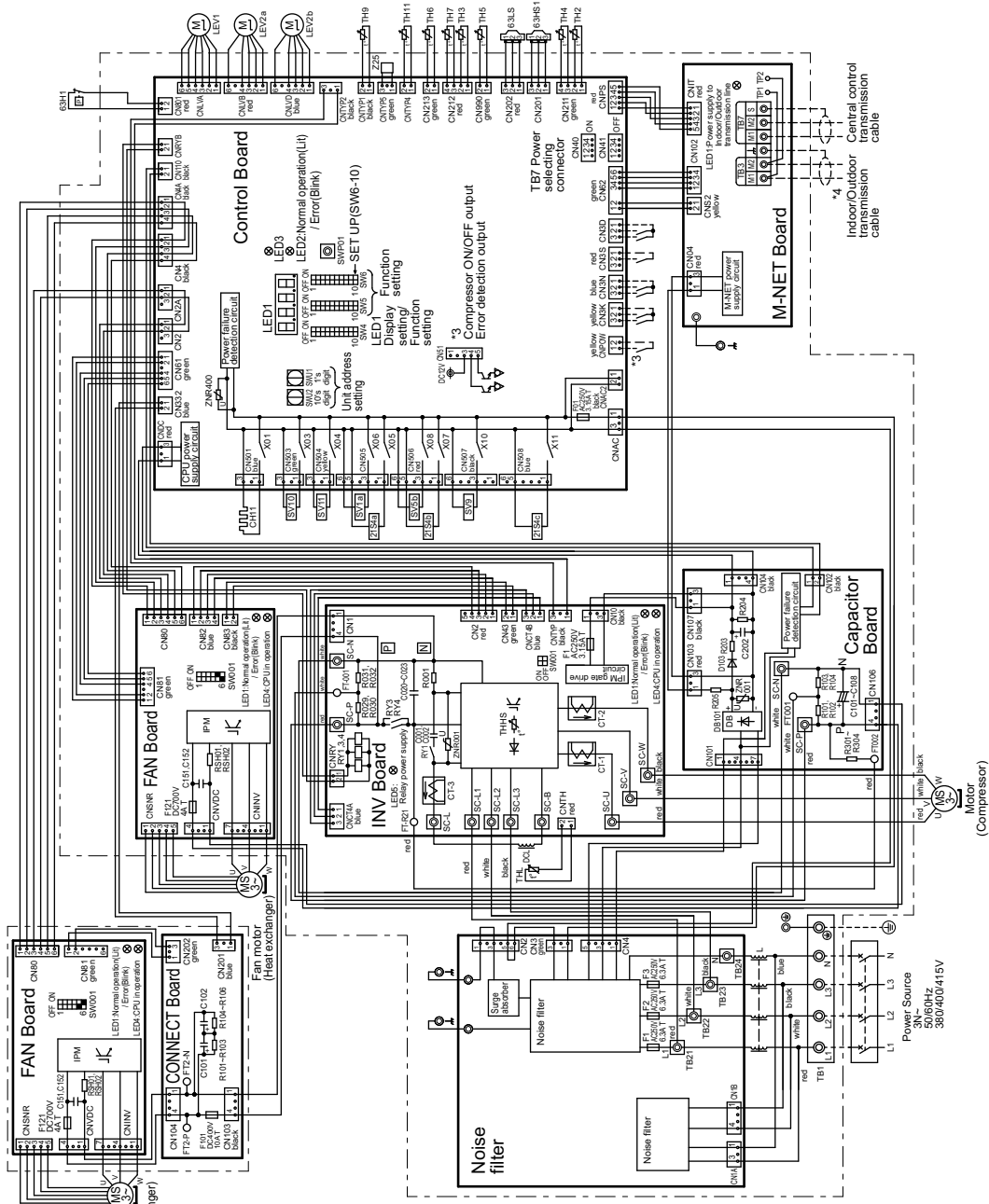

- *1. Single-dotted lines indicate wiring not supplied with the unit.
- *2. Dot-dash lines indicate the control box boundaries.
- *3. Refer to the Data book for connecting input/output signal connectors.
- *4. Daisy-chain terminals (TB3) on the outdoor units in the same refrigerant system together.
- *5. Faston terminals have a locking function. Make sure the terminals are securely locked in place after insertion. Press the tab on the terminals to removed them.
- *6. Control box houses high-voltage parts. Before inspecting the inside of the control box, turn off the power, keep the unit off for at least 10 minutes, and confirm that the voltage between SC-P and SC-N on Capacitor Board has dropped to DC20V or less.

<Symbol explanation>

Symbol	Explanation
Z1S4a	4-way valve
Z1S4b,c	Cooling/Heating switching
63H1	Heat exchanger capacity control switch
63HS1	High pressure protection for the outdoor unit
RV1	Pressure sensor
63LS	Discharge pressure sensor
RV3,RV4	Magnetic inverter main circuit
C001,C002	Capacitor
CT-1,CT-2	Inverter main circuit
CT-3	Filter circuit
DC	DC
CH11	Crankcase heater (for heating the compressor)
DCL	DC reactor
L	Choke coil (for high frequency noise reduction)
LEV1	HIC bypass/Controls refrigerant flow in HIC circuit
LEV2a,b	Pressure control, Refrigerant flow rate control
R307-R304	Resistor
R3H1,R3H2	Solenoid valve
SV1a	For opening/closing the bypass circuit under the O/S
SV5b	For opening/closing the bypass capacity control
SV9	Outdoor unit heat exchanger
SV10,SV11	For opening/closing the bypass circuit
TB1	For opening/closing the denost circuit
TB2	Power supply
TB3	Indoor/Outdoor transmission cable
TB7	Central control transmission cable
TB9	Indoor/Outdoor transmission cable
TH2	Thermistor
TH3	Discharge pipe temperature
TH4	ACC inlet pipe temperature
TH5	Subcooled liquid refrigerant temperature
TH6	OAT temperature
TH7	Heat exchanger outlet pipe temperature
TH9,TH11	IPM temperature
THHS	IPM temperature
THL	DC reactor temperature
Z25	Function setting connector

Measurement condition
PUHY-P200, 250YKB-A1(-BS)

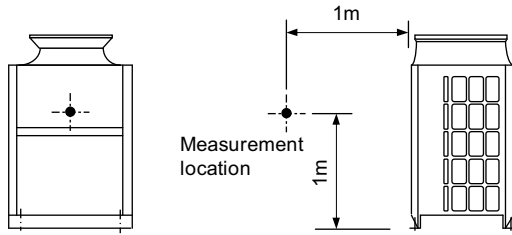

Measurement condition
PUHY-P300, 350, 400YKB-A1(-BS)

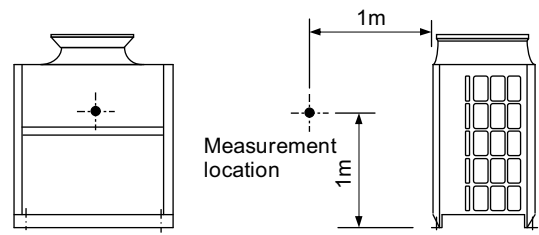

Sound level of PUHY-P200YKB-A1(-BS)

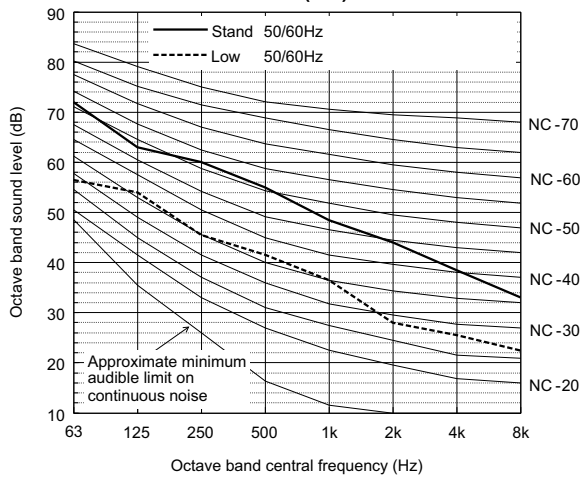

		63	125	250	500	1k	2k	4k	8k	dB(A)
Standard	50/60Hz	72.0	63.0	60.0	55.0	48.5	44.0	38.5	33.0	57.0
Low noise mode	50/60Hz	56.5	54.0	45.5	41.5	36.5	28.0	25.5	22.5	44.0

When Low noise mode is set, the A/C system's capacity is limited. The system could return to normal operation from Low noise mode automatically in the case that the operation condition is severe.

Sound level of PUHY-P300YKB-A1(-BS)

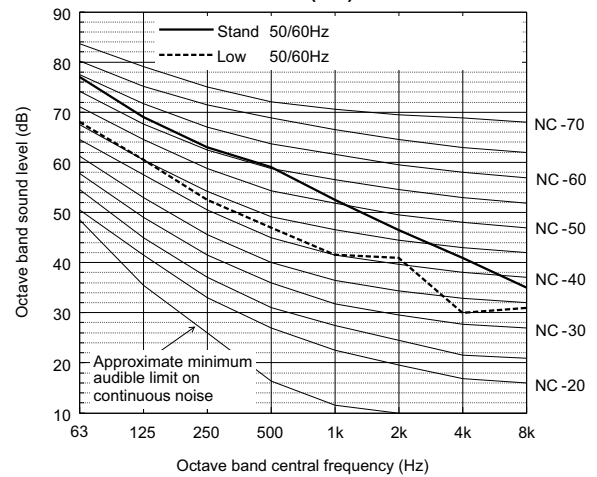

		63	125	250	500	1k	2k	4k	8k	dB(A)
Standard	50/60Hz	77.0	69.0	63.0	59.0	52.5	46.5	41.0	35.0	61.0
Low noise mode	50/60Hz	68.0	60.5	52.5	47.0	41.5	41.0	30.0	31.0	51.0

When Low noise mode is set, the A/C system's capacity is limited. The system could return to normal operation from Low noise mode automatically in the case that the operation condition is severe.

Sound level of PUHY-P250YKB-A1(-BS)

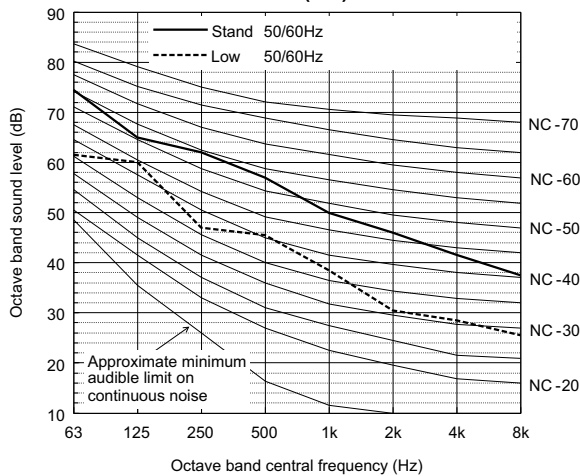

		63	125	250	500	1k	2k	4k	8k	dB(A)
Standard	50/60Hz	74.5	65.0	62.0	57.0	50.0	46.0	41.5	37.5	59.0
Low noise mode	50/60Hz	61.5	60.0	47.0	45.5	38.5	30.5	28.5	25.5	48.0

When Low noise mode is set, the A/C system's capacity is limited. The system could return to normal operation from Low noise mode automatically in the case that the operation condition is severe.

Sound level of PUHY-P350YKB-A1(-BS)

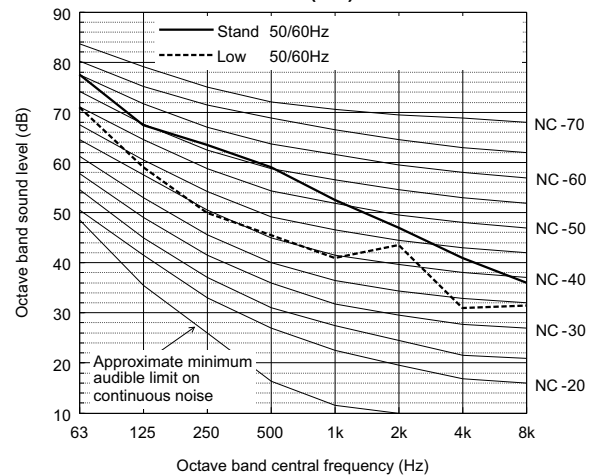

		63	125	250	500	1k	2k	4k	8k	dB(A)
Standard	50/60Hz	77.5	67.5	63.5	59.0	52.5	47.0	41.0	36.0	61.0
Low noise mode	50/60Hz	71.0	59.0	50.0	45.5	41.0	43.5	31.0	31.5	51.0

When Low noise mode is set, the A/C system's capacity is limited. The system could return to normal operation from Low noise mode automatically in the case that the operation condition is severe.

• Depending on the operation conditions, the unit generates noise caused by valve actuation, refrigerant flow, and pressure changes when operating normally. Please consider to avoid location where quietness is required.

Y

Sound level of PUHY-P400YKB-A1(-BS)

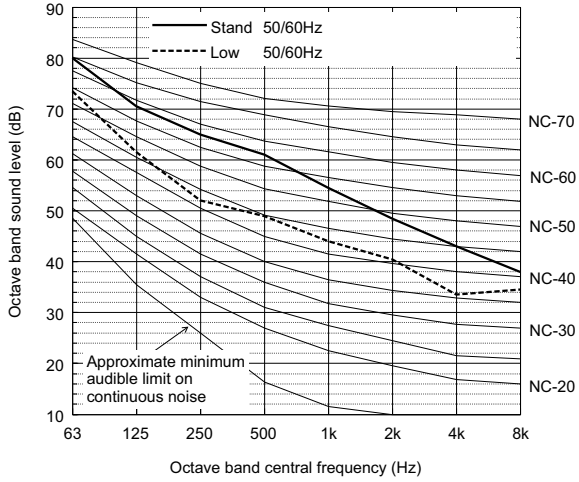

		63	125	250	500	1k	2k	4k	8k	dB(A)
Standard	50/60Hz	80.0	70.5	65.0	61.0	54.5	48.5	43.0	38.0	63.0
Low noise mode	50/60Hz	73.5	61.5	52.0	49.0	44.0	40.5	33.5	34.5	53.0

When Low noise mode is set, the A/C system's capacity is limited. The system could return to normal operation from Low noise mode automatically in the case that the operation condition is severe.

Measurement condition
PUHY-P450, 500YKB-A1(-BS)

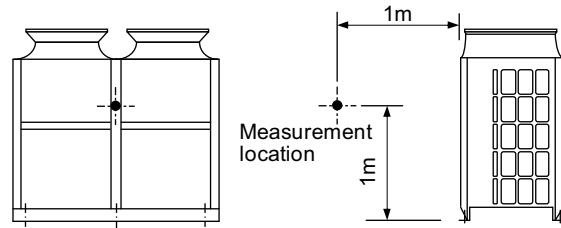

Sound level of PUHY-P450YKB-A1(-BS)

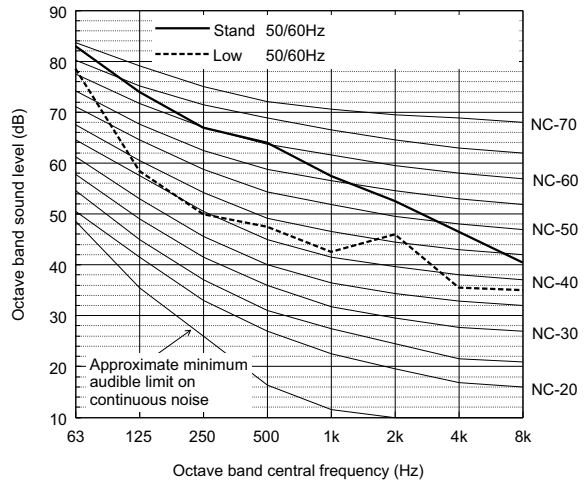

		63	125	250	500	1k	2k	4k	8k	dB(A)
Standard	50/60Hz	83.0	74.0	67.0	64.0	57.5	52.5	46.5	40.5	66.0
Low noise mode	50/60Hz	78.5	58.5	50.0	47.5	42.5	46.0	35.5	35.0	55.0

When Low noise mode is set, the A/C system's capacity is limited. The system could return to normal operation from Low noise mode automatically in the case that the operation condition is severe.

Sound level of PUHY-P500YKB-A1(-BS)

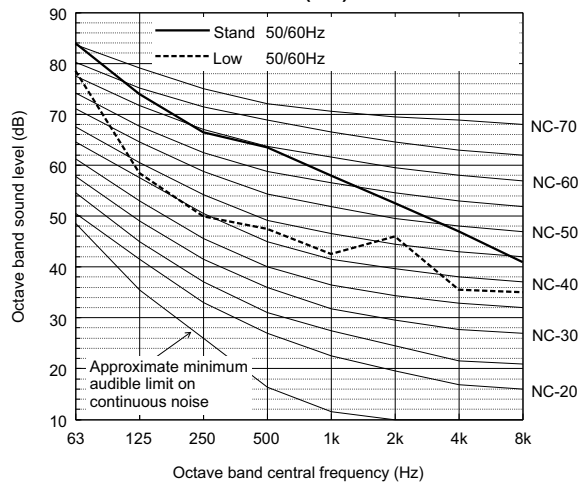

		63	125	250	500	1k	2k	4k	8k	dB(A)
Standard	50/60Hz	84.0	74.0	66.5	63.5	58.0	52.5	47.0	41.0	66.0
Low noise mode	50/60Hz	78.5	58.5	50.0	47.5	42.5	46.0	35.5	35.0	55.0

When Low noise mode is set, the A/C system's capacity is limited. The system could return to normal operation from Low noise mode automatically in the case that the operation condition is severe.

• Depending on the operation conditions, the unit generates noise caused by valve actuation, refrigerant flow, and pressure changes when operating normally. Please consider to avoid location where quietness is required.

Measurement condition
PUHY-P400, 450, 500YSKB-A1(-BS)

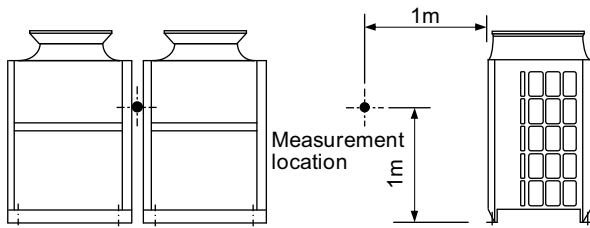

Sound level of PUHY-P500YSKB-A1(-BS)

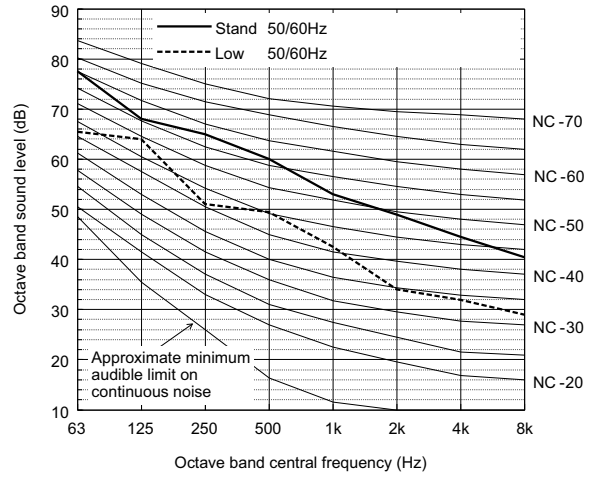

		63	125	250	500	1k	2k	4k	8k	dB(A)
Standard	50/60Hz	77.5	68.0	65.0	60.0	53.0	49.0	44.5	40.5	62.0
Low noise mode	50/60Hz	65.5	64.0	51.0	49.5	42.5	34.0	32.0	29.0	52.0

When Low noise mode is set, the A/C system's capacity is limited. The system could return to normal operation from Low noise mode automatically in the case that the operation condition is severe.

Sound level of PUHY-P400YSKB-A1(-BS)

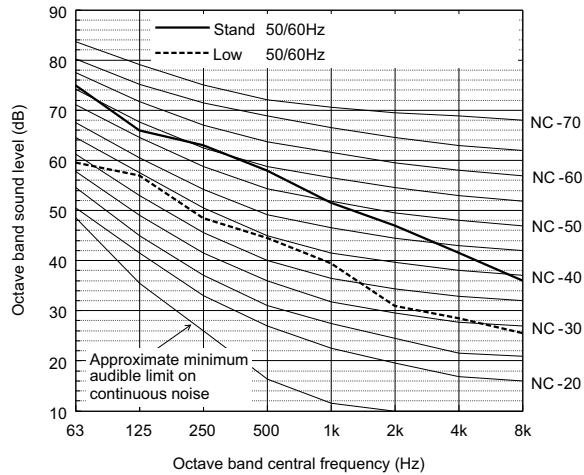

		63	125	250	500	1k	2k	4k	8k	dB(A)
Standard	50/60Hz	75.0	66.0	63.0	58.0	51.5	47.0	41.5	36.0	60.0
Low noise mode	50/60Hz	59.5	57.0	48.5	44.5	39.5	31.0	28.5	25.5	47.0

When Low noise mode is set, the A/C system's capacity is limited. The system could return to normal operation from Low noise mode automatically in the case that the operation condition is severe.

Sound level of PUHY-P450YSKB-A1(-BS)

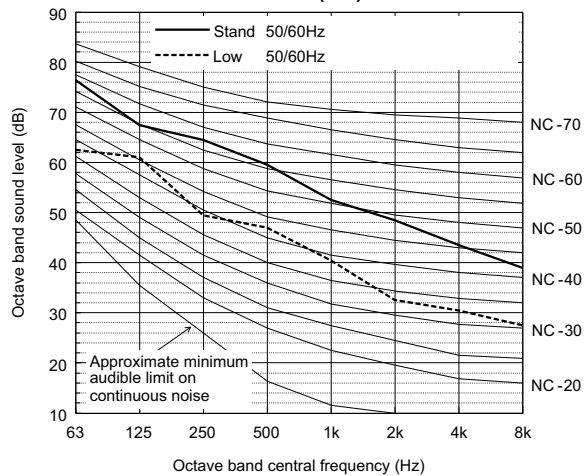

		63	125	250	500	1k	2k	4k	8k	dB(A)
Standard	50/60Hz	76.5	67.5	64.5	59.5	52.5	48.5	43.5	39.0	61.5
Low noise mode	50/60Hz	62.5	61.0	49.5	47.0	40.5	32.5	30.5	27.5	49.5

When Low noise mode is set, the A/C system's capacity is limited. The system could return to normal operation from Low noise mode automatically in the case that the operation condition is severe.

◆ Depending on the operation conditions, the unit generates noise caused by valve actuation, refrigerant flow, and pressure changes when operating normally. Please consider to avoid location where quietness is required.

Y

Measurement condition
PUHY-P550, 600YSKB-A1(-BS)

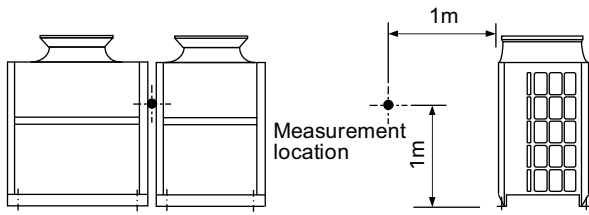

Measurement condition
PUHY-P650, 700, 750YSKB-A1(-BS)

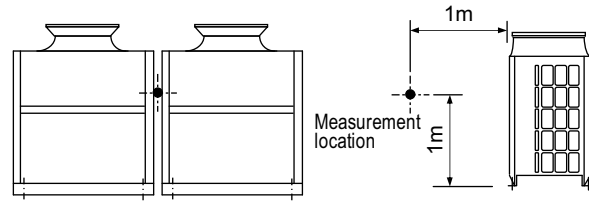

Sound level of PUHY-P550YSKB-A1(-BS)

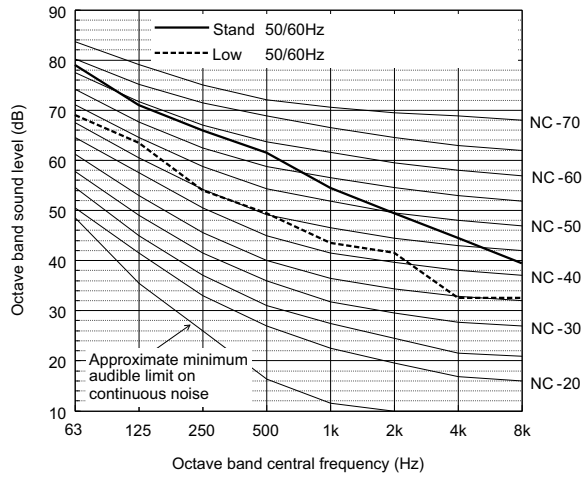

		63	125	250	500	1k	2k	4k	8k	dB(A)
Standard	50/60Hz	79.0	71.0	66.0	61.5	54.5	49.5	44.5	39.5	63.5
Low noise mode	50/60Hz	69.0	63.5	54.0	49.5	43.5	41.5	32.5	32.5	53.0

When Low noise mode is set, the A/C system's capacity is limited. The system could return to normal operation from Low noise mode automatically in the case that the operation condition is severe.

Sound level of PUHY-P650YSKB-A1(-BS)

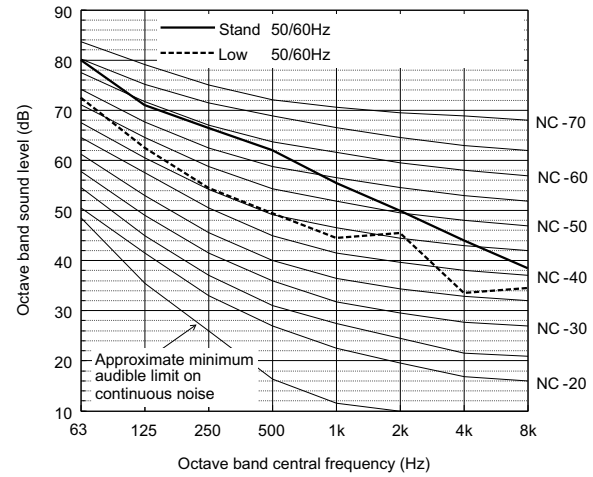

		63	125	250	500	1k	2k	4k	8k	dB(A)
Standard	50/60Hz	80.0	71.0	66.5	62.0	55.5	50.0	44.0	38.5	64.0
Low noise mode	50/60Hz	72.5	62.5	54.5	49.5	44.5	45.5	33.5	34.5	54.0

When Low noise mode is set, the A/C system's capacity is limited. The system could return to normal operation from Low noise mode automatically in the case that the operation condition is severe.

Sound level of PUHY-P600YSKB-A1(-BS)

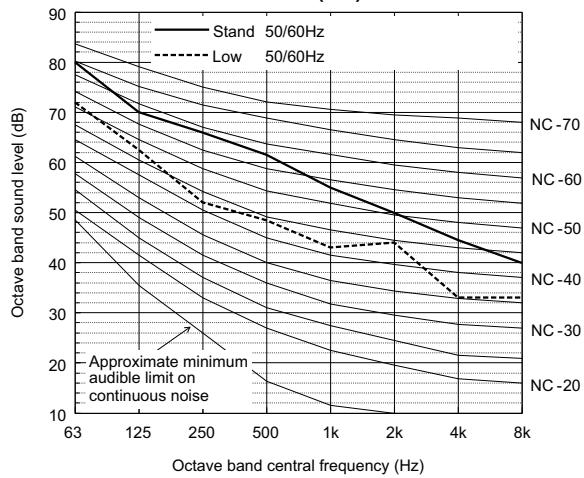

		63	125	250	500	1k	2k	4k	8k	dB(A)
Standard	50/60Hz	80.0	70.0	66.0	61.5	55.0	50.0	44.5	40.0	63.5
Low noise mode	50/60Hz	72.0	62.5	52.0	48.5	43.0	44.0	33.0	33.0	53.0

When Low noise mode is set, the A/C system's capacity is limited. The system could return to normal operation from Low noise mode automatically in the case that the operation condition is severe.

Sound level of PUHY-P700YSKB-A1(-BS)

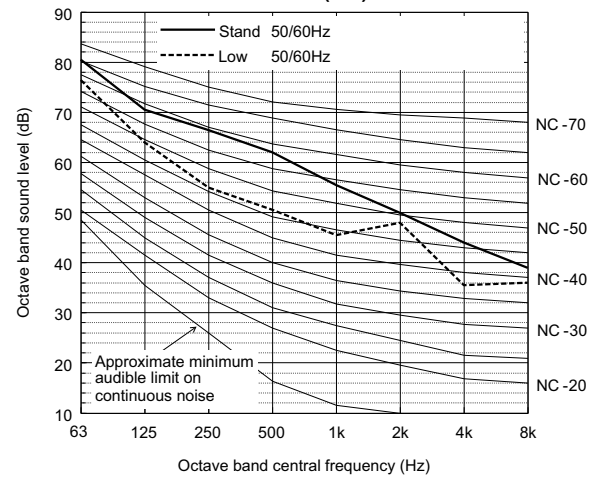

		63	125	250	500	1k	2k	4k	8k	dB(A)
Standard	50/60Hz	80.5	70.5	66.5	62.0	55.5	50.0	44.0	39.0	64.0
Low noise mode	50/60Hz	76.5	64.0	55.0	50.5	45.5	48.0	35.5	36.0	56.0

When Low noise mode is set, the A/C system's capacity is limited. The system could return to normal operation from Low noise mode automatically in the case that the operation condition is severe.

♦ Depending on the operation conditions, the unit generates noise caused by valve actuation, refrigerant flow, and pressure changes when operating normally. Please consider to avoid location where quietness is required.

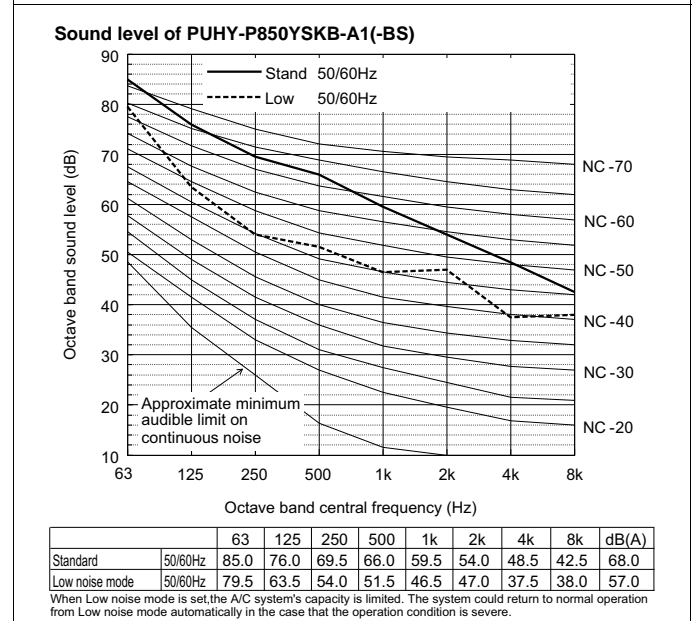
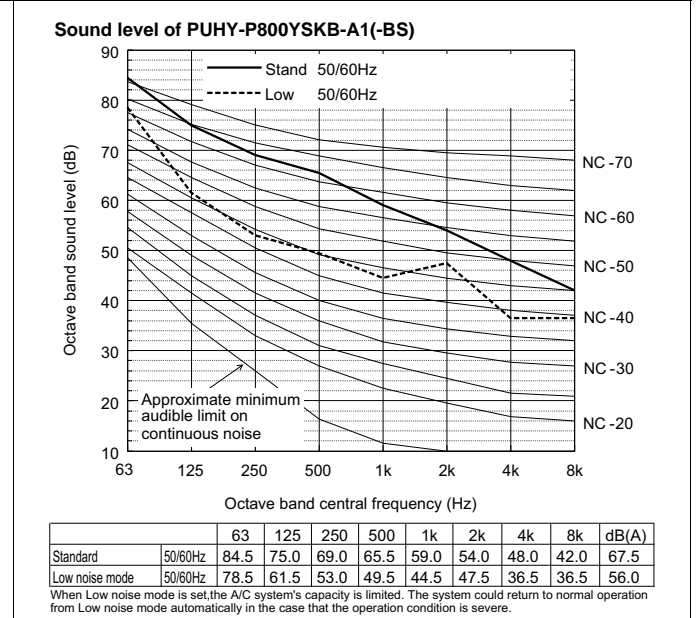
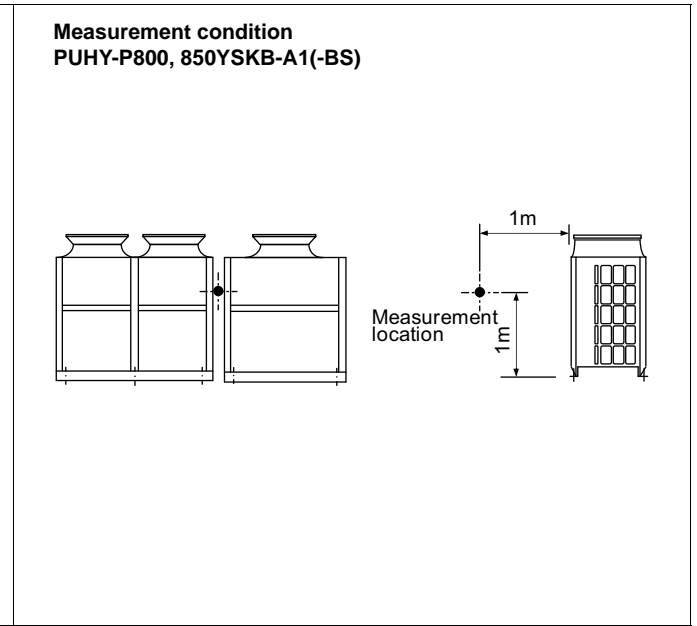
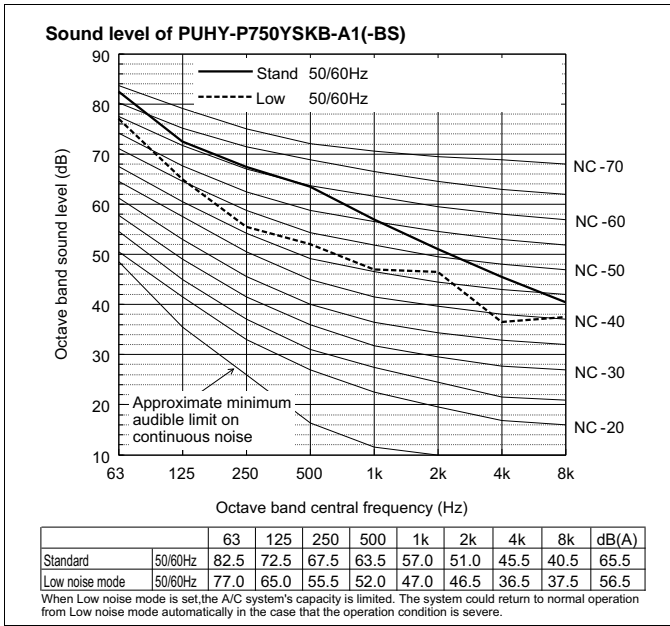

◆ Depending on the operation conditions, the unit generates noise caused by valve actuation, refrigerant flow, and pressure changes when operating normally. Please consider to avoid location where quietness is required.

Y

Measurement condition
PUHY-P900YSKB-A1(-BS)

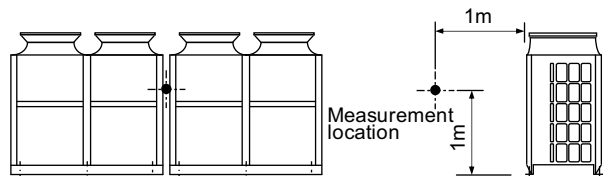

Measurement condition
PUHY-P950YSKB-A1(-BS)

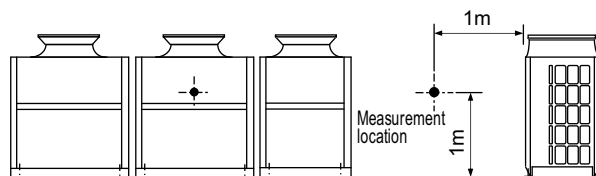

Sound level of PUHY-P900YSKB-A1(-BS)

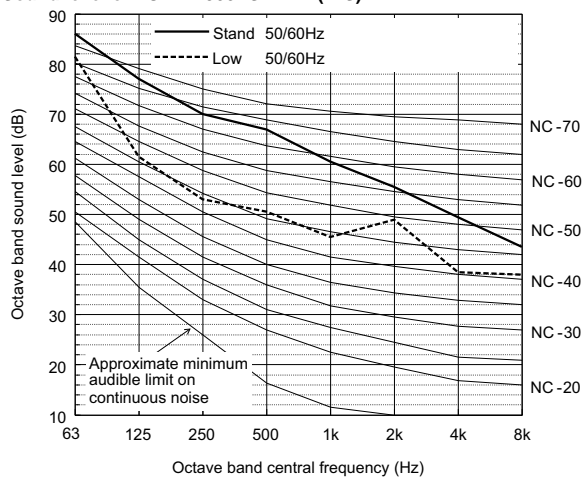

		63	125	250	500	1k	2k	4k	8k	dB(A)
Standard	50/60Hz	86.0	77.0	70.0	67.0	60.5	55.5	49.5	43.5	69.0
Low noise mode	50/60Hz	81.5	61.5	53.0	50.5	45.5	49.0	38.5	38.0	58.0

When Low noise mode is set, the A/C system's capacity is limited. The system could return to normal operation from Low noise mode automatically in the case that the operation condition is severe.

Sound level of PUHY-P950YSKB-A1(-BS)

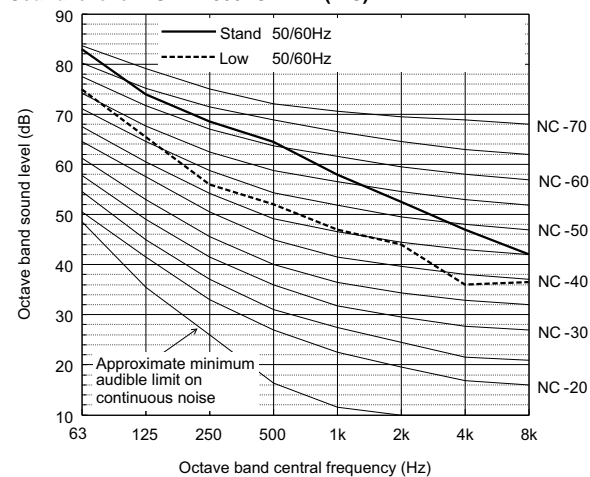

		63	125	250	500	1k	2k	4k	8k	dB(A)
Standard	50/60Hz	83.0	74.0	68.5	64.5	58.0	52.5	47.0	42.0	66.5
Low noise mode	50/60Hz	75.0	65.5	56.0	52.0	47.0	44.0	36.0	36.5	56.0

When Low noise mode is set, the A/C system's capacity is limited. The system could return to normal operation from Low noise mode automatically in the case that the operation condition is severe.

♦ Depending on the operation conditions, the unit generates noise caused by valve actuation, refrigerant flow, and pressure changes when operating normally. Please consider to avoid location where quietness is required.

Measurement condition
PUHY-P1000, 1050, 1100YSKB-A1(-BS)

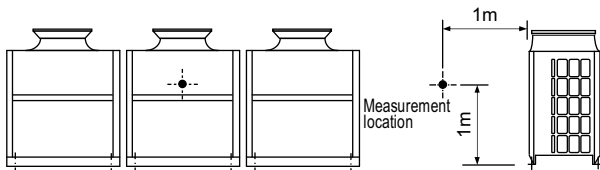

Sound level of PUHY-P1100YSKB-A1(-BS)

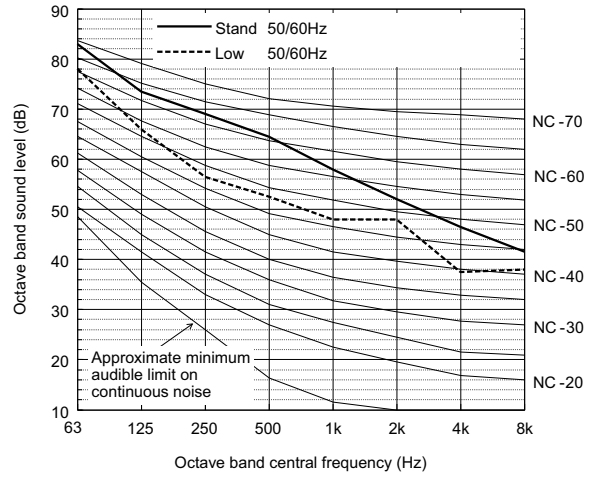

		63	125	250	500	1k	2k	4k	8k	dB(A)
Standard	50/60Hz	83.0	73.5	69.0	64.5	58.0	52.0	46.5	41.5	66.5
Low noise mode	50/60Hz	78.0	66.0	56.5	52.5	48.0	48.0	37.5	38.0	57.5

When Low noise mode is set, the A/C system's capacity is limited. The system could return to normal operation from Low noise mode automatically in the case that the operation condition is severe.

Sound level of PUHY-P1000YSKB-A1(-BS)

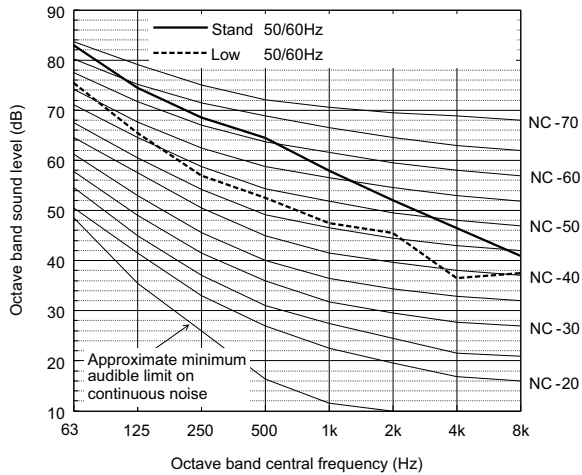

		63	125	250	500	1k	2k	4k	8k	dB(A)
Standard	50/60Hz	83.0	74.5	68.5	64.5	58.0	52.0	46.5	41.0	66.5
Low noise mode	50/60Hz	75.5	65.5	57.0	52.5	47.5	45.5	36.5	37.5	56.5

When Low noise mode is set, the A/C system's capacity is limited. The system could return to normal operation from Low noise mode automatically in the case that the operation condition is severe.

Sound level of PUHY-P1050YSKB-A1(-BS)

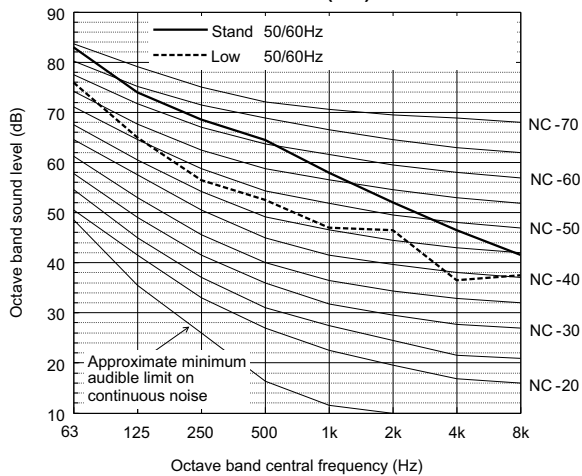

		63	125	250	500	1k	2k	4k	8k	dB(A)
Standard	50/60Hz	83.0	74.0	68.5	64.5	58.0	52.0	46.5	41.5	66.5
Low noise mode	50/60Hz	76.0	65.0	56.5	52.5	47.0	46.5	36.5	37.5	56.5

When Low noise mode is set, the A/C system's capacity is limited. The system could return to normal operation from Low noise mode automatically in the case that the operation condition is severe.

- Depending on the operation conditions, the unit generates noise caused by valve actuation, refrigerant flow, and pressure changes when operating normally. Please consider to avoid location where quietness is required.

Y

Measurement condition
PUHY-P1150, 1200YSKB-A1(-BS)

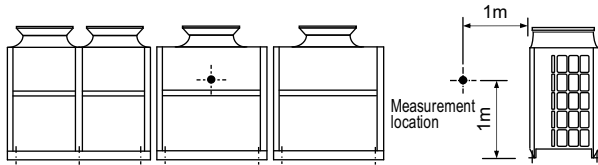

Measurement condition
PUHY-P1250, 1300YSKB-A1(-BS)

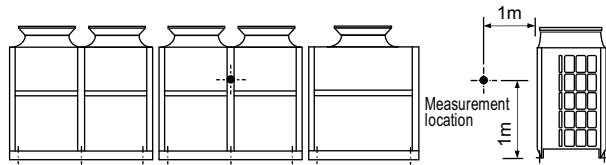

Sound level of PUHY-P1150YSKB-A1(-BS)

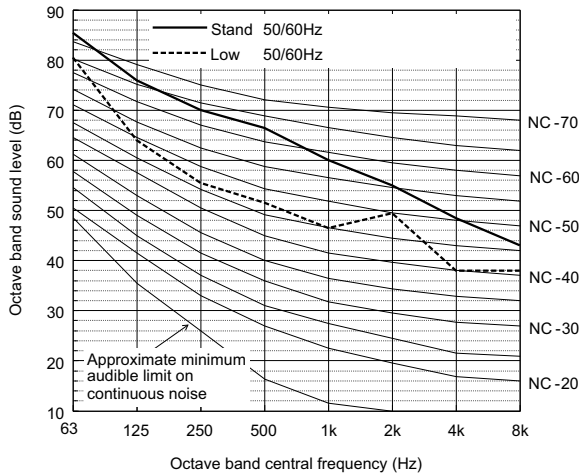

		63	125	250	500	1k	2k	4k	8k	dB(A)
Standard	50/60Hz	85.5	76.0	70.0	66.5	60.0	55.0	48.5	43.0	68.5
Low noise mode	50/60Hz	80.5	64.0	55.5	51.5	46.5	49.5	38.0	38.0	58.0

When Low noise mode is set, the A/C system's capacity is limited. The system could return to normal operation from Low noise mode automatically in the case that the operation condition is severe.

Sound level of PUHY-P1250YSKB-A1(-BS)

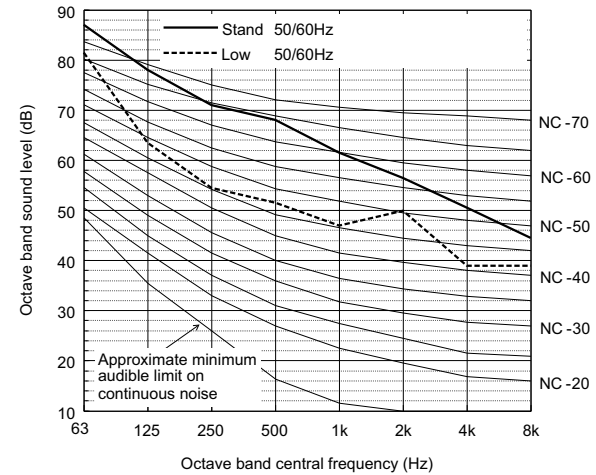

		63	125	250	500	1k	2k	4k	8k	dB(A)
Standard	50/60Hz	87.0	78.0	71.0	68.0	61.5	56.5	50.5	44.5	70.0
Low noise mode	50/60Hz	81.5	63.5	54.5	51.5	47.0	50.0	39.0	39.0	58.5

When Low noise mode is set, the A/C system's capacity is limited. The system could return to normal operation from Low noise mode automatically in the case that the operation condition is severe.

Sound level of PUHY-P1200YSKB-A1(-BS)

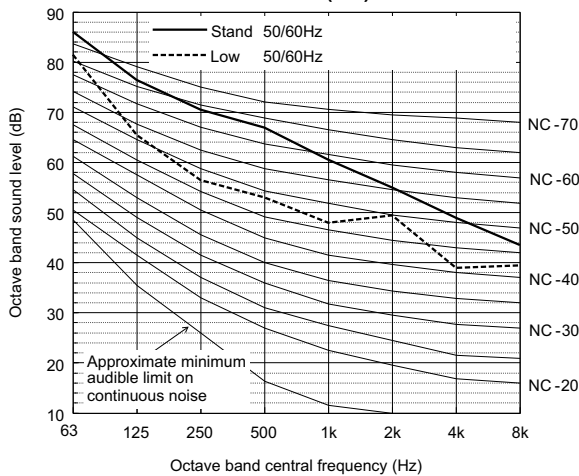

		63	125	250	500	1k	2k	4k	8k	dB(A)
Standard	50/60Hz	86.0	76.5	70.5	67.0	60.5	55.0	49.0	43.5	69.0
Low noise mode	50/60Hz	81.5	65.5	56.5	53.0	48.0	49.5	39.0	39.5	59.0

When Low noise mode is set, the A/C system's capacity is limited. The system could return to normal operation from Low noise mode automatically in the case that the operation condition is severe.

Sound level of PUHY-P1300YSKB-A1(-BS)

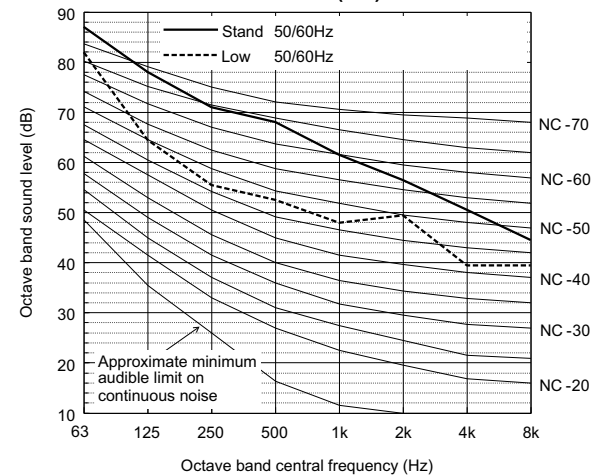

		63	125	250	500	1k	2k	4k	8k	dB(A)
Standard	50/60Hz	87.0	78.0	71.0	68.0	61.5	56.5	50.5	44.5	70.0
Low noise mode	50/60Hz	82.0	64.5	55.5	52.5	48.0	49.5	39.5	39.5	59.0

When Low noise mode is set, the A/C system's capacity is limited. The system could return to normal operation from Low noise mode automatically in the case that the operation condition is severe.

♦ Depending on the operation conditions, the unit generates noise caused by valve actuation, refrigerant flow, and pressure changes when operating normally. Please consider to avoid location where quietness is required.

**Measurement condition
PUHY-P1350YSKB-A1(-BS)**

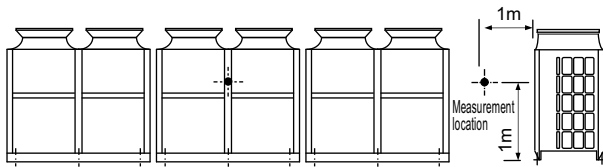

Sound level of PUHY-P1350YSKB-A1(-BS)

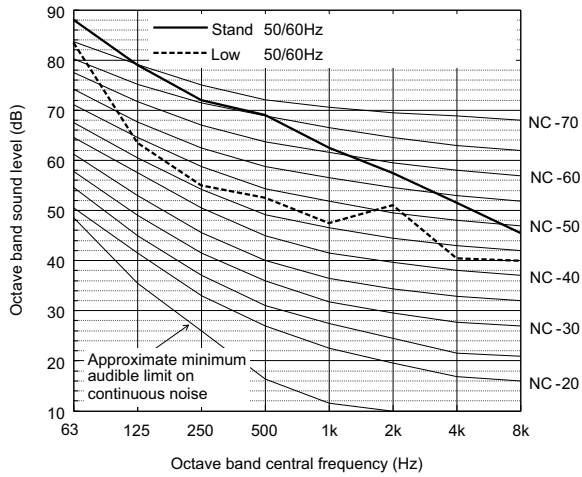

		63	125	250	500	1k	2k	4k	8k	dB(A)
Standard	50/60Hz	88.0	79.0	72.0	69.0	62.5	57.5	51.5	45.5	71.0
Low noise mode	50/60Hz	83.5	63.5	55.0	52.5	47.5	51.0	40.5	40.0	60.0

When Low noise mode is set, the A/C system's capacity is limited. The system could return to normal operation from Low noise mode automatically in the case that the operation condition is severe.

- ◆ Depending on the operation conditions, the unit generates noise caused by valve actuation, refrigerant flow, and pressure changes when operating normally. Please consider to avoid location where quietness is required.

[PUHY-P200-500YKB-A1, PUHY-P400-1350YSKB-A1]

Measurement condition

Measurement frequency: 1 Hz-80 Hz

Measurement point: Ground surface 20 cm away from the unit leg

Installation condition: Direct installation on the concrete floor

Power source: 3-phase 4-wire 380-400-415 V 50/60 Hz

Operation condition: JIS condition (cooling, heating)

Measurement device: Vibration level meter for vibration pollution VM-1220C (JIS-compliant product)

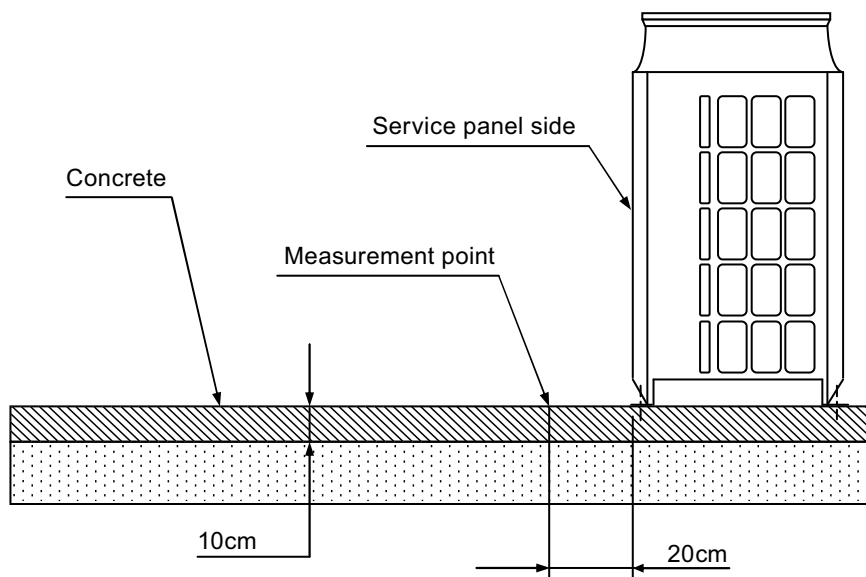

Vibration level

Model	Vibration level (dB)
PUHY-P200YKB-A1 (-BS)	45
PUHY-P250YKB-A1 (-BS)	46
PUHY-P300YKB-A1 (-BS)	47
PUHY-P350YKB-A1 (-BS)	47
PUHY-P400YKB-A1 (-BS)	47
PUHY-P450YKB-A1 (-BS)	47
PUHY-P500YKB-A1 (-BS)	48
PUHY-P400YSKB-A1 (-BS)	48
PUHY-P450YSKB-A1 (-BS)	48.5
PUHY-P500YSKB-A1 (-BS)	49
PUHY-P550YSKB-A1 (-BS)	49.5
PUHY-P600YSKB-A1 (-BS)	49.5
PUHY-P650YSKB-A1 (-BS)	50
PUHY-P700YSKB-A1 (-BS)	50
PUHY-P750YSKB-A1 (-BS)	50
PUHY-P800YSKB-A1 (-BS)	50
PUHY-P850YSKB-A1 (-BS)	50
PUHY-P900YSKB-A1 (-BS)	50
PUHY-P950YSKB-A1 (-BS)	51.5
PUHY-P1000YSKB-A1 (-BS)	52
PUHY-P1050YSKB-A1 (-BS)	52
PUHY-P1100YSKB-A1 (-BS)	52
PUHY-P1150YSKB-A1 (-BS)	52
PUHY-P1200YSKB-A1 (-BS)	52
PUHY-P1250YSKB-A1 (-BS)	52
PUHY-P1300YSKB-A1 (-BS)	52
PUHY-P1350YSKB-A1 (-BS)	52

* Vibration level varies depending on the conditions of actual installation site.

• Cooling

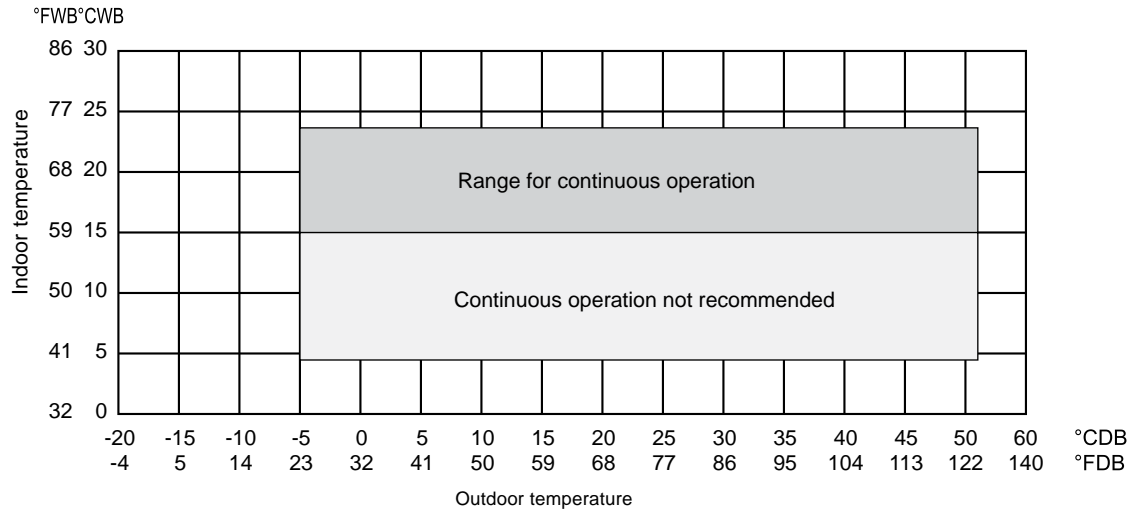

• Heating

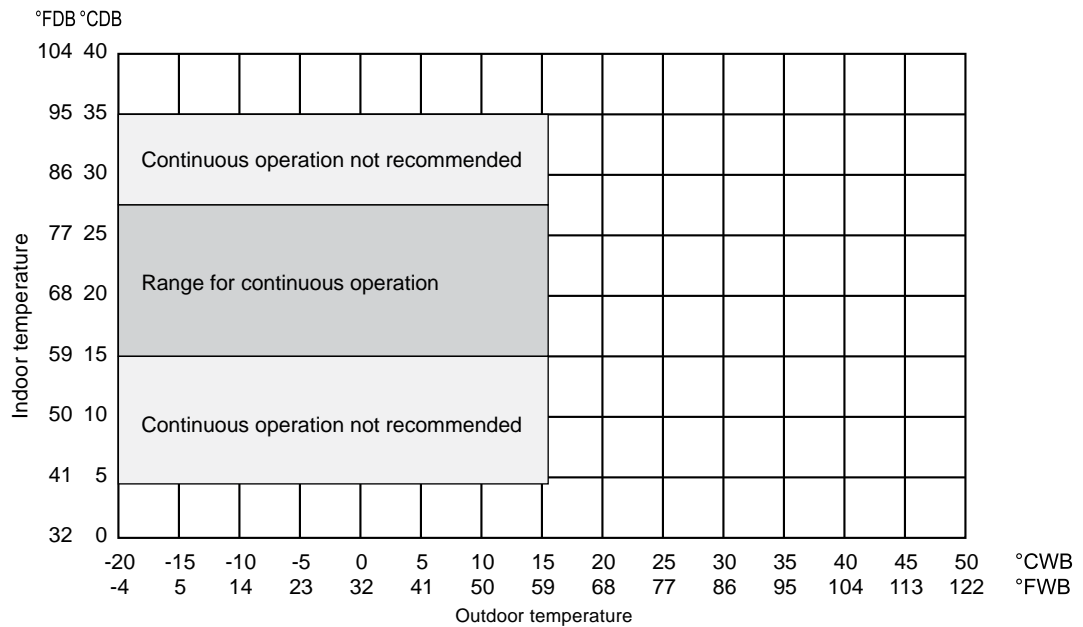

8-1. Selection of Cooling/Heating Units

<Cooling>

Design Condition	
Outdoor Design Dry Bulb Temperature	43 °C
Total Cooling Load	18.0 kW
Room1	
Indoor Design Dry Bulb Temperature	27 °C
Indoor Design Wet Bulb Temperature	20 °C
Cooling Load	8.0 kW
Room2	
Indoor Design Dry Bulb Temperature	24 °C
Indoor Design Wet Bulb Temperature	17 °C
Cooling Load	10.0 kW
<Other>	
Indoor/Outdoor Equivalent Piping Length	50 m

1. Cooling Calculation

(1) Temporary Selection of Indoor Units

Room1	PEFY-P80	9 kW (Rated)
Room2	PEFY-P100	11.2 kW (Rated)

(2) Total Indoor Units Capacity

$P80 + P100 = P180$

(3) Selection of Outdoor Unit

The P200 outdoor unit is selected as total indoor units capacity is P180

PUHY-P200	22.4 kW
-----------	---------

(4) Total Indoor Units Capacity Correction Calculation

Room1	Indoor Design Wet Bulb Temperature Correction (20°C)	1.04 (Refer to Fig.1)
Room2	Indoor Design Wet Bulb Temperature Correction (17°C)	0.95 (Refer to Fig.1)

Total Indoor Units Capacity (CTi)

$$CTi = \sum (\text{Indoor Unit Rating} \times \text{Indoor Design Temperature Correction})$$

$$= 9.0 \times 1.04 + 11.2 \times 0.95$$

$$= 20.0 \text{ kW}$$

(5) Outdoor Unit Correction Calculation

Outdoor Design Dry Bulb Temperature Correction (43°C)	0.94 (Refer to Fig.2)
Piping Length Correction (50 m)	0.94 (Refer to Fig.3)

Total Outdoor Unit Capacity (CTo)

$$CTo = \text{Outdoor Rating} \times \text{Outdoor Design Temperature Correction} \times \text{Piping Length Correction}$$

$$= 22.4 \times 0.94 \times 0.94$$

$$= 19.9 \text{ kW}$$

(6) Determination of Maximum System Capacity

Comparison of Capacity between Total Indoor Units Capacity (CTi) and Total Outdoor Unit Capacity (CTo)

$CTi = 20.0 > CTo = 19.9$, thus, select CTo.

$CTx = CTo = 19.9 \text{ kW}$

(7) Comparison with Essential Load

Against the essential load 18.0kW, the maximum system capacity is 19.9kW: Proper outdoor units have been selected.

(8) Calculation of Maximum Indoor Unit Capacity of Each Room

$CTx = CTo$, thus, calculate by the calculation below

Room1

$$\text{Maximum Capacity} \times \text{Room1 Capacity after the Temperature Correction} / (\text{Room1,2 Total Capacity after the Temperature Correction})$$

$$= 19.9 \times (9.0 \times 1.04) / (9.0 \times 1.04 + 11.2 \times 0.95)$$

$$= 9.3 \text{ kW} \quad \text{OK: fulfills the load 8.0kW}$$

Room2

$$\text{Maximum Capacity} \times \text{Room2 Capacity after the Temperature Correction} / (\text{Room1,2 Total Capacity after the Temperature Correction})$$

$$= 19.9 \times (11.2 \times 0.95) / (9.0 \times 1.04 + 11.2 \times 0.95)$$

$$= 10.6 \text{ kW} \quad \text{OK: fulfills the load 10.0kW}$$

Go on to the heating trial calculation since the selected units fulfill the cooling loads of Room 1, 2.

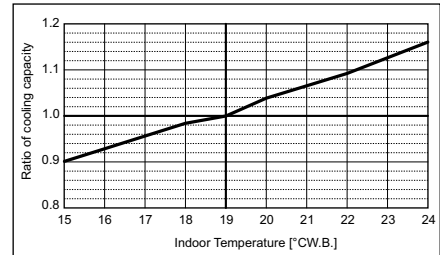

Fig.1 Indoor unit temperature correction
To be used to correct indoor unit capacity only

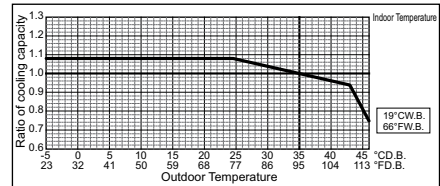

Fig.2 Outdoor unit temperature correction
To be used to correct outdoor unit capacity only

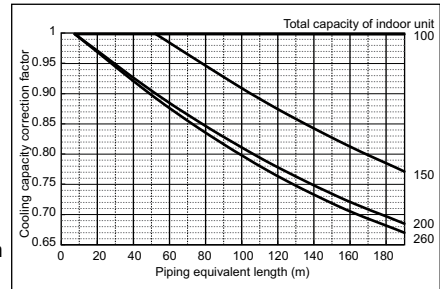

Fig.3 Correction of refrigerant piping length

<Heating>

Design Condition	
Outdoor Design Wet Bulb Temperature	-3 °C
Total Heating Load	20.5 kW
Room1	
Indoor Design Dry Bulb Temperature	21 °C
Heating Load	9.5 kW
Room2	
Indoor Design Dry Bulb Temperature	23 °C
Heating Load	11.0 kW
<Other>	
Indoor/Outdoor Equivalent Piping Length	50 m

2. Heating Calculation

(1) Temporary Selection of Indoor Units

Room1	PEFY-P80	10 kW (Rated)
Room2	PEFY-P100	12.5 kW (Rated)

(2) Total Indoor Units Capacity

P80 + P100 = P180

(3) Selection of Outdoor Unit

The P200 outdoor unit is selected as total indoor units capacity is P180

PUHY-P200	25.0 kW
-----------	---------

(4) Total Indoor Units Capacity Correction Calculation

Room1	Indoor Design Dry Bulb Temperature Correction (21°C)	0.97 (Refer to Fig.4)
Room2	Indoor Design Dry Bulb Temperature Correction (23°C)	0.90 (Refer to Fig.4)

Total Indoor Units Capacity (CTi)

$$CTi = \sum (\text{Indoor Unit Rating} \times \text{Indoor Design Temperature Correction})$$

$$= 10.0 \times 0.97 + 12.5 \times 0.90$$

$$= 21.0 \text{ kW}$$

(5) Outdoor Unit Correction Calculation

Outdoor Design Wet Bulb Temperature Correction (-3°C)	0.98 (Refer to Fig.5)
Piping Length Correction (50 m)	0.97 (Refer to Fig.6)
Defrost Correction	0.89 (Refer to Tbl.1)

Total Outdoor Unit Capacity (CTo)

$$CTo = \text{Outdoor Unit Rating} \times \text{Outdoor Design Temperature Correction} \times \text{Piping Length Correction} \times \text{Defrost Correction}$$

$$= 25.0 \times 0.98 \times 0.97 \times 0.89$$

$$= 21.1 \text{ kW}$$

(6) Determination of Maximum System Capacity

Comparison of Capacity between Total Indoor Units Capacity (CTi) and Total Outdoor Unit Capacity (CTo)

CTi = 21.0 < CTo = 21.1, thus, select CTi.

CTx = CTi = 21.0 kW

(7) Comparison with Essential Load

Against the essential load 20.5kW, the maximum system capacity is 21.0kW: Proper outdoor units have been selected.

(8) Calculation of Maximum Indoor Unit Capacity of Each Room

CTx = CTi, thus, calculate by the calculation below

Room1	Indoor Unit Rating × Indoor Design Temperature Correction	OK: fulfills the load 9.5kW
	= 10.0 × 0.97	
	= 9.7 kW	

Room2	Indoor Unit Rating × Indoor Design Temperature Correction	OK: fulfills the load 11.0kW
	= 12.5 × 0.90	
	= 11.3 kW	

Completed selecting units since the selected units fulfill the heating loads of Room 1, 2.

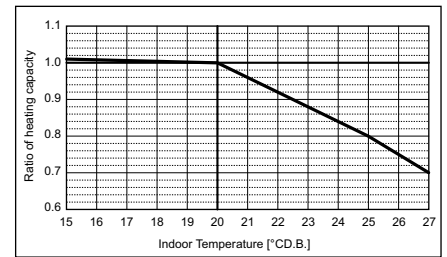

Fig.4 Indoor unit temperature correction
To be used to correct indoor unit capacity only

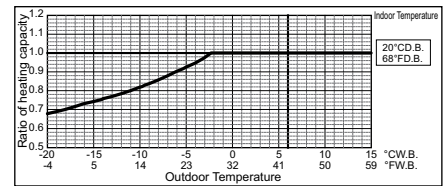

Fig.5 Outdoor unit temperature correction
To be used to correct outdoor unit capacity only

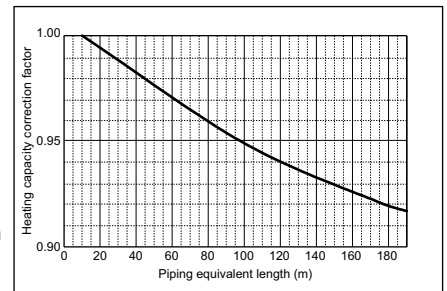

Fig.6 Correction of refrigerant piping length

Tbl.1 Table of correction factor at frost and defrost

Outdoor inlet air temp. °C	6	4	2	1	0	-2	-4	-6	-8	-10	-20
Outdoor inlet air temp. °F	43	39	36	34	32	28	25	21	18	14	-4
PUHY-P200	1.00	0.95	0.84	0.825	0.83	0.87	0.90	0.95	0.95	0.95	0.95
PUHY-P250	1.00	0.95	0.84	0.825	0.83	0.87	0.90	0.95	0.95	0.95	0.95
PUHY-P300	1.00	0.93	0.82	0.80	0.82	0.86	0.90	0.90	0.95	0.95	0.95
PUHY-P350	1.00	0.93	0.85	0.83	0.84	0.86	0.90	0.90	0.95	0.95	0.95
PUHY-P400	1.00	0.93	0.85	0.83	0.84	0.86	0.90	0.90	0.95	0.95	0.95

8-2. Correction by temperature

CITY MULTI could have varied capacity at different designing temperature. Using the nominal cooling/heating capacity value and the ratio below, the capacity can be observed at various temperature.

PUHY-		P200YKB-A1	P250YKB-A1
Nominal Cooling Capacity	kW	22.4	28.0
	BTU/h	76,400	95,500
Input	kW	5.19	6.88

Indoor unit temperature correction

To be used to correct indoor unit capacity only

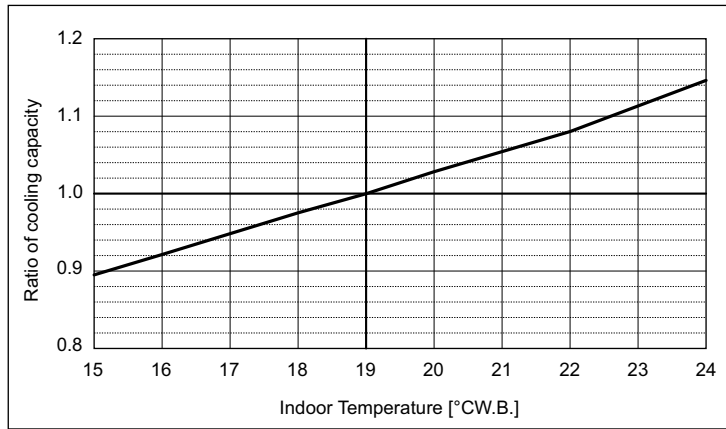

Outdoor unit temperature correction

To be used to correct outdoor unit only

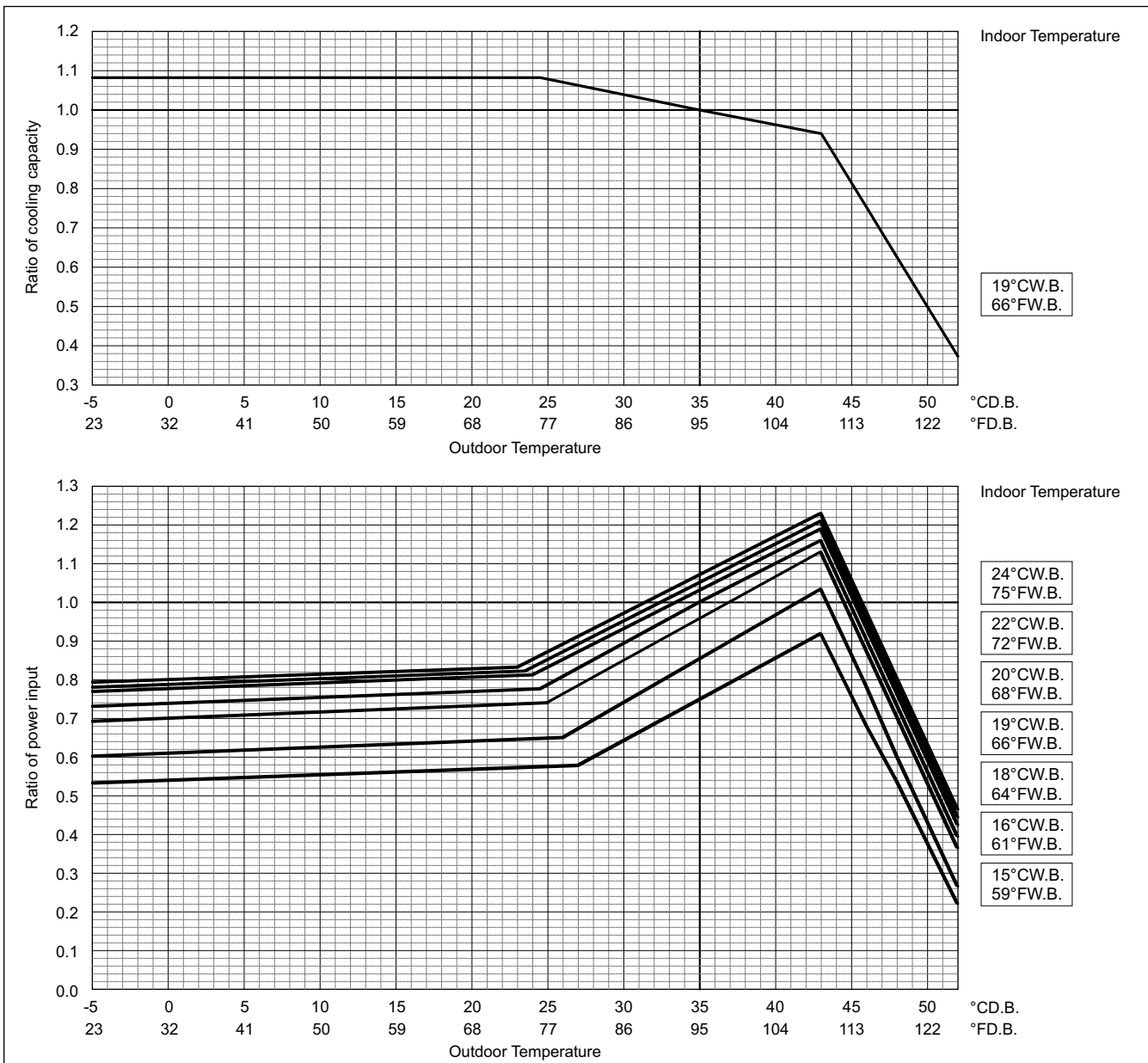

Outdoor unit power input is affected by the indoor and outdoor temperatures as shown in the graph above. Please consult the sales office for details.

PUHY-	P200YKB-A1	P250YKB-A1
Nominal Heating Capacity	kW 25.0	31.5
	BTU/h 85,300	107,500
Input	kW 5.81	7.34

Indoor unit temperature correction

To be used to correct indoor unit capacity only

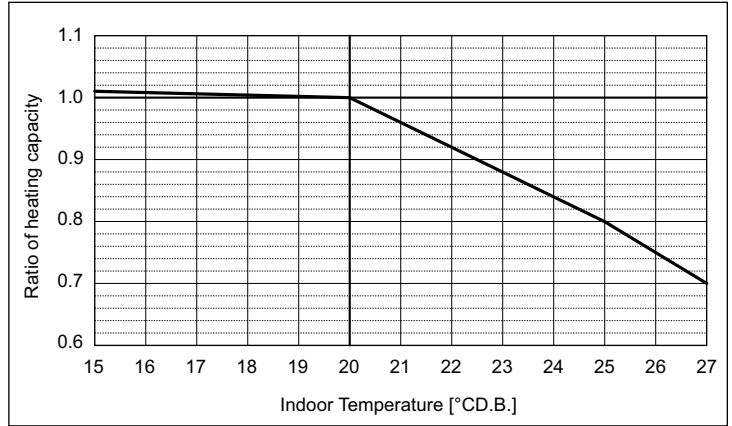

Outdoor unit temperature correction

To be used to correct outdoor unit only

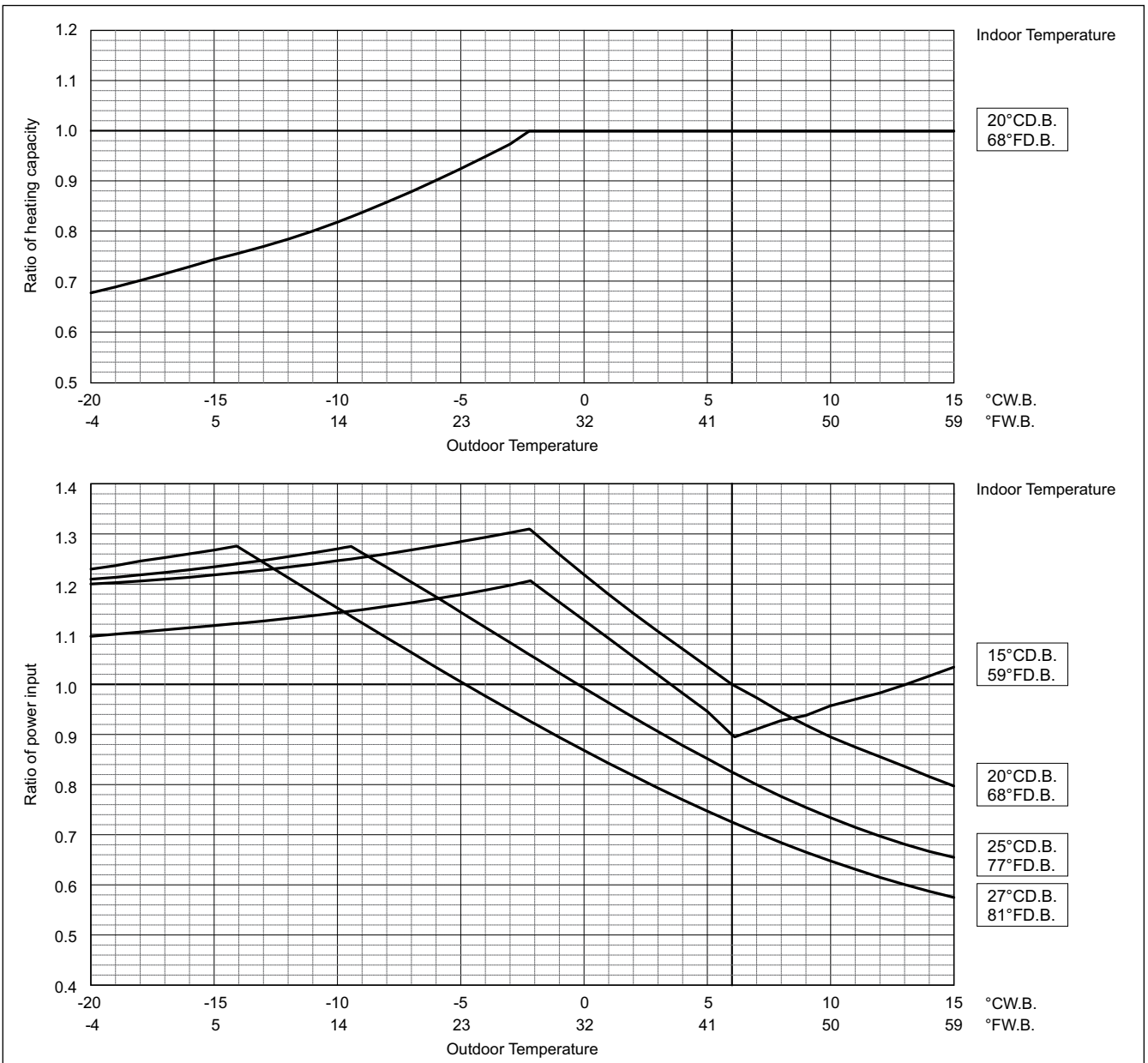

Outdoor unit power input is affected by the indoor and outdoor temperatures as shown in the graph above. Please consult the sales office for details.

Y

PUHY-		P300YKB-A1	P350YKB-A1	P400YKB-A1
Nominal Cooling Capacity	kW	33.5	40.0	45.0
	BTU/h	114,300	136,500	153,500
Input	kW	8.56	11.69	13.55

Indoor unit temperature correction

To be used to correct indoor unit capacity only

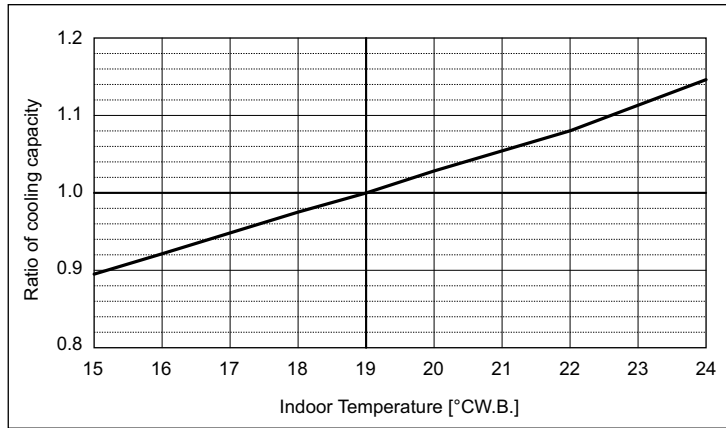

Outdoor unit temperature correction

To be used to correct outdoor unit only

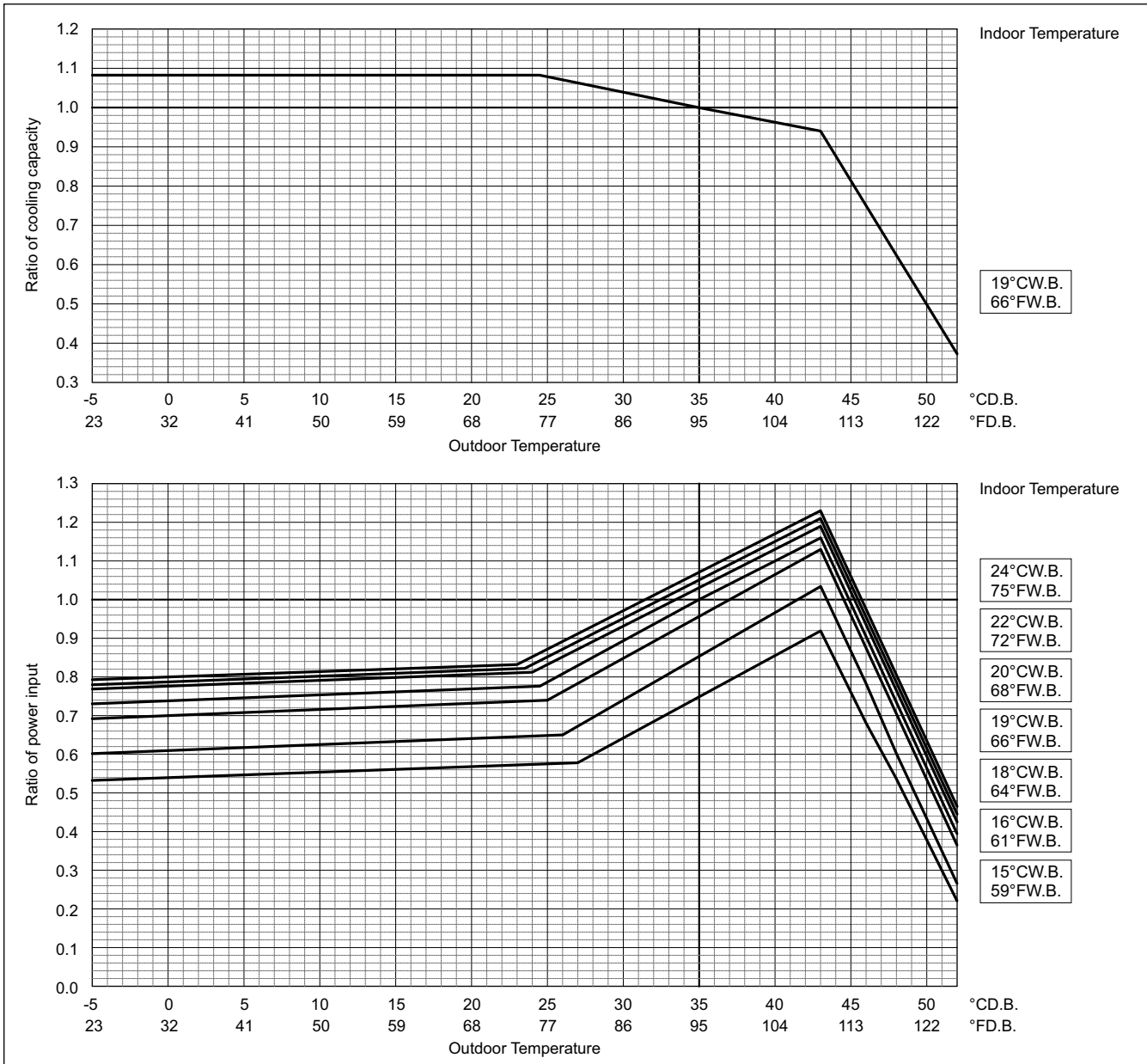

Outdoor unit power input is affected by the indoor and outdoor temperatures as shown in the graph above. Please consult the sales office for details.

PUHY-	P300YKB-A1	P350YKB-A1	P400YKB-A1
Nominal Heating Capacity	kW 37.5	45.0	50.0
	BTU/h 128,000	153,500	170,600
Input	kW 9.07	11.13	12.50

Indoor unit temperature correction

To be used to correct indoor unit capacity only

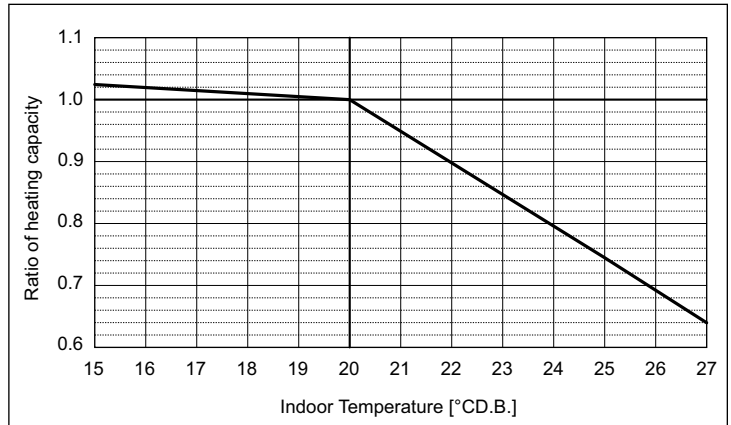

Outdoor unit temperature correction

To be used to correct outdoor unit only

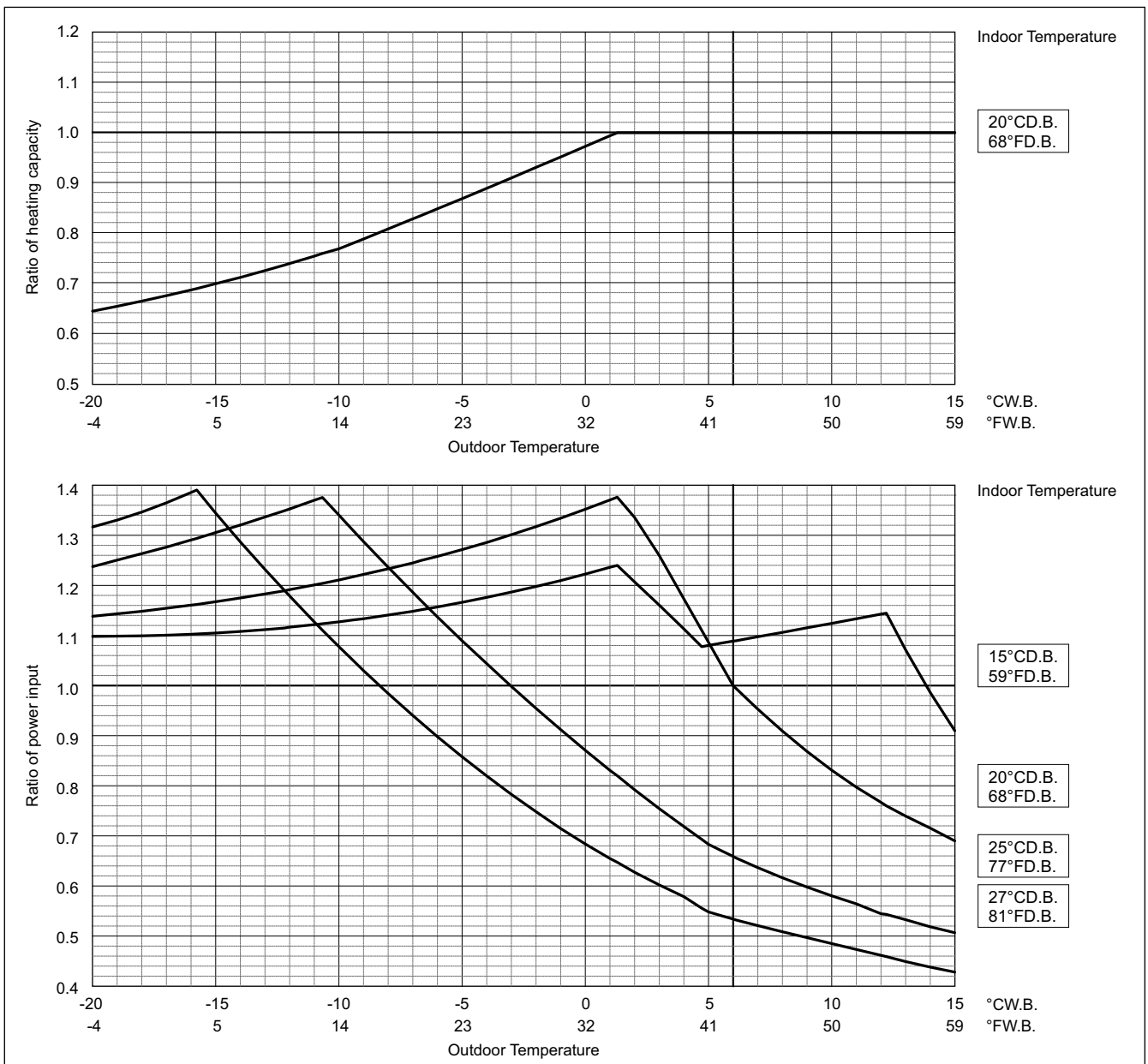

Outdoor unit power input is affected by the indoor and outdoor temperatures as shown in the graph above. Please consult the sales office for details.

Y

PUHY-		P450YKB-A1	P500YKB-A1
Nominal Cooling Capacity	kW	50.0	55.0
	BTU/h	170,600	187,700
Input	kW	14.79	18.39

Indoor unit temperature correction

To be used to correct indoor unit capacity only

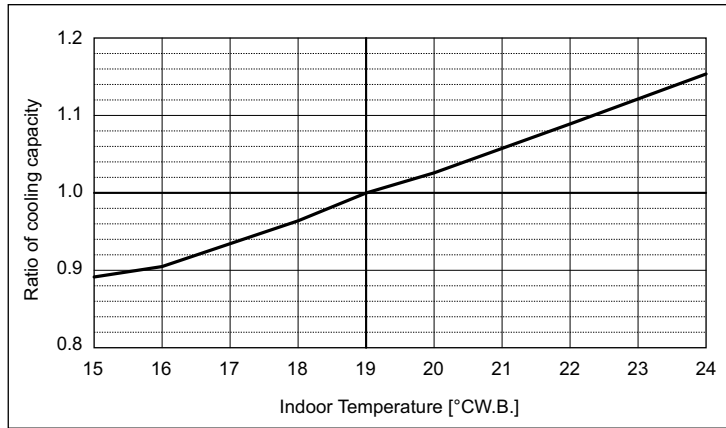

Outdoor unit temperature correction

To be used to correct outdoor unit only

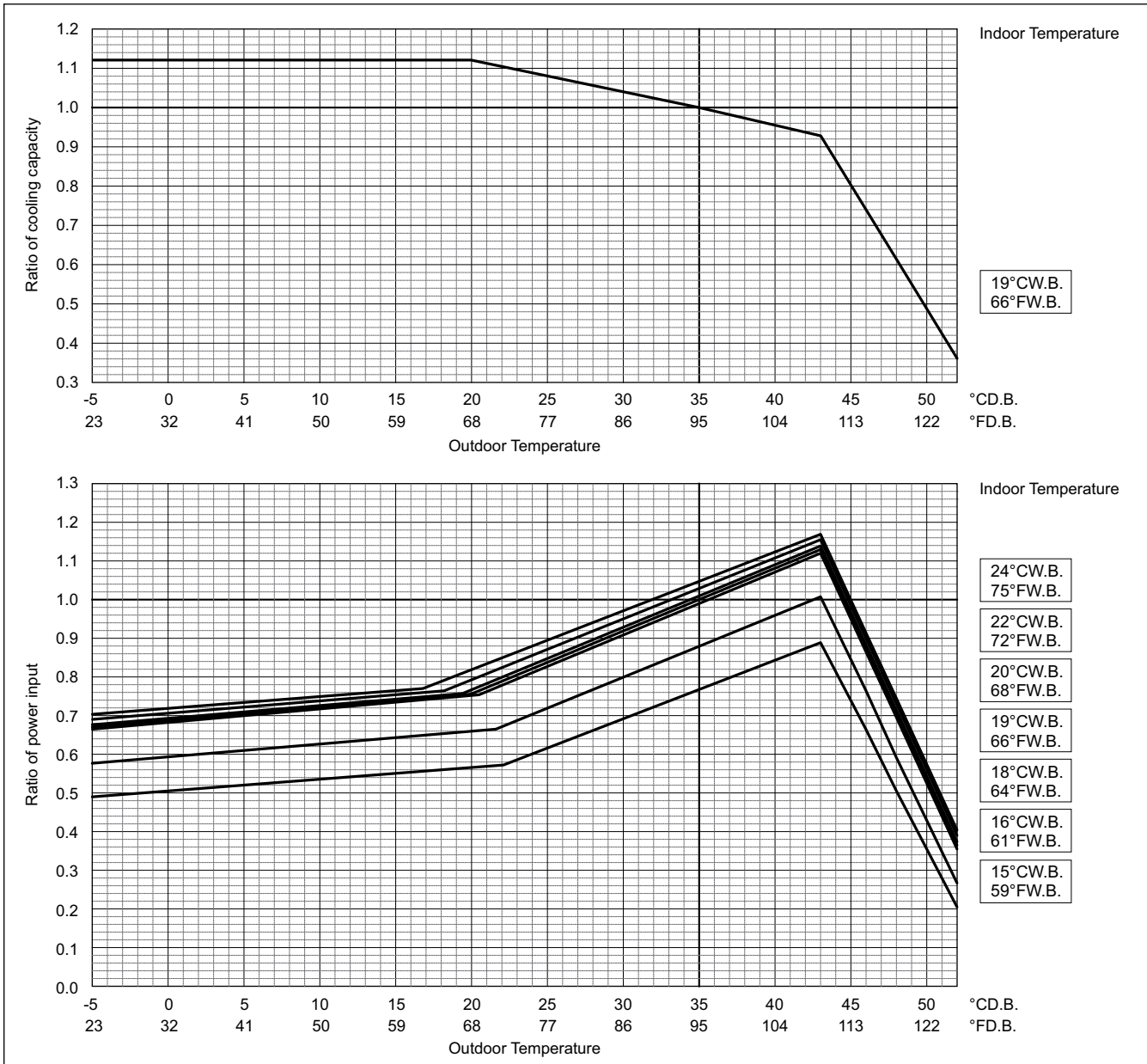

Outdoor unit power input is affected by the indoor and outdoor temperatures as shown in the graph above. Please consult the sales office for details.

PUHY-	P450YKB-A1	P500YKB-A1
Nominal Heating Capacity	kW 56.0	63.0
	BTU/h 191,100	215,000
Input	kW 15.55	18.52

Indoor unit temperature correction
To be used to correct indoor unit capacity only

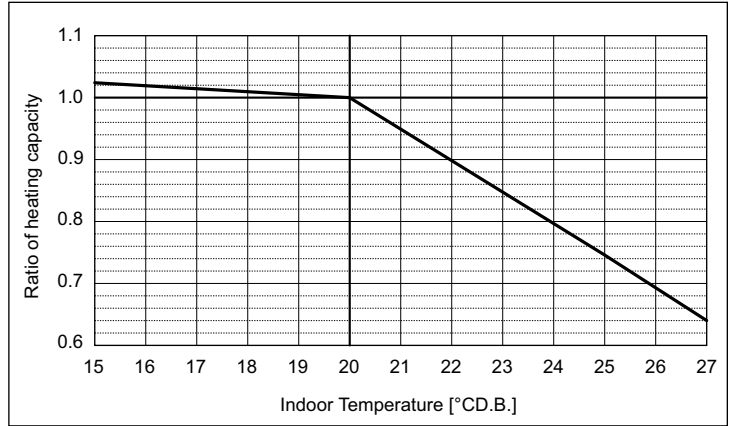

Outdoor unit temperature correction
To be used to correct outdoor unit only

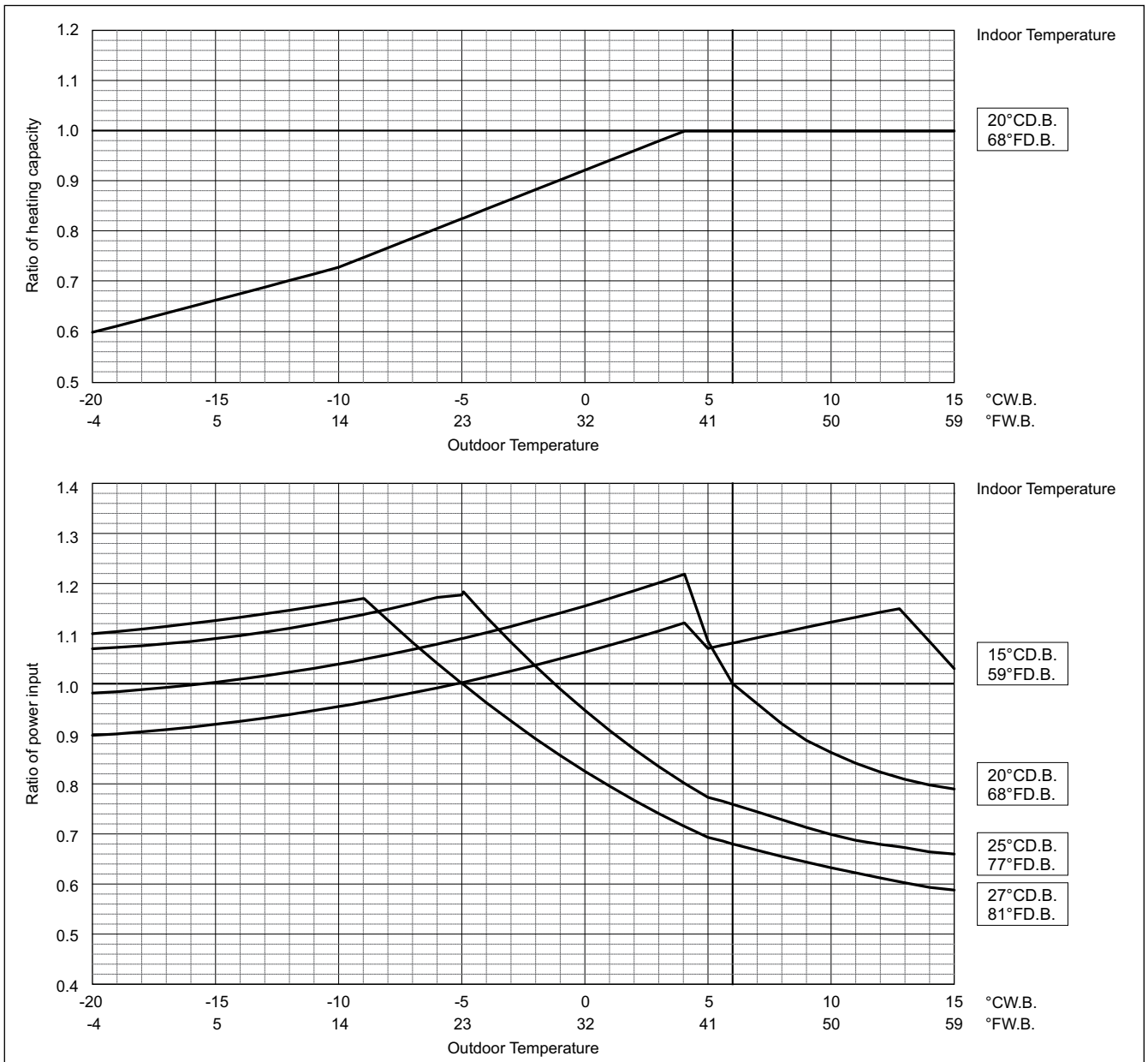

Outdoor unit power input is affected by the indoor and outdoor temperatures as shown in the graph above. Please consult the sales office for details.

8. CAPACITY TABLES

Y

PUHY-		P400YSKB-A1	P450YSKB-A1	P500YSKB-A1
Nominal Cooling Capacity	kW	45.0	50.0	56.0
	BTU/h	153,500	170,600	191,100
Input	kW	11.0	12.59	14.54

PUHY-		P550YSKB-A1	P600YSKB-A1	P650YSKB-A1
Nominal Cooling Capacity	kW	63.0	69.0	73.0
	BTU/h	215,000	235,400	249,100
Input	kW	16.66	19.43	20.97

Indoor unit temperature correction
To be used to correct indoor unit capacity only

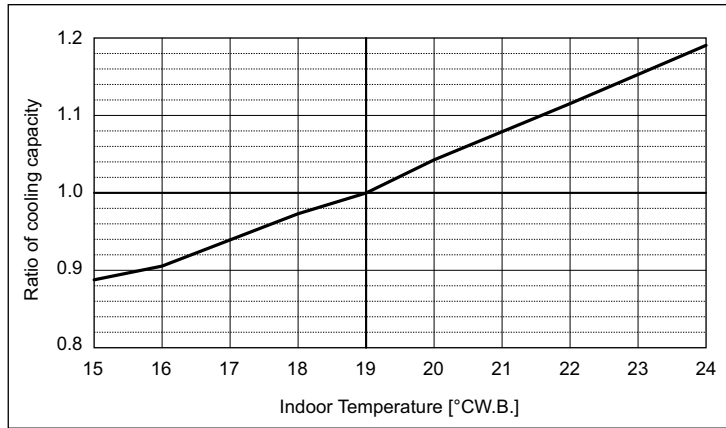

Outdoor unit temperature correction
To be used to correct outdoor unit only

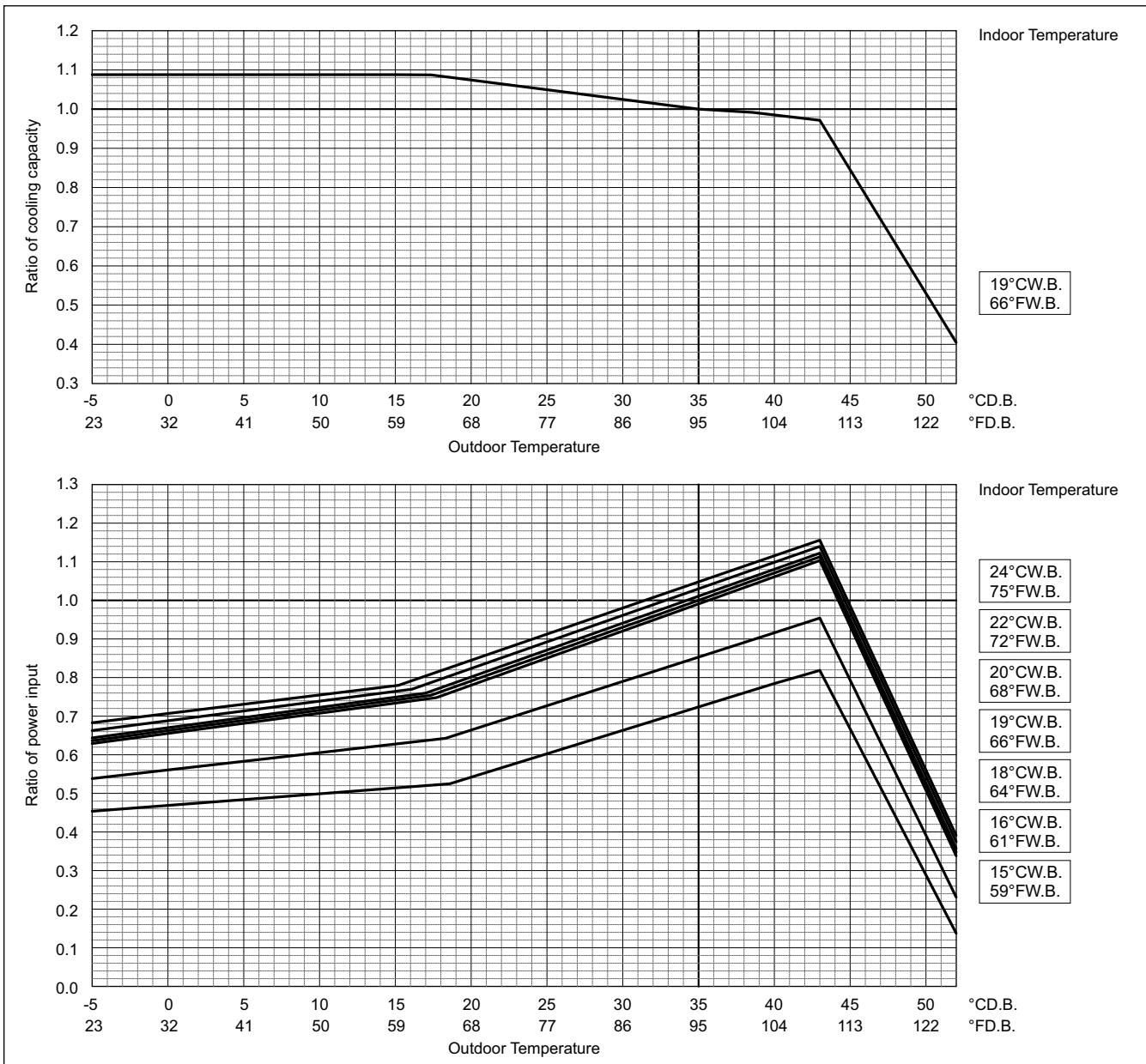

Outdoor unit power input is affected by the indoor and outdoor temperatures as shown in the graph above. Please consult the sales office for details.

8. CAPACITY TABLES

PUHY-		P400YSKB-A1	P450YSKB-A1	P500YSKB-A1
Nominal Heating Capacity	kW	50.0	56.0	63.0
	BTU/h	170,600	191,100	215,000
Input	kW	12.24	13.72	15.46

PUHY-		P550YSKB-A1	P600YSKB-A1	P650YSKB-A1
Nominal Cooling Capacity	kW	69.0	76.5	81.5
	BTU/h	235,400	261,000	278,100
Input	kW	17.29	19.36	21.00

Indoor unit temperature correction

To be used to correct indoor unit capacity only

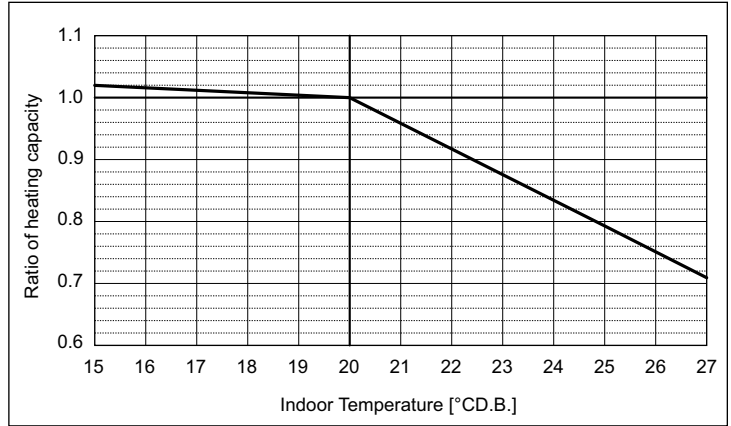

Outdoor unit temperature correction

To be used to correct outdoor unit only

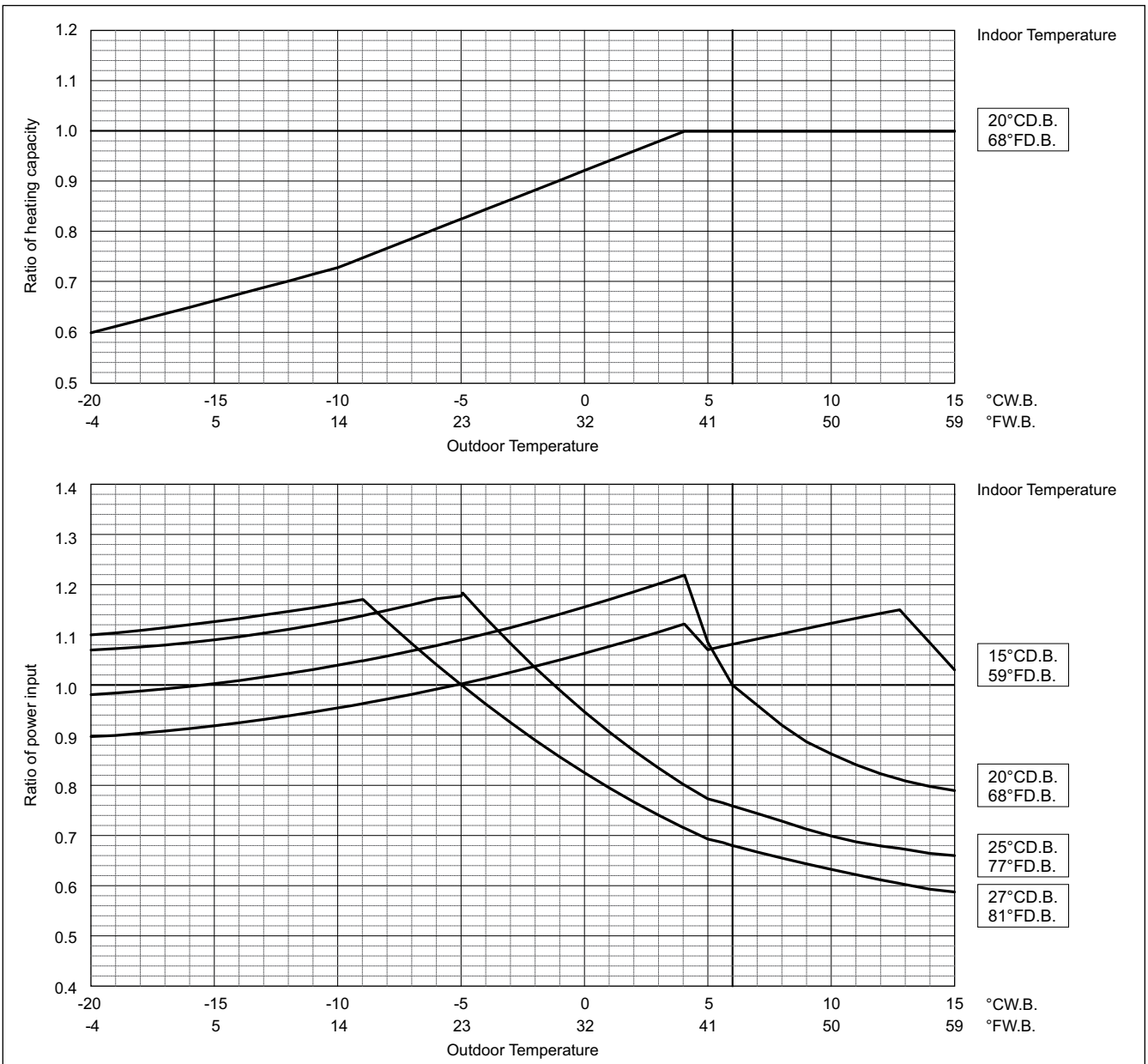

Outdoor unit power input is affected by the indoor and outdoor temperatures as shown in the graph above. Please consult the sales office for details.

Y

PUHY-		P700YSKB-A1	P750YSKB-A1	P800YSKB-A1
Nominal Cooling Capacity	kW	80.0	85.0	90.0
	BTU/h	273,000	290,000	307,100
Input	kW	24.69	26.56	27.86

Indoor unit temperature correction

To be used to correct indoor unit capacity only

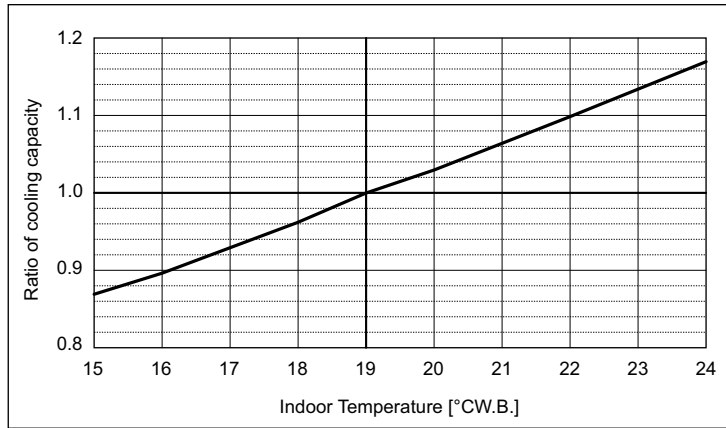

Outdoor unit temperature correction

To be used to correct outdoor unit only

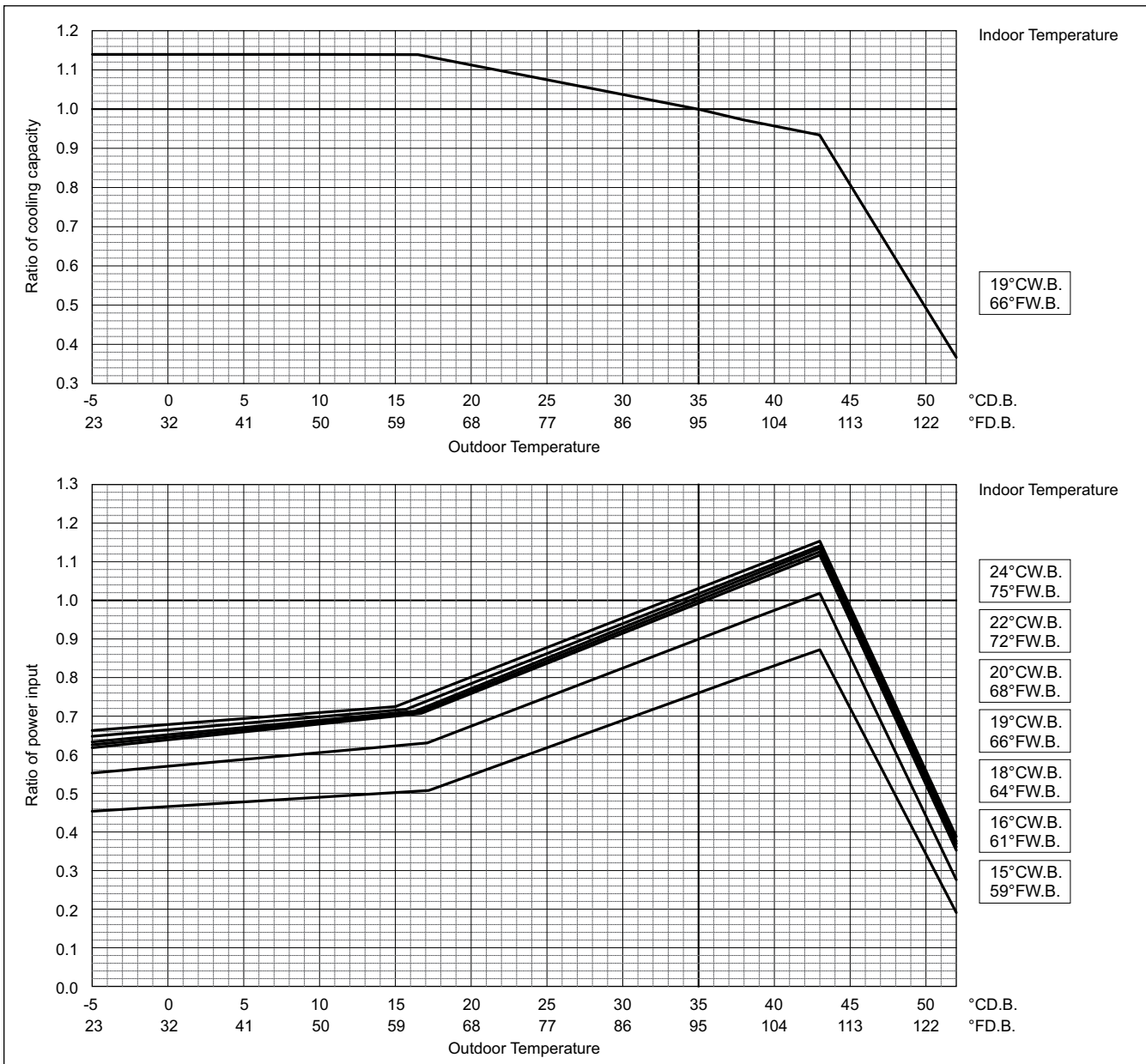

Outdoor unit power input is affected by the indoor and outdoor temperatures as shown in the graph above. Please consult the sales office for details.

PUHY-	P700YSKB-A1	P750YSKB-A1	P800YSKB-A1
Nominal Heating Capacity	kW 88.0	95.0	100.0
	BTU/h 300,300	324,100	341,200
Input	kW 22.97	24.93	27.62

Indoor unit temperature correction

To be used to correct indoor unit capacity only

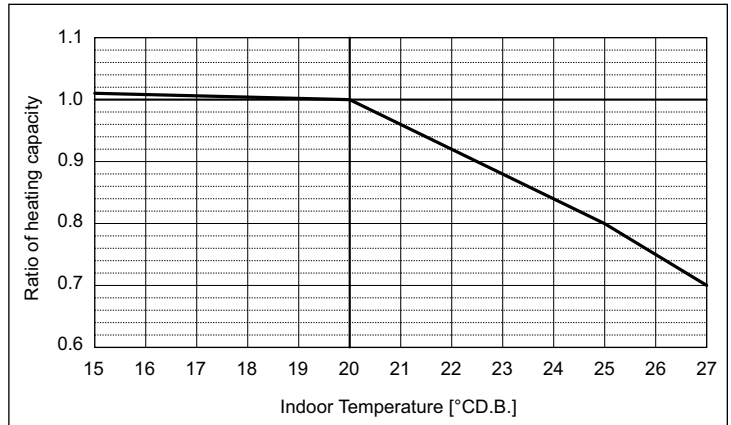

Outdoor unit temperature correction

To be used to correct outdoor unit only

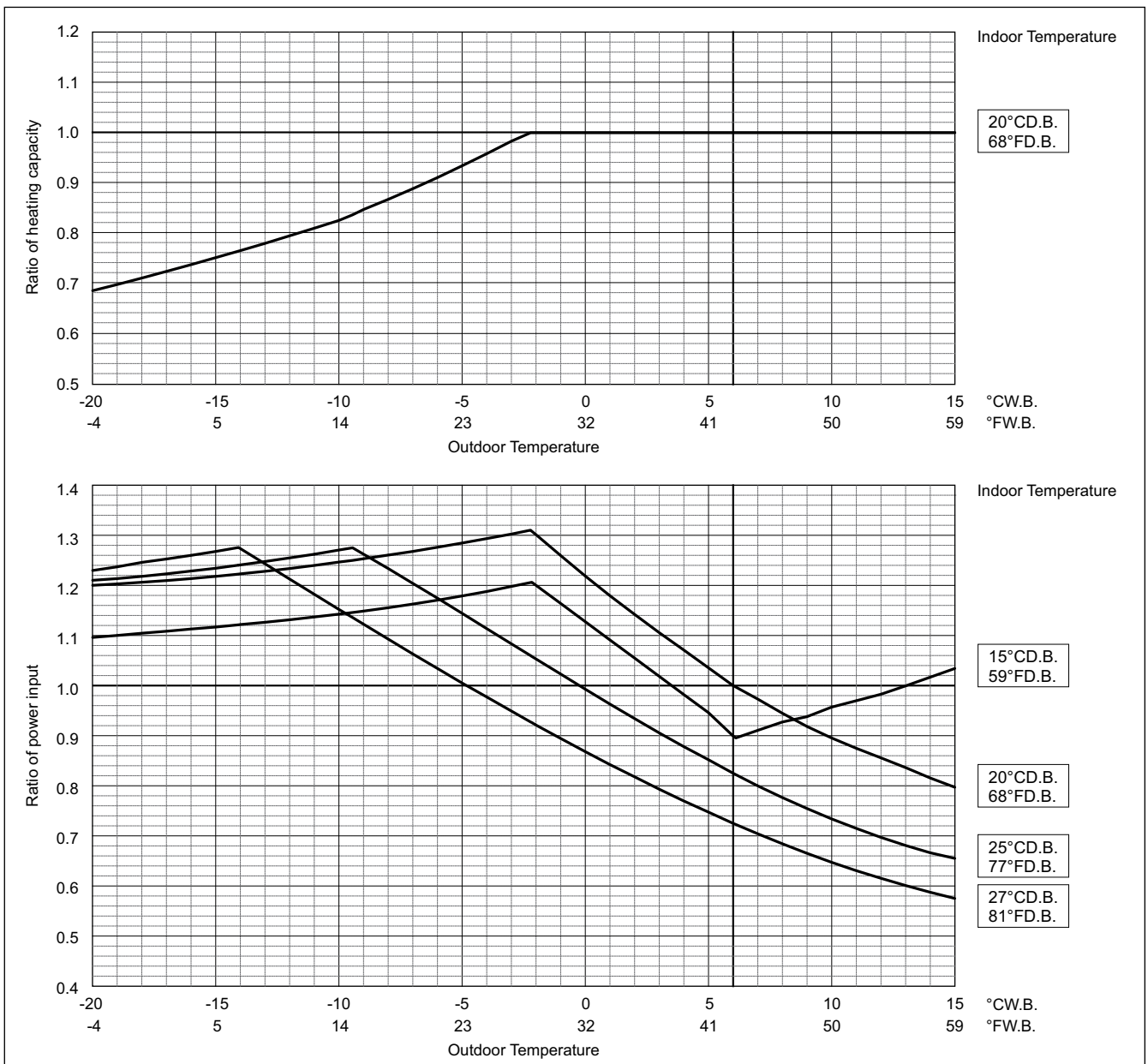

Outdoor unit power input is affected by the indoor and outdoor temperatures as shown in the graph above. Please consult the sales office for details.

PUHY-		P850YSKB-A1	P900YSKB-A1	P950YSKB-A1
Nominal Cooling Capacity	kW	96.0	101.0	108.0
	BTU/h	327,600	344,600	368,500
Input	kW	30.18	31.46	30.25

PUHY-		P1000YSKB-A1	P1050YSKB-A1	P1100YSKB-A1
Nominal Cooling Capacity	kW	113.0	118.0	124.0
	BTU/h	385,600	402,600	423,100
Input	kW	32.10	35.01	38.62

PUHY-		P1150YSKB-A1	P1200YSKB-A1	P1250YSKB-A1
Nominal Cooling Capacity	kW	130.0	136.0	140.0
	BTU/h	443,600	464,000	477,700
Input	kW	40.24	44.10	43.80

PUHY-		P1300YSKB-A1	P1350YSKB-A1
Nominal Cooling Capacity	kW	146.0	150.0
	BTU/h	498,200	511,800
Input	kW	47.80	47.40

Indoor unit temperature correction
To be used to correct indoor unit capacity only

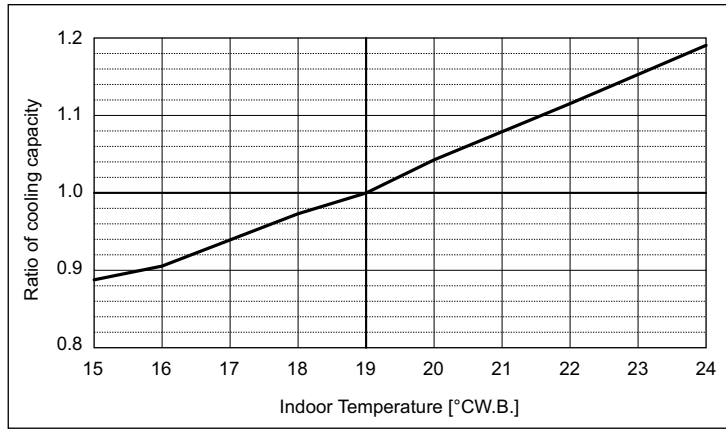

Outdoor unit temperature correction
To be used to correct outdoor unit only

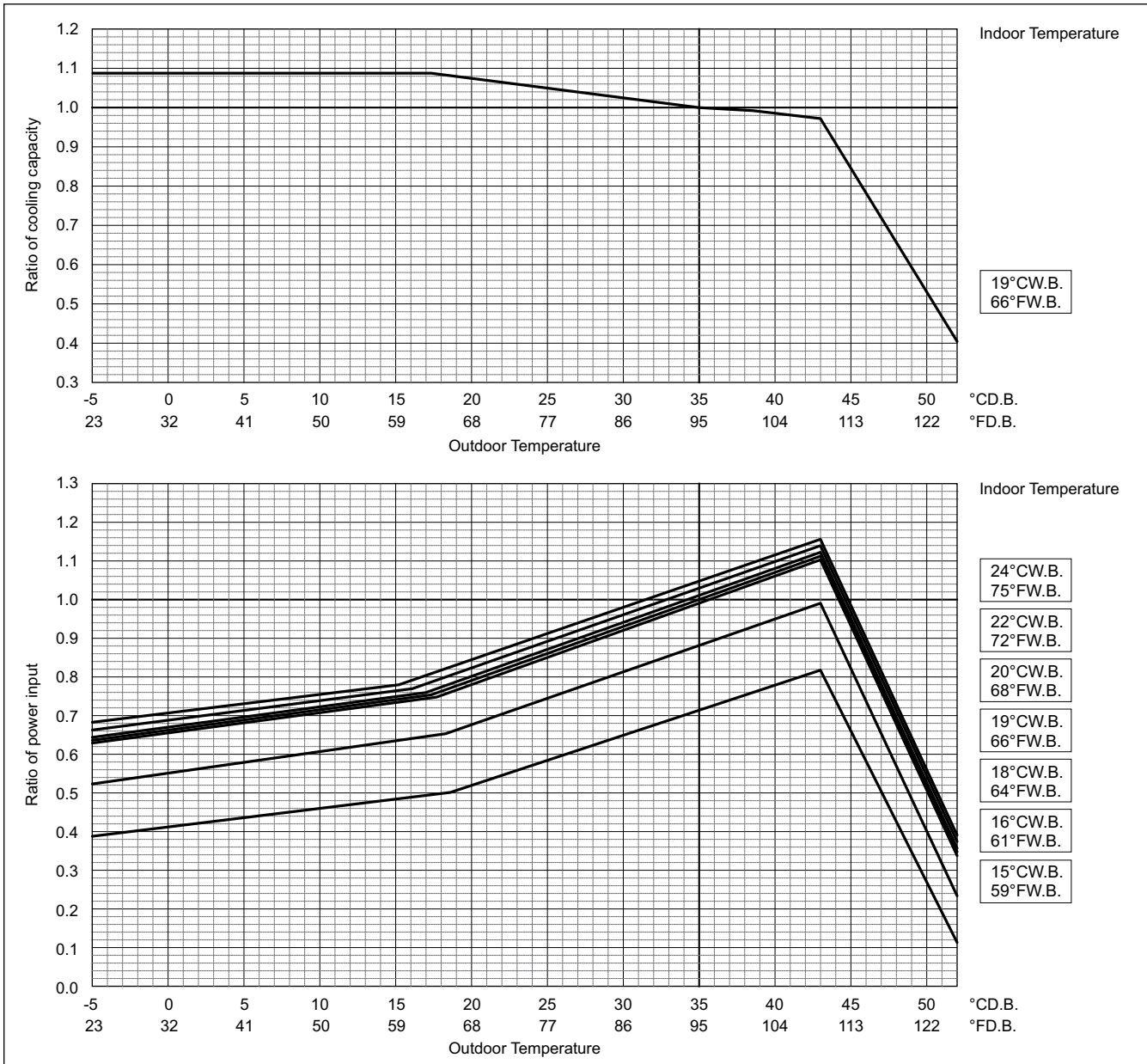

Outdoor unit power input is affected by the indoor and outdoor temperatures as shown in the graph above. Please consult the sales office for details.

PUHY-	P850YSKB-A1	P900YSKB-A1	P950YSKB-A1
Nominal Heating Capacity	kW 108.0	113.0	119.5
	BTU/h 368,500	385,600	407,700
Input	kW 29.90	33.00	30.40

PUHY-	P1000YSKB-A1	P1050YSKB-A1	P1100YSKB-A1
Nominal Heating Capacity	kW 127.0	132.0	140.0
	BTU/h 433,300	450,400	477,700
Input	kW 32.70	34.25	36.60

PUHY-	P1150YSKB-A1	P1200YSKB-A1	P1250YSKB-A1
Nominal Heating Capacity	kW 145.0	150.0	156.5
	BTU/h 494,700	511,800	534,000
Input	kW 39.29	40.76	44.08

PUHY-	P1300YSKB-A1	P1350YSKB-A1
Nominal Heating Capacity	kW 163.0	168.0
	BTU/h 556,200	573,200
Input	kW 46.04	49.12

Indoor unit temperature correction
To be used to correct indoor unit capacity only

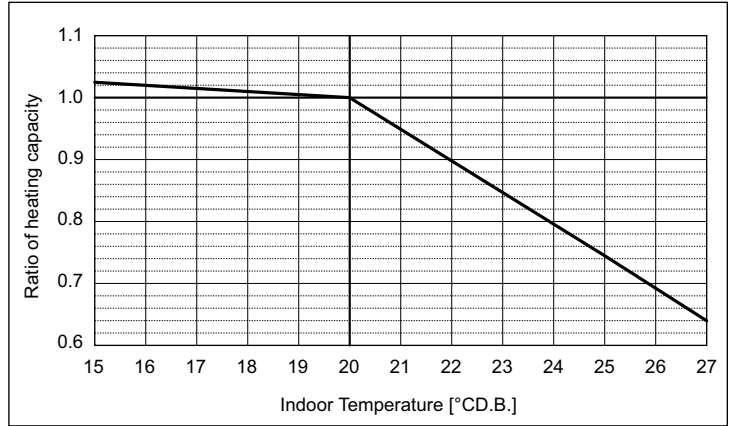

Outdoor unit temperature correction
To be used to correct outdoor unit only

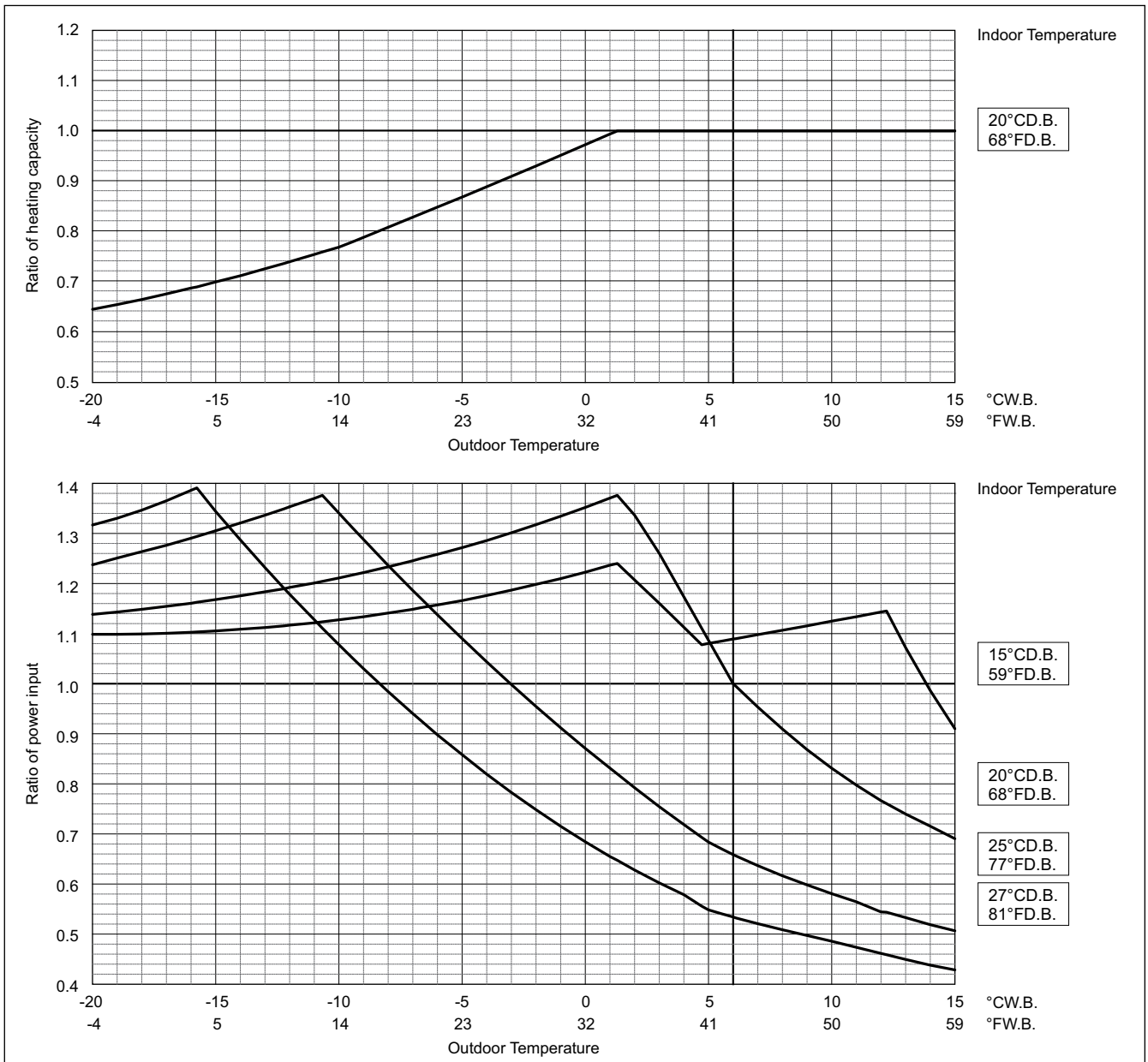

Outdoor unit power input is affected by the indoor and outdoor temperatures as shown in the graph above. Please consult the sales office for details.

Correction by temperature (COP Priority Mode)

CITY MULTI could have various capacities at different designing temperatures. Using the nominal cooling/heating capacity values and the ratios below, the capacity can be found for various temperatures. To select COP priority mode, DipSW 6-2 must be set to ON.

PUHY-		P200YKB-A1	P250YKB-A1
Nominal Cooling Capacity	kW	22.4	28.0
	BTU/h	76,400	95,500
Input	kW	5.19	6.88

Indoor unit temperature correction

To be used to correct indoor unit capacity only

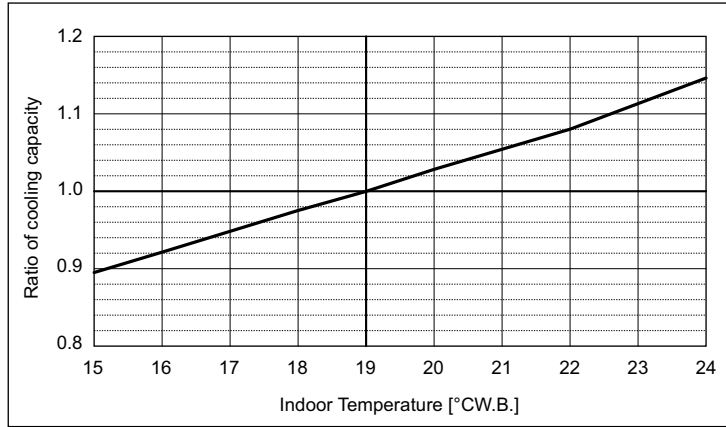

Outdoor unit temperature correction

To be used to correct outdoor unit only

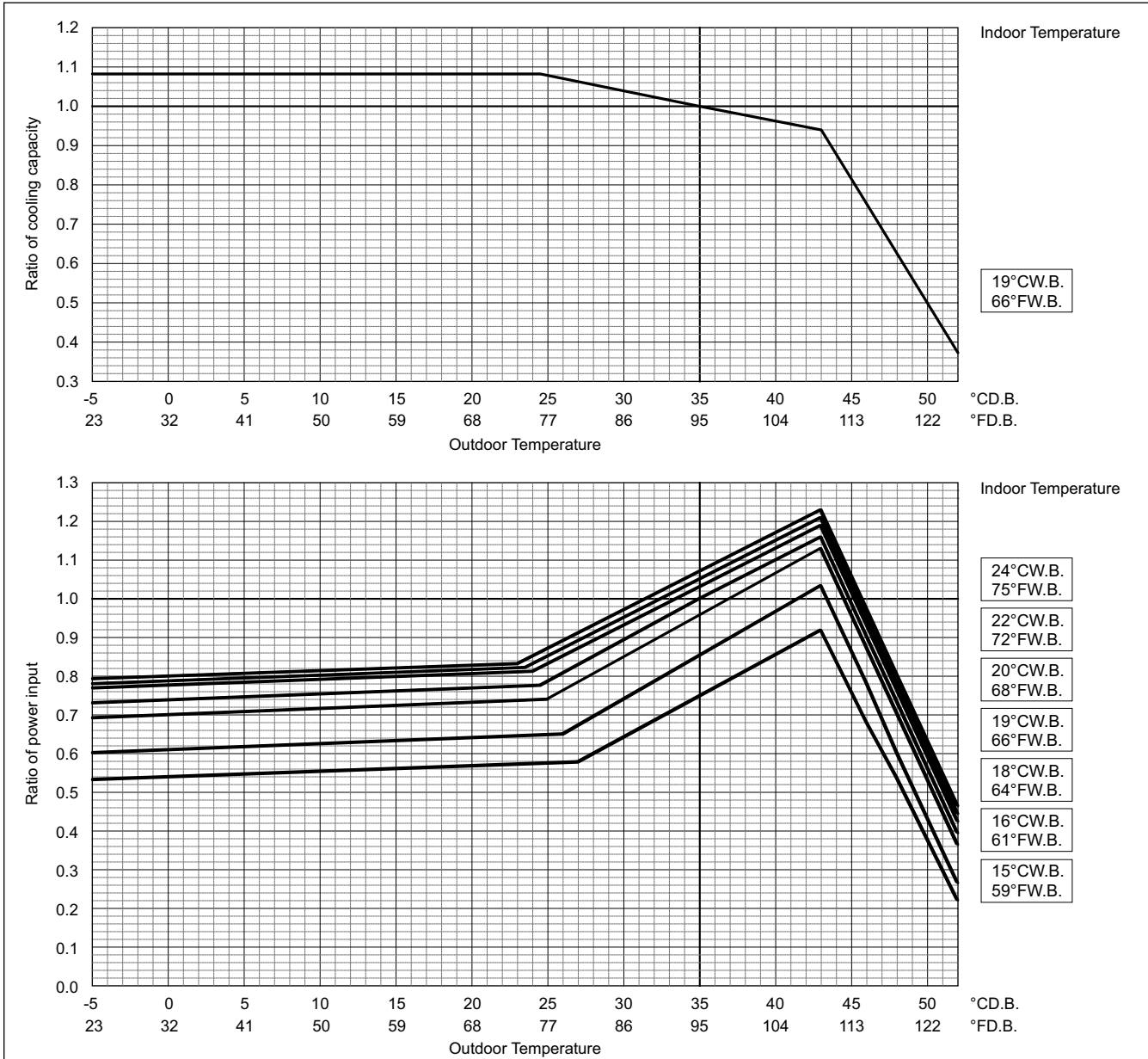

Outdoor unit power input is affected by the indoor and outdoor temperatures as shown in the graph above. Please consult the sales office for details.

PUHY-	P200YKB-A1	P250YKB-A1
Nominal Heating Capacity	kW 25.0	31.5
	BTU/h 85,300	107,500
Input	kW 5.81	7.34

Indoor unit temperature correction

To be used to correct indoor unit capacity only

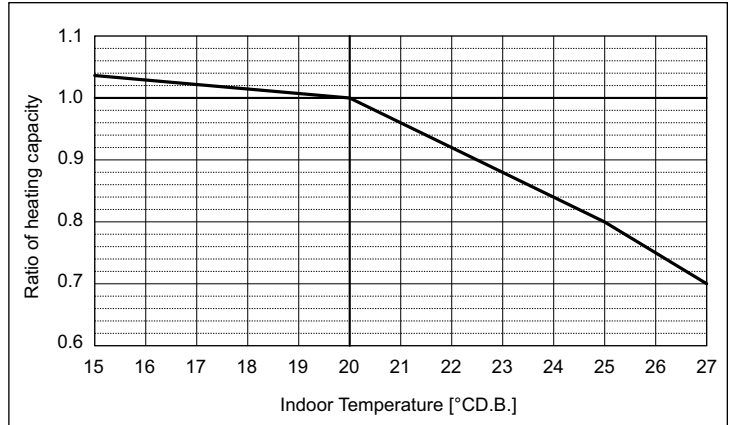

Outdoor unit temperature correction

To be used to correct outdoor unit only

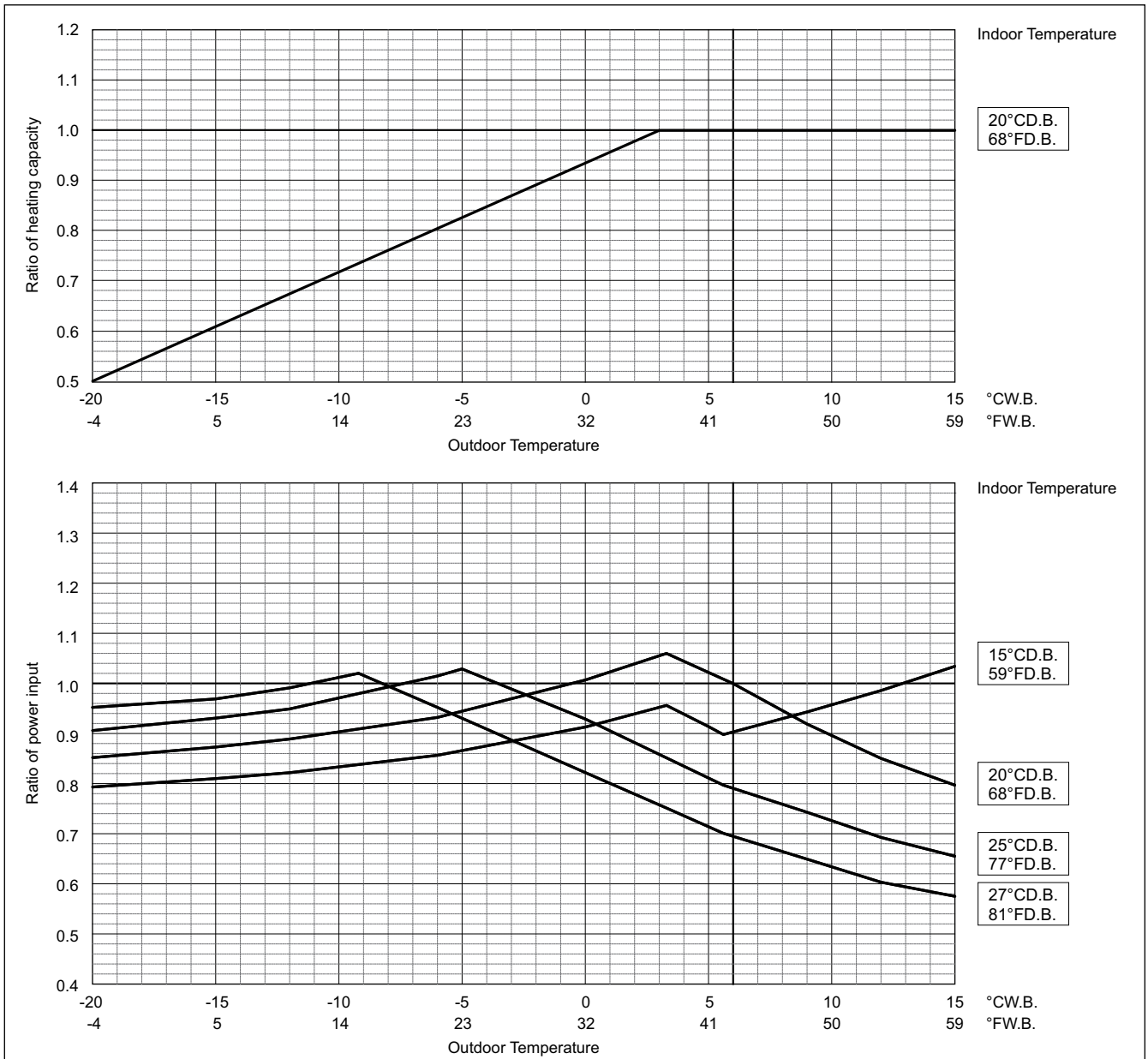

Outdoor unit power input is affected by the indoor and outdoor temperatures as shown in the graph above. Please consult the sales office for details.

Y

PUHY-	P300YKB-A1	P350YKB-A1	P400YKB-A1	
Nominal Cooling Capacity	kW	33.5	40.0	45.0
	BTU/h	114,300	136,500	153,500
Input	kW	8.56	11.69	13.55

Indoor unit temperature correction

To be used to correct indoor unit capacity only

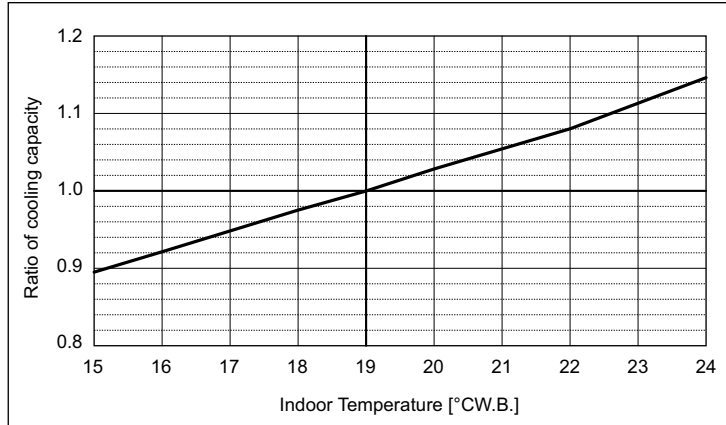

Outdoor unit temperature correction

To be used to correct outdoor unit only

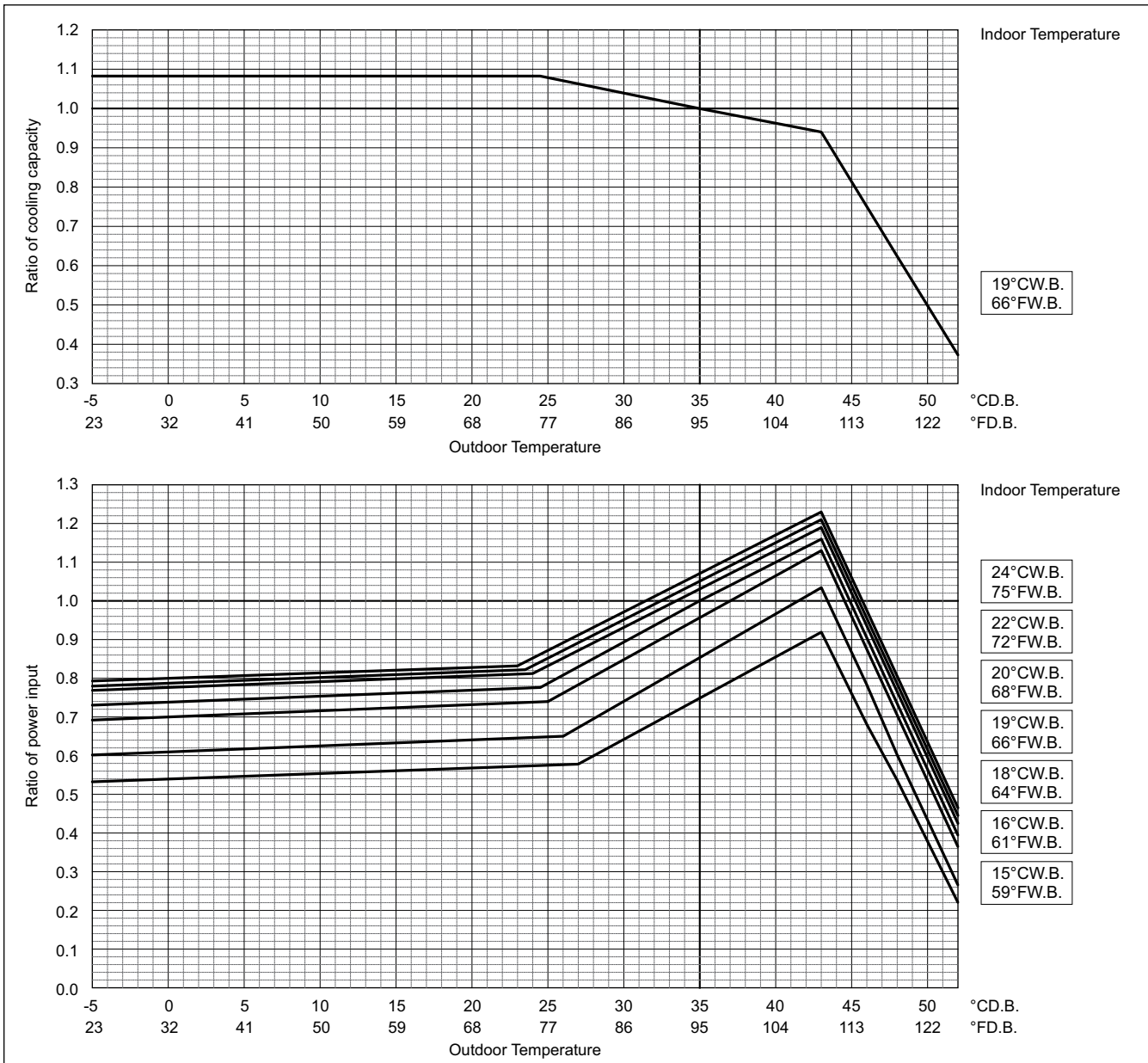

Outdoor unit power input is affected by the indoor and outdoor temperatures as shown in the graph above. Please consult the sales office for details.

PUHY-	P300YKB-A1	P350YKB-A1	P400YKB-A1
Nominal Heating Capacity	kW 37.5	45.0	50.0
	BTU/h 128,000	153,500	170,600
Input	kW 9.07	11.13	12.50

Indoor unit temperature correction

To be used to correct indoor unit capacity only

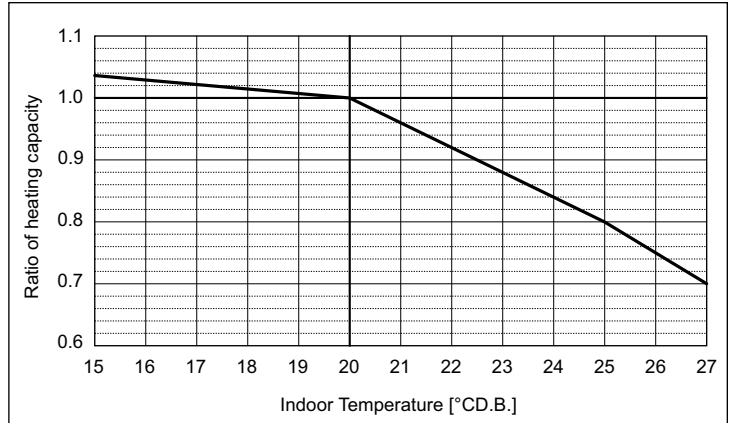

Outdoor unit temperature correction

To be used to correct outdoor unit only

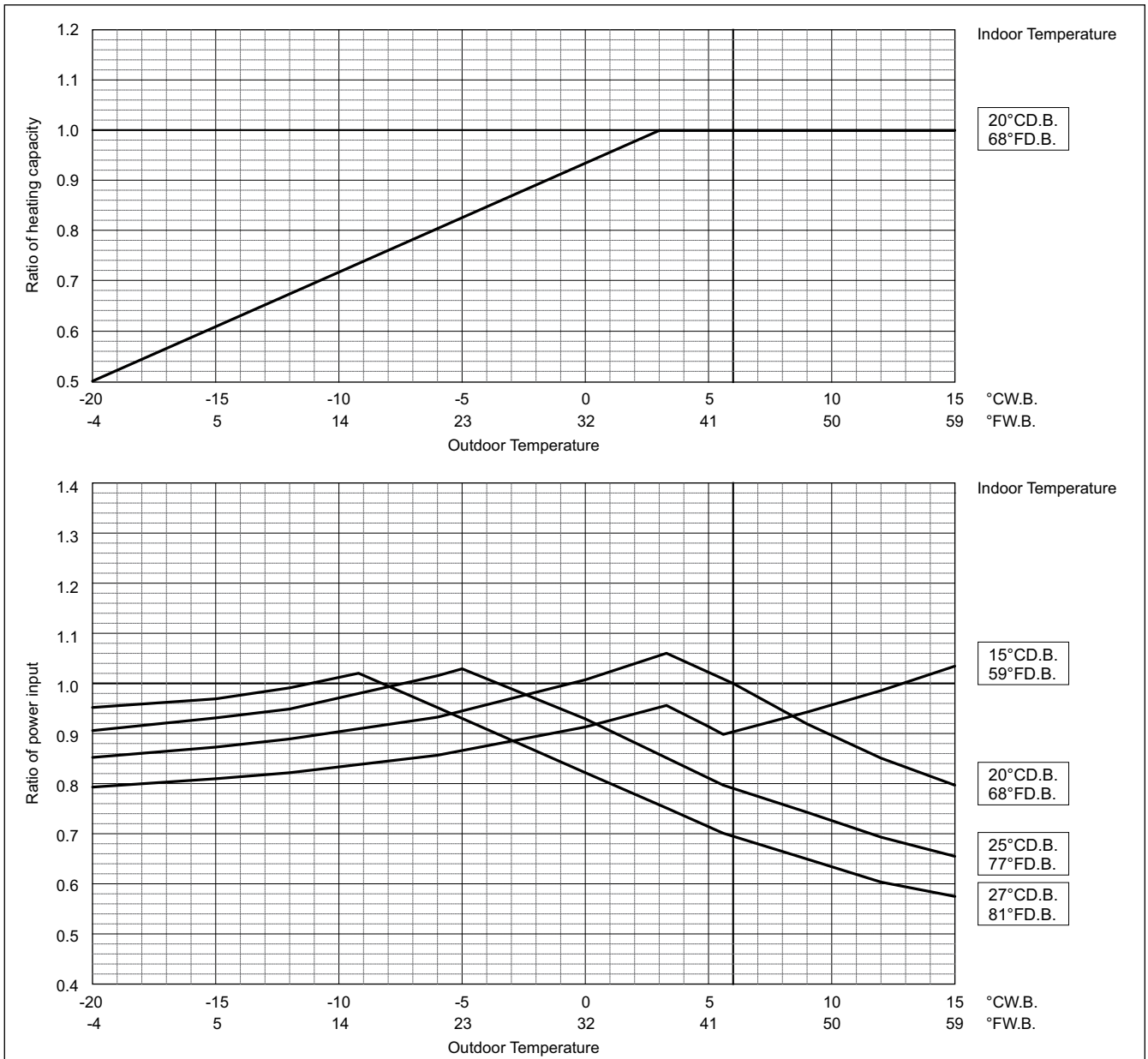

Outdoor unit power input is affected by the indoor and outdoor temperatures as shown in the graph above. Please consult the sales office for details.

8. CAPACITY TABLES

YKB/YLM

Y

PUHY-		P450YKB-A1	P500YKB-A1
Nominal Cooling Capacity	kW	50.0	55.0
	BTU/h	170,600	187,700
Input	kW	14.79	18.39

Indoor unit temperature correction

To be used to correct indoor unit capacity only

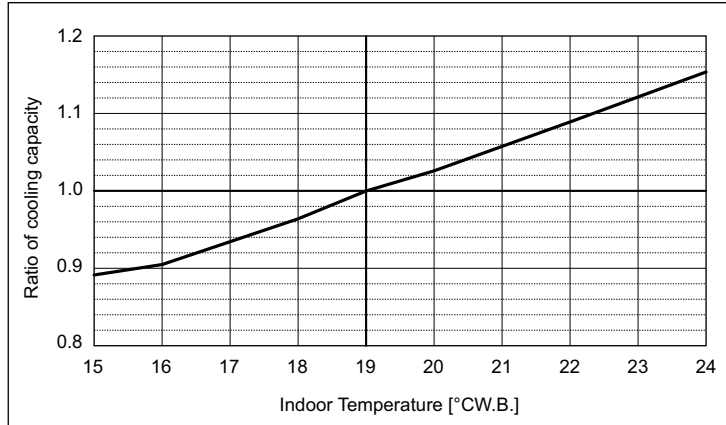

Outdoor unit temperature correction

To be used to correct outdoor unit only

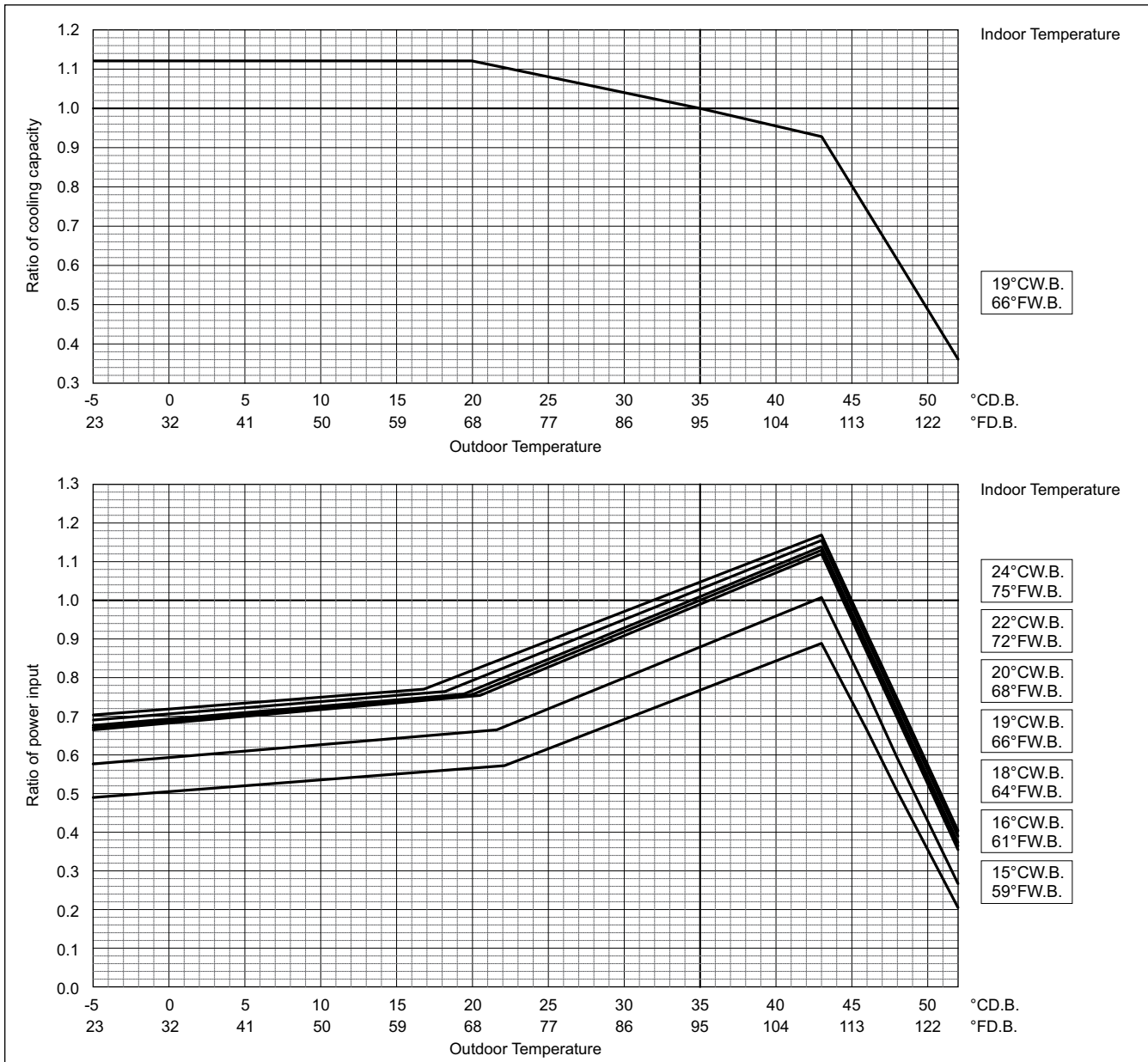

Outdoor unit power input is affected by the indoor and outdoor temperatures as shown in the graph above. Please consult the sales office for details.

PUHY-	P450YKB-A1	P500YKB-A1
Nominal Heating Capacity	kW 56.0	63.0
	BTU/h 191,100	215,000
Input	kW 15.55	18.52

Indoor unit temperature correction

To be used to correct indoor unit capacity only

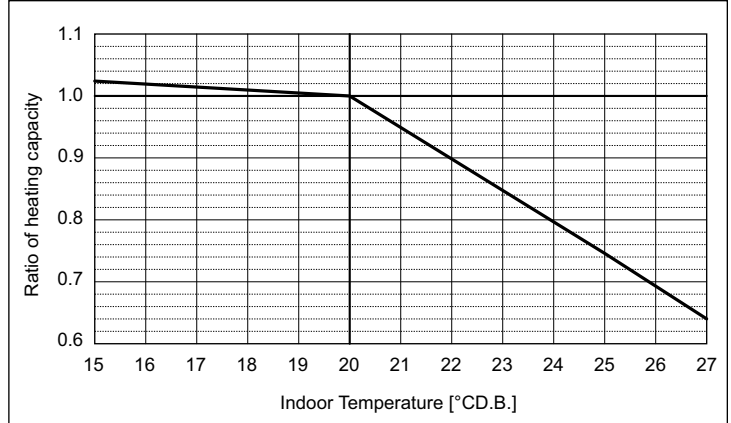

Outdoor unit temperature correction

To be used to correct outdoor unit only

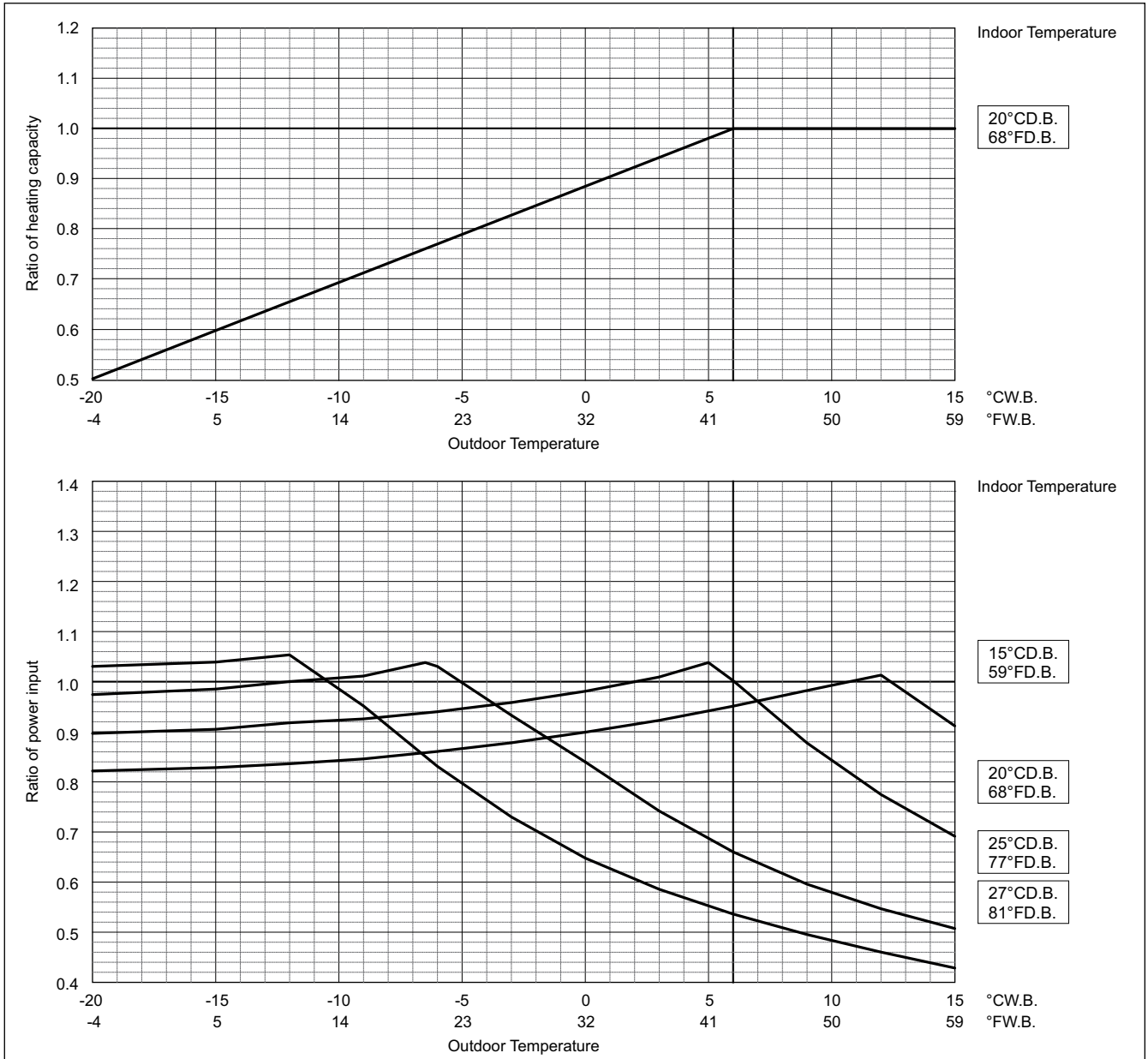

Outdoor unit power input is affected by the indoor and outdoor temperatures as shown in the graph above. Please consult the sales office for details.

8. CAPACITY TABLES

Y

PUHY-		P400YSKB-A1	P450YSKB-A1	P500YSKB-A1
Nominal Cooling Capacity	kW	45.0	50.0	56.0
	BTU/h	153,500	170,600	191,100
Input	kW	11.0	12.59	14.54

PUHY-		P550YSKB-A1	P600YSKB-A1	P650YSKB-A1
Nominal Cooling Capacity	kW	63.0	69.0	73.0
	BTU/h	215,000	235,400	249,100
Input	kW	16.66	19.43	20.97

Indoor unit temperature correction

To be used to correct indoor unit capacity only

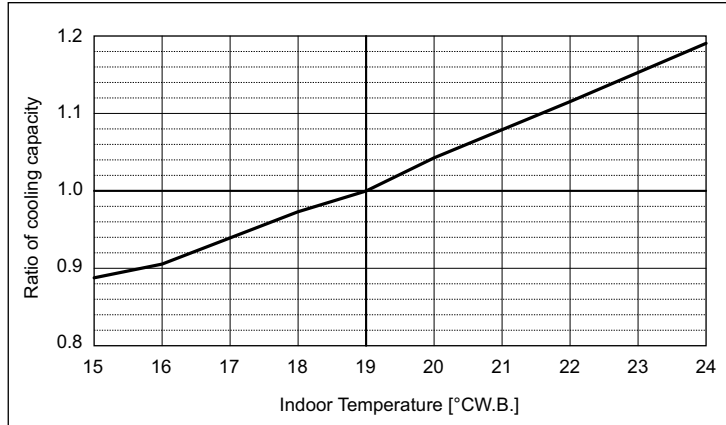

Outdoor unit temperature correction

To be used to correct outdoor unit only

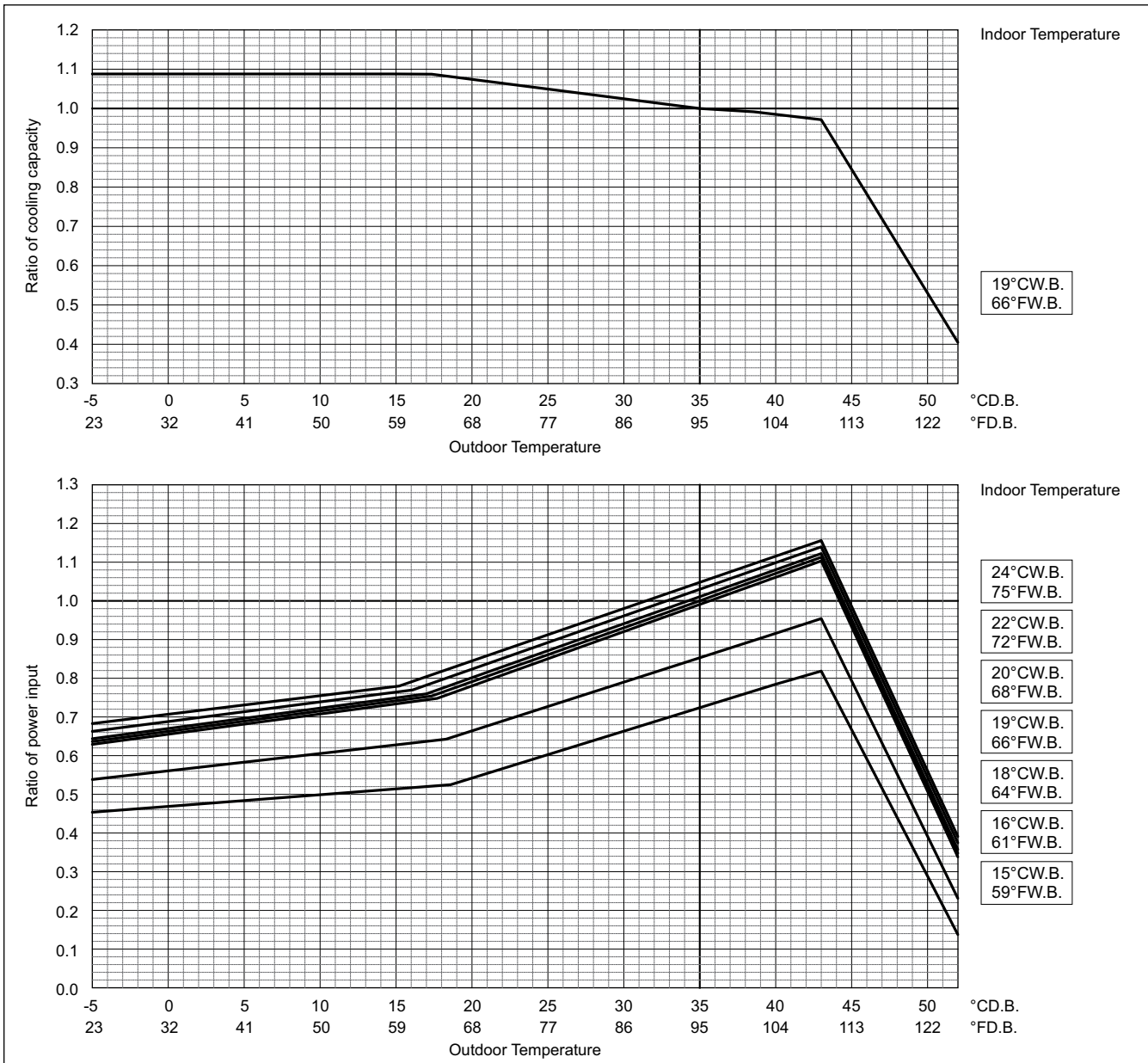

Outdoor unit power input is affected by the indoor and outdoor temperatures as shown in the graph above. Please consult the sales office for details.

PUHY-		P400YSKB-A1	P450YSKB-A1	P500YSKB-A1
Nominal Heating Capacity	kW	50.0	56.0	63.0
	BTU/h	170,600	191,100	215,000
Input	kW	12.24	13.72	15.46

PUHY-		P550YSKB-A1	P600YSKB-A1	P650YSKB-A1
Nominal Heating Capacity	kW	69.0	76.5	81.5
	BTU/h	235,400	261,000	278,100
Input	kW	17.29	19.36	21.00

Indoor unit temperature correction
To be used to correct indoor unit capacity only

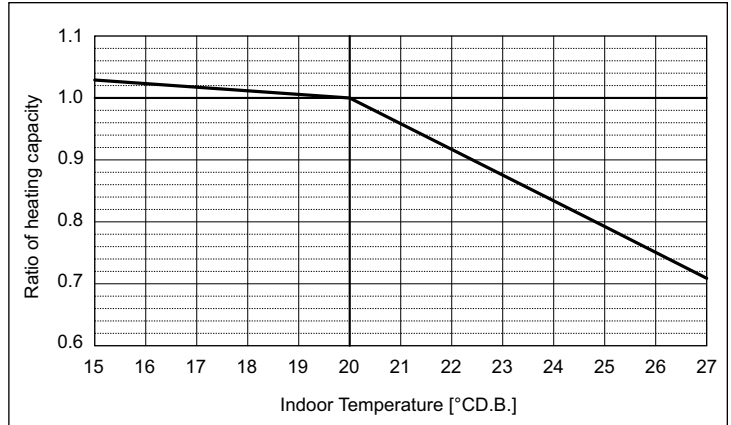

Outdoor unit temperature correction
To be used to correct outdoor unit only

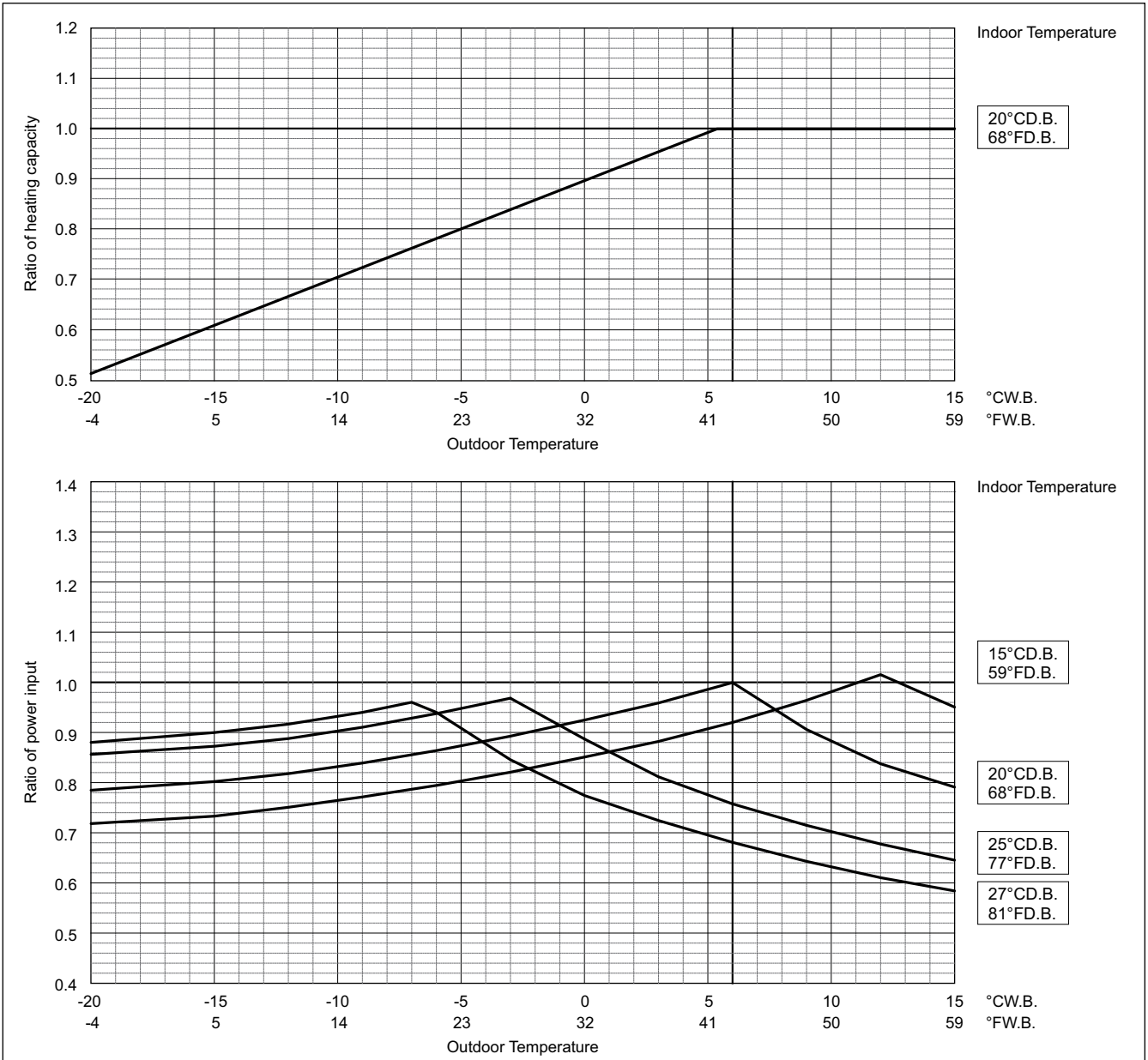

Outdoor unit power input is affected by the indoor and outdoor temperatures as shown in the graph above. Please consult the sales office for details.

8. CAPACITY TABLES

PUHY-	P700YSKB-A1	P750YSKB-A1	P800YSKB-A1
Nominal Cooling Capacity	80.0	85.0	90.0
Input	24.69	26.56	27.86

Indoor unit temperature correction

To be used to correct indoor unit capacity only

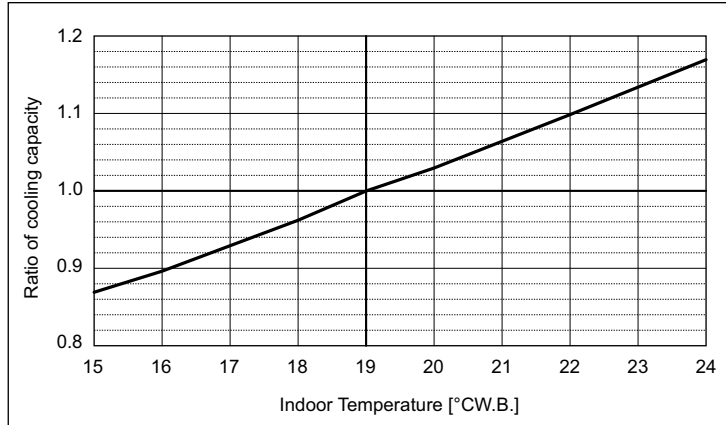

Outdoor unit temperature correction

To be used to correct outdoor unit only

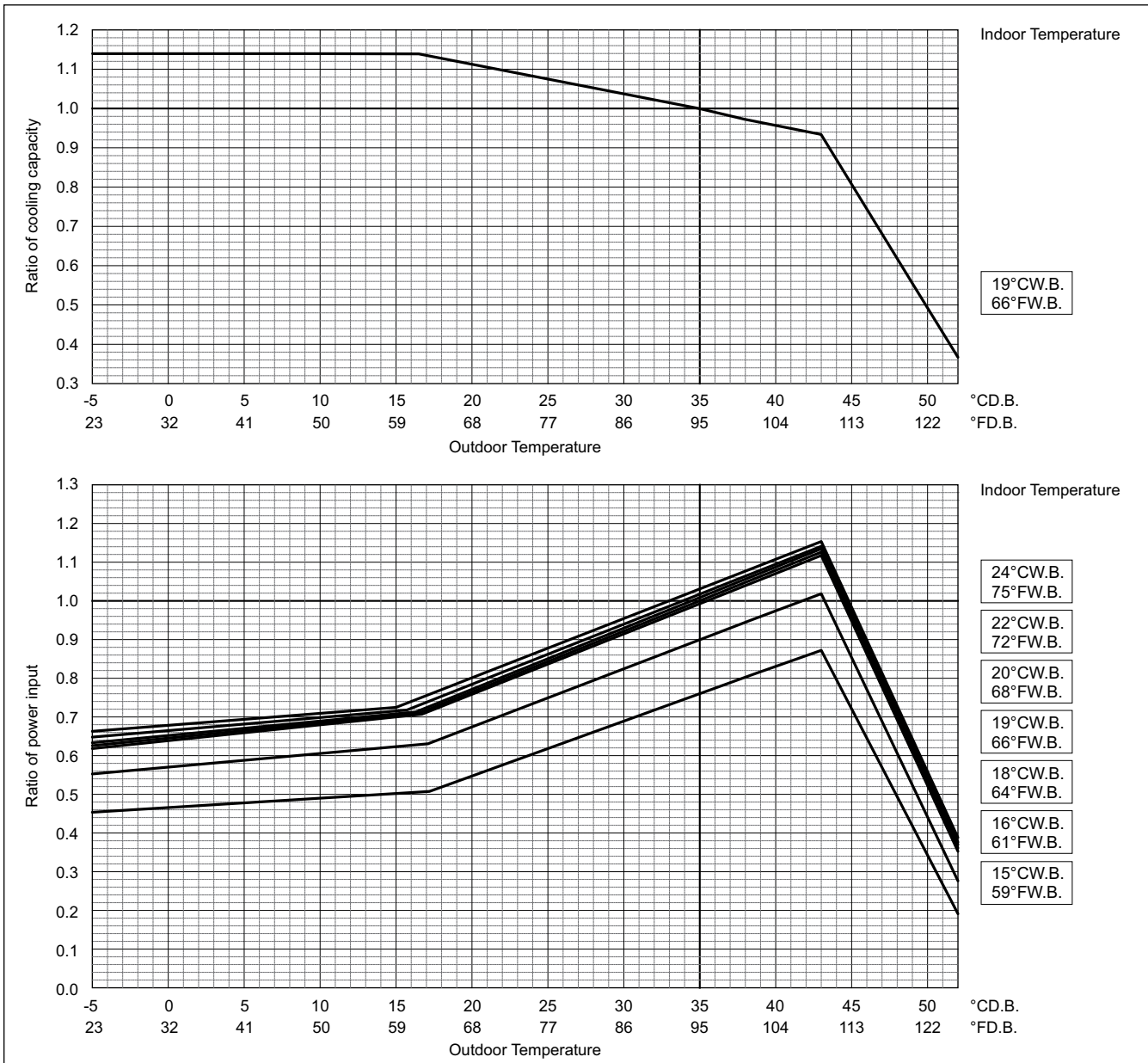

Outdoor unit power input is affected by the indoor and outdoor temperatures as shown in the graph above. Please consult the sales office for details.

PUHY-	P700YSKB-A1	P750YSKB-A1	P800YSKB-A1
Nominal Heating Capacity	kW 88.0	95.0	100.0
	BTU/h 300,300	324,100	341,200
Input	kW 22.97	24.93	27.62

Indoor unit temperature correction

To be used to correct indoor unit capacity only

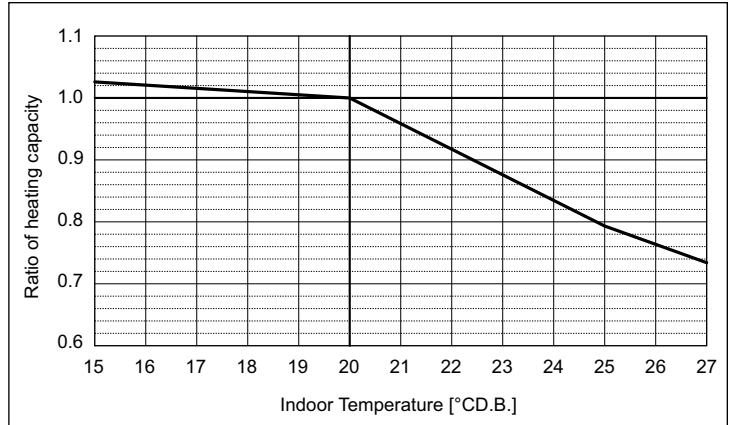

Outdoor unit temperature correction

To be used to correct outdoor unit only

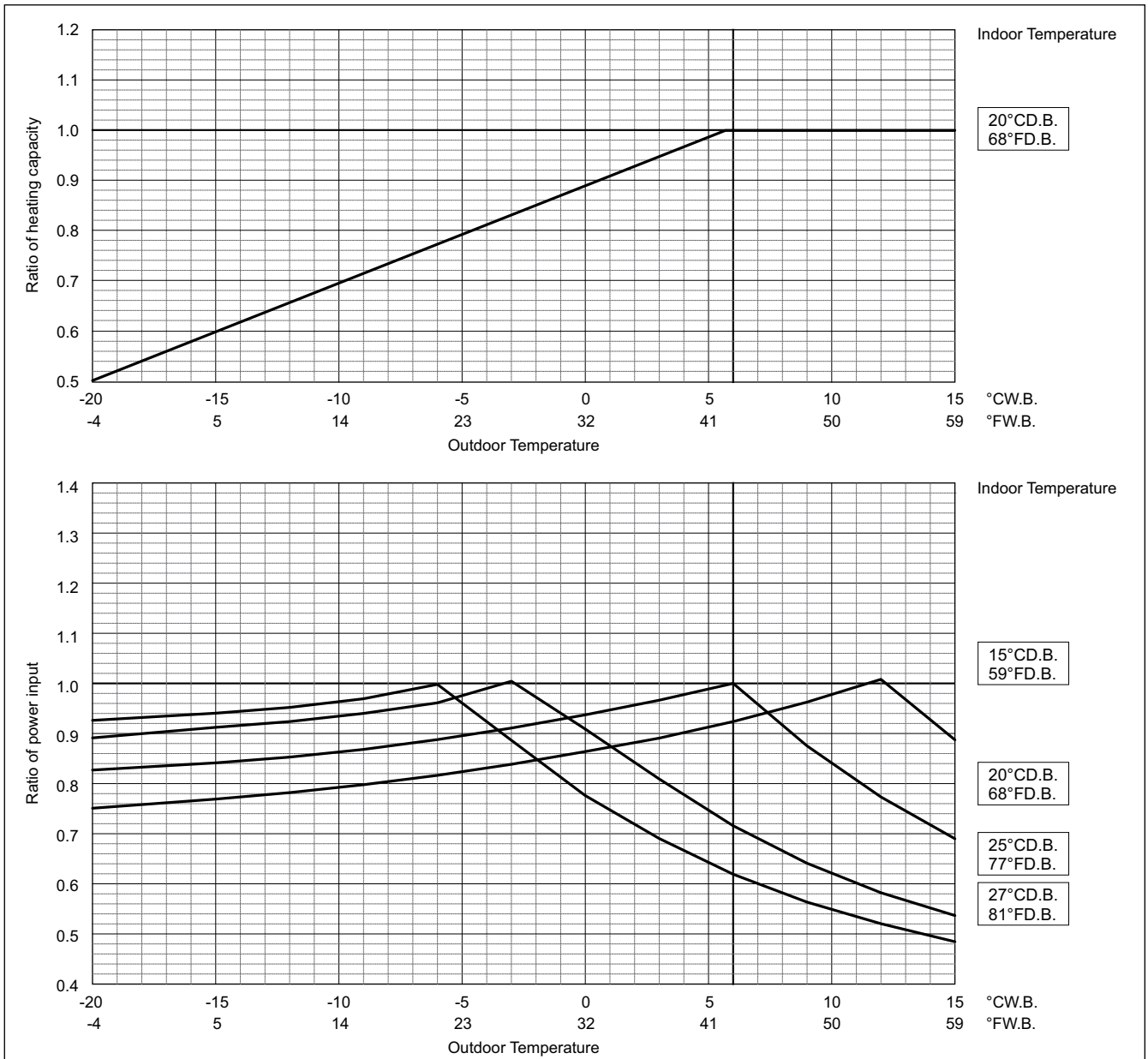

Outdoor unit power input is affected by the indoor and outdoor temperatures as shown in the graph above. Please consult the sales office for details.

8. CAPACITY TABLES

PUHY-		P850YSKB-A1	P900YSKB-A1	P950YSKB-A1
Nominal Cooling Capacity	kW	96.0	101.0	108.0
	BTU/h	327,600	344,600	368,500
Input	kW	30.18	31.46	30.25

PUHY-		P1000YSKB-A1	P1050YSKB-A1	P1100YSKB-A1
Nominal Cooling Capacity	kW	113.0	118.0	124.0
	BTU/h	385,600	402,600	423,100
Input	kW	32.10	35.01	38.62

PUHY-		P1150YSKB-A1	P1200YSKB-A1	P1250YSKB-A1
Nominal Cooling Capacity	kW	130.0	136.0	140.0
	BTU/h	443,600	464,000	477,700
Input	kW	40.24	44.10	43.80

PUHY-		P1300YSKB-A1	P1350YSKB-A1
Nominal Cooling Capacity	kW	146.0	150.0
	BTU/h	498,200	511,800
Input	kW	47.80	47.40

Indoor unit temperature correction

To be used to correct indoor unit capacity only

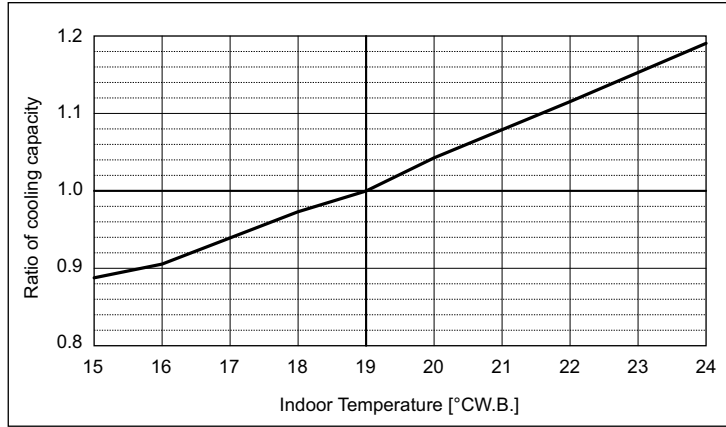

Outdoor unit temperature correction

To be used to correct outdoor unit only

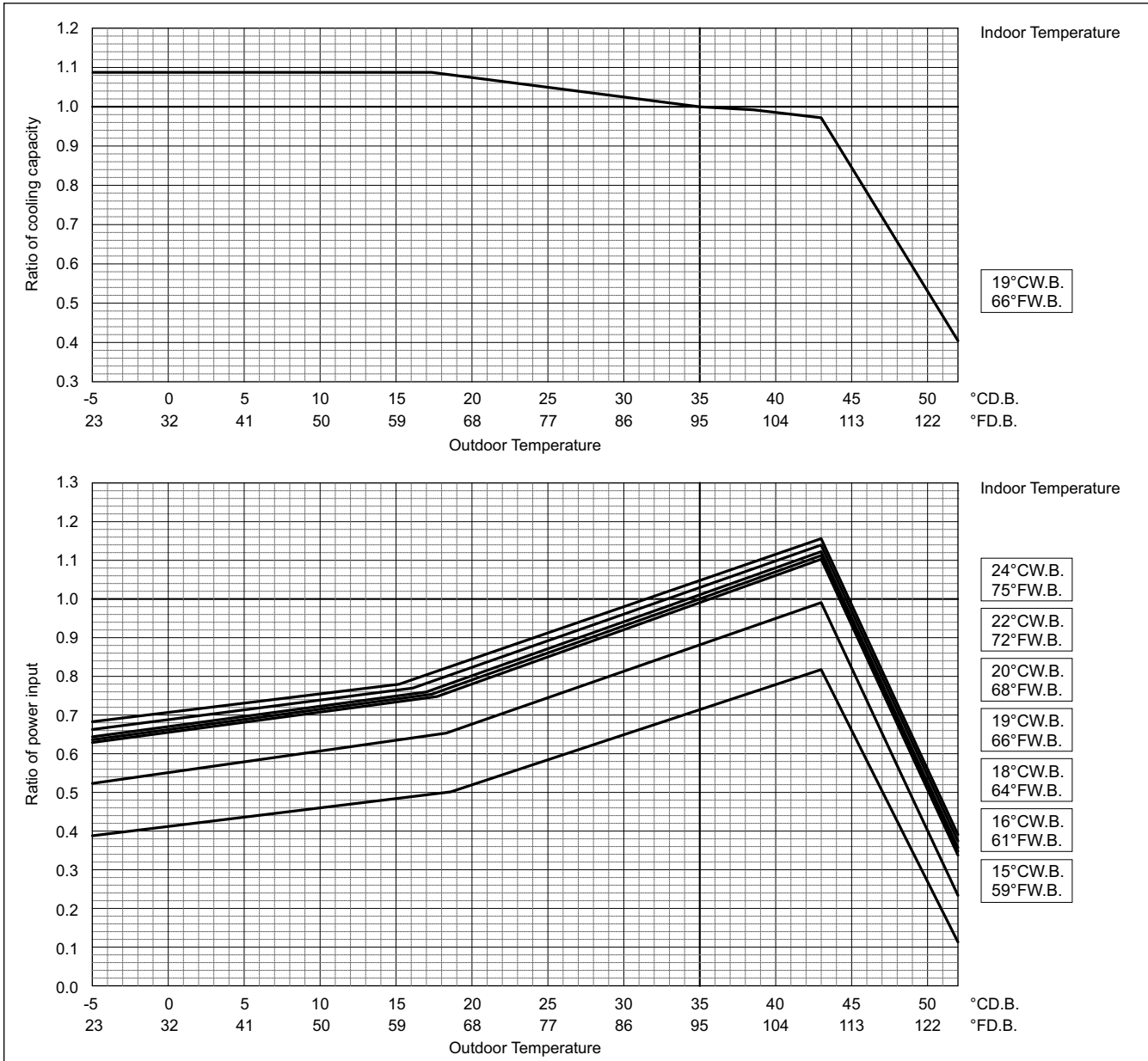

Outdoor unit power input is affected by the indoor and outdoor temperatures as shown in the graph above. Please consult the sales office for details.

PUHY-	P850YSKB-A1	P900YSKB-A1	P950YSKB-A1
Nominal Heating Capacity	kW 108.0	113.0	119.5
	BTU/h 368,500	385,600	407,700
Input	kW 29.90	33.00	30.40

PUHY-	P1000YSKB-A1	P1050YSKB-A1	P1100YSKB-A1
Nominal Heating Capacity	kW 127.0	132.0	140.0
	BTU/h 433,300	450,400	477,700
Input	kW 32.70	34.25	36.60

PUHY-	P1150YSKB-A1	P1200YSKB-A1	P1250YSKB-A1
Nominal Heating Capacity	kW 145.0	150.0	156.5
	BTU/h 494,700	511,800	534,000
Input	kW 39.29	40.76	44.08

PUHY-	P1300YSKB-A1	P1350YSKB-A1
Nominal Heating Capacity	kW 163.0	168.0
	BTU/h 556,200	573,200
Input	kW 46.04	49.12

Indoor unit temperature correction
To be used to correct indoor unit capacity only

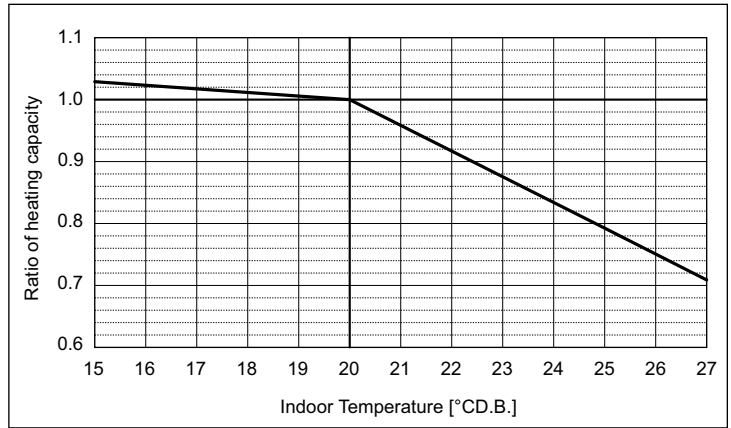

Outdoor unit temperature correction
To be used to correct outdoor unit only

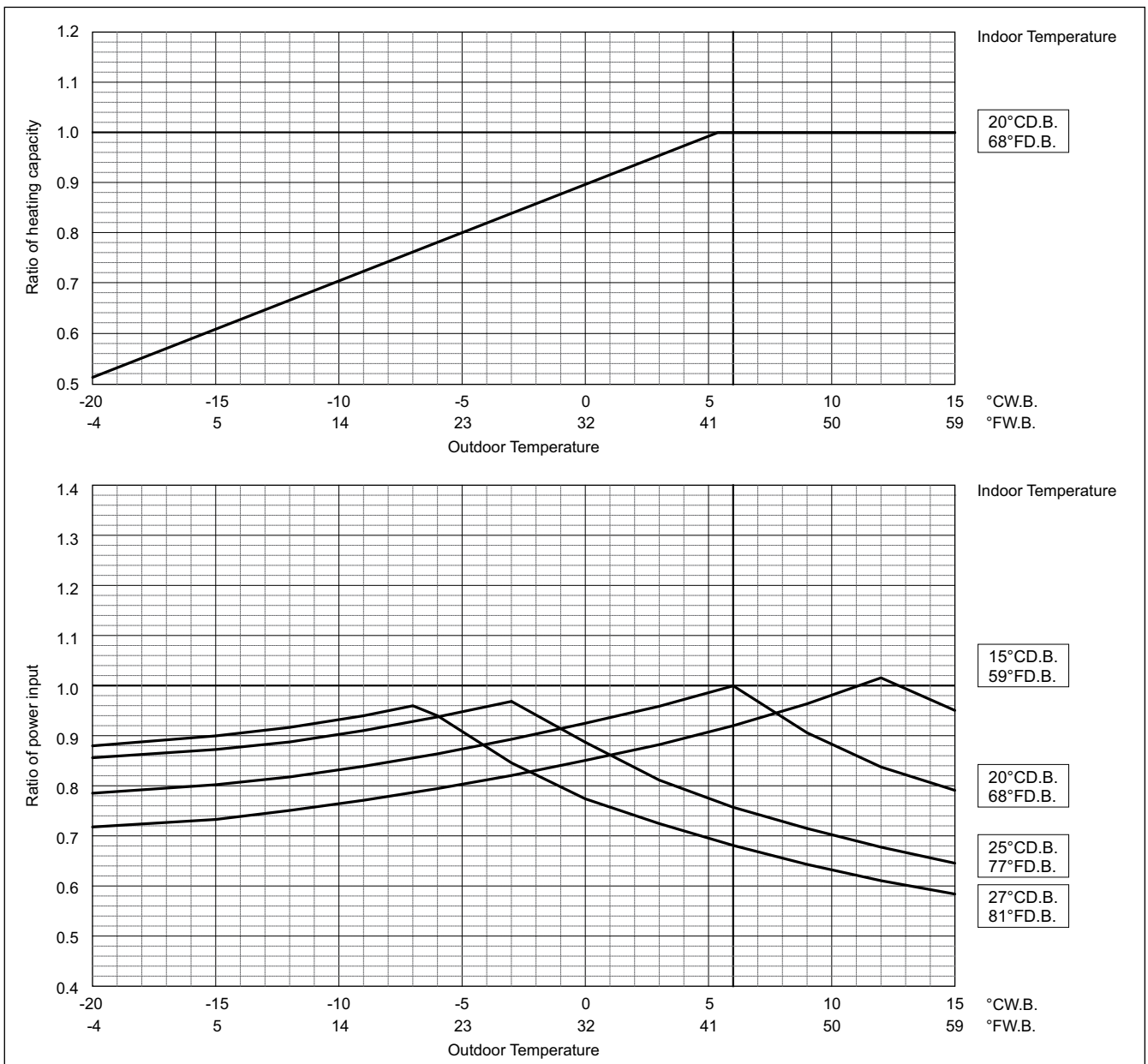

Outdoor unit power input is affected by the indoor and outdoor temperatures as shown in the graph above. Please consult the sales office for details.

8-3. Correction by total indoor

CITY MULTI system have different capacities and inputs when many combinations of indoor units with different total capacities are connected. Using following tables, the maximum capacity can be found to ensure the system is installed with enough capacity for a particular application.

PUHY-P200YKB-A1		
Nominal Cooling Capacity	kW	22.4
	BTU/h	76,400
Input	kW	5.19

PUHY-P200YKB-A1		
Nominal Heating Capacity	kW	25.0
	BTU/h	85,300
Input	kW	5.81

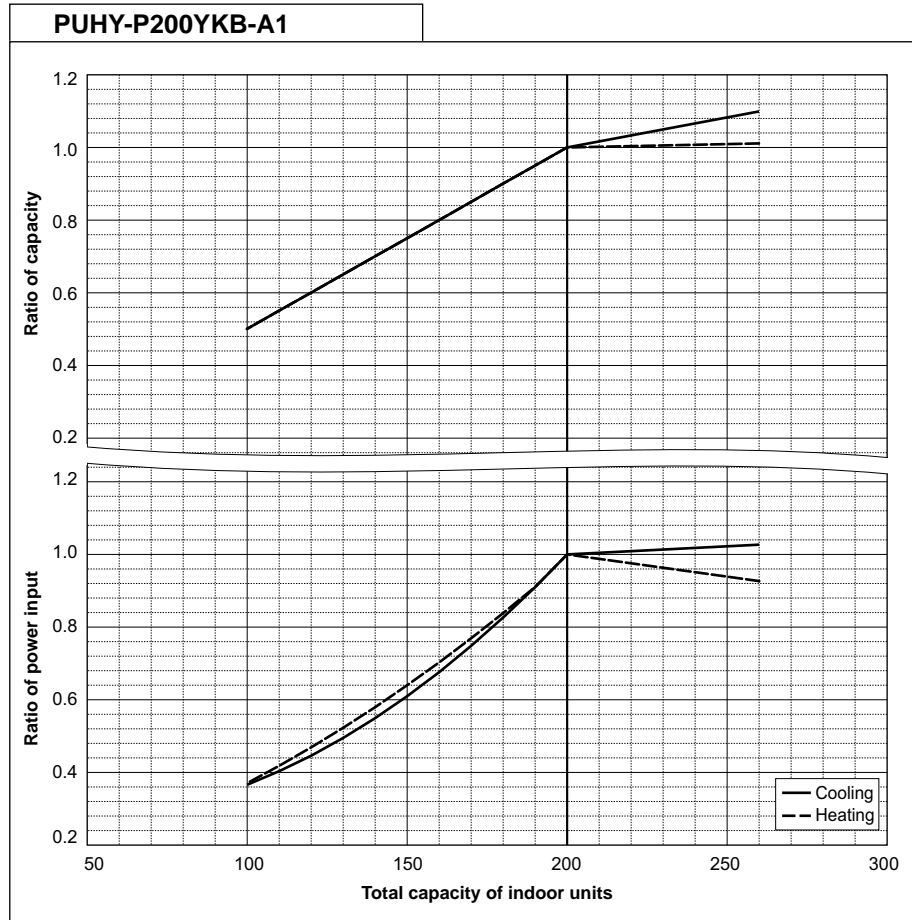

PUHY-P250YKB-A1		
Nominal Cooling Capacity	kW	28.0
	BTU/h	95,500
Input	kW	6.88

PUHY-P250YKB-A1		
Nominal Heating Capacity	kW	31.5
	BTU/h	107,500
Input	kW	7.34

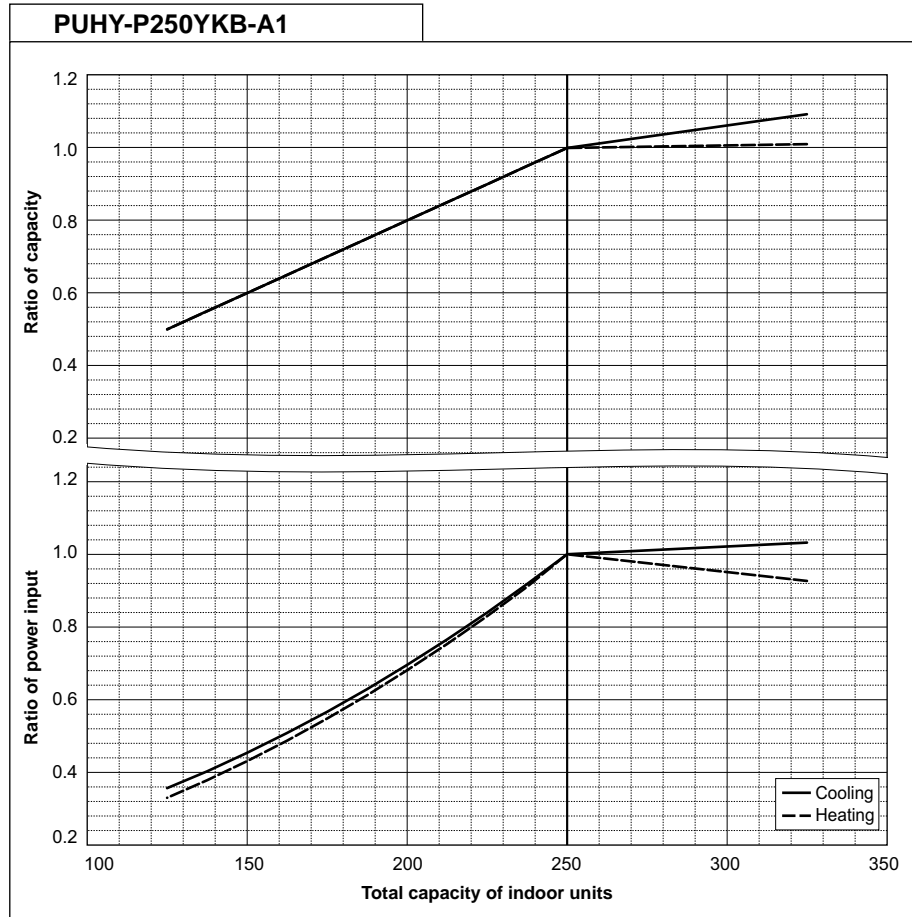

PUHY-P300YKB-A1		
Nominal Cooling Capacity	kW	33.5
	BTU/h	114,300
Input	kW	8.56

PUHY-P300YKB-A1		
Nominal Heating Capacity	kW	37.5
	BTU/h	128,000
Input	kW	9.07

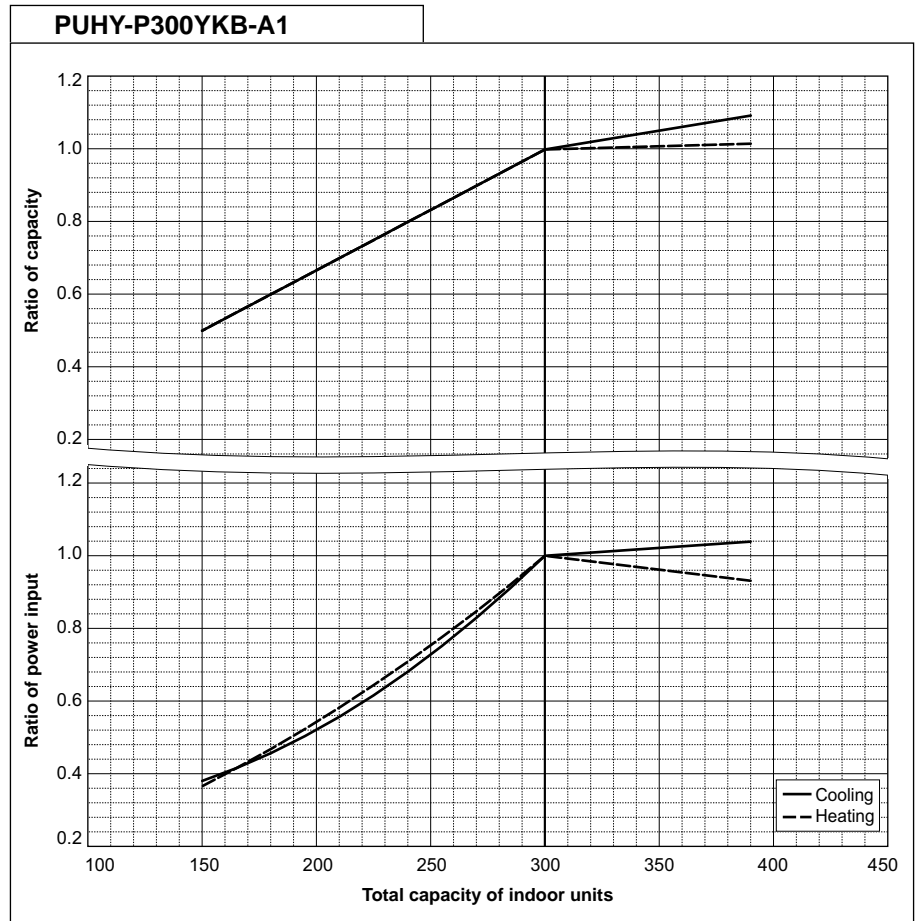

PUHY-P350YKB-A1		
Nominal Cooling Capacity	kW	40.0
	BTU/h	136,500
Input	kW	11.69

PUHY-P350YKB-A1		
Nominal Heating Capacity	kW	45.0
	BTU/h	153,500
Input	kW	11.13

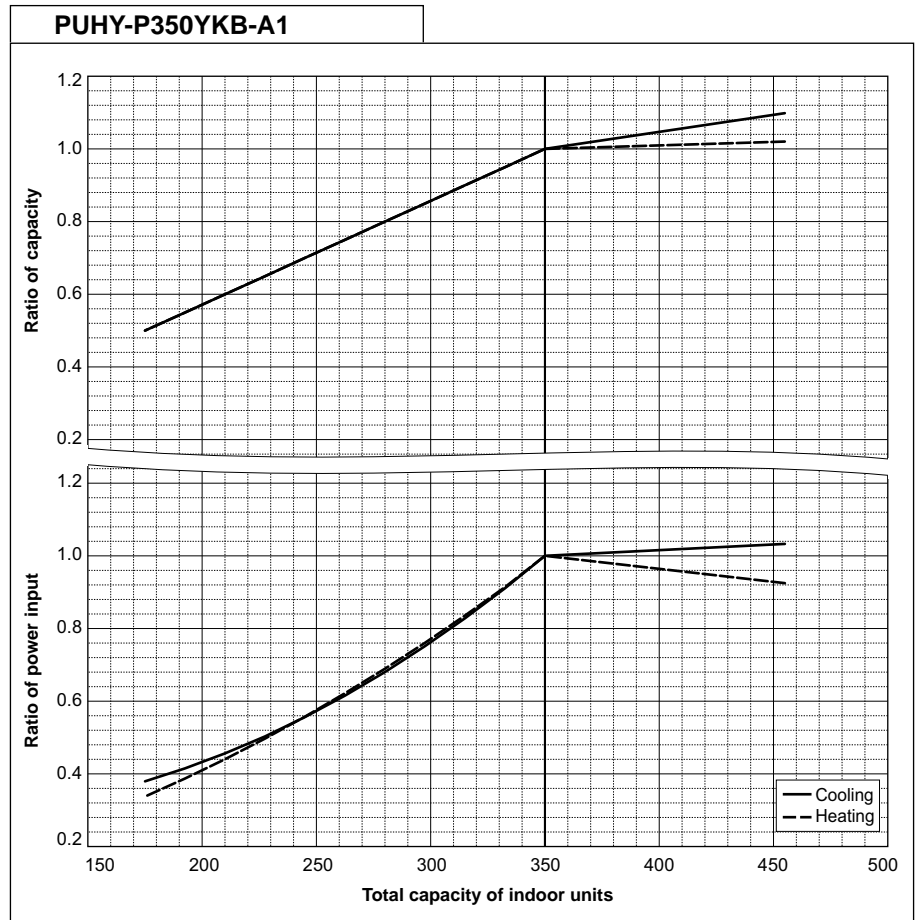

8. CAPACITY TABLES

YKB/YLM

Y

PUHY-P400YKB-A1		
Nominal Cooling Capacity	kW	45.0
	BTU/h	153,500
Input	kW	13.55

PUHY-P400YKB-A1		
Nominal Heating Capacity	kW	50.0
	BTU/h	170,600
Input	kW	12.50

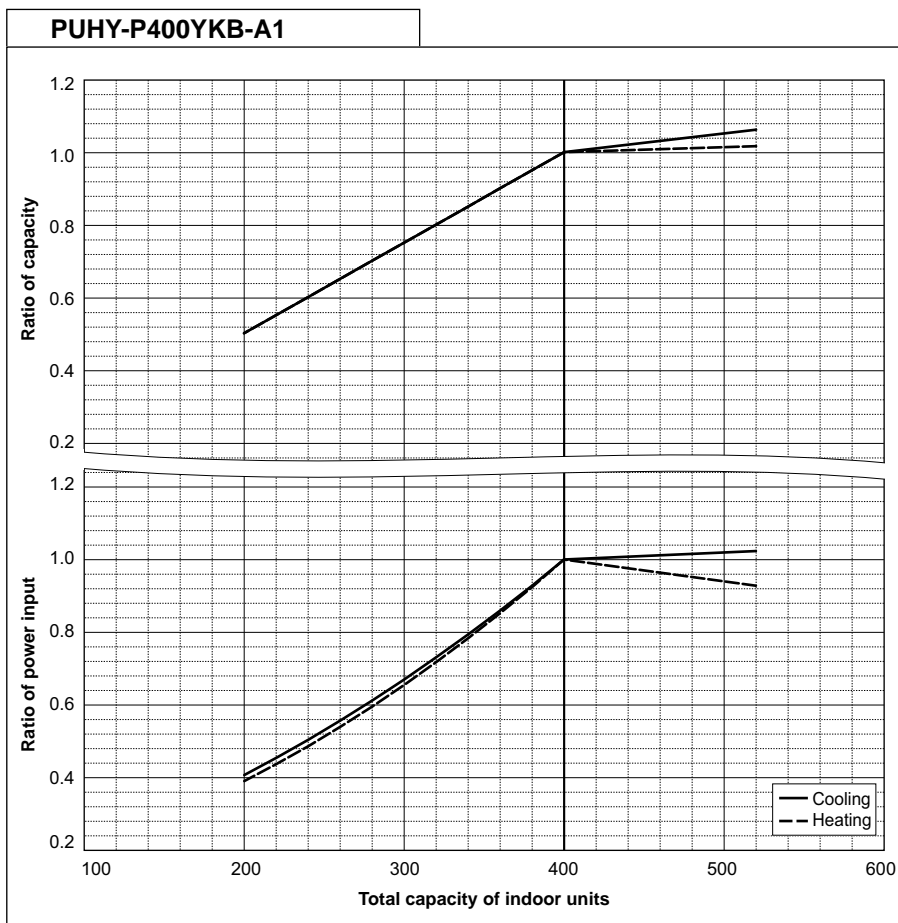

PUHY-P450YKB-A1		
Nominal Cooling Capacity	kW	50.0
	BTU/h	170,600
Input	kW	14.79

PUHY-P450YKB-A1		
Nominal Heating Capacity	kW	56.0
	BTU/h	191,100
Input	kW	15.55

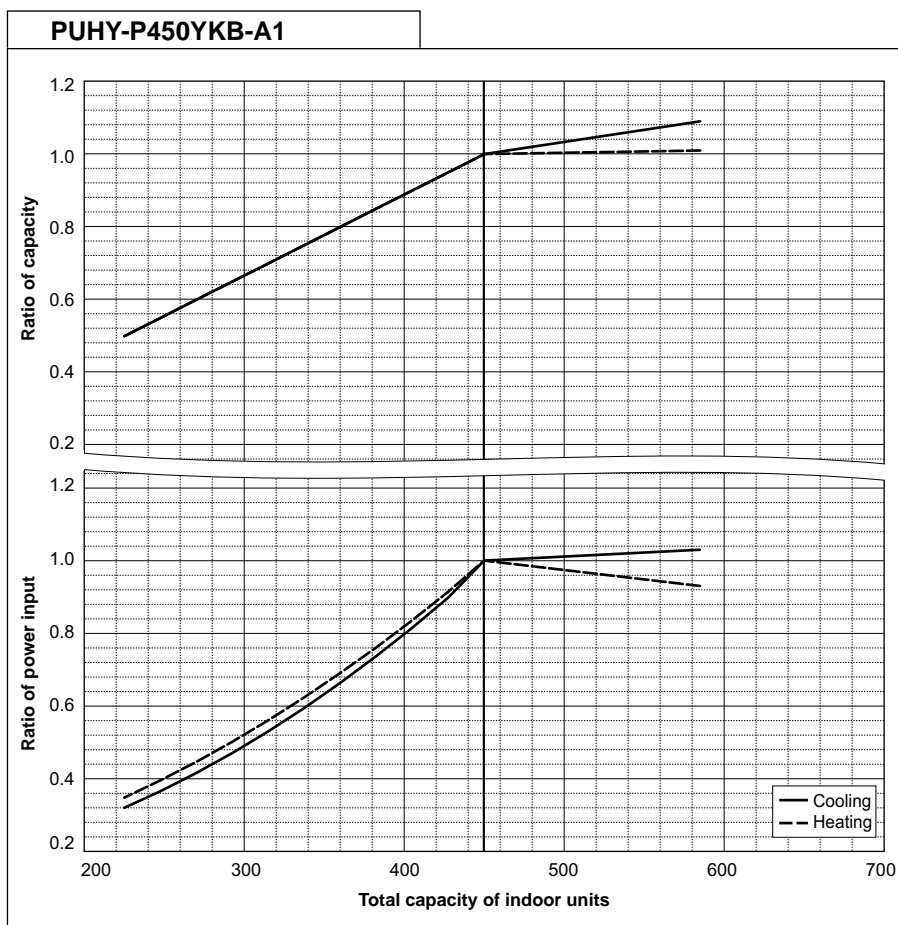

PUHY-P500YKB-A1		
Nominal Cooling Capacity	kW	55.0
	BTU/h	187,700
Input	kW	18.39

PUHY-P500YKB-A1		
Nominal Heating Capacity	kW	63.0
	BTU/h	215,000
Input	kW	18.52

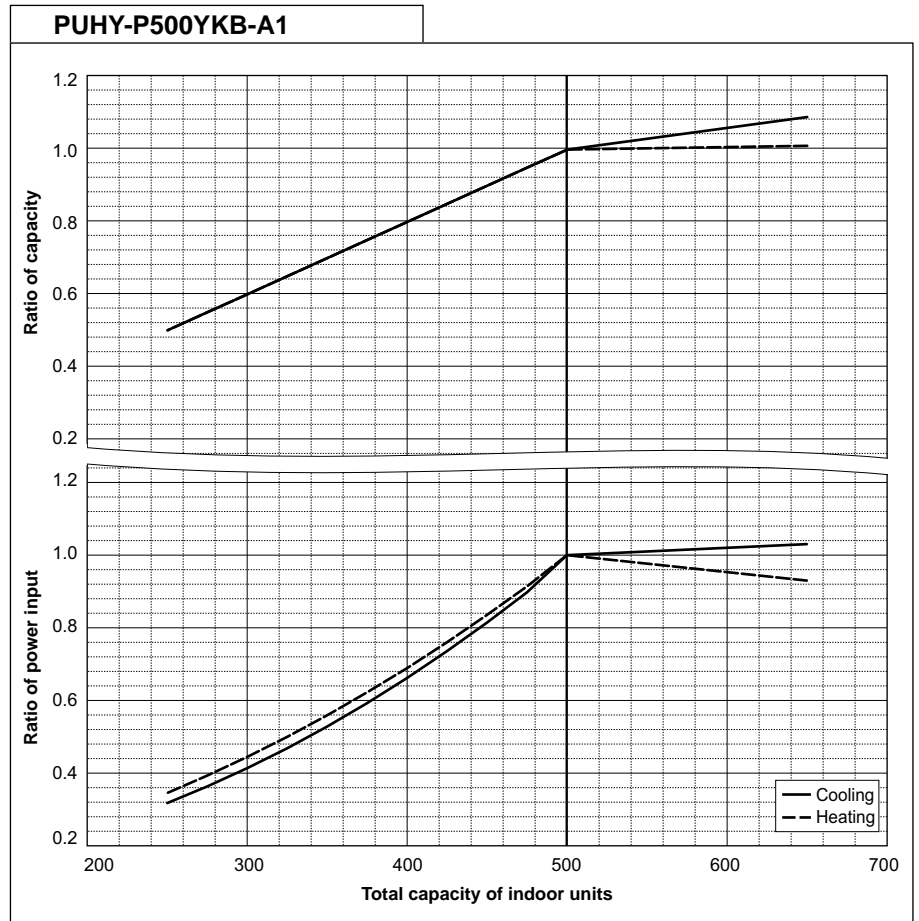

PUHY-P400YSKB-A1		
Nominal Cooling Capacity	kW	45.0
	BTU/h	153,500
Input	kW	11.0

PUHY-P400YSKB-A1		
Nominal Heating Capacity	kW	50.0
	BTU/h	170,600
Input	kW	12.24

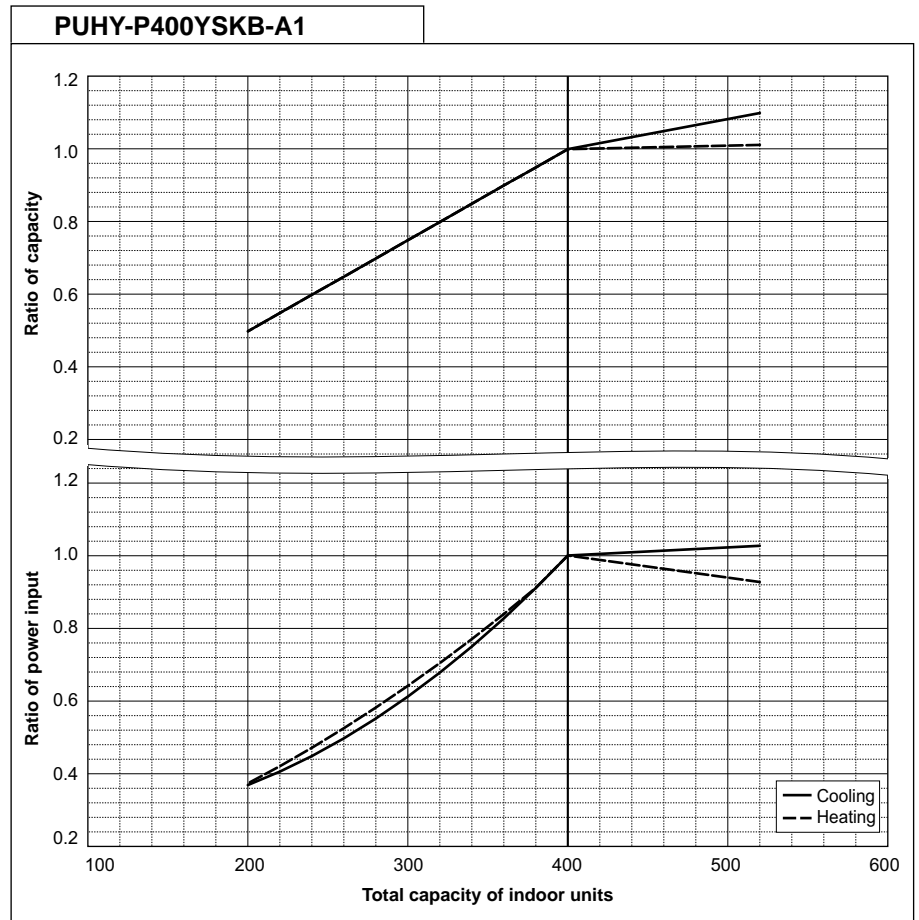

8. CAPACITY TABLES

Y

PUHY-P450YSKB-A1		
Nominal Cooling Capacity	kW	50.0
	BTU/h	170,600
Input	kW	12.59

PUHY-P450YSKB-A1		
Nominal Heating Capacity	kW	56.0
	BTU/h	191,100
Input	kW	13.72

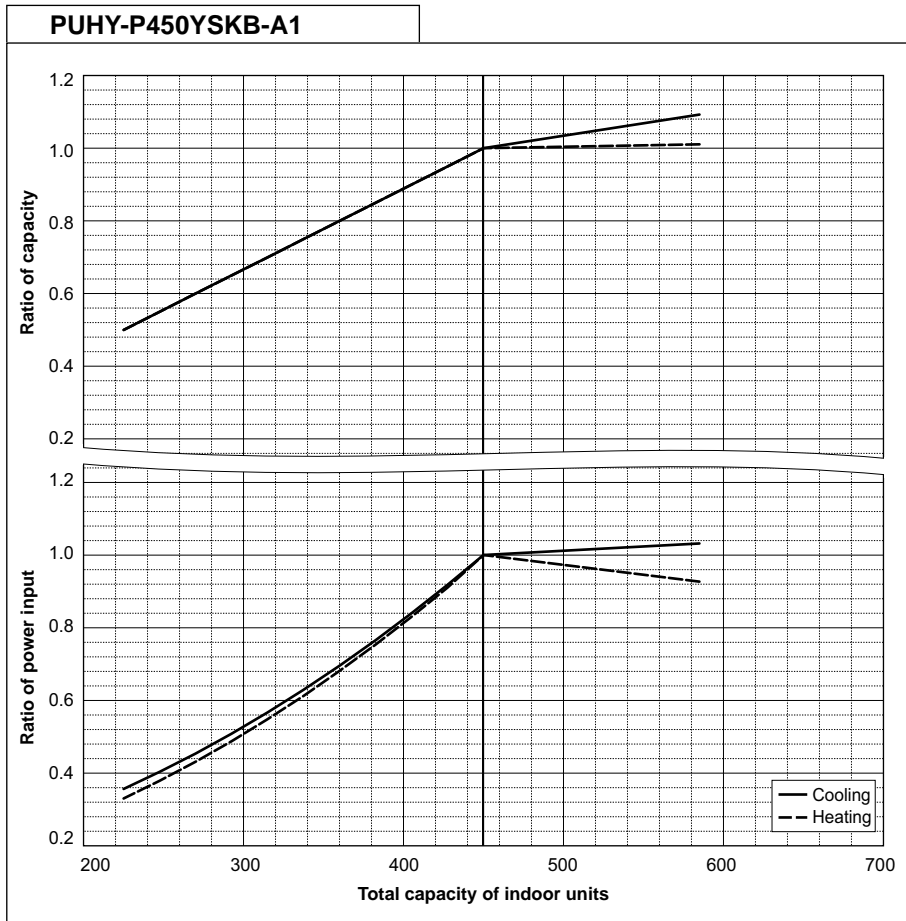

PUHY-P500YSKB-A1		
Nominal Cooling Capacity	kW	56.0
	BTU/h	191,100
Input	kW	14.54

PUHY-P500YSKB-A1		
Nominal Heating Capacity	kW	63.0
	BTU/h	215,000
Input	kW	15.46

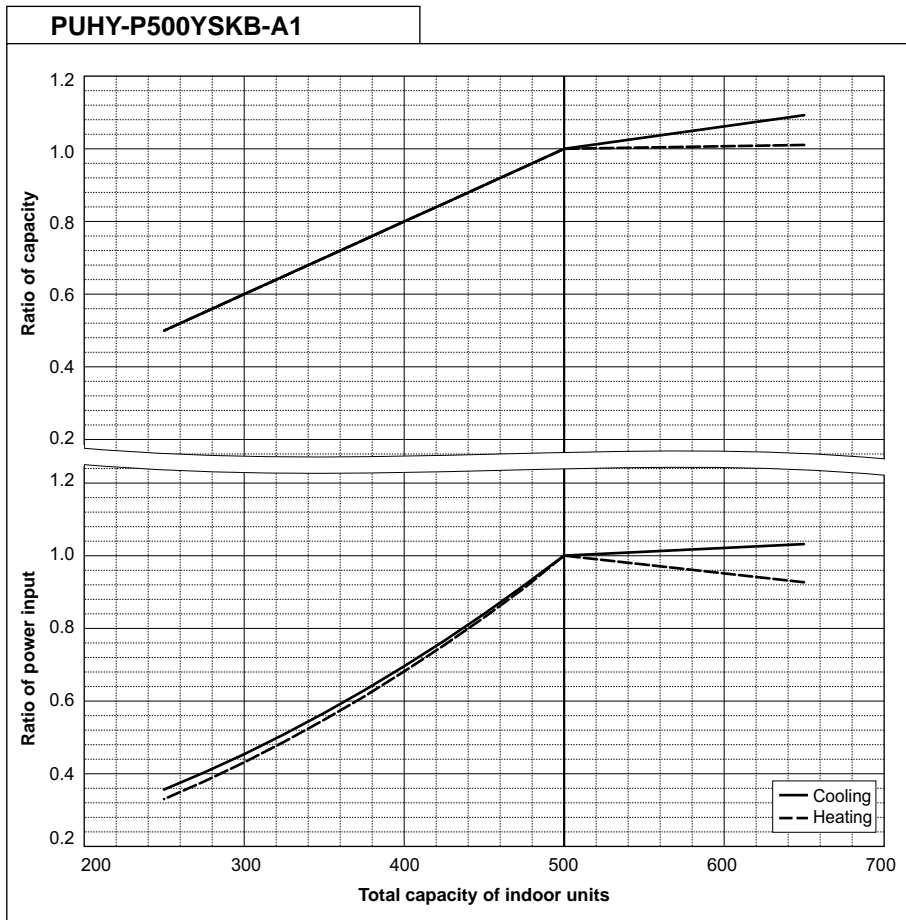

PUHY-P550YSKB-A1		
Nominal Cooling Capacity	kW	63.0
	BTU/h	215,000
Input	kW	16.66

PUHY-P550YSKB-A1		
Nominal Heating Capacity	kW	69.0
	BTU/h	235,400
Input	kW	17.29

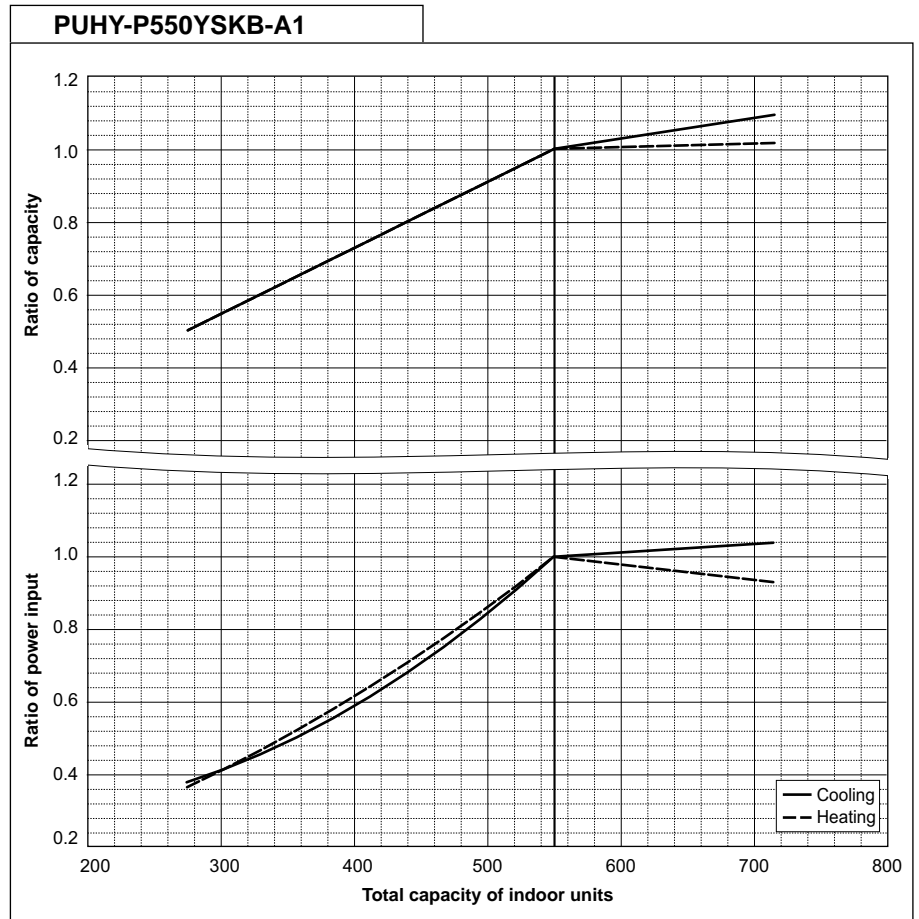

PUHY-P600YSKB-A1		
Nominal Cooling Capacity	kW	69.0
	BTU/h	235,400
Input	kW	19.43

PUHY-P600YSKB-A1		
Nominal Heating Capacity	kW	76.5
	BTU/h	261,000
Input	kW	19.36

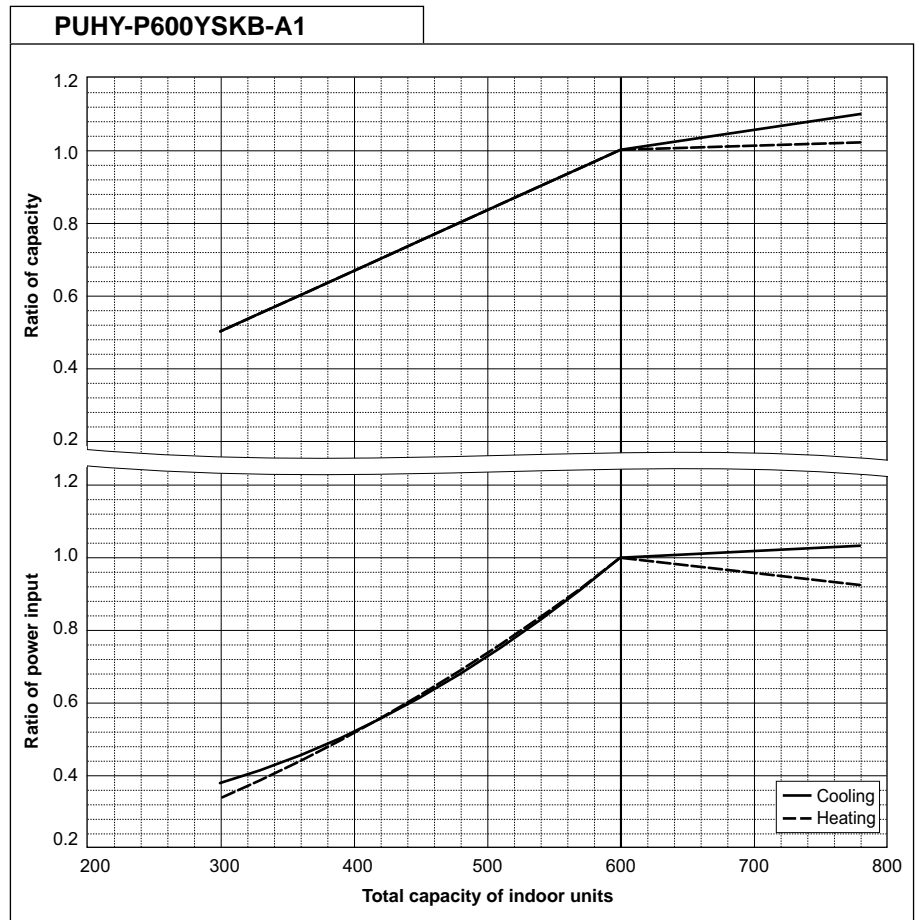

8. CAPACITY TABLES

Y

PUHY-P650YSKB-A1		
Nominal Cooling Capacity	kW	73.0
	BTU/h	249,100
Input	kW	20.97

PUHY-P650YSKB-A1		
Nominal Heating Capacity	kW	81.5
	BTU/h	278,100
Input	kW	21.00

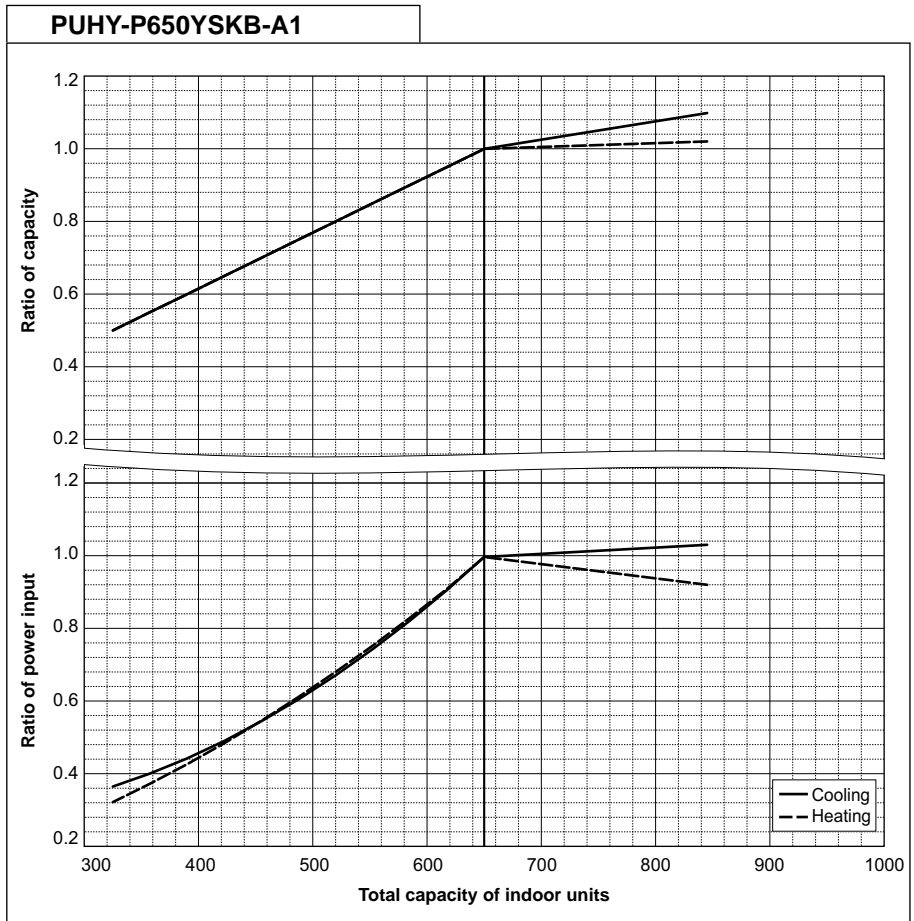

PUHY-P700YSKB-A1		
Nominal Cooling Capacity	kW	80.0
	BTU/h	273,000
Input	kW	24.69

PUHY-P700YSKB-A1		
Nominal Heating Capacity	kW	88.0
	BTU/h	300,300
Input	kW	22.97

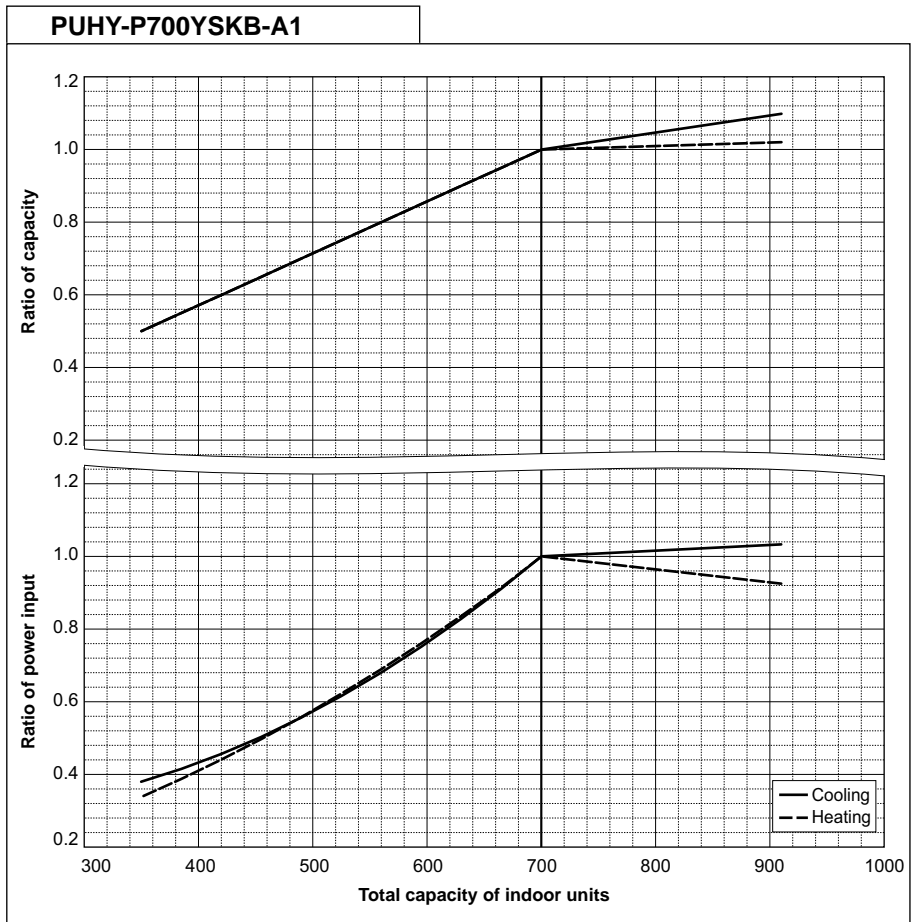

PUHY-P750YSKB-A1		
Nominal Cooling Capacity	kW	85.0
	BTU/h	290,000
Input	kW	26.56

PUHY-P750YSKB-A1		
Nominal Heating Capacity	kW	95.0
	BTU/h	324,100
Input	kW	24.93

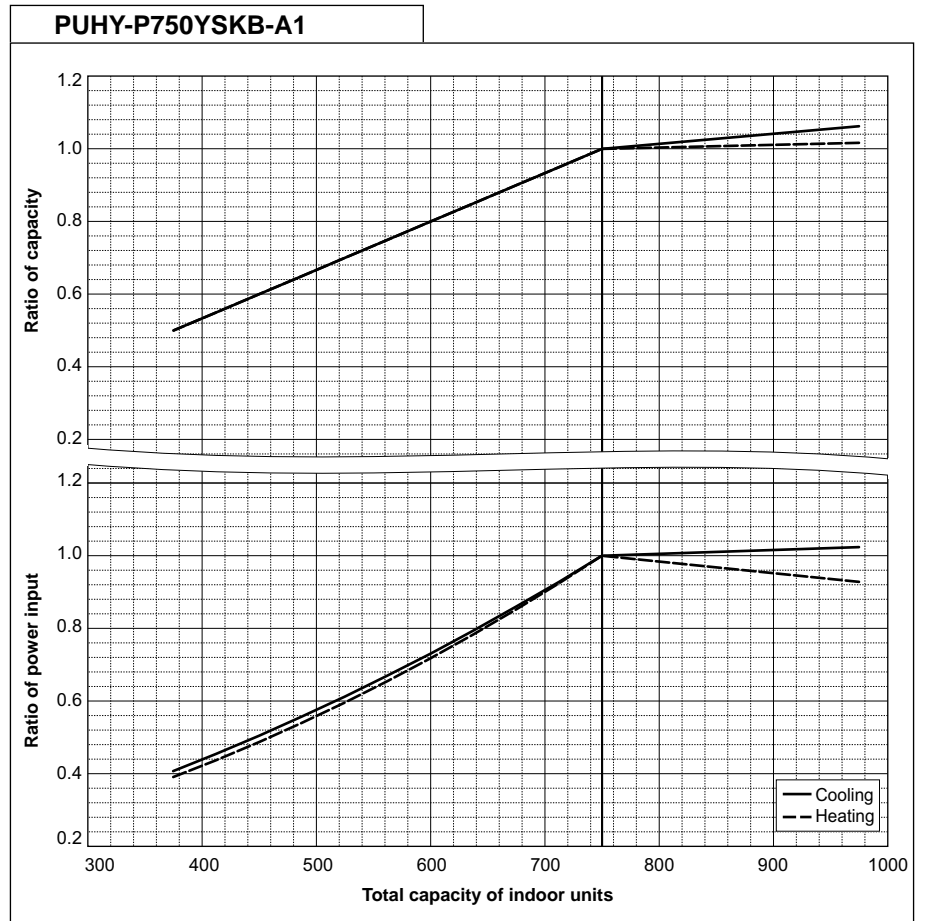

PUHY-P800YSKB-A1		
Nominal Cooling Capacity	kW	90.0
	BTU/h	307,100
Input	kW	27.86

PUHY-P800YSKB-A1		
Nominal Heating Capacity	kW	100.0
	BTU/h	341,200
Input	kW	27.62

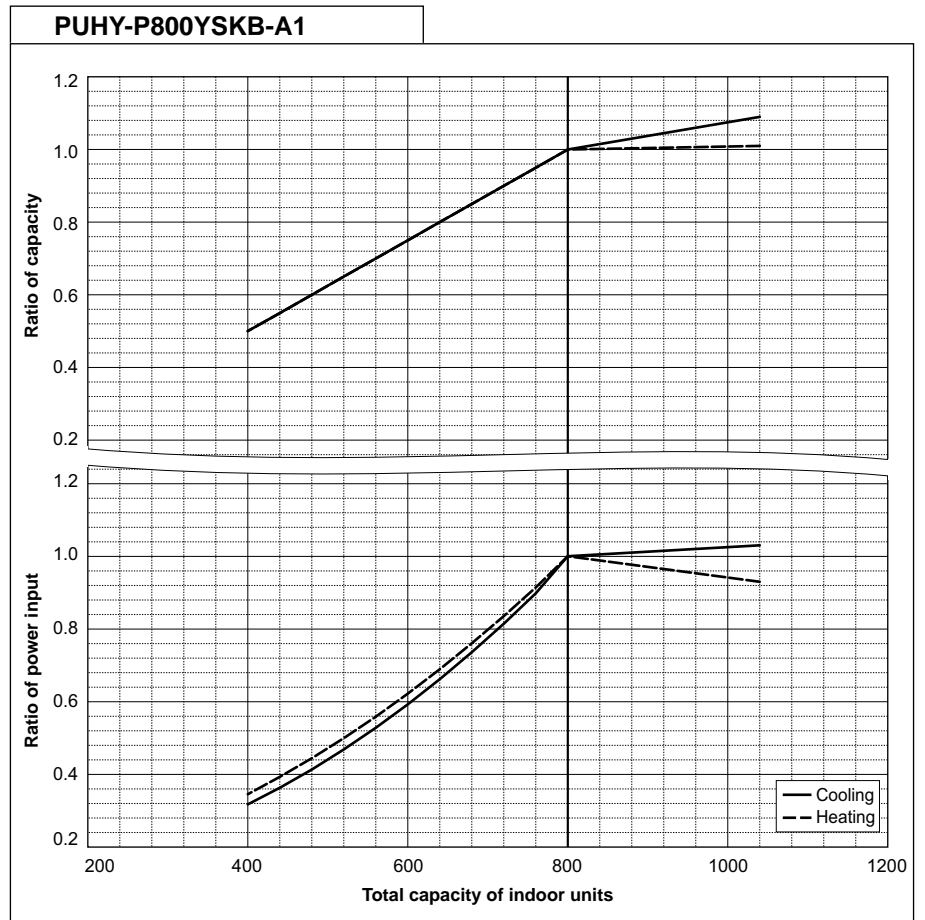

Y

PUHY-P850YSKB-A1		
Nominal Cooling Capacity	kW	96.0
	BTU/h	327,600
Input	kW	30.18

PUHY-P850YSKB-A1		
Nominal Heating Capacity	kW	108.0
	BTU/h	368,500
Input	kW	29.90

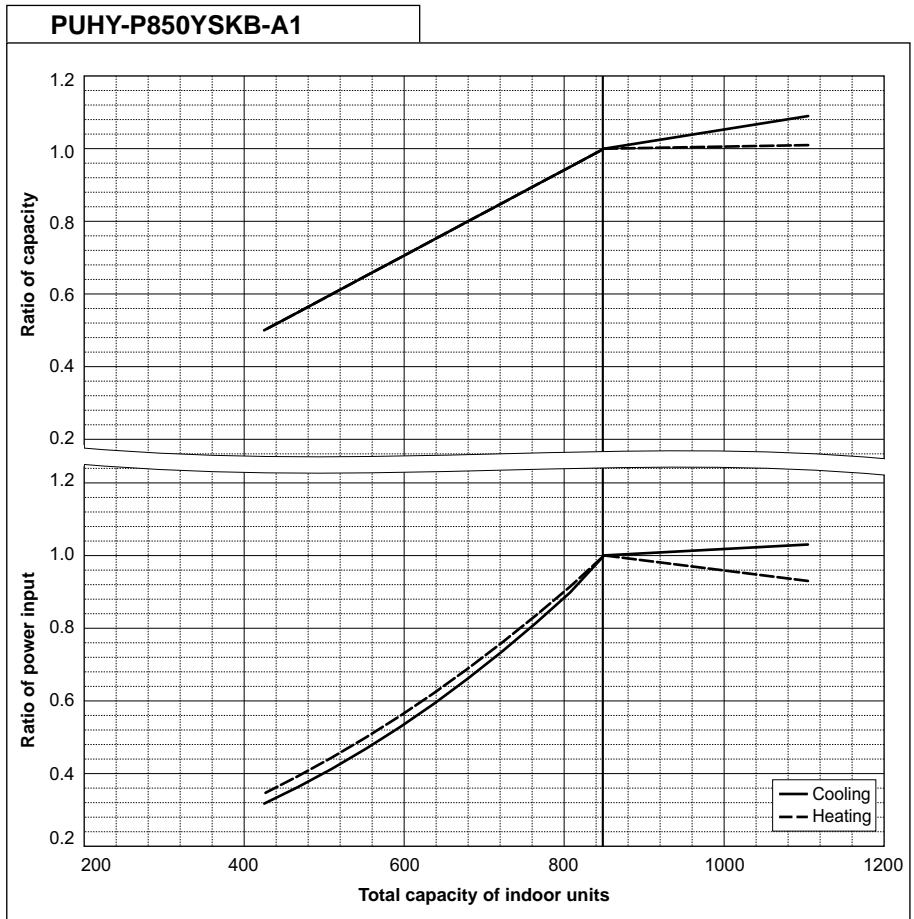

PUHY-P900YSKB-A1		
Nominal Cooling Capacity	kW	101.0
	BTU/h	344,600
Input	kW	31.46

PUHY-P900YSKB-A1		
Nominal Heating Capacity	kW	113.0
	BTU/h	385,600
Input	kW	33.00

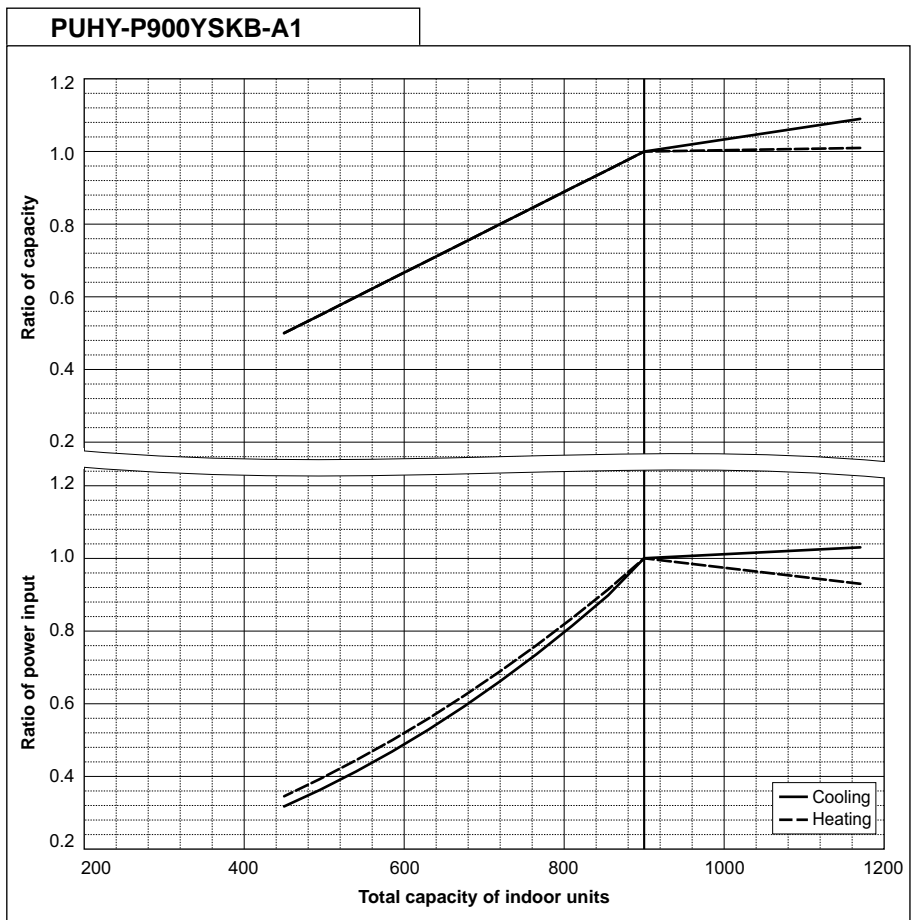

PUHY-P950YSKB-A1		
Nominal Cooling Capacity	kW	108.0
	BTU/h	368,500
Input	kW	30.25

PUHY-P950YSKB-A1		
Nominal Heating Capacity	kW	119.5
	BTU/h	407,700
Input	kW	30.40

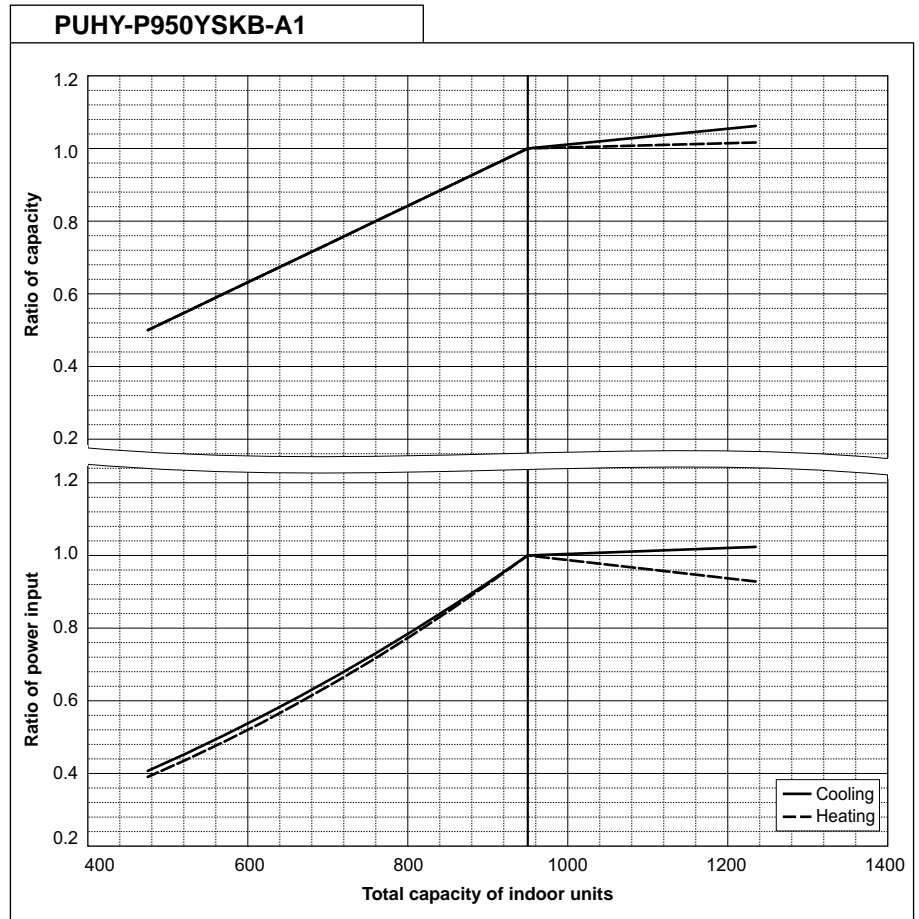

PUHY-P1000YSKB-A1		
Nominal Cooling Capacity	kW	113.0
	BTU/h	385,600
Input	kW	32.10

PUHY-P1000YSKB-A1		
Nominal Heating Capacity	kW	127.0
	BTU/h	433,300
Input	kW	32.70

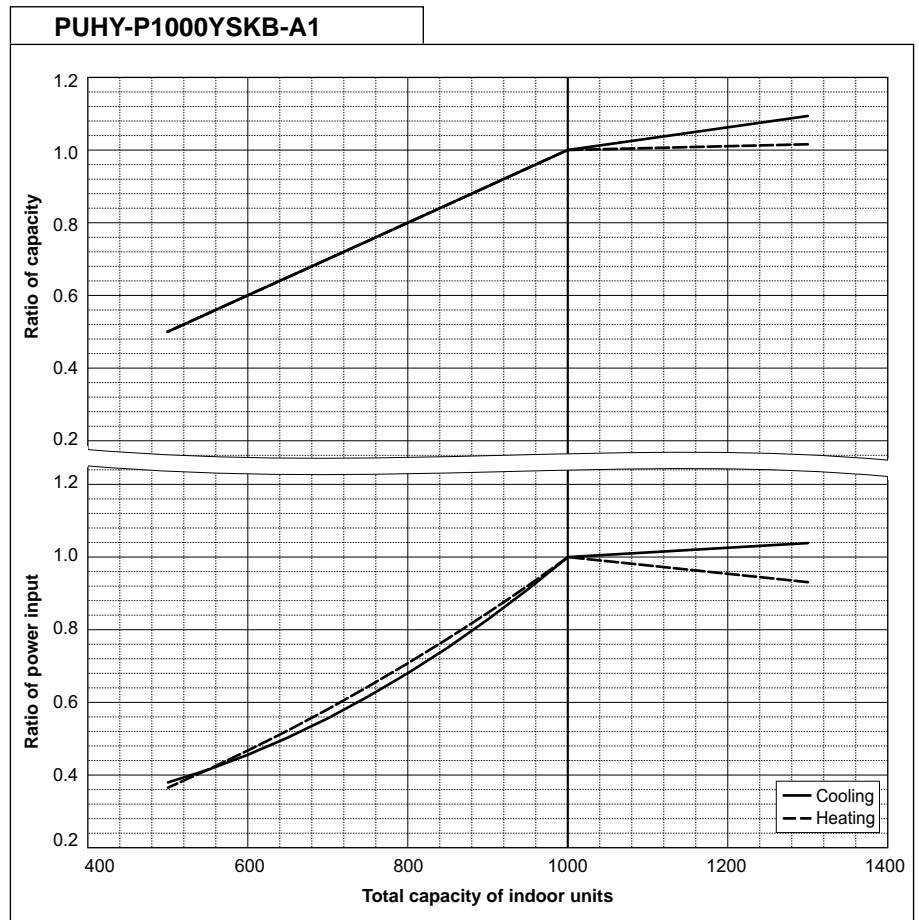

8. CAPACITY TABLES

Y

PUHY-P1050YSKB-A1		
Nominal Cooling Capacity	kW	118.0
	BTU/h	402,600
Input	kW	35.01

PUHY-P1050YSKB-A1		
Nominal Heating Capacity	kW	132.0
	BTU/h	450,400
Input	kW	34.25

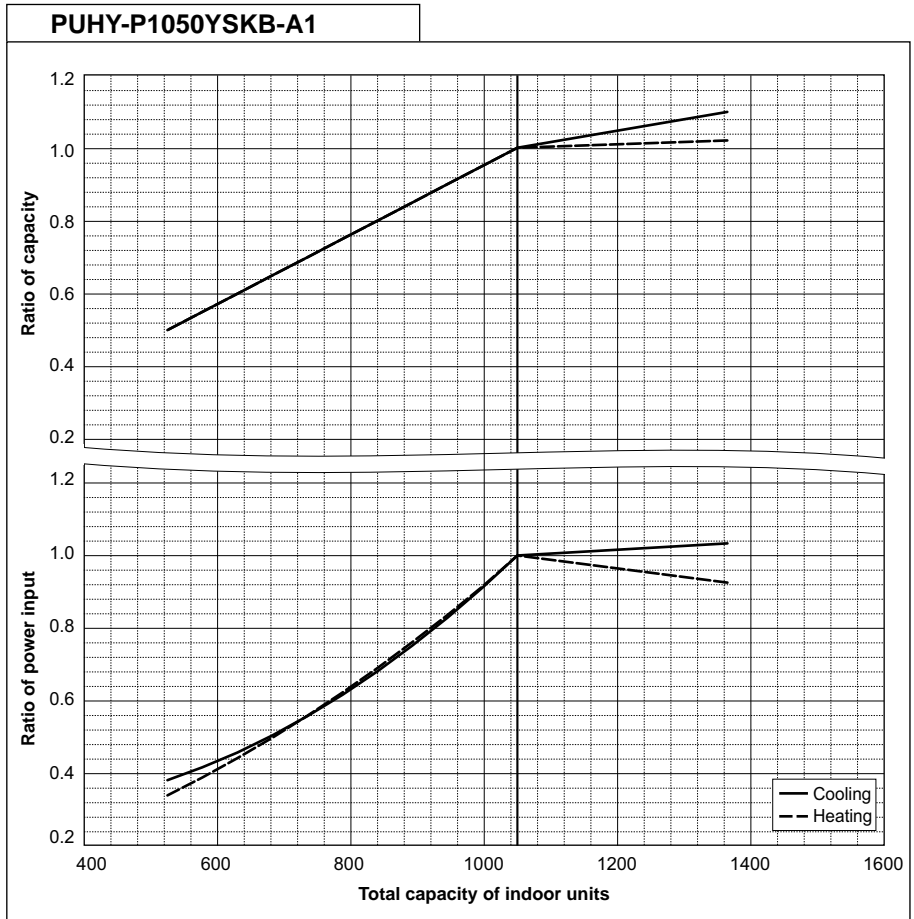

PUHY-P1100YSKB-A1		
Nominal Cooling Capacity	kW	124.0
	BTU/h	423,100
Input	kW	38.62

PUHY-P1100YSKB-A1		
Nominal Heating Capacity	kW	140.0
	BTU/h	477,700
Input	kW	36.60

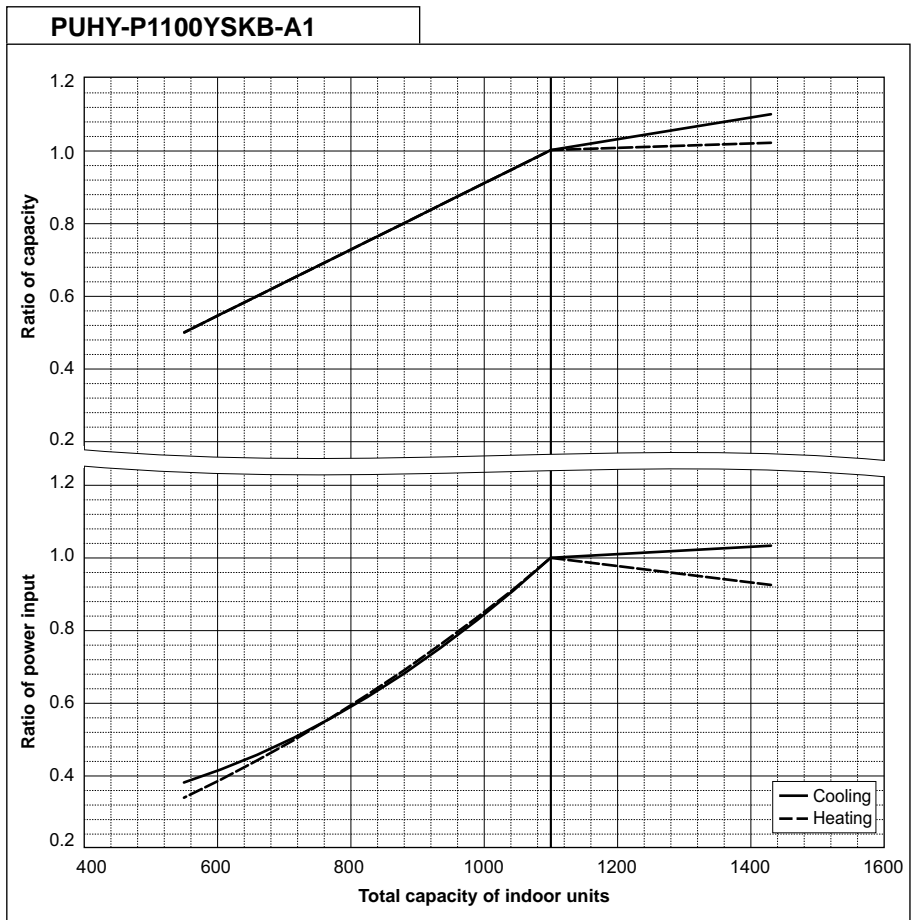

PUHY-P1150YSKB-A1		
Nominal Cooling Capacity	kW	130.0
	BTU/h	443,600
Input	kW	40.24

PUHY-P1150YSKB-A1		
Nominal Heating Capacity	kW	145.0
	BTU/h	494,700
Input	kW	39.29

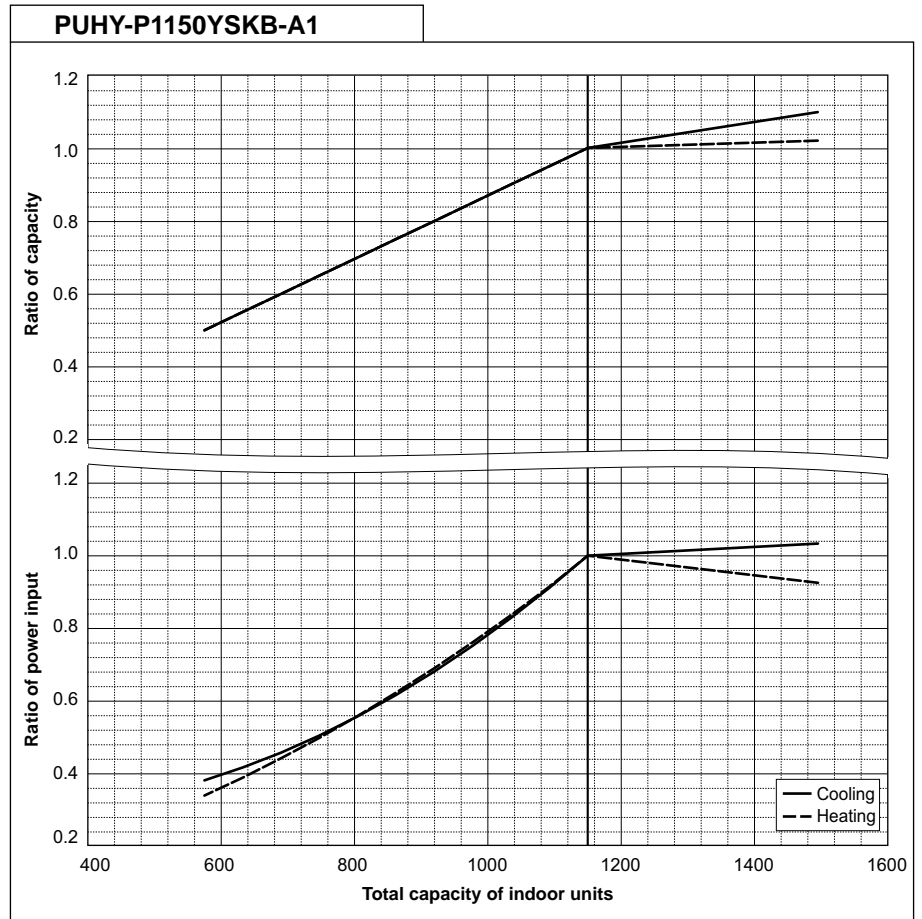

PUHY-P1200YSKB-A1		
Nominal Cooling Capacity	kW	136.0
	BTU/h	464,400
Input	kW	44.10

PUHY-P1200YSKB-A1		
Nominal Heating Capacity	kW	150.0
	BTU/h	511,800
Input	kW	40.76

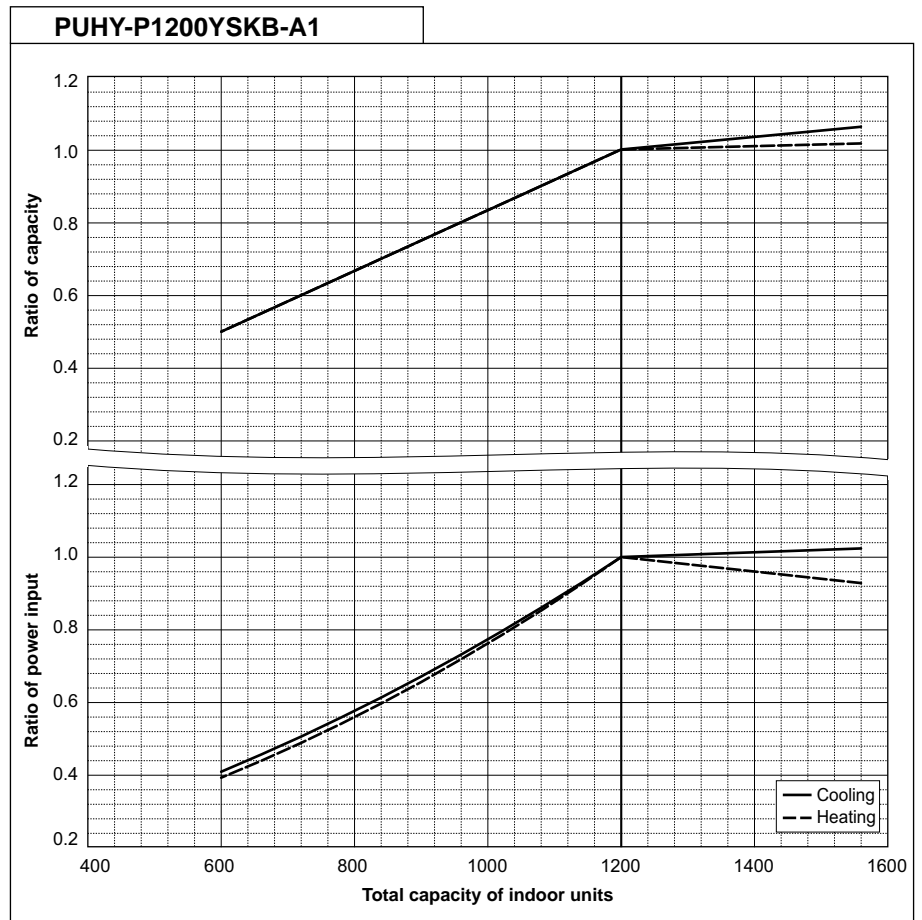

8. CAPACITY TABLES

Y

PUHY-P1250YSKB-A1		
Nominal Cooling Capacity	kW	140.0
	BTU/h	477,700
Input	kW	43.80

PUHY-P1250YSKB-A1		
Nominal Heating Capacity	kW	156.5
	BTU/h	534,000
Input	kW	44.08

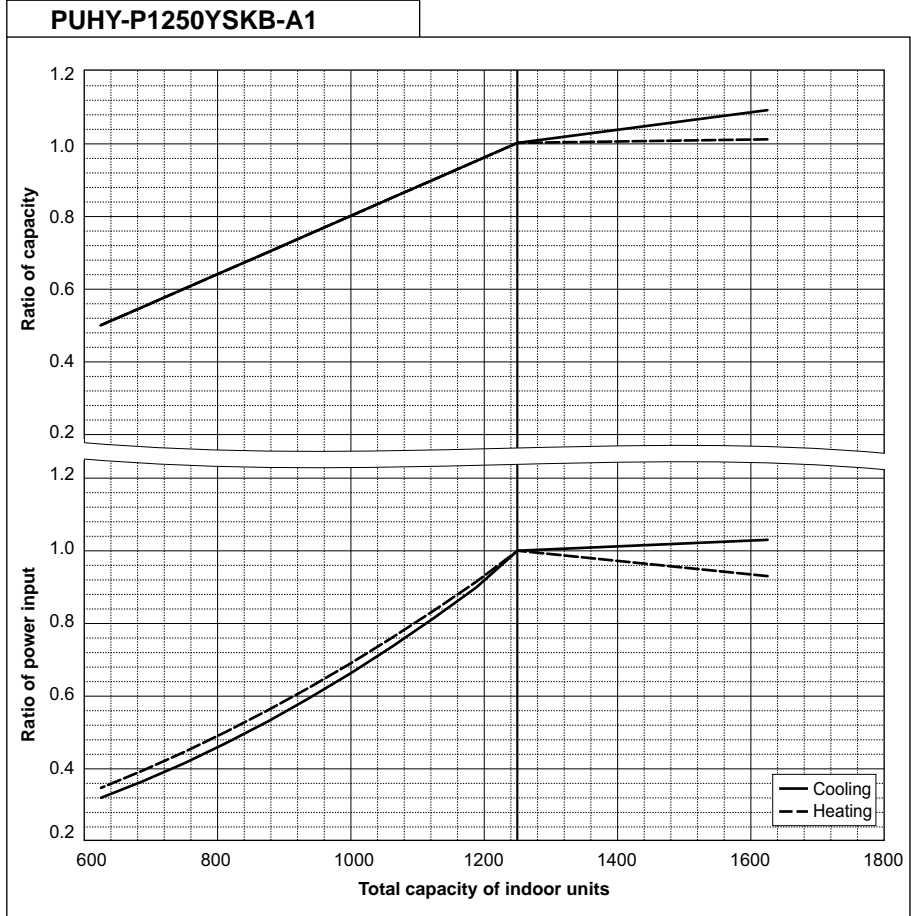

PUHY-P1300YSKB-A1		
Nominal Cooling Capacity	kW	146.0
	BTU/h	498,200
Input	kW	47.80

PUHY-P1300YSKB-A1		
Nominal Heating Capacity	kW	163.0
	BTU/h	556,200
Input	kW	46.04

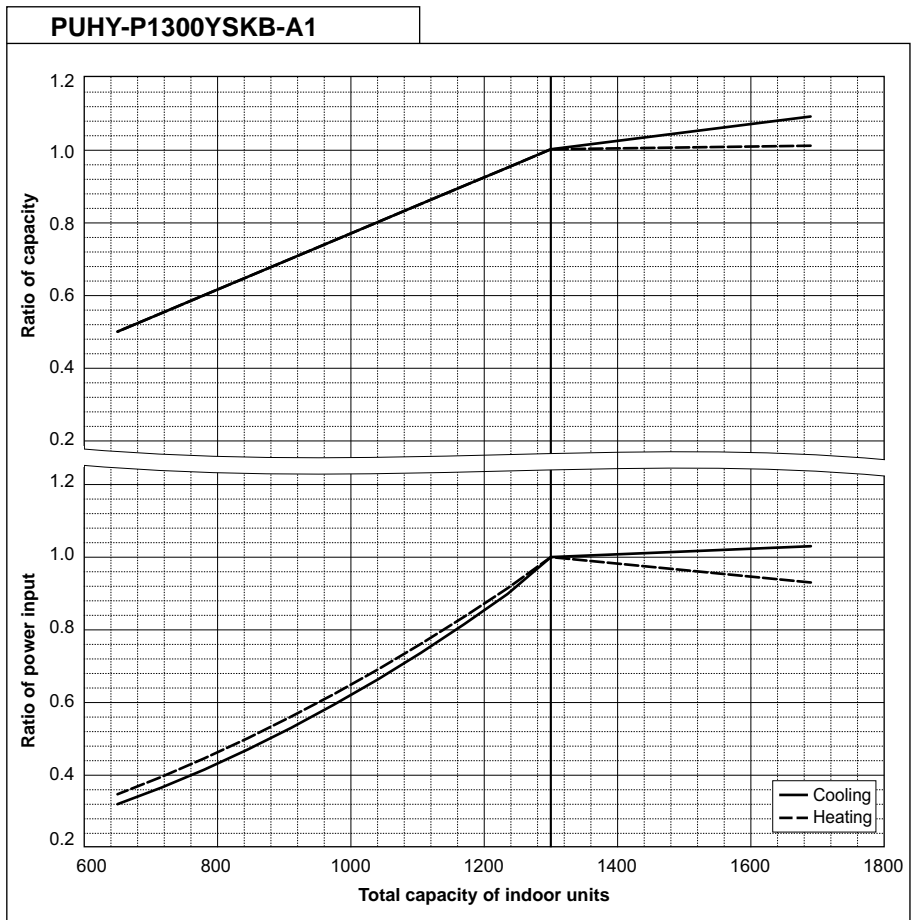

PUHY-P1350YSKB-A1		
Nominal Cooling Capacity	kW	150.0
	BTU/h	511,800
Input	kW	47.40

PUHY-P1350YSKB-A1		
Nominal Heating Capacity	kW	168.0
	BTU/h	573,200
Input	kW	49.12

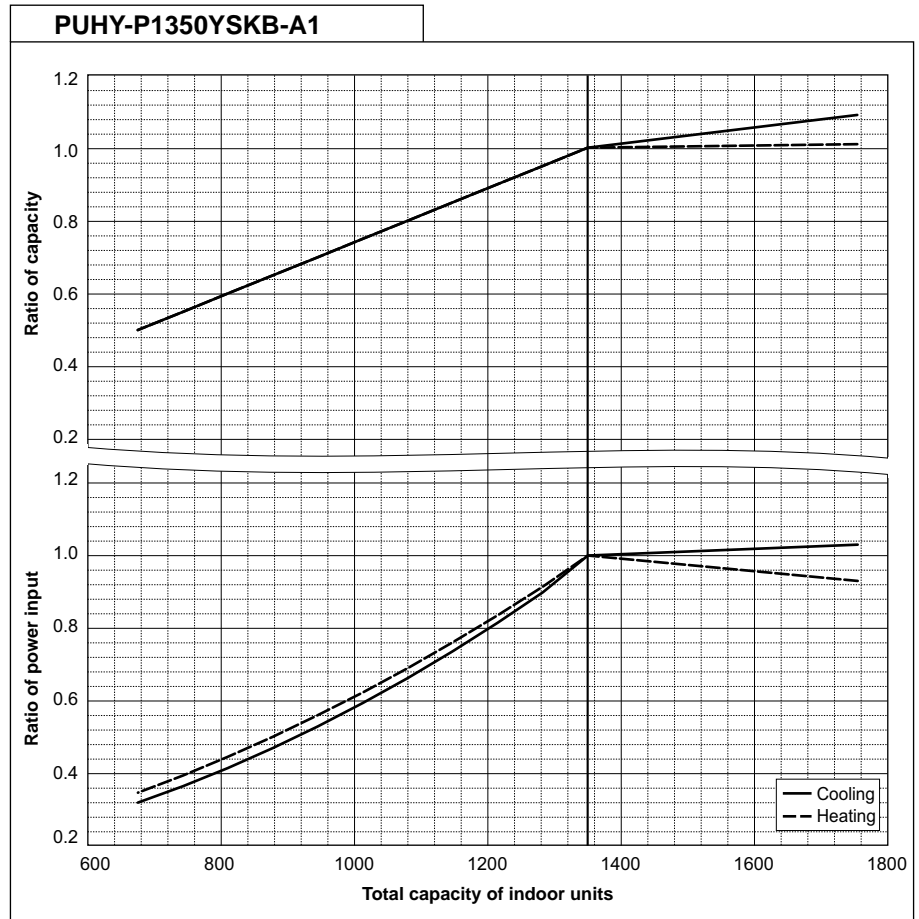

8-4. Correction by refrigerant piping length

CITY MULTI system can extend the piping flexibly within its limitation for the actual situation. However, a decrease of cooling/heating capacity could happen correspondently. Using following correction factor according to the equivalent length of the piping shown at 8-4-1 and 8-4-2, the capacity can be observed. 8-4-3 shows how to obtain the equivalent length of piping.

8-4-1. Cooling capacity correction

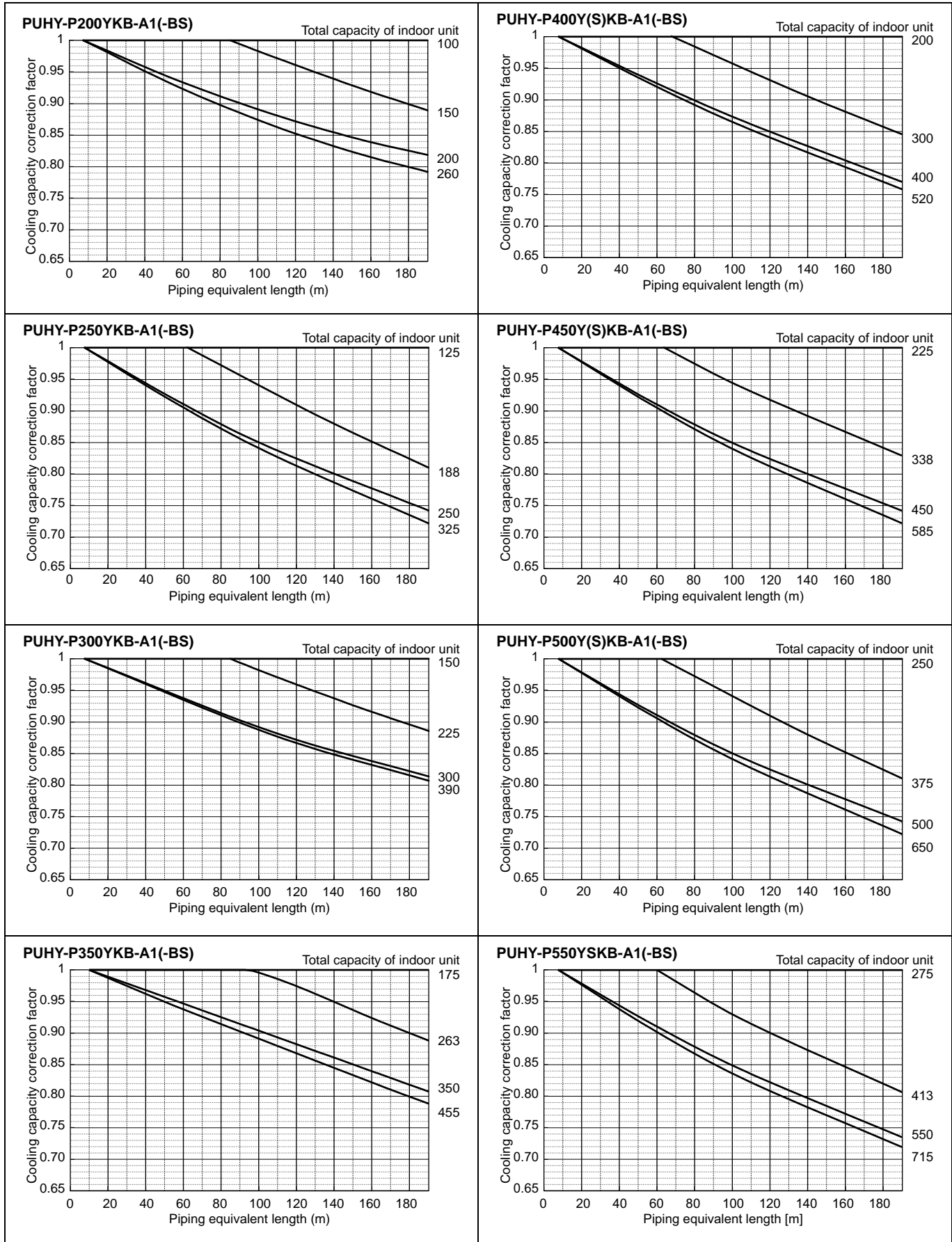

8. CAPACITY TABLES

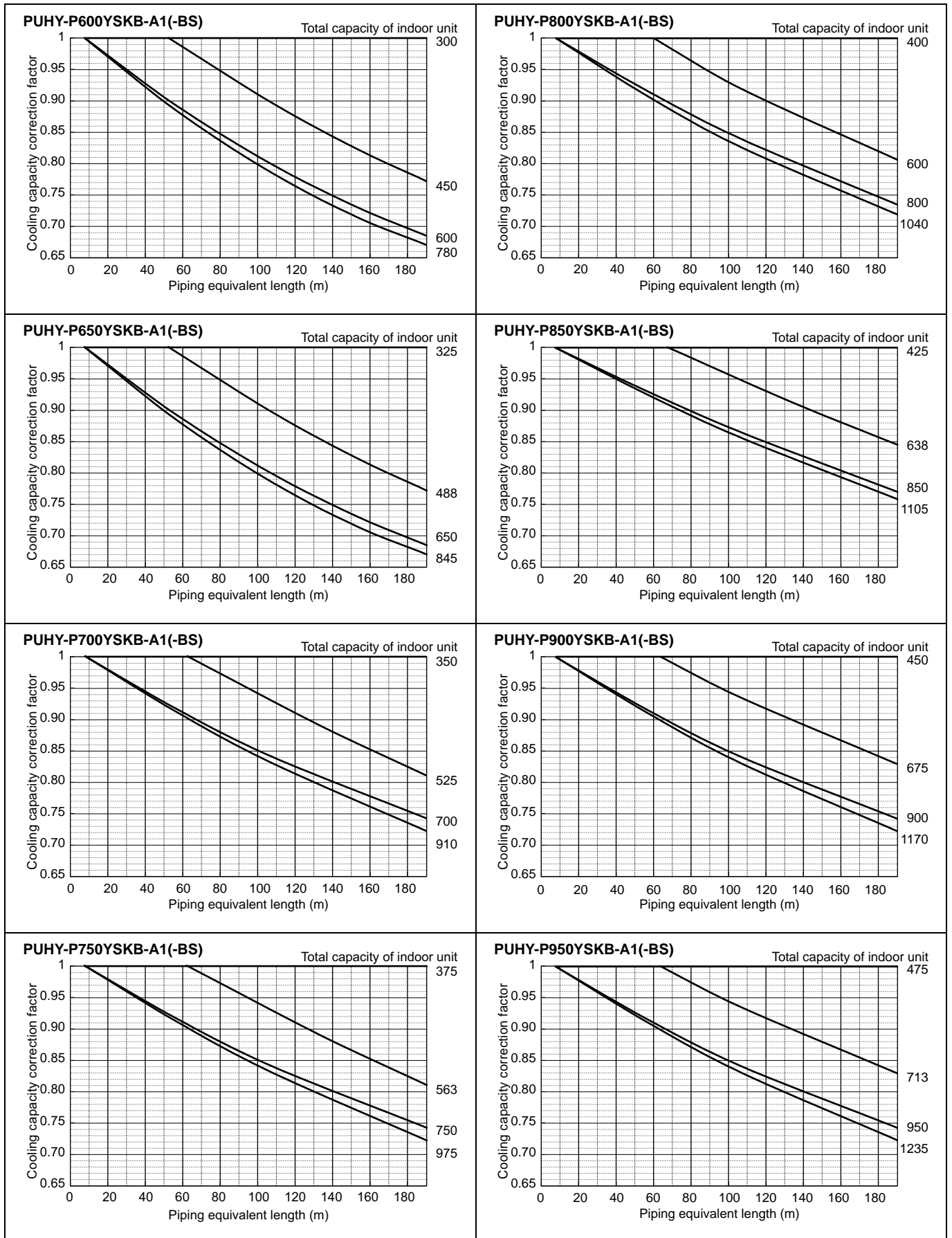

8. CAPACITY TABLES

Y

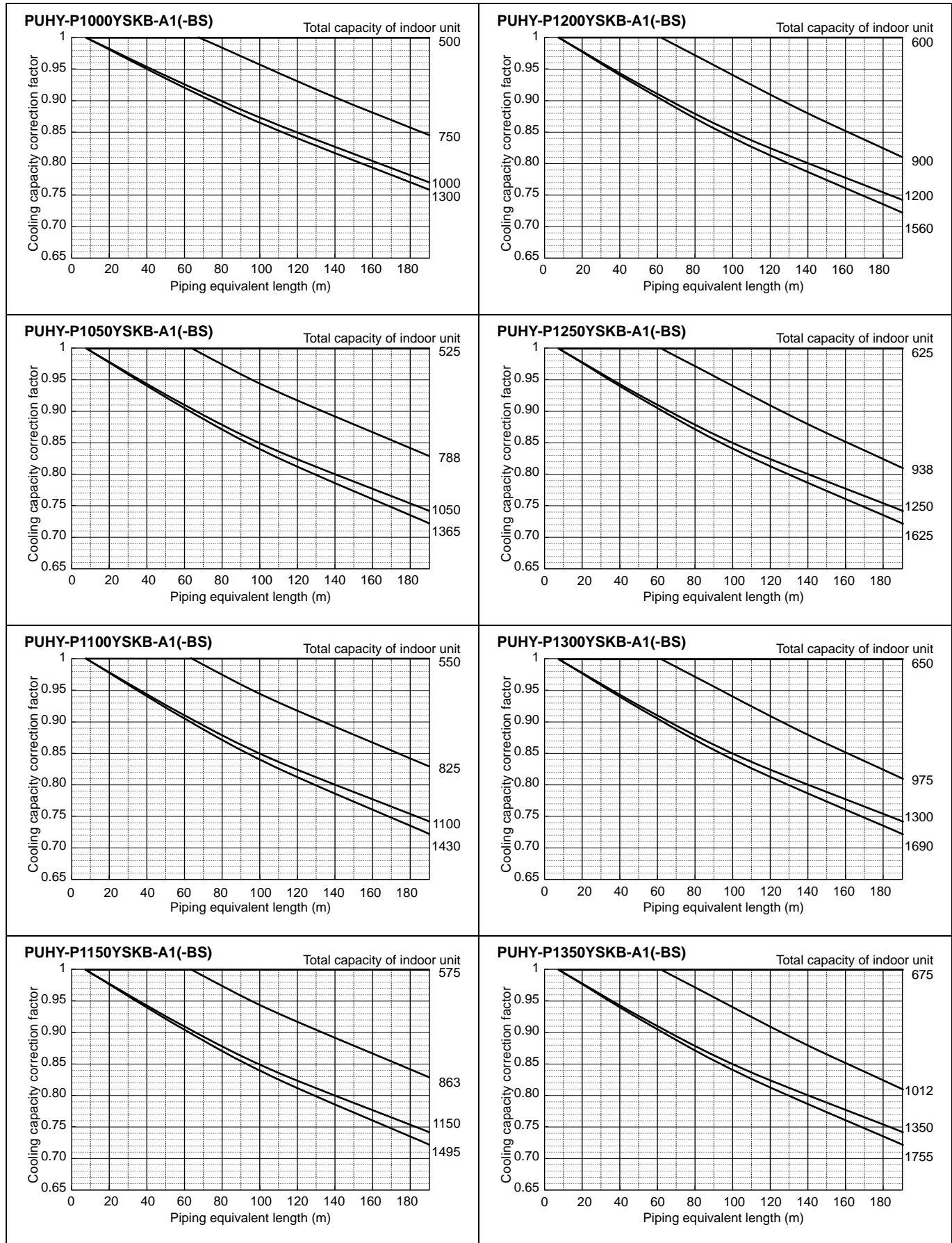

8-4-2. Heating capacity correction

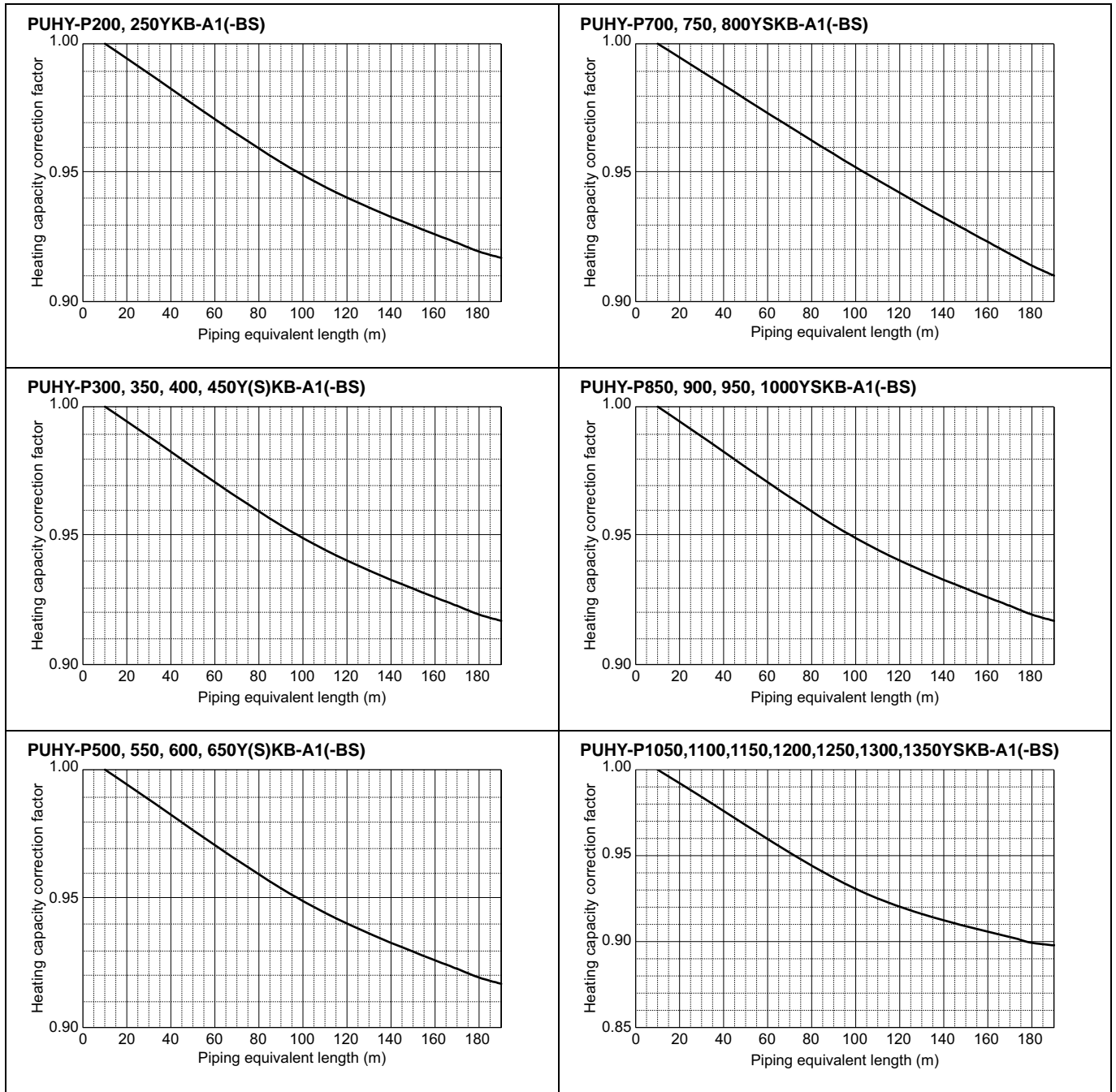

8-4-3. How to obtain the equivalent piping length

- 1 **PUHY-P200YKB-A1(-BS)**
Equivalent length = (Actual piping length to the farthest indoor unit) + (0.42 × number of bends in the piping) m
- 2 **PUHY-P250YKB-A1(-BS)**
Equivalent length = (Actual piping length to the farthest indoor unit) + (0.42 × number of bends in the piping) m
- 3 **PUHY-P300YKB-A1(-BS)**
Equivalent length = (Actual piping length to the farthest indoor unit) + (0.42 × number of bends in the piping) m
- 4 **PUHY-P350YKB-A1(-BS)**
Equivalent length = (Actual piping length to the farthest indoor unit) + (0.47 × number of bends in the piping) m
- 5 **PUHY-P400, 450, 500, 550, 600, 650Y(S)KB-A1(-BS)**
Equivalent length = (Actual piping length to the farthest indoor unit) + (0.50 × number of bends in the piping) m
- 6 **PUHY-P700, 750, 800YSKB-A1(-BS)**
Equivalent length = (Actual piping length to the farthest indoor unit) + (0.70 × number of bends in the piping) m
- 7 **PUHY-P850, 900, 950, 1000, 1050, 1100, 1150, 1200, 1250, 1300, 1350YSKB-A1(-BS)**
Equivalent length = (Actual piping length to the farthest indoor unit) + (0.80 × number of bends in the piping) m

8-5. Correction at frost and defrost

Due to frost at the outdoor heat exchanger and the automatic defrost operation, the heating capacity of the outdoor unit can be calculated by multiplying the correction factor shown in the table below.

Table of correction factor at frost and defrost

Outdoor inlet air temp. °C	6	4	2	1	0	-2	-4	-6	-8	-10	-20
Outdoor inlet air temp. °F	43	39	36	34	32	28	25	21	18	14	-4
PUHY-P200YKB-A1(-BS)	1.00	0.95	0.84	0.825	0.83	0.87	0.90	0.95	0.95	0.95	0.95
PUHY-P250YKB-A1(-BS)	1.00	0.95	0.84	0.825	0.83	0.87	0.90	0.95	0.95	0.95	0.95
PUHY-P300YKB-A1(-BS)	1.00	0.98	0.89	0.87	0.89	0.90	0.92	0.95	0.95	0.95	0.95
PUHY-P350YKB-A1(-BS)	1.00	0.98	0.89	0.87	0.89	0.90	0.92	0.95	0.95	0.95	0.95
PUHY-P400YKB-A1(-BS)	1.00	0.98	0.89	0.87	0.89	0.90	0.92	0.95	0.95	0.95	0.95
PUHY-P450YKB-A1(-BS)	1.00	0.98	0.89	0.87	0.89	0.90	0.92	0.95	0.95	0.95	0.95
PUHY-P500YKB-A1(-BS)	1.00	0.98	0.89	0.87	0.89	0.90	0.92	0.95	0.95	0.95	0.95
PUHY-P400YSKB-A1(-BS)	1.00	0.98	0.89	0.86	0.89	0.90	0.92	0.95	0.95	0.95	0.95
PUHY-P450YSKB-A1(-BS)	1.00	0.98	0.89	0.86	0.89	0.90	0.92	0.95	0.95	0.95	0.95
PUHY-P500YSKB-A1(-BS)	1.00	0.98	0.89	0.86	0.89	0.90	0.92	0.95	0.95	0.95	0.95
PUHY-P550YSKB-A1(-BS)	1.00	0.94	0.87	0.86	0.87	0.88	0.90	0.90	0.93	0.93	0.93
PUHY-P600YSKB-A1(-BS)	1.00	0.94	0.87	0.86	0.87	0.88	0.90	0.90	0.93	0.93	0.93
PUHY-P650YSKB-A1(-BS)	1.00	0.94	0.87	0.86	0.87	0.88	0.90	0.90	0.93	0.93	0.93
PUHY-P700YSKB-A1(-BS)	1.00	0.98	0.89	0.88	0.89	0.90	0.92	0.95	0.95	0.95	0.95
PUHY-P750YSKB-A1(-BS)	1.00	0.98	0.89	0.88	0.89	0.90	0.92	0.95	0.95	0.95	0.95
PUHY-P800YSKB-A1(-BS)	1.00	0.98	0.89	0.88	0.89	0.90	0.92	0.95	0.95	0.95	0.95
PUHY-P850YSKB-A1(-BS)	1.00	0.94	0.87	0.86	0.87	0.88	0.90	0.90	0.93	0.93	0.93
PUHY-P900YSKB-A1(-BS)	1.00	0.94	0.87	0.86	0.87	0.88	0.90	0.90	0.93	0.95	0.95
PUHY-P950YSKB-A1(-BS)	1.00	0.94	0.87	0.86	0.87	0.88	0.90	0.90	0.93	0.93	0.93
PUHY-P1000YSKB-A1(-BS)	1.00	0.94	0.87	0.86	0.87	0.88	0.90	0.90	0.93	0.93	0.93
PUHY-P1050YSKB-A1(-BS)	1.00	0.94	0.87	0.86	0.87	0.88	0.90	0.90	0.93	0.93	0.93
PUHY-P1100YSKB-A1(-BS)	1.00	0.94	0.87	0.86	0.87	0.88	0.90	0.90	0.93	0.93	0.93
PUHY-P1150YSKB-A1(-BS)	1.00	0.94	0.87	0.86	0.87	0.88	0.90	0.90	0.93	0.93	0.93
PUHY-P1200YSKB-A1(-BS)	1.00	0.94	0.87	0.86	0.87	0.88	0.90	0.90	0.93	0.93	0.93
PUHY-P1250YSKB-A1(-BS)	1.00	0.93	0.82	0.80	0.82	0.86	0.90	0.90	0.95	0.95	0.95
PUHY-P1300YSKB-A1(-BS)	1.00	0.93	0.82	0.80	0.82	0.86	0.90	0.90	0.95	0.95	0.95
PUHY-P1350YSKB-A1(-BS)	1.00	0.93	0.82	0.80	0.82	0.86	0.90	0.90	0.95	0.95	0.95

9-1. JOINT

CITY MULTI units can be easily connected by using Joint sets and Header sets provided by Mitsubishi Electric. Four kinds of Joint sets are available for use. Refer to section 3 in "System Design" or the Installation Manual that comes with the Joint set for how to install the Joint set.

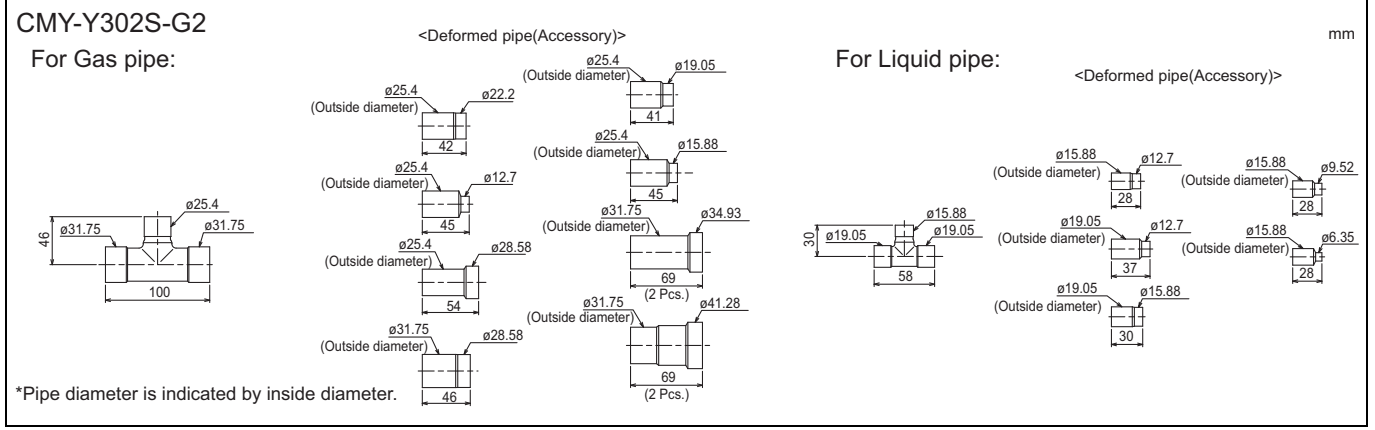
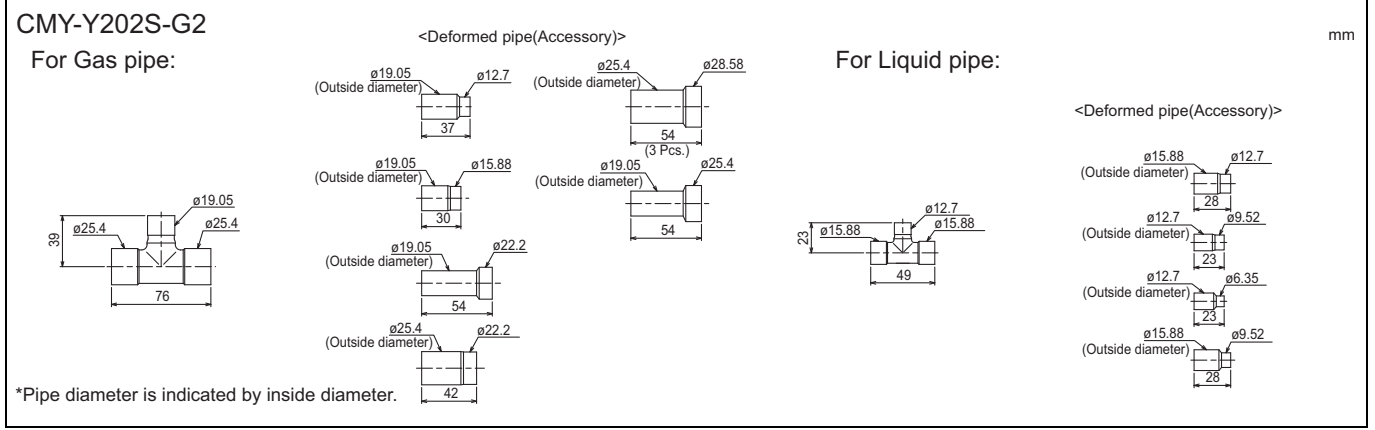
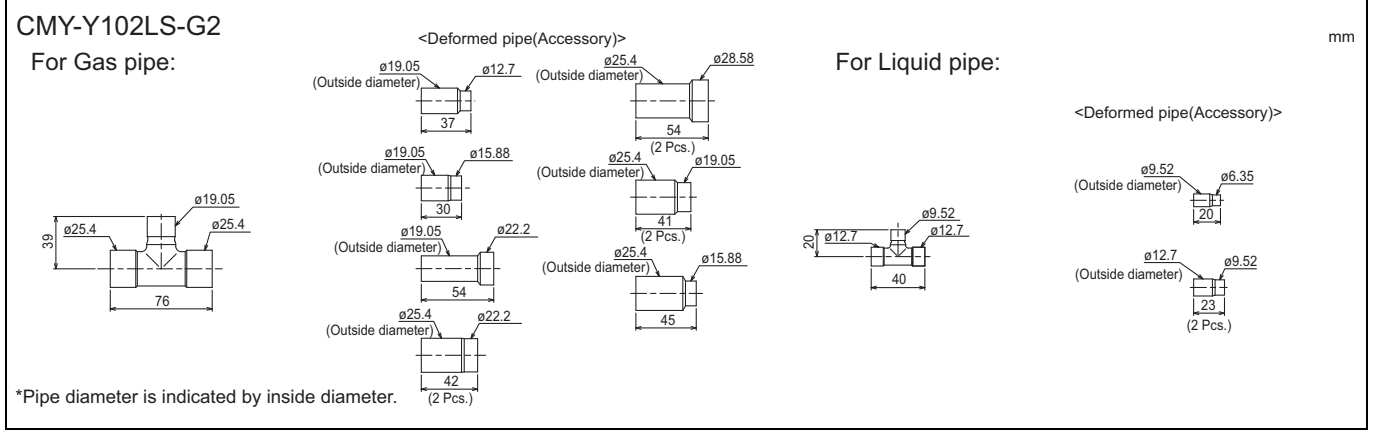
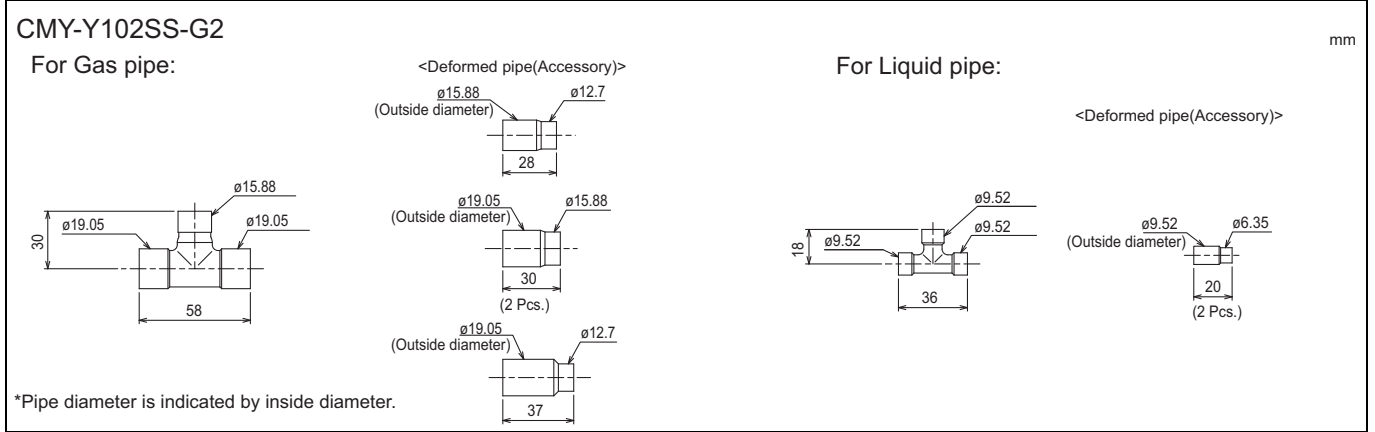

9-2. HEADER

CITY MULTI units can be easily connected by using Joint sets and Header sets provided by Mitsubishi Electric. Three kinds of Header sets are available for use. Refer to section 3 in "System Design" or the Installation Manual that comes with the Header set for how to install the Header set.

CMY-Y104-G Ref.: CMY_Y104-G_EXD_EUDB_SI mm

For Gas pipe:

<Deformed pipe(Accessory)>

For Liquid pipe:

<Deformed pipe(Accessory)>

ID: Inner Diameter OD: Outer Diameter
 NOTE: Besides above mentioned accessories, caps for pipe of φ 6.35, φ 9.52, φ 12.7, φ 15.88 (each diameter 1 piece) are included in the Header set.

CMY-Y108-G Ref.: CMY_Y108-G_EXD_EUDB_SI mm

For Gas pipe:

<Deformed pipe(Accessory)>

For Liquid pipe:

<Deformed pipe(Accessory)>

ID: Inner Diameter OD: Outer Diameter
 NOTE: Besides above mentioned accessories, caps for pipe of φ 6.35, φ 9.52, φ 12.7, φ 15.88 (each diameter 2 pieces) and 1 cap for pipe of φ 19.05 are included in the Header set.

CMY-Y1010-G Ref.: CMY_Y1010-G_EXD_EUDB_SI mm

For Gas pipe:

<Deformed pipe(Accessory)>

For Liquid pipe:

<Deformed pipe(Accessory)>

ID: Inner Diameter OD: Outer Diameter
 NOTE: Besides above mentioned accessories, caps for pipe of φ 6.35, φ 9.52, φ 12.7, φ 15.88 (each diameter 2 pieces) and 1 cap for pipe of φ 19.05 are included in the Header set.

9-3. OUTDOOR TWINNING KIT

The following optional Outdoor Twinning Kit is needed to use to combine multiple refrigerant pipes. Refer to the chapter entitled System Design Section for the details of selecting a proper twinning kit.

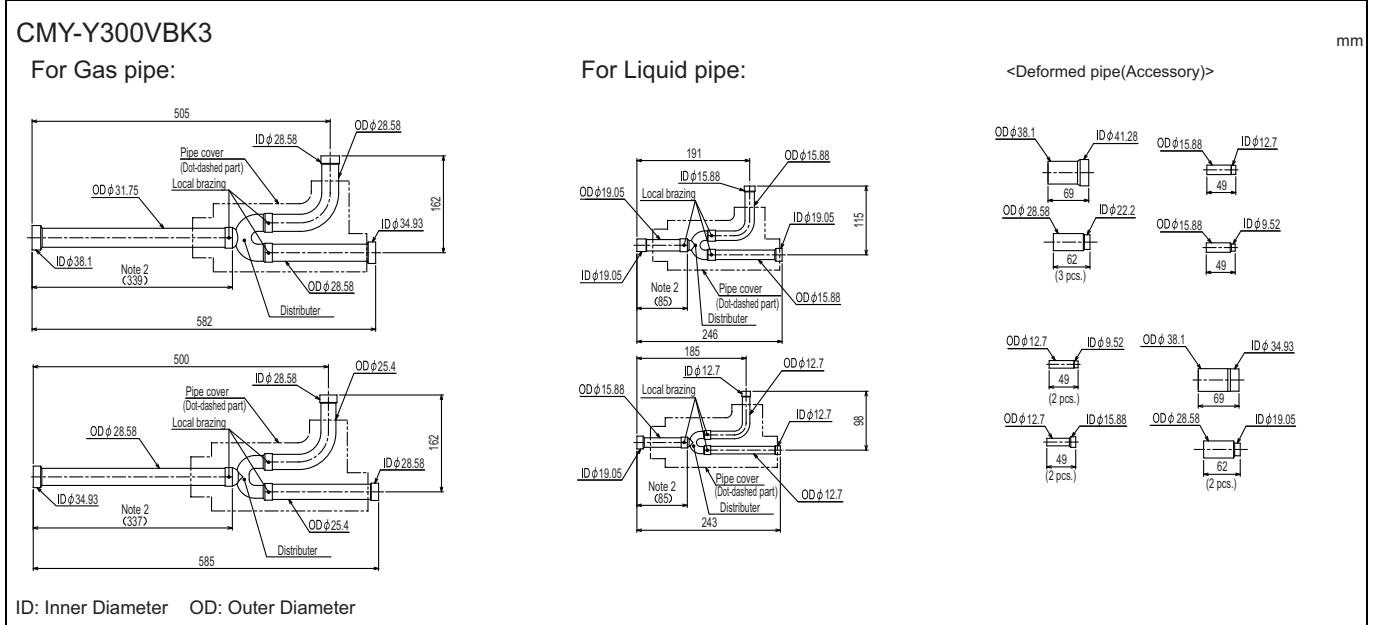
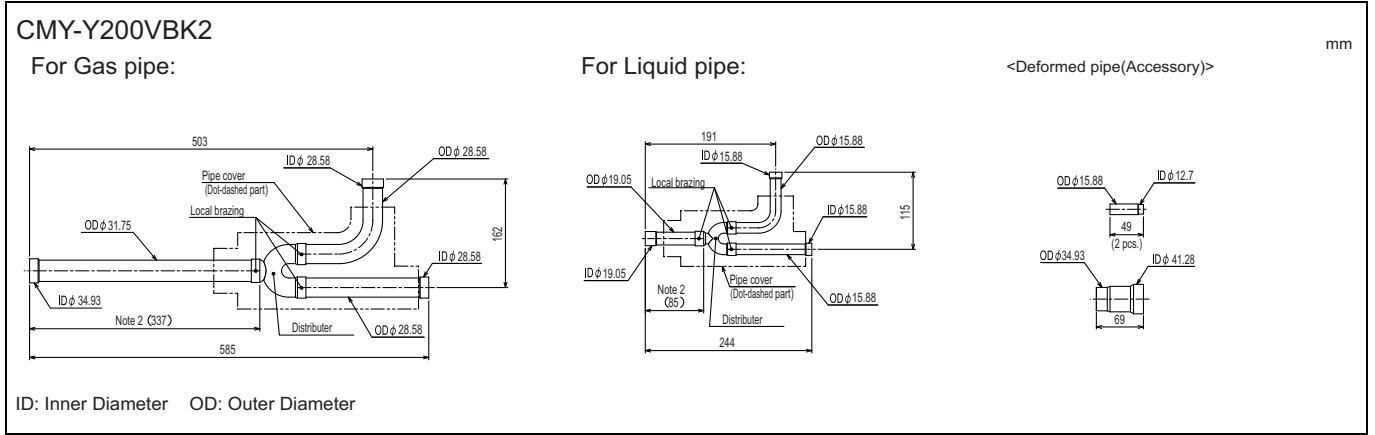
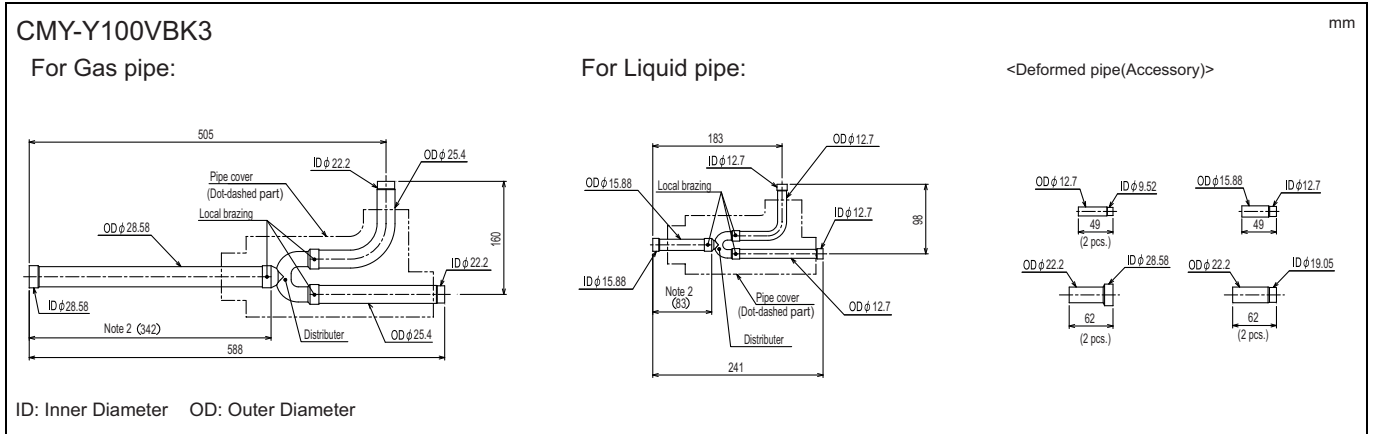

Note 1. Refer to the figure below for the installation position of the twinning pipe.

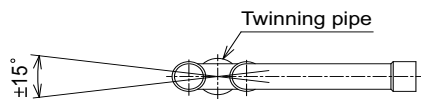

Slope of the twinning pipes are at an angle within $\pm 15^\circ$ to the horizontal plane.

2. Use the attached pipe to braze the port-opening of the twinning pipe.
3. Pipe diameter is indicated by inside diameter.
4. Only use the twinning pipe by Mitsubishi (optional parts).

9-4. RELAY BOX

If there is a risk that the drain water will freeze inside the outdoor unit, the installation of a base heater is recommended. PAC-BH02KTY-E is a relay box for controlling the electric base heater. For details, refer to the relay box Installation Manual.

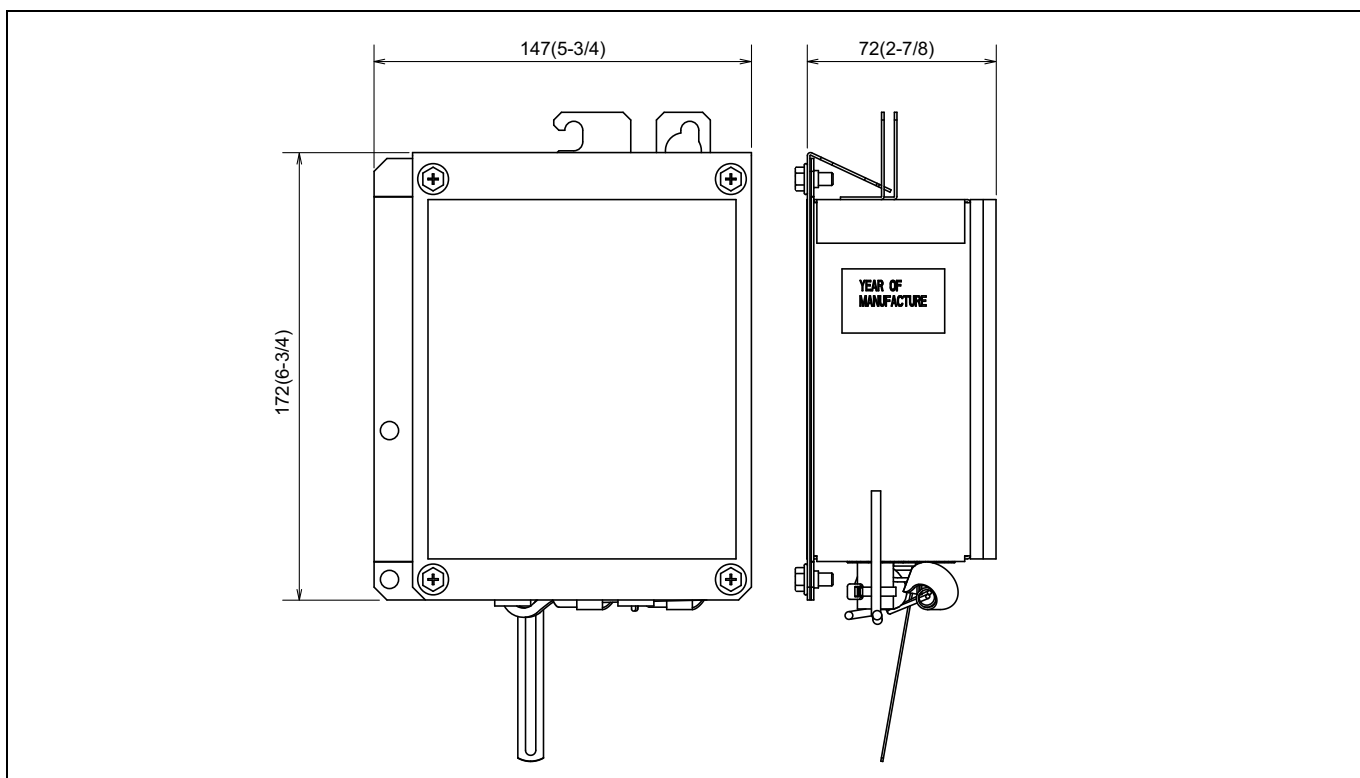

9-5. BASE HEATER

If there is a risk that the drain water will freeze inside the outdoor unit, the installation of a base heater is recommended. For details, refer to the base heater Installation Manual.

PAC-BH04EHT-E (for S module)

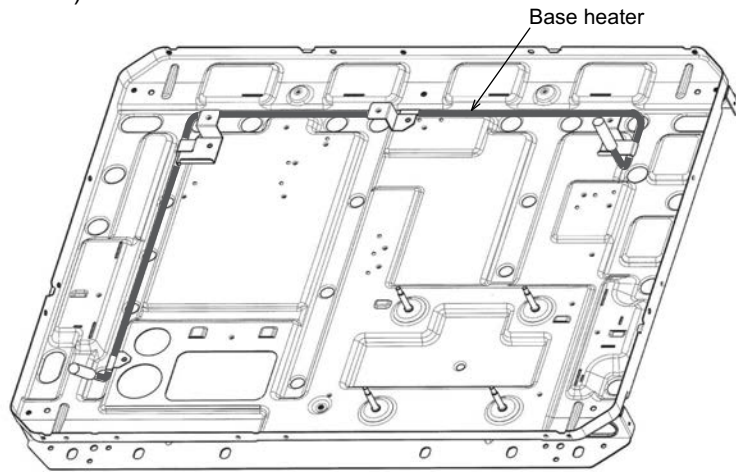

PAC-BH05EHT-E (for L module)

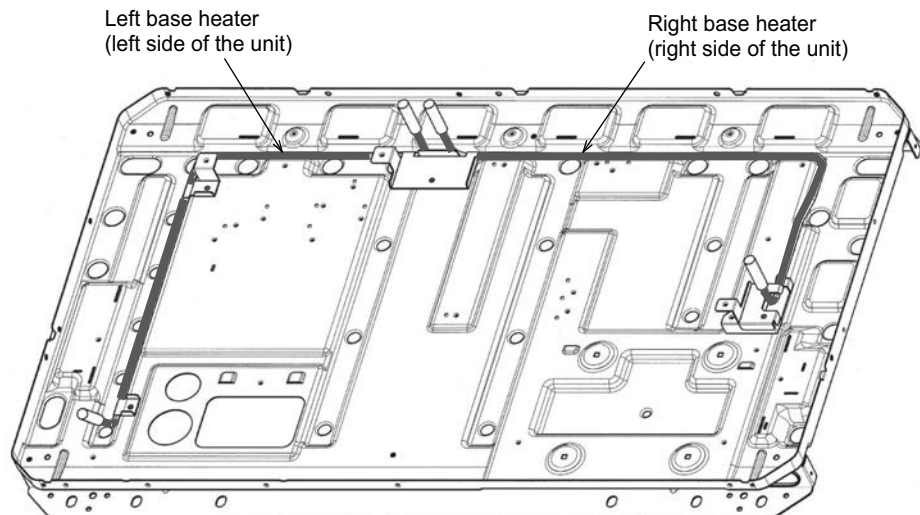

PAC-BH06EHT-E (for XL module)

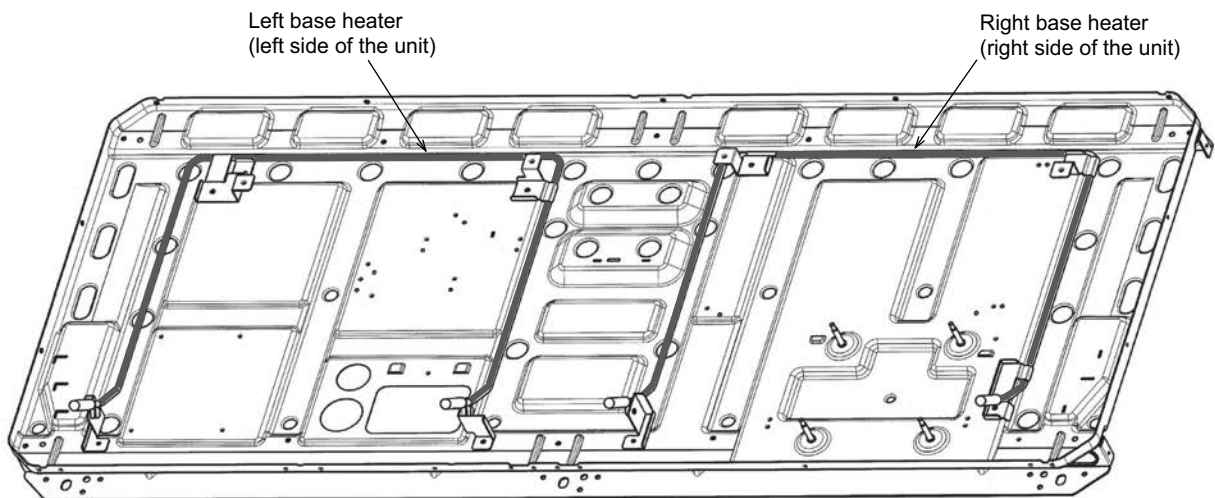

OUTDOOR UNITS

1. SPECIFICATIONS	2 - 114
2. EXTERNAL DIMENSIONS	2 - 135
3. CENTER OF GRAVITY	2 - 150
4. ELECTRICAL WIRING DIAGRAMS	2 - 151
5. SOUND LEVELS	2 - 154
6. VIBRATION LEVEL	2 - 161
7. OPERATION TEMPERATURE RANGE	2 - 162
8. CAPACITY TABLES	2 - 163
8-1. Selection of Cooling/Heating Units	2 - 164
8-2. Correction by temperature	2 - 166
8-3. Correction by total indoor	2 - 190
8-4. Correction by refrigerant piping length	2 - 202
8-5. Correction at frost and defrost	2 - 206
9. OPTIONAL PARTS	2 - 207
9-1. JOINT	2 - 207
9-2. HEADER	2 - 208
9-3. OUTDOOR TWINNING KIT	2 - 209
9-4. RELAY BOX	2 - 210
9-5. BASE HEATER	2 - 211

1. SPECIFICATIONS

YKB/YLM

Y (HIGH COP)

Model		PUHY-EP200YLM-A (-BS)		PUHY-EP250YLM-A (-BS)	
Power source		3-phase 4-wire 380-400-415 V 50/60 Hz		3-phase 4-wire 380-400-415 V 50/60 Hz	
Cooling capacity (Nominal)	*1	kW	22.4	28.0	
		kcal/h	20,000	25,000	
		BTU/h	76,400	95,500	
	Power input	kW	5.19	6.89	
		Current input	A	8.7-8.3-8.0	11.6-11.0-10.6
EER		kW/kW	4.31	4.06	
Temp. range of cooling	Indoor	W.B.	15.0~24.0°C (59~75°F)	15.0~24.0°C (59~75°F)	
	Outdoor	D.B.	-5.0~52.0°C (23~126°F)	-5.0~52.0°C (23~126°F)	
Heating capacity (Nominal)	*2	kW	25.0	31.5	
		kcal/h	21,500	27,100	
		BTU/h	85,300	107,500	
	Power input	kW	5.73	7.68	
		Current input	A	9.6-9.1-8.8	12.9-12.3-11.8
		COP	kW/kW	4.36	4.10
Temp. range of heating	Indoor	D.B.	15.0~27.0°C (59~81°F)	15.0~27.0°C (59~81°F)	
	Outdoor	W.B.	-20.0~15.5°C (-4~60°F)	-20.0~15.5°C (-4~60°F)	
Indoor unit connectable	Total capacity	50~130% of outdoor unit capacity		50~130% of outdoor unit capacity	
	Model/Quantity	P15~P250/1~17		P15~P250/1~21	
Sound pressure level (measured in anechoic room)	dB <A>	57		60	
Sound power level (measured in anechoic room)	dB <A>	79.5		80	
Refrigerant piping diameter	Liquid pipe	mm (in.)	9.52 (3/8) Brazed	9.52 (3/8) Brazed (12.7 (1/2) Brazed, farthest length >= 90 m)	
	Gas pipe	mm (in.)	22.2 (7/8) Brazed	22.2 (7/8) Brazed	
FAN	Type x Quantity		Propeller fan x 1		
	Air flow rate	m ³ /min	175		
		L/s	2,917		
		cfm	6,179		
	Control, Driving mechanism		Inverter-control, Direct-driven by motor		
	Motor output	kW	0.92 x 1		
*3 External static press.		0 Pa (0 mmH ₂ O)			
Compressor	Type x Quantity		Inverter scroll hermetic compressor		
	Manufacture		AC&R Works, MITSUBISHI ELECTRIC CORPORATION		
	Starting method		Inverter		
	Motor output	kW	5.6		
	Case heater	kW	-		
	Lubricant		MEL32		
External finish		Pre-coated galvanized steel sheets (+powder coating for -BS type) <MUNSELL 5Y 8/1 or similar>		Pre-coated galvanized steel sheets (+powder coating for -BS type) <MUNSELL 5Y 8/1 or similar>	
External dimension H x W x D		mm	1,710 (1,650 without legs) x 920 x 740		
		in.	67-3/8 (65 without legs) x 36-1/4 x 29-3/16		
Protection devices	High pressure protection		High pressure sensor, High pressure switch at 4.15 MPa (601 psi)		
	Inverter circuit (COMP./FAN)		Over-heat protection, Over-current protection		
	Compressor		-		
	Fan motor		-		
Refrigerant	Type x original charge		R410A x 7.5 kg (17 lbs)		
	Control		LEV and HIC circuit		
Net weight		kg (lbs)	208 (459)		
Heat exchanger		Salt-resistant cross fin & aluminium tube		Salt-resistant cross fin & aluminium tube	
HIC circuit (HIC: Heat Inter-Changer)		Copper pipe, tube-in-tube structure		Copper pipe, tube-in-tube structure	
Defrosting method		Auto-defrost mode (Reversed refrigerant cycle, Hot gas)		Auto-defrost mode (Reversed refrigerant cycle, Hot gas)	
Drawing	External	WKJ94L352		WKJ94L352	
	Wiring	WKE94C946		WKE94C946	
Standard attachment	Document	Installation Manual		Installation Manual	
	Accessory	Refrigerant conn. pipe		Refrigerant conn. pipe	
Optional parts		Joint: CMY-Y102SS/LS-G2 Header: CMY-Y104/108/1010-G		Joint: CMY-Y102SS/LS-G2 Header: CMY-Y104/108/1010-G	
Remarks		Details on foundation work, duct work, insulation work, electrical wiring, power source switch, and other items shall be referred to the Installation Manual. Due to continuing improvement, above specifications may be subject to change without notice.			

Notes:	Unit converter
1.Nominal cooling conditions (subject to JIS B8615-1) Indoor: 27°C D.B./19°C W.B. (81°F D.B./66°F W.B.), Outdoor: 35°C D.B./24°C W.B. (95°F D.B./75°F W.B.) Pipe length: 7.5 m (24-9/16 ft.), Level difference: 0 m (0 ft.)	BTU/h =kW x 3,412
2.Nominal heating conditions (subject to JIS B8615-1) Indoor: 20°C D.B. (68°F D.B.), Outdoor: 7°C D.B./6°C W.B. (45°F D.B./43°F W.B.) Pipe length: 7.5 m (24-9/16 ft.), Level difference: 0 m (0 ft.)	cfm =m ³ /min x 35.31
3.External static pressure option is available (30Pa, 60Pa/3.1mmH ₂ O, 6.1mmH ₂ O).	lbs =kg/0.4536
	*Above specification data is subject to rounding variation.

1. SPECIFICATIONS

YKB/YLM

Y (HIGH COP)

Model			PUHY-EP300YLM-A (-BS)	PUHY-EP350YLM-A (-BS)
Power source			3-phase 4-wire 380-400-415 V 50/60 Hz	
Cooling capacity (Nominal)	*1	kW	33.5	40.0
		kcal/h	30,000	35,000
		BTU/h	114,300	136,500
	Power input	kW	8.56	11.69
		A	14.4-13.7-13.2	19.7-18.7-18.0
EER	kW/kW	3.91	3.42	
Temp. range of cooling	Indoor	W.B.	15.0-24.0°C (59-75°F)	15.0-24.0°C (59-75°F)
	Outdoor	D.B.	-5.0-52.0°C (23-126°F)	-5.0-52.0°C (23-126°F)
Heating capacity (Nominal)	*2	kW	37.5	45.0
		kcal/h	32,300	38,700
		BTU/h	128,000	153,500
	Power input	kW	9.16	12.53
		A	15.4-14.6-14.1	21.1-20.0-19.3
COP	kW/kW	4.09	3.59	
Temp. range of heating	Indoor	D.B.	15.0-27.0°C (59-81°F)	15.0-27.0°C (59-81°F)
	Outdoor	W.B.	-20.0-15.5°C (-4-60°F)	-20.0-15.5°C (-4-60°F)
Indoor unit connectable	Total capacity	50-130% of outdoor unit capacity		50-130% of outdoor unit capacity
	Model/Quantity	P15-P250/1-26		P15-P250/1-30
Sound pressure level (measured in anechoic room)	dB <A>		61	61
Sound power level (measured in anechoic room)	dB <A>		82	82.5
Refrigerant piping diameter	Liquid pipe	mm (in.)	9.52 (3/8) Brazed (12.7 (1/2) Brazed, farthest length >= 40 m)	12.7 (1/2) Brazed
	Gas pipe	mm (in.)	28.58 (1-1/8) Brazed	28.58 (1-1/8) Brazed
FAN	Type x Quantity		Propeller fan x 1	
	Air flow rate	m ³ /min	200	200
		L/s	3,333	3,333
		cfm	7,062	7,062
	Control, Driving mechanism		Inverter-control, Direct-driven by motor	
	Motor output	kW	0.92 x 1	0.92 x 1
*3 External static press.	0 Pa (0 mmH ₂ O)		0 Pa (0 mmH ₂ O)	
Compressor	Type x Quantity		Inverter scroll hermetic compressor	
	Manufacture		AC&R Works, MITSUBISHI ELECTRIC CORPORATION	
	Starting method		Inverter	
	Motor output	kW	8.1	10.5
	Case heater	kW	-	-
	Lubricant		MEL32	
External finish			Pre-coated galvanized steel sheets (+powder coating for -BS type) <MUNSELL 5Y 8/1 or similar>	
External dimension H x W x D			1,710 (1,650 without legs) x 1,220 x 740 67-3/8 (65 without legs) x 48-1/16 x 29-3/16	
Protection devices	High pressure protection		High pressure sensor, High pressure switch at 4.15 MPa (601 psi)	
	Inverter circuit (COMP./FAN)		Over-heat protection, Over-current protection	
	Compressor		-	
	Fan motor		-	
Refrigerant	Type x original charge		R410A x 10.3 kg (23 lbs)	
	Control		LEV and HIC circuit	
Net weight		kg (lbs)	252 (556)	252 (556)
Heat exchanger			Salt-resistant cross fin & aluminium tube	
HIC circuit (HIC: Heat Inter-Changer)			Copper pipe, tube-in-tube structure	
Defrosting method			Auto-defrost mode (Reversed refrigerant cycle, Hot gas)	
Drawing	External	WKJ94L355		WKJ94L355
	Wiring	WKE94C946		WKE94C946
Standard attachment	Document	Installation Manual		Installation Manual
	Accessory	Refrigerant conn. pipe		Refrigerant conn. pipe
Optional parts			Joint: CMY-Y102SS/LS-G2 Header: CMY-Y104/108/1010-G	
Remarks			Details on foundation work, duct work, insulation work, electrical wiring, power source switch, and other items shall be referred to the Installation Manual. Due to continuing improvement, above specifications may be subject to change without notice.	

Notes:	Unit converter
1.Nominal cooling conditions (subject to JIS B8615-1) Indoor: 27°C D.B./19°C W.B. (81°F D.B./66°F W.B.), Outdoor: 35°C D.B./24°C W.B. (95°F D.B./75°F W.B.) Pipe length: 7.5 m (24-9/16 ft.), Level difference: 0 m (0 ft.)	BTU/h =kW x 3,412
2.Nominal heating conditions (subject to JIS B8615-1) Indoor: 20°C D.B. (68°F D.B.), Outdoor: 7°C D.B./6°C W.B. (45°F D.B./43°F W.B.) Pipe length: 7.5 m (24-9/16 ft.), Level difference: 0 m (0 ft.)	cfm =m ³ /min x 35.31
3.External static pressure option is available (30Pa, 60Pa/3.1mmH ₂ O, 6.1mmH ₂ O).	lbs =kg/0.4536
	*Above specification data is subject to rounding variation.

1. SPECIFICATIONS

YKB/YLM

Y (HIGH COP)

Model			PUHY-EP400YLM-A (-BS)	PUHY-EP450YLM-A (-BS)
Power source			3-phase 4-wire 380-400-415 V 50/60 Hz	
Cooling capacity (Nominal)	*1	kW	45.0	50.0
		kcal/h	40,000	45,000
		BTU/h	153,500	170,600
	Power input	kW	12.26	14.79
		A	20.6-19.6-18.9	24.9-23.7-22.8
EER	kW/kW	3.67	3.38	
Temp. range of cooling	Indoor	W.B.	15.0~24.0°C (59~75°F)	15.0~24.0°C (59~75°F)
	Outdoor	D.B.	-5.0~52.0°C (23~126°F)	-5.0~52.0°C (23~126°F)
Heating capacity (Nominal)	*2	kW	50.0	56.0
		kcal/h	45,000	50,000
		BTU/h	170,600	191,100
	Power input	kW	13.15	16.09
		A	22.1-21.0-20.3	27.1-25.8-24.8
	COP	kW/kW	3.80	3.48
Temp. range of heating	Indoor	D.B.	15.0~27.0°C (59~81°F)	15.0~27.0°C (59~81°F)
	Outdoor	W.B.	-20.0~15.5°C (-4~60°F)	-20.0~15.5°C (-4~60°F)
Indoor unit connectable	Total capacity		50~130% of outdoor unit capacity	50~130% of outdoor unit capacity
	Model/Quantity		P15~P250/1~34	P15~P250/1~39
Sound pressure level (measured in anechoic room)		dB <A>	62.5	63
Sound power level (measured in anechoic room)		dB <A>	82.5	83
Refrigerant piping diameter	Liquid pipe	mm (in.)	12.7 (1/2) Brazed	15.88 (5/8) Brazed
	Gas pipe	mm (in.)	28.58 (1-1/8) Brazed	28.58 (1-1/8) Brazed
FAN	Type x Quantity		Propeller fan x 2	Propeller fan x 2
	Air flow rate	m ³ /min	320	370
		L/s	5,333	6,167
		cfm	11,299	13,065
	Control, Driving mechanism		Inverter-control, Direct-driven by motor	Inverter-control, Direct-driven by motor
	Motor output	kW	0.92 x 2	0.92 x 2
*3 External static press.		0 Pa (0 mmH ₂ O)	0 Pa (0 mmH ₂ O)	
Compressor	Type x Quantity		Inverter scroll hermetic compressor	Inverter scroll hermetic compressor
	Manufacture		AC&R Works, MITSUBISHI ELECTRIC CORPORATION	AC&R Works, MITSUBISHI ELECTRIC CORPORATION
	Starting method		Inverter	Inverter
	Motor output	kW	10.9	12.4
	Case heater	kW	-	-
	Lubricant		MEL32	MEL32
External finish			Pre-coated galvanized steel sheets (+powder coating for -BS type) <MUNSELL 5Y 8/1 or similar>	Pre-coated galvanized steel sheets (+powder coating for -BS type) <MUNSELL 5Y 8/1 or similar>
External dimension H x W x D			mm 1,710 (1,650 without legs) x 1,750 x 740 67-3/8 (65 without legs) x 68-15/16 x 29-3/16	mm 1,710 (1,650 without legs) x 1,750 x 740 67-3/8 (65 without legs) x 68-15/16 x 29-3/16
Protection devices	High pressure protection		High pressure sensor, High pressure switch at 4.15 MPa (601 psi)	High pressure sensor, High pressure switch at 4.15 MPa (601 psi)
	Inverter circuit (COMP./FAN)		Over-heat protection, Over-current protection	Over-heat protection, Over-current protection
	Compressor		-	-
	Fan motor		-	-
Refrigerant	Type x original charge		R410A x 11.8 kg (27 lbs)	R410A x 11.8 kg (27 lbs)
	Control		LEV and HIC circuit	LEV and HIC circuit
Net weight			kg (lbs) 318 (702)	kg (lbs) 318 (702)
Heat exchanger			Salt-resistant cross fin & aluminium tube	Salt-resistant cross fin & aluminium tube
HIC circuit (HIC: Heat Inter-Changer)			Copper pipe, tube-in-tube structure	Copper pipe, tube-in-tube structure
Defrosting method			Auto-defrost mode (Reversed refrigerant cycle, Hot gas)	Auto-defrost mode (Reversed refrigerant cycle, Hot gas)
Drawing	External		WKJ94L358	WKJ94L358
	Wiring		WKE94C947	WKE94C947
Standard attachment	Document		Installation Manual	Installation Manual
	Accessory		Refrigerant conn. pipe	Refrigerant conn. pipe
Optional parts			Joint: CMY-Y102SS/LS-G2, CMY-Y202S-G2 Header: CMY-Y104/108/1010-G	Joint: CMY-Y102SS/LS-G2, CMY-Y202S-G2 Header: CMY-Y104/108/1010-G
Remarks			Details on foundation work, duct work, insulation work, electrical wiring, power source switch, and other items shall be referred to the Installation Manual. Due to continuing improvement, above specifications may be subject to change without notice.	

Notes:

- Nominal cooling conditions (subject to JIS B8615-1)
Indoor: 27°C D.B./19°C W.B. (81°F D.B./66°F W.B.), Outdoor: 35°C D.B./24°C W.B. (95°F D.B./75°F W.B.)
Pipe length: 7.5 m (24-9/16 ft.), Level difference: 0 m (0 ft.)
- Nominal heating conditions (subject to JIS B8615-1)
Indoor: 20°C D.B. (68°F D.B.), Outdoor: 7°C D.B./6°C W.B. (45°F D.B./43°F W.B.)
Pipe length: 7.5 m (24-9/16 ft.), Level difference: 0 m (0 ft.)
- External static pressure option is available (30Pa, 60Pa/3.1mmH₂O, 6.1mmH₂O).

Unit converter

BTU/h =kW x 3.412
cfm =m³/min x 35.31
lbs =kg/0.4536

*Above specification data is subject to rounding variation.

1. SPECIFICATIONS

YKB/YLM

Y (HIGH COP)

Model		PUHY-EP500YLM-A (-BS)	
Power source		3-phase 4-wire 380-400-415 V 50/60 Hz	
Cooling capacity (Nominal)	*1 kW	56.0	
	kcal/h	50,000	
	*1 BTU/h	191,100	
	Power input kW	18.72	
	Current input A	31.6-30.0-28.9	
EER		kW/kW 2.99	
Temp. range of cooling	Indoor	W.B.	15.0~24.0°C (59~75°F)
	Outdoor	D.B.	-5.0~52.0°C (23~126°F)
Heating capacity (Nominal)	*2 kW	63.0	
	kcal/h	54,200	
	*2 BTU/h	215,000	
	Power input kW	19.68	
	Current input A	33.2-31.5-30.4	
COP		kW/kW 3.20	
Temp. range of heating	Indoor	D.B.	15.0~27.0°C (59~81°F)
	Outdoor	W.B.	-20.0~15.5°C (-4~60°F)
Indoor unit connectable	Total capacity	50~130% of outdoor unit capacity	
	Model/Quantity	P15~P250/1~43	
Sound pressure level (measured in anechoic room)		dB <A>	63.5
Sound power level (measured in anechoic room)		dB <A>	83.5
Refrigerant piping diameter	Liquid pipe	mm (in.)	15.88 (5/8) Brazed
	Gas pipe	mm (in.)	28.58 (1-1/8) Brazed
FAN	Type x Quantity		Propeller fan x 2
	Air flow rate	m ³ /min	370
		L/s	6,167
		cfm	13,065
	Control, Driving mechanism		Inverter-control, Direct-driven by motor
	Motor output	kW	0.92 x 2
*3 External static press.	0 Pa (0 mmH ₂ O)		
Compressor	Type x Quantity		Inverter scroll hermetic compressor
	Manufacture		AC&R Works, MITSUBISHI ELECTRIC CORPORATION
	Starting method		Inverter
	Motor output	kW	13.4
	Case heater	kW	0.045
	Lubricant		MEL32
External finish		Pre-coated galvanized steel sheets (+powder coating for -BS type) <MUNSELL 5Y 8/1 or similar>	
External dimension H x W x D		mm	1,710 (1,650 without legs) x 1,750 x 740
		in.	67-3/8 (65 without legs) x 68-15/16 x 29-3/16
Protection devices	High pressure protection		High pressure sensor, High pressure switch at 4.15 MPa (601 psi)
	Inverter circuit (COMP./FAN)		Over-heat protection, Over-current protection
	Compressor		-
	Fan motor		-
Refrigerant	Type x original charge		R410A x 11.8 kg (27 lbs)
	Control		LEV and HIC circuit
Net weight	kg (lbs)	332 (732)	
Heat exchanger		Salt-resistant cross fin & aluminium tube	
HIC circuit (HIC: Heat Inter-Changer)		Copper pipe, tube-in-tube structure	
Defrosting method		Auto-defrost mode (Reversed refrigerant cycle, Hot gas)	
Drawing	External		WKJ94L358
	Wiring		WKE94G002
Standard attachment	Document		Installation Manual
	Accessory		Refrigerant conn. pipe
Optional parts		Joint: CMY-Y102SS/LS-G2, CMY-Y202S-G2 Header: CMY-Y104/108/1010-G	
Remarks		Details on foundation work, duct work, insulation work, electrical wiring, power source switch, and other items shall be referred to the Installation Manual. Due to continuing improvement, above specifications may be subject to change without notice.	

Notes:	Unit converter
1.Nominal cooling conditions (subject to JIS B8615-1) Indoor: 27°C D.B./19°C W.B. (81°F D.B./66°F W.B.), Outdoor: 35°C D.B./24°C W.B. (95°F D.B./75°F W.B.) Pipe length: 7.5 m (24-9/16 ft.), Level difference: 0 m (0 ft.)	BTU/h =kW x 3,412
2.Nominal heating conditions (subject to JIS B8615-1) Indoor: 20°C D.B. (68°F D.B.), Outdoor: 7°C D.B./6°C W.B. (45°F D.B./43°F W.B.) Pipe length: 7.5 m (24-9/16 ft.), Level difference: 0 m (0 ft.)	cfm =m ³ /min x 35.31
3.External static pressure option is available (30Pa, 60Pa/3.1mmH ₂ O, 6.1mmH ₂ O).	lbs =kg/0.4536
	*Above specification data is subject to rounding variation.

1. SPECIFICATIONS

YKB/YLM

Y (HIGH COP)

Model			PUHY-EP550YSLM-A (-BS)		
Power source			3-phase 4-wire 380-400-415 V 50/60 Hz		
Cooling capacity (Nominal)	*1	kW	63.0		
		kcal/h	54,200		
		BTU/h	215,000		
	Power input	kW	16.62		
		Current input	A	28.0-26.6-25.6	
EER		kW/kW	3.79		
Temp. range of cooling	Indoor	W.B.	15.0~24.0°C (59~75°F)		
	Outdoor	D.B.	-5.0~52.0°C (23~126°F)		
Heating capacity (Nominal)	*2	kW	69.0		
		kcal/h	59,300		
		BTU/h	235,400		
	Power input	kW	17.73		
		Current input	A	29.9-28.4-27.4	
COP		kW/kW	3.89		
Temp. range of heating	Indoor	D.B.	15.0~27.0°C (59~81°F)		
	Outdoor	W.B.	-20.0~15.5°C (-4~60°F)		
Indoor unit connectable	Total capacity		50~130% of outdoor unit capacity		
	Model/Quantity		P15~P250/2~47		
Sound pressure level (measured in anechoic room)		dB <A>	63.5		
Sound power level (measured in anechoic room)		dB <A>	84.5		
Refrigerant piping diameter	Liquid pipe	mm (in.)	15.88 (5/8) Brazed		
	Gas pipe	mm (in.)	28.58 (1-1/8) Brazed		

Set Model			PUHY-EP250YLM-A (-BS)			PUHY-EP300YLM-A (-BS)		
Model			PUHY-EP250YLM-A (-BS)			PUHY-EP300YLM-A (-BS)		
FAN	Type x Quantity		Propeller fan x 1			Propeller fan x 1		
	Air flow rate	m ³ /min	175			200		
		L/s	2,917			3,333		
		cfm	6,179			7,062		
	Control, Driving mechanism		Inverter-control, Direct-driven by motor			Inverter-control, Direct-driven by motor		
	Motor output	kW	0.92 x 1			0.92 x 1		
*3	External static press.		0 Pa (0 mmH ₂ O)			0 Pa (0 mmH ₂ O)		
Compressor	Type x Quantity		Inverter scroll hermetic compressor			Inverter scroll hermetic compressor		
	Manufacture		AC&R Works, MITSUBISHI ELECTRIC CORPORATION			AC&R Works, MITSUBISHI ELECTRIC CORPORATION		
	Starting method		Inverter			Inverter		
	Motor output	kW	6.9			8.1		
	Case heater	kW	-			-		
	Lubricant		MEL32			MEL32		
External finish			Pre-coated galvanized steel sheets (+powder coating for -BS type) <MUNSELL 5Y 8/1 or similar>			Pre-coated galvanized steel sheets (+powder coating for -BS type) <MUNSELL 5Y 8/1 or similar>		
External dimension H x W x D			mm 1,710 (1,650 without legs) x 920 x 740 in. 67-3/8 (65 without legs) x 36-1/4 x 29-3/16			mm 1,710 (1,650 without legs) x 1,220 x 740 in. 67-3/8 (65 without legs) x 48-1/16 x 29-3/16		
Protection devices	High pressure protection		High pressure sensor, High pressure switch at 4.15 MPa (601 psi)			High pressure sensor, High pressure switch at 4.15 MPa (601 psi)		
	Inverter circuit (COMP./FAN)		Over-heat protection, Over-current protection			Over-heat protection, Over-current protection		
	Compressor		-			-		
	Fan motor		-			-		
Refrigerant	Type x original charge		R410A x 7.5 kg (17 lbs)			R410A x 10.3 kg (23 lbs)		
	Control		LEV and HIC circuit					
Net weight			kg (lbs) 208 (459)			kg (lbs) 252 (556)		
Heat exchanger			Salt-resistant cross fin & aluminium tube			Salt-resistant cross fin & aluminium tube		
HIC circuit (HIC: Heat Inter-Changer)			Copper pipe, tube-in-tube structure			Copper pipe, tube-in-tube structure		
Pipe between unit and distributor	Liquid pipe	mm (in.)	9.52 (3/8) Brazed			12.7 (1/2) Brazed		
	Gas pipe	mm (in.)	22.2 (7/8) Brazed			28.58 (1-1/8) Brazed		
Defrosting method			Auto-defrost mode (Reversed refrigerant cycle, Hot gas)					
Drawing	External		WKJ94L361					
	Wiring		WKE94C946			WKE94C946		
Standard attachment	Document		Installation Manual					
	Accessory		Refrigerant conn. pipe					
Optional parts			Outdoor Twinning kit: CMY-Y100VBK3 Joint: CMY-Y102SS/LS-G2, CMY-Y202S-G2 Header: CMY-Y104/108/1010-G					
Remarks			Details on foundation work, duct work, insulation work, electrical wiring, power source switch, and other items shall be referred to the Installation Manual. Due to continuing improvement, above specifications may be subject to change without notice.					

Notes:		Unit converter	
1.Nominal cooling conditions (subject to JIS B8615-1) Indoor: 27°C D.B./19°C W.B. (81°F D.B./66°F W.B.), Outdoor: 35°C D.B./24°C W.B. (95°F D.B./75°F W.B.) Pipe length: 7.5 m (24-9/16 ft.), Level difference: 0 m (0 ft.)		BTU/h	=kW x 3,412
2.Nominal heating conditions (subject to JIS B8615-1) Indoor: 20°C D.B. (68°F D.B.), Outdoor: 7°C D.B./6°C W.B. (45°F D.B./43°F W.B.) Pipe length: 7.5 m (24-9/16 ft.), Level difference: 0 m (0 ft.)		cfm	=m ³ /min x 35.31
3.External static pressure option is available (30Pa, 60Pa/3.1mmH ₂ O, 6.1mmH ₂ O).		lbs	=kg/0.4536
		*Above specification data is subject to rounding variation.	

1. SPECIFICATIONS

Model			PUHY-EP600YSLM-A (-BS)	
Power source			3-phase 4-wire 380-400-415 V 50/60 Hz	
Cooling capacity (Nominal)	*1	kW	69.0	
		kcal/h	59,300	
		BTU/h	235,400	
	Power input	kW	18.59	
		Current input	A	31.3-29.8-28.7
EER	kW/kW		3.71	
	Indoor	W.B.	15.0-24.0°C (59-75°F)	
Temp. range of cooling	Outdoor	D.B.	-5.0-52.0°C (23-126°F)	
	Heating capacity (Nominal)	*2	kW	76.5
kcal/h			65,800	
BTU/h			261,000	
Power input	kW	19.66		
	Current input	A	33.1-31.5-30.3	
COP	kW/kW		3.89	
	Indoor	D.B.	15.0-27.0°C (59-81°F)	
Temp. range of heating	Outdoor	W.B.	-20.0-15.5°C (-4-60°F)	
	Indoor unit connectable		Total capacity	50-130% of outdoor unit capacity
Model/Quantity		P15-P250/2-50		
Sound pressure level (measured in anechoic room)		dB <A>	64	
Sound power level (measured in anechoic room)		dB <A>	85	
Refrigerant piping diameter	Liquid pipe	mm (in.)	15.88 (5/8) Brazed	
	Gas pipe	mm (in.)	28.58 (1-1/8) Brazed	

Set Model			PUHY-EP300YLM-A (-BS)		PUHY-EP300YLM-A (-BS)	
Model			Propeller fan x 1		Propeller fan x 1	
FAN	Type x Quantity		200		200	
	Air flow rate	m ³ /min	3,333		3,333	
		L/s	7,062		7,062	
		cfm	-		-	
	Control, Driving mechanism		Inverter-control, Direct-driven by motor		Inverter-control, Direct-driven by motor	
Motor output	kW	0.92 x 1		0.92 x 1		
*3 External static press.		0 Pa (0 mmH ₂ O)		0 Pa (0 mmH ₂ O)		
Compressor			Inverter scroll hermetic compressor		Inverter scroll hermetic compressor	
Manufacture			AC&R Works, MITSUBISHI ELECTRIC CORPORATION		AC&R Works, MITSUBISHI ELECTRIC CORPORATION	
Starting method			Inverter		Inverter	
Motor output	kW	8.1		8.1		
Case heater	kW	-		-		
Lubricant			MEL32		MEL32	
External finish			Pre-coated galvanized steel sheets (+powder coating for -BS type) <MUNSELL 5Y 8/1 or similar>		Pre-coated galvanized steel sheets (+powder coating for -BS type) <MUNSELL 5Y 8/1 or similar>	
External dimension H x W x D			1,710 (1,650 without legs) x 1,220 x 740 67-3/8 (65 without legs) x 48-1/16 x 29-3/16		1,710 (1,650 without legs) x 1,220 x 740 67-3/8 (65 without legs) x 48-1/16 x 29-3/16	
Protection devices	High pressure protection		High pressure sensor, High pressure switch at 4.15 MPa (601 psi)		High pressure sensor, High pressure switch at 4.15 MPa (601 psi)	
	Inverter circuit (COMP./FAN)		Over-heat protection, Over-current protection		Over-heat protection, Over-current protection	
	Compressor		-		-	
	Fan motor		-		-	
Refrigerant	Type x original charge		R410A x 10.3 kg (23 lbs)		R410A x 10.3 kg (23 lbs)	
	Control		LEV and HIC circuit			
Net weight			252 (556)		252 (556)	
Heat exchanger			Salt-resistant cross fin & aluminium tube		Salt-resistant cross fin & aluminium tube	
HIC circuit (HIC: Heat Inter-Changer)			Copper pipe, tube-in-tube structure		Copper pipe, tube-in-tube structure	
Pipe between unit and distributor	Liquid pipe	mm (in.)	12.7 (1/2) Brazed		12.7 (1/2) Brazed	
	Gas pipe	mm (in.)	28.58 (1-1/8) Brazed		28.58 (1-1/8) Brazed	
Defrosting method			Auto-defrost mode (Reversed refrigerant cycle, Hot gas)			
Drawing	External		WKJ94L362			
	Wiring		WKE94C946		WKE94C946	
Standard attachment	Document		Installation Manual			
	Accessory		Refrigerant conn. pipe			
Optional parts			Outdoor Twinning kit: CMY-Y100VBK3 Joint: CMY-Y102SS/LS-G2, CMY-Y202S-G2 Header: CMY-Y104/108/1010-G			
Remarks			Details on foundation work, duct work, insulation work, electrical wiring, power source switch, and other items shall be referred to the Installation Manual. Due to continuing improvement, above specifications may be subject to change without notice.			

Notes:	Unit converter
1.Nominal cooling conditions (subject to JIS B8615-1) Indoor: 27°C D.B./19°C W.B. (81°F D.B./66°F W.B.), Outdoor: 35°C D.B./24°C W.B. (95°F D.B./75°F W.B.) Pipe length: 7.5 m (24-9/16 ft.), Level difference: 0 m (0 ft.)	BTU/h =kW x 3,412 cfm =m ³ /min x 35.31 lbs =kg/0.4536
2.Nominal heating conditions (subject to JIS B8615-1) Indoor: 20°C D.B. (68°F D.B.), Outdoor: 7°C D.B./6°C W.B. (45°F D.B./43°F W.B.) Pipe length: 7.5 m (24-9/16 ft.), Level difference: 0 m (0 ft.)	
3.External static pressure option is available (30Pa, 60Pa/3.1mmH ₂ O, 6.1mmH ₂ O).	
	*Above specification data is subject to rounding variation.

1. SPECIFICATIONS

YKB/YLM

Y (HIGH COP)

Model			PUHY-EP650YSLM-A (-BS)		
Power source			3-phase 4-wire 380-400-415 V 50/60 Hz		
Cooling capacity (Nominal)	*1	kW	73.0		
		kcal/h	62,800		
		BTU/h	249,100		
	Power input	kW	18.15		
		Current input	A	30.6-29.1-28.0	
EER		kW/kW	4.02		
Temp. range of cooling	Indoor	W.B.	15.0~24.0°C (59~75°F)		
	Outdoor	D.B.	-5.0~52.0°C (23~126°F)		
Heating capacity (Nominal)	*2	kW	81.5		
		kcal/h	70,100		
		BTU/h	278,100		
	Power input	kW	20.07		
		Current input	A	33.8-32.1-31.0	
COP		kW/kW	4.06		
Temp. range of heating	Indoor	D.B.	15.0~27.0°C (59~81°F)		
	Outdoor	W.B.	-20.0~15.5°C (-4~60°F)		
Indoor unit connectable	Total capacity		50~130% of outdoor unit capacity		
	Model/Quantity		P15~P250/2~50		
Sound pressure level (measured in anechoic room)		dB <A>	63		
Sound power level (measured in anechoic room)		dB <A>	84.5		
Refrigerant piping diameter	Liquid pipe	mm (in.)	15.88 (5/8) Brazed		
	Gas pipe	mm (in.)	28.58 (1-1/8) Brazed		

Set Model			PUHY-EP200YLM-A (-BS)		PUHY-EP200YLM-A (-BS)		PUHY-EP250YLM-A (-BS)	
Model			Propeller fan x 1		Propeller fan x 1		Propeller fan x 1	
FAN	Type x Quantity		175		175		175	
	Air flow rate	m ³ /min	2,917		2,917		2,917	
		L/s	6,179		6,179		6,179	
		cfm						
	Control, Driving mechanism		Inverter-control, Direct-driven by motor		Inverter-control, Direct-driven by motor		Inverter-control, Direct-driven by motor	
*3 External static press.		0 Pa (0 mmH ₂ O)		0 Pa (0 mmH ₂ O)		0 Pa (0 mmH ₂ O)		
Compressor	Type x Quantity		Inverter scroll hermetic compressor		Inverter scroll hermetic compressor		Inverter scroll hermetic compressor	
	Manufacture		AC&R Works, MITSUBISHI ELECTRIC CORPORATION		AC&R Works, MITSUBISHI ELECTRIC CORPORATION		AC&R Works, MITSUBISHI ELECTRIC CORPORATION	
	Starting method		Inverter		Inverter		Inverter	
	Motor output	kW	5.6		5.6		6.9	
	Case heater	kW	-		-		-	
	Lubricant		MEL32		MEL32		MEL32	
External finish			Pre-coated galvanized steel sheets (+powder coating for -BS type) <MUNSELL 5Y 8/1 or similar>		Pre-coated galvanized steel sheets (+powder coating for -BS type) <MUNSELL 5Y 8/1 or similar>		Pre-coated galvanized steel sheets (+powder coating for -BS type) <MUNSELL 5Y 8/1 or similar>	
External dimension H x W x D			mm 1,710 (1,650 without legs) x 920 x 740 67-3/8 (65 without legs) x 36-1/4 x 29-3/16		mm 1,710 (1,650 without legs) x 920 x 740 67-3/8 (65 without legs) x 36-1/4 x 29-3/16		mm 1,710 (1,650 without legs) x 920 x 740 67-3/8 (65 without legs) x 36-1/4 x 29-3/16	
Protection devices	High pressure protection		High pressure sensor, High pressure switch at 4.15 MPa (601 psi)		High pressure sensor, High pressure switch at 4.15 MPa (601 psi)		High pressure sensor, High pressure switch at 4.15 MPa (601 psi)	
	Inverter circuit (COMP./FAN)		Over-heat protection, Over-current protection		Over-heat protection, Over-current protection		Over-heat protection, Over-current protection	
	Compressor		-		-		-	
	Fan motor		-		-		-	
Refrigerant	Type x original charge		R410A x 7.5 kg (17 lbs)		R410A x 7.5 kg (17 lbs)		R410A x 7.5 kg (17 lbs)	
	Control		LEV and HIC circuit		LEV and HIC circuit		LEV and HIC circuit	
Net weight			kg (lbs) 208 (459)		kg (lbs) 208 (459)		kg (lbs) 208 (459)	
Heat exchanger			Salt-resistant cross fin & aluminium tube		Salt-resistant cross fin & aluminium tube		Salt-resistant cross fin & aluminium tube	
HIC circuit (HIC: Heat Inter-Changer)			Copper pipe, tube-in-tube structure		Copper pipe, tube-in-tube structure		Copper pipe, tube-in-tube structure	
Pipe between unit and distributor	Liquid pipe	mm (in.)	9.52 (3/8) Brazed		9.52 (3/8) Brazed		9.52 (3/8) Brazed	
	Gas pipe	mm (in.)	22.2 (7/8) Brazed		22.2 (7/8) Brazed		22.2 (7/8) Brazed	
Defrosting method			Auto-defrost mode (Reversed refrigerant cycle, Hot gas)		Auto-defrost mode (Reversed refrigerant cycle, Hot gas)		Auto-defrost mode (Reversed refrigerant cycle, Hot gas)	
Drawing	External		WKJ94L363		WKJ94L363		WKJ94L363	
	Wiring		KE94C946		KE94C946		KE94C946	
Standard attachment	Document		Installation Manual		Installation Manual		Installation Manual	
	Accessory		Refrigerant conn. pipe		Refrigerant conn. pipe		Refrigerant conn. pipe	
Optional parts			Outdoor Twinning kit: CMY-Y300VBK3 Joint: CMY-Y102SS/LS-G2, CMY-Y202/302S-G2 Header: CMY-Y104/108/1010-G		Outdoor Twinning kit: CMY-Y300VBK3 Joint: CMY-Y102SS/LS-G2, CMY-Y202/302S-G2 Header: CMY-Y104/108/1010-G		Outdoor Twinning kit: CMY-Y300VBK3 Joint: CMY-Y102SS/LS-G2, CMY-Y202/302S-G2 Header: CMY-Y104/108/1010-G	
Remarks			Details on foundation work, duct work, insulation work, electrical wiring, power source switch, and other items shall be referred to the Installation Manual. Due to continuing improvement, above specifications may be subject to change without notice.		Details on foundation work, duct work, insulation work, electrical wiring, power source switch, and other items shall be referred to the Installation Manual. Due to continuing improvement, above specifications may be subject to change without notice.		Details on foundation work, duct work, insulation work, electrical wiring, power source switch, and other items shall be referred to the Installation Manual. Due to continuing improvement, above specifications may be subject to change without notice.	

Notes:			Unit converter		
1.Nominal cooling conditions (subject to JIS B8615-1) Indoor: 27°C.D.B./19°C.W.B. (81°F.D.B./66°F.W.B.), Outdoor: 35°C.D.B./24°C.W.B. (95°F.D.B./75°F.W.B.) Pipe length: 7.5 m (24-9/16 ft.), Level difference: 0 m (0 ft.)			BTU/h =kW x 3,412		
2.Nominal heating conditions (subject to JIS B8615-1) Indoor: 20°C.D.B. (68°F.D.B.), Outdoor: 7°C.D.B./6°C.W.B. (45°F.D.B./43°F.W.B.) Pipe length: 7.5 m (24-9/16 ft.), Level difference: 0 m (0 ft.)			cfm =m ³ /min x 35.31		
3.External static pressure option is available (30Pa, 60Pa/3.1mmH ₂ O, 6.1mmH ₂ O).			lbs =kg/0.4536		
			*Above specification data is subject to rounding variation.		

1. SPECIFICATIONS

YKB/YLM

Y (HIGH COP)

Model		PUHY-EP700YSLM-A (-BS)	
Power source		3-phase 4-wire 380-400-415 V 50/60 Hz	
Cooling capacity (Nominal)	*1 kW	80.0	
	kcal/h	68,800	
	*1 BTU/h	273,000	
	Power input kW	20.15	
	Current input A	34.0-32.3-31.1	
Temp. range of cooling	EER	3.97	
	Indoor	W.B.	15.0~24.0°C (59~75°F)
	Outdoor	D.B.	-5.0~52.0°C (23~126°F)
Heating capacity (Nominal)	*2 kW	88.0	
	kcal/h	75,700	
	*2 BTU/h	300,300	
	Power input kW	21.67	
	Current input A	36.5-34.7-33.4	
Temp. range of heating	COP	4.06	
	Indoor	D.B.	15.0~27.0°C (59~81°F)
	Outdoor	W.B.	-20.0~15.5°C (-4~60°F)
Indoor unit connectable	Total capacity	50~130% of outdoor unit capacity	
	Model/Quantity	P15~P250/2~50	
Sound pressure level (measured in anechoic room)	dB <A>	63.5	
Sound power level (measured in anechoic room)	dB <A>	85.5	
Refrigerant piping diameter	Liquid pipe	mm (in.)	19.05 (3/4) Brazed
	Gas pipe	mm (in.)	34.93 (1-3/8) Brazed

Set Model		PUHY-EP200YLM-A (-BS)		PUHY-EP200YLM-A (-BS)		PUHY-EP300YLM-A (-BS)		
FAN	Type x Quantity		Propeller fan x 1		Propeller fan x 1		Propeller fan x 1	
	Air flow rate	m ³ /min	175		175		200	
		L/s	2,917		2,917		3,333	
		cfm	6,179		6,179		7,062	
	Control, Driving mechanism		Inverter-control, Direct-driven by motor		Inverter-control, Direct-driven by motor		Inverter-control, Direct-driven by motor	
	Motor output	kW	0.92 x 1		0.92 x 1		0.92 x 1	
*3 External static press.		0 Pa (0 mmH ₂ O)		0 Pa (0 mmH ₂ O)		0 Pa (0 mmH ₂ O)		
Compressor	Type x Quantity		Inverter scroll hermetic compressor		Inverter scroll hermetic compressor		Inverter scroll hermetic compressor	
	Manufacture		AC&R Works, MITSUBISHI ELECTRIC CORPORATION		AC&R Works, MITSUBISHI ELECTRIC CORPORATION		AC&R Works, MITSUBISHI ELECTRIC CORPORATION	
	Starting method		Inverter		Inverter		Inverter	
	Motor output	kW	5.6		5.6		8.1	
	Case heater	kW	-		-		-	
	Lubricant		MEL32		MEL32		MEL32	
External finish		Pre-coated galvanized steel sheets (+powder coating for -BS type) <MUNSELL 5Y 8/1 or similar>		Pre-coated galvanized steel sheets (+powder coating for -BS type) <MUNSELL 5Y 8/1 or similar>		Pre-coated galvanized steel sheets (+powder coating for -BS type) <MUNSELL 5Y 8/1 or similar>		
External dimension H x W x D		mm	1,710 (1,650 without legs) x 920 x 740		1,710 (1,650 without legs) x 920 x 740		1,710 (1,650 without legs) x 1,220 x 740	
		in.	67-3/8 (65 without legs) x 36-1/4 x 29-3/16		67-3/8 (65 without legs) x 36-1/4 x 29-3/16		67-3/8 (65 without legs) x 48-1/16 x 29-3/16	
Protection devices	High pressure protection		High pressure sensor, High pressure switch at 4.15 MPa (601 psi)		High pressure sensor, High pressure switch at 4.15 MPa (601 psi)		High pressure sensor, High pressure switch at 4.15 MPa (601 psi)	
	Inverter circuit (COMP./FAN)		Over-heat protection, Over-current protection		Over-heat protection, Over-current protection		Over-heat protection, Over-current protection	
	Compressor		-		-		-	
	Fan motor		-		-		-	
Refrigerant	Type x original charge		R410A x 7.5 kg (17 lbs)		R410A x 7.5 kg (17 lbs)		R410A x 10.3 kg (23 lbs)	
	Control		LEV and HIC circuit		LEV and HIC circuit		LEV and HIC circuit	
Net weight		kg (lbs)	208 (459)		208 (459)		252 (556)	
Heat exchanger		Salt-resistant cross fin & aluminium tube		Salt-resistant cross fin & aluminium tube		Salt-resistant cross fin & aluminium tube		
HIC circuit (HIC: Heat Inter-Changer)		Copper pipe, tube-in-tube structure		Copper pipe, tube-in-tube structure		Copper pipe, tube-in-tube structure		
Pipe between unit and distributor	Liquid pipe	mm (in.)	9.52 (3/8) Brazed		9.52 (3/8) Brazed		12.7 (1/2) Brazed	
	Gas pipe	mm (in.)	22.2 (7/8) Brazed		22.2 (7/8) Brazed		28.58 (1-1/8) Brazed	
Defrosting method		Auto-defrost mode (Reversed refrigerant cycle, Hot gas)		Auto-defrost mode (Reversed refrigerant cycle, Hot gas)		Auto-defrost mode (Reversed refrigerant cycle, Hot gas)		
Drawing	External		WKJ94L364		WKJ94L364		WKJ94L364	
	Wiring		KE94C946		KE94C946		KE94C946	
Standard attachment	Document		Installation Manual		Installation Manual		Installation Manual	
	Accessory		Refrigerant conn. pipe		Refrigerant conn. pipe		Refrigerant conn. pipe	
Optional parts		Outdoor Twinning kit: CMY-Y300VBK3 Joint: CMY-Y102SS/LS-G2, CMY-Y202/302S-G2 Header: CMY-Y104/108/1010-G		Outdoor Twinning kit: CMY-Y300VBK3 Joint: CMY-Y102SS/LS-G2, CMY-Y202/302S-G2 Header: CMY-Y104/108/1010-G		Outdoor Twinning kit: CMY-Y300VBK3 Joint: CMY-Y102SS/LS-G2, CMY-Y202/302S-G2 Header: CMY-Y104/108/1010-G		
Remarks		Details on foundation work, duct work, insulation work, electrical wiring, power source switch, and other items shall be referred to the Installation Manual. Due to continuing improvement, above specifications may be subject to change without notice.		Details on foundation work, duct work, insulation work, electrical wiring, power source switch, and other items shall be referred to the Installation Manual. Due to continuing improvement, above specifications may be subject to change without notice.		Details on foundation work, duct work, insulation work, electrical wiring, power source switch, and other items shall be referred to the Installation Manual. Due to continuing improvement, above specifications may be subject to change without notice.		

Notes:	Unit converter
1.Nominal cooling conditions (subject to JIS B8615-1) Indoor: 27°C D.B./19°C W.B. (81°F D.B./66°F W.B.), Outdoor: 35°C D.B./24°C W.B. (95°F D.B./75°F W.B.) Pipe length: 7.5 m (24-9/16 ft.), Level difference: 0 m (0 ft.)	BTU/h =kW x 3,412
2.Nominal heating conditions (subject to JIS B8615-1) Indoor: 20°C D.B. (68°F D.B.), Outdoor: 7°C D.B./6°C W.B. (45°F D.B./43°F W.B.) Pipe length: 7.5 m (24-9/16 ft.), Level difference: 0 m (0 ft.)	cfm =m ³ /min x 35.31
3.External static pressure option is available (30Pa, 60Pa/3.1mmH ₂ O, 6.1mmH ₂ O).	lbs =kg/0.4536
	*Above specification data is subject to rounding variation.

1. SPECIFICATIONS

YKB/YLM

Y (HIGH COP)

Model			PUHY-EP750YSLM-A (-BS)	
Power source			3-phase 4-wire 380-400-415 V 50/60 Hz	
Cooling capacity (Nominal)	*1	kW	85.0	
		kcal/h	73,100	
		BTU/h	290,000	
	Power input	kW	21.85	
		A	36.8-35.0-33.7	
EER	kW/kW	3.89		
Temp. range of cooling	Indoor	W.B.	15.0~24.0°C (59~75°F)	
	Outdoor	D.B.	-5.0~52.0°C (23~126°F)	
Heating capacity (Nominal)	*2	kW	95.0	
		kcal/h	81,700	
		BTU/h	324,100	
	Power input	kW	23.92	
		A	40.3-38.3-36.9	
COP	kW/kW	3.97		
Temp. range of heating	Indoor	D.B.	15.0~27.0°C (59~81°F)	
	Outdoor	W.B.	-20.0~15.5°C (-4~60°F)	
Indoor unit connectable	Total capacity	50~130% of outdoor unit capacity		
	Model/Quantity	P15~P250/2~50		
Sound pressure level (measured in anechoic room)		dB <A>	64.5	
Sound power level (measured in anechoic room)		dB <A>	85.5	
Refrigerant piping diameter	Liquid pipe	mm (in.)	19.05 (3/4) Brazed	
	Gas pipe	mm (in.)	34.93 (1-3/8) Brazed	

Set Model

Model			PUHY-EP200YLM-A (-BS)		PUHY-EP250YLM-A (-BS)		PUHY-EP300YLM-A (-BS)	
FAN	Type x Quantity		Propeller fan x 1		Propeller fan x 1		Propeller fan x 1	
	Air flow rate	m ³ /min	175		175		200	
		L/s	2,917		2,917		3,333	
		cfm	6,179		6,179		7,062	
	Control, Driving mechanism		Inverter-control, Direct-driven by motor		Inverter-control, Direct-driven by motor		Inverter-control, Direct-driven by motor	
	Motor output	kW	0.92 x 1		0.92 x 1		0.92 x 1	
	*3 External static press.		0 Pa (0 mmH ₂ O)		0 Pa (0 mmH ₂ O)		0 Pa (0 mmH ₂ O)	
Compressor	Type x Quantity		Inverter scroll hermetic compressor		Inverter scroll hermetic compressor		Inverter scroll hermetic compressor	
	Manufacture		AC&R Works, MITSUBISHI ELECTRIC CORPORATION		AC&R Works, MITSUBISHI ELECTRIC CORPORATION		AC&R Works, MITSUBISHI ELECTRIC CORPORATION	
	Starting method		Inverter		Inverter		Inverter	
	Motor output	kW	5.6		6.9		8.1	
	Case heater	kW	-		-		-	
Lubricant		MEL32		MEL32		MEL32		
External finish			Pre-coated galvanized steel sheets (+powder coating for -BS type) <MUNSELL 5Y 8/1 or similar>		Pre-coated galvanized steel sheets (+powder coating for -BS type) <MUNSELL 5Y 8/1 or similar>		Pre-coated galvanized steel sheets (+powder coating for -BS type) <MUNSELL 5Y 8/1 or similar>	
External dimension H x W x D			mm	1,710 (1,650 without legs) x 920 x 740	1,710 (1,650 without legs) x 920 x 740	1,710 (1,650 without legs) x 1,220 x 740	in.	67-3/8 (65 without legs) x 36-1/4 x 29-3/16
Protection devices	High pressure protection		High pressure sensor, High pressure switch at 4.15 MPa (601 psi)		High pressure sensor, High pressure switch at 4.15 MPa (601 psi)		High pressure sensor, High pressure switch at 4.15 MPa (601 psi)	
	Inverter circuit (COMP./FAN)		Over-heat protection, Over-current protection		Over-heat protection, Over-current protection		Over-heat protection, Over-current protection	
	Compressor		-		-		-	
	Fan motor		-		-		-	
Refrigerant	Type x original charge		R410A x 7.5 kg (17 lbs)		R410A x 7.5 kg (17 lbs)		R410A x 10.3 kg (23 lbs)	
	Control		LEV and HIC circuit		LEV and HIC circuit		LEV and HIC circuit	
Net weight			kg (lbs)	208 (459)	208 (459)	252 (556)		
Heat exchanger			Salt-resistant cross fin & aluminium tube		Salt-resistant cross fin & aluminium tube		Salt-resistant cross fin & aluminium tube	
HIC circuit (HIC: Heat Inter-Changer)			Copper pipe, tube-in-tube structure		Copper pipe, tube-in-tube structure		Copper pipe, tube-in-tube structure	
Pipe between unit and distributor	Liquid pipe	mm (in.)	9.52 (3/8) Brazed		9.52 (3/8) Brazed		12.7 (1/2) Brazed	
	Gas pipe	mm (in.)	22.2 (7/8) Brazed		22.2 (7/8) Brazed		28.58 (1-1/8) Brazed	
Defrosting method			Auto-defrost mode (Reversed refrigerant cycle, Hot gas)		Auto-defrost mode (Reversed refrigerant cycle, Hot gas)		Auto-defrost mode (Reversed refrigerant cycle, Hot gas)	
Drawing	External		WKJ94L364		WKJ94L364		WKJ94L364	
	Wiring		KE94C946		KE94C946		KE94C946	
Standard attachment	Document		Installation Manual		Installation Manual		Installation Manual	
	Accessory		Refrigerant conn. pipe		Refrigerant conn. pipe		Refrigerant conn. pipe	
Optional parts			Outdoor Twinning kit: CMY-Y300VBK3 Joint: CMY-Y102SS/LS-G2, CMY-Y202/302S-G2 Header: CMY-Y104/108/1010-G		Outdoor Twinning kit: CMY-Y300VBK3 Joint: CMY-Y102SS/LS-G2, CMY-Y202/302S-G2 Header: CMY-Y104/108/1010-G		Outdoor Twinning kit: CMY-Y300VBK3 Joint: CMY-Y102SS/LS-G2, CMY-Y202/302S-G2 Header: CMY-Y104/108/1010-G	
Remarks			Details on foundation work, duct work, insulation work, electrical wiring, power source switch, and other items shall be referred to the Installation Manual. Due to continuing improvement, above specifications may be subject to change without notice.		Details on foundation work, duct work, insulation work, electrical wiring, power source switch, and other items shall be referred to the Installation Manual. Due to continuing improvement, above specifications may be subject to change without notice.		Details on foundation work, duct work, insulation work, electrical wiring, power source switch, and other items shall be referred to the Installation Manual. Due to continuing improvement, above specifications may be subject to change without notice.	

Notes:

- Nominal cooling conditions (subject to JIS B8615-1)
Indoor: 27°C D.B./19°C W.B. (81°F D.B./66°F W.B.), Outdoor: 35°C D.B./24°C W.B. (95°F D.B./75°F W.B.)
Pipe length: 7.5 m (24-9/16 ft.), Level difference: 0 m (0 ft.)
- Nominal heating conditions (subject to JIS B8615-1)
Indoor: 20°C D.B. (68°F D.B.), Outdoor: 7°C D.B./6°C W.B. (45°F D.B./43°F W.B.)
Pipe length: 7.5 m (24-9/16 ft.), Level difference: 0 m (0 ft.)
- External static pressure option is available (30Pa, 60Pa/3.1mmH₂O, 6.1mmH₂O).

Unit converter	
BTU/h	=kW x 3,412
cfm	=m ³ /min x 35.31
lbs	=kg/0.4536
*Above specification data is subject to rounding variation.	

1. SPECIFICATIONS

YKB/YLM

Y (HIGH COP)

Model			PUHY-EP800YSLM-A (-BS)	
Power source			3-phase 4-wire 380-400-415 V 50/60 Hz	
Cooling capacity (Nominal)	*1	kW	90.0	
		kcal/h	77,400	
		BTU/h	307,100	
	Power input	kW	23.43	
		Current input	A	
EER		kW/kW		
Temp. range of cooling	Indoor	W.B.	15.0~24.0°C (59~75°F)	
	Outdoor	D.B.	-5.0~52.0°C (23~126°F)	
Heating capacity (Nominal)	*2	kW	100.0	
		kcal/h	86,000	
		BTU/h	341,200	
	Power input	kW	25.18	
		Current input	A	
COP		kW/kW		
Temp. range of heating	Indoor	D.B.	15.0~27.0°C (59~81°F)	
	Outdoor	W.B.	-20.0~15.5°C (-4~60°F)	
Indoor unit connectable	Total capacity	50~130% of outdoor unit capacity		
	Model/Quantity	P15-P250/2-50		
Sound pressure level (measured in anechoic room)		dB <A>	65	
Sound power level (measured in anechoic room)		dB <A>	86.5	
Refrigerant piping diameter	Liquid pipe	mm (in.)	19.05 (3/4) Brazed	
	Gas pipe	mm (in.)	34.93 (1-3/8) Brazed	

Set Model			PUHY-EP200YLM-A (-BS)		PUHY-EP300YLM-A (-BS)		PUHY-EP300YLM-A (-BS)	
FAN	Type x Quantity		Propeller fan x 1		Propeller fan x 1		Propeller fan x 1	
	Air flow rate	m ³ /min	175		200		200	
		L/s	2,917		3,333		3,333	
		cfm	6,179		7,062		7,062	
	Control, Driving mechanism		Inverter-control, Direct-driven by motor		Inverter-control, Direct-driven by motor		Inverter-control, Direct-driven by motor	
	*3	Motor output	kW	0.92 x 1		0.92 x 1		0.92 x 1
External static press.			0 Pa (0 mmH ₂ O)		0 Pa (0 mmH ₂ O)		0 Pa (0 mmH ₂ O)	
Compressor		Inverter scroll hermetic compressor		Inverter scroll hermetic compressor		Inverter scroll hermetic compressor		
Manufacture		AC&R Works, MITSUBISHI ELECTRIC CORPORATION		AC&R Works, MITSUBISHI ELECTRIC CORPORATION		AC&R Works, MITSUBISHI ELECTRIC CORPORATION		
Starting method		Inverter		Inverter		Inverter		
Motor output		kW	5.6		8.1		8.1	
Case heater		kW	-		-		-	
Lubricant		MEL32		MEL32		MEL32		
External finish			Pre-coated galvanized steel sheets (+powder coating for -BS type) <MUNSELL 5Y 8/1 or similar>		Pre-coated galvanized steel sheets (+powder coating for -BS type) <MUNSELL 5Y 8/1 or similar>		Pre-coated galvanized steel sheets (+powder coating for -BS type) <MUNSELL 5Y 8/1 or similar>	
External dimension H x W x D			mm		mm		mm	
			1,710 (1,650 without legs) x 920 x 740		1,710 (1,650 without legs) x 1,220 x 740		1,710 (1,650 without legs) x 1,220 x 740	
			in.		67-3/8 (65 without legs) x 36-1/4 x 29-3/16		67-3/8 (65 without legs) x 48-1/16 x 29-3/16	
Protection devices	High pressure protection		High pressure sensor, High pressure switch at 4.15 MPa (601 psi)		High pressure sensor, High pressure switch at 4.15 MPa (601 psi)		High pressure sensor, High pressure switch at 4.15 MPa (601 psi)	
	Inverter circuit (COMP./FAN)		Over-heat protection, Over-current protection		Over-heat protection, Over-current protection		Over-heat protection, Over-current protection	
	Compressor		-		-		-	
	Fan motor		-		-		-	
Refrigerant	Type x original charge		R410A x 7.5 kg (17 lbs)		R410A x 10.3 kg (23 lbs)		R410A x 10.3 kg (23 lbs)	
	Control		LEV and HIC circuit		LEV and HIC circuit		LEV and HIC circuit	
Net weight			kg (lbs)		kg (lbs)		kg (lbs)	
			208 (459)		252 (556)		252 (556)	
Heat exchanger			Salt-resistant cross fin & aluminium tube		Salt-resistant cross fin & aluminium tube		Salt-resistant cross fin & aluminium tube	
HIC circuit (HIC: Heat Inter-Changer)			Copper pipe, tube-in-tube structure		Copper pipe, tube-in-tube structure		Copper pipe, tube-in-tube structure	
Pipe between unit and distributor	Liquid pipe	mm (in.)	9.52 (3/8) Brazed		12.7 (1/2) Brazed		12.7 (1/2) Brazed	
	Gas pipe	mm (in.)	22.2 (7/8) Brazed		28.58 (1-1/8) Brazed		28.58 (1-1/8) Brazed	
Defrosting method			Auto-defrost mode (Reversed refrigerant cycle, Hot gas)					
Drawing	External		WKJ94L365					
	Wiring		KE94C946		KE94C946		KE94C946	
Standard attachment	Document		Installation Manual					
	Accessory		Refrigerant conn. pipe					
Optional parts			Outdoor Twinning kit: CMY-Y300VBK3 Joint: CMY-Y102SS/LS-G2, CMY-Y202/302S-G2 Header: CMY-Y104/108/1010-G					
Remarks			Details on foundation work, duct work, insulation work, electrical wiring, power source switch, and other items shall be referred to the Installation Manual. Due to continuing improvement, above specifications may be subject to change without notice.					

Notes:	Unit converter
1.Nominal cooling conditions (subject to JIS B8615-1) Indoor: 27°C.D.B./19°C.W.B. (81°F.D.B./66°F.W.B.), Outdoor: 35°C.D.B./24°C.W.B. (95°F.D.B./75°F.W.B.) Pipe length: 7.5 m (24-9/16 ft.), Level difference: 0 m (0 ft.)	BTU/h =kW x 3,412
2.Nominal heating conditions (subject to JIS B8615-1) Indoor: 20°C.D.B. (68°F.D.B.), Outdoor: 7°C.D.B./6°C.W.B. (45°F.D.B./43°F.W.B.) Pipe length: 7.5 m (24-9/16 ft.), Level difference: 0 m (0 ft.)	cfm =m ³ /min x 35.31
3.External static pressure option is available (30Pa, 60Pa/3.1mmH ₂ O, 6.1mmH ₂ O).	lbs =kg/0.4536
	*Above specification data is subject to rounding variation.

1. SPECIFICATIONS

YKB/YLM

Y (HIGH COP)

Model			PUHY-EP850YSLM-A (-BS)	
Power source			3-phase 4-wire 380-400-415 V 50/60 Hz	
Cooling capacity (Nominal)	*1	kW	96.0	
		kcal/h	82,600	
		BTU/h	327,600	
	Power input	kW	25.53	
		A	43.0-40.9-39.4	
EER	kW/kW	3.76		
Temp. range of cooling	Indoor	W.B.	15.0~24.0°C (59~75°F)	
	Outdoor	D.B.	-5.0~52.0°C (23~126°F)	
Heating capacity (Nominal)	*2	kW	108.0	
		kcal/h	92,900	
		BTU/h	368,500	
	Power input	kW	27.76	
		A	46.8-44.5-42.9	
COP	kW/kW	3.89		
Temp. range of heating	Indoor	D.B.	15.0~27.0°C (59~81°F)	
	Outdoor	W.B.	-20.0~15.5°C (-4~60°F)	
Indoor unit connectable	Total capacity	50~130% of outdoor unit capacity		
	Model/Quantity	P15~P250/2~50		
Sound pressure level (measured in anechoic room)		dB <A>	65.5	
Sound power level (measured in anechoic room)		dB <A>	86.5	
Refrigerant piping diameter	Liquid pipe	mm (in.)	19.05 (3/4) Brazed	
	Gas pipe	mm (in.)	41.28 (1-5/8) Brazed	

Set Model			PUHY-EP250YLM-A (-BS)		PUHY-EP300YLM-A (-BS)		PUHY-EP300YLM-A (-BS)	
FAN	Type x Quantity		Propeller fan x 1		Propeller fan x 1		Propeller fan x 1	
	Air flow rate	m ³ /min	175		200		200	
		L/s	2,917		3,333		3,333	
		cfm	6,179		7,062		7,062	
	Control, Driving mechanism		Inverter-control, Direct-driven by motor		Inverter-control, Direct-driven by motor		Inverter-control, Direct-driven by motor	
	Motor output	kW	0.92 x 1		0.92 x 1		0.92 x 1	
	*3 External static press.		0 Pa (0 mmH ₂ O)		0 Pa (0 mmH ₂ O)		0 Pa (0 mmH ₂ O)	
Compressor	Type x Quantity		Inverter scroll hermetic compressor		Inverter scroll hermetic compressor		Inverter scroll hermetic compressor	
	Manufacture		AC&R Works, MITSUBISHI ELECTRIC CORPORATION		AC&R Works, MITSUBISHI ELECTRIC CORPORATION		AC&R Works, MITSUBISHI ELECTRIC CORPORATION	
	Starting method		Inverter		Inverter		Inverter	
	Motor output	kW	6.9		8.1		8.1	
	Case heater	kW	-		-		-	
	Lubricant		MEL32		MEL32		MEL32	
External finish			Pre-coated galvanized steel sheets (+powder coating for -BS type) <MUNSELL 5Y 8/1 or similar>		Pre-coated galvanized steel sheets (+powder coating for -BS type) <MUNSELL 5Y 8/1 or similar>		Pre-coated galvanized steel sheets (+powder coating for -BS type) <MUNSELL 5Y 8/1 or similar>	
External dimension H x W x D			mm	1,710 (1,650 without legs) x 920 x 740	1,710 (1,650 without legs) x 1,220 x 740	1,710 (1,650 without legs) x 1,220 x 740	1,710 (1,650 without legs) x 1,220 x 740	
			in.	67-3/8 (65 without legs) x 36-1/4 x 29-3/16	67-3/8 (65 without legs) x 48-1/16 x 29-3/16	67-3/8 (65 without legs) x 48-1/16 x 29-3/16	67-3/8 (65 without legs) x 48-1/16 x 29-3/16	
Protection devices	High pressure protection		High pressure sensor, High pressure switch at 4.15 MPa (601 psi)		High pressure sensor, High pressure switch at 4.15 MPa (601 psi)		High pressure sensor, High pressure switch at 4.15 MPa (601 psi)	
	Inverter circuit (COMP./FAN)		Over-heat protection, Over-current protection		Over-heat protection, Over-current protection		Over-heat protection, Over-current protection	
	Compressor		-		-		-	
	Fan motor		-		-		-	
Refrigerant	Type x original charge		R410A x 7.5 kg (17 lbs)		R410A x 10.3 kg (23 lbs)		R410A x 10.3 kg (23 lbs)	
	Control		LEV and HIC circuit		LEV and HIC circuit		LEV and HIC circuit	
Net weight			kg (lbs)	208 (459)	252 (556)	252 (556)	252 (556)	
Heat exchanger			Salt-resistant cross fin & aluminium tube		Salt-resistant cross fin & aluminium tube		Salt-resistant cross fin & aluminium tube	
HIC circuit (HIC: Heat Inter-Changer)			Copper pipe, tube-in-tube structure		Copper pipe, tube-in-tube structure		Copper pipe, tube-in-tube structure	
Pipe between unit and distributor	Liquid pipe	mm (in.)	9.52 (3/8) Brazed		12.7 (1/2) Brazed		12.7 (1/2) Brazed	
	Gas pipe	mm (in.)	22.2 (7/8) Brazed		28.58 (1-1/8) Brazed		28.58 (1-1/8) Brazed	
Defrosting method			Auto-defrost mode (Reversed refrigerant cycle, Hot gas)					
Drawing	External		WKJ94L365					
	Wiring		KE94C946	KE94C946	KE94C946	KE94C946	KE94C946	
Standard attachment	Document		Installation Manual					
	Accessory		Refrigerant conn. pipe					
Optional parts			Outdoor Twinning kit: CMY-Y300VBK3 Joint: CMY-Y102SS/LS-G2, CMY-Y202/302S-G2 Header: CMY-Y104/108/1010-G					
Remarks			Details on foundation work, duct work, insulation work, electrical wiring, power source switch, and other items shall be referred to the Installation Manual. Due to continuing improvement, above specifications may be subject to change without notice.					

Notes:	Unit converter
1.Nominal cooling conditions (subject to JIS B8615-1) Indoor: 27°C D.B./19°C W.B. (81°F D.B./66°F W.B.), Outdoor: 35°C D.B./24°C W.B. (95°F D.B./75°F W.B.) Pipe length: 7.5 m (24-9/16 ft.), Level difference: 0 m (0 ft.)	BTU/h =kW x 3,412
2.Nominal heating conditions (subject to JIS B8615-1) Indoor: 20°C D.B. (68°F D.B.), Outdoor: 7°C D.B./6°C W.B. (45°F D.B./43°F W.B.) Pipe length: 7.5 m (24-9/16 ft.), Level difference: 0 m (0 ft.)	cfm =m ³ /min x 35.31
3.External static pressure option is available (30Pa, 60Pa/3.1mmH ₂ O, 6.1mmH ₂ O).	lbs =kg/0.4536
	*Above specification data is subject to rounding variation.

1. SPECIFICATIONS

YKB/YLM

Y (HIGH COP)

Model			PUHY-EP900YSLM-A (-BS)	
Power source			3-phase 4-wire 380-400-415 V 50/60 Hz	
Cooling capacity (Nominal)	*1	kW	101.0	
		kcal/h	86,900	
		BTU/h	344,600	
	Power input	kW	27.22	
		A	45.9-43.6-42.0	
EER	kW/kW	3.71		
Temp. range of cooling	Indoor	W.B.	15.0~24.0°C (59~75°F)	
	Outdoor	D.B.	-5.0~52.0°C (23~126°F)	
Heating capacity (Nominal)	*2	kW	113.0	
		kcal/h	97,200	
		BTU/h	385,600	
	Power input	kW	29.04	
		A	49.0-46.5-44.8	
COP	kW/kW	3.89		
Temp. range of heating	Indoor	D.B.	15.0~27.0°C (59~81°F)	
	Outdoor	W.B.	-20.0~15.5°C (-4~60°F)	
Indoor unit connectable	Total capacity	50~130% of outdoor unit capacity		
	Model/Quantity	P15-P250/2-50		
Sound pressure level (measured in anechoic room)	dB <A>	66		
Sound power level (measured in anechoic room)	dB <A>	87		
Refrigerant piping diameter	Liquid pipe	mm (in.)	19.05 (3/4) Brazed	
	Gas pipe	mm (in.)	41.28 (1-5/8) Brazed	

Model			PUHY-EP300YLM-A (-BS)		PUHY-EP300YLM-A (-BS)		PUHY-EP300YLM-A (-BS)	
FAN	Type x Quantity		Propeller fan x 1		Propeller fan x 1		Propeller fan x 1	
	Air flow rate	m ³ /min	200		200		200	
		L/s	3,333		3,333		3,333	
		cfm	7,062		7,062		7,062	
	Control, Driving mechanism		Inverter-control, Direct-driven by motor		Inverter-control, Direct-driven by motor		Inverter-control, Direct-driven by motor	
	*3	Motor output	kW	0.92 x 1		0.92 x 1		0.92 x 1
External static press.			0 Pa (0 mmH ₂ O)		0 Pa (0 mmH ₂ O)		0 Pa (0 mmH ₂ O)	
Compressor	Type x Quantity		Inverter scroll hermetic compressor		Inverter scroll hermetic compressor		Inverter scroll hermetic compressor	
	Manufacture		AC&R Works, MITSUBISHI ELECTRIC CORPORATION		AC&R Works, MITSUBISHI ELECTRIC CORPORATION		AC&R Works, MITSUBISHI ELECTRIC CORPORATION	
	Starting method		Inverter		Inverter		Inverter	
	Motor output	kW	8.1		8.1		8.1	
	Case heater	kW	-		-		-	
Lubricant		MEL32		MEL32		MEL32		
External finish			Pre-coated galvanized steel sheets (+powder coating for -BS type) <MUNSELL 5Y 8/1 or similar>		Pre-coated galvanized steel sheets (+powder coating for -BS type) <MUNSELL 5Y 8/1 or similar>		Pre-coated galvanized steel sheets (+powder coating for -BS type) <MUNSELL 5Y 8/1 or similar>	
External dimension H x W x D			mm	1,710 (1,650 without legs) x 1,220 x 740	1,710 (1,650 without legs) x 1,220 x 740	1,710 (1,650 without legs) x 1,220 x 740	1,710 (1,650 without legs) x 1,220 x 740	
			in.	67-3/8 (65 without legs) x 48-1/16 x 29-3/16	67-3/8 (65 without legs) x 48-1/16 x 29-3/16	67-3/8 (65 without legs) x 48-1/16 x 29-3/16	67-3/8 (65 without legs) x 48-1/16 x 29-3/16	
Protection devices	High pressure protection		High pressure sensor, High pressure switch at 4.15 MPa (601 psi)		High pressure sensor, High pressure switch at 4.15 MPa (601 psi)		High pressure sensor, High pressure switch at 4.15 MPa (601 psi)	
	Inverter circuit (COMP./FAN)		Over-heat protection, Over-current protection		Over-heat protection, Over-current protection		Over-heat protection, Over-current protection	
	Compressor		-		-		-	
	Fan motor		-		-		-	
Refrigerant	Type x original charge		R410A x 10.3 kg (23 lbs)		R410A x 10.3 kg (23 lbs)		R410A x 10.3 kg (23 lbs)	
	Control		LEV and HIC circuit					
Net weight			kg (lbs)	252 (556)	252 (556)	252 (556)	252 (556)	
Heat exchanger			Salt-resistant cross fin & aluminium tube		Salt-resistant cross fin & aluminium tube		Salt-resistant cross fin & aluminium tube	
HIC circuit (HIC: Heat Inter-Changer)			Copper pipe, tube-in-tube structure		Copper pipe, tube-in-tube structure		Copper pipe, tube-in-tube structure	
Pipe between unit and distributor	Liquid pipe	mm (in.)	12.7 (1/2) Brazed		12.7 (1/2) Brazed		12.7 (1/2) Brazed	
	Gas pipe	mm (in.)	28.58 (1-1/8) Brazed		28.58 (1-1/8) Brazed		28.58 (1-1/8) Brazed	
Defrosting method			Auto-defrost mode (Reversed refrigerant cycle, Hot gas)					
Drawing	External		WKJ94L366					
	Wiring		KE94C946		KE94C946		KE94C946	
Standard attachment	Document		Installation Manual					
	Accessory		Refrigerant conn. pipe					
Optional parts			Outdoor Twinning kit: CMY-Y300VBK3 Joint: CMY-Y102SS/LS-G2, CMY-Y202/302S-G2 Header: CMY-Y104/108/1010-G					
Remarks			Details on foundation work, duct work, insulation work, electrical wiring, power source switch, and other items shall be referred to the Installation Manual. Due to continuing improvement, above specifications may be subject to change without notice.					

Notes:	Unit converter
1.Nominal cooling conditions (subject to JIS B8615-1) Indoor: 27°C.D.B./19°C.W.B. (81°F.D.B./66°F.W.B.), Outdoor: 35°C.D.B./24°C.W.B. (95°F.D.B./75°F.W.B.) Pipe length: 7.5 m (24-9/16 ft.), Level difference: 0 m (0 ft.)	BTU/h =kW x 3,412
2.Nominal heating conditions (subject to JIS B8615-1) Indoor: 20°C.D.B. (68°F.D.B.), Outdoor: 7°C.D.B./6°C.W.B. (45°F.D.B./43°F.W.B.) Pipe length: 7.5 m (24-9/16 ft.), Level difference: 0 m (0 ft.)	cfm =m ³ /min x 35.31
3.External static pressure option is available (30Pa, 60Pa/3.1mmH ₂ O, 6.1mmH ₂ O).	lbs =kg/0.4536
	*Above specification data is subject to rounding variation.

1. SPECIFICATIONS

YKB/YLM

Y (HIGH COP)

Model			PUHY-EP950YSLM-A (-BS)		
Power source			3-phase 4-wire 380-400-415 V 50/60 Hz		
Cooling capacity (Nominal)	*1	kW	108.0		
		kcal/h	92,900		
		BTU/h	368,500		
	Power input	kW	30.33		
		Current input	A	51.2-48.6-46.8	
EER		kW/kW	3.56		
Temp. range of cooling	Indoor	W.B.	15.0~24.0°C (59~75°F)		
	Outdoor	D.B.	-5.0~52.0°C (23~126°F)		
Heating capacity (Nominal)	*2	kW	119.5		
		kcal/h	102,800		
		BTU/h	407,700		
	Power input	kW	32.03		
		Current input	A	54.0-51.3-49.5	
COP		kW/kW	3.73		
Temp. range of heating	Indoor	D.B.	15.0~27.0°C (59~81°F)		
	Outdoor	W.B.	-20.0~15.5°C (-4~60°F)		
Indoor unit connectable	Total capacity		50~130% of outdoor unit capacity		
	Model/Quantity		P15~P250/2~50		
Sound pressure level (measured in anechoic room)		dB <A>	66		
Sound power level (measured in anechoic room)		dB <A>	87		
Refrigerant piping diameter	Liquid pipe	mm (in.)	19.05 (3/4) Brazed		
	Gas pipe	mm (in.)	41.28 (1-5/8) Brazed		

Set Model								
Model		PUHY-EP300YLM-A (-BS)		PUHY-EP300YLM-A (-BS)		PUHY-EP350YLM-A (-BS)		
FAN	Type x Quantity		Propeller fan x 1		Propeller fan x 1		Propeller fan x 1	
	Air flow rate	m ³ /min	200		200		200	
		L/s	3,333		3,333		3,333	
		cfm	7,062		7,062		7,062	
	Control, Driving mechanism		Inverter-control, Direct-driven by motor		Inverter-control, Direct-driven by motor		Inverter-control, Direct-driven by motor	
*3	Motor output	kW	0.92 x 1		0.92 x 1		0.92 x 1	
External static press.		0 Pa (0 mmH ₂ O)		0 Pa (0 mmH ₂ O)		0 Pa (0 mmH ₂ O)		
Compressor	Type x Quantity		Inverter scroll hermetic compressor		Inverter scroll hermetic compressor		Inverter scroll hermetic compressor	
	Manufacture		AC&R Works, MITSUBISHI ELECTRIC CORPORATION		AC&R Works, MITSUBISHI ELECTRIC CORPORATION		AC&R Works, MITSUBISHI ELECTRIC CORPORATION	
	Starting method		Inverter		Inverter		Inverter	
	Motor output	kW	8.1		8.1		10.5	
	Case heater	kW	-		-		-	
	Lubricant		MEL32		MEL32		MEL32	
External finish		Pre-coated galvanized steel sheets (+powder coating for -BS type) <MUNSELL 5Y 8/1 or similar>		Pre-coated galvanized steel sheets (+powder coating for -BS type) <MUNSELL 5Y 8/1 or similar>		Pre-coated galvanized steel sheets (+powder coating for -BS type) <MUNSELL 5Y 8/1 or similar>		
External dimension H x W x D		mm	1,710 (1,650 without legs) x 1,220 x 740		1,710 (1,650 without legs) x 1,220 x 740		1,710 (1,650 without legs) x 1,220 x 740	
		in.	67-3/8 (65 without legs) x 48-1/16 x 29-3/16		67-3/8 (65 without legs) x 48-1/16 x 29-3/16		67-3/8 (65 without legs) x 48-1/16 x 29-3/16	
Protection devices	High pressure protection		High pressure sensor, High pressure switch at 4.15 MPa (601 psi)		High pressure sensor, High pressure switch at 4.15 MPa (601 psi)		High pressure sensor, High pressure switch at 4.15 MPa (601 psi)	
	Inverter circuit (COMP./FAN)		Over-heat protection, Over-current protection		Over-heat protection, Over-current protection		Over-heat protection, Over-current protection	
	Compressor		-		-		-	
	Fan motor		-		-		-	
Refrigerant	Type x original charge		R410A x 10.3 kg (23 lbs)		R410A x 10.3 kg (23 lbs)		R410A x 10.3 kg (23 lbs)	
	Control		LEV and HIC circuit		LEV and HIC circuit		LEV and HIC circuit	
Net weight		kg (lbs)	252 (556)		252 (556)		252 (556)	
Heat exchanger		Salt-resistant cross fin & aluminium tube		Salt-resistant cross fin & aluminium tube		Salt-resistant cross fin & aluminium tube		
HIC circuit (HIC: Heat Inter-Changer)		Copper pipe, tube-in-tube structure		Copper pipe, tube-in-tube structure		Copper pipe, tube-in-tube structure		
Pipe between unit and distributor	Liquid pipe	mm (in.)	12.7 (1/2) Brazed		12.7 (1/2) Brazed		12.7 (1/2) Brazed	
	Gas pipe	mm (in.)	28.58 (1-1/8) Brazed		28.58 (1-1/8) Brazed		28.58 (1-1/8) Brazed	
Defrosting method		Auto-defrost mode (Reversed refrigerant cycle, Hot gas)		Auto-defrost mode (Reversed refrigerant cycle, Hot gas)		Auto-defrost mode (Reversed refrigerant cycle, Hot gas)		
Drawing	External		WKJ94L366		WKJ94L366		WKJ94L366	
	Wiring		KE94C946		KE94C946		KE94C946	
Standard attachment	Document		Installation Manual		Installation Manual		Installation Manual	
	Accessory		Refrigerant conn. pipe		Refrigerant conn. pipe		Refrigerant conn. pipe	
Optional parts		Outdoor Twinning kit: CMY-Y300VBK3 Joint: CMY-Y102SS/LS-G2, CMY-Y202/302S-G2 Header: CMY-Y104/108/1010-G		Outdoor Twinning kit: CMY-Y300VBK3 Joint: CMY-Y102SS/LS-G2, CMY-Y202/302S-G2 Header: CMY-Y104/108/1010-G		Outdoor Twinning kit: CMY-Y300VBK3 Joint: CMY-Y102SS/LS-G2, CMY-Y202/302S-G2 Header: CMY-Y104/108/1010-G		
Remarks		Details on foundation work, duct work, insulation work, electrical wiring, power source switch, and other items shall be referred to the Installation Manual. Due to continuing improvement, above specifications may be subject to change without notice.		Details on foundation work, duct work, insulation work, electrical wiring, power source switch, and other items shall be referred to the Installation Manual. Due to continuing improvement, above specifications may be subject to change without notice.		Details on foundation work, duct work, insulation work, electrical wiring, power source switch, and other items shall be referred to the Installation Manual. Due to continuing improvement, above specifications may be subject to change without notice.		

Notes:		Unit converter	
1. Nominal cooling conditions (subject to JIS B8615-1) Indoor: 27°C D.B./19°C W.B. (81°F D.B./66°F W.B.), Outdoor: 35°C D.B./24°C W.B. (95°F D.B./75°F W.B.) Pipe length: 7.5 m (24-9/16 ft.), Level difference: 0 m (0 ft.)		BTU/h	=kW x 3,412
2. Nominal heating conditions (subject to JIS B8615-1) Indoor: 20°C D.B. (68°F D.B.), Outdoor: 7°C D.B./6°C W.B. (45°F D.B./43°F W.B.) Pipe length: 7.5 m (24-9/16 ft.), Level difference: 0 m (0 ft.)		cfm	=m ³ /min x 35.31
3. External static pressure option is available (30Pa, 60Pa/3.1mmH ₂ O, 6.1mmH ₂ O).		lbs	=kg/0.4536
		*Above specification data is subject to rounding variation.	

1. SPECIFICATIONS

YKB/YLM

Y (HIGH COP)

Model		PUHY-EP1000YSLM-A (-BS)	
Power source		3-phase 4-wire 380-400-415 V 50/60 Hz	
Cooling capacity (Nominal)	*1 kW	113.0	
	kcal/h	97,200	
	*1 BTU/h	385,600	
	Power input	kW	
	Current input	A	
EER	kW/kW		3.64
Temp. range of cooling	Indoor	W.B.	15.0~24.0°C (59~75°F)
	Outdoor	D.B.	-5.0~52.0°C (23~126°F)
Heating capacity (Nominal)	*2 kW	127.0	
	kcal/h	109,200	
	*2 BTU/h	433,300	
	Power input	kW	
	Current input	A	
COP	kW/kW		3.79
Temp. range of heating	Indoor	D.B.	15.0~27.0°C (59~81°F)
	Outdoor	W.B.	-20.0~15.5°C (-4~60°F)
Indoor unit connectable	Total capacity	50~130% of outdoor unit capacity	
	Model/Quantity	P15-P250/2-50	
Sound pressure level (measured in anechoic room)	dB <A>	66.5	
Sound power level (measured in anechoic room)	dB <A>	87	
Refrigerant piping diameter	Liquid pipe	mm (in.)	19.05 (3/4) Brazed
	Gas pipe	mm (in.)	41.28 (1-5/8) Brazed

Model		PUHY-EP300YLM-A (-BS)		PUHY-EP300YLM-A (-BS)		PUHY-EP400YLM-A (-BS)		
FAN	Type x Quantity	Propeller fan x 1		Propeller fan x 1		Propeller fan x 2		
	Air flow rate	m ³ /min	200		200		320	
		L/s	3,333		3,333		5,333	
		cfm	7,062		7,062		11,299	
	Control, Driving mechanism	Inverter-control, Direct-driven by motor		Inverter-control, Direct-driven by motor		Inverter-control, Direct-driven by motor		
	*3 Motor output	kW	0.92 x 1		0.92 x 1		0.92 x 2	
External static press.	0 Pa (0 mmH ₂ O)		0 Pa (0 mmH ₂ O)		0 Pa (0 mmH ₂ O)			
Compressor	Type x Quantity	Inverter scroll hermetic compressor		Inverter scroll hermetic compressor		Inverter scroll hermetic compressor		
	Manufacture	AC&R Works, MITSUBISHI ELECTRIC CORPORATION		AC&R Works, MITSUBISHI ELECTRIC CORPORATION		AC&R Works, MITSUBISHI ELECTRIC CORPORATION		
	Starting method	Inverter		Inverter		Inverter		
	Motor output	kW	8.1		8.1		10.9	
	Case heater	kW	-		-		-	
	Lubricant	MEL32		MEL32		MEL32		
External finish		Pre-coated galvanized steel sheets (+powder coating for -BS type) <MUNSELL 5Y 8/1 or similar>		Pre-coated galvanized steel sheets (+powder coating for -BS type) <MUNSELL 5Y 8/1 or similar>		Pre-coated galvanized steel sheets (+powder coating for -BS type) <MUNSELL 5Y 8/1 or similar>		
External dimension H x W x D		mm	1,710 (1,650 without legs) x 1,220 x 740		1,710 (1,650 without legs) x 1,220 x 740		1,710 (1,650 without legs) x 1,750 x 740	
		in.	67-3/8 (65 without legs) x 48-1/16 x 29-3/16		67-3/8 (65 without legs) x 48-1/16 x 29-3/16		67-3/8 (65 without legs) x 68-15/16 x 29-3/16	
Protection devices	High pressure protection	High pressure sensor, High pressure switch at 4.15 MPa (601 psi)		High pressure sensor, High pressure switch at 4.15 MPa (601 psi)		High pressure sensor, High pressure switch at 4.15 MPa (601 psi)		
	Inverter circuit (COMP./FAN)	Over-heat protection, Over-current protection		Over-heat protection, Over-current protection		Over-heat protection, Over-current protection		
	Compressor	-		-		-		
	Fan motor	-		-		-		
Refrigerant	Type x original charge	R410A x 10.3 kg (23 lbs)		R410A x 10.3 kg (23 lbs)		R410A x 11.8 kg (27 lbs)		
	Control			LEV and HIC circuit				
Net weight	kg (lbs)	252 (556)		252 (556)		318 (702)		
Heat exchanger	Salt-resistant cross fin & aluminium tube		Salt-resistant cross fin & aluminium tube		Salt-resistant cross fin & aluminium tube			
HIC circuit (HIC: Heat Inter-Changer)	Copper pipe, tube-in-tube structure		Copper pipe, tube-in-tube structure		Copper pipe, tube-in-tube structure			
Pipe between unit and distributor	Liquid pipe	mm (in.)	12.7 (1/2) Brazed		12.7 (1/2) Brazed		15.88 (5/8) Brazed	
	Gas pipe	mm (in.)	28.58 (1-1/8) Brazed		28.58 (1-1/8) Brazed		28.58 (1-1/8) Brazed	
Defrosting method	Auto-defrost mode (Reversed refrigerant cycle, Hot gas)							
Drawing	External	WKJ94R305		WKJ94R305		WKJ94R305		
	Wiring	WKE94C946		WKE94C946		WKE94C947		
Standard attachment	Document	Installation Manual		Installation Manual		Installation Manual		
	Accessory	Refrigerant conn. pipe		Refrigerant conn. pipe		Refrigerant conn. pipe		
Optional parts	Outdoor Twinning kit: CMY-Y300VBK3 Joint: CMY-Y102SS/LS-G2, CMY-Y202/302S-G2 Header: CMY-Y104/108/1010-G							
Remarks	Details on foundation work, duct work, insulation work, electrical wiring, power source switch, and other items shall be referred to the Installation Manual. Due to continuing improvement, above specifications may be subject to change without notice.							

Notes:	Unit converter
1.Nominal cooling conditions (subject to JIS B8615-1) Indoor: 27°C.D.B./19°C.W.B. (81°F.D.B./66°F.W.B.), Outdoor: 35°C.D.B./24°C.W.B. (95°F.D.B./75°F.W.B.) Pipe length: 7.5 m (24-9/16 ft.), Level difference: 0 m (0 ft.)	BTU/h =kW x 3,412
2.Nominal heating conditions (subject to JIS B8615-1) Indoor: 20°C.D.B. (68°F.D.B.), Outdoor: 7°C.D.B./6°C.W.B. (45°F.D.B./43°F.W.B.) Pipe length: 7.5 m (24-9/16 ft.), Level difference: 0 m (0 ft.)	cfm =m ³ /min x 35.31
3.External static pressure option is available (30Pa, 60Pa/3.1mmH ₂ O, 6.1mmH ₂ O).	lbs =kg/0.4536
	*Above specification data is subject to rounding variation.

1. SPECIFICATIONS

YKB/YLM

Y (HIGH COP)

Model			PUHY-EP1050YSLM-A (-BS)		
Power source			3-phase 4-wire 380-400-415 V 50/60 Hz		
Cooling capacity (Nominal)	*1	kW	118.0		
		kcal/h	101,500		
		BTU/h	402,600		
	Power input	kW	34.40		
		A	58.0-55.1-53.1		
EER	kW/kW	3.43			
Temp. range of cooling	Indoor	W.B.	15.0~24.0°C (59~75°F)		
	Outdoor	D.B.	-5.0~52.0°C (23~126°F)		
Heating capacity (Nominal)	*2	kW	132.0		
		kcal/h	113,500		
		BTU/h	450,400		
	Power input	kW	36.87		
		A	62.2-59.1-56.9		
COP	kW/kW	3.58			
Temp. range of heating	Indoor	D.B.	15.0~27.0°C (59~81°F)		
	Outdoor	W.B.	-20.0~15.5°C (-4~60°F)		
Indoor unit connectable	Total capacity	50~130% of outdoor unit capacity			
	Model/Quantity	P15~P250/3~50			
Sound pressure level (measured in anechoic room)		dB <A>	66.5		
Sound power level (measured in anechoic room)		dB <A>	87.5		
Refrigerant piping diameter	Liquid pipe	mm (in.)	19.05 (3/4) Brazed		
	Gas pipe	mm (in.)	41.28 (1-5/8) Brazed		

Set Model			PUHY-EP300YLM-A (-BS)			PUHY-EP350YLM-A (-BS)			PUHY-EP400YLM-A (-BS)		
FAN	Type x Quantity		Propeller fan x 1			Propeller fan x 1			Propeller fan x 2		
	Air flow rate	m ³ /min	200			200			320		
		L/s	3,333			3,333			5,333		
		cfm	7,062			7,062			11,299		
	Control, Driving mechanism		Inverter-control, Direct-driven by motor			Inverter-control, Direct-driven by motor			Inverter-control, Direct-driven by motor		
	Motor output	kW	0.92 x 1			0.92 x 1			0.92 x 2		
	*3 External static press.		0 Pa (0 mmH ₂ O)			0 Pa (0 mmH ₂ O)			0 Pa (0 mmH ₂ O)		
Compressor	Type x Quantity		Inverter scroll hermetic compressor			Inverter scroll hermetic compressor			Inverter scroll hermetic compressor		
	Manufacture		AC&R Works, MITSUBISHI ELECTRIC CORPORATION			AC&R Works, MITSUBISHI ELECTRIC CORPORATION			AC&R Works, MITSUBISHI ELECTRIC CORPORATION		
	Starting method		Inverter			Inverter			Inverter		
	Motor output	kW	8.1			10.5			10.9		
	Case heater	kW	-			-			-		
	Lubricant		MEL32			MEL32			MEL32		
External finish			Pre-coated galvanized steel sheets (+powder coating for -BS type) <MUNSELL 5Y 8/1 or similar>			Pre-coated galvanized steel sheets (+powder coating for -BS type) <MUNSELL 5Y 8/1 or similar>			Pre-coated galvanized steel sheets (+powder coating for -BS type) <MUNSELL 5Y 8/1 or similar>		
External dimension H x W x D		mm	1,710 (1,650 without legs) x 1,220 x 740			1,710 (1,650 without legs) x 1,220 x 740			1,710 (1,650 without legs) x 1,750 x 740		
		in.	67-3/8 (65 without legs) x 48-1/16 x 29-3/16			67-3/8 (65 without legs) x 48-1/16 x 29-3/16			67-3/8 (65 without legs) x 68-15/16 x 29-3/16		
Protection devices	High pressure protection		High pressure sensor, High pressure switch at 4.15 MPa (601 psi)			High pressure sensor, High pressure switch at 4.15 MPa (601 psi)			High pressure sensor, High pressure switch at 4.15 MPa (601 psi)		
	Inverter circuit (COMP./FAN)		Over-heat protection, Over-current protection			Over-heat protection, Over-current protection			Over-heat protection, Over-current protection		
	Compressor		-			-			-		
	Fan motor		-			-			-		
Refrigerant	Type x original charge		R410A x 10.3 kg (23 lbs)			R410A x 10.3 kg (23 lbs)			R410A x 11.8 kg (27 lbs)		
	Control		LEV and HIC circuit								
Net weight		kg (lbs)	252 (556)			252 (556)			318 (702)		
Heat exchanger			Salt-resistant cross fin & aluminium tube			Salt-resistant cross fin & aluminium tube			Salt-resistant cross fin & aluminium tube		
HIC circuit (HIC: Heat Inter-Changer)			Copper pipe, tube-in-tube structure								
Pipe between unit and distributor	Liquid pipe	mm (in.)	12.7 (1/2) Brazed			12.7 (1/2) Brazed			15.88 (5/8) Brazed		
	Gas pipe	mm (in.)	28.58 (1-1/8) Brazed			28.58 (1-1/8) Brazed			28.58 (1-1/8) Brazed		
Defrosting method			Auto-defrost mode (Reversed refrigerant cycle, Hot gas)								
Drawing	External		WKJ94R305								
	Wiring		WKE94C946			WKE94C946			WKE94C947		
Standard attachment	Document		Installation Manual								
	Accessory		Refrigerant conn. pipe								
Optional parts			Outdoor Twinning kit: CMY-Y300VBK3 Joint: CMY-Y102SS/LS-G2, CMY-Y202/302S-G2 Header: CMY-Y104/108/1010-G								
Remarks			Details on foundation work, duct work, insulation work, electrical wiring, power source switch, and other items shall be referred to the Installation Manual. Due to continuing improvement, above specifications may be subject to change without notice.								

Notes:		Unit converter	
1.Nominal cooling conditions (subject to JIS B8615-1) Indoor: 27°C D.B./19°C W.B. (81°F D.B./66°F W.B.), Outdoor: 35°C D.B./24°C W.B. (95°F D.B./75°F W.B.) Pipe length: 7.5 m (24-9/16 ft.), Level difference: 0 m (0 ft.)		BTU/h	=kW x 3,412
2.Nominal heating conditions (subject to JIS B8615-1) Indoor: 20°C D.B. (68°F D.B.), Outdoor: 7°C D.B./6°C W.B. (45°F D.B./43°F W.B.) Pipe length: 7.5 m (24-9/16 ft.), Level difference: 0 m (0 ft.)		cfm	=m ³ /min x 35.31
3.External static pressure option is available (30Pa, 60Pa/3.1mmH ₂ O, 6.1mmH ₂ O).		lbs	=kg/0.4536
		*Above specification data is subject to rounding variation.	

1. SPECIFICATIONS

YKB/YLM

Y (HIGH COP)

Model			PUHY-EP1100YSLM-A (-BS)	
Power source			3-phase 4-wire 380-400-415 V 50/60 Hz	
Cooling capacity (Nominal)	*1	kW	124.0	
		kcal/h	106,600	
		BTU/h	423,100	
	Power input	kW	38.15	
		Current input	A	
EER		kW/kW		
Temp. range of cooling	Indoor	W.B.	15.0~24.0°C (59~75°F)	
	Outdoor	D.B.	-5.0~52.0°C (23~126°F)	
Heating capacity (Nominal)	*2	kW	140.0	
		kcal/h	120,400	
		BTU/h	477,700	
	Power input	kW	41.17	
		Current input	A	
COP		kW/kW		
Temp. range of heating	Indoor	D.B.	15.0~27.0°C (59~81°F)	
	Outdoor	W.B.	-20.0~15.5°C (-4~60°F)	
Indoor unit connectable	Total capacity	50~130% of outdoor unit capacity		
	Model/Quantity	P15-P250/3-50		
Sound pressure level (measured in anechoic room)		dB <A>	66.5	
Sound power level (measured in anechoic room)		dB <A>	87.5	
Refrigerant piping diameter	Liquid pipe	mm (in.)	19.05 (3/4) Brazed	
	Gas pipe	mm (in.)	41.28 (1-5/8) Brazed	

Model			PUHY-EP350YLM-A (-BS)	PUHY-EP350YLM-A (-BS)	PUHY-EP400YLM-A (-BS)
FAN	Type x Quantity		Propeller fan x 1	Propeller fan x 1	Propeller fan x 2
	Air flow rate	m ³ /min	200	200	320
		L/s	3,333	3,333	5,333
		cfm	7,062	7,062	11,299
	Control, Driving mechanism		Inverter-control, Direct-driven by motor	Inverter-control, Direct-driven by motor	Inverter-control, Direct-driven by motor
	Motor output	kW	0.92 x 1	0.92 x 1	0.92 x 2
*3	External static press.		0 Pa (0 mmH ₂ O)	0 Pa (0 mmH ₂ O)	0 Pa (0 mmH ₂ O)
Compressor	Type x Quantity		Inverter scroll hermetic compressor	Inverter scroll hermetic compressor	Inverter scroll hermetic compressor
	Manufacture		AC&R Works, MITSUBISHI ELECTRIC CORPORATION	AC&R Works, MITSUBISHI ELECTRIC CORPORATION	AC&R Works, MITSUBISHI ELECTRIC CORPORATION
	Starting method		Inverter	Inverter	Inverter
	Motor output	kW	10.5	10.5	10.9
	Case heater	kW	-	-	-
Lubricant		MEL32			
External finish			Pre-coated galvanized steel sheets (+powder coating for -BS type) <MUNSELL 5Y 8/1 or similar>	Pre-coated galvanized steel sheets (+powder coating for -BS type) <MUNSELL 5Y 8/1 or similar>	Pre-coated galvanized steel sheets (+powder coating for -BS type) <MUNSELL 5Y 8/1 or similar>
External dimension H x W x D			mm 1,710 (1,650 without legs) x 1,220 x 740	mm 1,710 (1,650 without legs) x 1,220 x 740	mm 1,710 (1,650 without legs) x 1,750 x 740
			in. 67-3/8 (65 without legs) x 48-1/16 x 29-3/16	in. 67-3/8 (65 without legs) x 48-1/16 x 29-3/16	in. 67-3/8 (65 without legs) x 68-15/16 x 29-3/16
Protection devices	High pressure protection		High pressure sensor, High pressure switch at 4.15 MPa (601 psi)	High pressure sensor, High pressure switch at 4.15 MPa (601 psi)	High pressure sensor, High pressure switch at 4.15 MPa (601 psi)
	Inverter circuit (COMP./FAN)		Over-heat protection, Over-current protection	Over-heat protection, Over-current protection	Over-heat protection, Over-current protection
	Compressor		-	-	-
	Fan motor		-	-	-
Refrigerant	Type x original charge		R410A x 10.3 kg (23 lbs)	R410A x 10.3 kg (23 lbs)	R410A x 11.8 kg (27 lbs)
	Control		LEV and HIC circuit		
Net weight			kg (lbs) 252 (556)	kg (lbs) 252 (556)	kg (lbs) 318 (702)
Heat exchanger			Salt-resistant cross fin & aluminium tube		
HIC circuit (HIC: Heat Inter-Changer)			Copper pipe, tube-in-tube structure		
Pipe between unit and distributor	Liquid pipe	mm (in.)	12.7 (1/2) Brazed	12.7 (1/2) Brazed	15.88 (5/8) Brazed
	Gas pipe	mm (in.)	28.58 (1-1/8) Brazed	28.58 (1-1/8) Brazed	28.58 (1-1/8) Brazed
Defrosting method			Auto-defrost mode (Reversed refrigerant cycle, Hot gas)		
Drawing	External		WKJ94R305		
	Wiring		WKE94C946	WKE94C946	WKE94C947
Standard attachment	Document		Installation Manual		
	Accessory		Refrigerant conn. pipe		
Optional parts			Outdoor Twinning kit: CMY-Y300VBK3 Joint: CMY-Y102SS/LS-G2, CMY-Y202/302S-G2 Header: CMY-Y104/108/1010-G		
Remarks			Details on foundation work, duct work, insulation work, electrical wiring, power source switch, and other items shall be referred to the Installation Manual. Due to continuing improvement, above specifications may be subject to change without notice.		

Notes:	Unit converter
1.Nominal cooling conditions (subject to JIS B8615-1) Indoor: 27°C.D.B./19°C.W.B. (81°F.D.B./66°F.W.B.), Outdoor: 35°C.D.B./24°C.W.B. (95°F.D.B./75°F.W.B.) Pipe length: 7.5 m (24-9/16 ft.), Level difference: 0 m (0 ft.)	BTU/h =kW x 3,412
2.Nominal heating conditions (subject to JIS B8615-1) Indoor: 20°C.D.B. (68°F.D.B.), Outdoor: 7°C.D.B./6°C.W.B. (45°F.D.B./43°F.W.B.) Pipe length: 7.5 m (24-9/16 ft.), Level difference: 0 m (0 ft.)	cfm =m ³ /min x 35.31
3.External static pressure option is available (30Pa, 60Pa/3.1mmH ₂ O, 6.1mmH ₂ O).	lbs =kg/0.4536
	*Above specification data is subject to rounding variation.

1. SPECIFICATIONS

YKB/YLM

Y (HIGH COP)

Model			PUHY-EP1150YSLM-A (-BS)	
Power source			3-phase 4-wire 380-400-415 V 50/60 Hz	
Cooling capacity (Nominal)	*1	kW	130.0	
		kcal/h	111,800	
		BTU/h	443,600	
	Power input	kW	41.53	
		A	70.1-66.6-64.1	
EER	kW/kW	3.13		
Temp. range of cooling	Indoor	W.B.	15.0~24.0°C (59~75°F)	
	Outdoor	D.B.	-5.0~52.0°C (23~126°F)	
Heating capacity (Nominal)	*2	kW	145.0	
		kcal/h	124,700	
		BTU/h	494,700	
	Power input	kW	44.47	
		A	75.0-71.3-68.7	
COP	kW/kW	3.26		
Temp. range of heating	Indoor	D.B.	15.0~27.0°C (59~81°F)	
	Outdoor	W.B.	-20.0~15.5°C (-4~60°F)	
Indoor unit connectable	Total capacity	50~130% of outdoor unit capacity		
	Model/Quantity	P15~P250/3~50		
Sound pressure level (measured in anechoic room)		dB <A>	66.5	
Sound power level (measured in anechoic room)		dB <A>	87.5	
Refrigerant piping diameter	Liquid pipe	mm (in.)	19.05 (3/4) Brazed	
	Gas pipe	mm (in.)	41.28 (1-5/8) Brazed	

Set Model

Model			PUHY-EP350YLM-A (-BS)		PUHY-EP350YLM-A (-BS)		PUHY-EP450YLM-A (-BS)	
FAN	Type x Quantity		Propeller fan x 1		Propeller fan x 1		Propeller fan x 2	
	Air flow rate	m ³ /min	200		200		370	
		L/s	3,333		3,333		6,167	
		cfm	7,062		7,062		13,065	
	Control, Driving mechanism		Inverter-control, Direct-driven by motor		Inverter-control, Direct-driven by motor		Inverter-control, Direct-driven by motor	
	Motor output	kW	0.92 x 1		0.92 x 1		0.92 x 2	
	*3 External static press.		0 Pa (0 mmH ₂ O)		0 Pa (0 mmH ₂ O)		0 Pa (0 mmH ₂ O)	
Compressor	Type x Quantity		Inverter scroll hermetic compressor		Inverter scroll hermetic compressor		Inverter scroll hermetic compressor	
	Manufacture		AC&R Works, MITSUBISHI ELECTRIC CORPORATION		AC&R Works, MITSUBISHI ELECTRIC CORPORATION		AC&R Works, MITSUBISHI ELECTRIC CORPORATION	
	Starting method		Inverter		Inverter		Inverter	
	Motor output	kW	10.5		10.5		12.4	
	Case heater	kW	-		-		-	
Lubricant		MEL32		MEL32		MEL32		
External finish			Pre-coated galvanized steel sheets (+powder coating for -BS type) <MUNSELL 5Y 8/1 or similar>		Pre-coated galvanized steel sheets (+powder coating for -BS type) <MUNSELL 5Y 8/1 or similar>		Pre-coated galvanized steel sheets (+powder coating for -BS type) <MUNSELL 5Y 8/1 or similar>	
External dimension H x W x D			mm	1,710 (1,650 without legs) x 1,220 x 740	1,710 (1,650 without legs) x 1,220 x 740	1,710 (1,650 without legs) x 1,220 x 740	1,710 (1,650 without legs) x 1,750 x 740	
			in.	67-3/8 (65 without legs) x 48-1/16 x 29-3/16	67-3/8 (65 without legs) x 48-1/16 x 29-3/16	67-3/8 (65 without legs) x 48-1/16 x 29-3/16	67-3/8 (65 without legs) x 68-15/16 x 29-3/16	
Protection devices	High pressure protection		High pressure sensor, High pressure switch at 4.15 MPa (601 psi)		High pressure sensor, High pressure switch at 4.15 MPa (601 psi)		High pressure sensor, High pressure switch at 4.15 MPa (601 psi)	
	Inverter circuit (COMP./FAN)		Over-heat protection, Over-current protection		Over-heat protection, Over-current protection		Over-heat protection, Over-current protection	
	Compressor		-		-		-	
	Fan motor		-		-		-	
Refrigerant	Type x original charge		R410A x 10.3 kg (23 lbs)		R410A x 10.3 kg (23 lbs)		R410A x 11.8 kg (27 lbs)	
	Control		LEV and HIC circuit		LEV and HIC circuit		LEV and HIC circuit	
Net weight			kg (lbs)	252 (556)	252 (556)	252 (556)	318 (702)	
Heat exchanger			Salt-resistant cross fin & aluminium tube		Salt-resistant cross fin & aluminium tube		Salt-resistant cross fin & aluminium tube	
HIC circuit (HIC: Heat Inter-Changer)			Copper pipe, tube-in-tube structure		Copper pipe, tube-in-tube structure		Copper pipe, tube-in-tube structure	
Pipe between unit and distributor	Liquid pipe	mm (in.)	12.7 (1/2) Brazed		12.7 (1/2) Brazed		15.88 (5/8) Brazed	
	Gas pipe	mm (in.)	28.58 (1-1/8) Brazed		28.58 (1-1/8) Brazed		28.58 (1-1/8) Brazed	
Defrosting method			Auto-defrost mode (Reversed refrigerant cycle, Hot gas)		Auto-defrost mode (Reversed refrigerant cycle, Hot gas)		Auto-defrost mode (Reversed refrigerant cycle, Hot gas)	
Drawing	External		WKJ94R305		WKJ94R305		WKJ94R305	
	Wiring		WKE94C946		WKE94C946		WKE94C947	
Standard attachment	Document		Installation Manual		Installation Manual		Installation Manual	
	Accessory		Refrigerant conn. pipe		Refrigerant conn. pipe		Refrigerant conn. pipe	
Optional parts			Outdoor Twinning kit: CMY-Y300VBK3 Joint: CMY-Y102SS/LS-G2, CMY-Y202/302S-G2 Header: CMY-Y104/108/1010-G		Outdoor Twinning kit: CMY-Y300VBK3 Joint: CMY-Y102SS/LS-G2, CMY-Y202/302S-G2 Header: CMY-Y104/108/1010-G		Outdoor Twinning kit: CMY-Y300VBK3 Joint: CMY-Y102SS/LS-G2, CMY-Y202/302S-G2 Header: CMY-Y104/108/1010-G	
Remarks			Details on foundation work, duct work, insulation work, electrical wiring, power source switch, and other items shall be referred to the Installation Manual. Due to continuing improvement, above specifications may be subject to change without notice.		Details on foundation work, duct work, insulation work, electrical wiring, power source switch, and other items shall be referred to the Installation Manual. Due to continuing improvement, above specifications may be subject to change without notice.		Details on foundation work, duct work, insulation work, electrical wiring, power source switch, and other items shall be referred to the Installation Manual. Due to continuing improvement, above specifications may be subject to change without notice.	

Notes:

- Nominal cooling conditions (subject to JIS B8615-1)
Indoor: 27°C D.B./19°C W.B. (81°F D.B./66°F W.B.), Outdoor: 35°C D.B./24°C W.B. (95°F D.B./75°F W.B.)
Pipe length: 7.5 m (24-9/16 ft.), Level difference: 0 m (0 ft.)
- Nominal heating conditions (subject to JIS B8615-1)
Indoor: 20°C D.B./68°F D.B., Outdoor: 7°C D.B./6°C W.B. (45°F D.B./43°F W.B.)
Pipe length: 7.5 m (24-9/16 ft.), Level difference: 0 m (0 ft.)
- External static pressure option is available (30Pa, 60Pa/3.1mmH₂O, 6.1mmH₂O).

Unit converter

BTU/h =kW x 3,412
cfm =m³/min x 35.31
lbs =kg/0.4536

*Above specification data is subject to rounding variation.

1. SPECIFICATIONS

YKB/YLM

Y (HIGH COP)

Model			PUHY-EP1200YSLM-A (-BS)	
Power source			3-phase 4-wire 380-400-415 V 50/60 Hz	
Cooling capacity (Nominal)	*1	kW	136.0	
		kcal/h	117,000	
		BTU/h	464,000	
	Power input	kW	42.76	
		Current input	A	
EER		kW/kW		
Temp. range of cooling	Indoor	W.B.	15.0~24.0°C (59~75°F)	
	Outdoor	D.B.	-5.0~52.0°C (23~126°F)	
Heating capacity (Nominal)	*2	kW	150.0	
		kcal/h	129,000	
		BTU/h	511,800	
	Power input	kW	45.45	
		Current input	A	
COP		kW/kW		
Temp. range of heating	Indoor	D.B.	15.0~27.0°C (59~81°F)	
	Outdoor	W.B.	-20.0~15.5°C (-4~60°F)	
Indoor unit connectable	Total capacity	50~130% of outdoor unit capacity		
	Model/Quantity	P15-P250/3-50		
Sound pressure level (measured in anechoic room)		dB <A>	67	
Sound power level (measured in anechoic room)		dB <A>	87.5	
Refrigerant piping diameter	Liquid pipe	mm (in.)	19.05 (3/4) Brazed	
	Gas pipe	mm (in.)	41.28 (1-5/8) Brazed	

Set Model			PUHY-EP350YLM-A (-BS)		PUHY-EP400YLM-A (-BS)		PUHY-EP450YLM-A (-BS)	
FAN	Type x Quantity		Propeller fan x 1		Propeller fan x 2		Propeller fan x 2	
	Air flow rate	m ³ /min	200		320		370	
		L/s	3,333		5,333		6,167	
		cfm	7,062		11,299		13,065	
	Control, Driving mechanism		Inverter-control, Direct-driven by motor		Inverter-control, Direct-driven by motor		Inverter-control, Direct-driven by motor	
	*3	Motor output	kW	0.92 x 1		0.92 x 2		0.92 x 2
External static press.			0 Pa (0 mmH ₂ O)		0 Pa (0 mmH ₂ O)		0 Pa (0 mmH ₂ O)	
Compressor		Inverter scroll hermetic compressor		Inverter scroll hermetic compressor		Inverter scroll hermetic compressor		
Manufacture		AC&R Works, MITSUBISHI ELECTRIC CORPORATION		AC&R Works, MITSUBISHI ELECTRIC CORPORATION		AC&R Works, MITSUBISHI ELECTRIC CORPORATION		
Starting method		Inverter		Inverter		Inverter		
Motor output		kW	10.5		10.9		12.4	
Case heater		kW	-		-		-	
Lubricant		MEL32		MEL32		MEL32		
External finish			Pre-coated galvanized steel sheets (+powder coating for -BS type) <MUNSELL 5Y 8/1 or similar>		Pre-coated galvanized steel sheets (+powder coating for -BS type) <MUNSELL 5Y 8/1 or similar>		Pre-coated galvanized steel sheets (+powder coating for -BS type) <MUNSELL 5Y 8/1 or similar>	
External dimension H x W x D			mm		mm		mm	
			in.		in.		in.	
Protection devices			High pressure protection		High pressure protection		High pressure protection	
			Inverter circuit (COMP./FAN)		Inverter circuit (COMP./FAN)		Inverter circuit (COMP./FAN)	
			Compressor		Compressor		Compressor	
			Fan motor		Fan motor		Fan motor	
Refrigerant			Type x original charge		Type x original charge		Type x original charge	
			Control		Control		Control	
Net weight			kg (lbs)		kg (lbs)		kg (lbs)	
Heat exchanger			Salt-resistant cross fin & aluminium tube		Salt-resistant cross fin & aluminium tube		Salt-resistant cross fin & aluminium tube	
HIC circuit (HIC: Heat Inter-Changer)			Copper pipe, tube-in-tube structure		Copper pipe, tube-in-tube structure		Copper pipe, tube-in-tube structure	
Pipe between unit and distributor			Liquid pipe		Liquid pipe		Liquid pipe	
			Gas pipe		Gas pipe		Gas pipe	
Defrosting method			Auto-defrost mode (Reversed refrigerant cycle, Hot gas)					
Drawing			External		External		External	
			Wiring		Wiring		Wiring	
Standard attachment			Document		Document		Document	
			Accessory		Accessory		Accessory	
Optional parts			Outdoor Twinning kit: CMY-Y300VBK3 Joint: CMY-Y102SS/LS-G2, CMY-Y202/302S-G2 Header: CMY-Y104/108/1010-G					
Remarks			Details on foundation work, duct work, insulation work, electrical wiring, power source switch, and other items shall be referred to the Installation Manual. Due to continuing improvement, above specifications may be subject to change without notice.					

Notes:	Unit converter
1.Nominal cooling conditions (subject to JIS B8615-1) Indoor: 27°C.D.B./19°C.W.B. (81°F.D.B./66°F.W.B.), Outdoor: 35°C.D.B./24°C.W.B. (95°F.D.B./75°F.W.B.) Pipe length: 7.5 m (24-9/16 ft.), Level difference: 0 m (0 ft.)	BTU/h =kW x 3,412
2.Nominal heating conditions (subject to JIS B8615-1) Indoor: 20°C.D.B. (68°F.D.B.), Outdoor: 7°C.D.B./6°C.W.B. (45°F.D.B./43°F.W.B.) Pipe length: 7.5 m (24-9/16 ft.), Level difference: 0 m (0 ft.)	cfm =m ³ /min x 35.31
3.External static pressure option is available (30Pa, 60Pa/3.1mmH ₂ O, 6.1mmH ₂ O).	lbs =kg/0.4536
	*Above specification data is subject to rounding variation.

1. SPECIFICATIONS

YKB/YLM

Y (HIGH COP)

Model			PUHY-EP1250YSLM-A (-BS)	
Power source			3-phase 4-wire 380-400-415 V 50/60 Hz	
Cooling capacity (Nominal)	*1	kW	140.0	
		kcal/h	120,400	
		BTU/h	477,700	
	Power input	kW	45.90	
		A	77.4-73.6-70.9	
EER	kW/kW	3.05		
Temp. range of cooling	Indoor	W.B.	15.0~24.0°C (59~75°F)	
	Outdoor	D.B.	-5.0~52.0°C (23~126°F)	
Heating capacity (Nominal)	*2	kW	156.5	
		kcal/h	134,600	
		BTU/h	534,000	
	Power input	kW	49.36	
		A	83.3-79.1-76.2	
COP	kW/kW	3.17		
Temp. range of heating	Indoor	D.B.	15.0~27.0°C (59~81°F)	
	Outdoor	W.B.	-20.0~15.5°C (-4~60°F)	
Indoor unit connectable	Total capacity	50~130% of outdoor unit capacity		
	Model/Quantity	P15~P250/3~50		
Sound pressure level (measured in anechoic room)		dB <A>	67.5	
Sound power level (measured in anechoic room)		dB <A>	88	
Refrigerant piping diameter	Liquid pipe	mm (in.)	19.05 (3/4) Brazed	
	Gas pipe	mm (in.)	41.28 (1-5/8) Brazed	

Set Model			PUHY-EP350YLM-A (-BS)		PUHY-EP450YLM-A (-BS)		PUHY-EP450YLM-A (-BS)	
FAN	Type x Quantity		Propeller fan x 1		Propeller fan x 2		Propeller fan x 2	
	Air flow rate	m ³ /min	200		370		370	
		L/s	3,333		6,167		6,167	
		cfm	7,062		13,065		13,065	
	Control, Driving mechanism		Inverter-control, Direct-driven by motor		Inverter-control, Direct-driven by motor		Inverter-control, Direct-driven by motor	
	Motor output	kW	0.92 x 1		0.92 x 2		0.92 x 2	
	*3 External static press.		0 Pa (0 mmH ₂ O)		0 Pa (0 mmH ₂ O)		0 Pa (0 mmH ₂ O)	
Compressor	Type x Quantity		Inverter scroll hermetic compressor		Inverter scroll hermetic compressor		Inverter scroll hermetic compressor	
	Manufacture		AC&R Works, MITSUBISHI ELECTRIC CORPORATION		AC&R Works, MITSUBISHI ELECTRIC CORPORATION		AC&R Works, MITSUBISHI ELECTRIC CORPORATION	
	Starting method		Inverter		Inverter		Inverter	
	Motor output	kW	10.5		12.4		12.4	
	Case heater	kW	-		-		-	
	Lubricant		MEL32		MEL32		MEL32	
External finish			Pre-coated galvanized steel sheets (+powder coating for -BS type) <MUNSELL 5Y 8/1 or similar>		Pre-coated galvanized steel sheets (+powder coating for -BS type) <MUNSELL 5Y 8/1 or similar>		Pre-coated galvanized steel sheets (+powder coating for -BS type) <MUNSELL 5Y 8/1 or similar>	
External dimension H x W x D			mm	1,710 (1,650 without legs) x 1,220 x 740	1,710 (1,650 without legs) x 1,750 x 740	1,710 (1,650 without legs) x 1,750 x 740	1,710 (1,650 without legs) x 1,750 x 740	
			in.	67-3/8 (65 without legs) x 48-1/16 x 29-3/16	67-3/8 (65 without legs) x 68-15/16 x 29-3/16	67-3/8 (65 without legs) x 68-15/16 x 29-3/16	67-3/8 (65 without legs) x 68-15/16 x 29-3/16	
Protection devices	High pressure protection		High pressure sensor, High pressure switch at 4.15 MPa (601 psi)		High pressure sensor, High pressure switch at 4.15 MPa (601 psi)		High pressure sensor, High pressure switch at 4.15 MPa (601 psi)	
	Inverter circuit (COMP./FAN)		Over-heat protection, Over-current protection		Over-heat protection, Over-current protection		Over-heat protection, Over-current protection	
	Compressor		-		-		-	
	Fan motor		-		-		-	
Refrigerant	Type x original charge		R410A x 10.3 kg (23 lbs)		R410A x 11.8 kg (27 lbs)		R410A x 11.8 kg (27 lbs)	
	Control		LEV and HIC circuit		LEV and HIC circuit		LEV and HIC circuit	
Net weight			kg (lbs)	252 (556)	318 (702)	318 (702)	318 (702)	
Heat exchanger			Salt-resistant cross fin & aluminium tube		Salt-resistant cross fin & aluminium tube		Salt-resistant cross fin & aluminium tube	
HIC circuit (HIC: Heat Inter-Changer)			Copper pipe, tube-in-tube structure		Copper pipe, tube-in-tube structure		Copper pipe, tube-in-tube structure	
Pipe between unit and distributor	Liquid pipe	mm (in.)	12.7 (1/2) Brazed		15.88 (5/8) Brazed		15.88 (5/8) Brazed	
	Gas pipe	mm (in.)	28.58 (1-1/8) Brazed		28.58 (1-1/8) Brazed		28.58 (1-1/8) Brazed	
Defrosting method			Auto-defrost mode (Reversed refrigerant cycle, Hot gas)					
Drawing	External		WKJ94R306					
	Wiring		WKE94C946	WKE94C947	WKE94C947			
Standard attachment	Document		Installation Manual					
	Accessory		Refrigerant conn. pipe					
Optional parts			Outdoor Twinning kit: CMY-Y300VBK3 Joint: CMY-Y102SS/LS-G2, CMY-Y202/302S-G2 Header: CMY-Y104/108/1010-G					
Remarks			Details on foundation work, duct work, insulation work, electrical wiring, power source switch, and other items shall be referred to the Installation Manual. Due to continuing improvement, above specifications may be subject to change without notice.					

Notes:	Unit converter
1. Nominal cooling conditions (subject to JIS B8615-1) Indoor: 27°C D.B./19°C W.B. (81°F D.B./66°F W.B.), Outdoor: 35°C D.B./24°C W.B. (95°F D.B./75°F W.B.) Pipe length: 7.5 m (24-9/16 ft.), Level difference: 0 m (0 ft.)	BTU/h = kW x 3,412
2. Nominal heating conditions (subject to JIS B8615-1) Indoor: 20°C D.B. (68°F D.B.), Outdoor: 7°C D.B./6°C W.B. (45°F D.B./43°F W.B.) Pipe length: 7.5 m (24-9/16 ft.), Level difference: 0 m (0 ft.)	cfm = m ³ /min x 35.31
3. External static pressure option is available (30Pa, 60Pa/3.1mmH ₂ O, 6.1mmH ₂ O).	lbs = kg/0.4536
	*Above specification data is subject to rounding variation.

1. SPECIFICATIONS

YKB/YLM

Y (HIGH COP)

Model			PUHY-EP1300YSLM-A (-BS)	
Power source			3-phase 4-wire 380-400-415 V 50/60 Hz	
Cooling capacity (Nominal)	*1	kW	146.0	
		kcal/h	125,600	
		BTU/h	498,200	
	Power input	kW	46.94	
		Current input	A	
EER		kW/kW		
Temp. range of cooling	Indoor	W.B.	15.0~24.0°C (59~75°F)	
	Outdoor	D.B.	-5.0~52.0°C (23~126°F)	
Heating capacity (Nominal)	*2	kW	163.0	
		kcal/h	140,200	
		BTU/h	556,200	
	Power input	kW	50.62	
		Current input	A	
COP		kW/kW		
Temp. range of heating	Indoor	D.B.	15.0~27.0°C (59~81°F)	
	Outdoor	W.B.	-20.0~15.5°C (-4~60°F)	
Indoor unit connectable	Total capacity	50~130% of outdoor unit capacity		
	Model/Quantity	P15-P250/3-50		
Sound pressure level (measured in anechoic room)		dB <A>	68	
Sound power level (measured in anechoic room)		dB <A>	88	
Refrigerant piping diameter	Liquid pipe	mm (in.)	19.05 (3/4) Brazed	
	Gas pipe	mm (in.)	41.28 (1-5/8) Brazed	

Set Model			PUHY-EP400YLM-A (-BS)		PUHY-EP450YLM-A (-BS)		PUHY-EP450YLM-A (-BS)	
FAN	Type x Quantity		Propeller fan x 2		Propeller fan x 2		Propeller fan x 2	
	Air flow rate	m ³ /min	320		370		370	
		L/s	5,333		6,167		6,167	
		cfm	11,299		13,065		13,065	
	Control, Driving mechanism		Inverter-control, Direct-driven by motor		Inverter-control, Direct-driven by motor		Inverter-control, Direct-driven by motor	
	*3	Motor output	kW	0.92 x 2		0.92 x 2		0.92 x 2
External static press.			0 Pa (0 mmH ₂ O)		0 Pa (0 mmH ₂ O)		0 Pa (0 mmH ₂ O)	
Compressor	Type x Quantity		Inverter scroll hermetic compressor		Inverter scroll hermetic compressor		Inverter scroll hermetic compressor	
	Manufacture		AC&R Works, MITSUBISHI ELECTRIC CORPORATION		AC&R Works, MITSUBISHI ELECTRIC CORPORATION		AC&R Works, MITSUBISHI ELECTRIC CORPORATION	
	Starting method		Inverter		Inverter		Inverter	
	Motor output	kW	10.9		12.4		12.4	
	Case heater	kW	-		-		-	
Lubricant		MEL32		MEL32		MEL32		
External finish			Pre-coated galvanized steel sheets (+powder coating for -BS type) <MUNSELL 5Y 8/1 or similar>		Pre-coated galvanized steel sheets (+powder coating for -BS type) <MUNSELL 5Y 8/1 or similar>		Pre-coated galvanized steel sheets (+powder coating for -BS type) <MUNSELL 5Y 8/1 or similar>	
External dimension H x W x D			mm		mm		mm	
			in.		in.		in.	
Protection devices	High pressure protection		High pressure sensor, High pressure switch at 4.15 MPa (601 psi)		High pressure sensor, High pressure switch at 4.15 MPa (601 psi)		High pressure sensor, High pressure switch at 4.15 MPa (601 psi)	
	Inverter circuit (COMP./FAN)		Over-heat protection, Over-current protection		Over-heat protection, Over-current protection		Over-heat protection, Over-current protection	
	Compressor		-		-		-	
	Fan motor		-		-		-	
Refrigerant	Type x original charge		R410A x 11.8 kg (27 lbs)		R410A x 11.8 kg (27 lbs)		R410A x 11.8 kg (27 lbs)	
	Control		LEV and HIC circuit		LEV and HIC circuit		LEV and HIC circuit	
Net weight			kg (lbs)		kg (lbs)		kg (lbs)	
			318 (702)		318 (702)		318 (702)	
Heat exchanger			Salt-resistant cross fin & aluminium tube		Salt-resistant cross fin & aluminium tube		Salt-resistant cross fin & aluminium tube	
HIC circuit (HIC: Heat Inter-Changer)			Copper pipe, tube-in-tube structure		Copper pipe, tube-in-tube structure		Copper pipe, tube-in-tube structure	
Pipe between unit and distributor	Liquid pipe	mm (in.)	15.88 (5/8) Brazed		15.88 (5/8) Brazed		15.88 (5/8) Brazed	
	Gas pipe	mm (in.)	28.58 (1-1/8) Brazed		28.58 (1-1/8) Brazed		28.58 (1-1/8) Brazed	
Defrosting method			Auto-defrost mode (Reversed refrigerant cycle, Hot gas)					
Drawing	External		WKJ94R307					
	Wiring		WKE94C947		WKE94C947		WKE94C947	
Standard attachment	Document		Installation Manual					
	Accessory		Refrigerant conn. pipe					
Optional parts			Outdoor Twinning kit: CMY-Y300VBK3 Joint: CMY-Y102SS/LS-G2, CMY-Y202/302S-G2 Header: CMY-Y104/108/1010-G					
Remarks			Details on foundation work, duct work, insulation work, electrical wiring, power source switch, and other items shall be referred to the Installation Manual. Due to continuing improvement, above specifications may be subject to change without notice.					

Notes:	Unit converter
1.Nominal cooling conditions (subject to JIS B8615-1) Indoor: 27°C.D.B./19°C.W.B. (81°F.D.B./66°F.W.B.), Outdoor: 35°C.D.B./24°C.W.B. (95°F.D.B./75°F.W.B.) Pipe length: 7.5 m (24-9/16 ft.), Level difference: 0 m (0 ft.)	BTU/h =kW x 3,412
2.Nominal heating conditions (subject to JIS B8615-1) Indoor: 20°C.D.B. (68°F.D.B.), Outdoor: 7°C.D.B./6°C.W.B. (45°F.D.B./43°F.W.B.) Pipe length: 7.5 m (24-9/16 ft.), Level difference: 0 m (0 ft.)	cfm =m ³ /min x 35.31
3.External static pressure option is available (30Pa, 60Pa/3.1mmH ₂ O, 6.1mmH ₂ O).	lbs =kg/0.4536
	*Above specification data is subject to rounding variation.

1. SPECIFICATIONS

YKB/YLM

Y (HIGH COP)

Model			PUHY-EP1350YSLM-A (-BS)	
Power source			3-phase 4-wire 380-400-415 V 50/60 Hz	
Cooling capacity (Nominal)	*1	kW	150.0	
		kcal/h	129,000	
		BTU/h	511,800	
	Power input	kW	50.00	
		A	84.4-80.1-77.2	
EER	kW/kW	3.00		
Temp. range of cooling	Indoor	W.B.	15.0~24.0°C (59~75°F)	
	Outdoor	D.B.	-5.0~52.0°C (23~126°F)	
Heating capacity (Nominal)	*2	kW	168.0	
		kcal/h	144,500	
		BTU/h	573,200	
	Power input	kW	54.36	
		A	91.7-87.1-84.0	
COP	kW/kW	3.09		
Temp. range of heating	Indoor	D.B.	15.0~27.0°C (59~81°F)	
	Outdoor	W.B.	-20.0~15.5°C (-4~60°F)	
Indoor unit connectable	Total capacity	50~130% of outdoor unit capacity		
	Model/Quantity	P15~P250/3~50		
Sound pressure level (measured in anechoic room)		dB <A>	68	
Sound power level (measured in anechoic room)		dB <A>	88	
Refrigerant piping diameter	Liquid pipe	mm (in.)	19.05 (3/4) Brazed	
	Gas pipe	mm (in.)	41.28 (1-5/8) Brazed	

Set Model			PUHY-EP450YLM-A (-BS)		PUHY-EP450YLM-A (-BS)		PUHY-EP450YLM-A (-BS)	
FAN	Type x Quantity		Propeller fan x 2		Propeller fan x 2		Propeller fan x 2	
	Air flow rate	m ³ /min	370		370		370	
		L/s	6,167		6,167		6,167	
		cfm	13,065		13,065		13,065	
	Control, Driving mechanism		Inverter-control, Direct-driven by motor		Inverter-control, Direct-driven by motor		Inverter-control, Direct-driven by motor	
	Motor output	kW	0.92 x 2		0.92 x 2		0.92 x 2	
	*3	External static press.	0 Pa (0 mmH ₂ O)		0 Pa (0 mmH ₂ O)		0 Pa (0 mmH ₂ O)	
Compressor	Type x Quantity		Inverter scroll hermetic compressor		Inverter scroll hermetic compressor		Inverter scroll hermetic compressor	
	Manufacture		AC&R Works, MITSUBISHI ELECTRIC CORPORATION		AC&R Works, MITSUBISHI ELECTRIC CORPORATION		AC&R Works, MITSUBISHI ELECTRIC CORPORATION	
	Starting method		Inverter		Inverter		Inverter	
	Motor output	kW	12.4		12.4		12.4	
	Case heater	kW	-		-		-	
	Lubricant		MEL32		MEL32		MEL32	
External finish			Pre-coated galvanized steel sheets (+powder coating for -BS type) <MUNSELL 5Y 8/1 or similar>		Pre-coated galvanized steel sheets (+powder coating for -BS type) <MUNSELL 5Y 8/1 or similar>		Pre-coated galvanized steel sheets (+powder coating for -BS type) <MUNSELL 5Y 8/1 or similar>	
External dimension H x W x D			mm	1,710 (1,650 without legs) x 1,750 x 740	1,710 (1,650 without legs) x 1,750 x 740	1,710 (1,650 without legs) x 1,750 x 740	1,710 (1,650 without legs) x 1,750 x 740	
			in.	67-3/8 (65 without legs) x 68-15/16 x 29-3/16	67-3/8 (65 without legs) x 68-15/16 x 29-3/16	67-3/8 (65 without legs) x 68-15/16 x 29-3/16	67-3/8 (65 without legs) x 68-15/16 x 29-3/16	
Protection devices	High pressure protection		High pressure sensor, High pressure switch at 4.15 MPa (601 psi)		High pressure sensor, High pressure switch at 4.15 MPa (601 psi)		High pressure sensor, High pressure switch at 4.15 MPa (601 psi)	
	Inverter circuit (COMP./FAN)		Over-heat protection, Over-current protection		Over-heat protection, Over-current protection		Over-heat protection, Over-current protection	
	Compressor		-		-		-	
	Fan motor		-		-		-	
Refrigerant	Type x original charge		R410A x 11.8 kg (27 lbs)		R410A x 11.8 kg (27 lbs)		R410A x 11.8 kg (27 lbs)	
	Control		LEV and HIC circuit		LEV and HIC circuit		LEV and HIC circuit	
Net weight			kg (lbs)	318 (702)	318 (702)	318 (702)	318 (702)	
Heat exchanger			Salt-resistant cross fin & aluminium tube		Salt-resistant cross fin & aluminium tube		Salt-resistant cross fin & aluminium tube	
HIC circuit (HIC: Heat Inter-Changer)			Copper pipe, tube-in-tube structure		Copper pipe, tube-in-tube structure		Copper pipe, tube-in-tube structure	
Pipe between unit and distributor	Liquid pipe	mm (in.)	15.88 (5/8) Brazed		15.88 (5/8) Brazed		15.88 (5/8) Brazed	
	Gas pipe	mm (in.)	28.58 (1-1/8) Brazed		28.58 (1-1/8) Brazed		28.58 (1-1/8) Brazed	
Defrosting method			Auto-defrost mode (Reversed refrigerant cycle, Hot gas)		Auto-defrost mode (Reversed refrigerant cycle, Hot gas)		Auto-defrost mode (Reversed refrigerant cycle, Hot gas)	
Drawing	External		WKJ94R307		WKJ94R307		WKJ94R307	
	Wiring		WKE94C947		WKE94C947		WKE94C947	
Standard attachment	Document		Installation Manual		Installation Manual		Installation Manual	
	Accessory		Refrigerant conn. pipe		Refrigerant conn. pipe		Refrigerant conn. pipe	
Optional parts			Outdoor Twinning kit: CMY-Y300VBK3 Joint: CMY-Y102SS/LS-G2, CMY-Y202/302S-G2 Header: CMY-Y104/108/1010-G		Outdoor Twinning kit: CMY-Y300VBK3 Joint: CMY-Y102SS/LS-G2, CMY-Y202/302S-G2 Header: CMY-Y104/108/1010-G		Outdoor Twinning kit: CMY-Y300VBK3 Joint: CMY-Y102SS/LS-G2, CMY-Y202/302S-G2 Header: CMY-Y104/108/1010-G	
Remarks			Details on foundation work, duct work, insulation work, electrical wiring, power source switch, and other items shall be referred to the Installation Manual. Due to continuing improvement, above specifications may be subject to change without notice.		Details on foundation work, duct work, insulation work, electrical wiring, power source switch, and other items shall be referred to the Installation Manual. Due to continuing improvement, above specifications may be subject to change without notice.		Details on foundation work, duct work, insulation work, electrical wiring, power source switch, and other items shall be referred to the Installation Manual. Due to continuing improvement, above specifications may be subject to change without notice.	

Notes:	Unit converter
1. Nominal cooling conditions (subject to JIS B8615-1) Indoor: 27°C D.B./19°C W.B. (81°F D.B./66°F W.B.), Outdoor: 35°C D.B./24°C W.B. (95°F D.B./75°F W.B.) Pipe length: 7.5 m (24-9/16 ft.), Level difference: 0 m (0 ft.)	BTU/h = kW x 3,412
2. Nominal heating conditions (subject to JIS B8615-1) Indoor: 20°C D.B. (68°F D.B.), Outdoor: 7°C D.B./6°C W.B. (45°F D.B./43°F W.B.) Pipe length: 7.5 m (24-9/16 ft.), Level difference: 0 m (0 ft.)	cfm = m ³ /min x 35.31
3. External static pressure option is available (30Pa, 60Pa/3.1mmH ₂ O, 6.1mmH ₂ O).	lbs = kg/0.4536
	*Above specification data is subject to rounding variation.

PUHY-EP200, 250YLM-A (-BS)

Unit : mm

- <Accessories>
 ● Connecting pipe
 <Gas>
 · Pipe (IDø22.2×ODø28.58) ... EP200, EP250 1pc.
 · Pipe (IDø28.58×ODø22.2) ... EP200, EP250 1pc.
 · Elbow (IDø28.58×IDø28.58) ... EP200, EP250 1pc.
 <Liquid>
 · Pipe (IDø9.52×ODø9.52) ... EP200, EP250 1pc.
 · Pipe (IDø9.52×ODø12.7) ... EP250 1pc.

Note 1. Please refer to the next page for information regarding necessary spacing around the unit and foundation work.
 2. The detachable leg can be removed at site.
 3. At brazing of pipes, wrap the refrigerant service valve with wet cloth and keep the temperature of refrigerant service valve under 120°C.
 4. Used only when a separately-sold unit is attached. Refer to the Installation Manual of the unit for details.

Connecting pipe specifications

Model	Refrigerant pipe		Diameter	
	Liquid	Gas	Liquid	Gas
PUHY-EP200YLM-A(-BS)	ø9.52 Brazeed *1	ø22.2 Brazeed *1	ø9.52	ø28.58
PUHY-EP250YLM-A(-BS)	ø9.52 Brazeed *1, *2 (ø12.7 Brazeed) *1, *2	ø22.2 Brazeed *1, *2	ø9.52	ø28.58

*1 Use the included connecting pipe and connect to the refrigerant service valve piping
 *2 Furthest piping length (OU from IU)≥90m

NO.	Usage	Specifications
①	For pipes	Front through hole 140×77 Knockout hole
②		Bottom through hole 150×94 Knockout hole
③	For wires	Front through hole ø65 or ø40 Knockout hole
④		Front through hole ø52 or ø27 Knockout hole
⑤		Bottom through hole ø65 Knockout hole
⑥	For transmission cables	Bottom through hole ø52 Knockout hole
⑦		Front through hole ø34 Knockout hole

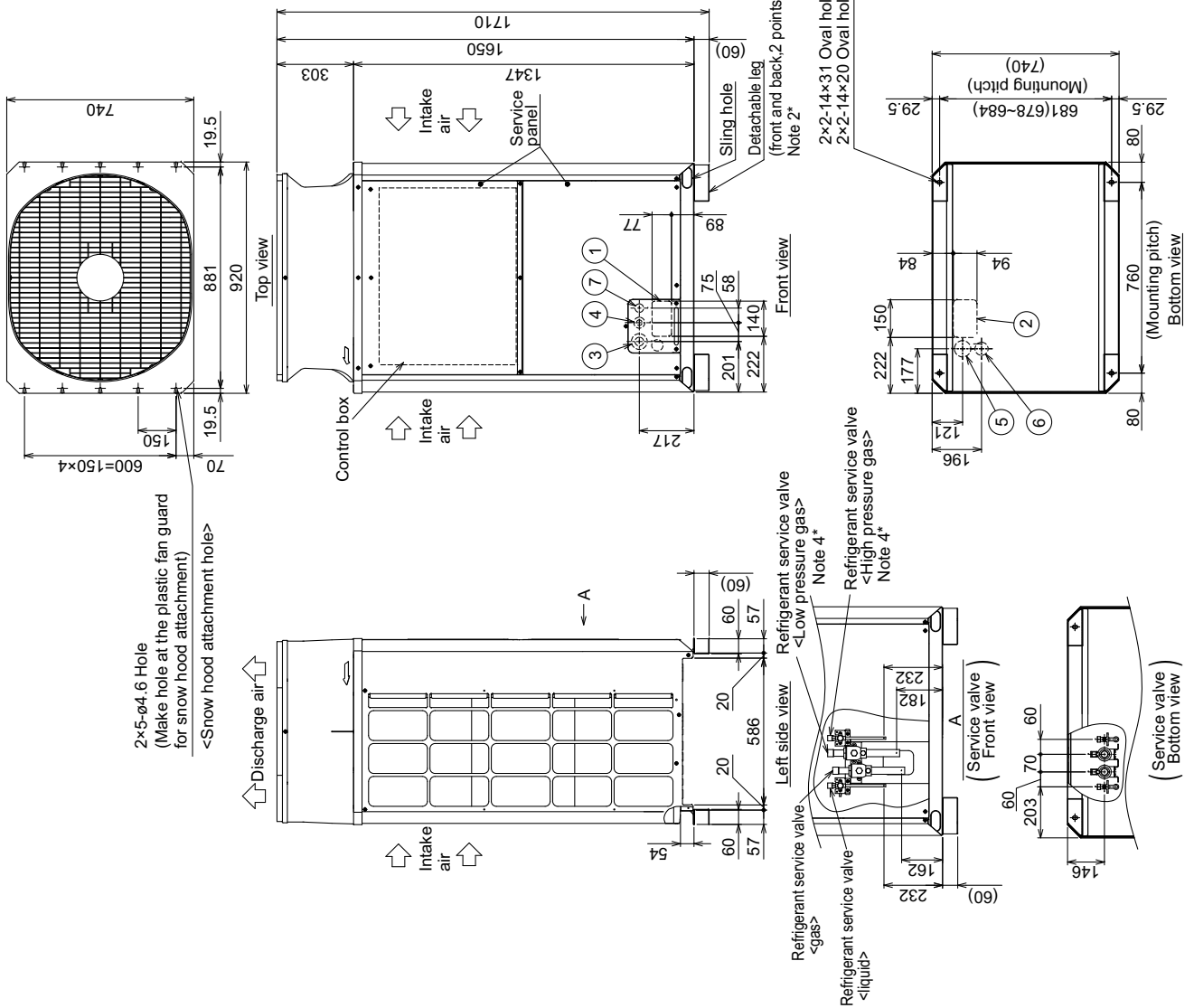

PUHY-EP200, 250YLM-A (-BS)

Unit : mm

● In case of collective installation

- ① When multiple units are installed adjacent to each other, secure enough space to allow for air circulation and walkway between groups of units as shown in the figures below.
- ② At least two sides must be left open.
- ③ As with the single installation, add the height that exceeds the height limit<h> to the figures that are marked with an asterisk.
- ④ If there is a wall at both the front and the rear of the unit, install up to six units consecutively in the side direction and provide a space of 1000mm or more as inlet space/ passage space for each six units.

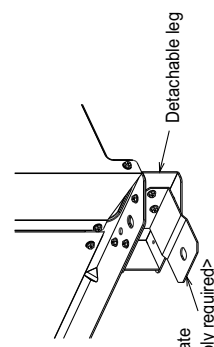
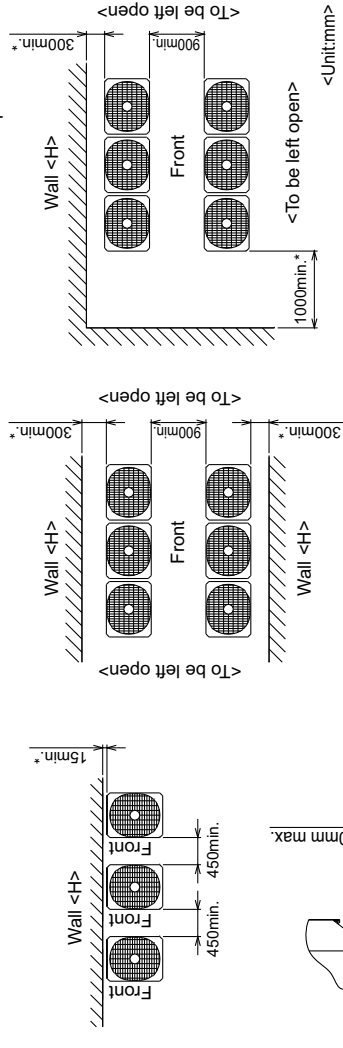
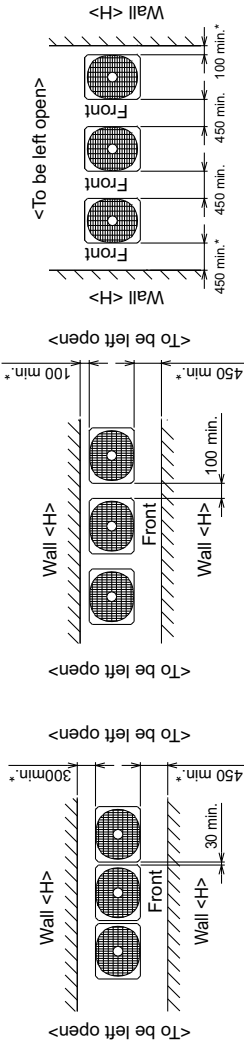

Fig.D (with detachable legs)

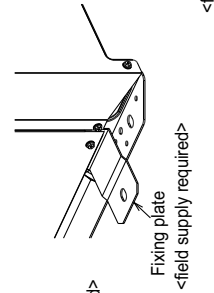

Fig.C (without detachable legs)

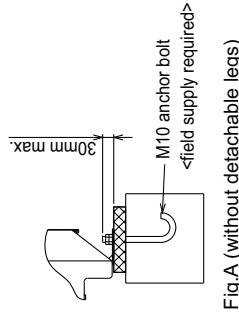

Fig.A (without detachable legs)

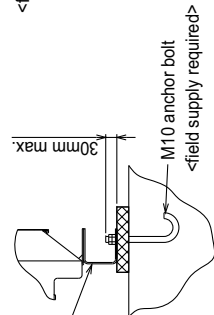
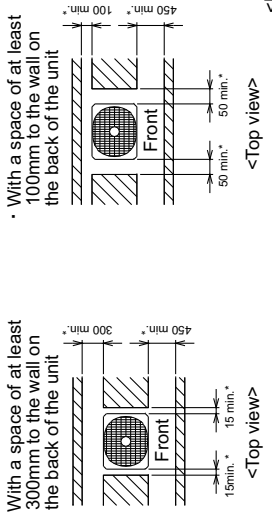

Fig.B (with detachable legs)

1. Required space around the unit

● In case of single installation

- ① Secure enough space around the unit as shown in the figure below.



- ② When the height of the walls on the front, back or on the sides<H> exceeds the wall height limit as defined below, add the height that exceeds the height limit <h> to the figures that are marked with an asterisk.

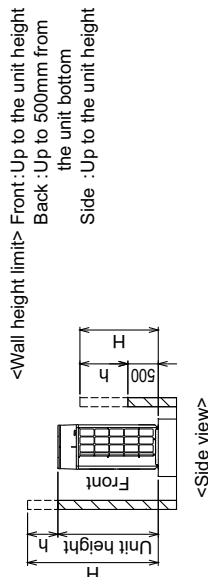

2. Foundation work

- ① Take into consideration the surface strength, water drainage route, piping route, and wiring route when preparing the installation site. <Note that the drain water comes out of the unit during operation.>
- ② Build the foundation in such way that the corner of the installation leg is securely supported as shown in the right figure.(Fig.A,B) When using a rubber isolating cushion, please ensure it is large enough to cover the entire width of each of the unit's legs.
- ③ The protrusion length of the anchor bolt must not exceed 30mm.(Fig.A,B)
- ④ Use four fixing plates as shown in the right figure <field supply required> when using post-installed anchor bolts.(Fig.C,D)
- ⑤ To prevent small animals and water and snow from entering the unit and damaging its parts, close the gap around the edges of through holes for pipes and wires with filler plates <field supply required>.
- ⑥ When the pipes or cables are routed at the bottom of the unit, make sure that the through hole at the base of the unit does not get blocked with the installation base.
- ⑦ Refer to the Installation Manual when installing units on an installation base.

PUHY-EP300, 350YLM-A (-BS)

Unit : mm

- <Accessories>
 • Connecting pipe
 <Gas>
 • Pipe (IDø28.58×ODø28.58) ... EP300,EP350 1pc.
 • Elbow(IDø28.58×IDø28.58) ... EP300,EP350 1pc.
 <Liquid>
 • Pipe (IDø12.7×ODø9.52) ... EP300 1pc.
 • Pipe (IDø12.7×ODø12.7) ... EP300,EP350 1pc.

Note1. Please refer to the next page for information regarding necessary spacing around the unit and foundation work.
 2. The detachable leg can be removed at site.
 3. At brazing of pipes, wrap the refrigerant service valve with wet cloth and keep the temperature of refrigerant service valve under 120°C.
 4. Used only when a separately-sold unit is attached. Refer to the Installation Manual of the unit for details.

Connecting pipe specifications

Model	Refrigerant pipe		Diameter	
	Liquid	Gas	Liquid	Gas
PUHY-EP300YLM-A(-BS)	ø9.52 Braze	ø12.7 Braze	ø12.7	ø28.58
PUHY-EP350YLM-A(-BS)	ø12.7 Braze*1	ø12.7 Braze*1	ø12.7	ø28.58

*1 Use the included connecting pipe and connect to the refrigerant service valve piping

*2 Furthest piping length (OU from IU)≥40m

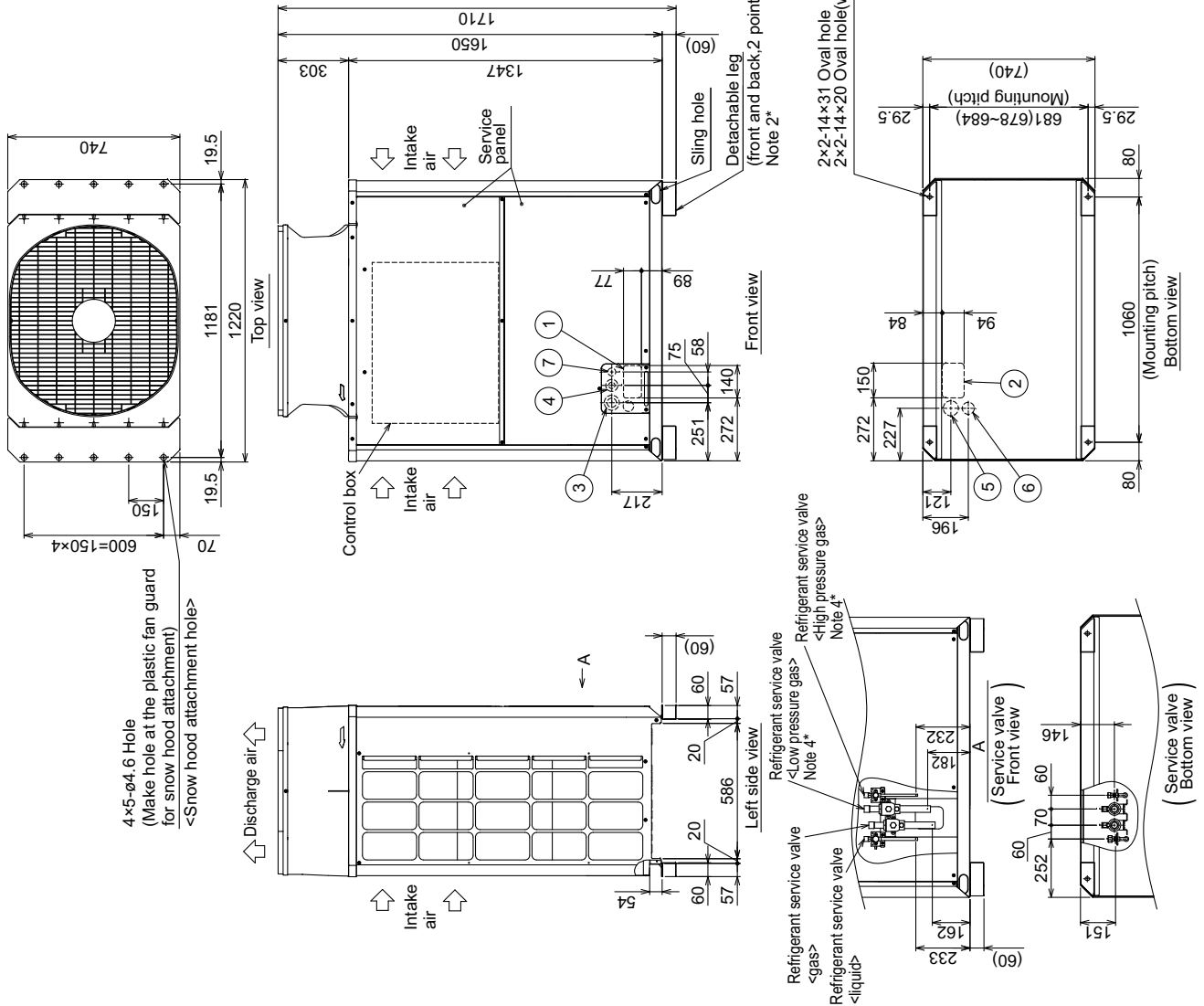

NO.	Usage	Specifications
①	For pipes	Front through hole 140×77 Knockout hole
②		Bottom through hole 150×94 Knockout hole
③	For wires	Front through hole ø65 or ø40 Knockout hole
④		Front through hole ø52 or ø27 Knockout hole
⑤		Bottom through hole ø65 Knockout hole
⑥		Bottom through hole ø52 Knockout hole
⑦	For transmission cables	Front through hole ø34 Knockout hole

PUHY-EP300, 350YLM-A (-BS)

Unit : mm

● In case of collective installation

- ① When multiple units are installed adjacent to each other, secure enough space to allow for air circulation and walkway between groups of units as shown in the figures below.
- ② At least two sides must be left open.
- ③ As with the single installation, add the height that exceeds the height limit <h> to the figures that are marked with an asterisk.
- ④ If there is a wall at both the front and the rear of the unit, install up to six units consecutively in the side direction and provide a space of 1000mm or more as inlet space/ passage space for each six units.

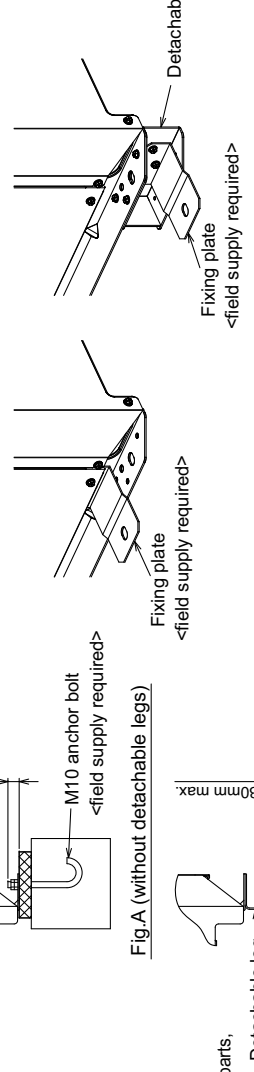
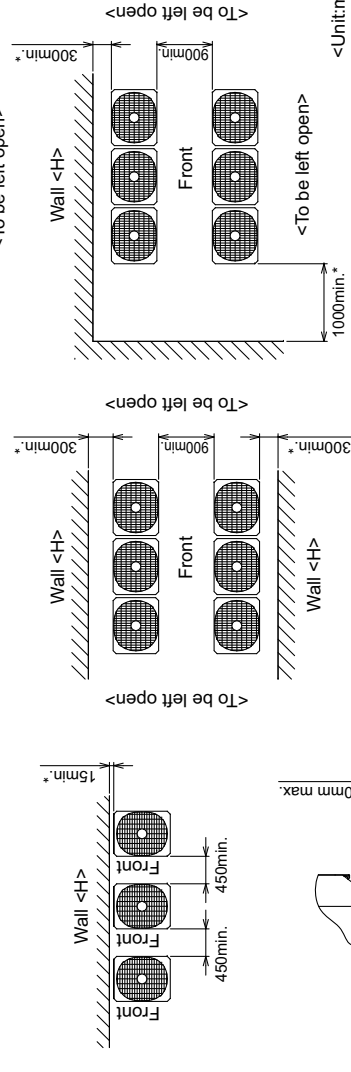
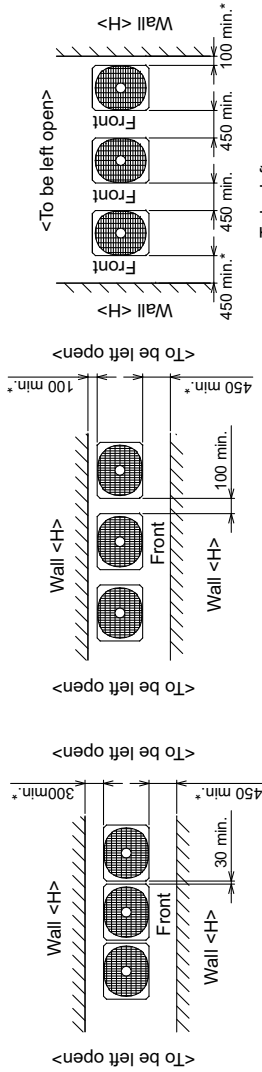

Fig.D (with detachable legs)

Fig.C (without detachable legs)

Fig.B (with detachable legs)

1. Required space around the unit

● In case of single installation

- ① Secure enough space around the unit as shown in the figure below.
 - With a space of at least 100mm to the wall on the back of the unit

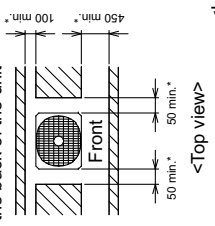

- ② When the height of the walls on the front, back or on the sides <H> exceeds the wall height limit as defined below, add the height that exceeds the height limit <h> to the figures that are marked with an asterisk.

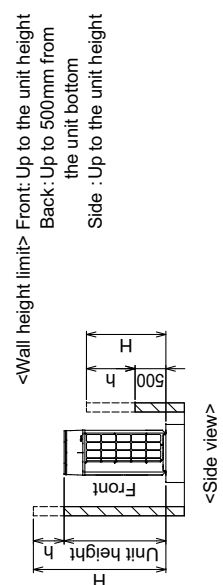

2. Foundation work

- ① Take into consideration the surface strength, water drainage route, piping route, and wiring route when preparing the installation site.
 - <Note that the drain water comes out of the unit during operation.>
- ② Build the foundation in such way that the corner of the installation leg is securely supported as shown in the right figure (Fig.A,B)
 - When using a rubber isolating cushion, please ensure it is large enough to cover the entire width of each of the unit's legs.
- ③ The protrusion length of the anchor bolt must not exceed 30mm. (Fig.A,B)
- ④ Use four fixing plates as shown in the right figure <field supply required> when using post-installed anchor bolts. (Fig.C,D)
- ⑤ To prevent small animals and water and snow from entering the unit and damaging its parts, close the gap around the edges of through holes for pipes and wires with filler plates <field supply required>.
- ⑥ When the pipes or cables are routed at the bottom of the unit, make sure that the through hole at the base of the unit does not get blocked with the installation base.
- ⑦ Refer to the Installation Manual when installing units on an installation base.

PUHY-EP400, 450, 500YLM-A (-BS)

Unit : mm

- <Accessories>
- Connecting pipe
- <Gas>
- Pipe (IDø28.58×ODø28.58) ... EP400,EP450,EP500 1pc.
- Elbow(IDø28.58×IDø28.58) ... EP400,EP450,EP500 1pc.
- <Liquid>
- Pipe (IDø15.88×ODø12.7) ... EP400 1pc.
- Pipe (IDø15.88×IDø15.88) ... EP450,EP500 1pc.

Note1 Please refer to the next page for information regarding necessary spacing around the unit and foundation work.

2.The detachable leg can be removed at site.

3.At brazing of pipes,wrap the refrigerant service valve with wet cloth and keep the temperature of refrigerant service valve under 120°C.

4.Used only when a separately-sold unit is attached. Refer to the Installation Manual of the unit for details.

Connecting pipe specifications

Model	Refrigerant pipe		Service valve	
	Liquid	Gas	Liquid	Gas
PUHY-EP400YLM-A(-BS)	ø12.7 Brazeed *1	ø28.58 Brazeed *1	ø15.88	ø28.58
PUHY-EP450YLM-A(-BS)	ø12.7 Brazeed *1	ø28.58 Brazeed *1	ø15.88	ø28.58
PUHY-EP500YLM-A(-BS)	ø12.7 Brazeed *1	ø28.58 Brazeed *1	ø15.88	ø28.58

*1 Use the included connecting pipe and connect to the refrigerant service valve piping

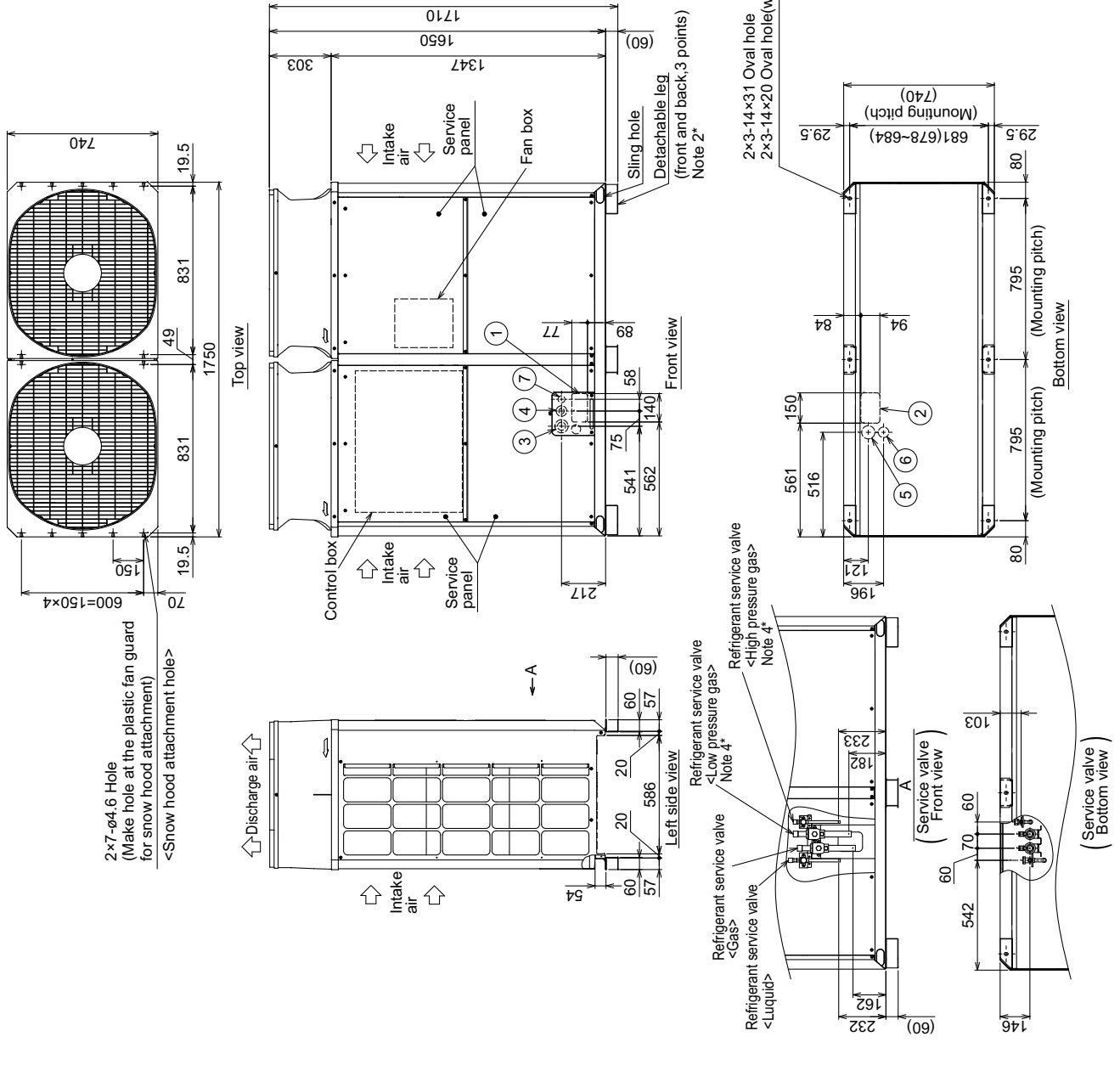

NO.	Usage	Specifications
①	For pipes	Front through hole 140×77 Knockout hole
②		Bottom through hole 150×94 Knockout hole
③	For wires	Front through hole ø65 or ø40 Knockout hole
④		Front through hole ø62 or ø27 Knockout hole
⑤		Bottom through hole ø65 Knockout hole
⑥		Bottom through hole ø52 Knockout hole
⑦	For transmission cables	Front through hole ø34 Knockout hole

PUHY-EP400, 450, 500YLM-A (-BS)

Unit : mm

Y (HIGH COP)

● In case of collective installation

- ① When multiple units are installed adjacent to each other, secure enough space to allow for air circulation and walkway between groups of units as shown in the figures below.
- ② At least two sides must be left open.
- ③ As with the single installation, add the height that exceeds the height limit to the figures that are marked with an asterisk.
- ④ If there is a wall at both the front and the rear of the unit, install up to three units consecutively in the side direction and provide a space of 1000mm or more as inlet space/ passage space for each three units.

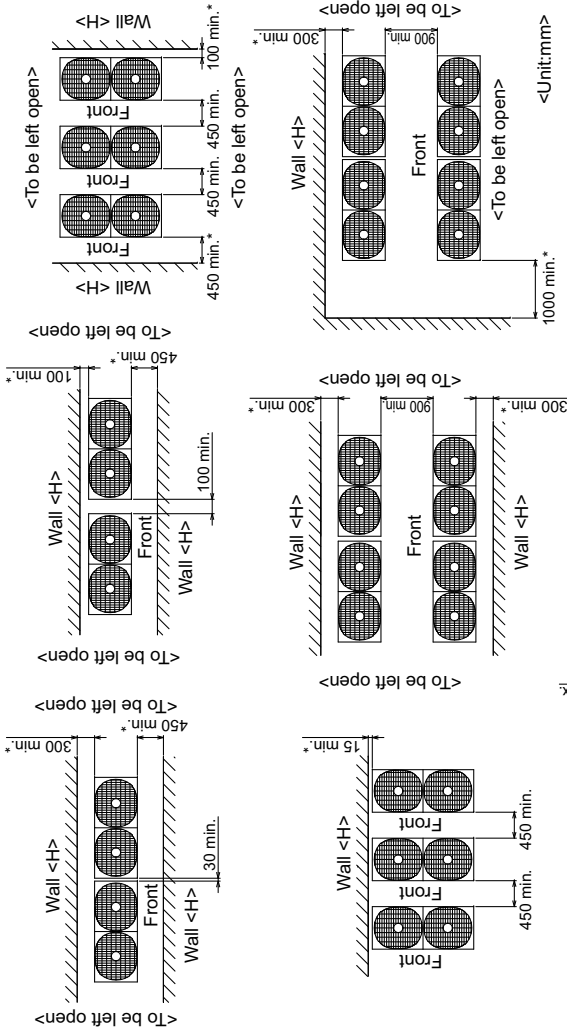

1. Required space around the unit

● In case of single installation

- ① Secure enough space around the unit as shown in the figure below.

· With a space of at least 100mm to the wall on the back of the unit

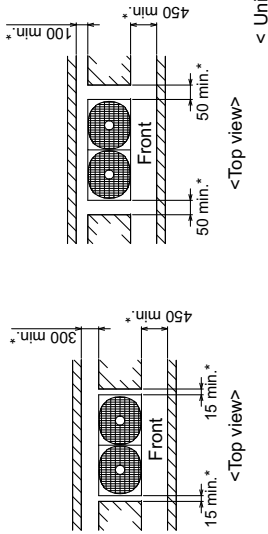

- ② When the height of the walls on the front, back or on the sides <H> exceeds the wall height limit as defined below add the height that exceeds the height limit <h> to the figures that are marked with an asterisk.

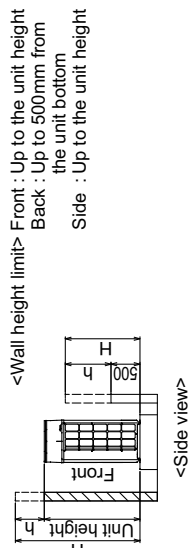

2. Foundation work

- ① Take into consideration the surface strength, water drainage route, piping route, and wiring route when preparing the installation site. <Note that the drain water comes out of the unit during operation.>
- ② Build the foundation in such way that the corner of the installation leg is securely supported as shown in the right figure. (Fig.A,B) When using a rubber isolating cushion, please ensure it is large enough to cover the entire width of each of the unit's legs.
- ③ The protrusion length of the anchor bolt must not exceed 30mm. (Fig.A,B)
- ④ Use four fixing plates as shown in the right figure <field supply required> when using post-installed anchor bolts. (Fig.C,D)
- ⑤ To prevent small animals and water and snow from entering the unit and damaging its parts, close the gap around the edges of through holes for pipes and wires with filler plates <field supply required>.
- ⑥ When the pipes or cables are routed at the bottom of the unit, make sure that the through hole at the base of the unit does not get blocked with the installation base.
- ⑦ Refer to the Installation Manual when installing units on an installation base.

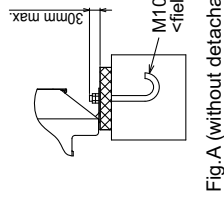

Fig.A (without detachable legs)

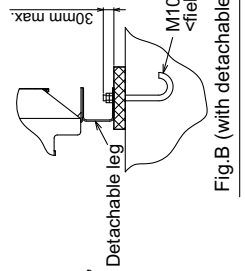

Fig.B (with detachable legs)

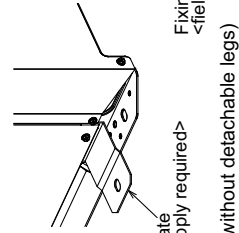

Fig.C (without detachable legs)

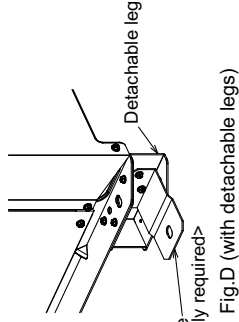
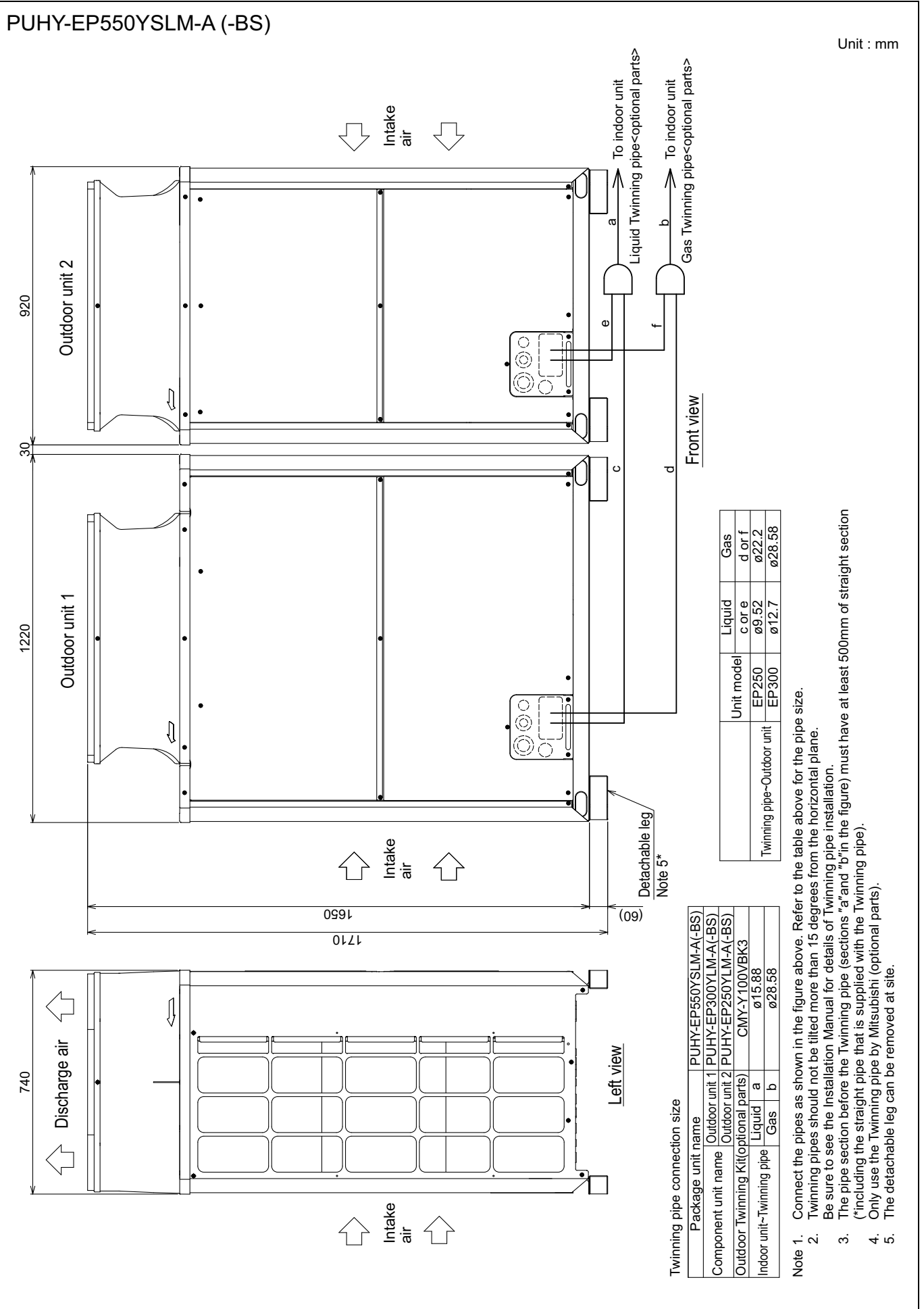

Fig.D (with detachable legs)



Y (HIGH COP)

PUHY-EP600YSLM-A (-BS)

Unit : mm

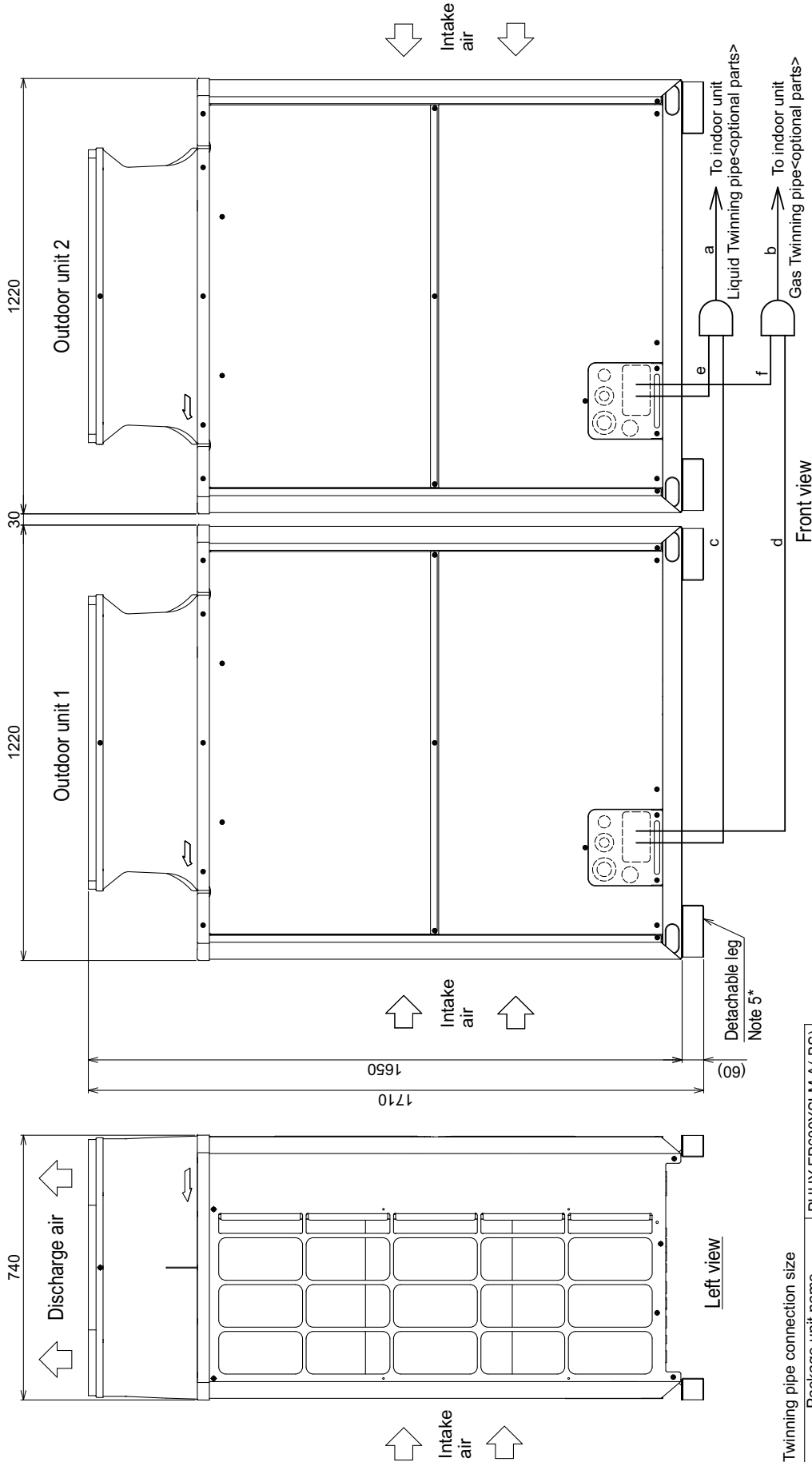

Twinning pipe connection size

Package unit name	PUHY-EP600YSLM-A(-BS)
Component unit name	Outdoor unit 1 PUHY-EP300YLM-A(-BS) Outdoor unit 2 PUHY-EP300YLM-A(-BS)
Outdoor Twinning Kit(optional parts)	CMY-Y100VBK3
Indoor unit-Twinning pipe	Liquid a ø15.88 Gas b ø28.58

Twinning pipe-Outdoor unit	Unit model	Liquid	Gas
	EP300	c or e ø12.7	d or f ø28.58

- Note 1. Connect the pipes as shown in the figure above. Refer to the table above for the pipe size.
 2. Twinning pipes should not be tilted more than 15 degrees from the horizontal plane.
 Be sure to see the Installation Manual for details of Twinning pipe installation.
 3. The pipe section before the Twinning pipe (sections "a" and "b" in the figure) must have at least 500mm of straight section (*including the straight pipe that is supplied with the Twinning pipe).
 4. Only use the Twinning pipe by Mitsubishi (optional parts).
 5. The detachable leg can be removed at site.

PUHY-EP650YSLM-A (-BS)

Unit : mm

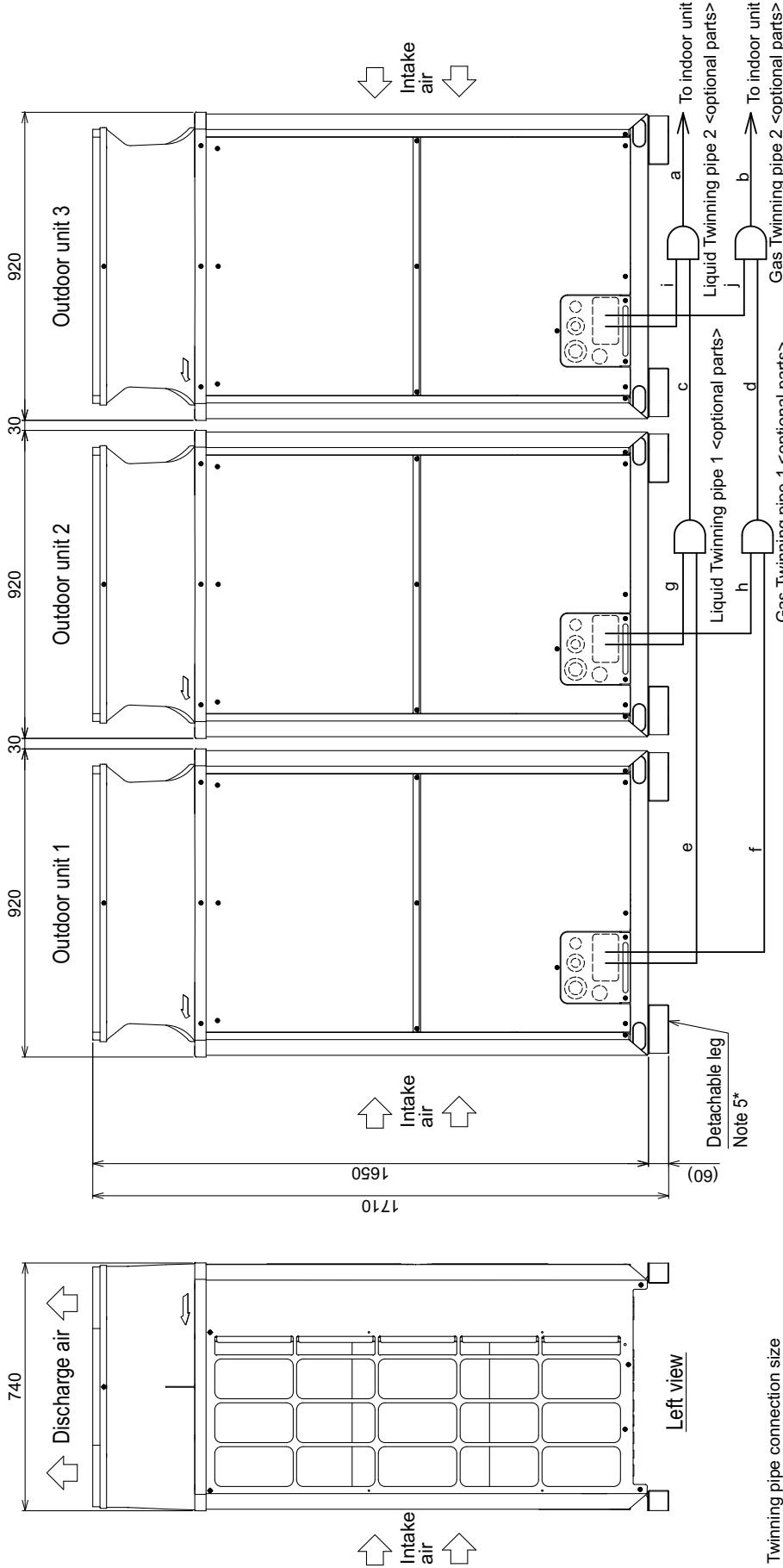

Front view

Package unit name	PUHY-EP650YSLM-A(-BS)	
Outdoor unit 1	PUHY-EP250YLM-A(-BS)	
Outdoor unit 2	PUHY-EP200YLM-A(-BS)	
Outdoor unit 3	PUHY-EP200YLM-A(-BS)	
Outdoor Twinning Kit(optional parts)	CMY-Y300VBK3	
Indoor unit~Twinning pipe 2	Liquid a	ø15.88
	Gas b	ø28.58
Twinning pipe 1~Twinning pipe 2	Liquid c	ø19.05
	Gas d	ø34.93

Unit model	Liquid e or g or i	Gas f or h or j
EP200	ø9.52	ø22.2
EP250	ø9.52	ø22.2

Twinning pipe connection size

- Note 1. Connect the pipes as shown in the figure above. Refer to the table above for the pipe size.
 2. Twinning pipes should not be tilted more than 15 degrees from the horizontal plane.
 Be sure to see the Installation Manual for details of Twinning pipe installation.
 3. The pipe section before the Twinning pipe (sections "a", "b", "c" and "d" in the figure) must have at least 500mm of straight section (*including the straight pipe that is supplied with the Twinning pipe).
 4. Only use the Twinning pipe by Mitsubishi (optional parts).
 5. The detachable leg can be removed at site.

PUHY-EP700, 750YSLM-A (-BS)

Unit : mm

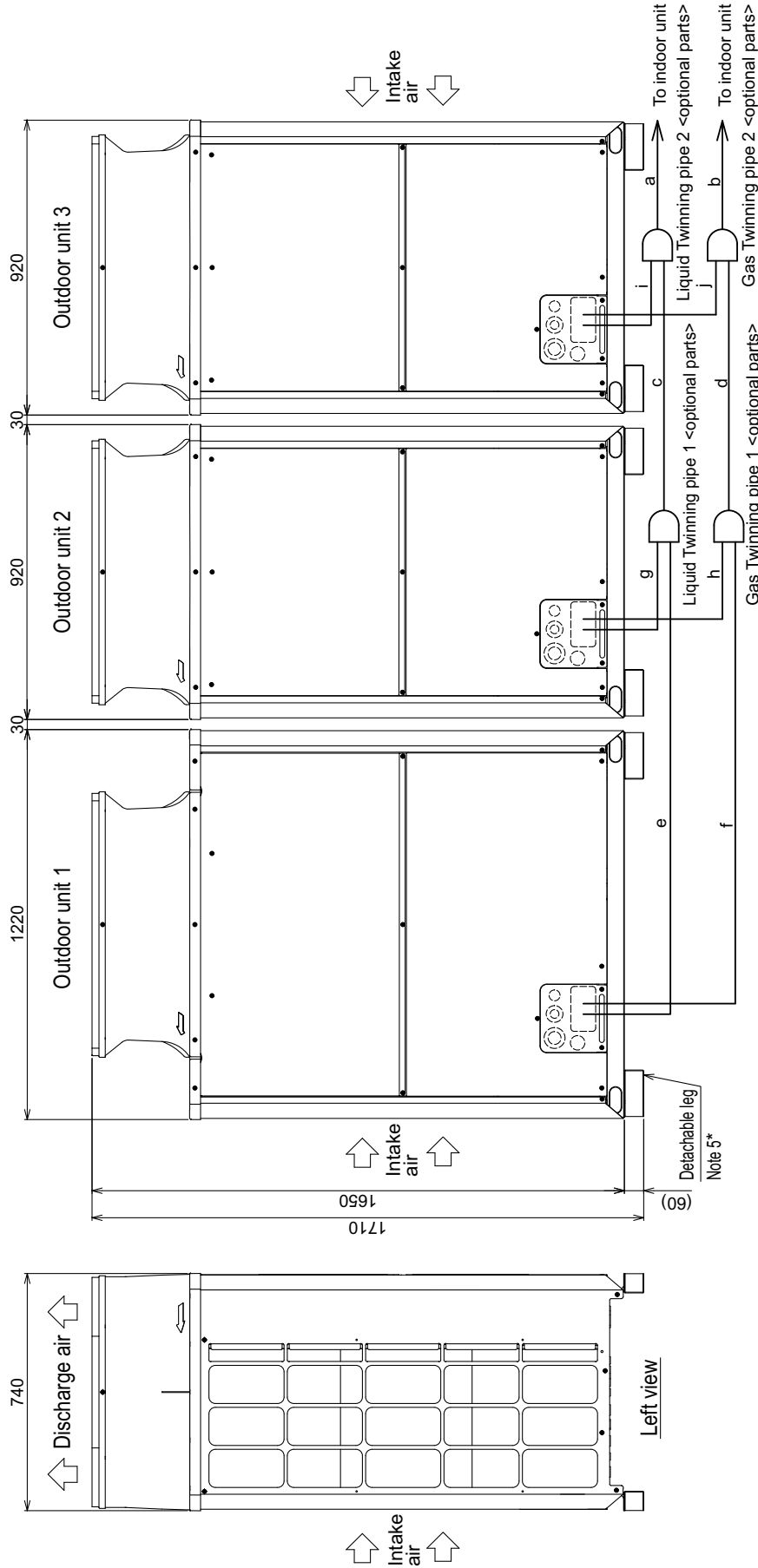

Twinning pipe connection size

Package unit name	PUHY-EP700YSLM-A(-BS)	PUHY-EP750YSLM-A(-BS)
Outdoor unit 1	PUHY-EP300YLM-A(-BS)	PUHY-EP300YLM-A(-BS)
Outdoor unit 2	PUHY-EP200YLM-A(-BS)	PUHY-EP250YLM-A(-BS)
Outdoor unit 3	PUHY-EP200YLM-A(-BS)	PUHY-EP200YLM-A(-BS)
Outdoor Twinning Kit(optional parts)	CMY-Y300VBK3	
Indoor unit~Twinning pipe 2	Liquid	a
	Gas	b
Twinning pipe 1~Twinning pipe 2	Liquid	c
	Gas	d

Unit model	Liquid	Gas
EP200	e or g or i ø9.52	f or h or j ø22.2
EP250	ø9.52	ø22.2
EP300	ø12.7	ø28.58

Front view

- Note 1. Connect the pipes as shown in the figure above. Refer to the table above for the pipe size.
 2. Twinning pipes should not be tilted more than 15 degrees from the horizontal plane.
 3. Be sure to see the Installation Manual for details of Twinning pipe installation.
 4. The pipe section before the Twinning pipe (sections "a", "b", "c" and "d" in the figure) must have at least 500mm of straight section (*including the straight pipe that is supplied with the Twinning pipe).
 5. Only use the Twinning pipe by Mitsubishi (optional parts).
 6. The detachable leg can be removed at site.

PUHY-EP800, 850YSLM-A (-BS)

Unit : mm

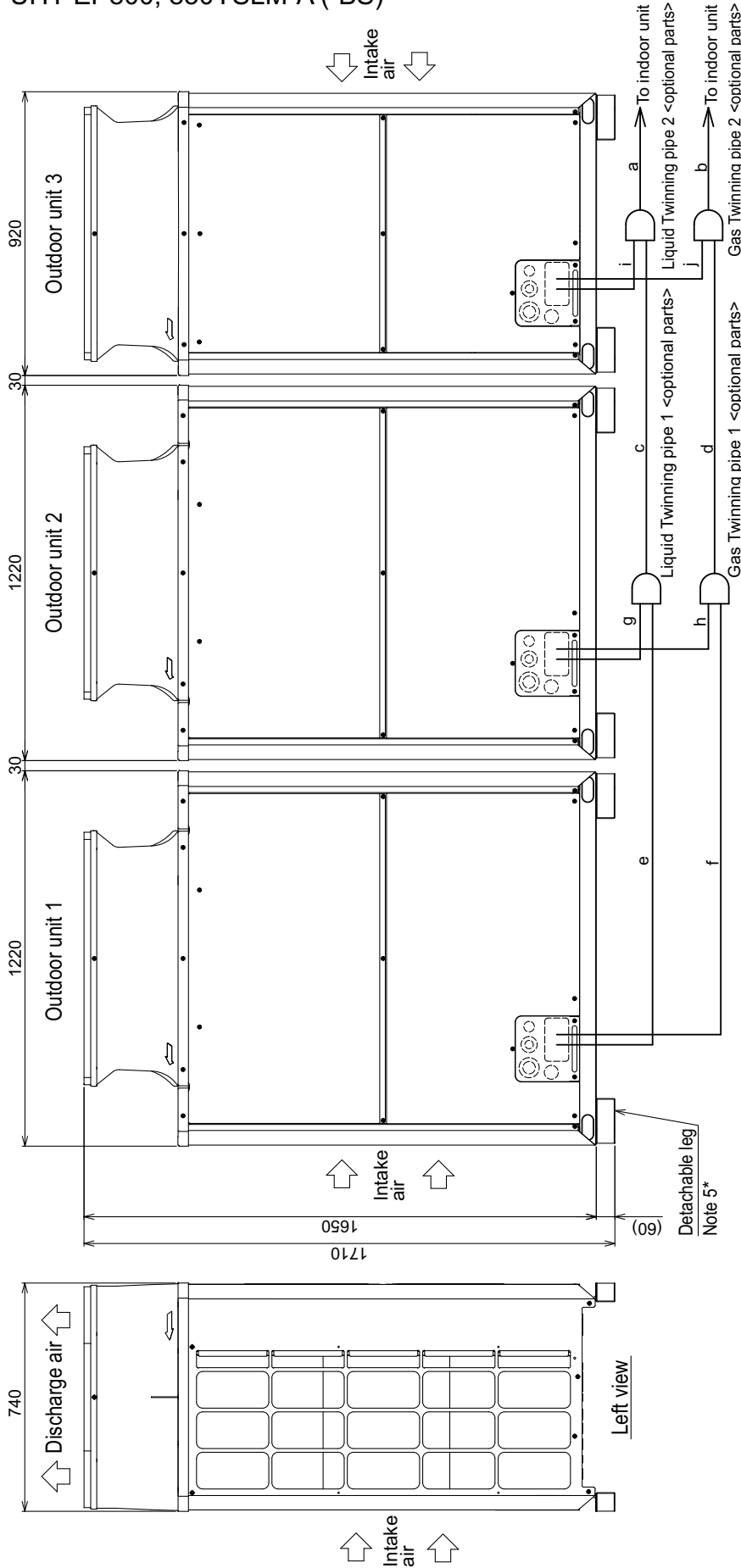

Front view

Twinning pipe connection size

Package unit name	PUHY-EP800YSLM-A(-BS)	PUHY-EP850YSLM-A(-BS)
Outdoor unit 1	PUHY-EP300YLM-A(-BS)	PUHY-EP300YLM-A(-BS)
Outdoor unit 2	PUHY-EP300YLM-A(-BS)	PUHY-EP300YLM-A(-BS)
Outdoor unit 3	PUHY-EP200YLM-A(-BS)	PUHY-EP250YLM-A(-BS)
Outdoor Twinning Kit(optional parts)	CMY-Y300VBK3	CMY-Y300VBK3
Indoor unit~Twinning pipe 2	Liquid a	ø19.05
	Gas b	ø34.93
Twinning pipe 1~Twinning pipe 2	Liquid c	ø19.05
	Gas d	ø34.93

Unit model	Liquid	Gas
EP200	e or g or i ø9.52	f or h or j ø22.2
EP250	ø9.52	ø22.2
EP300	ø12.7	ø28.58

- Note 1. Connect the pipes as shown in the figure above. Refer to the table above for the pipe size.
 2. Twinning pipes should not be tilted more than 15 degrees from the horizontal plane.
 Be sure to see the Installation Manual for details of Twinning pipe installation.
 3. The pipe section before the Twinning pipe (sections "a", "b", "c" and "d" in the figure) must have at least 500mm of straight section.
 (*Including the straight pipe that is supplied with the Twinning pipe).
 4. Only use the Twinning pipe by Mitsubishi (optional parts).
 5. The detachable leg can be removed at site.

2. EXTERNAL DIMENSIONS

YKB/YLM

Y (HIGH COP)

PUHY-EP900, 950YSLM-A (-BS)

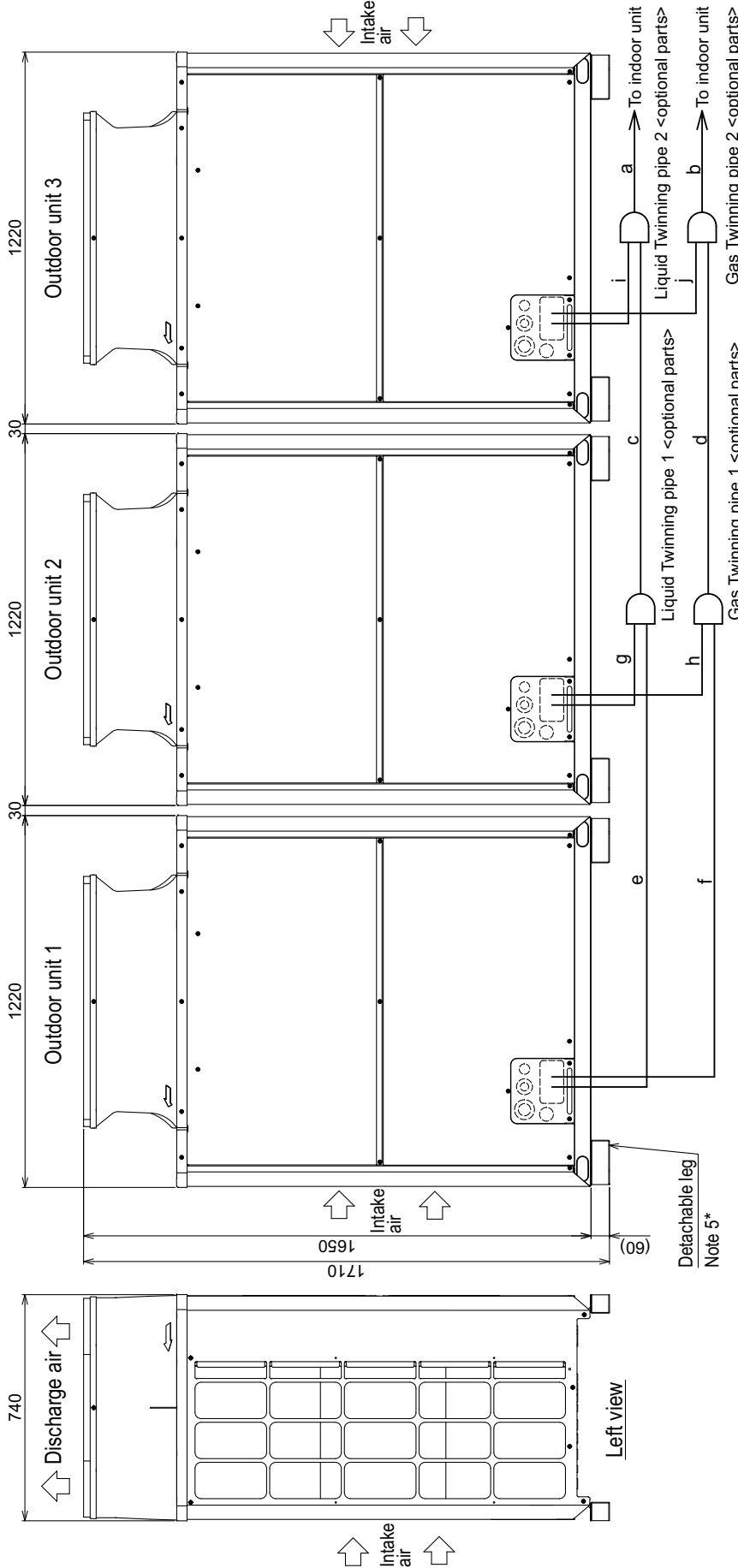

Front view

Left view

Twinning pipe connection size

Package unit name	PUHY-EP900YSLM-A(-BS)	PUHY-EP950YSLM-A(-BS)
Outdoor unit 1	PUHY-EP300YLM-A(-BS)	PUHY-EP350YLM-A(-BS)
Outdoor unit 2	PUHY-EP300YLM-A(-BS)	PUHY-EP300YLM-A(-BS)
Outdoor unit 3	PUHY-EP300YLM-A(-BS)	PUHY-EP300YLM-A(-BS)
Outdoor Twinning Kit(optional parts)	CMY-Y300VBK3	
Indoor unit~Twinning pipe 2	Liquid	ø19.05
	Gas	ø41.28
Twinning pipe 1~Twinning pipe 2	Liquid	ø19.05
	Gas	ø34.93

Twinning pipe-Outdoor unit	Unit model	Liquid e or g or i	Gas f or h or j
	EP300	ø12.7	ø28.58
	EP350	ø12.7	ø28.58

- Note 1. Connect the pipes as shown in the figure above. Refer to the table above for the pipe size.
 2. Twinning pipes should not be tilted more than 15 degrees from the horizontal plane.
 3. Be sure to see the Installation Manual for details of Twinning pipe installation.
 4. The pipe section before the Twinning pipe (sections "a", "b", "c" and "d" in the figure) must have at least 500mm of straight section (*including the straight pipe that is supplied with the Twinning pipe).
 5. Only use the Twinning pipe by Mitsubishi (optional parts).
 6. The detachable leg can be removed at site.

Unit : mm

PUHY-EP1000, 1050, 1100, 1150YSLM-A (-BS)

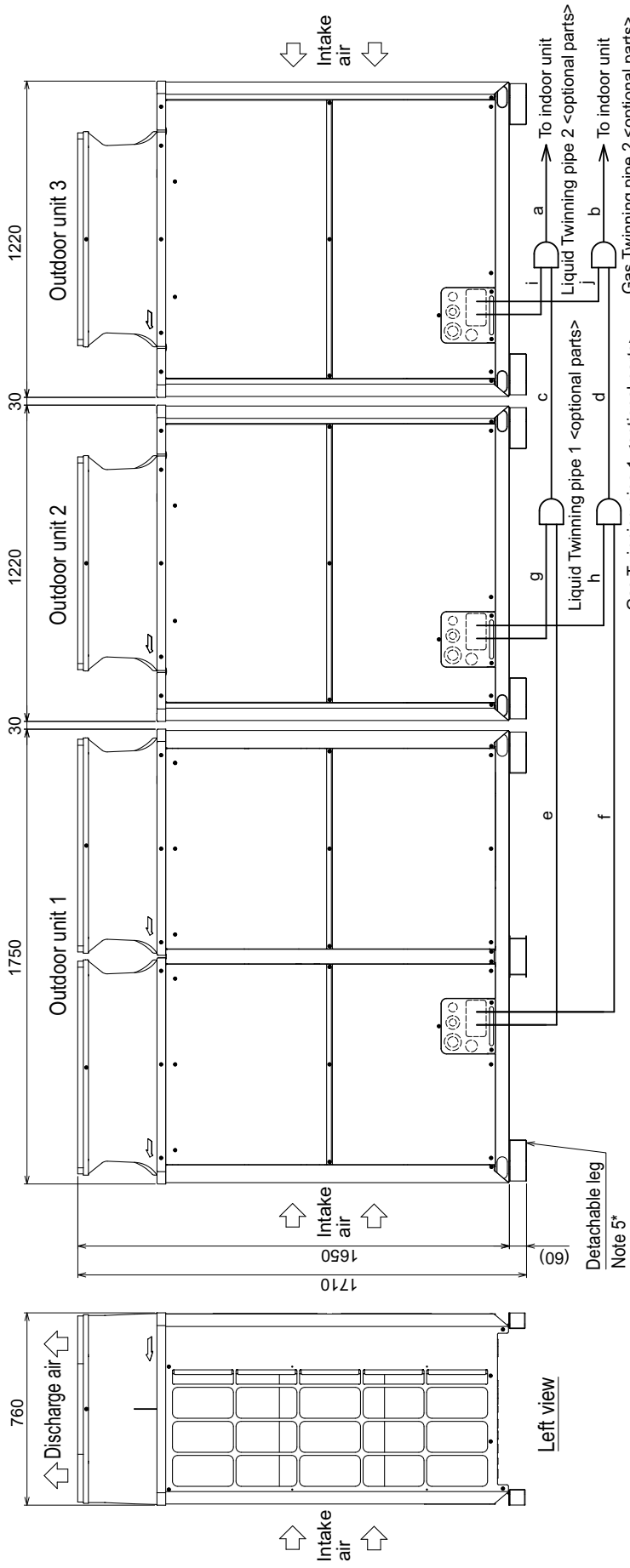

Front view

Twinning pipe connection size

Package unit name	PUHY-EP1000YSLM-A(-BS)	PUHY-EP1050YSLM-A(-BS)	PUHY-EP1100YSLM-A(-BS)	PUHY-EP1150YSLM-A(-BS)
Outdoor unit 1	PUHY-EP400YLM-A(-BS)	PUHY-EP400YLM-A(-BS)	PUHY-EP400YLM-A(-BS)	PUHY-EP450YLM-A(-BS)
Outdoor unit 2	PUHY-EP300YLM-A(-BS)	PUHY-EP350YLM-A(-BS)	PUHY-EP350YLM-A(-BS)	PUHY-EP350YLM-A(-BS)
Outdoor unit 3	PUHY-EP300YLM-A(-BS)	PUHY-EP300YLM-A(-BS)	PUHY-EP350YLM-A(-BS)	PUHY-EP350YLM-A(-BS)
Outdoor Twinning Kit(optional parts)	CMY-Y300VBK3			
Indoor unit~ Twinning pipe 2	Liquid	a	ø19.05	
	Gas	b	ø41.28	
Twinning pipe 1~Twinning pipe 2	Liquid	c	ø19.05	
	Gas	d	ø34.93	

Unit model	Liquid e or g or i	Gas f or h or j
EP300	ø12.7	ø28.58
EP350	ø12.7	ø28.58
EP400	ø15.88	ø28.58
EP450	ø15.88	ø28.58

Twinning pipe~Outdoor unit

- Note 1. Connect the pipes as shown in the figure above. Refer to the table above for the pipe size.
 2. Twinning pipes should not be tilted more than 15 degrees from the horizontal plane. Be sure to see the Installation Manual for details of twinning pipe installation.
 3. The pipe section before the twinning pipe (sections "a", "b", "c" and "d" in the figure) must have at least 500mm of straight section ("including the straight pipe that is supplied with the twinning pipe).
 4. Only use the twinning pipe by Mitsubishi (optional parts).
 5. The detachable leg can be removed at site.

Unit : mm

Y (HIGH COP)

PUHY-EP1200, 1250YSLM-A (-BS)

Unit : mm

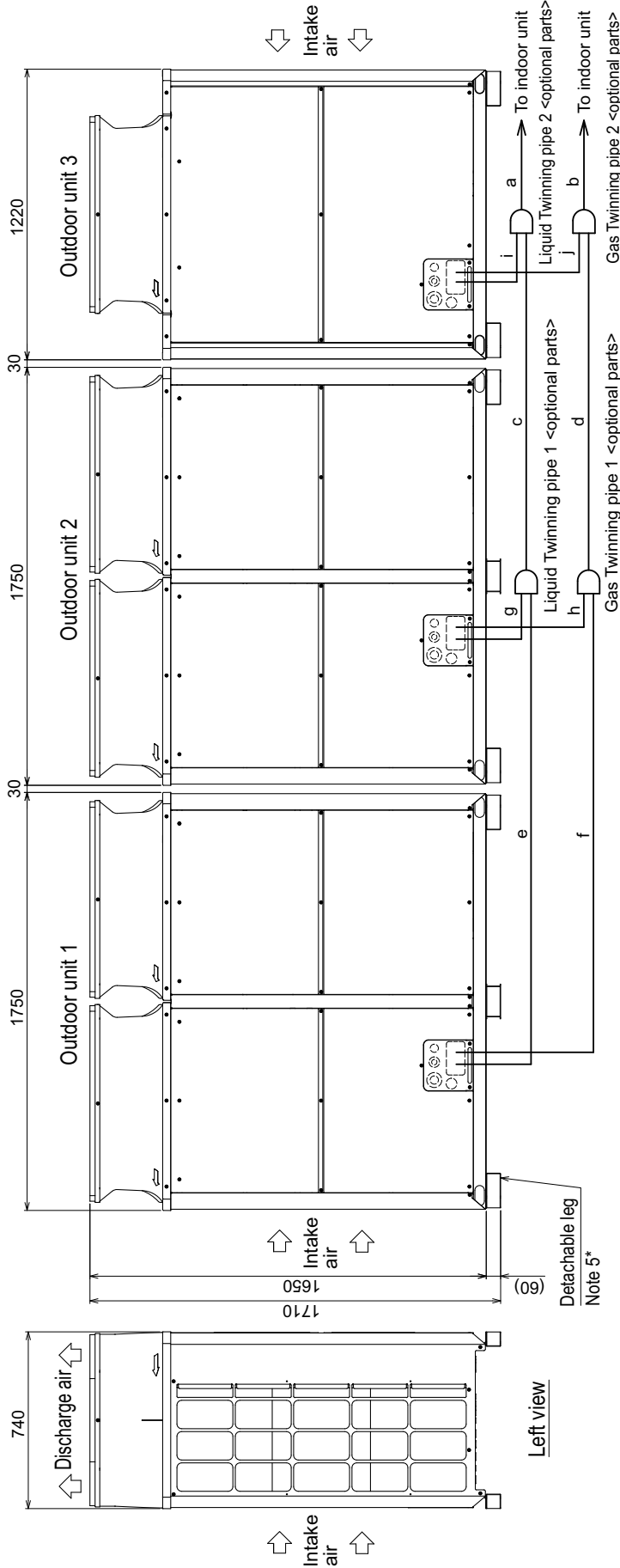

Front view

Left view

Twinning pipe connection size

Package unit name	PUHY-EP1200YSLM-A(-BS)	PUHY-EP1250YSLM-A(-BS)
Outdoor unit 1	PUHY-EP450YLM-A(-BS)	PUHY-EP450YLM-A(-BS)
Outdoor unit 2	PUHY-EP400YLM-A(-BS)	PUHY-EP450YLM-A(-BS)
Outdoor unit 3	PUHY-EP350YLM-A(-BS)	PUHY-EP350YLM-A(-BS)
Outdoor Twinning Kit(optional parts)	CMY-Y300VBK3	
Indoor unit~Twinning pipe 2	Liquid a	ø19.05
	Gas b	ø41.28
Twinning pipe 1~Twinning pipe 2	Liquid c	ø19.05
	Gas d	ø34.93

Unit model	Liquid e or g or i	Gas f or h or j
EP350	ø12.7	ø28.58
EP400	ø15.88	ø28.58
EP450	ø15.88	ø28.58

- Note 1. Connect the pipes as shown in the figure above. Refer to the table above for the pipe size.
 2. Twinning pipes should not be tilted more than 15 degrees from the horizontal plane.
 Be sure to see the Installation Manual for details of Twinning pipe installation.
 3. The pipe section before the Twinning pipe (sections "a", "b", "c" and "d" in the figure) must have at least 500mm of straight section (*including the straight pipe that is supplied with the Twinning pipe).
 4. Only use the Twinning pipe by Mitsubishi (optional parts).
 5. The detachable leg can be removed at site.

PUHY-EP1300, 1350YSLM-A (-BS)

Unit : mm

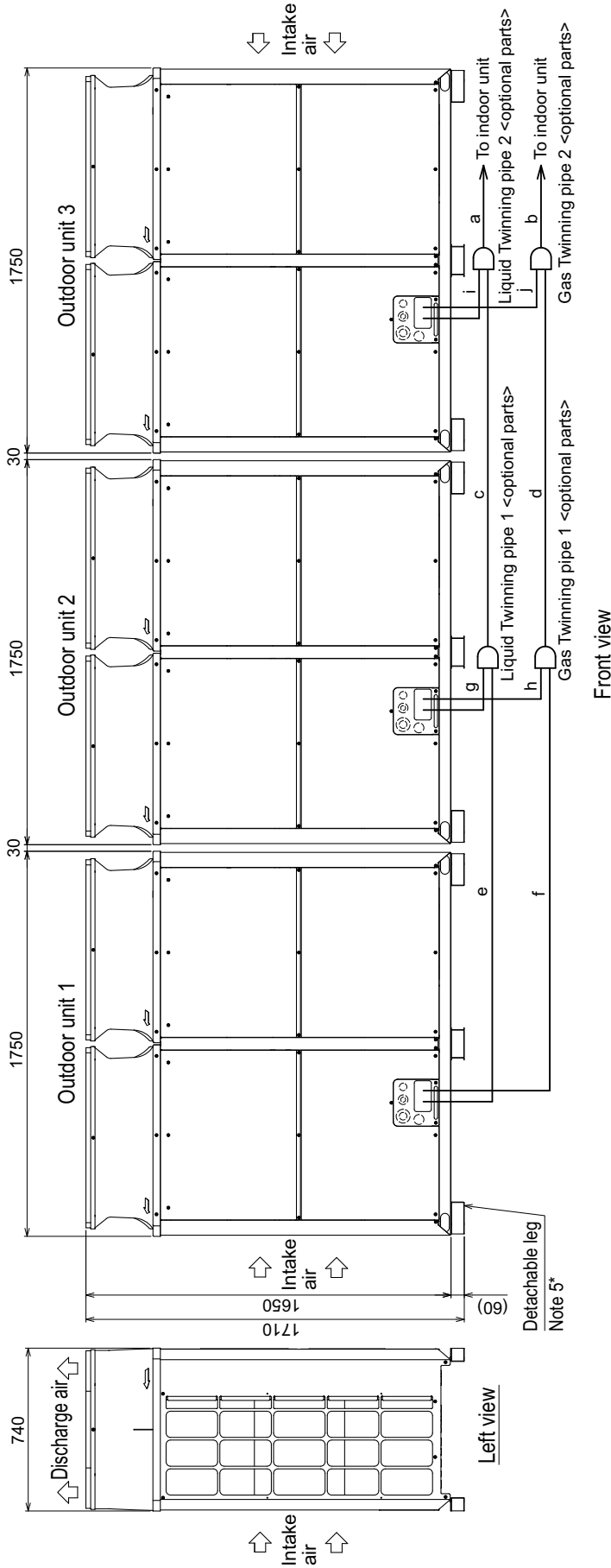

Twinning pipe connection size

Package unit name	PUHY-EP1300YSLM-A(-BS)	PUHY-EP1350YSLM-A(-BS)
Outdoor unit 1	PUHY-EP450YLM-A(-BS)	PUHY-EP450YLM-A(-BS)
Outdoor unit 2	PUHY-EP450YLM-A(-BS)	PUHY-EP450YLM-A(-BS)
Outdoor unit 3	PUHY-EP400YLM-A(-BS)	PUHY-EP450YLM-A(-BS)
Outdoor Twinning Kit(optional parts)	CMY-Y300VBK3	
Indoor unit~Twinning pipe 2	Liquid a	ø19.05
	Gas b	ø41.28
Twinning pipe 1~Twinning pipe 2	Liquid c	ø19.05
	Gas d	ø34.93

- Note 1. Connect the pipes as shown in the figure above. Refer to the table above for the pipe size.
- 2. Twinning pipes should not be tilted more than 15 degrees from the horizontal plane. Be sure to see the Installation Manual for details of Twinning pipe installation.
- 3. The pipe section before the Twinning pipe (sections "a", "b", "c" and "d" in the figure) must have at least 500mm of straight section (*including the straight pipe that is supplied with the Twinning pipe).
- 4. Only use the Twinning pipe by Mitsubishi (optional parts).
- 5. The detachable leg can be removed at site.

Unit model	Liquid e or g or i	Gas f or h or j
EP400	ø15.88	ø28.58
EP450	ø15.88	ø28.58

Y (HIGH COP)

PUHY-EP200, 250YLM-A (-BS)

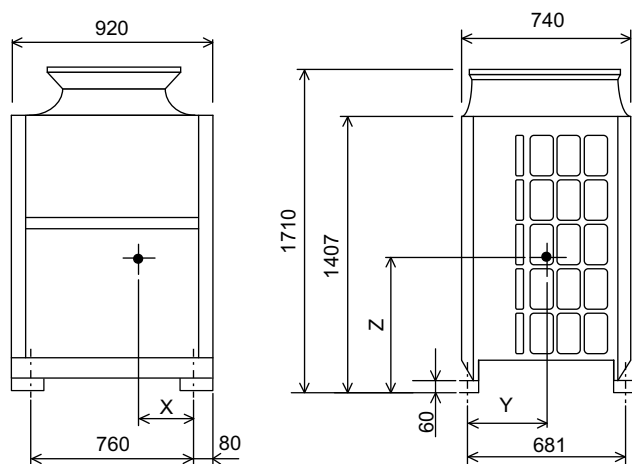

Unit : mm

Model	X	Y	Z
PUHY-EP200YLM-A(-BS)	346	311	704
PUHY-EP250YLM-A(-BS)	346	311	704

PUHY-EP300, 350YLM-A (-BS)

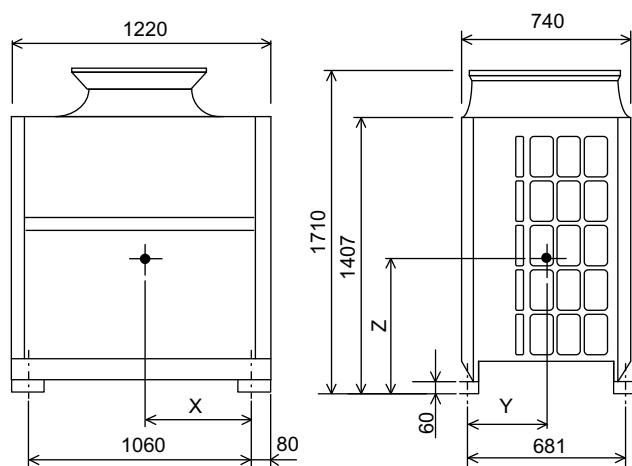

Unit : mm

Model	X	Y	Z
PUHY-EP300YLM-A(-BS)	457	316	669
PUHY-EP350YLM-A(-BS)	457	316	669

PUHY-EP400, 450, 500YLM-A (-BS)

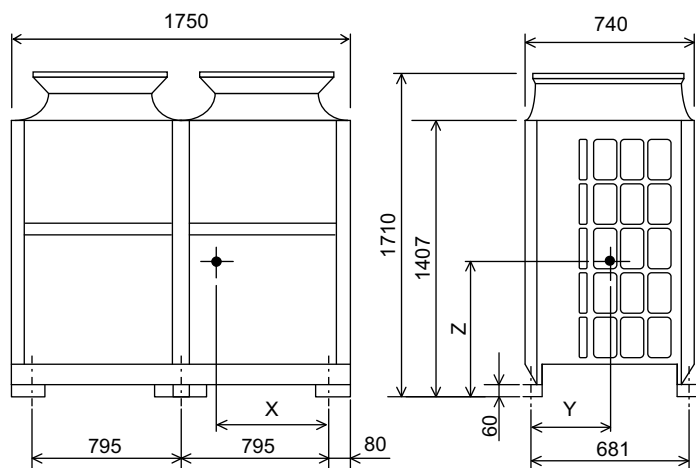

Unit : mm

Model	X	Y	Z
PUHY-EP400YLM-A(-BS)	707	328	721
PUHY-EP450YLM-A(-BS)	707	328	721
PUHY-EP500YLM-A(-BS)	721	325	753

PUHY-EP200, 250, 300, 350YLM-A (-BS)

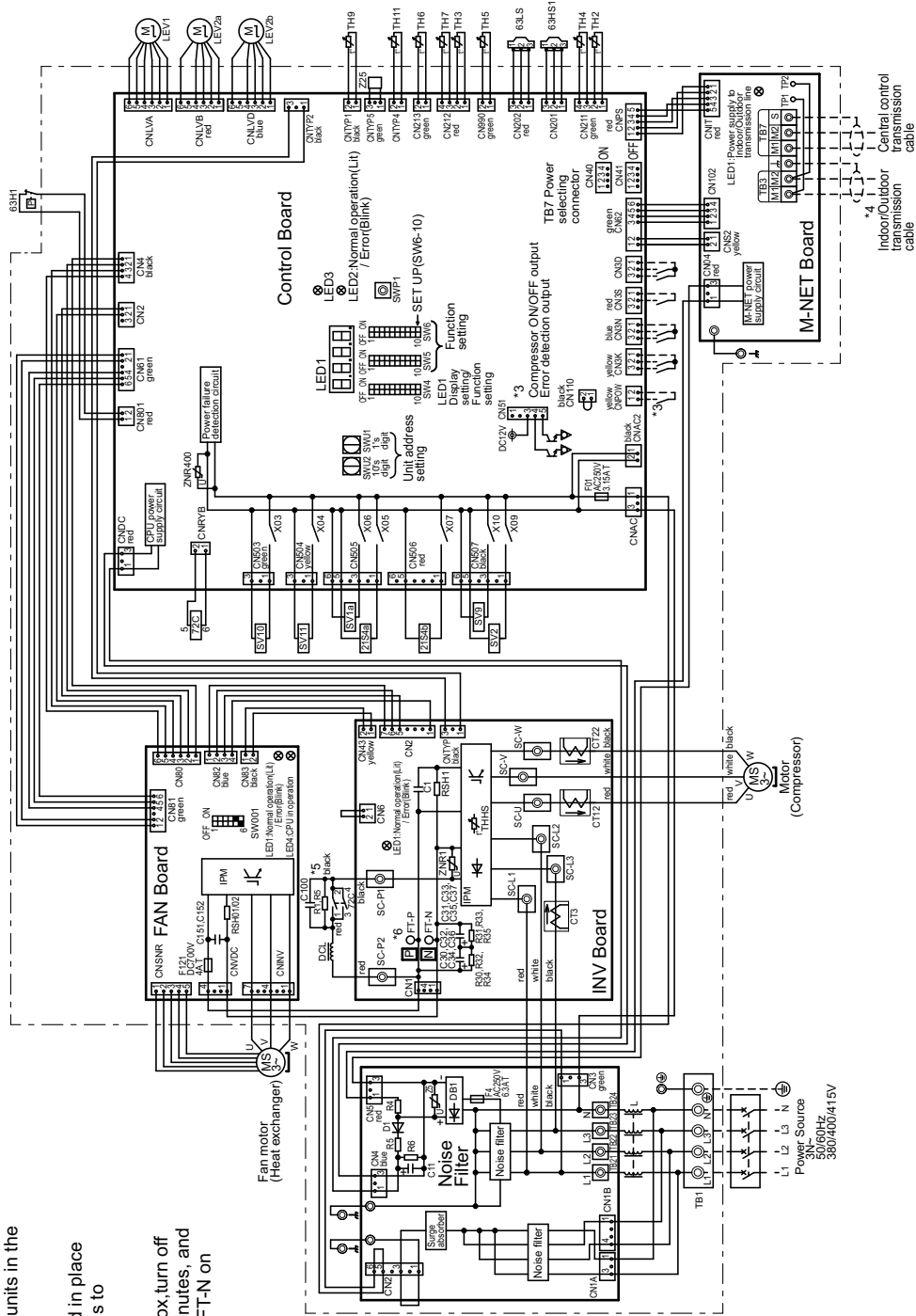

- *1. Single-dotted lines indicate wiring not supplied with the unit.
- *2. Dot-dash lines indicate the control box boundaries.
- *3. Refer to the Data book for connecting input/output signal connectors.
- *4. Daisy-chain terminals (TB3) on the outdoor units in the same refrigerant system together.
- *5. Faston terminals have a locking function. Make sure the terminals are securely locked in place after insertion. Press the tab on the terminals to removed them.
- *6. Control box houses high-voltage parts. Before inspecting the inside of the control box, turn off the power, keep the unit off for at least 10 minutes, and confirm that the voltage between FT-P and FT-N on INV Board has dropped to DC20V or less.

<Symbol explanation>

Symbol	Explanation
Z1S4a	4-way valve
Z1S4b	Cooling/Heating switching
63HT	Heat exchanger capacity control
63HS1	Pressure switch
63LS	High pressure protection for the fan
ZC	Discharge pressure
C30-C37	Low pressure
C12, C22, C23	Magnetic relay (inverter, main circuit)
DCL	Capacitor (inverter, main circuit)
L	DC reactor
LEV1	Choke coil (for high frequency noise reduction)
LEV2a, b	Linear expansion valve
R1.5	HIC bypass; Controls refrigerant flow in HIC circuit.
RS101/02/RS11	Pressure control/Refrigerant flow rate sensor
SV1a	Resistor
SV2	For brush current prevention
SV9	Solenoid valve
SV10, SV11	For opening/closing the bypass circuit
TB1	For opening/closing the bypass circuit
TB3	Terminal block
TB7	Indoor/Outdoor transmission cable
TH2	Central control transmission cable temperature
TH3	Sub-cool bypass outlet temperature
TH4	Pipe temperature
TH5	Discharge pipe temperature
TH6	ACC inlet pipe temperature
TH7	Sub-cooled liquid refrigerant temperature
TH9, TH11	OA temperature
THHS	Heat exchanger outlet pipe temperature
Z25	IPM temperature
	Function setting connector

PUHY-EP400, 450YLM-A (-BS)

Y (HIGH COP)

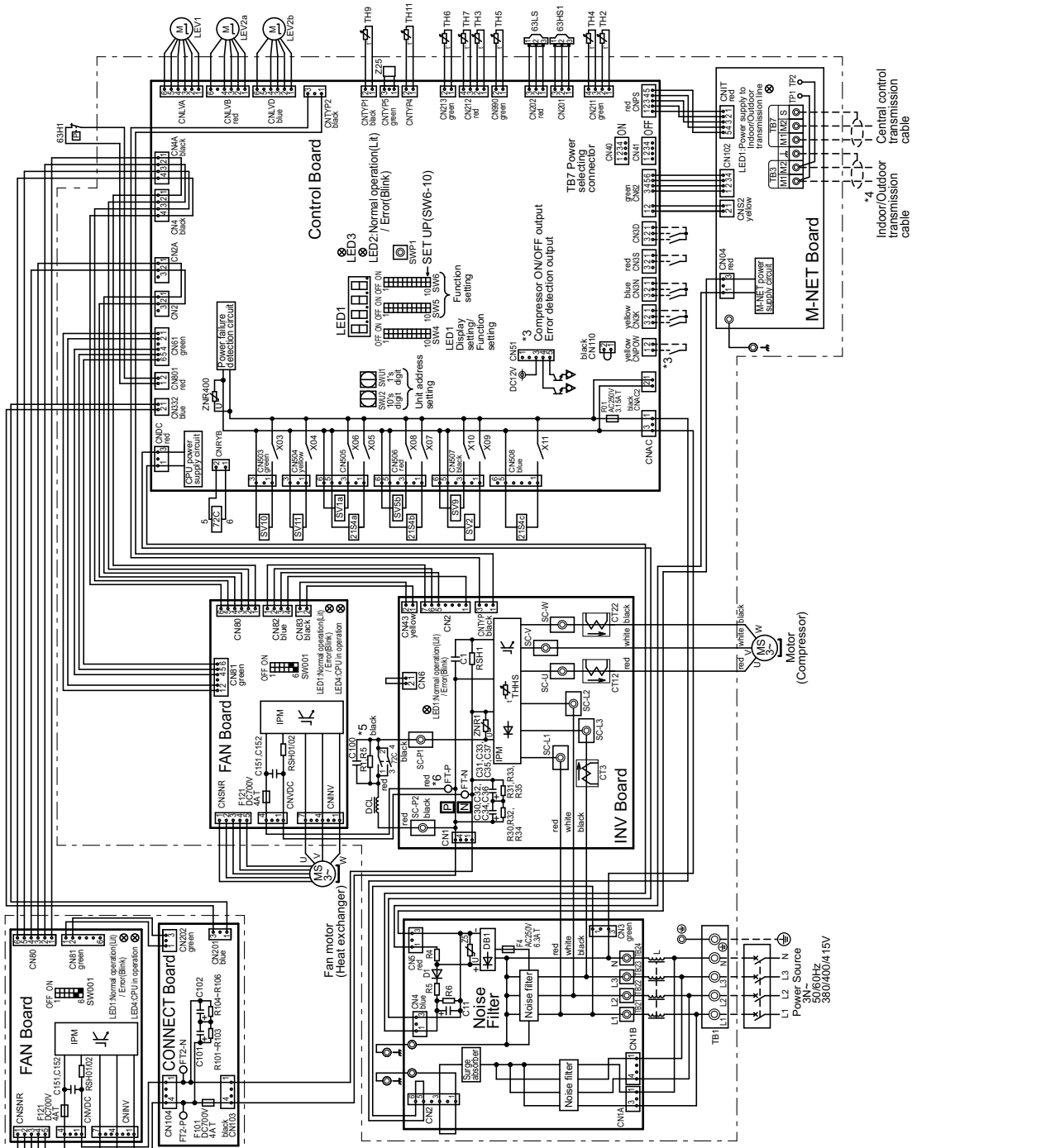

- *1. Single-dotted lines indicate wiring not supplied with the unit.
- *2. Dot-dash lines indicate the control box boundaries.
- *3. Refer to the Data book for connecting input/output signal connectors.
- *4. Daisy-chain terminals (TB3) on the outdoor units in the same refrigerant system together.
- *5. Faston terminals have a locking function.
- *6. Control box houses high-voltage parts. Before inspecting the inside of the control box, turn off the power, keep the unit off for at least 10 minutes, and confirm that the voltage between FT-P and FT-N on INV Board has dropped to DC20V or less.

<Symbol explanation>

Symbol	Explanation
21SA/a	4-way valve
21SA/b,c	Cooling/Heating switching
63H1	Heat exchanger capacity control outdoor unit
63HS1	High pressure protection for the outdoor unit
63LS	Pressure
Z3P-C37	Discharge pressure
CT17,CT2,CT13	Low pressure
DCL	Magnetic relay (inverter main circuit) current sensor (AC)
L	DC reactor
LEV1	Check coil (for high frequency noise reduction)
LEV2a,b	Linear expansion valve
RT1.5	HIC bypass Controls refrigerant flow in HIC circuit
RS101/2/RS11	Pressure control/Refrigerant flow rate control
SV1/a	For inrush current prevention
SV2	For current detection
SV5/b	For opening/closing the bypass circuit under the O/S
SV9	For opening/closing the discharge circuit bypass
SV10,SV11	For opening/closing the discharge circuit capacity control
TB1	Heat exchanger capacity control
TB3	For opening/closing the defrost circuit
TB7	Power supply
TH1	Indoor/Outdoor transmission cable
TH2	Central control transmission cable
TH3	Subcool bypass outlet temperature
TH4	Pipe temperature
TH5	Discharge pipe temperature
TH6	ACC inlet pipe temperature
TH7	Subcooled liquid refrigerant temperature
TH9,TH11	OA temperature
THHS	Heat exchanger outlet pipe temperature
Z25	IPM temperature
	Function setting connector

PUHY-EP500YLM-A (-BS)

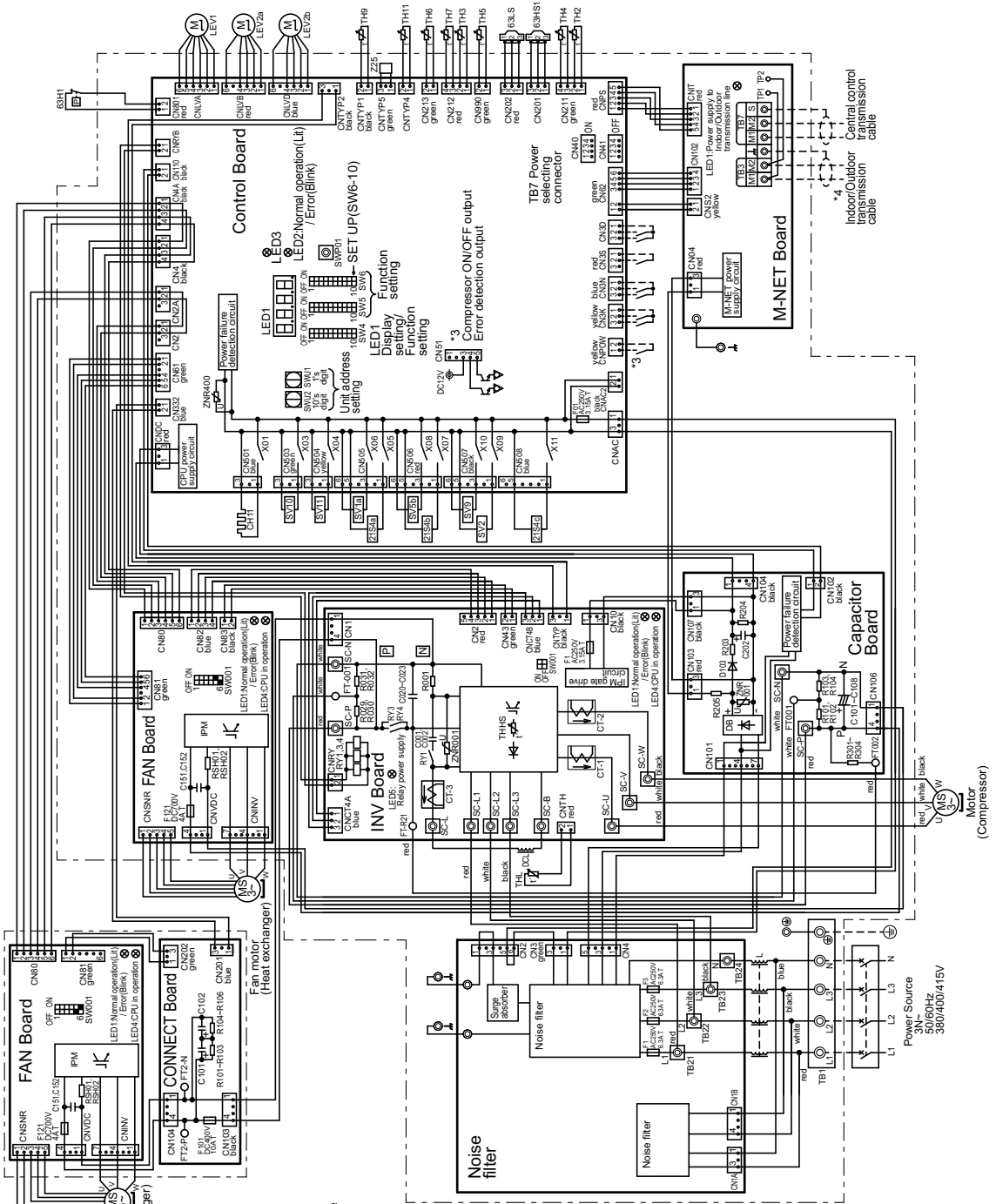

- *1. Single-dotted lines indicate wiring not supplied with the unit.
- *2. Dot-dash lines indicate the control box boundaries.
- *3. Refer to the Data book for connecting input/output signal connectors.
- *4. Daisy-chain terminals (TB3) on the outdoor units in the same refrigerant system together.
- *5. Faston terminals have a locking function. Make sure the terminals are securely locked in place after insertion. Press the tab on the terminals to removed them.
- *6. Control box houses high-voltage parts. Before inspecting the inside of the control box, turn off the power, keep the unit off for at least 10 minutes, and confirm that the voltage between SC-P and SC-N on Capacitor Board has dropped to DC20V or less.

<Symbol explanation>

Symbol	Explanation
2T5Aa	4-way valve
2T5Ab.c	Cooling/Heating switching
63H	Heat exchanger capacity control
63H1	Pressure switch
63HS1	High pressure protection for the outdoor unit
63LS	Discharge pressure
RY1	Low pressure
RV3-RV4	Filter circuit
C01-C108	Inverter main circuit
CH1	Capacitor
DCL	Inverter main circuit
LEV1	DC
R30T-R304	DC
RS40T-RS402	Crankcase heater (for heating the compressor)
SV1a	Choke coil (for high frequency noise reduction)
SV2	Linear expansion valve
SV5b	HIC bypass Controls refrigerant flow in HIC circuit
SV9	Pressure control, Refrigerant flow rate control
SV10, SV11	For inrush current prevention
TB1	For current detection
TB3	For opening/closing the bypass circuit under the O/S
TB7	Subcooling control
TH2	Opening/closing the discharge capacity control
TH3	Outdoor unit heat exchanger
TH4	For opening/closing the defrost circuit
TH5	Power supply
TH6	Terminal block
TH7	Indoor/Outdoor transmission cable
TH8	Central control transmission cable
TH9	Subcool bypass outlet temperature
TH10	Pipe temperature
TH11	Discharge pipe temperature
TH12	ACC Inlet pipe temperature
TH13	Subcooled liquid refrigerant
TH14	Gas temperature
TH15	Heat exchanger outlet pipe temperature
TH16	IPM temperature
TH17	THHS
TH18	DC reactor temperature
TH19	Function sealing connector
TH20	
TH21	
TH22	
TH23	
TH24	
TH25	
TH26	
TH27	
TH28	
TH29	
TH30	
TH31	
TH32	
TH33	
TH34	
TH35	
TH36	
TH37	
TH38	
TH39	
TH40	
TH41	
TH42	
TH43	
TH44	
TH45	
TH46	
TH47	
TH48	
TH49	
TH50	
TH51	
TH52	
TH53	
TH54	
TH55	
TH56	
TH57	
TH58	
TH59	
TH60	
TH61	
TH62	
TH63	
TH64	
TH65	
TH66	
TH67	
TH68	
TH69	
TH70	
TH71	
TH72	
TH73	
TH74	
TH75	
TH76	
TH77	
TH78	
TH79	
TH80	
TH81	
TH82	
TH83	
TH84	
TH85	
TH86	
TH87	
TH88	
TH89	
TH90	
TH91	
TH92	
TH93	
TH94	
TH95	
TH96	
TH97	
TH98	
TH99	
TH100	

Measurement condition
PUHY-EP200, 250YLM-A(-BS)

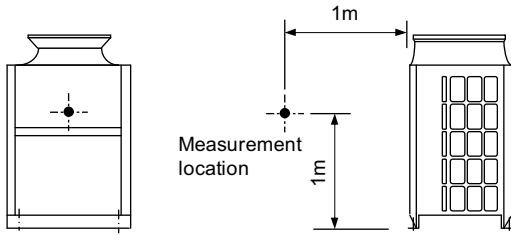

Measurement condition
PUHY-EP300, 350YLM-A(-BS)

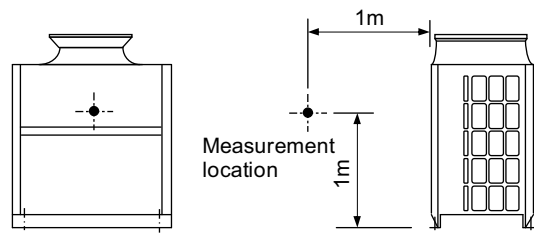

Sound level of PUHY-EP200YLM-A(-BS)

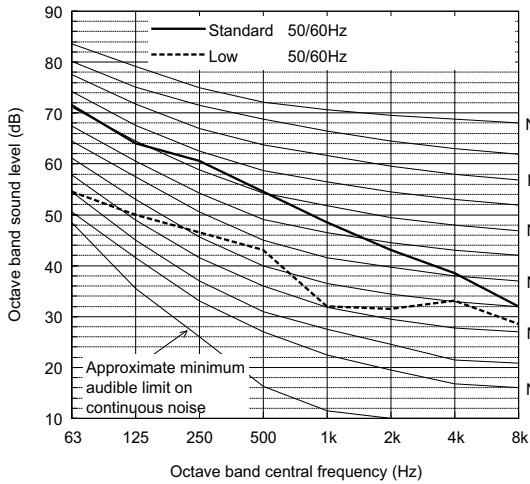

		63	125	250	500	1k	2k	4k	8k	dB(A)
Standard	50/60Hz	71.5	64.0	60.5	54.5	48.5	43.0	38.5	32.0	57.0
Low noise mode	50/60Hz	54.5	50.0	46.5	43.0	32.0	31.5	33.0	28.5	44.0

When Low noise mode is set, the A/C system's capacity is limited. The system could return to normal operation from Low noise mode automatically in the case that the operation condition is severe.

Sound level of PUHY-EP300YLM-A(-BS)

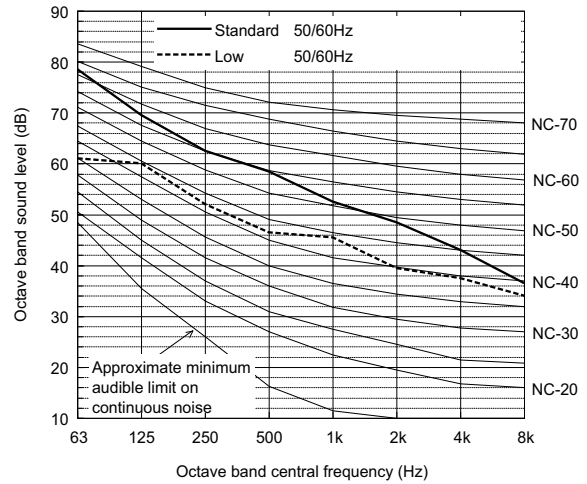

		63	125	250	500	1k	2k	4k	8k	dB(A)
Standard	50/60Hz	78.5	69.5	62.5	58.5	52.5	48.5	43.0	36.5	61.0
Low noise mode	50/60Hz	61.0	60.0	52.0	46.5	45.5	39.5	37.5	34.0	51.0

When Low noise mode is set, the A/C system's capacity is limited. The system could return to normal operation from Low noise mode automatically in the case that the operation condition is severe.

Sound level of PUHY-EP250YLM-A(-BS)

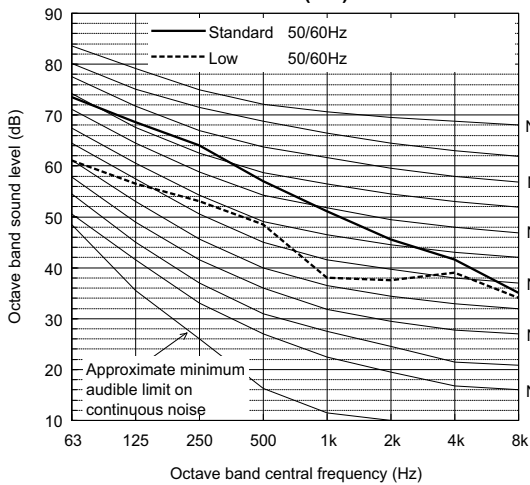

		63	125	250	500	1k	2k	4k	8k	dB(A)
Standard	50/60Hz	73.5	68.5	64.0	57.0	51.0	45.5	41.5	35.0	60.0
Low noise mode	50/60Hz	61.0	56.5	53.0	48.5	38.0	37.5	39.0	34.0	50.0

When Low noise mode is set, the A/C system's capacity is limited. The system could return to normal operation from Low noise mode automatically in the case that the operation condition is severe.

Sound level of PUHY-EP350YLM-A(-BS)

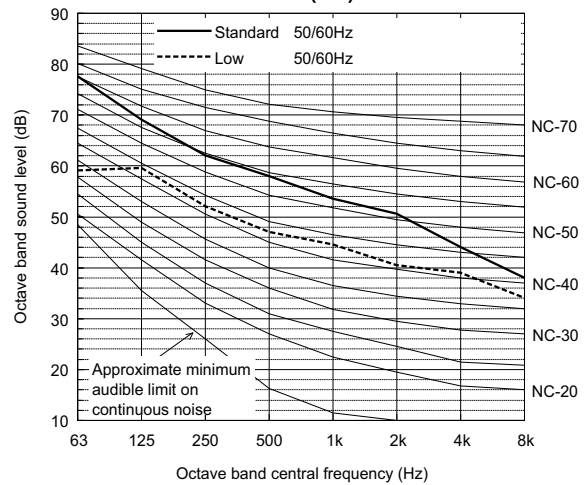

		63	125	250	500	1k	2k	4k	8k	dB(A)
Standard	50/60Hz	77.5	69.0	62.0	58.0	53.5	50.5	44.0	38.0	61.0
Low noise mode	50/60Hz	59.0	59.5	52.0	47.0	44.5	40.5	39.0	34.0	51.0

When Low noise mode is set, the A/C system's capacity is limited. The system could return to normal operation from Low noise mode automatically in the case that the operation condition is severe.

♦ Depending on the operation conditions, the unit generates noise caused by valve actuation, refrigerant flow, and pressure changes when operating normally. Please consider to avoid location where quietness is required.

Measurement condition
PUHY-EP400, 450, 500YLM-A(-BS)

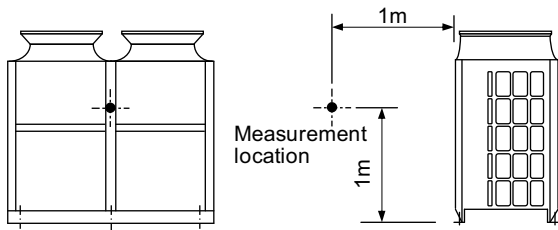

Sound level of PUHY-EP500YLM-A(-BS)

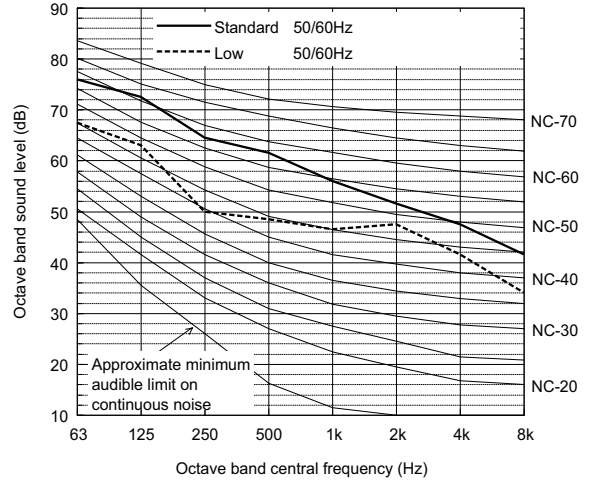

		63	125	250	500	1k	2k	4k	8k	dB(A)
Standard	50/60Hz	76.0	72.5	64.5	61.5	56.0	51.5	47.5	41.5	63.5
Low noise mode	50/60Hz	67.5	63.0	50.0	48.5	46.5	47.5	41.5	34.0	54.0

When Low noise mode is set, the A/C system's capacity is limited. The system could return to normal operation from Low noise mode automatically in the case that the operation condition is severe.

Sound level of PUHY-EP400YLM-A(-BS)

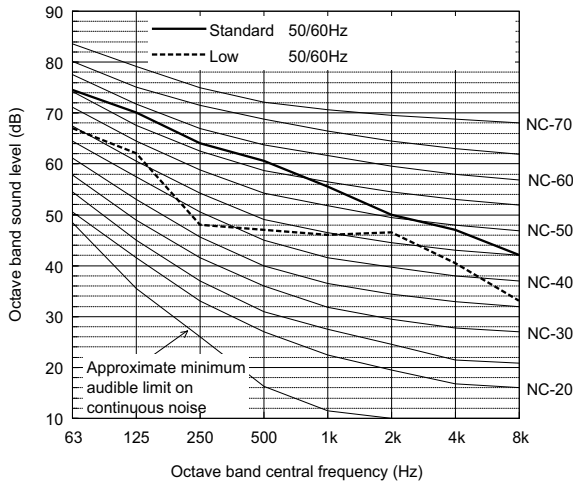

		63	125	250	500	1k	2k	4k	8k	dB(A)
Standard	50/60Hz	74.5	70.0	64.0	60.5	55.5	50.0	47.0	42.0	62.5
Low noise mode	50/60Hz	67.0	62.0	48.0	47.0	46.0	46.5	40.5	33.0	53.0

When Low noise mode is set, the A/C system's capacity is limited. The system could return to normal operation from Low noise mode automatically in the case that the operation condition is severe.

Sound level of PUHY-EP450YLM-A(-BS)

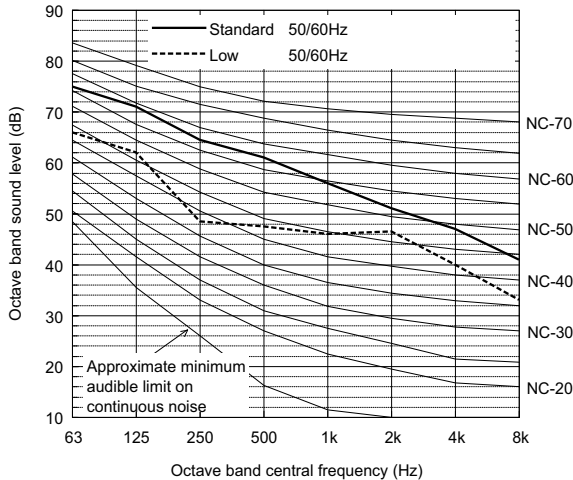

		63	125	250	500	1k	2k	4k	8k	dB(A)
Standard	50/60Hz	75.0	71.0	64.5	61.0	56.0	51.0	47.0	41.0	63.0
Low noise mode	50/60Hz	66.0	62.0	48.5	47.5	46.0	46.5	40.0	33.0	53.0

When Low noise mode is set, the A/C system's capacity is limited. The system could return to normal operation from Low noise mode automatically in the case that the operation condition is severe.

◆ Depending on the operation conditions, the unit generates noise caused by valve actuation, refrigerant flow, and pressure changes when operating normally. Please consider to avoid location where quietness is required.

Measurement condition
PUHY-EP550YSLM-A(-BS)

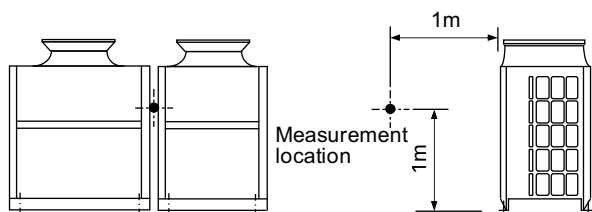

Measurement condition
PUHY-EP600YSLM-A(-BS)

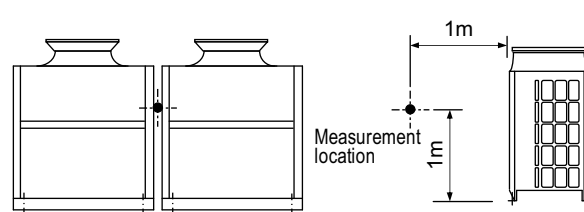

Sound level of PUHY-EP550YSLM-A(-BS)

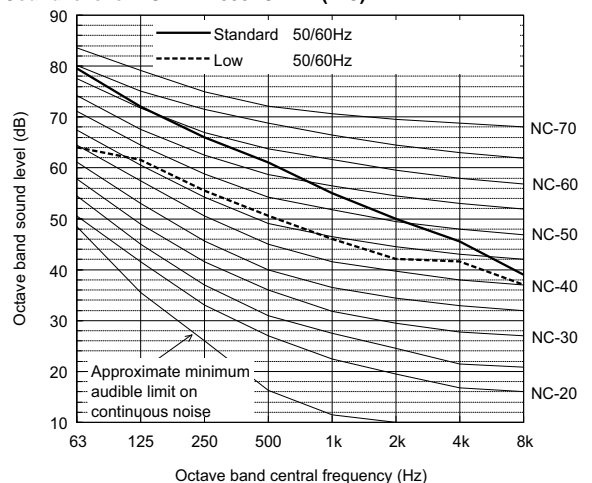

		63	125	250	500	1k	2k	4k	8k	dB(A)
Standard	50/60Hz	79.5	72.0	66.0	61.0	55.0	50.0	45.5	39.0	63.5
Low noise mode	50/60Hz	64.0	61.5	55.5	50.5	46.0	42.0	41.5	37.0	53.5

When Low noise mode is set, the A/C system's capacity is limited. The system could return to normal operation from Low noise mode automatically in the case that the operation condition is severe.

Sound level of PUHY-EP600YSLM-A(-BS)

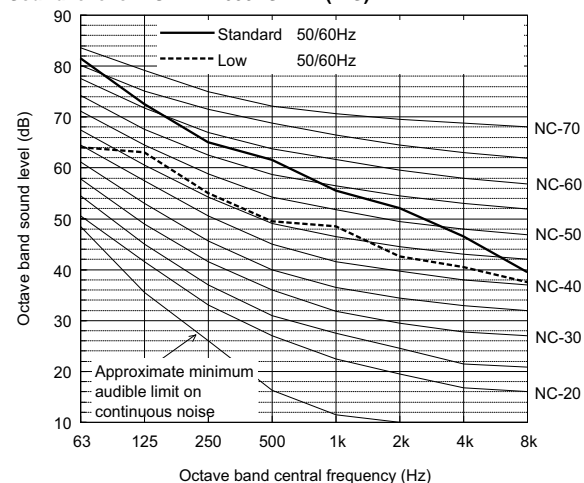

		63	125	250	500	1k	2k	4k	8k	dB(A)
Standard	50/60Hz	81.5	72.5	65.0	61.5	55.5	52.0	46.5	39.5	64.0
Low noise mode	50/60Hz	64.0	63.0	55.0	49.5	48.5	42.5	40.5	37.5	54.0

When Low noise mode is set, the A/C system's capacity is limited. The system could return to normal operation from Low noise mode automatically in the case that the operation condition is severe.

• Depending on the operation conditions, the unit generates noise caused by valve actuation, refrigerant flow, and pressure changes when operating normally. Please consider to avoid location where quietness is required.

Measurement condition
PUHY-EP650YSLM-A(-BS)

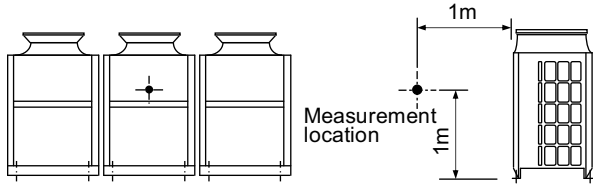

Measurement condition
PUHY-EP700, 750YSLM-A(-BS)

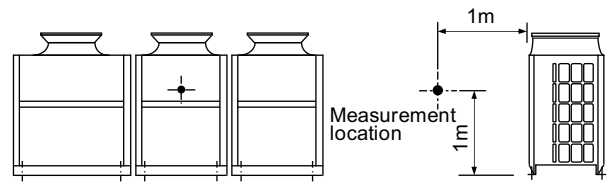

Sound level of PUHY-EP650YSLM-A(-BS)

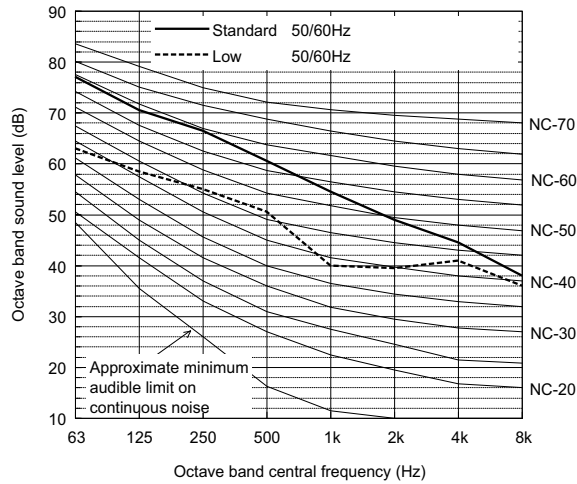

		63	125	250	500	1k	2k	4k	8k	dB(A)
Standard	50/60Hz	77.0	70.5	66.5	60.5	54.5	49.0	44.5	38.0	63.0
Low noise mode	50/60Hz	63.0	58.5	55.0	50.5	40.0	39.5	41.0	36.0	52.0

When Low noise mode is set, the A/C system's capacity is limited. The system could return to normal operation from Low noise mode automatically in the case that the operation condition is severe.

Sound level of PUHY-EP700YSLM-A(-BS)

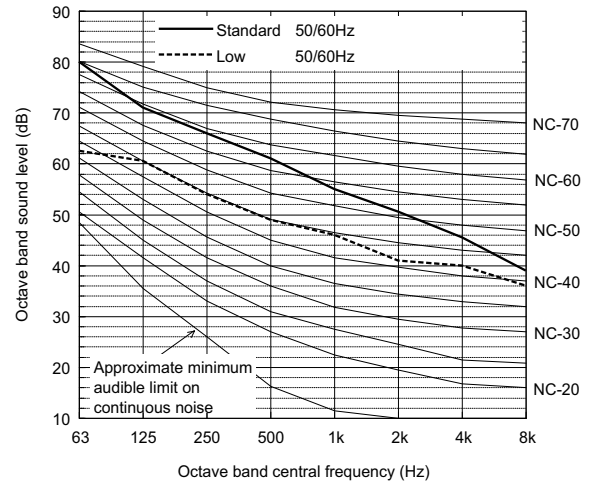

		63	125	250	500	1k	2k	4k	8k	dB(A)
Standard	50/60Hz	80.0	71.0	66.0	61.0	55.0	50.5	45.5	39.0	63.5
Low noise mode	50/60Hz	62.5	60.5	54.0	49.0	46.0	41.0	40.0	36.0	52.5

When Low noise mode is set, the A/C system's capacity is limited. The system could return to normal operation from Low noise mode automatically in the case that the operation condition is severe.

Sound level of PUHY-EP750YSLM-A(-BS)

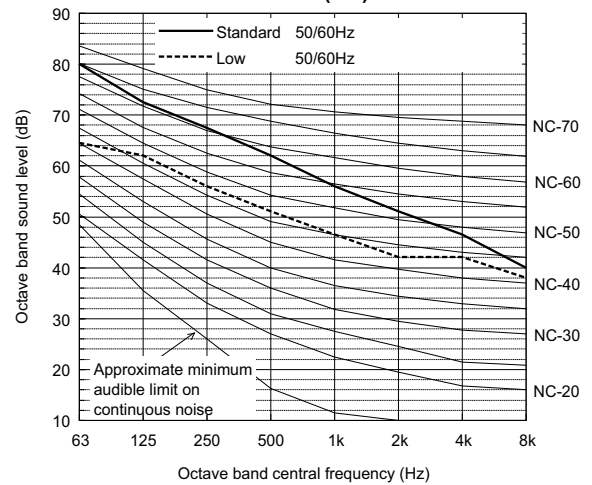

		63	125	250	500	1k	2k	4k	8k	dB(A)
Standard	50/60Hz	80.0	72.5	67.5	62.0	56.0	51.0	46.5	40.0	64.5
Low noise mode	50/60Hz	64.5	62.0	56.0	51.0	46.5	42.0	42.0	38.0	54.0

When Low noise mode is set, the A/C system's capacity is limited. The system could return to normal operation from Low noise mode automatically in the case that the operation condition is severe.

◆ Depending on the operation conditions, the unit generates noise caused by valve actuation, refrigerant flow, and pressure changes when operating normally. Please consider to avoid location where quietness is required.

Measurement condition
PUHY-EP800, 850YSLM-A(-BS)

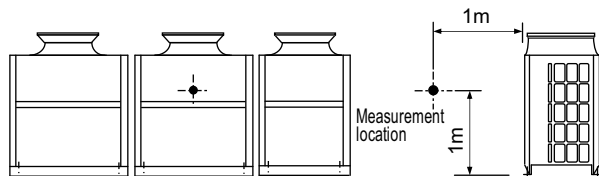

Measurement condition
PUHY-EP900, 950YSLM-A(-BS)

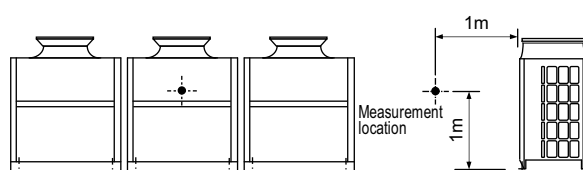

Sound level of PUHY-EP800YSLM-A(-BS)

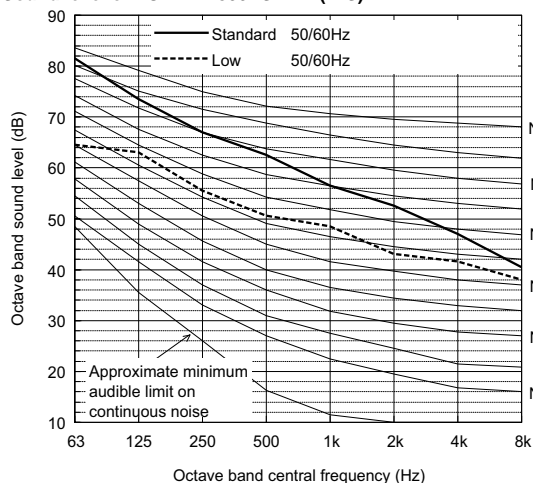

		63	125	250	500	1k	2k	4k	8k	dB(A)
Standard	50/60Hz	81.5	73.5	67.0	62.5	56.5	52.5	47.0	40.5	65.0
Low noise mode	50/60Hz	64.5	63.0	55.5	50.5	48.5	43.0	41.5	38.0	54.5

When Low noise mode is set, the A/C system's capacity is limited. The system could return to normal operation from Low noise mode automatically in the case that the operation condition is severe.

Sound level of PUHY-EP900YSLM-A(-BS)

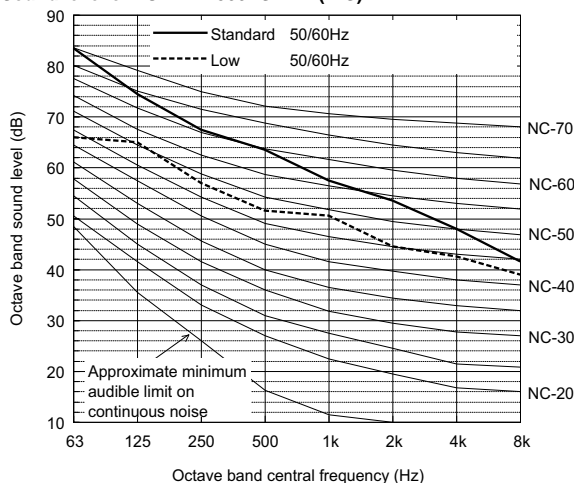

		63	125	250	500	1k	2k	4k	8k	dB(A)
Standard	50/60Hz	83.5	74.5	67.5	63.5	57.5	53.5	48.0	41.5	66.0
Low noise mode	50/60Hz	66.0	65.0	57.0	51.5	50.5	44.5	42.5	39.0	56.0

When Low noise mode is set, the A/C system's capacity is limited. The system could return to normal operation from Low noise mode automatically in the case that the operation condition is severe.

Sound level of PUHY-EP850YSLM-A(-BS)

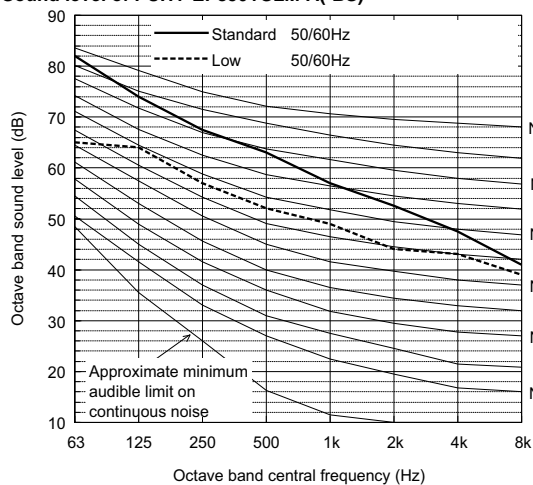

		63	125	250	500	1k	2k	4k	8k	dB(A)
Standard	50/60Hz	82.0	74.0	67.5	63.0	57.0	52.5	47.5	41.0	65.5
Low noise mode	50/60Hz	65.0	64.0	57.0	52.0	49.0	44.0	43.0	39.0	55.5

When Low noise mode is set, the A/C system's capacity is limited. The system could return to normal operation from Low noise mode automatically in the case that the operation condition is severe.

Sound level of PUHY-EP950YSLM-A(-BS)

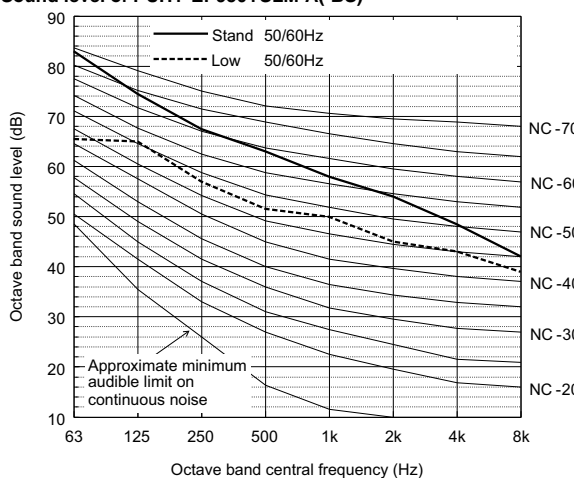

		63	125	250	500	1k	2k	4k	8k	dB(A)
Standard	50/60Hz	83.0	74.5	67.5	63.0	58.0	54.0	48.5	42.0	66.0
Low noise mode	50/60Hz	65.5	65.0	57.0	51.5	50.0	45.0	43.0	39.0	56.0

When Low noise mode is set, the A/C system's capacity is limited. The system could return to normal operation from Low noise mode automatically in the case that the operation condition is severe.

♦ Depending on the operation conditions, the unit generates noise caused by valve actuation, refrigerant flow, and pressure changes when operating normally. Please consider to avoid location where quietness is required.

Measurement condition
PUHY-EP1000, 1050, 1100, 1150YSLM-A(-BS)

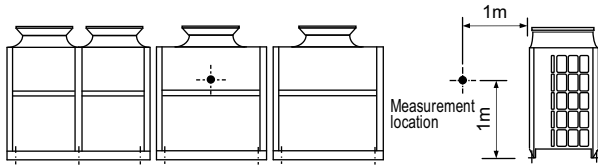

Sound level of PUHY-EP1100YSLM-A(-BS)

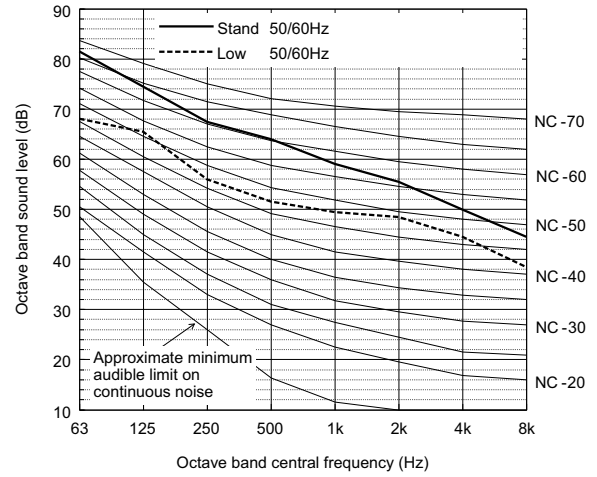

		63	125	250	500	1k	2k	4k	8k	dB(A)
Standard	50/60Hz	81.5	74.5	67.5	64.0	59.0	55.5	50.0	44.5	66.5
Low noise mode	50/60Hz	68.0	65.5	56.0	51.5	49.5	48.5	44.5	38.5	56.5

When Low noise mode is set, the A/C system's capacity is limited. The system could return to normal operation from Low noise mode automatically in the case that the operation condition is severe.

Sound level of PUHY-EP1000YSLM-A(-BS)

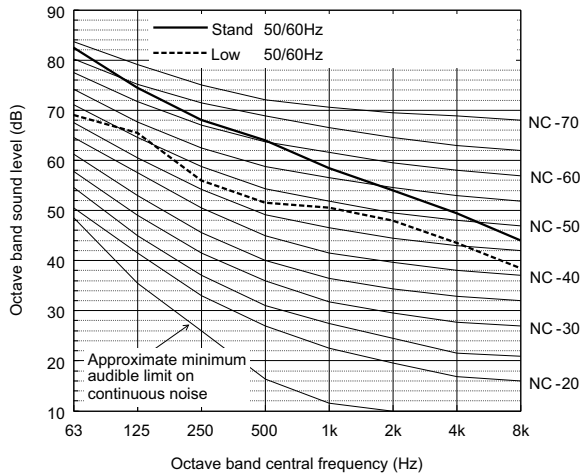

		63	125	250	500	1k	2k	4k	8k	dB(A)
Standard	50/60Hz	82.5	74.5	68.0	64.0	58.5	54.0	49.5	44.0	66.5
Low noise mode	50/60Hz	69.0	65.5	56.0	51.5	50.5	48.0	43.5	38.5	56.5

When Low noise mode is set, the A/C system's capacity is limited. The system could return to normal operation from Low noise mode automatically in the case that the operation condition is severe.

Sound level of PUHY-EP1150YSLM-A(-BS)

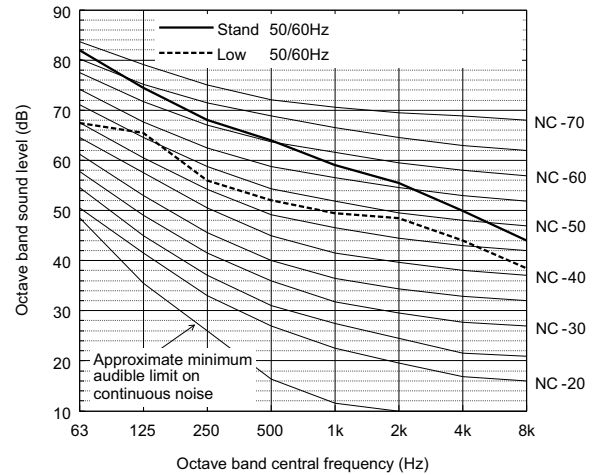

		63	125	250	500	1k	2k	4k	8k	dB(A)
Standard	50/60Hz	82.0	74.5	68.0	64.0	59.0	55.5	50.0	44.0	66.5
Low noise mode	50/60Hz	67.5	65.5	56.0	52.0	49.5	48.5	44.0	38.5	56.5

When Low noise mode is set, the A/C system's capacity is limited. The system could return to normal operation from Low noise mode automatically in the case that the operation condition is severe.

Sound level of PUHY-EP1050YSLM-A(-BS)

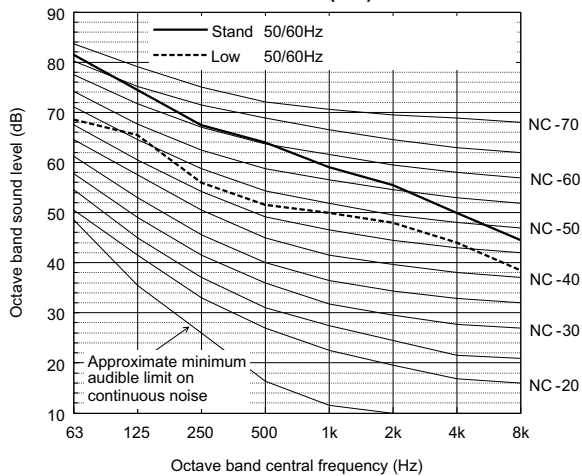

		63	125	250	500	1k	2k	4k	8k	dB(A)
Standard	50/60Hz	81.5	74.5	67.5	64.0	59.0	55.5	50.0	44.5	66.5
Low noise mode	50/60Hz	68.5	65.5	56.0	51.5	50.0	48.0	44.0	38.5	56.5

When Low noise mode is set, the A/C system's capacity is limited. The system could return to normal operation from Low noise mode automatically in the case that the operation condition is severe.

• Depending on the operation conditions, the unit generates noise caused by valve actuation, refrigerant flow, and pressure changes when operating normally. Please consider to avoid location where quietness is required.

Measurement condition
PUHY-EP1200, 1250YSLM-A(-BS)

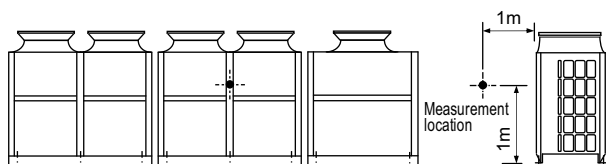

Measurement condition
PUHY-EP1300, 1350YSLM-A(-BS)

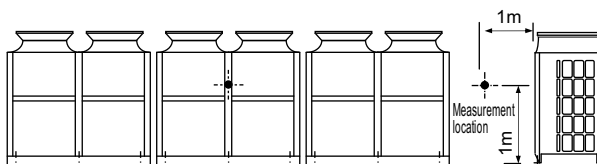

Sound level of PUHY-EP1200YSLM-A(-BS)

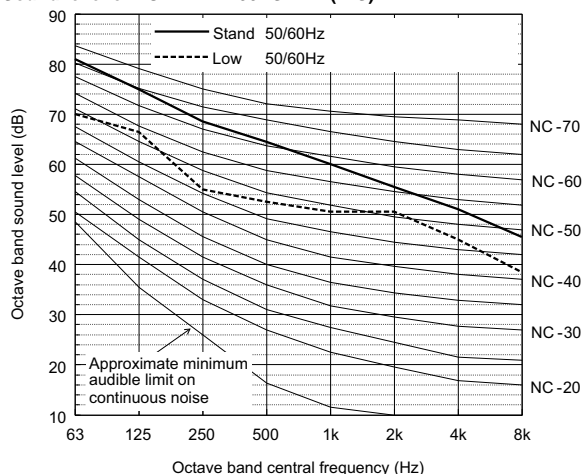

		63	125	250	500	1k	2k	4k	8k	dB(A)
Standard	50/60Hz	81.0	75.5	68.5	64.5	60.0	55.5	51.0	45.5	67.0
Low noise mode	50/60Hz	70.0	66.5	55.0	52.5	50.5	50.5	45.0	38.5	57.5

When Low noise mode is set, the A/C system's capacity is limited. The system could return to normal operation from Low noise mode automatically in the case that the operation condition is severe.

Sound level of PUHY-EP1300YSLM-A(-BS)

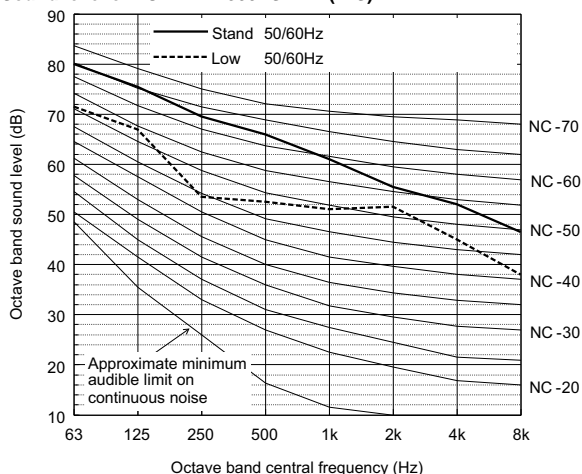

		63	125	250	500	1k	2k	4k	8k	dB(A)
Standard	50/60Hz	80.0	75.5	69.5	66.0	61.0	55.5	52.0	46.5	68.0
Low noise mode	50/60Hz	71.5	67.0	53.5	52.5	51.0	51.5	45.0	38.0	58.0

When Low noise mode is set, the A/C system's capacity is limited. The system could return to normal operation from Low noise mode automatically in the case that the operation condition is severe.

Sound level of PUHY-EP1250YSLM-A(-BS)

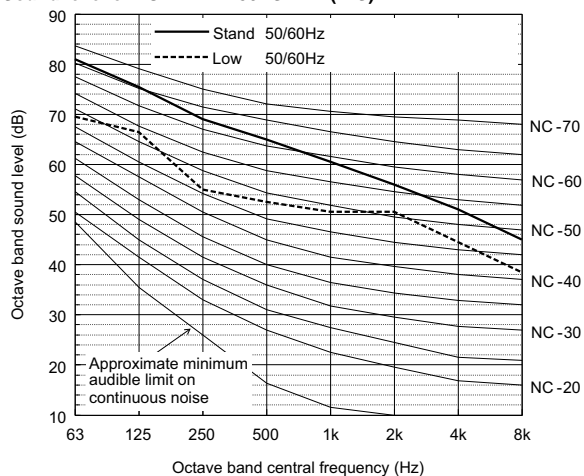

		63	125	250	500	1k	2k	4k	8k	dB(A)
Standard	50/60Hz	81.0	75.5	69.0	65.0	60.5	56.0	51.0	45.0	67.5
Low noise mode	50/60Hz	69.5	66.5	55.0	52.5	50.5	50.5	44.5	38.5	57.5

When Low noise mode is set, the A/C system's capacity is limited. The system could return to normal operation from Low noise mode automatically in the case that the operation condition is severe.

Sound level of PUHY-EP1350YSLM-A(-BS)

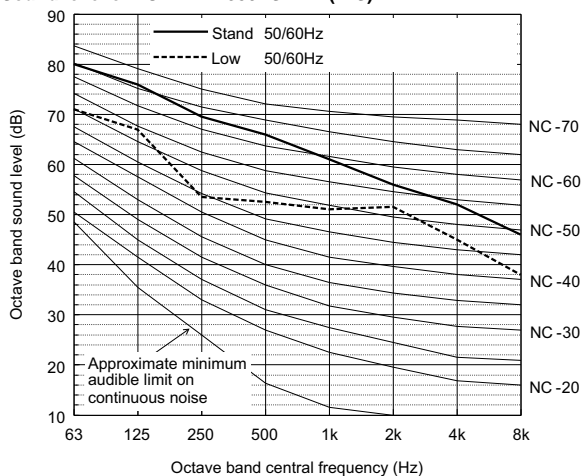

		63	125	250	500	1k	2k	4k	8k	dB(A)
Standard	50/60Hz	80.0	76.0	69.5	66.0	61.0	56.0	52.0	46.0	68.0
Low noise mode	50/60Hz	71.0	67.0	53.5	52.5	51.0	51.5	45.0	38.0	58.0

When Low noise mode is set, the A/C system's capacity is limited. The system could return to normal operation from Low noise mode automatically in the case that the operation condition is severe.

♦ Depending on the operation conditions, the unit generates noise caused by valve actuation, refrigerant flow, and pressure changes when operating normally. Please consider to avoid location where quietness is required.

[PUHY-EP200-500YLM, PUHY-EP550-1350YSLM]

Measurement condition

Measurement frequency: 1 Hz-80 Hz

Measurement point: Ground surface 20 cm away from the unit leg

Installation condition: Direct installation on the concrete floor

Power source: 3-phase 4-wire 380-400-415 V 50/60 Hz

Operation condition: JIS condition (cooling, heating)

Measurement device: Vibration level meter for vibration pollution VM-1220C (JIS-compliant product)

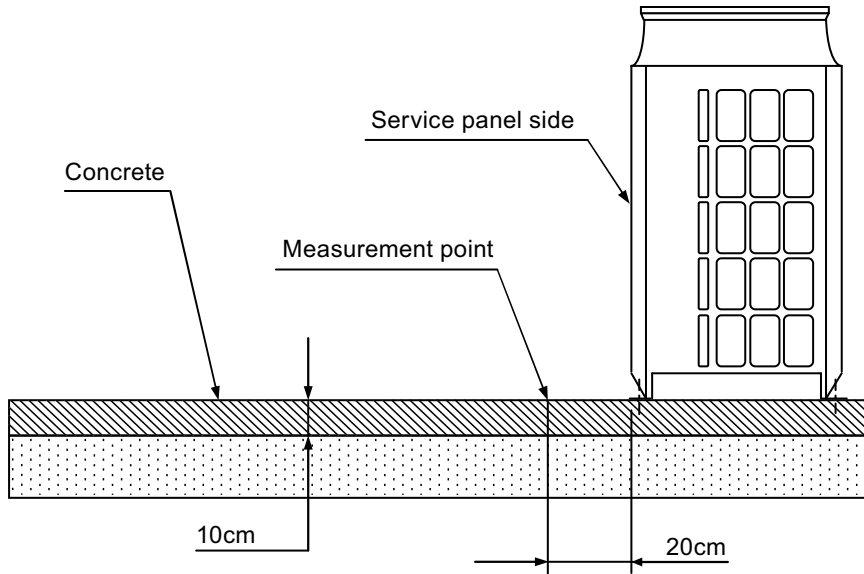

Vibration level

Model	Vibration level (dB)
PUHY-EP200YLM-A (-BS)	46
PUHY-EP250YLM-A (-BS)	46
PUHY-EP300YLM-A (-BS)	47
PUHY-EP350YLM-A (-BS)	47
PUHY-EP400YLM-A (-BS)	47
PUHY-EP450YLM-A (-BS)	47
PUHY-EP500YLM-A (-BS)	48
PUHY-EP550YSLM-A (-BS)	49.5
PUHY-EP600YSLM-A (-BS)	50
PUHY-EP650YSLM-A (-BS)	51
PUHY-EP700YSLM-A (-BS)	51
PUHY-EP750YSLM-A (-BS)	51.5
PUHY-EP800YSLM-A (-BS)	51.5
PUHY-EP850YSLM-A (-BS)	51.5
PUHY-EP900YSLM-A (-BS)	52
PUHY-EP950YSLM-A (-BS)	52
PUHY-EP1000YSLM-A (-BS)	52
PUHY-EP1050YSLM-A (-BS)	52
PUHY-EP1100YSLM-A (-BS)	52
PUHY-EP1150YSLM-A (-BS)	52
PUHY-EP1200YSLM-A (-BS)	52
PUHY-EP1250YSLM-A (-BS)	52
PUHY-EP1300YSLM-A (-BS)	52
PUHY-EP1350YSLM-A (-BS)	52

* Vibration level varies depending on the conditions of actual installation site.

• Cooling

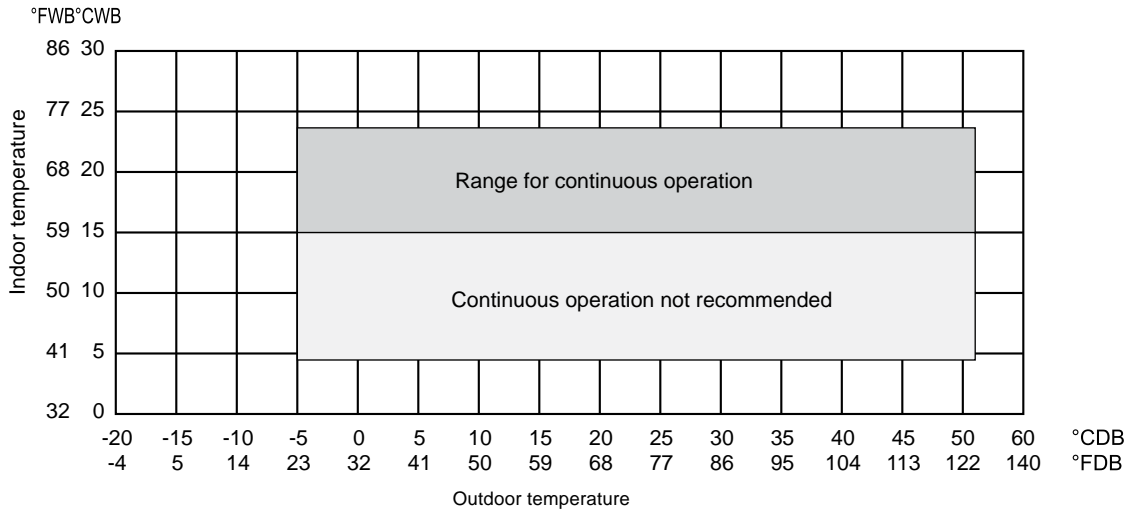

• Heating

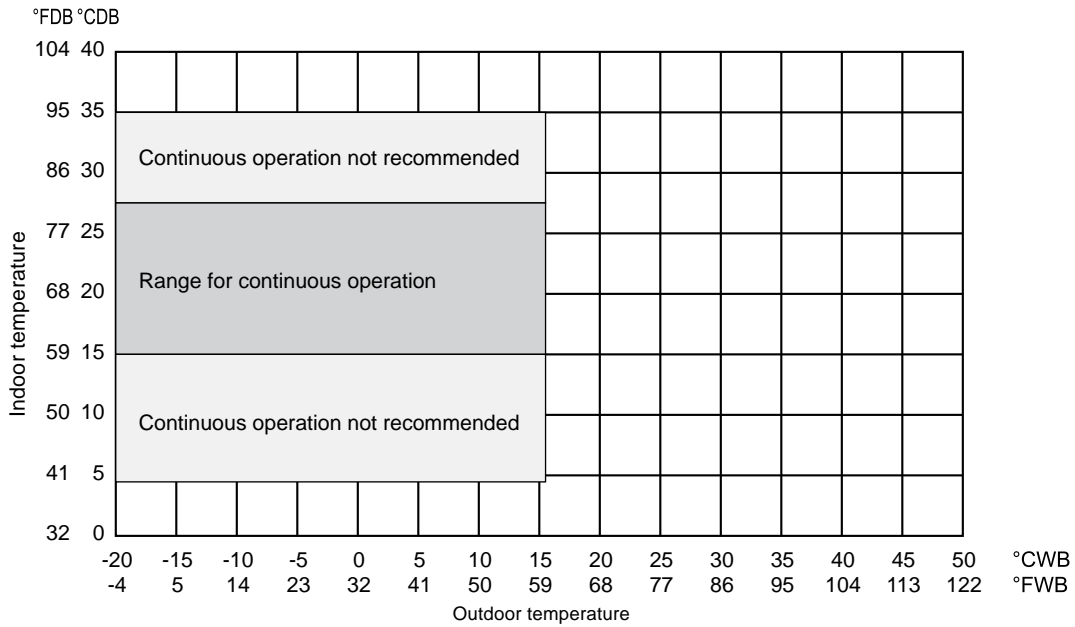

Section 8-1.

Shows an example of how to select the indoor and outdoor units according to the required heating/cooling load.

Section 8-2. through 8-5.

Show the actual correction data of indoor and outdoor units.

8-1. Selection of Cooling/Heating Units

<Cooling>

Design Condition	
Outdoor Design Dry Bulb Temperature	43 °C
Total Cooling Load	18.0 kW
Room1	
Indoor Design Dry Bulb Temperature	27 °C
Indoor Design Wet Bulb Temperature	20 °C
Cooling Load	8.0 kW
Room2	
Indoor Design Dry Bulb Temperature	24 °C
Indoor Design Wet Bulb Temperature	17 °C
Cooling Load	10.0 kW
<Other>	
Indoor/Outdoor Equivalent Piping Length	50 m

1. Cooling Calculation

(1) Temporary Selection of Indoor Units

Room1	PEFY-P80	9 kW (Rated)
Room2	PEFY-P100	11.2 kW (Rated)

(2) Total Indoor Units Capacity

$P80 + P100 = P180$

(3) Selection of Outdoor Unit

The P200 outdoor unit is selected as total indoor units capacity is P180

PUHY-P200	22.4 kW
-----------	---------

(4) Total Indoor Units Capacity Correction Calculation

Room1	Indoor Design Wet Bulb Temperature Correction (20°C)	1.04 (Refer to Fig.1)
Room2	Indoor Design Wet Bulb Temperature Correction (17°C)	0.95 (Refer to Fig.1)

Total Indoor Units Capacity (CTi)

$$CTi = \sum (\text{Indoor Unit Rating} \times \text{Indoor Design Temperature Correction})$$

$$= 9.0 \times 1.04 + 11.2 \times 0.95$$

$$= 20.0 \text{ kW}$$

(5) Outdoor Unit Correction Calculation

Outdoor Design Dry Bulb Temperature Correction (43°C)	0.94 (Refer to Fig.2)
Piping Length Correction (50 m)	0.94 (Refer to Fig.3)

Total Outdoor Unit Capacity (CTo)

$$CTo = \text{Outdoor Rating} \times \text{Outdoor Design Temperature Correction} \times \text{Piping Length Correction}$$

$$= 22.4 \times 0.94 \times 0.94$$

$$= 19.9 \text{ kW}$$

(6) Determination of Maximum System Capacity

Comparison of Capacity between Total Indoor Units Capacity (CTi) and Total Outdoor Unit Capacity (CTo)

$CTi = 20.0 > CTo = 19.9$, thus, select CTo.

$CTx = CTo = 19.9 \text{ kW}$

(7) Comparison with Essential Load

Against the essential load 18.0kW, the maximum system capacity is 19.9kW: Proper outdoor units have been selected.

(8) Calculation of Maximum Indoor Unit Capacity of Each Room

$CTx = CTo$, thus, calculate by the calculation below

Room1

$$\text{Maximum Capacity} \times \text{Room1 Capacity after the Temperature Correction} / (\text{Room1,2 Total Capacity after the Temperature Correction})$$

$$= 19.9 \times (9.0 \times 1.04) / (9.0 \times 1.04 + 11.2 \times 0.95)$$

$$= 9.3 \text{ kW} \quad \text{OK: fulfills the load 8.0kW}$$

Room2

$$\text{Maximum Capacity} \times \text{Room2 Capacity after the Temperature Correction} / (\text{Room1,2 Total Capacity after the Temperature Correction})$$

$$= 19.9 \times (11.2 \times 0.95) / (9.0 \times 1.04 + 11.2 \times 0.95)$$

$$= 10.6 \text{ kW} \quad \text{OK: fulfills the load 10.0kW}$$

Go on to the heating trial calculation since the selected units fulfill the cooling loads of Room 1, 2.

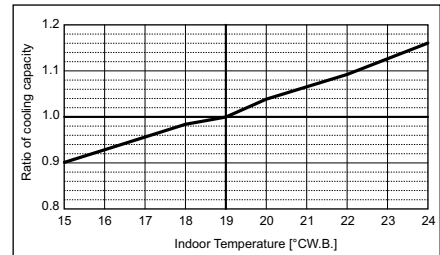

Fig.1 Indoor unit temperature correction
To be used to correct indoor unit capacity only

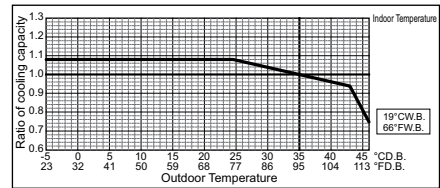

Fig.2 Outdoor unit temperature correction
To be used to correct outdoor unit capacity only

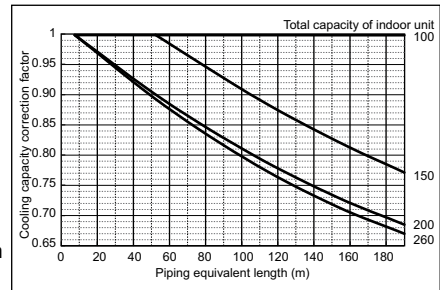

Fig.3 Correction of refrigerant piping length

<Heating>

Design Condition	
Outdoor Design Wet Bulb Temperature	-3 °C
Total Heating Load	20.5 kW
Room1	
Indoor Design Dry Bulb Temperature	21 °C
Heating Load	9.5 kW
Room2	
Indoor Design Dry Bulb Temperature	23 °C
Heating Load	11.0 kW
<Other>	
Indoor/Outdoor Equivalent Piping Length	50 m

2. Heating Calculation

(1) Temporary Selection of Indoor Units

Room1	PEFY-P80	10 kW (Rated)
Room2	PEFY-P100	12.5 kW (Rated)

(2) Total Indoor Units Capacity

P80 + P100 = P180

(3) Selection of Outdoor Unit

The P200 outdoor unit is selected as total indoor units capacity is P180

PUHY-P200	25.0 kW
-----------	---------

(4) Total Indoor Units Capacity Correction Calculation

Room1	Indoor Design Dry Bulb Temperature Correction (21°C)	0.97 (Refer to Fig.4)
Room2	Indoor Design Dry Bulb Temperature Correction (23°C)	0.90 (Refer to Fig.4)

Total Indoor Units Capacity (CTi)

$$CTi = \sum (\text{Indoor Unit Rating} \times \text{Indoor Design Temperature Correction})$$

$$= 10.0 \times 0.97 + 12.5 \times 0.90$$

$$= 21.0 \text{ kW}$$

(5) Outdoor Unit Correction Calculation

Outdoor Design Wet Bulb Temperature Correction (-3°C)	0.98 (Refer to Fig.5)
Piping Length Correction (50 m)	0.97 (Refer to Fig.6)
Defrost Correction	0.89 (Refer to Tbl.1)

Total Outdoor Unit Capacity (CTo)

$$CTo = \text{Outdoor Unit Rating} \times \text{Outdoor Design Temperature Correction} \times \text{Piping Length Correction} \times \text{Defrost Correction}$$

$$= 25.0 \times 0.98 \times 0.97 \times 0.89$$

$$= 21.1 \text{ kW}$$

(6) Determination of Maximum System Capacity

Comparison of Capacity between Total Indoor Units Capacity (CTi) and Total Outdoor Unit Capacity (CTo)

CTi = 21.0 < CTo = 21.1, thus, select CTi.

CTx = CTi = 21.0 kW

(7) Comparison with Essential Load

Against the essential load 20.5kW, the maximum system capacity is 21.0kW: Proper outdoor units have been selected.

(8) Calculation of Maximum Indoor Unit Capacity of Each Room

CTx = CTi, thus, calculate by the calculation below

Room1	Indoor Unit Rating × Indoor Design Temperature Correction	
	= 10.0 × 0.97	
	= 9.7 kW	OK: fulfills the load 9.5kW

Room2	Indoor Unit Rating × Indoor Design Temperature Correction	
	= 12.5 × 0.90	
	= 11.3 kW	OK: fulfills the load 11.0kW

Completed selecting units since the selected units fulfill the heating loads of Room 1, 2.

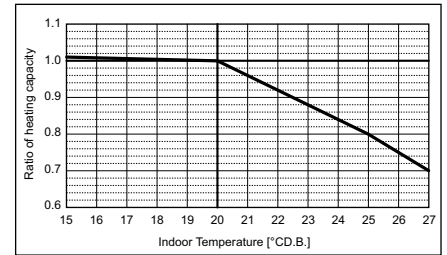

Fig.4 Indoor unit temperature correction
To be used to correct indoor unit capacity only

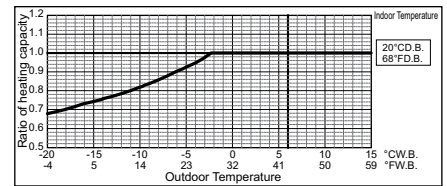

Fig.5 Outdoor unit temperature correction
To be used to correct outdoor unit capacity only

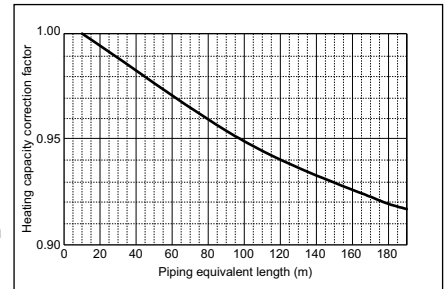

Fig.6 Correction of refrigerant piping length

Tbl.1 Table of correction factor at frost and defrost

Outdoor inlet air temp. °C	6	4	2	1	0	-2	-4	-6	-8	-10	-20
Outdoor inlet air temp. °F	43	39	36	34	32	28	25	21	18	14	-4
PUHY-P200	1.00	0.95	0.84	0.825	0.83	0.87	0.90	0.95	0.95	0.95	0.95
PUHY-P250	1.00	0.95	0.84	0.825	0.83	0.87	0.90	0.95	0.95	0.95	0.95
PUHY-P300	1.00	0.93	0.82	0.80	0.82	0.86	0.90	0.90	0.95	0.95	0.95
PUHY-P350	1.00	0.93	0.85	0.83	0.84	0.86	0.90	0.90	0.95	0.95	0.95
PUHY-P400	1.00	0.93	0.85	0.83	0.84	0.86	0.90	0.90	0.95	0.95	0.95

8-2. Correction by temperature

CITY MULTI could have varied capacity at different designing temperature. Using the nominal cooling/heating capacity value and the ratio below, the capacity can be observed at various temperature.

Y (HIGH COP)

PUHY-		EP200YLM-A	EP250YLM-A
Nominal Cooling Capacity	kW	22.4	28.0
	BTU/h	76,400	95,500
Input	kW	5.19	6.89

Indoor unit temperature correction

To be used to correct indoor unit capacity only

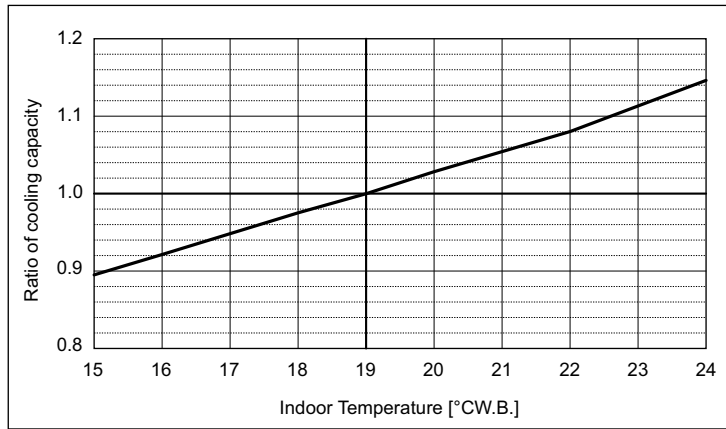

Outdoor unit temperature correction

To be used to correct outdoor unit only

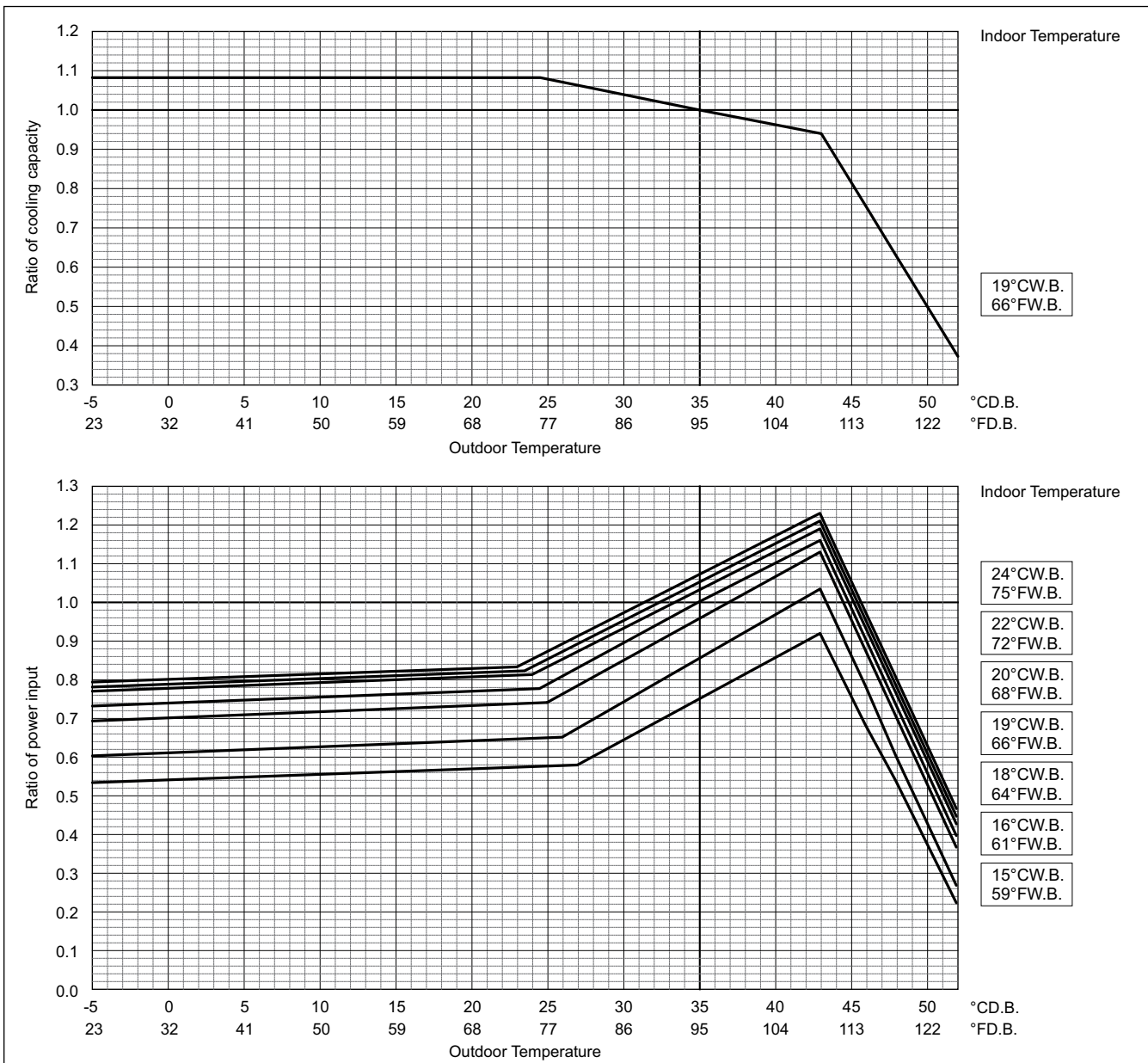

Outdoor unit power input is affected by the indoor and outdoor temperatures as shown in the graph above. Please consult the sales office for details.

PUHY-	EP200YLM-A	EP250YLM-A
Nominal Heating Capacity	kW 25.0	31.5
	BTU/h 85,300	107,500
Input	kW 5.73	7.68

Indoor unit temperature correction

To be used to correct indoor unit capacity only

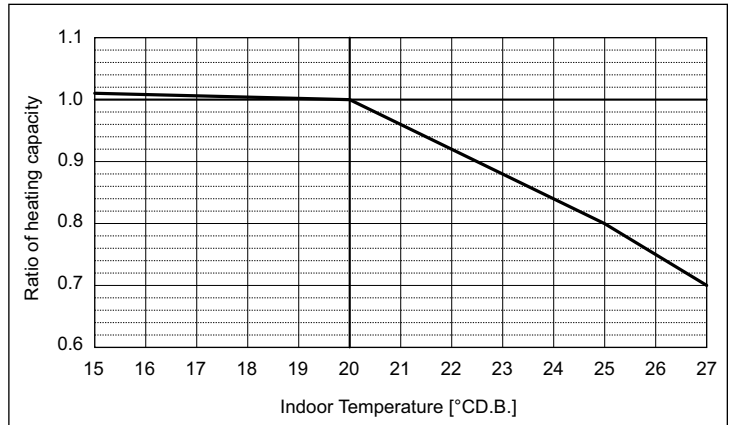

Y (HIGH COP)

Outdoor unit temperature correction

To be used to correct outdoor unit only

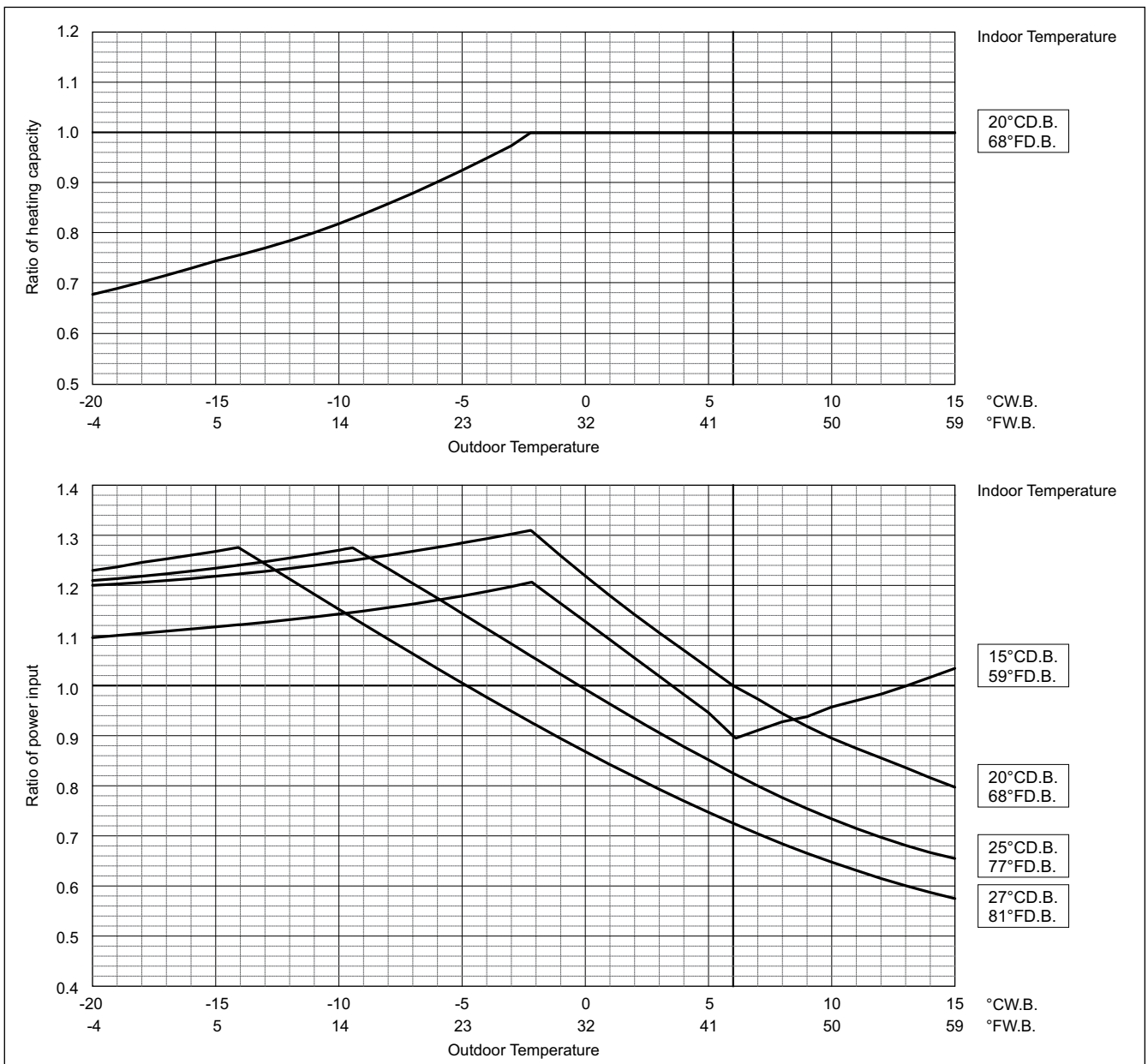

Outdoor unit power input is affected by the indoor and outdoor temperatures as shown in the graph above. Please consult the sales office for details.

Y (HIGH COP)

PUHY-		EP300YLM-A	EP350YLM-A
Nominal Cooling Capacity	kW	33.5	40.0
	BTU/h	114,300	136,500
Input	kW	8.56	11.69

Indoor unit temperature correction

To be used to correct indoor unit capacity only

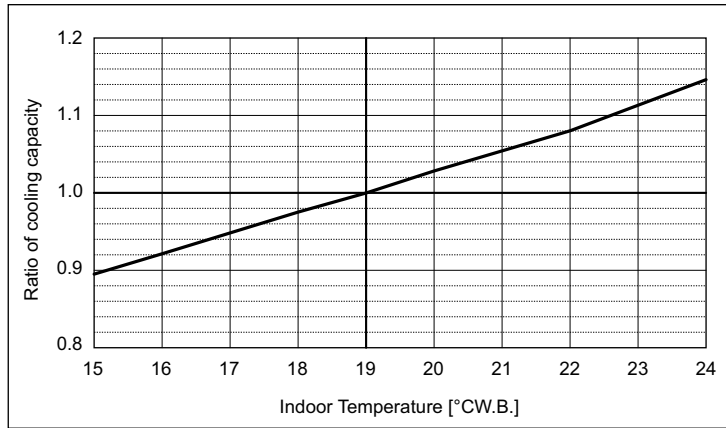

Outdoor unit temperature correction

To be used to correct outdoor unit only

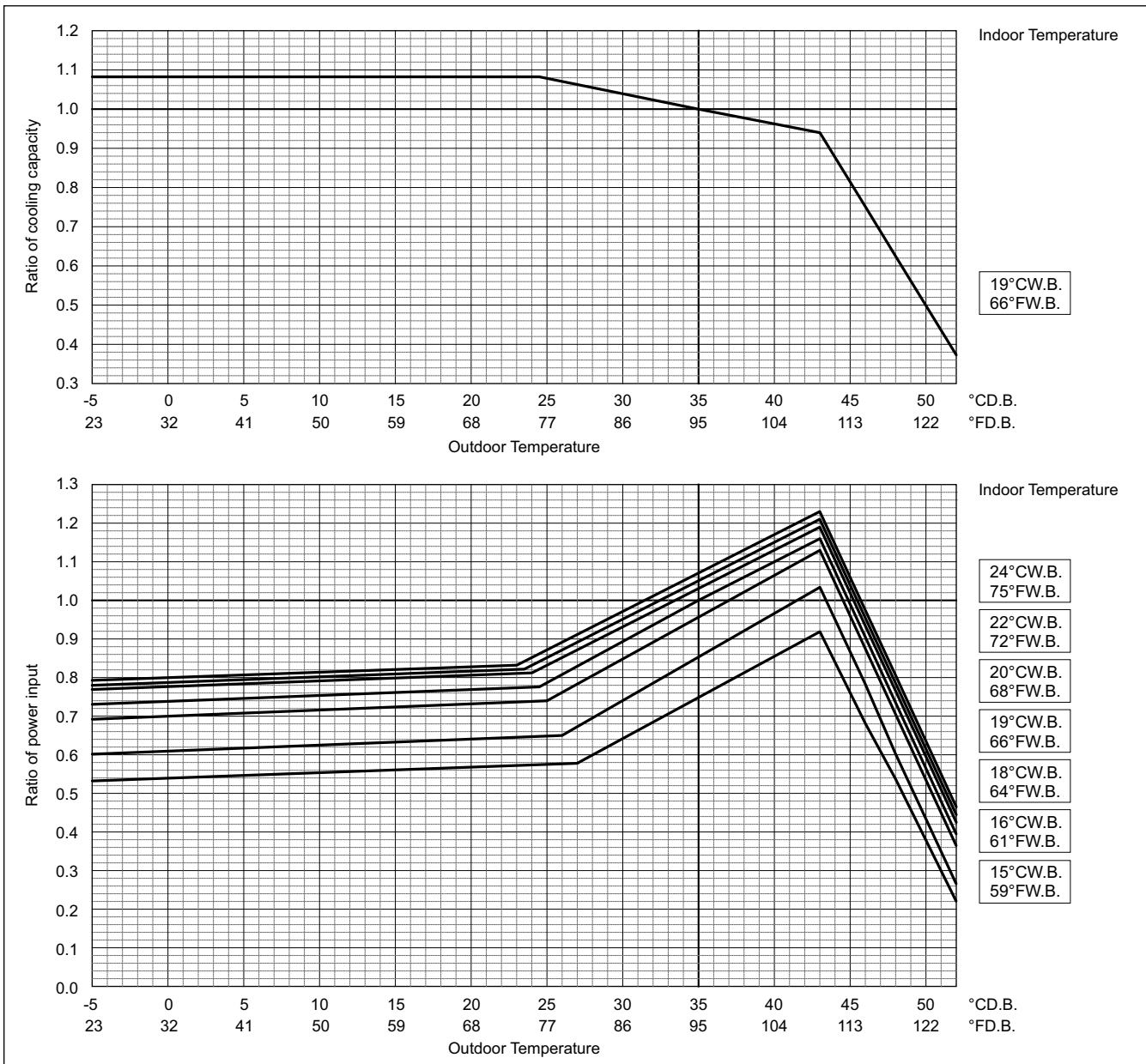

Outdoor unit power input is affected by the indoor and outdoor temperatures as shown in the graph above. Please consult the sales office for details.

PUHY-	EP300YLM-A	EP350YLM-A
Nominal Heating Capacity	kW 37.5	45.0
	BTU/h 128,000	153,500
Input	kW 9.16	12.53

Indoor unit temperature correction

To be used to correct indoor unit capacity only

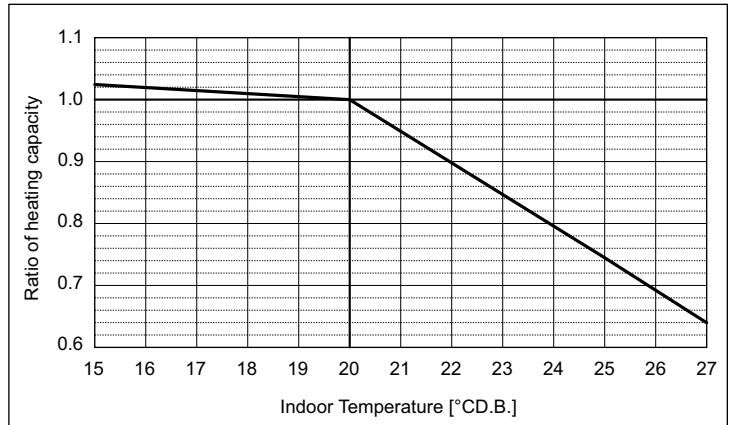

Y (HIGH COP)

Outdoor unit temperature correction

To be used to correct outdoor unit only

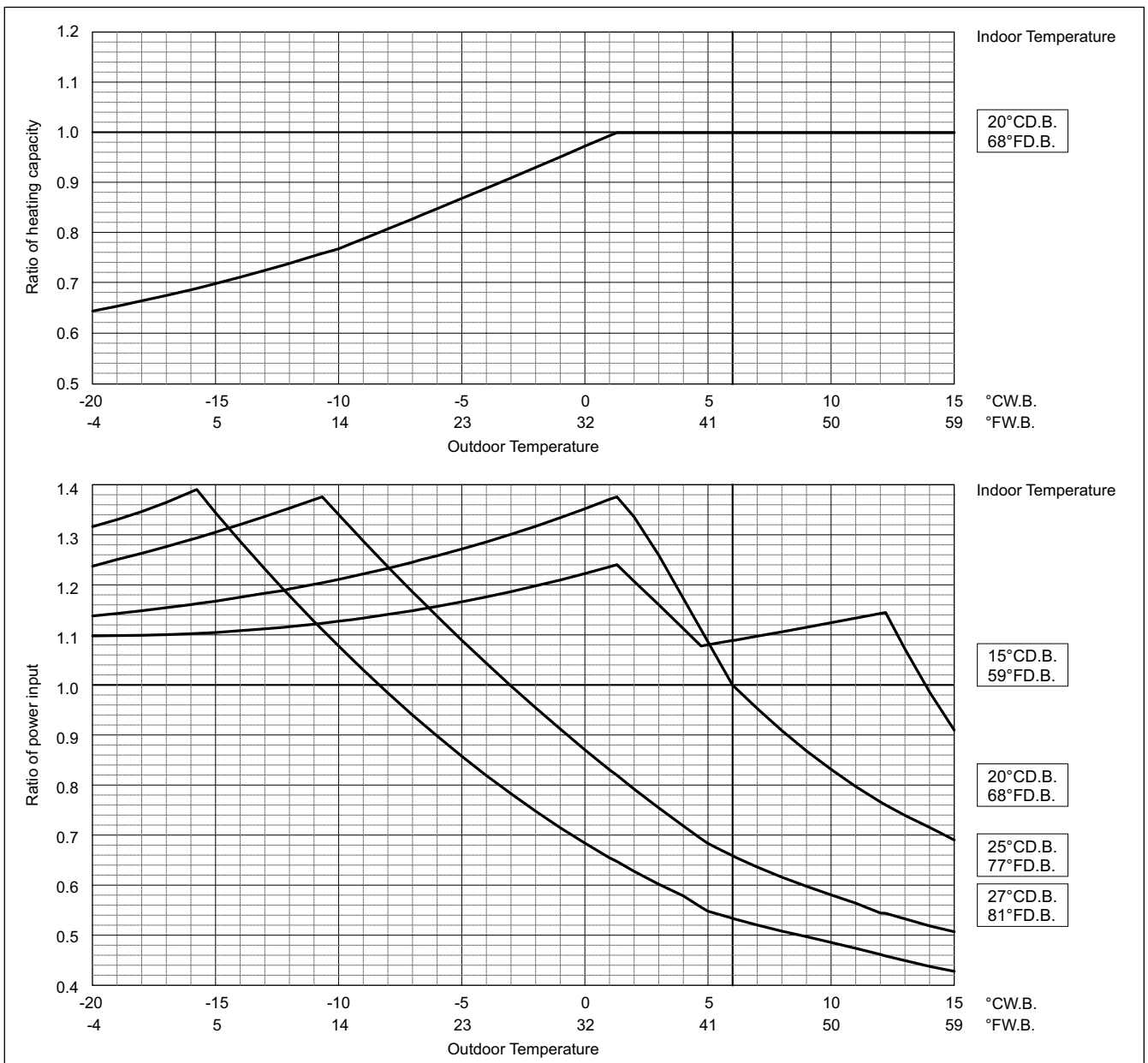

Outdoor unit power input is affected by the indoor and outdoor temperatures as shown in the graph above. Please consult the sales office for details.

Y (HIGH COP)

PUHY-		EP400YLM-A	EP450YLM-A	EP500YLM-A
Nominal Cooling Capacity	kW	45.0	50.0	56.0
	BTU/h	153,500	170,600	191,100
Input	kW	12.26	14.79	18.72

Indoor unit temperature correction

To be used to correct indoor unit capacity only

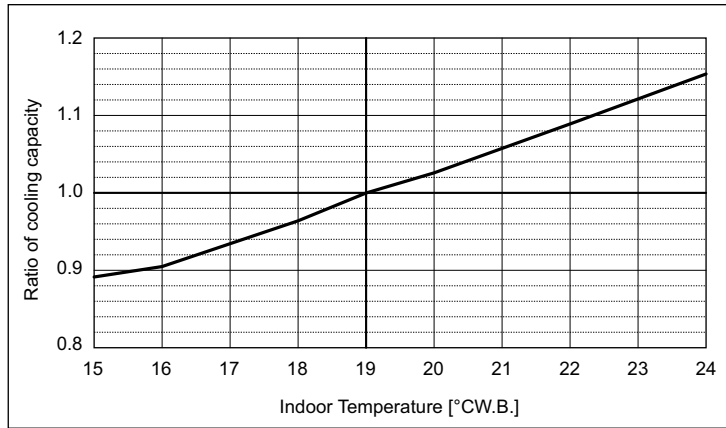

Outdoor unit temperature correction

To be used to correct outdoor unit only

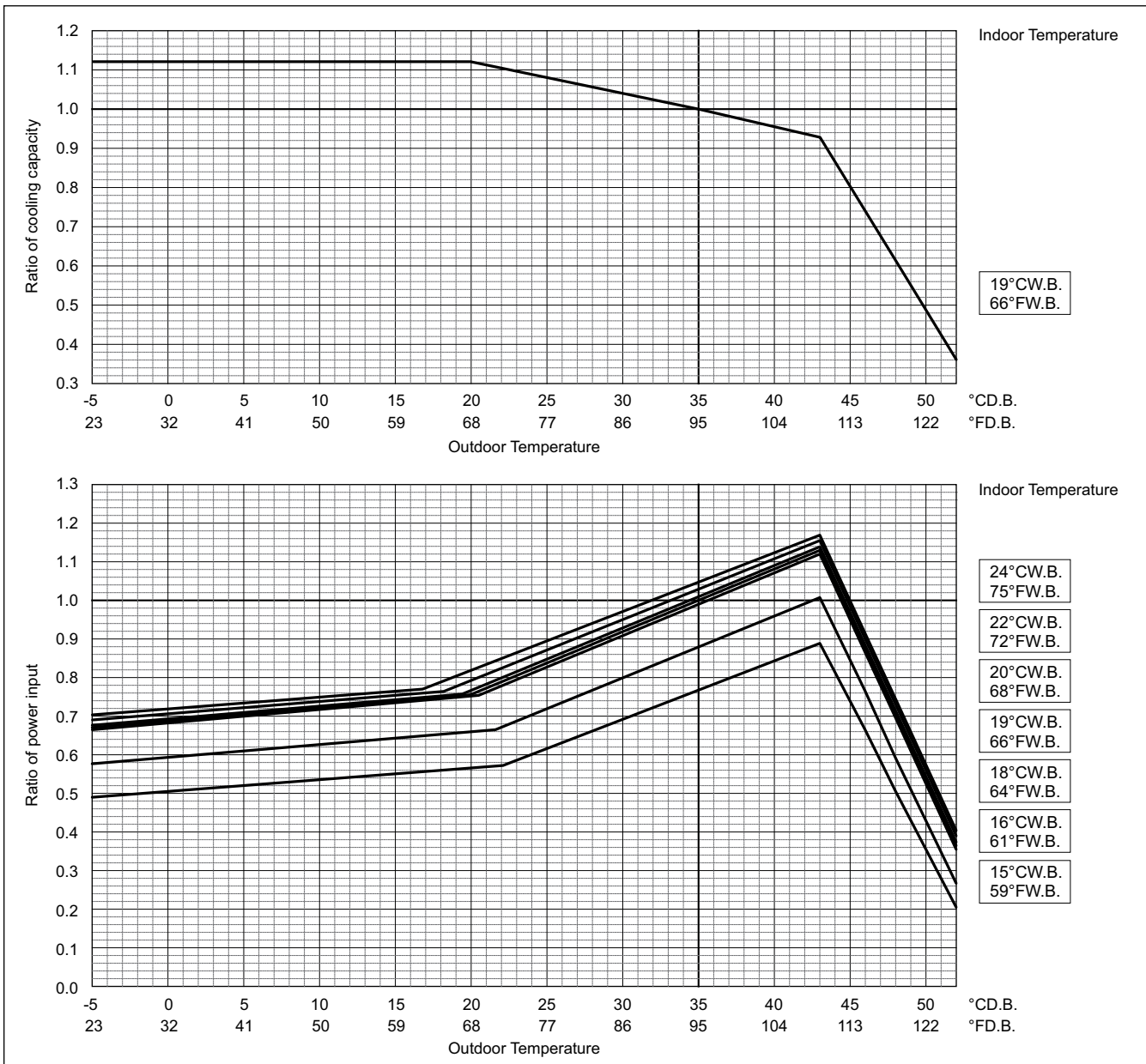

Outdoor unit power input is affected by the indoor and outdoor temperatures as shown in the graph above. Please consult the sales office for details.

PUHY-	EP400YLM-A	EP450YLM-A	EP500YLM-A
Nominal Heating Capacity	kW 50.0	56.0	63.0
	BTU/h 170,600	191,100	215,000
Input	kW 13.15	16.09	19.68

Indoor unit temperature correction
To be used to correct indoor unit capacity only

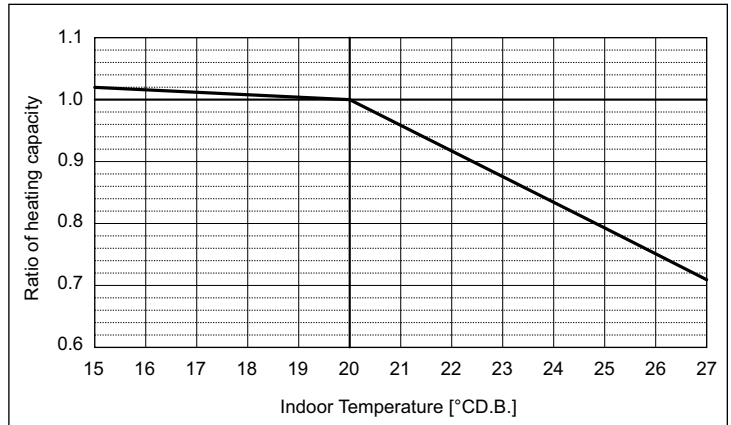

Y (HIGH COP)

Outdoor unit temperature correction
To be used to correct outdoor unit only

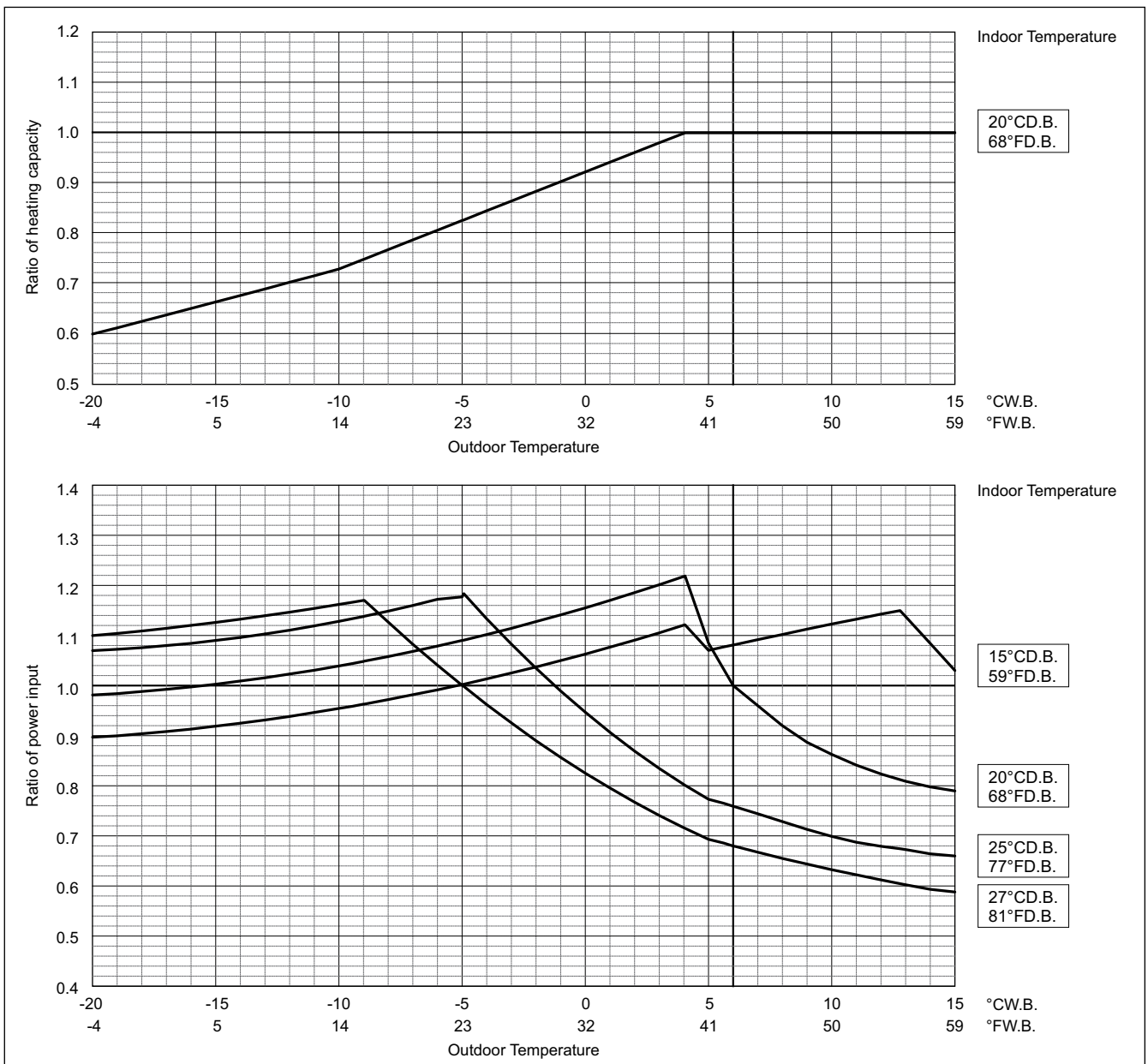

Outdoor unit power input is affected by the indoor and outdoor temperatures as shown in the graph above. Please consult the sales office for details.

PUHY-		EP550YSLM-A	EP600YSLM-A	EP650YSLM-A
Nominal Cooling Capacity	kW	63.0	69.0	73.0
	BTU/h	215,000	235,400	249,100
Input	kW	16.62	18.59	18.15

Indoor unit temperature correction

To be used to correct indoor unit capacity only

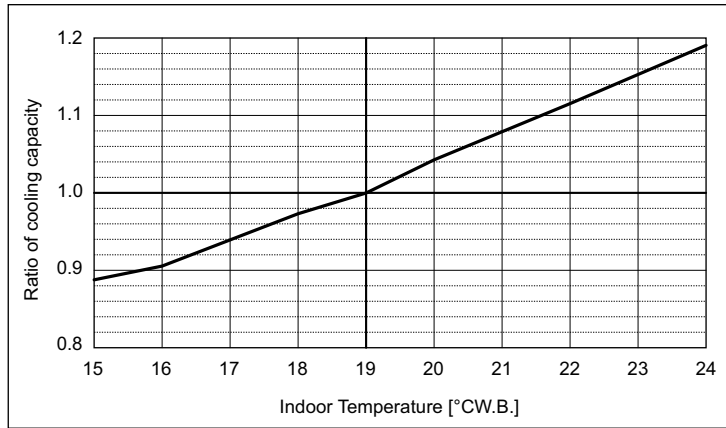

Outdoor unit temperature correction

To be used to correct outdoor unit only

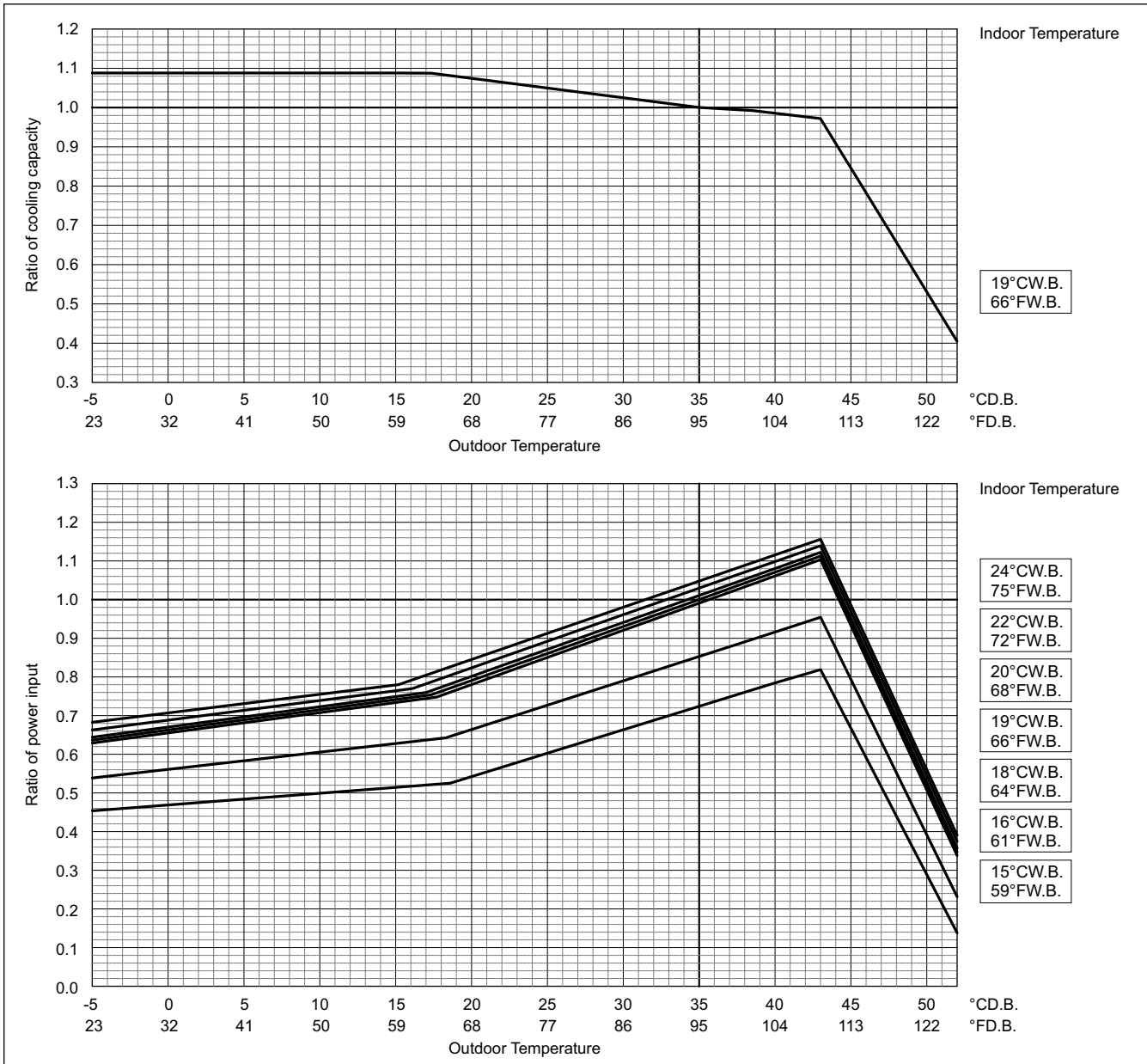

Outdoor unit power input is affected by the indoor and outdoor temperatures as shown in the graph above. Please consult the sales office for details.

PUHY-	EP550YSLM-A	EP600YSLM-A	EP650YSLM-A
Nominal Heating Capacity	kW 69.0	76.5	81.5
	BTU/h 235,400	261,000	278,100
Input	kW 17.73	19.66	20.07

Indoor unit temperature correction

To be used to correct indoor unit capacity only

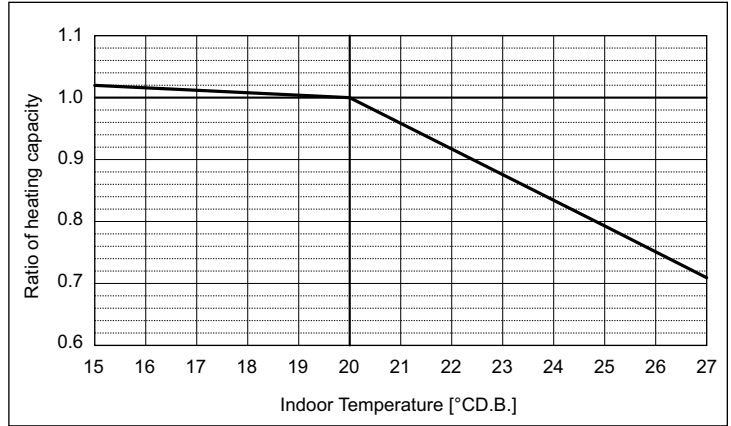

Y (HIGH COP)

Outdoor unit temperature correction

To be used to correct outdoor unit only

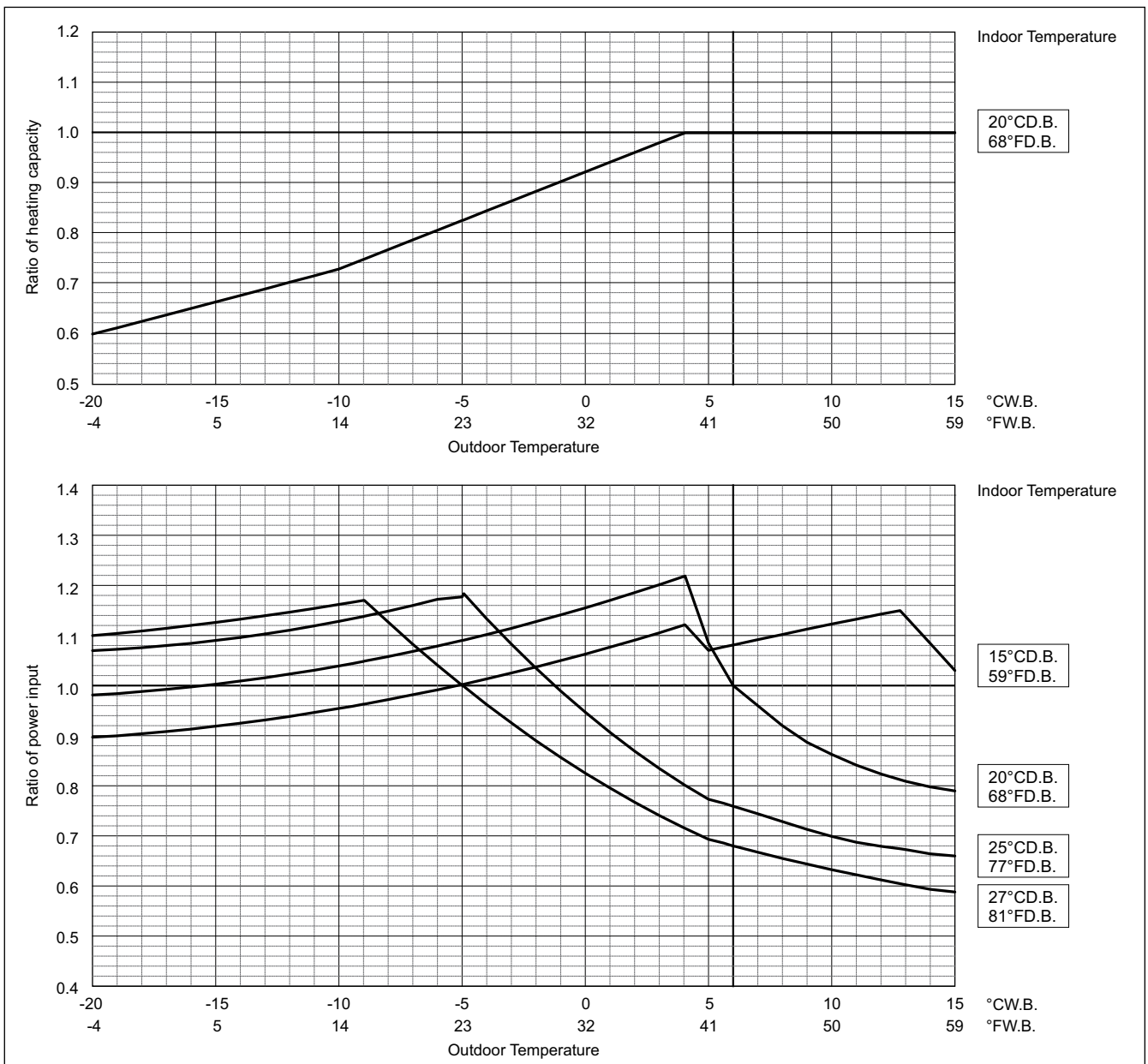

Outdoor unit power input is affected by the indoor and outdoor temperatures as shown in the graph above. Please consult the sales office for details.

PUHY-		EP700YSLM-A	EP750YSLM-A	EP800YSLM-A
Nominal Cooling Capacity	kW	80.0	85.0	90.0
	BTU/h	273,000	290,000	307,100
Input	kW	20.15	21.85	23.43

Indoor unit temperature correction

To be used to correct indoor unit capacity only

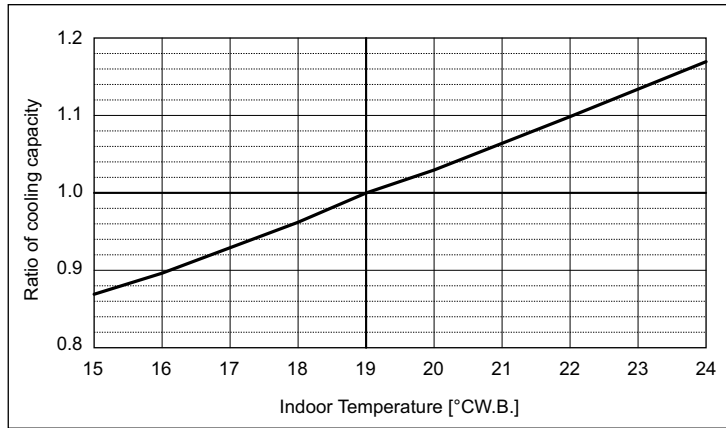

Outdoor unit temperature correction

To be used to correct outdoor unit only

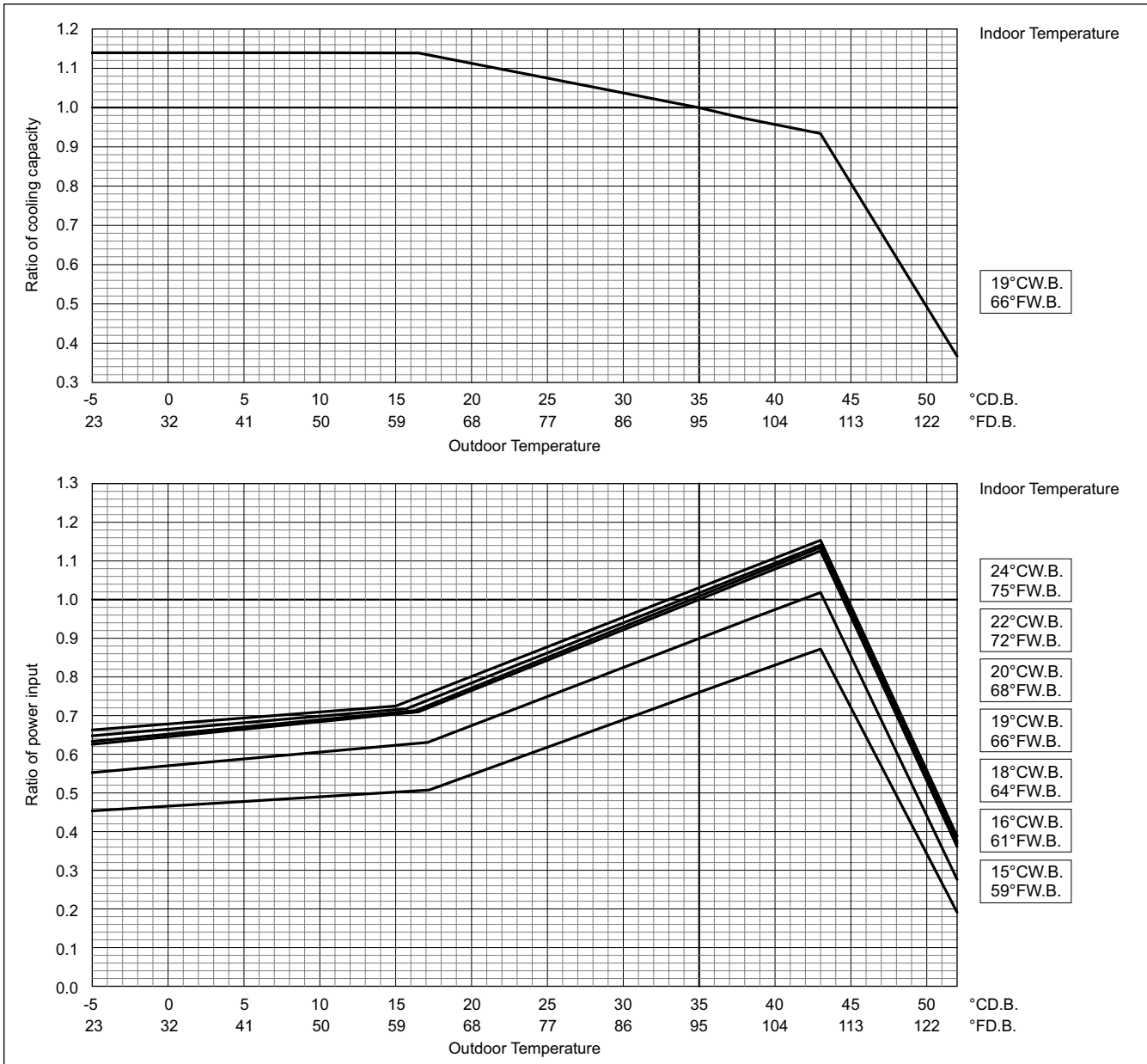

Outdoor unit power input is affected by the indoor and outdoor temperatures as shown in the graph above. Please consult the sales office for details.

PUHY-	EP700YSLM-A	EP750YSLM-A	EP800YSLM-A
Nominal Heating Capacity	kW 88.0	95.0	100.0
	BTU/h 300,300	324,100	341,200
Input	kW 21.67	23.92	25.18

Indoor unit temperature correction

To be used to correct indoor unit capacity only

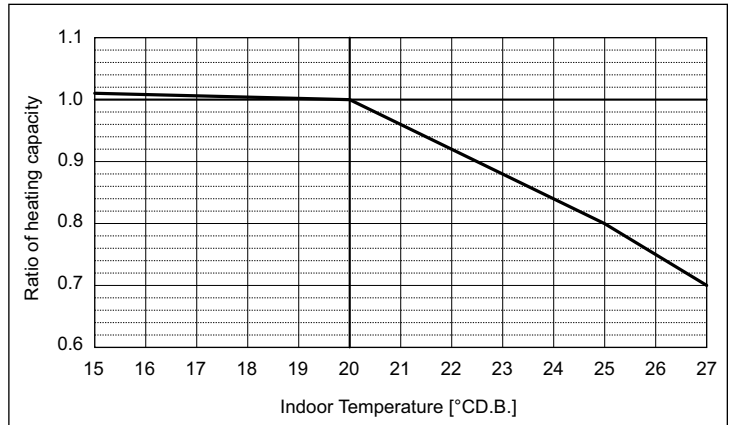

Y (HIGH COP)

Outdoor unit temperature correction

To be used to correct outdoor unit only

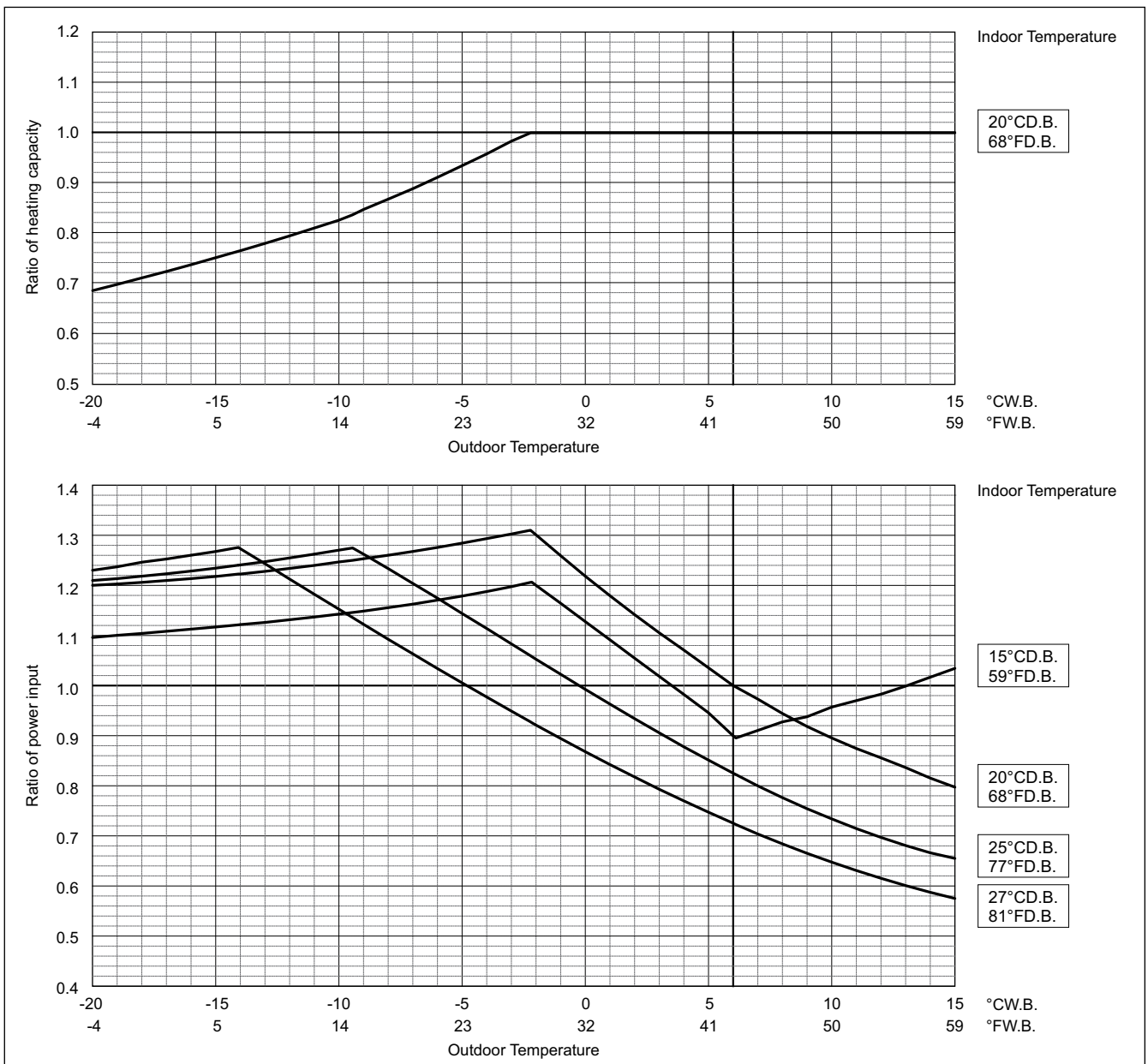

Outdoor unit power input is affected by the indoor and outdoor temperatures as shown in the graph above. Please consult the sales office for details.

Y (HIGH COP)

PUHY-		EP850YSLM-A	EP900YSLM-A	EP950YSLM-A
Nominal Cooling Capacity	kW	96.0	101.0	108.0
	BTU/h	327,600	344,600	368,500
Input	kW	25.53	27.22	30.33

PUHY-		EP1000YSLM-A	EP1050YSLM-A	EP1100YSLM-A
Nominal Cooling Capacity	kW	113.0	118.0	124.0
	BTU/h	385,600	402,600	423,100
Input	kW	31.04	34.40	38.15

PUHY-		EP1150YSLM-A	EP1200YSLM-A	EP1250YSLM-A
Nominal Cooling Capacity	kW	130.0	136.0	140.0
	BTU/h	443,600	464,000	477,700
Input	kW	41.53	42.76	45.90

PUHY-		EP1300YSLM-A	EP1350YSLM-A
Nominal Cooling Capacity	kW	146.0	150.0
	BTU/h	498,200	511,800
Input	kW	46.94	50.0

Indoor unit temperature correction
To be used to correct indoor unit capacity only

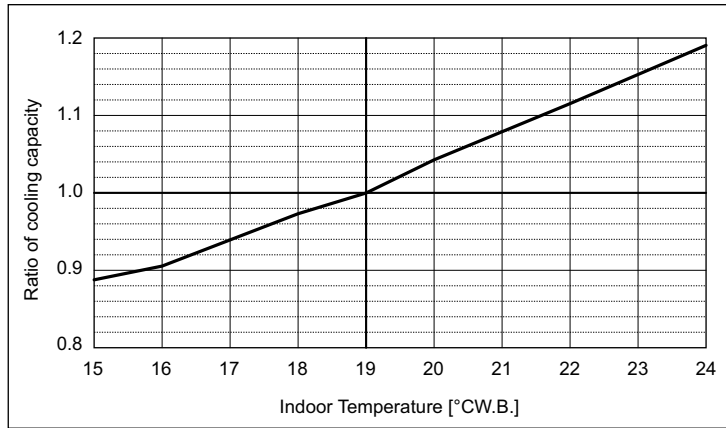

Outdoor unit temperature correction
To be used to correct outdoor unit only

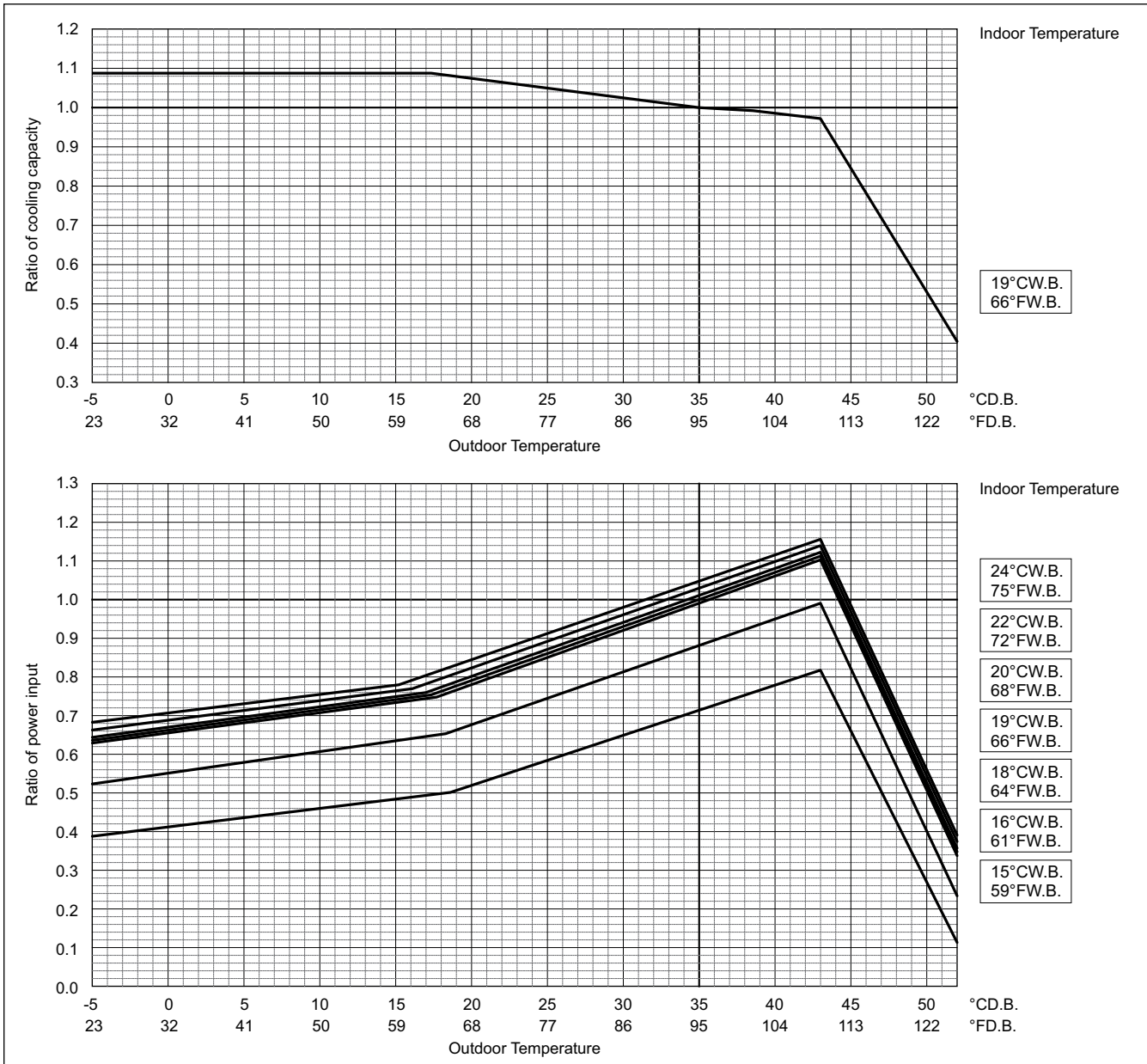

Outdoor unit power input is affected by the indoor and outdoor temperatures as shown in the graph above. Please consult the sales office for details.

PUHY-	EP850YSLM-A	EP900YSLM-A	EP950YSLM-A
Nominal Heating Capacity	kW 108.0	113.0	119.5
	BTU/h 368,500	385,600	407,700
Input	kW 27.76	29.04	32.03

PUHY-	EP1000YSLM-A	EP1050YSLM-A	EP1100YSLM-A
Nominal Heating Capacity	kW 127.0	132.0	140.0
	BTU/h 433,300	450,400	477,700
Input	kW 33.50	36.87	41.17

PUHY-	EP1150YSLM-A	EP1200YSLM-A	EP1250YSLM-A
Nominal Heating Capacity	kW 145.0	150.0	156.5
	BTU/h 494,700	511,800	534,000
Input	kW 44.47	45.45	49.36

PUHY-	EP1300YSLM-A	EP1350YSLM-A
Nominal Heating Capacity	kW 163.0	168.0
	BTU/h 556,200	573,200
Input	kW 50.62	54.36

Indoor unit temperature correction
To be used to correct indoor unit capacity only

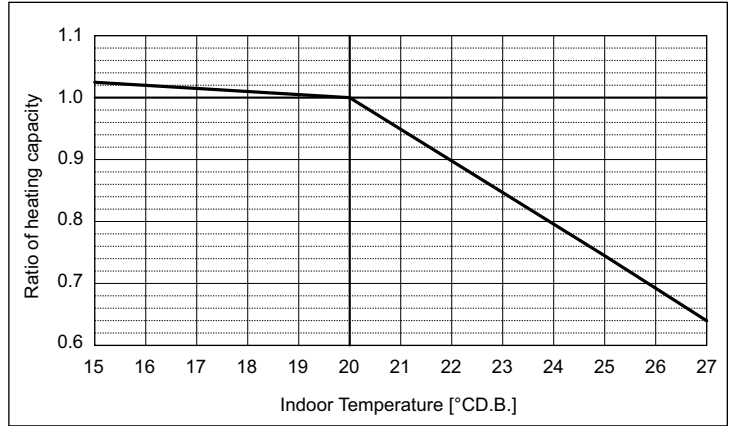

Outdoor unit temperature correction
To be used to correct outdoor unit only

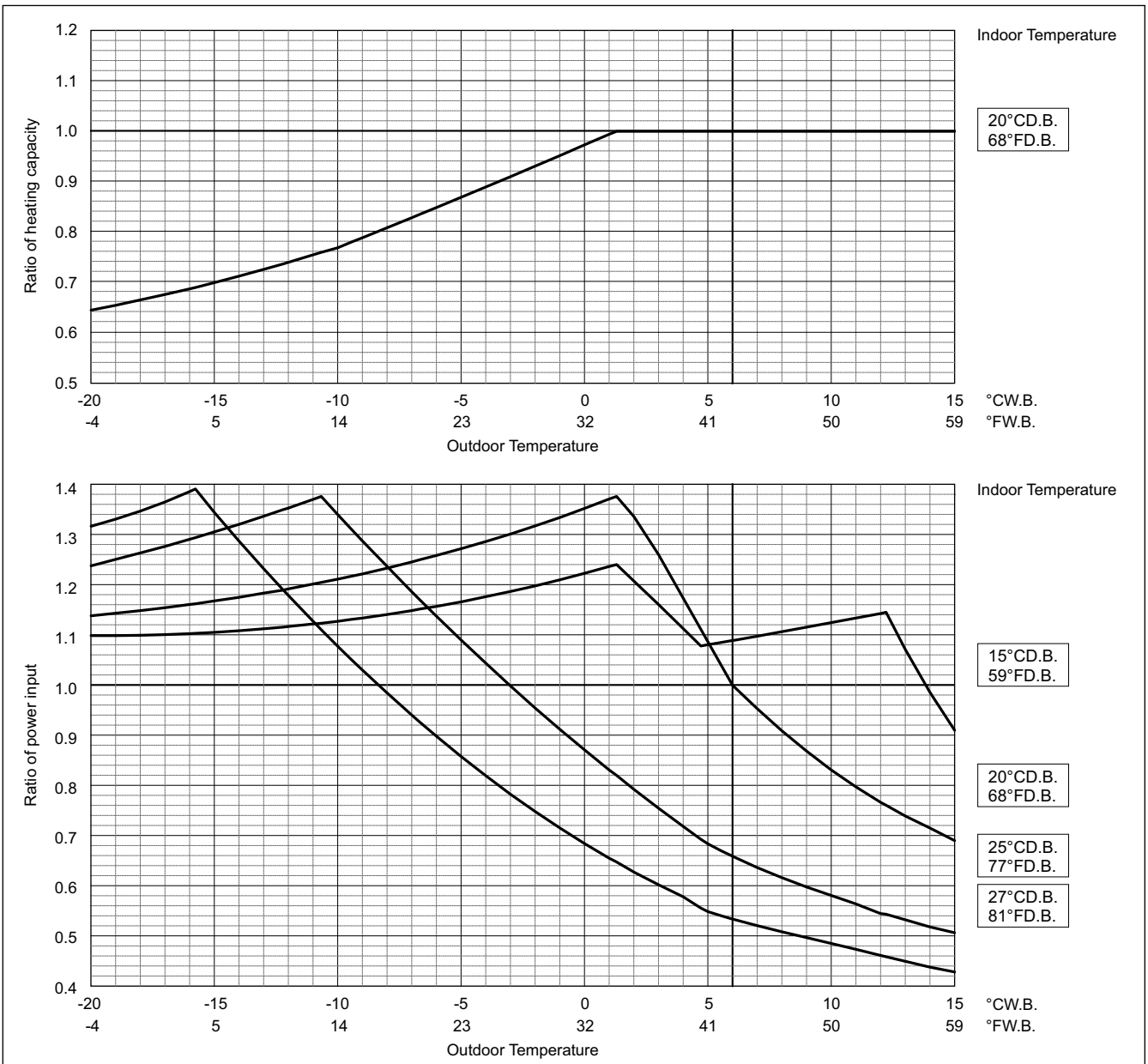

Outdoor unit power input is affected by the indoor and outdoor temperatures as shown in the graph above. Please consult the sales office for details.

Y (HIGH COP)

Correction by temperature (COP Priority Mode)

CITY MULTI could have various capacities at different designing temperatures. Using the nominal cooling/heating capacity values and the ratios below, the capacity can be found for various temperatures. To select COP priority mode, DipSW 6-2 must be set to ON.

PUHY-		EP200YLM-A	EP250YLM-A
Nominal Cooling Capacity	kW	22.4	28.0
	BTU/h	76,400	95,500
Input	kW	5.19	6.89

Y (HIGH COP)

Indoor unit temperature correction

To be used to correct indoor unit capacity only

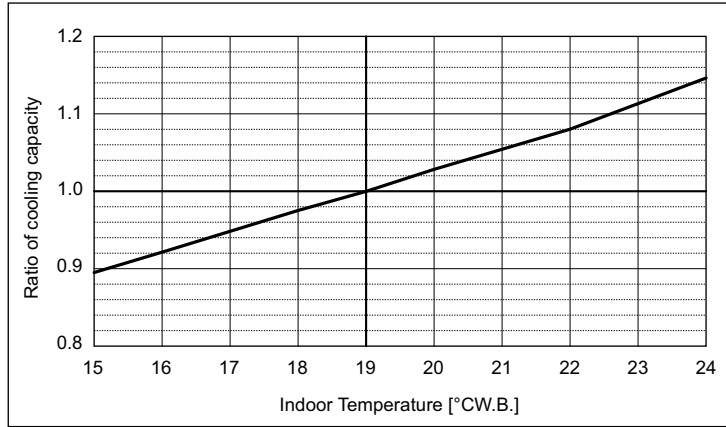

Outdoor unit temperature correction

To be used to correct outdoor unit only

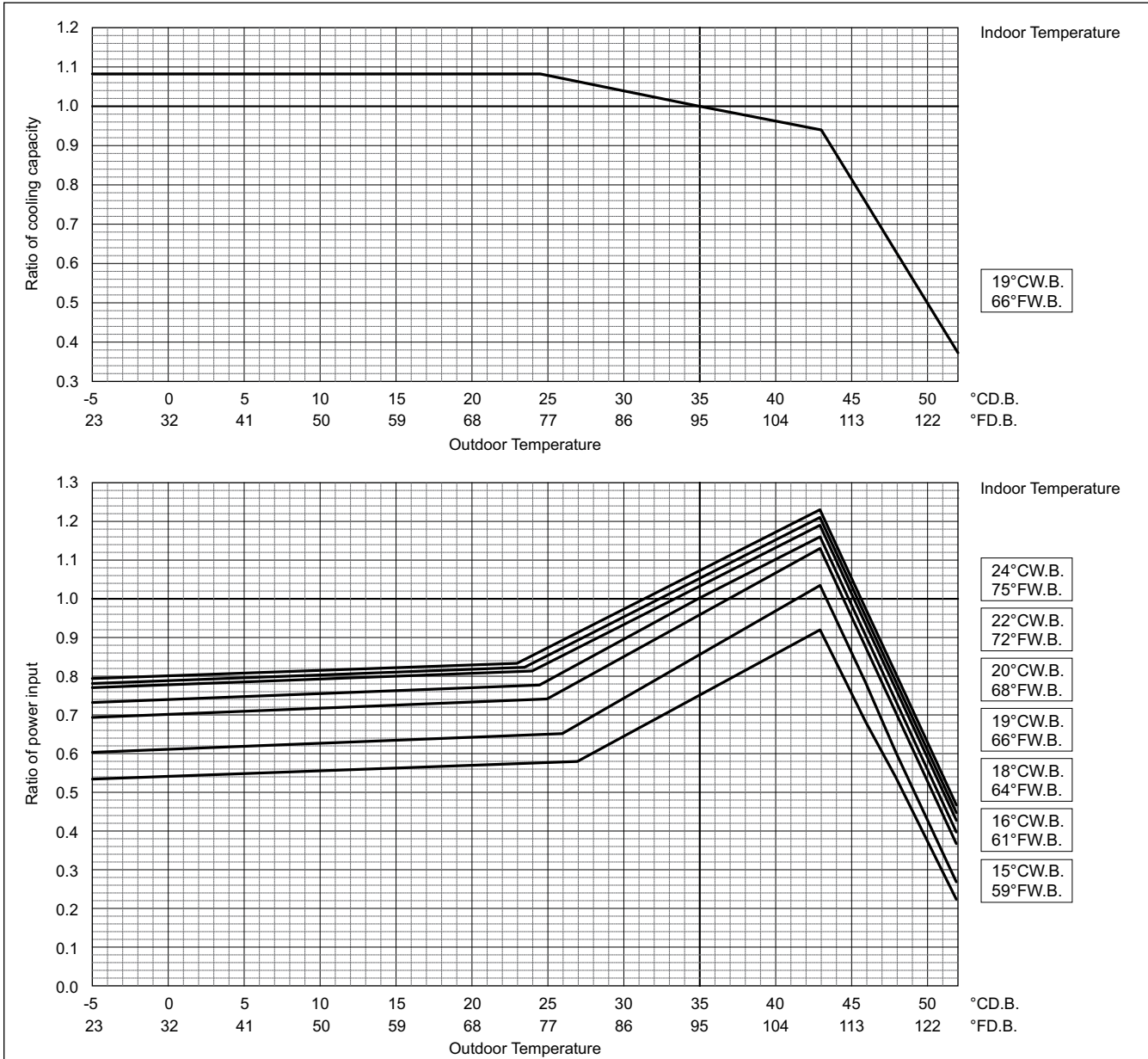

Outdoor unit power input is affected by the indoor and outdoor temperatures as shown in the graph above. Please consult the sales office for details.

PUHY-	EP200YLM-A	EP250YLM-A
Nominal Heating Capacity	kW 25.0	31.5
	BTU/h 85,300	107,500
Input	kW 5.73	7.68

Indoor unit temperature correction

To be used to correct indoor unit capacity only

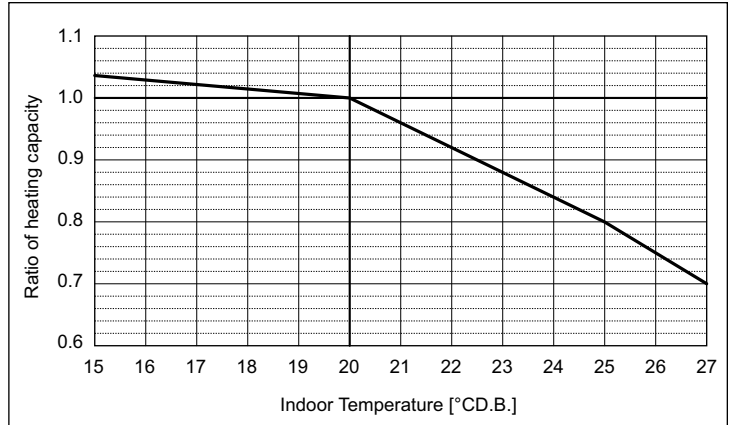

Y (HIGH COP)

Outdoor unit temperature correction

To be used to correct outdoor unit only

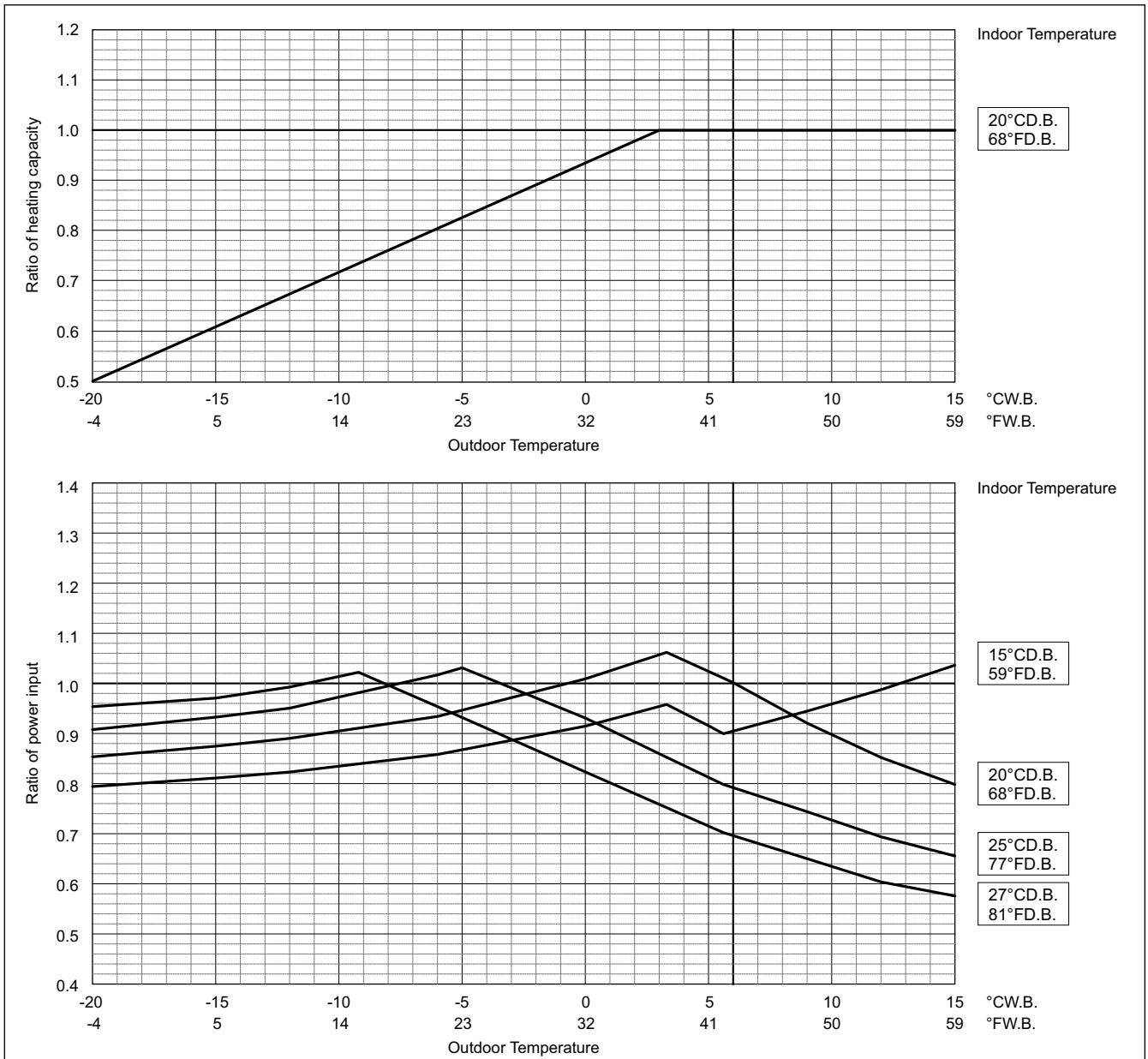

Outdoor unit power input is affected by the indoor and outdoor temperatures as shown in the graph above. Please consult the sales office for details.

Y (HIGH COP)

PUHY-	EP300YLM-A	EP350YLM-A
Nominal Cooling Capacity kW	33.5	40.0
Nominal Cooling Capacity BTU/h	114,300	136,500
Input kW	8.56	11.69

Indoor unit temperature correction

To be used to correct indoor unit capacity only

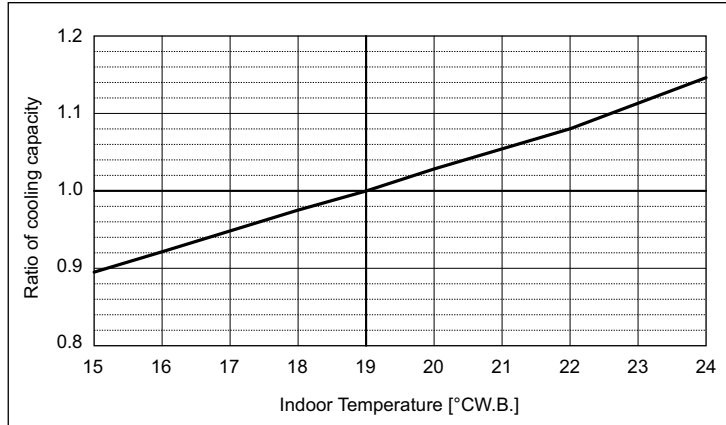

Outdoor unit temperature correction

To be used to correct outdoor unit only

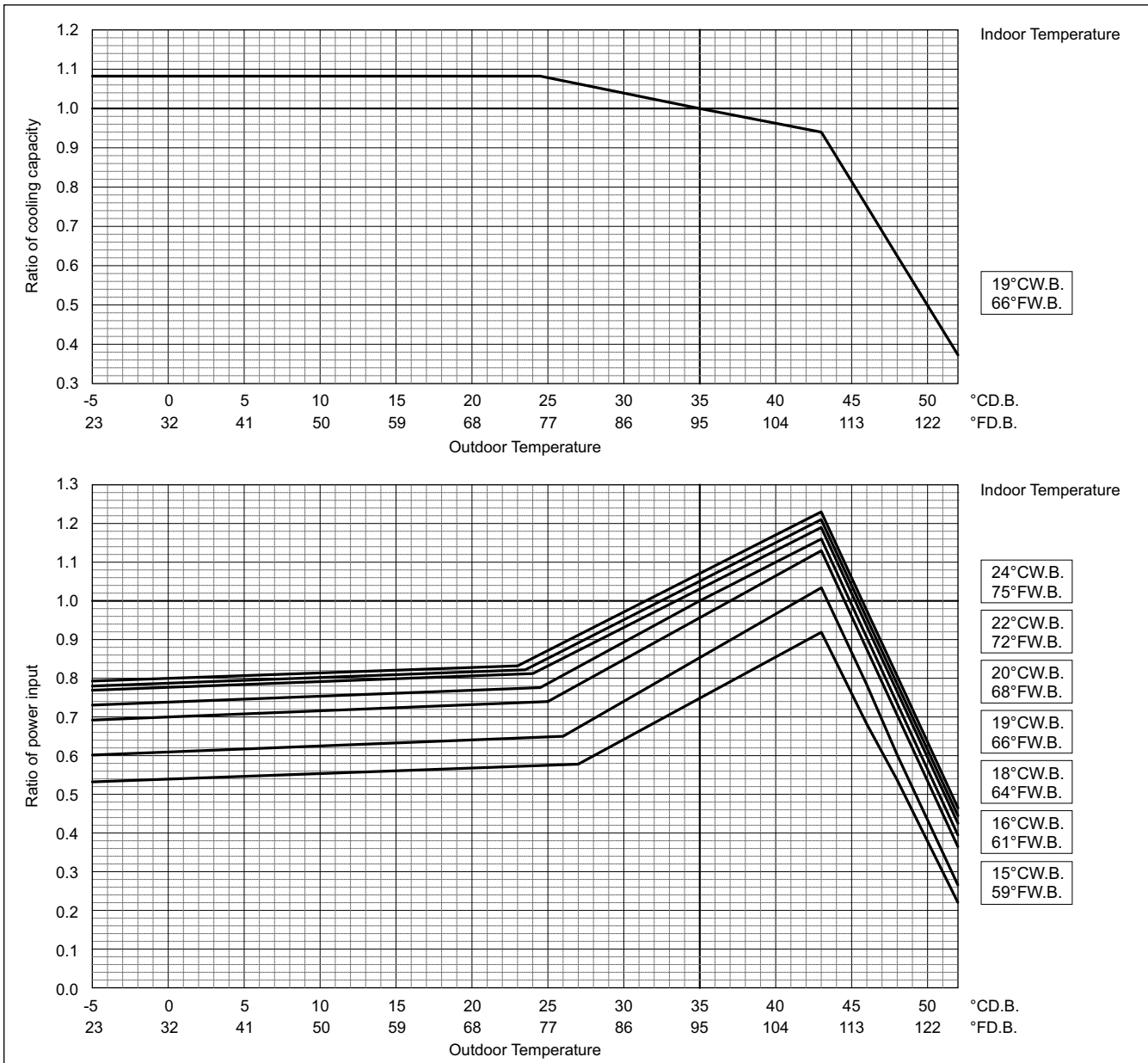

Outdoor unit power input is affected by the indoor and outdoor temperatures as shown in the graph above. Please consult the sales office for details.

PUHY-	EP300YLM-A	EP350YLM-A
Nominal Heating Capacity	kW 37.5	45.0
	BTU/h 128,000	153,500
Input	kW 9.16	12.53

Indoor unit temperature correction

To be used to correct indoor unit capacity only

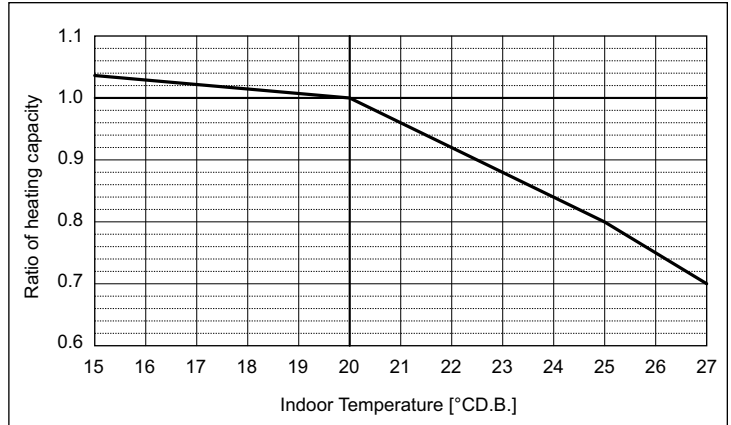

Y (HIGH COP)

Outdoor unit temperature correction

To be used to correct outdoor unit only

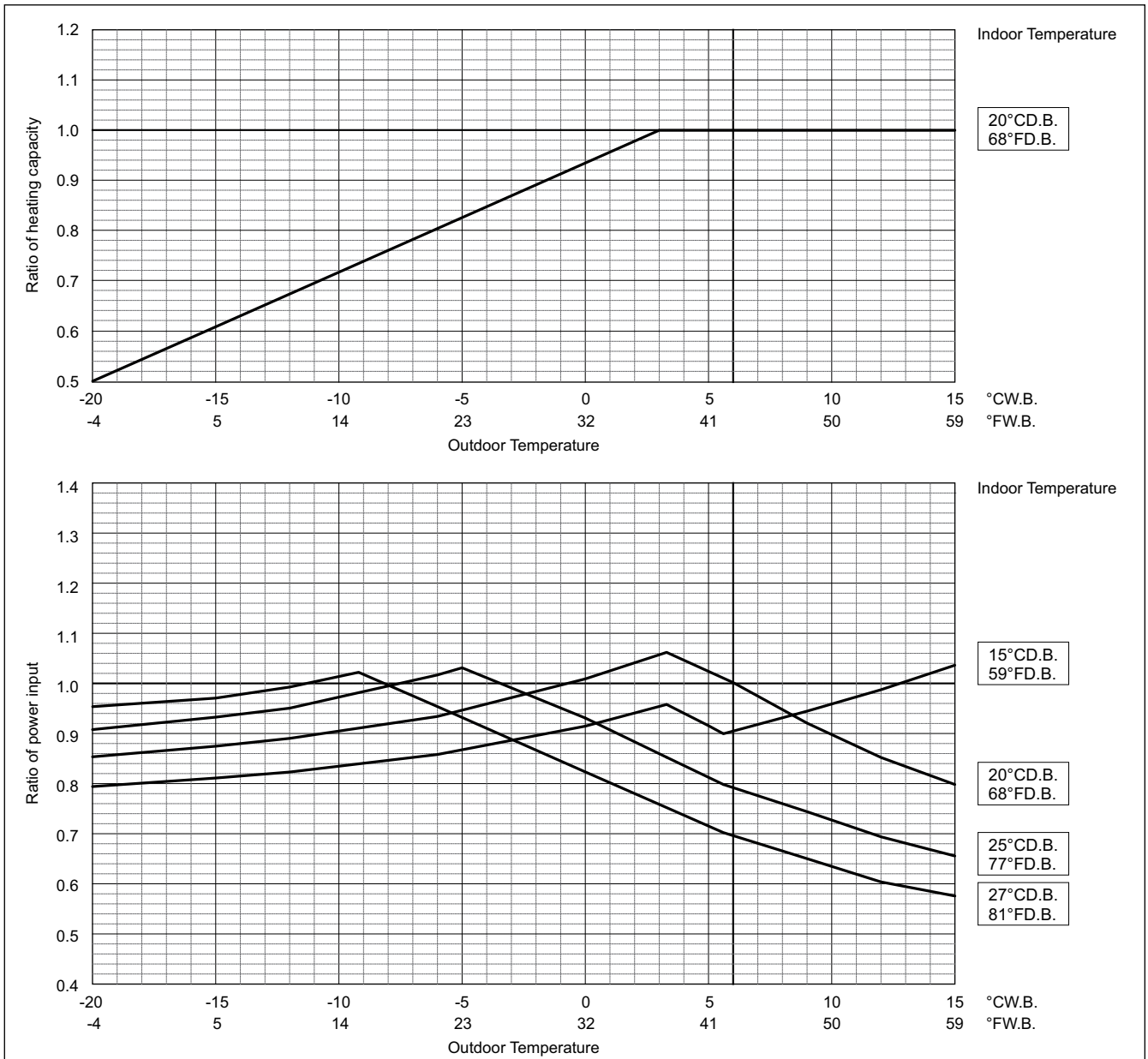

Outdoor unit power input is affected by the indoor and outdoor temperatures as shown in the graph above. Please consult the sales office for details.

8. CAPACITY TABLES

Y (HIGH COP)

PUHY-	EP400YLM-A	EP450YLM-A	EP500YLM-A	
Nominal Cooling Capacity	kW	45.0	50.0	56.0
	BTU/h	153,500	170,600	191,100
Input	kW	12.26	14.79	18.72

Indoor unit temperature correction

To be used to correct indoor unit capacity only

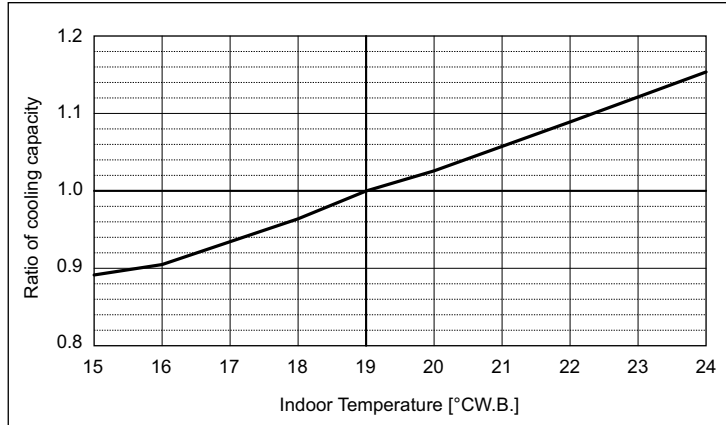

Outdoor unit temperature correction

To be used to correct outdoor unit only

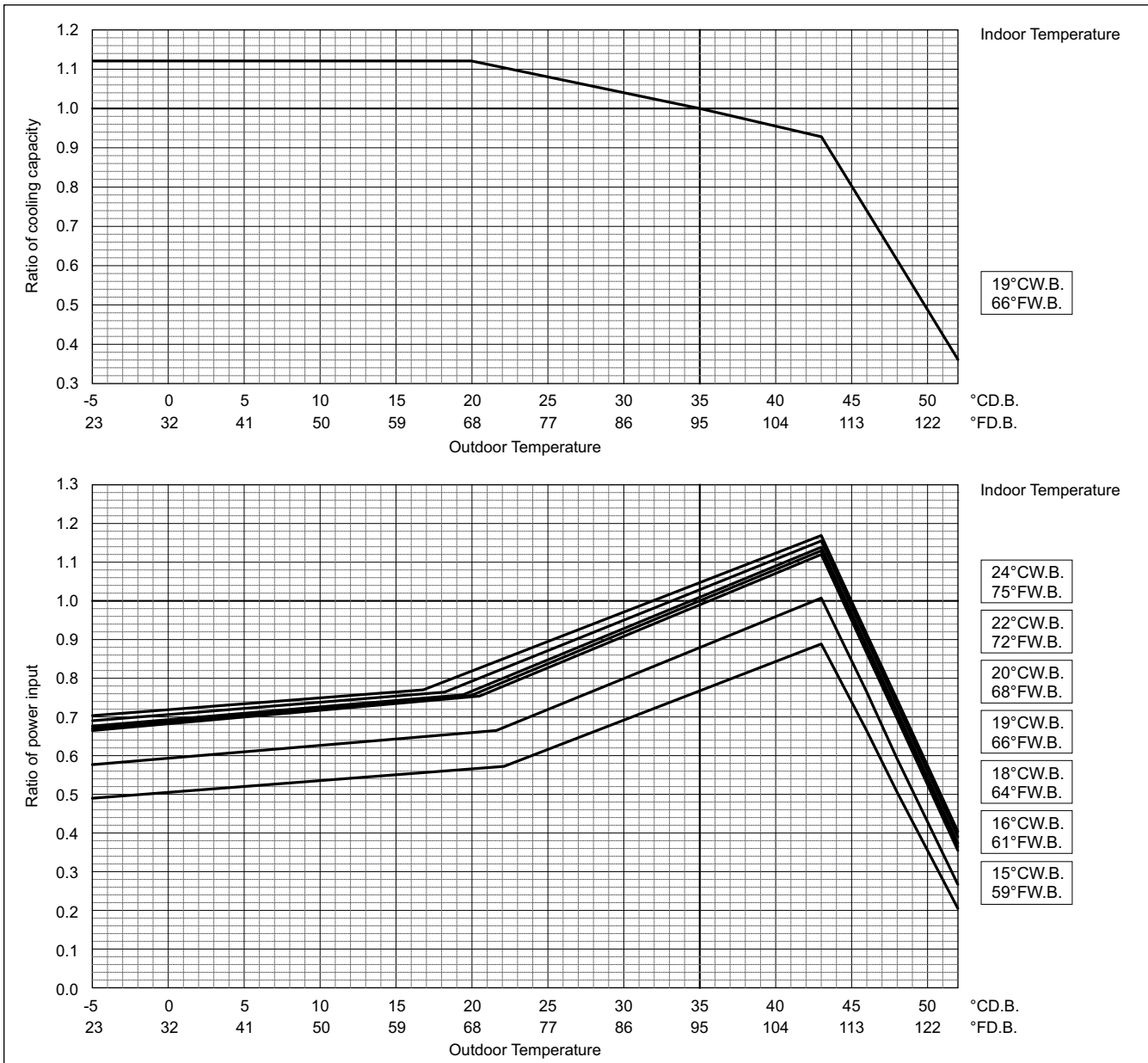

Outdoor unit power input is affected by the indoor and outdoor temperatures as shown in the graph above. Please consult the sales office for details.

PUHY-	EP400YLM-A	EP450YLM-A	EP500YLM-A
Nominal Heating Capacity	kW 50.0	56.0	63.0
	BTU/h 170,600	191,100	215,000
Input	kW 13.15	16.09	19.68

Indoor unit temperature correction

To be used to correct indoor unit capacity only

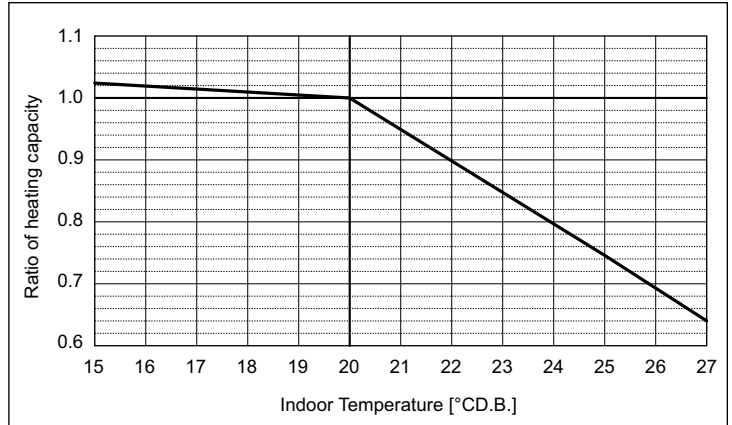

Y (HIGH COP)

Outdoor unit temperature correction

To be used to correct outdoor unit only

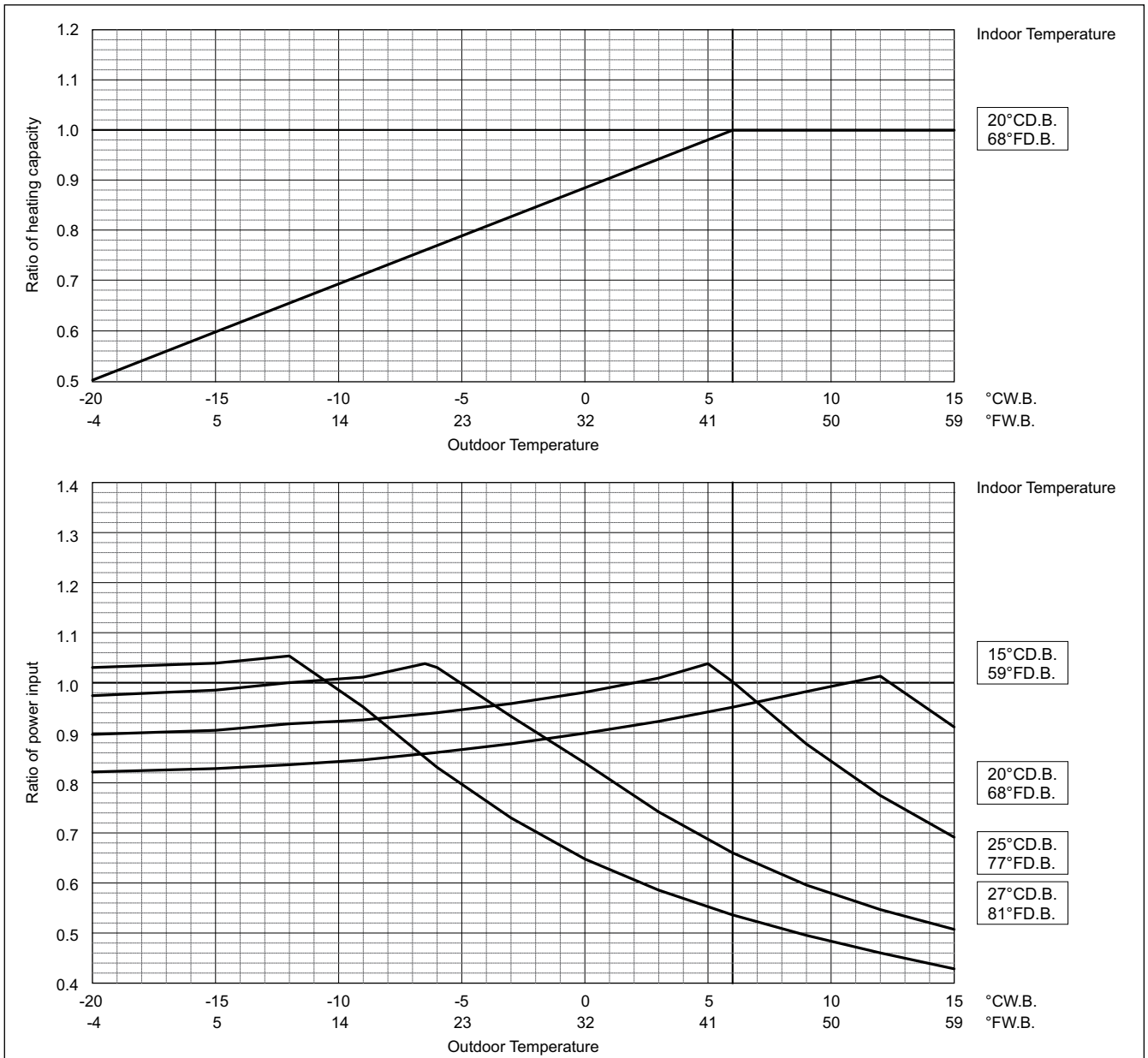

Outdoor unit power input is affected by the indoor and outdoor temperatures as shown in the graph above. Please consult the sales office for details.

8. CAPACITY TABLES

Y (HIGH COP)

PUHY-	EP550YSLM-A	EP600YSLM-A	EP650YSLM-A
Nominal Cooling Capacity	63.0	69.0	73.0
	BTU/h	235,400	249,100
Input	16.62	18.59	18.15
	kW		

Indoor unit temperature correction

To be used to correct indoor unit capacity only

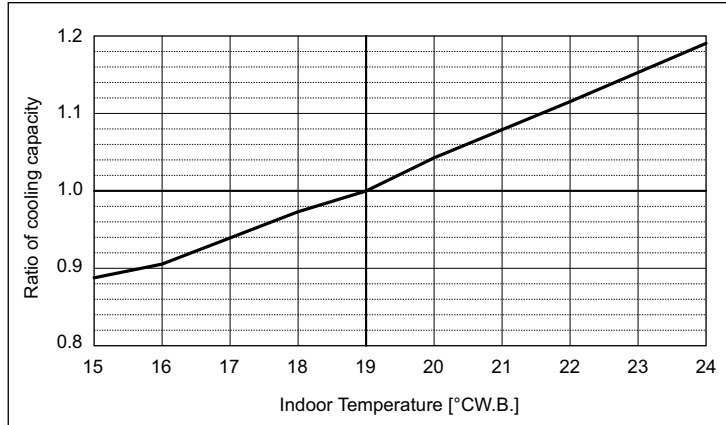

Outdoor unit temperature correction

To be used to correct outdoor unit only

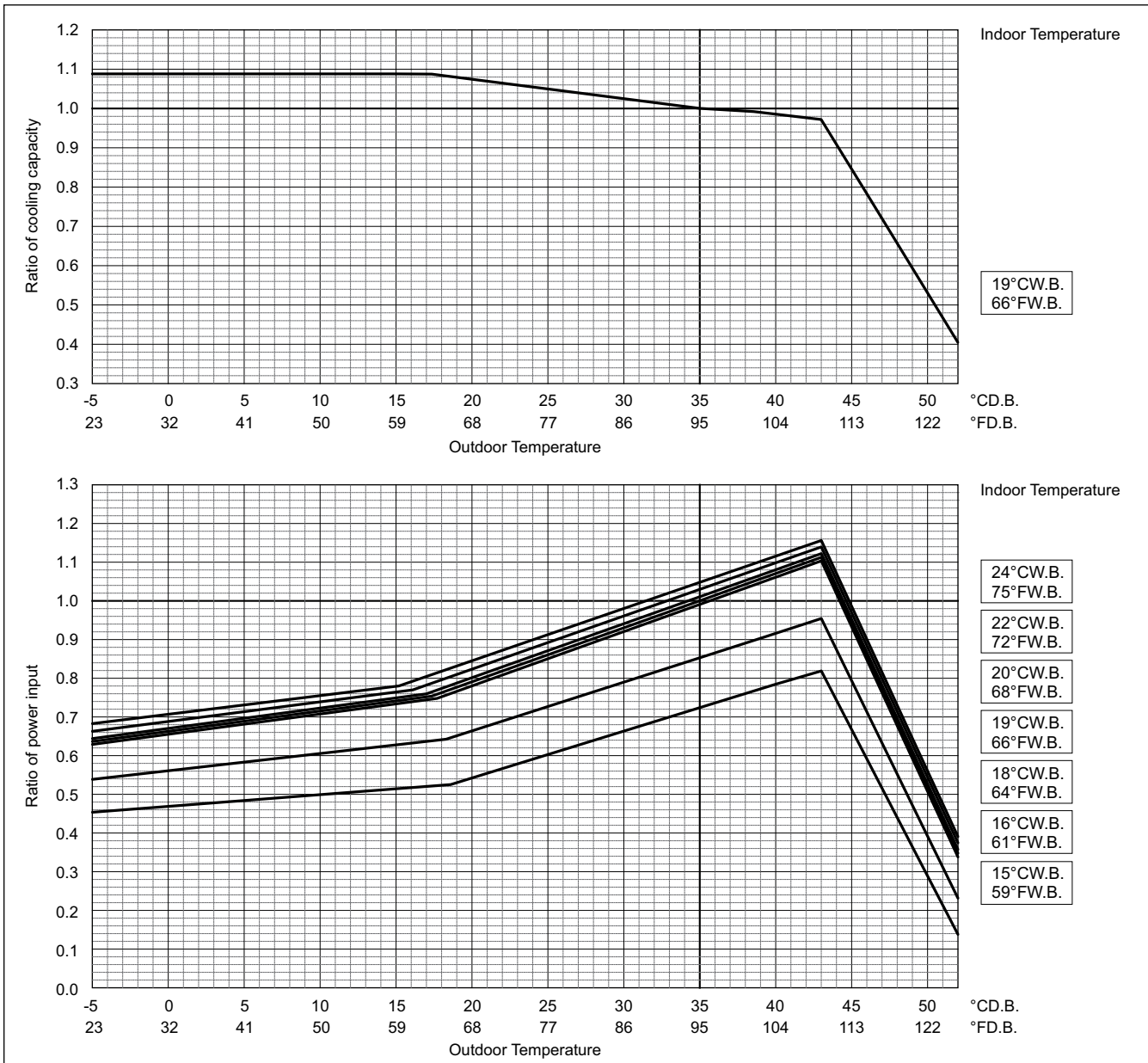

Outdoor unit power input is affected by the indoor and outdoor temperatures as shown in the graph above. Please consult the sales office for details.

PUHY-		EP550YSLM-A	EP600YSLM-A	EP650YSLM-A
Nominal Heating Capacity	kW	69.0	76.5	81.5
	BTU/h	235,400	261,000	278,100
Input	kW	17.73	19.66	20.07

Indoor unit temperature correction

To be used to correct indoor unit capacity only

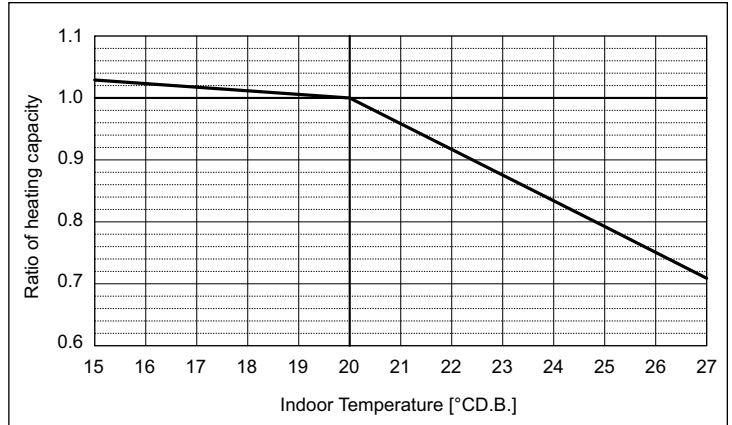

Outdoor unit temperature correction

To be used to correct outdoor unit only

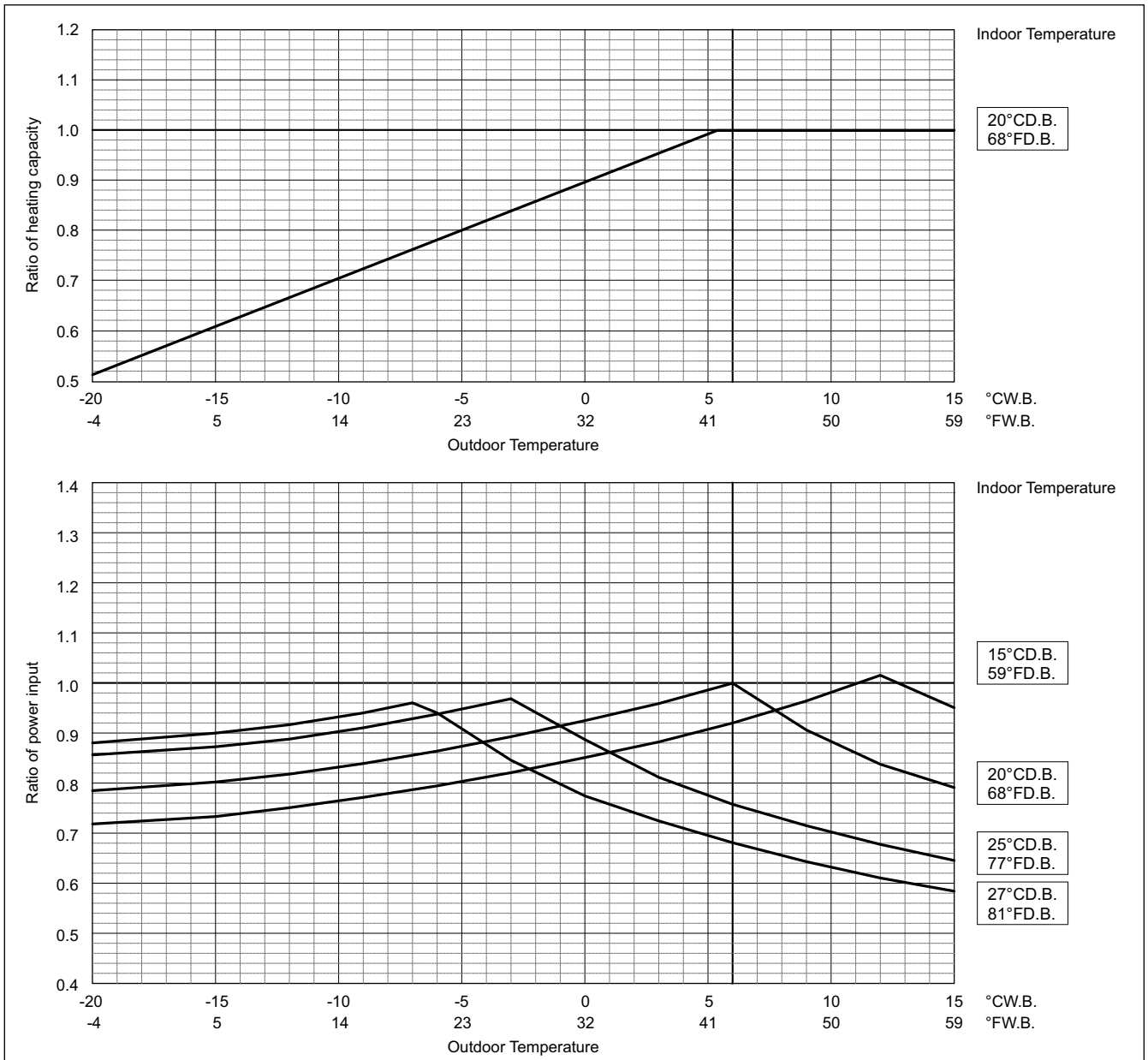

Outdoor unit power input is affected by the indoor and outdoor temperatures as shown in the graph above. Please consult the sales office for details.

Y (HIGH COP)

Y (HIGH COP)

PUHY-	EP700YSLM-A	EP750YSLM-A	EP800YSLM-A
Nominal Cooling Capacity	80.0	85.0	90.0
BTU/h	273,000	290,000	307,100
Input	20.15	21.85	23.43
kW			

Indoor unit temperature correction

To be used to correct indoor unit capacity only

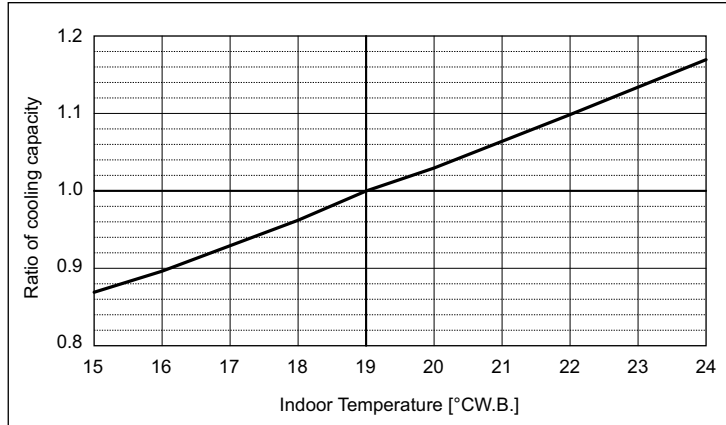

Outdoor unit temperature correction

To be used to correct outdoor unit only

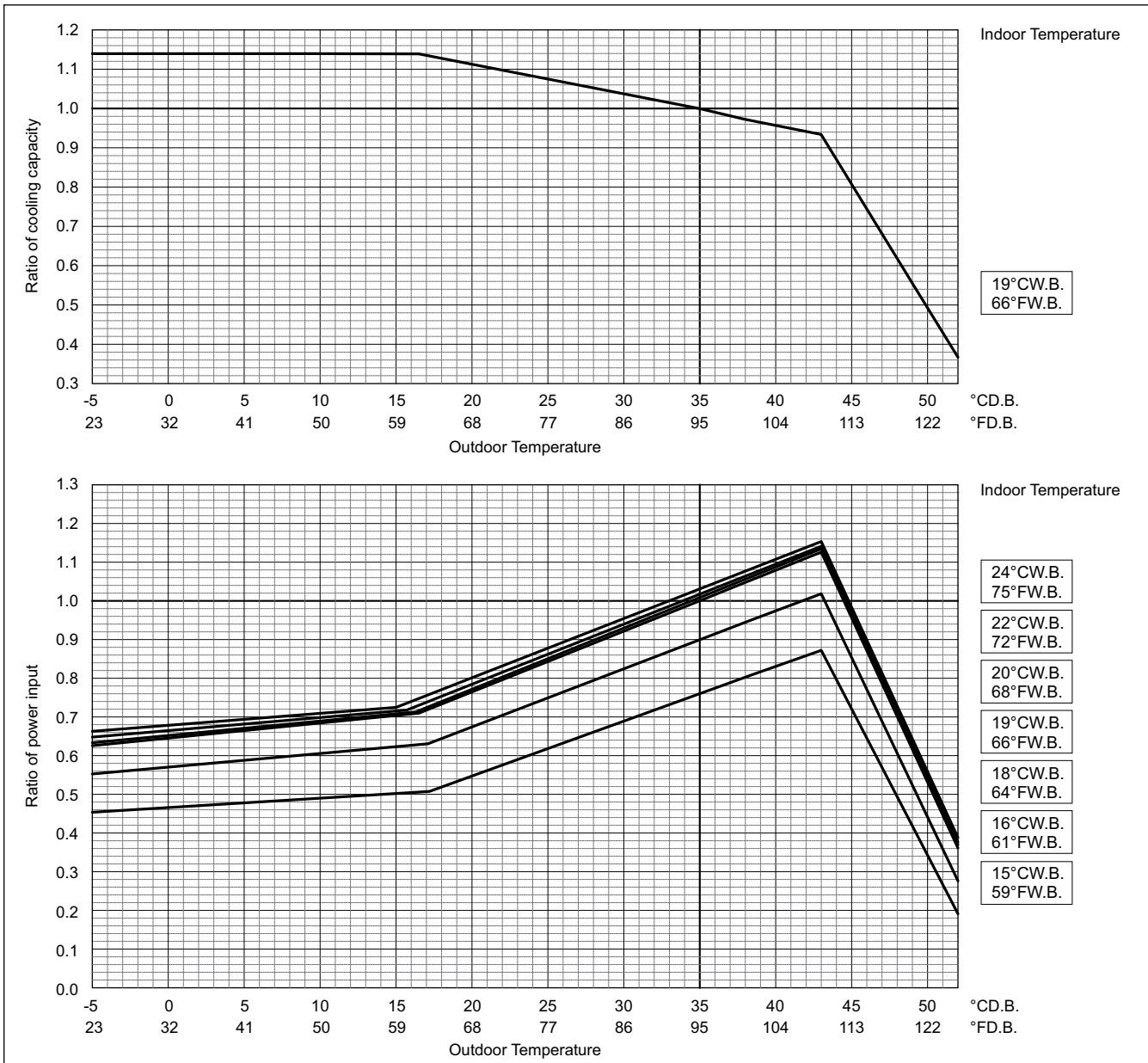

Outdoor unit power input is affected by the indoor and outdoor temperatures as shown in the graph above. Please consult the sales office for details.

PUHY-	EP700YSLM-A	EP750YSLM-A	EP800YSLM-A
Nominal Heating Capacity	kW 88.0	95.0	100.0
	BTU/h 300,300	324,100	341,200
Input	kW 21.67	23.92	25.18

Indoor unit temperature correction

To be used to correct indoor unit capacity only

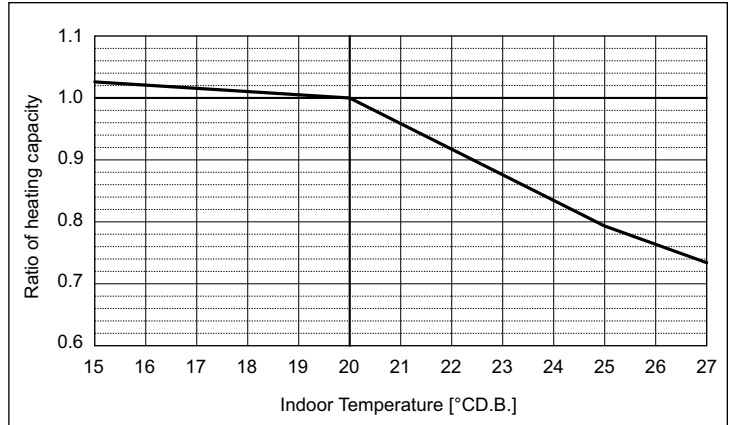

Outdoor unit temperature correction

To be used to correct outdoor unit only

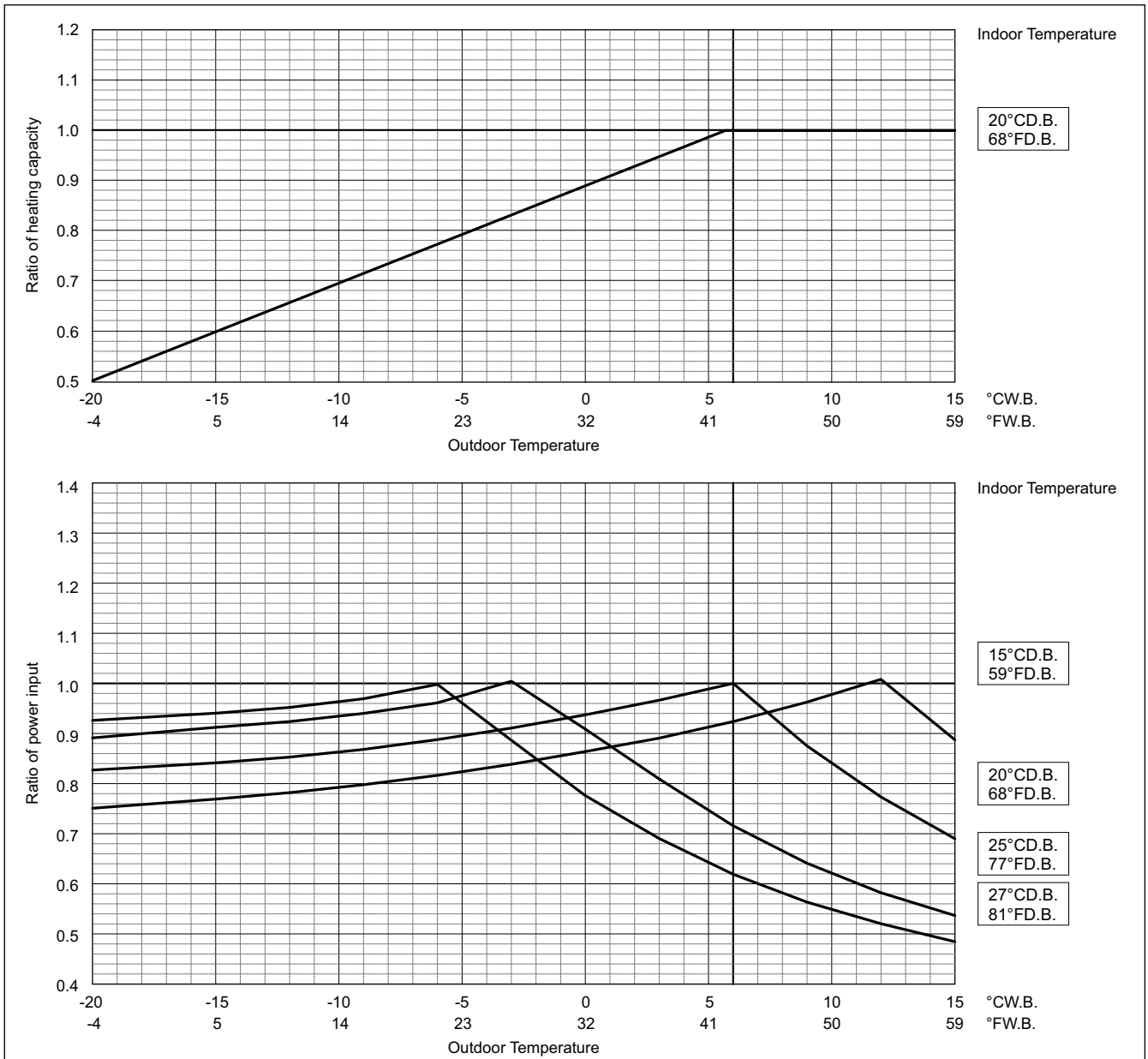

Outdoor unit power input is affected by the indoor and outdoor temperatures as shown in the graph above. Please consult the sales office for details.

Y (HIGH COP)

8. CAPACITY TABLES

Y (HIGH COP)

PUHY-		EP850YSLM-A	EP900YSLM-A	EP950YSLM-A
Nominal Cooling Capacity	kW	96.0	101.0	108.0
	BTU/h	327,600	344,600	368,500
Input	kW	25.53	27.22	30.33

PUHY-		EP1000YSLM-A	EP1050YSLM-A	EP1100YSLM-A
Nominal Cooling Capacity	kW	113.0	118.0	124.0
	BTU/h	385,600	402,600	423,100
Input	kW	31.04	34.40	38.15

PUHY-		EP1150YSLM-A	EP1200YSLM-A	EP1250YSLM-A
Nominal Cooling Capacity	kW	130.0	136.0	140.0
	BTU/h	443,600	464,000	477,700
Input	kW	41.53	42.76	45.90

PUHY-		EP1300YSLM-A	EP1350YSLM-A
Nominal Cooling Capacity	kW	146.0	150.0
	BTU/h	498,200	511,800
Input	kW	46.94	50.0

Indoor unit temperature correction

To be used to correct indoor unit capacity only

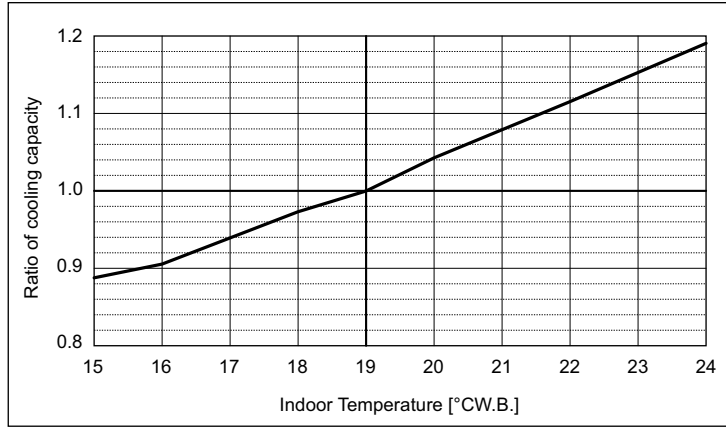

Outdoor unit temperature correction

To be used to correct outdoor unit only

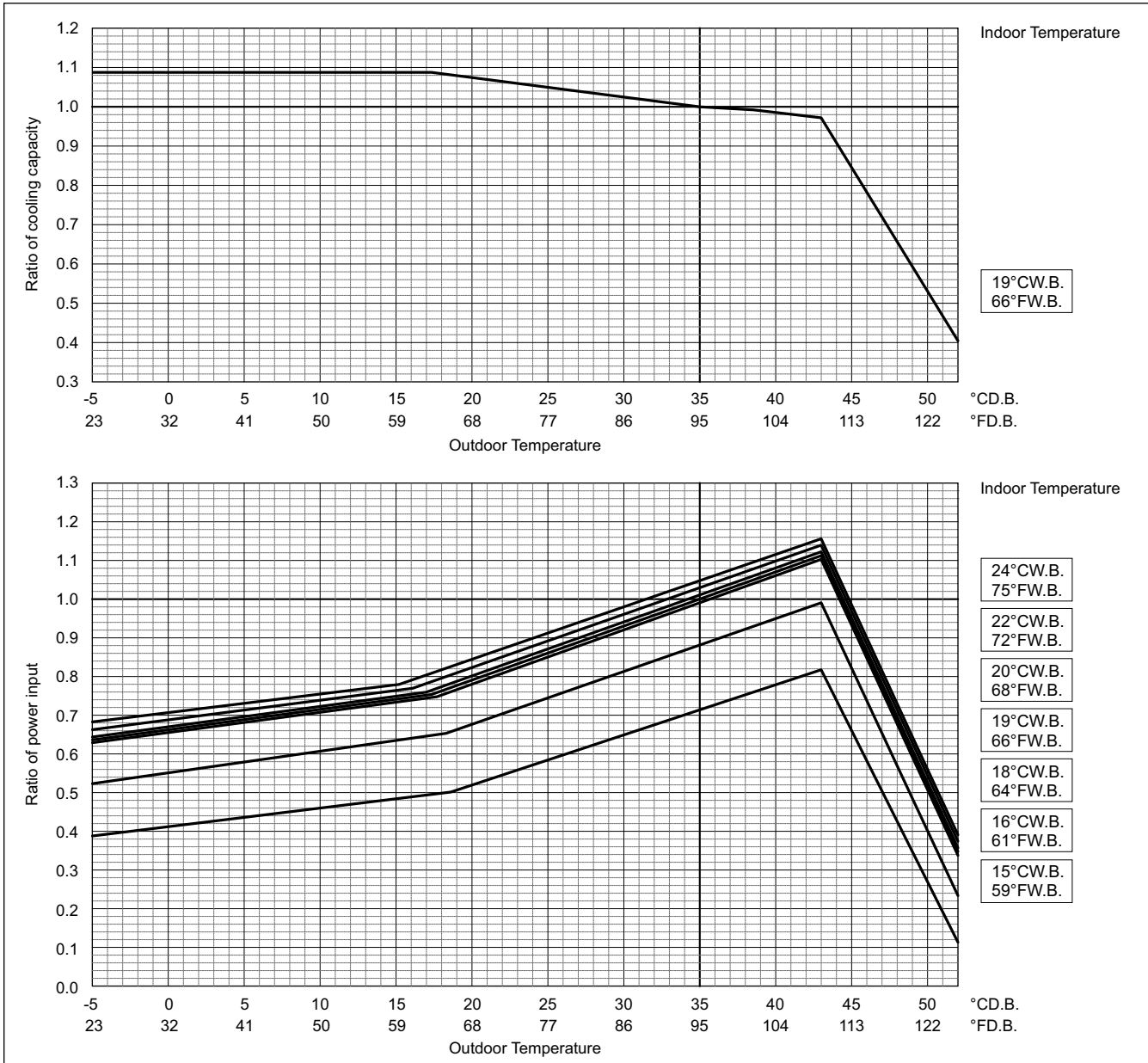

Outdoor unit power input is affected by the indoor and outdoor temperatures as shown in the graph above. Please consult the sales office for details.

PUHY-	EP850YSLM-A	EP900YSLM-A	EP950YSLM-A
Nominal Heating Capacity	kW 108.0	113.0	119.5
	BTU/h 368,500	385,600	407,700
Input	kW 27.76	29.04	32.03

PUHY-	EP1000YSLM-A	EP1050YSLM-A	EP1100YSLM-A
Nominal Heating Capacity	kW 127.0	132.0	140.0
	BTU/h 433,300	450,400	477,700
Input	kW 33.50	36.87	41.17

PUHY-	EP1150YSLM-A	EP1200YSLM-A	EP1250YSLM-A
Nominal Heating Capacity	kW 145.0	150.0	156.5
	BTU/h 494,700	511,800	534,000
Input	kW 44.47	45.45	49.36

PUHY-	EP1300YSLM-A	EP1350YSLM-A
Nominal Heating Capacity	kW 163.0	168.0
	BTU/h 556,200	573,200
Input	kW 50.62	54.36

Indoor unit temperature correction
To be used to correct indoor unit capacity only

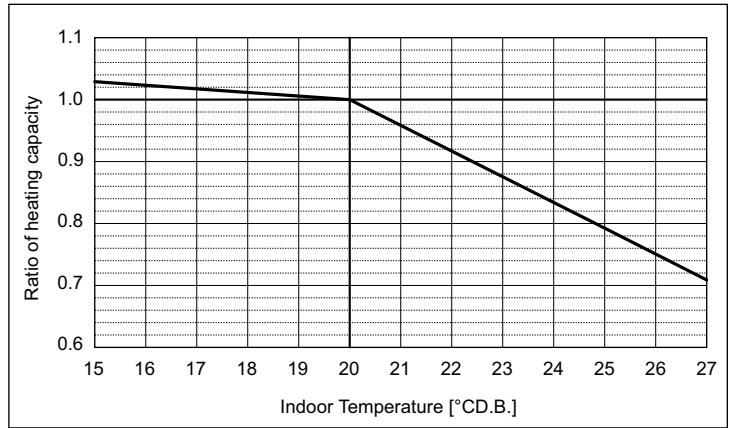

Outdoor unit temperature correction
To be used to correct outdoor unit only

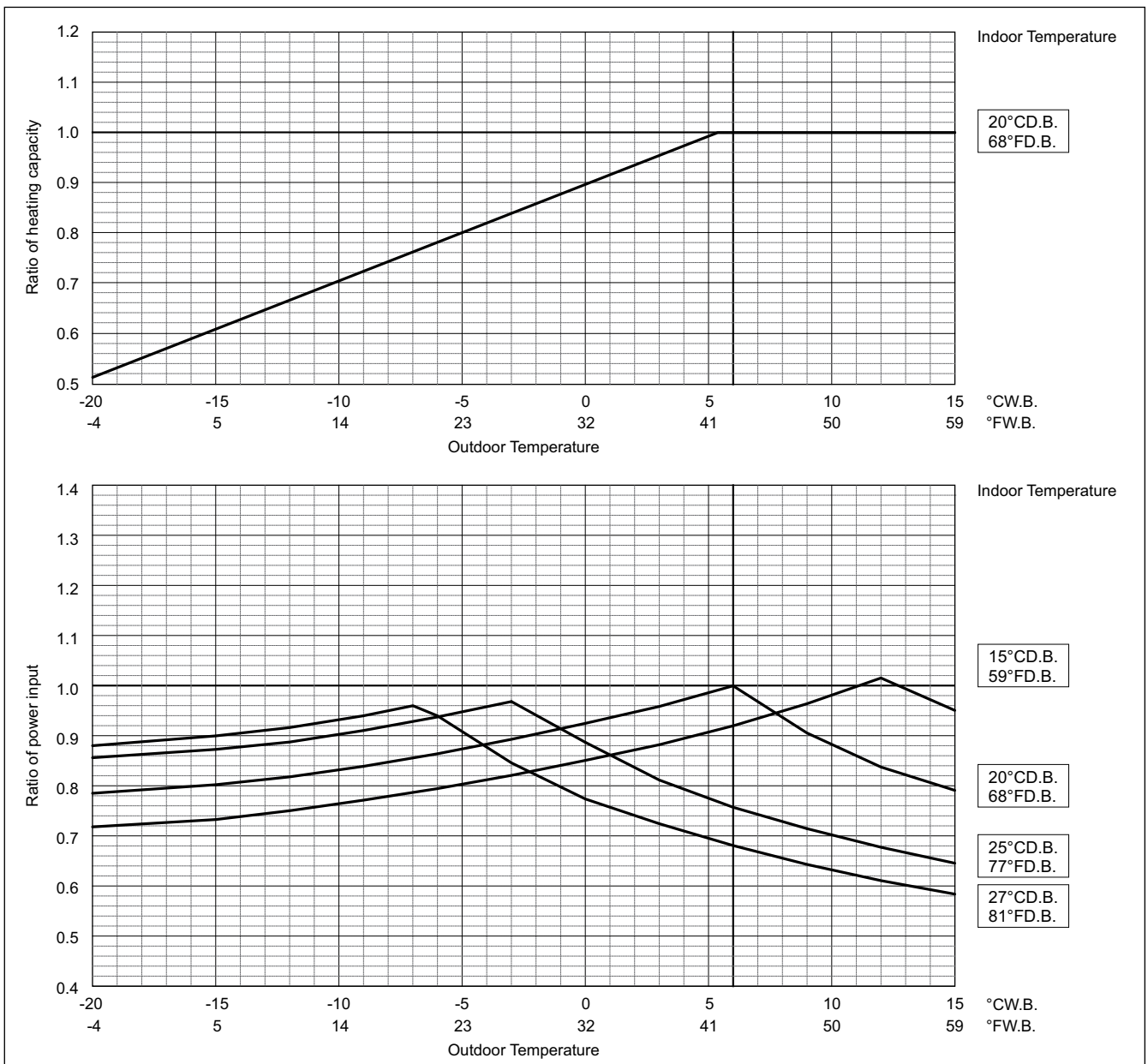

Outdoor unit power input is affected by the indoor and outdoor temperatures as shown in the graph above. Please consult the sales office for details.

Y (HIGH COP)

8-3. Correction by total indoor

CITY MULTI system have different capacities and inputs when many combinations of indoor units with different total capacities are connected. Using following tables, the maximum capacity can be found to ensure the system is installed with enough capacity for a particular application.

Y (HIGH COP)

PUHY-EP200YLM-A		
Nominal Cooling Capacity	kW	22.4
	BTU/h	76,400
Input	kW	5.19

PUHY-EP200YLM-A		
Nominal Heating Capacity	kW	25.0
	BTU/h	85,300
Input	kW	5.73

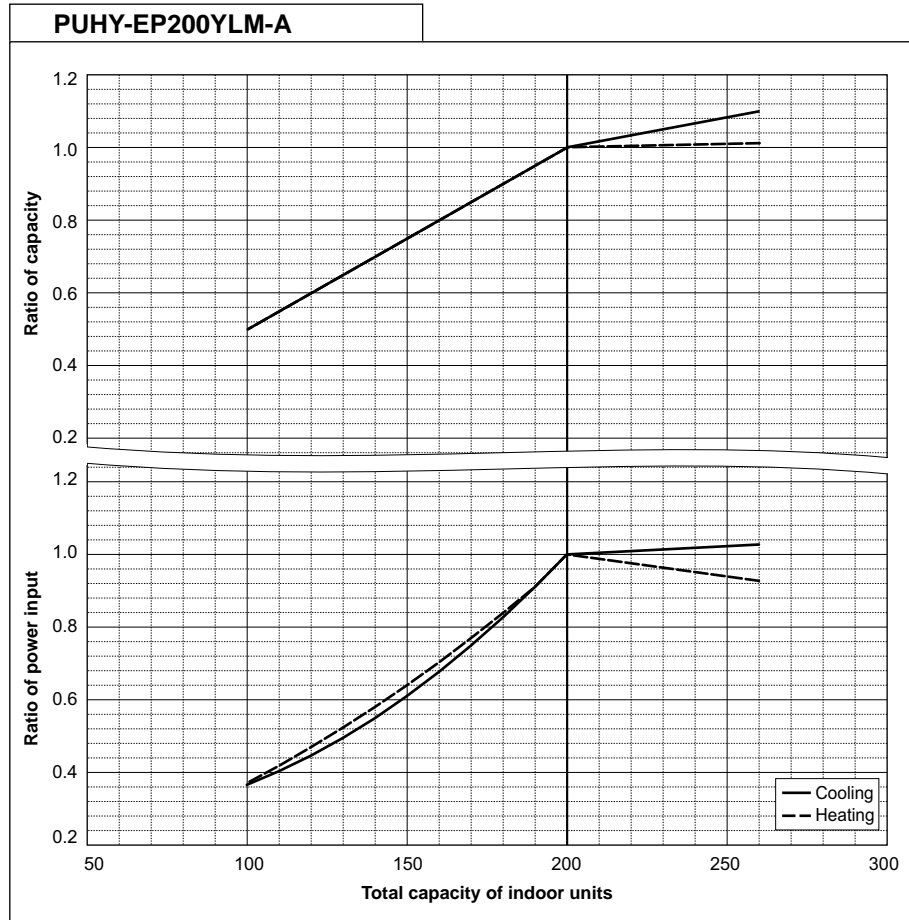

PUHY-EP250YLM-A		
Nominal Cooling Capacity	kW	28.0
	BTU/h	95,500
Input	kW	6.89

PUHY-EP250YLM-A		
Nominal Heating Capacity	kW	31.5
	BTU/h	107,500
Input	kW	7.68

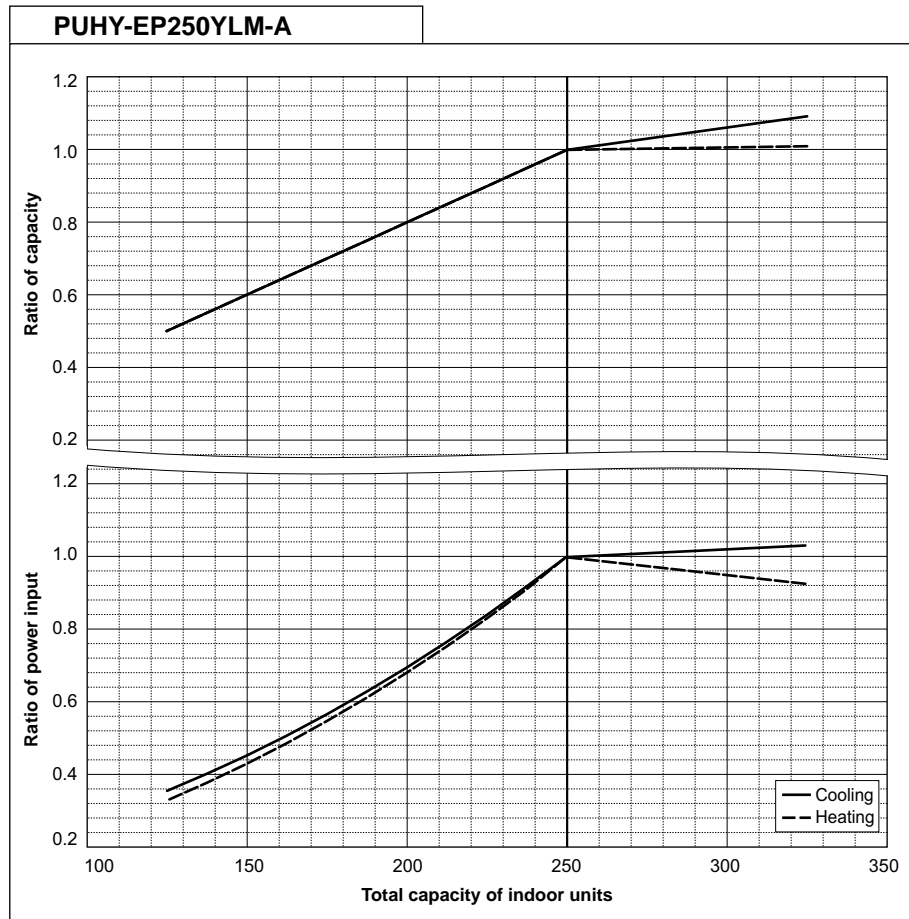

PUHY-EP300YLM-A		
Nominal Cooling Capacity	kW	33.5
	BTU/h	114,300
Input	kW	8.56

PUHY-EP300YLM-A		
Nominal Heating Capacity	kW	37.5
	BTU/h	128,000
Input	kW	9.16

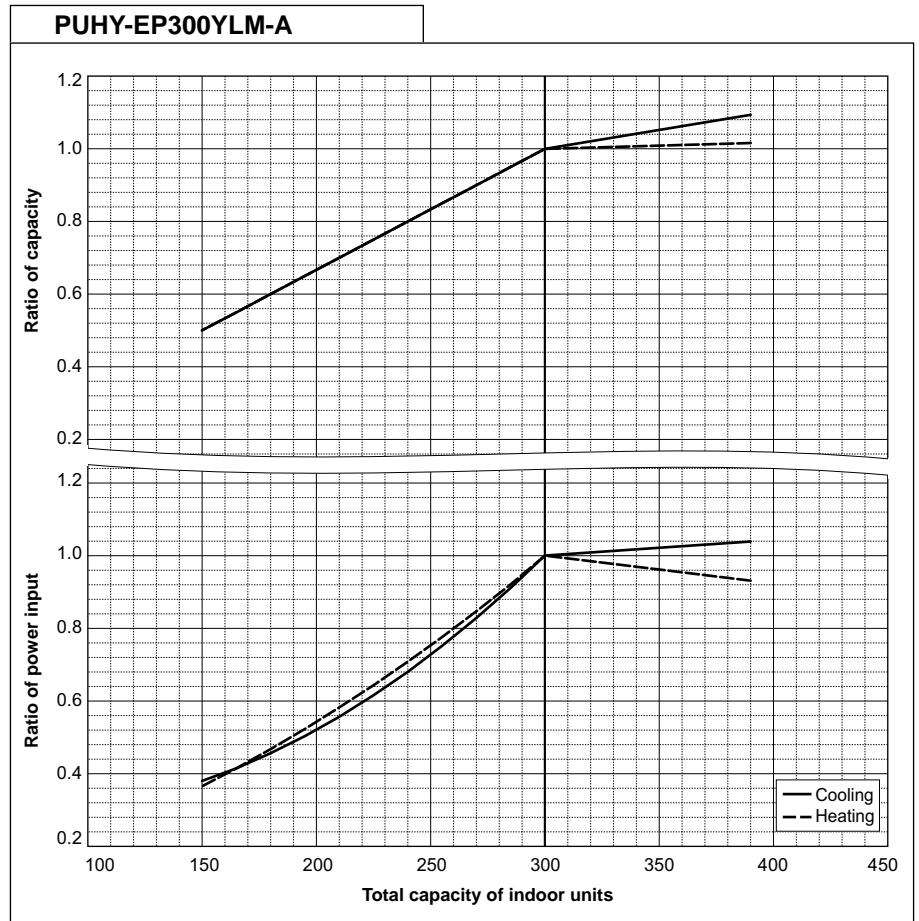

PUHY-EP350YLM-A		
Nominal Cooling Capacity	kW	40.0
	BTU/h	136,500
Input	kW	11.69

PUHY-EP350YLM-A		
Nominal Heating Capacity	kW	45.0
	BTU/h	153,500
Input	kW	12.53

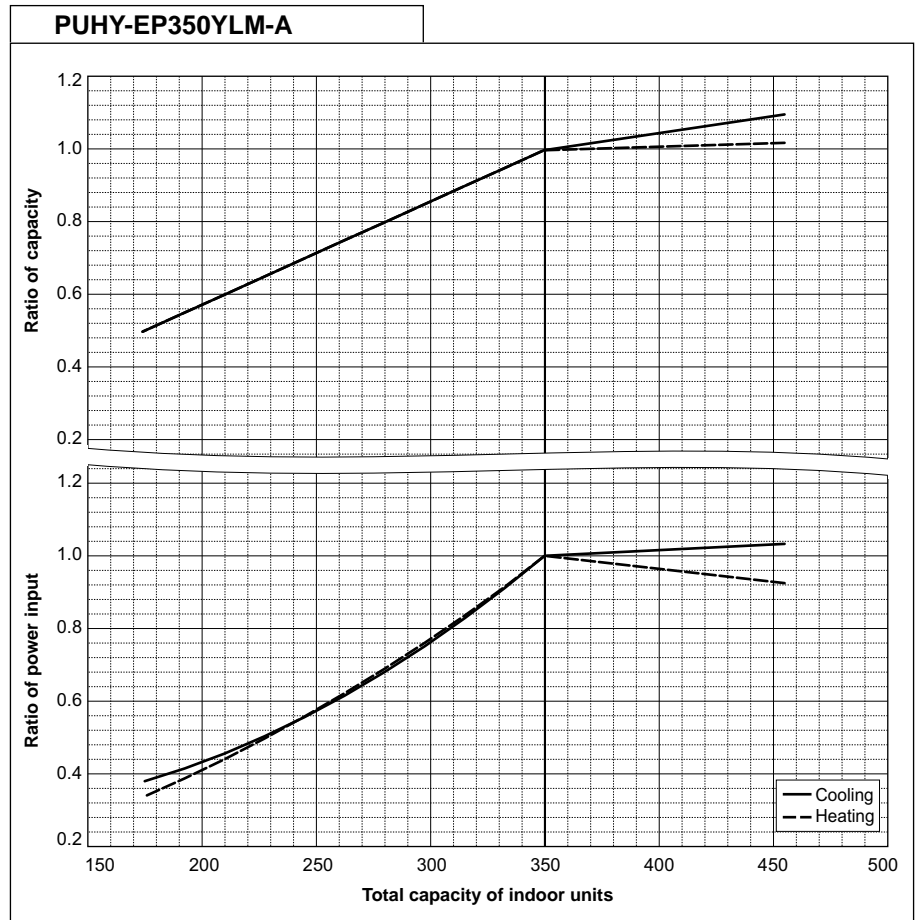

8. CAPACITY TABLES

YKB/YLM

Y (HIGH COP)

PUHY-EP400YLM-A		
Nominal Cooling Capacity	kW	45.0
	BTU/h	153,500
Input	kW	12.26

PUHY-EP400YLM-A		
Nominal Heating Capacity	kW	50.0
	BTU/h	170,600
Input	kW	13.15

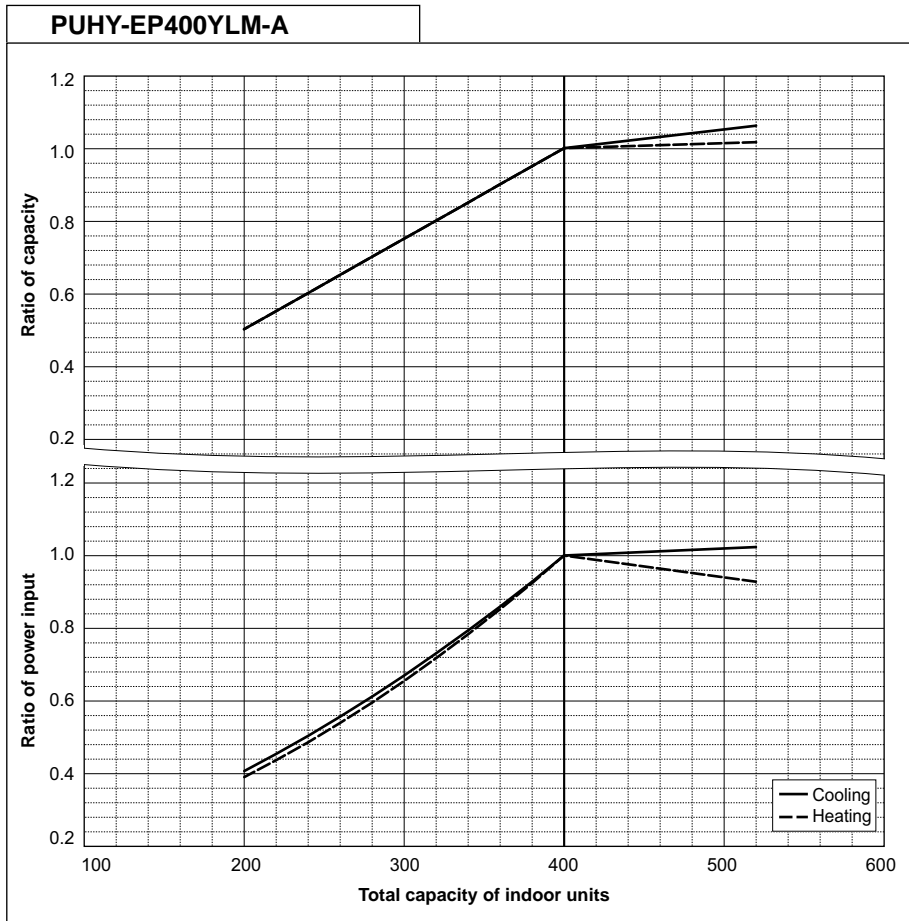

PUHY-EP450YLM-A		
Nominal Cooling Capacity	kW	50.0
	BTU/h	170,600
Input	kW	14.79

PUHY-EP450YLM-A		
Nominal Heating Capacity	kW	56.0
	BTU/h	191,100
Input	kW	16.09

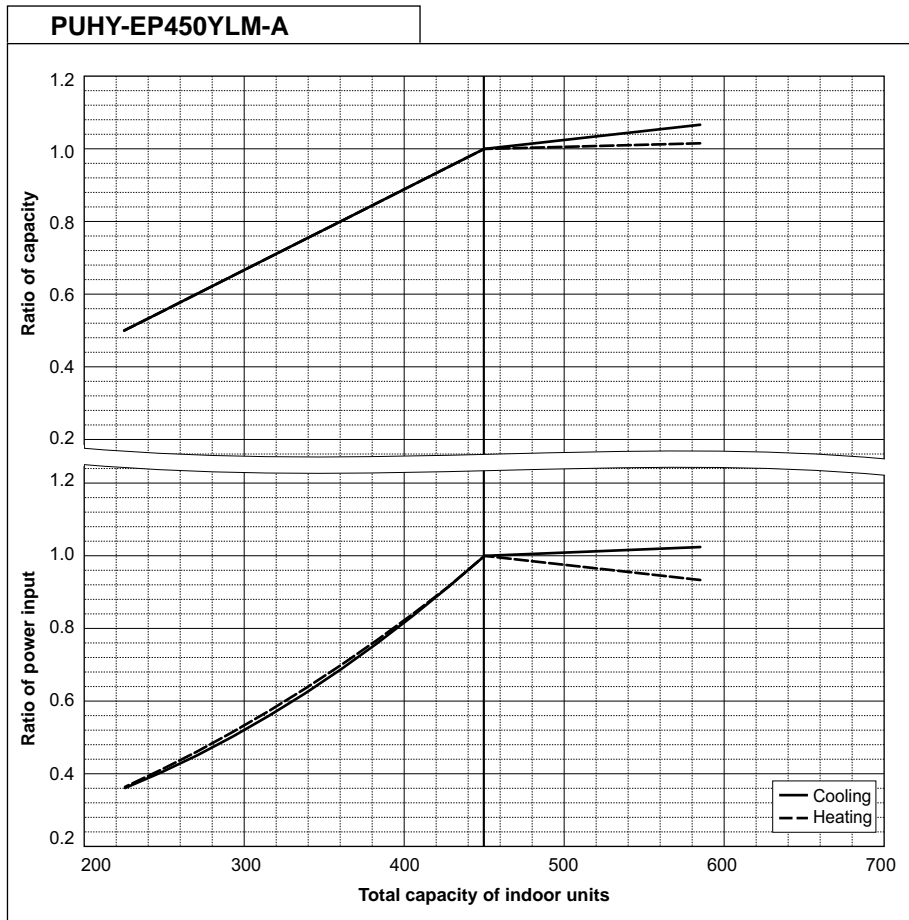

PUHY-EP500YLM-A		
Nominal Cooling Capacity	kW	56.0
	BTU/h	191,100
Input	kW	18.72

PUHY-EP500YLM-A		
Nominal Heating Capacity	kW	63.0
	BTU/h	215,000
Input	kW	19.68

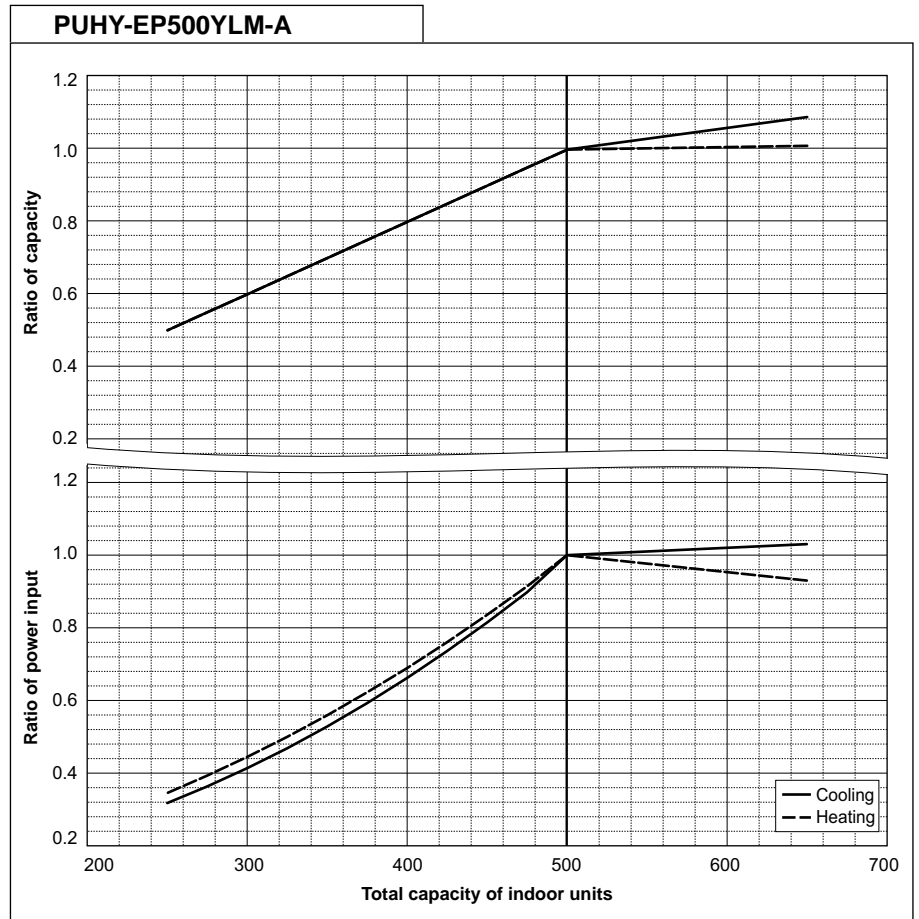

PUHY-EP550YSLM-A		
Nominal Cooling Capacity	kW	63.0
	BTU/h	215,000
Input	kW	16.62

PUHY-EP550YSLM-A		
Nominal Heating Capacity	kW	69.0
	BTU/h	235,400
Input	kW	17.73

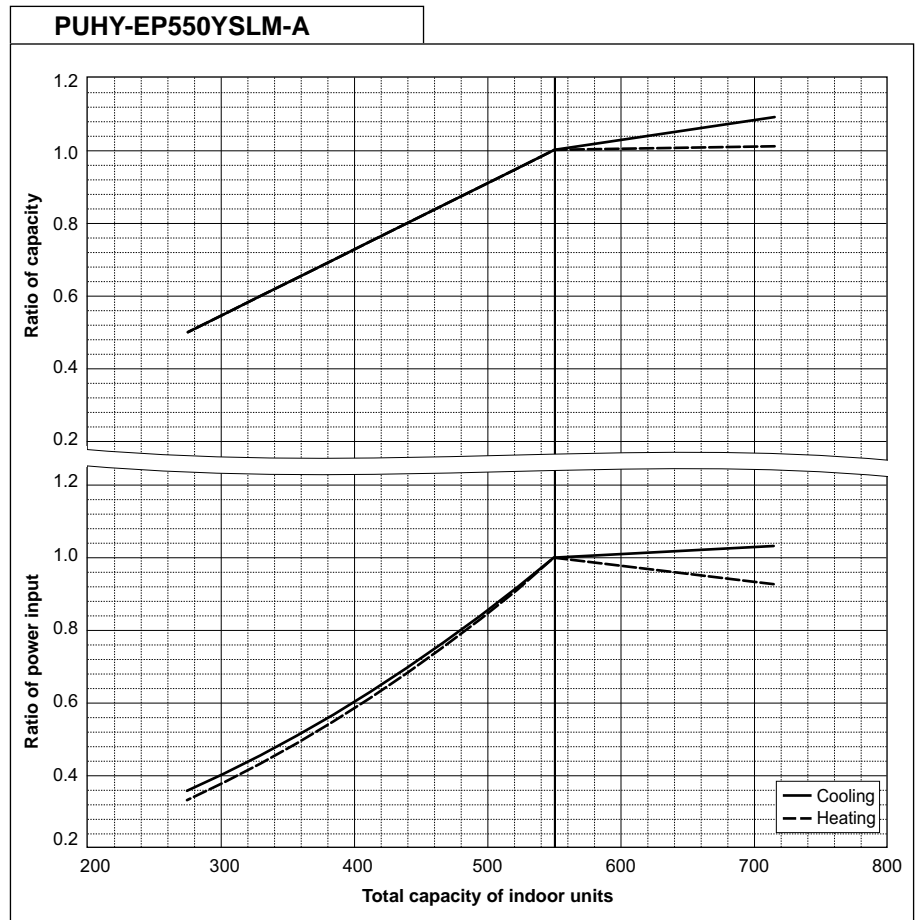

8. CAPACITY TABLES

Y (HIGH COP)

PUHY-EP600YSLM-A		
Nominal Cooling Capacity	kW	69.0
	BTU/h	235,400
Input	kW	18.59

PUHY-EP600YSLM-A		
Nominal Heating Capacity	kW	76.5
	BTU/h	261,000
Input	kW	19.66

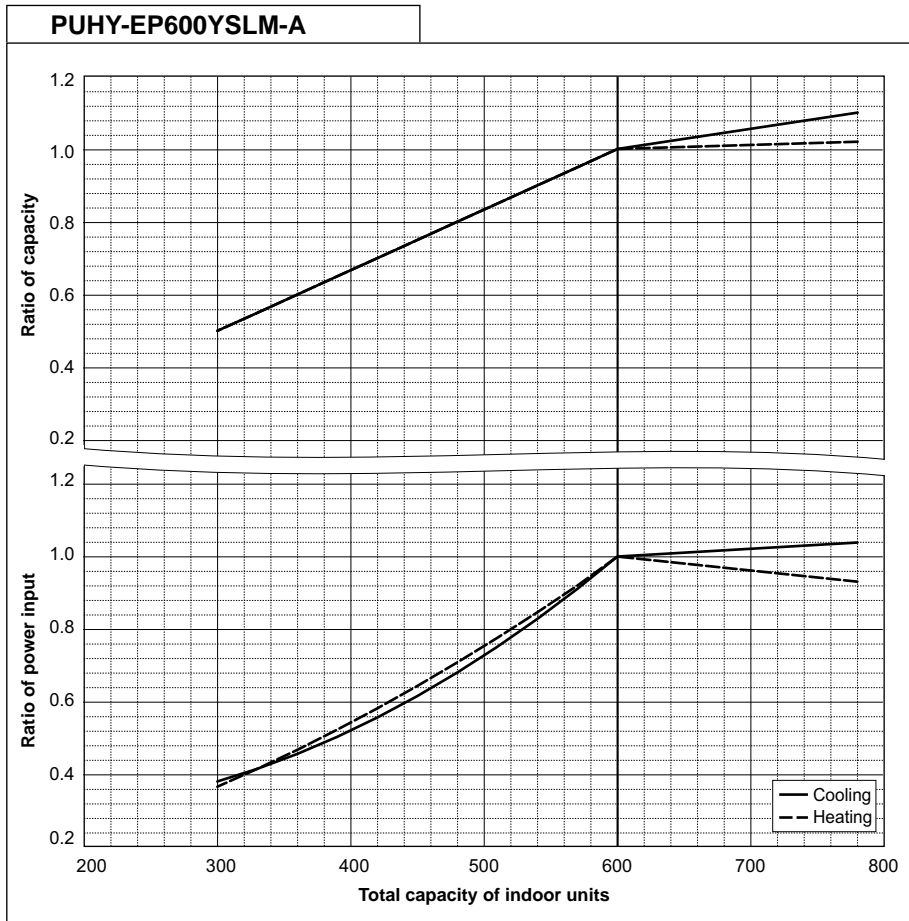

PUHY-EP650YSLM-A		
Nominal Cooling Capacity	kW	73.0
	BTU/h	249,100
Input	kW	18.15

PUHY-EP650YSLM-A		
Nominal Heating Capacity	kW	81.5
	BTU/h	278,100
Input	kW	20.07

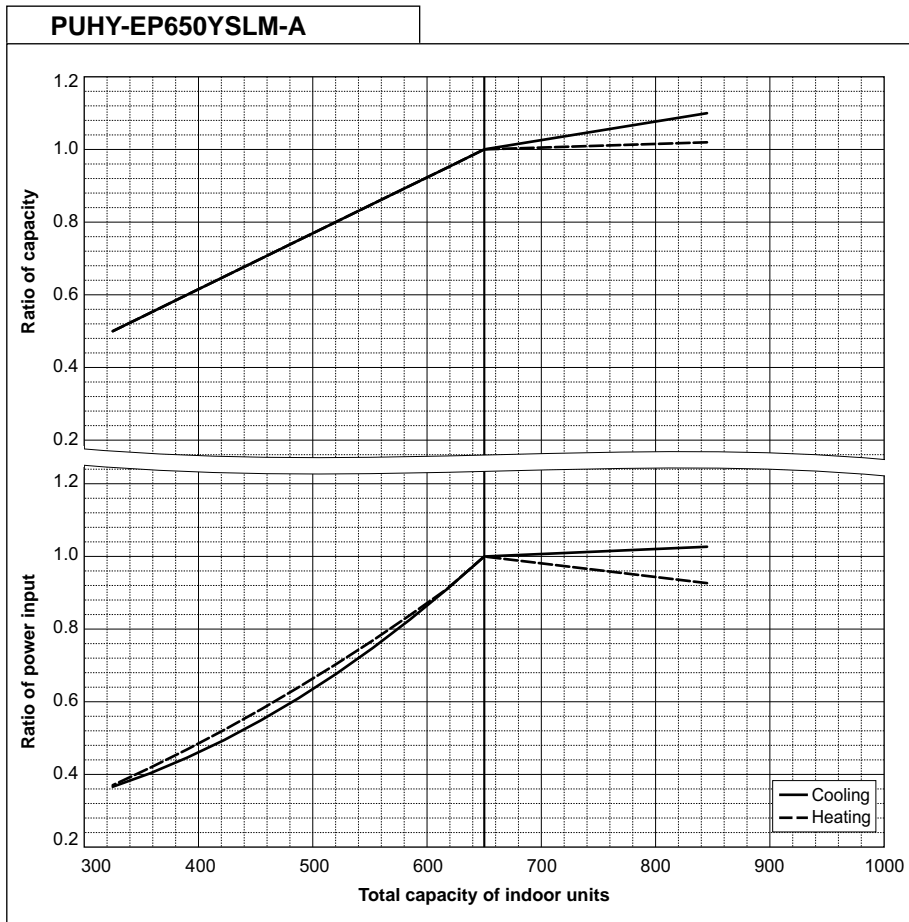

PUHY-EP700YSLM-A		
Nominal Cooling Capacity	kW	80.0
	BTU/h	273,000
Input	kW	20.15

PUHY-EP700YSLM-A		
Nominal Heating Capacity	kW	88.0
	BTU/h	300,300
Input	kW	21.67

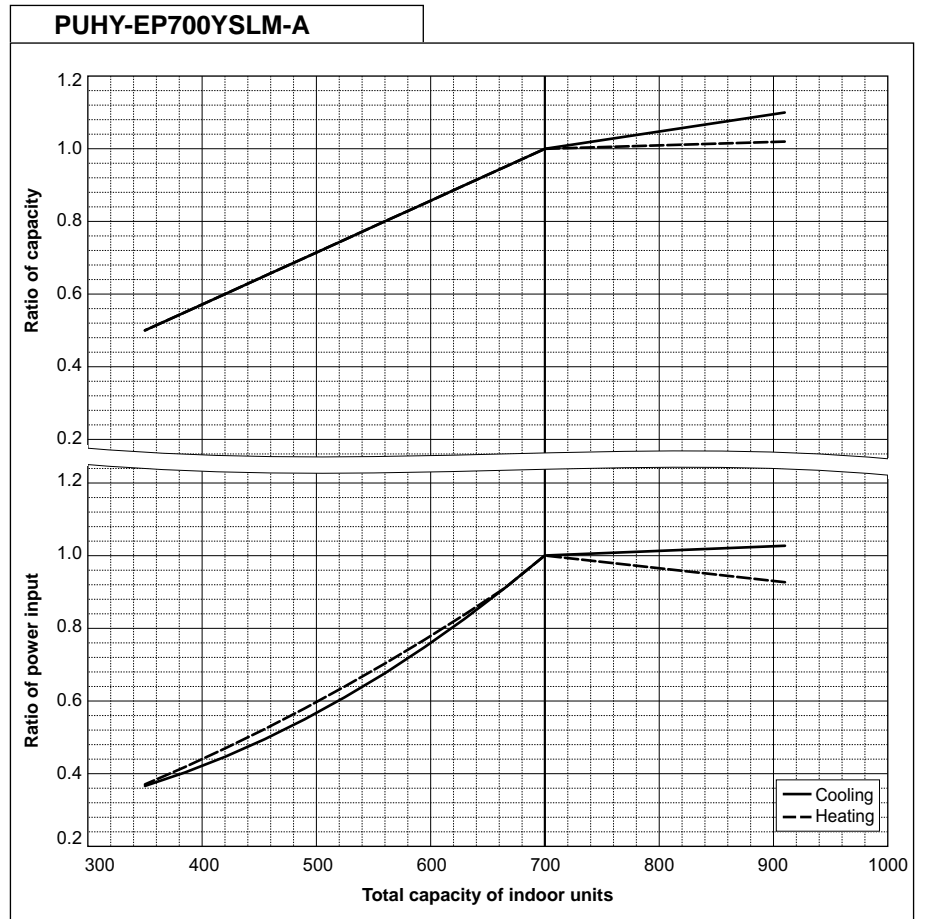

PUHY-EP750YSLM-A		
Nominal Cooling Capacity	kW	85.0
	BTU/h	290,000
Input	kW	21.85

PUHY-EP750YSLM-A		
Nominal Heating Capacity	kW	95.0
	BTU/h	324,100
Input	kW	23.92

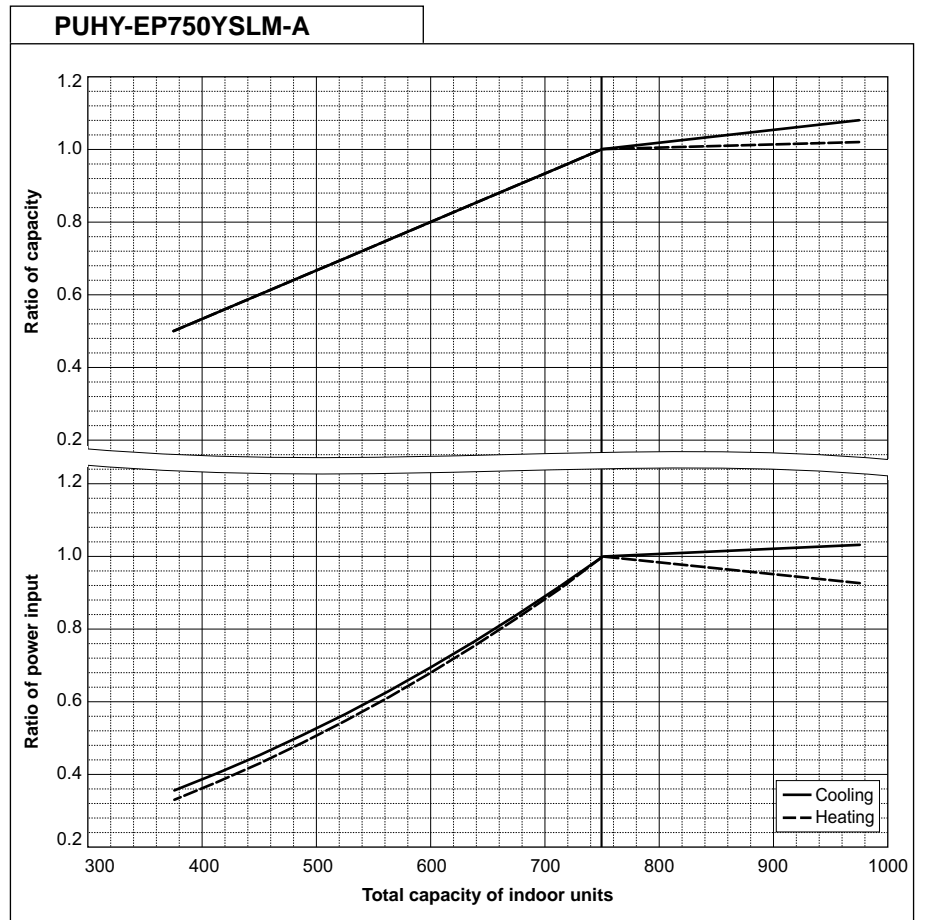

8. CAPACITY TABLES

YKB/YLM

Y (HIGH COP)

PUHY-EP800YSLM-A		
Nominal Cooling Capacity	kW	90.0
	BTU/h	307,100
Input	kW	23.43

PUHY-EP800YSLM-A		
Nominal Heating Capacity	kW	100.0
	BTU/h	341,200
Input	kW	25.18

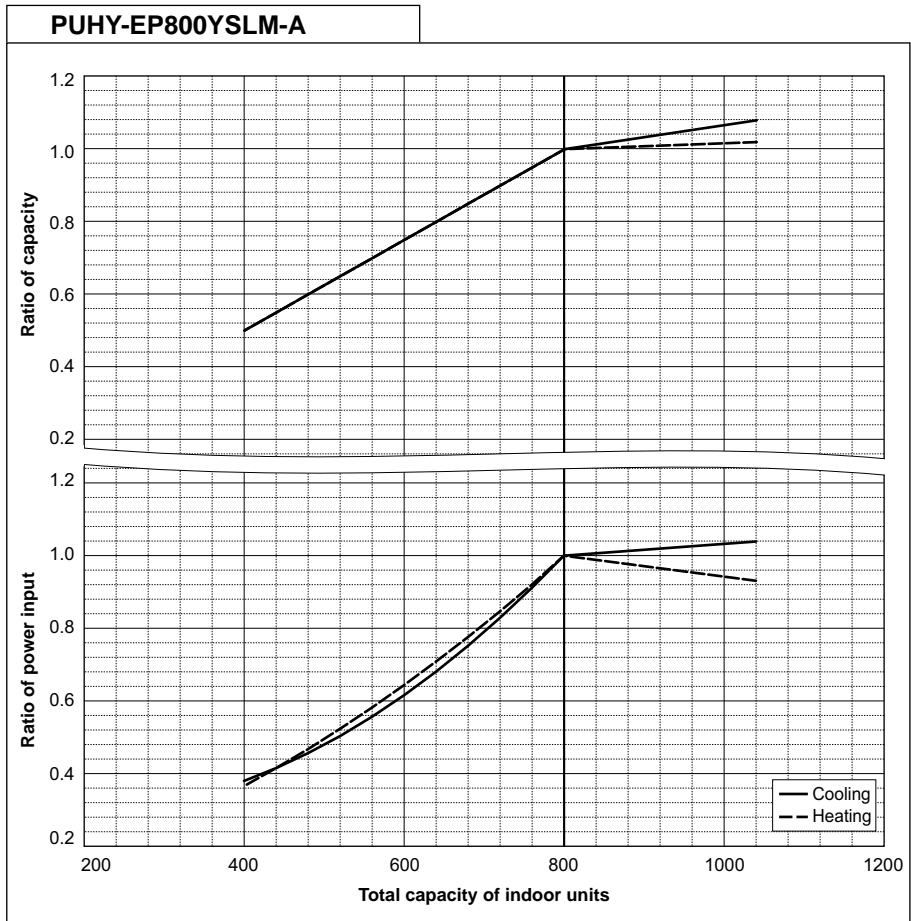

PUHY-EP850YSLM-A		
Nominal Cooling Capacity	kW	96.0
	BTU/h	327,600
Input	kW	25.53

PUHY-EP850YSLM-A		
Nominal Heating Capacity	kW	108.0
	BTU/h	368,500
Input	kW	27.76

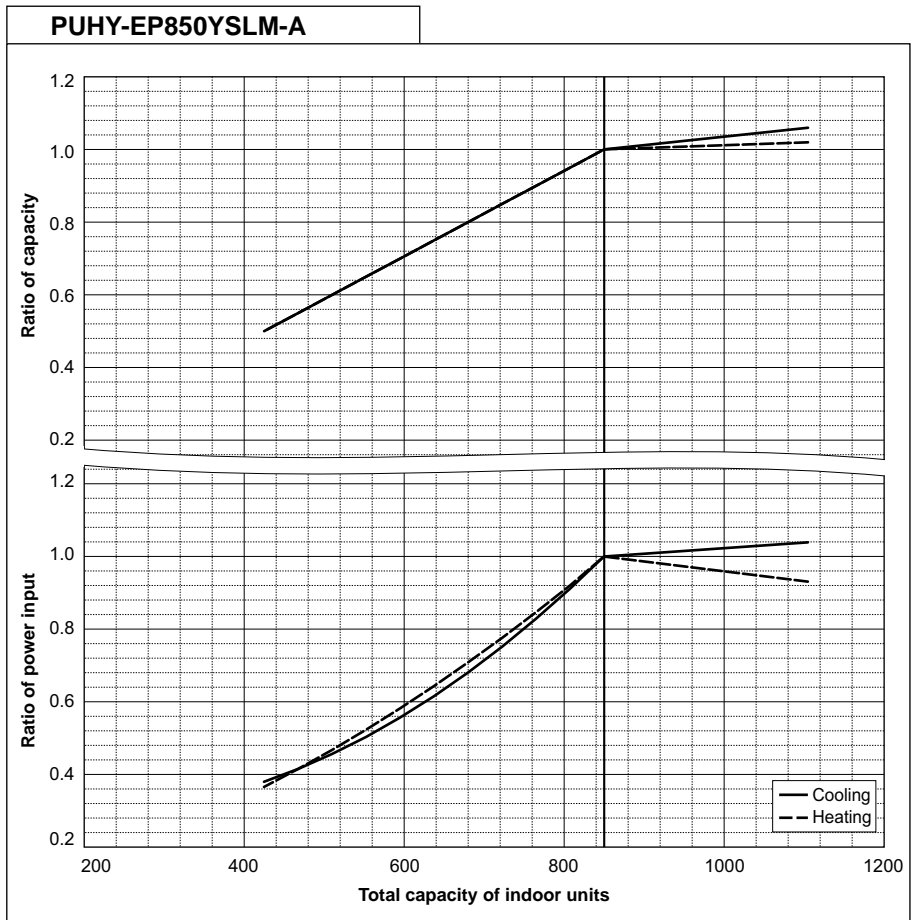

PUHY-EP900YSLM-A		
Nominal Cooling Capacity	kW	101.0
	BTU/h	344,600
Input	kW	27.22

PUHY-EP900YSLM-A		
Nominal Heating Capacity	kW	113.0
	BTU/h	385,600
Input	kW	29.04

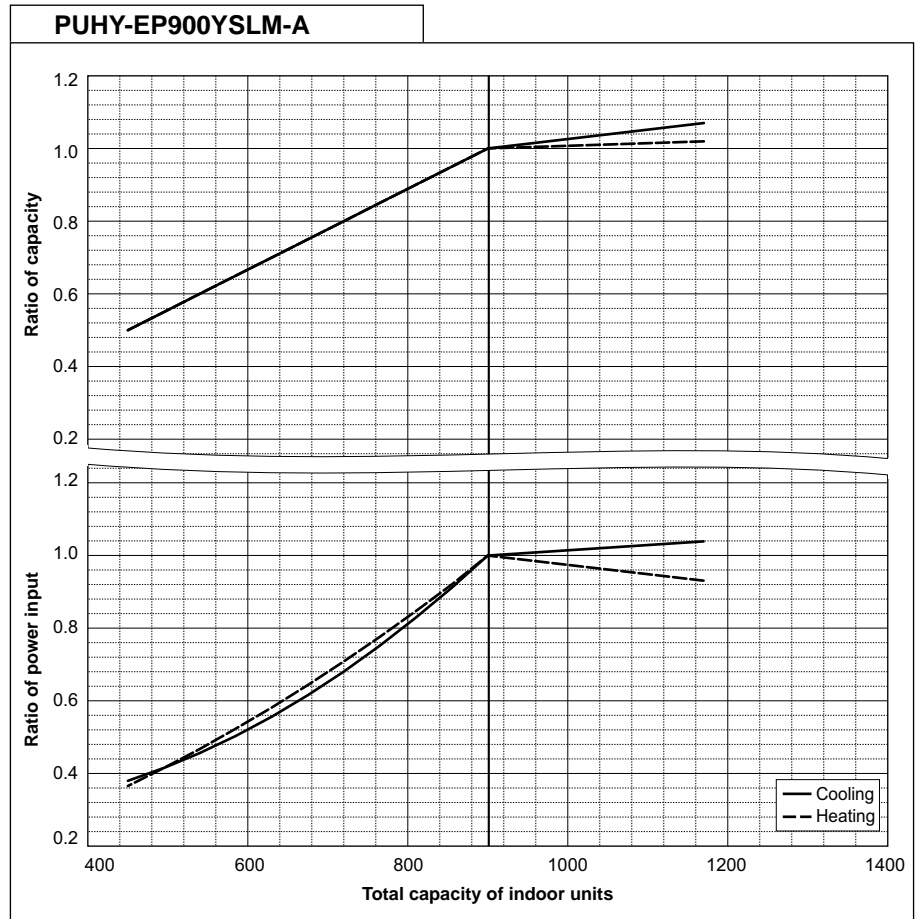

PUHY-EP950YSLM-A		
Nominal Cooling Capacity	kW	108.0
	BTU/h	368,500
Input	kW	30.33

PUHY-EP950YSLM-A		
Nominal Heating Capacity	kW	119.5
	BTU/h	407,700
Input	kW	32.03

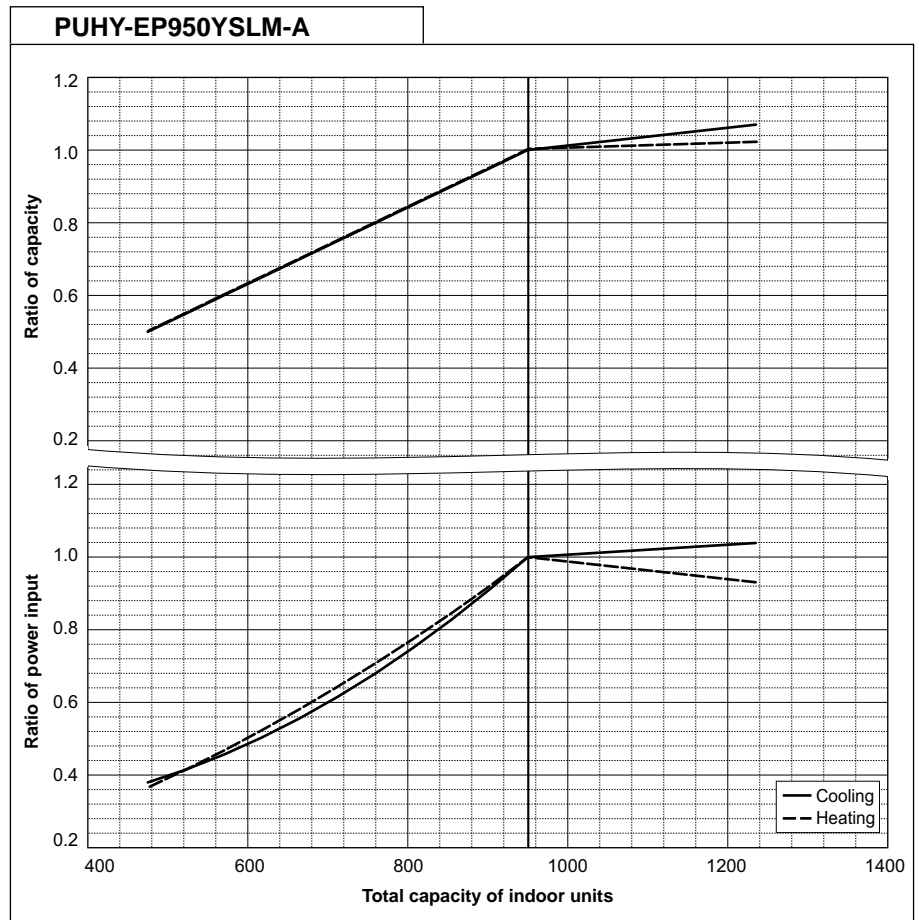

8. CAPACITY TABLES

YKB/YLM

Y (HIGH COP)

PUHY-EP1000YSLM-A		
Nominal Cooling Capacity	kW	113.0
	BTU/h	385,600
Input	kW	31.04

PUHY-EP1000YSLM-A		
Nominal Heating Capacity	kW	127.0
	BTU/h	433,300
Input	kW	33.50

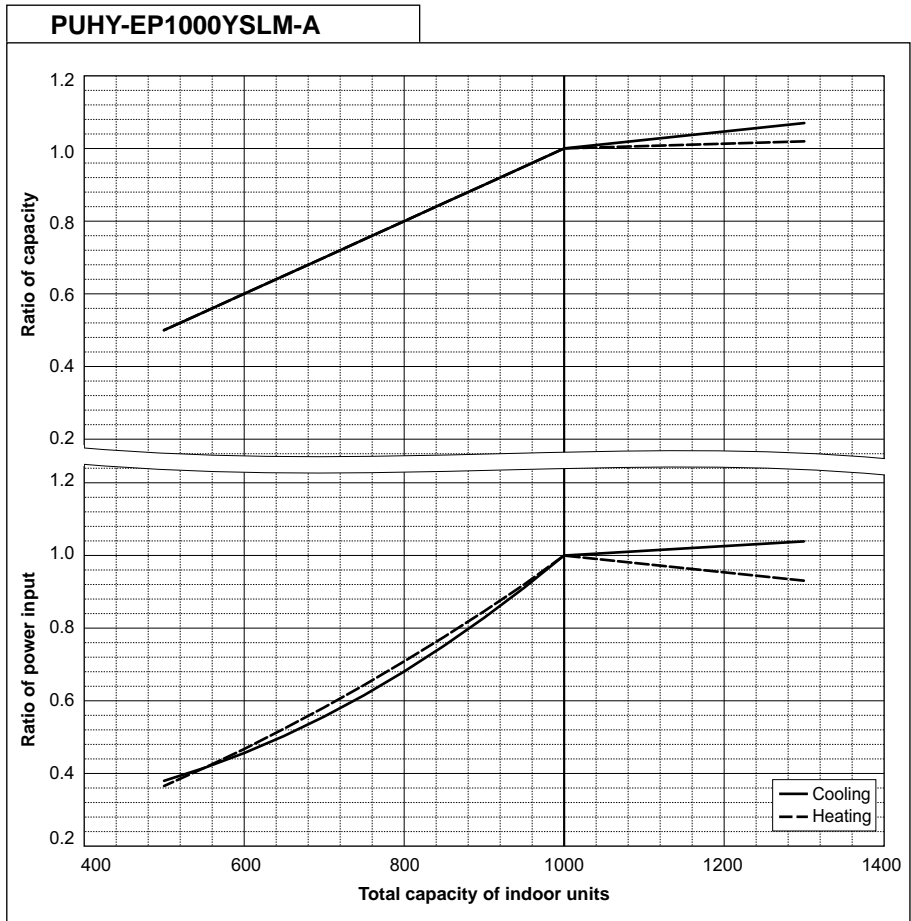

PUHY-EP1050YSLM-A		
Nominal Cooling Capacity	kW	118.0
	BTU/h	402,600
Input	kW	34.40

PUHY-EP1050YSLM-A		
Nominal Heating Capacity	kW	132.0
	BTU/h	450,400
Input	kW	36.87

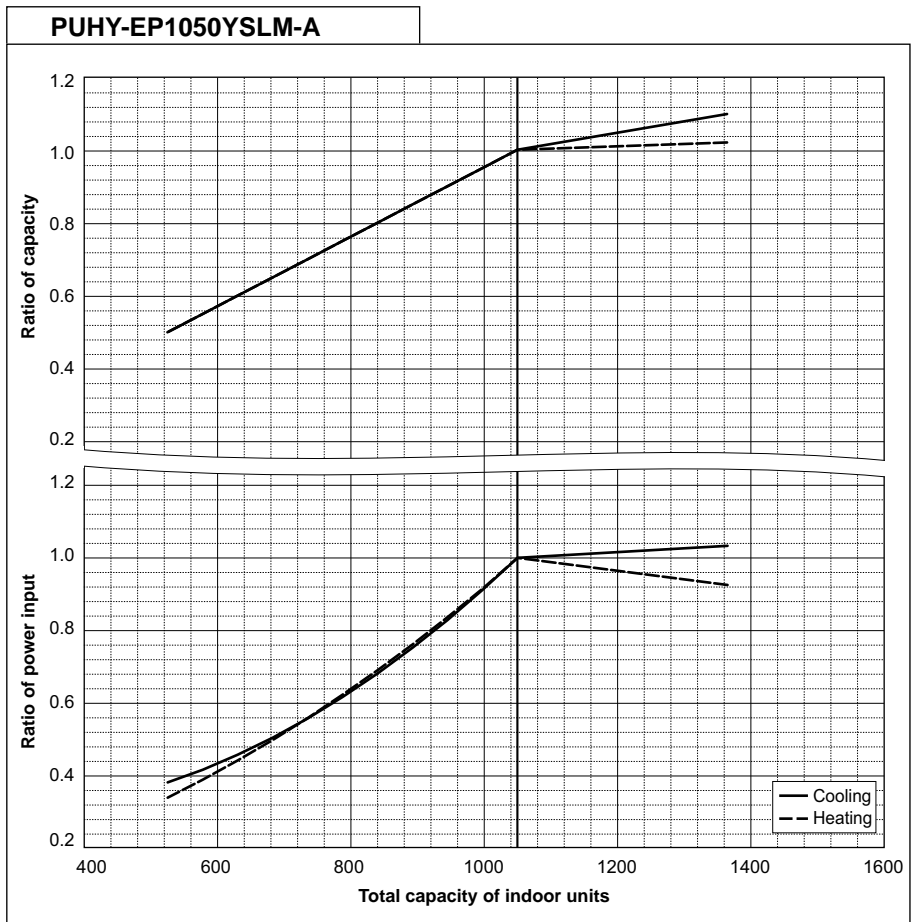

PUHY-EP1100YSLM-A		
Nominal Cooling Capacity	kW	124.0
	BTU/h	423,100
Input	kW	38.15

PUHY-EP1100YSLM-A		
Nominal Heating Capacity	kW	140.0
	BTU/h	477,700
Input	kW	41.17

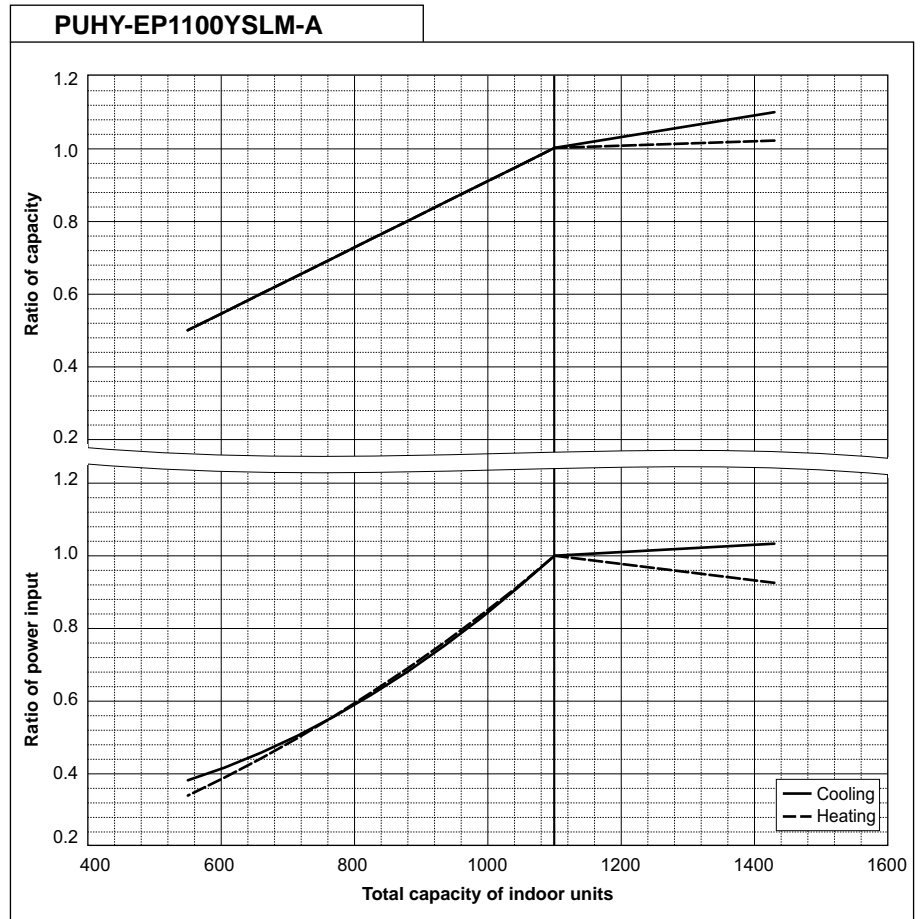

PUHY-EP1150YSLM-A		
Nominal Cooling Capacity	kW	130.0
	BTU/h	443,600
Input	kW	41.53

PUHY-EP1150YSLM-A		
Nominal Heating Capacity	kW	145.0
	BTU/h	494,700
Input	kW	44.47

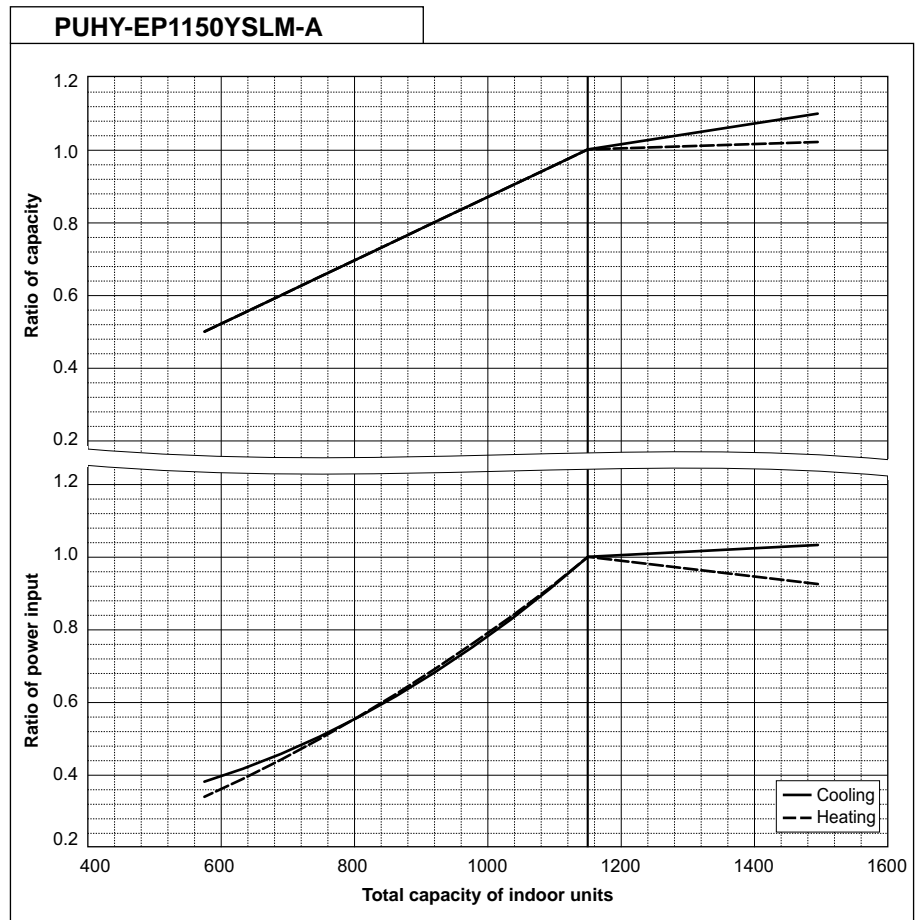

8. CAPACITY TABLES

Y (HIGH COP)

PUHY-EP1200YSLM-A		
Nominal Cooling Capacity	kW	136.0
	BTU/h	464,000
Input	kW	42.76

PUHY-EP1200YSLM-A		
Nominal Heating Capacity	kW	150.0
	BTU/h	511,800
Input	kW	45.45

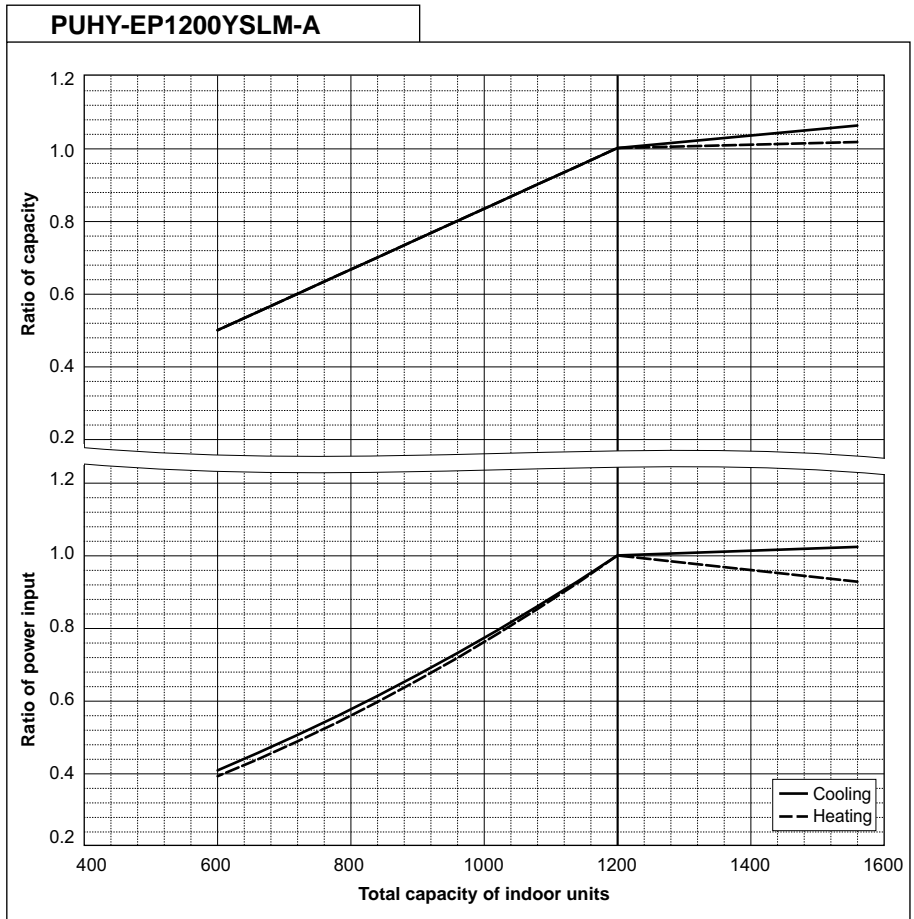

PUHY-EP1250YSLM-A		
Nominal Cooling Capacity	kW	140.0
	BTU/h	477,700
Input	kW	45.90

PUHY-EP1250YSLM-A		
Nominal Heating Capacity	kW	156.5
	BTU/h	534,000
Input	kW	49.36

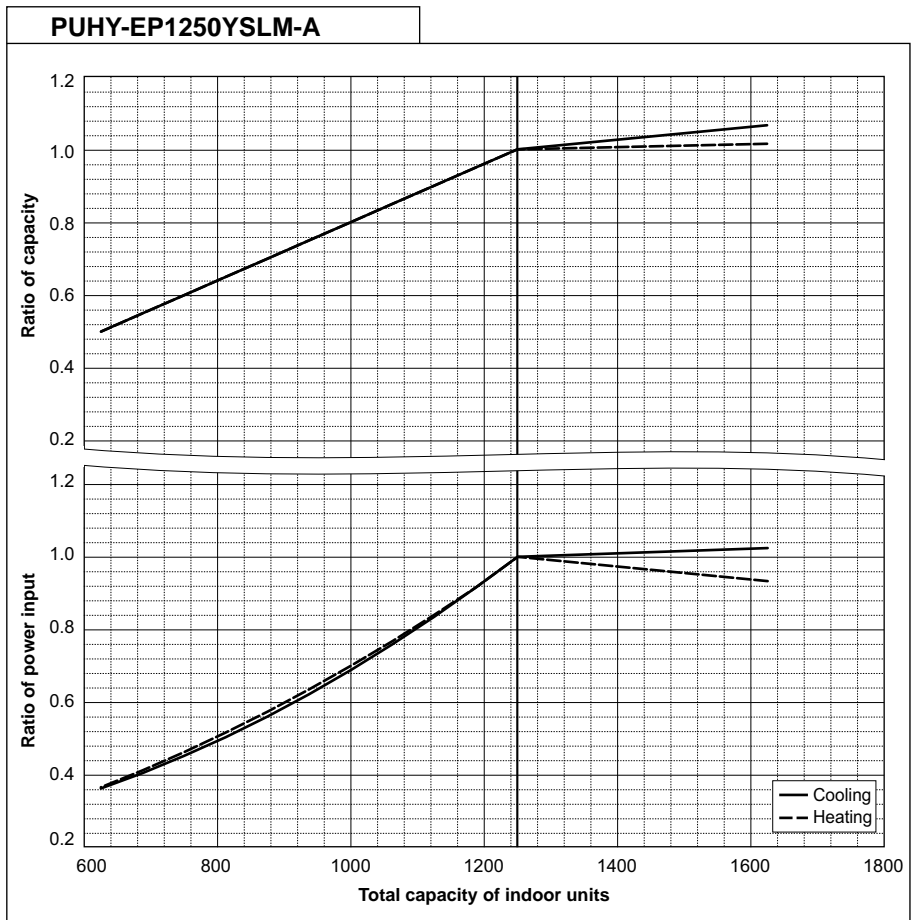

PUHY-EP1300YSLM-A		
Nominal Cooling Capacity	kW	146.0
	BTU/h	498,200
Input	kW	46.94

PUHY-EP1300YSLM-A		
Nominal Heating Capacity	kW	163.0
	BTU/h	556,200
Input	kW	50.62

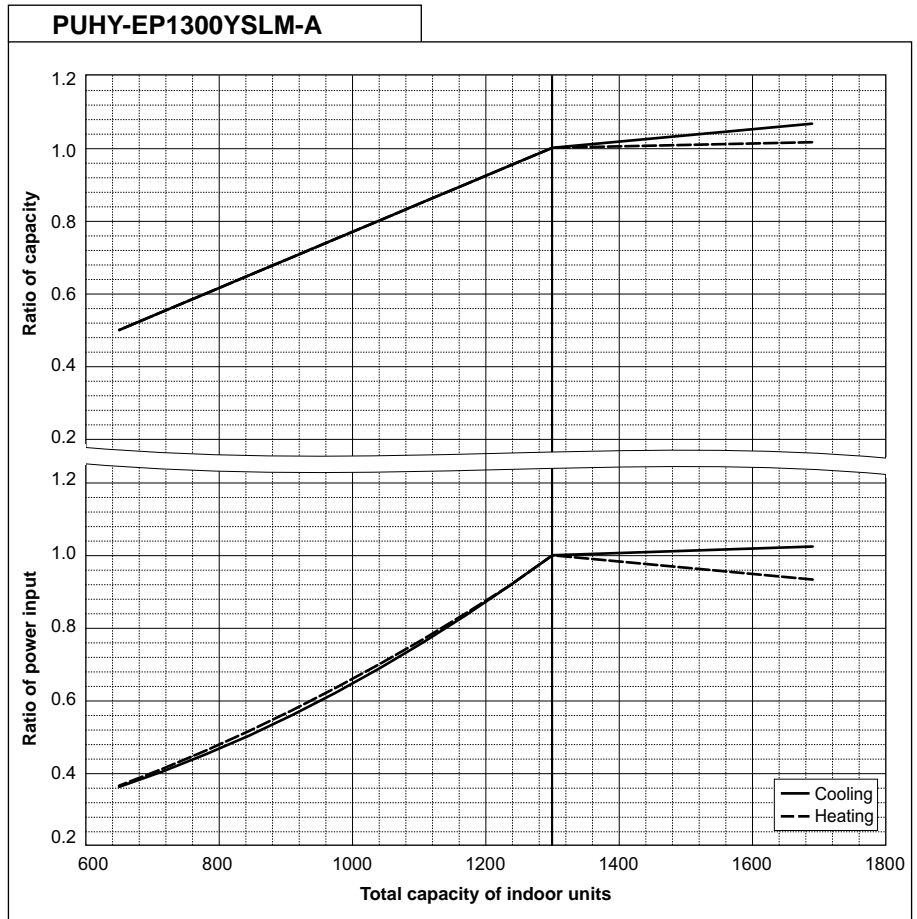

PUHY-EP1350YSLM-A		
Nominal Cooling Capacity	kW	150.0
	BTU/h	511,800
Input	kW	50.00

PUHY-EP1350YSLM-A		
Nominal Heating Capacity	kW	168.0
	BTU/h	573,200
Input	kW	54.36

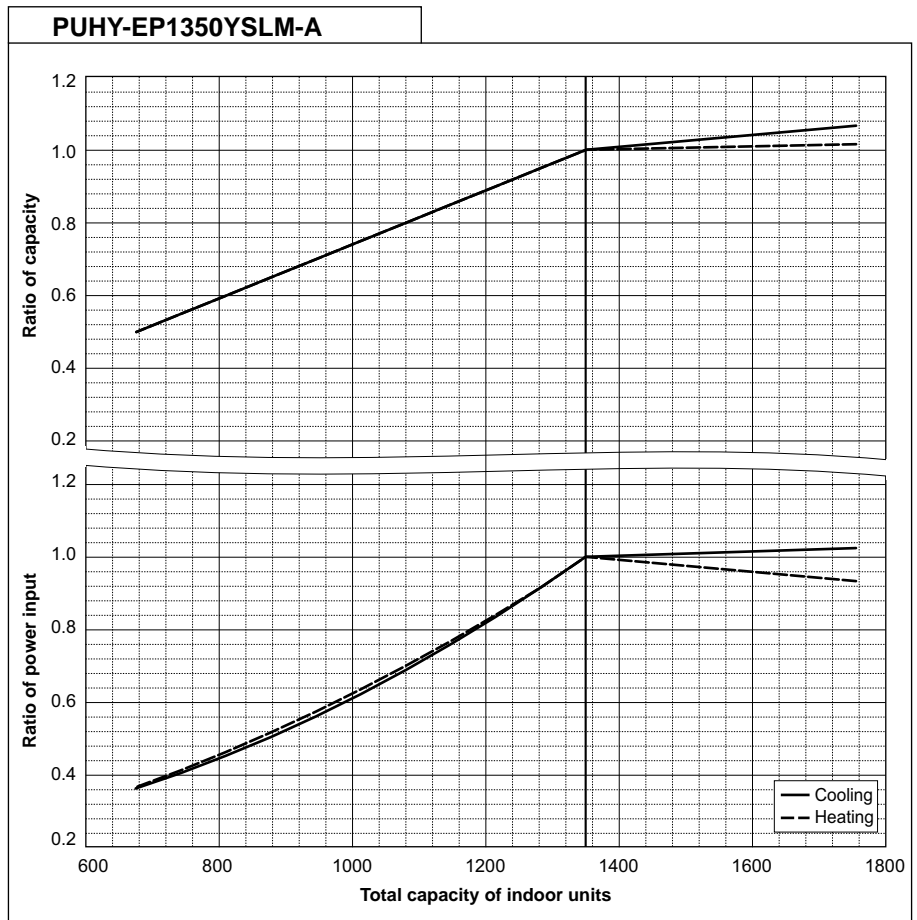

8-4. Correction by refrigerant piping length

CITY MULTI system can extend the piping flexibly within its limitation for the actual situation. However, a decrease of cooling/heating capacity could happen correspondently. Using following correction factor according to the equivalent length of the piping shown at 8-4-1 and 8-4-2, the capacity can be observed. 8-4-3 shows how to obtain the equivalent length of piping.

8-4-1. Cooling capacity correction

Y (HIGH COP)

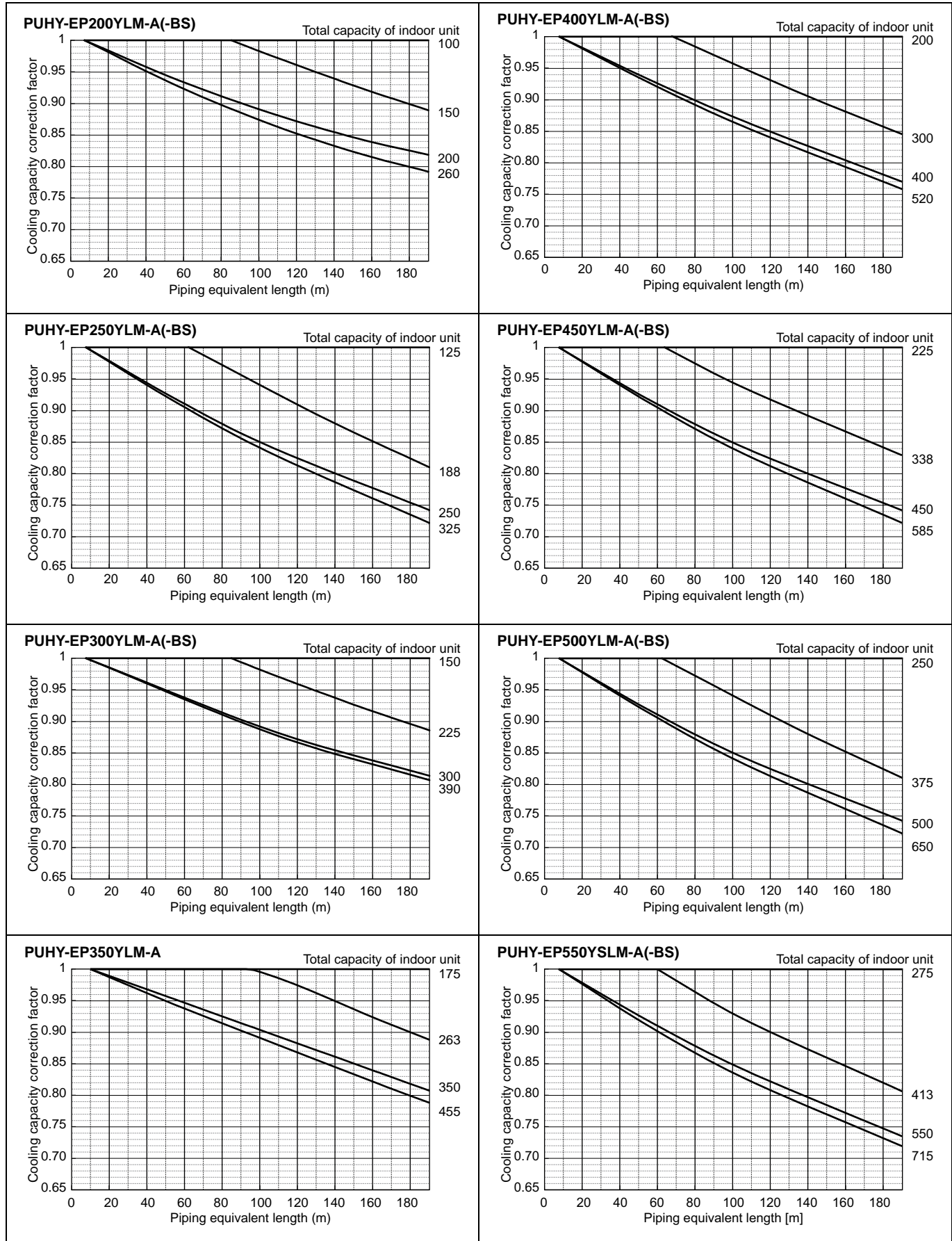

8. CAPACITY TABLES

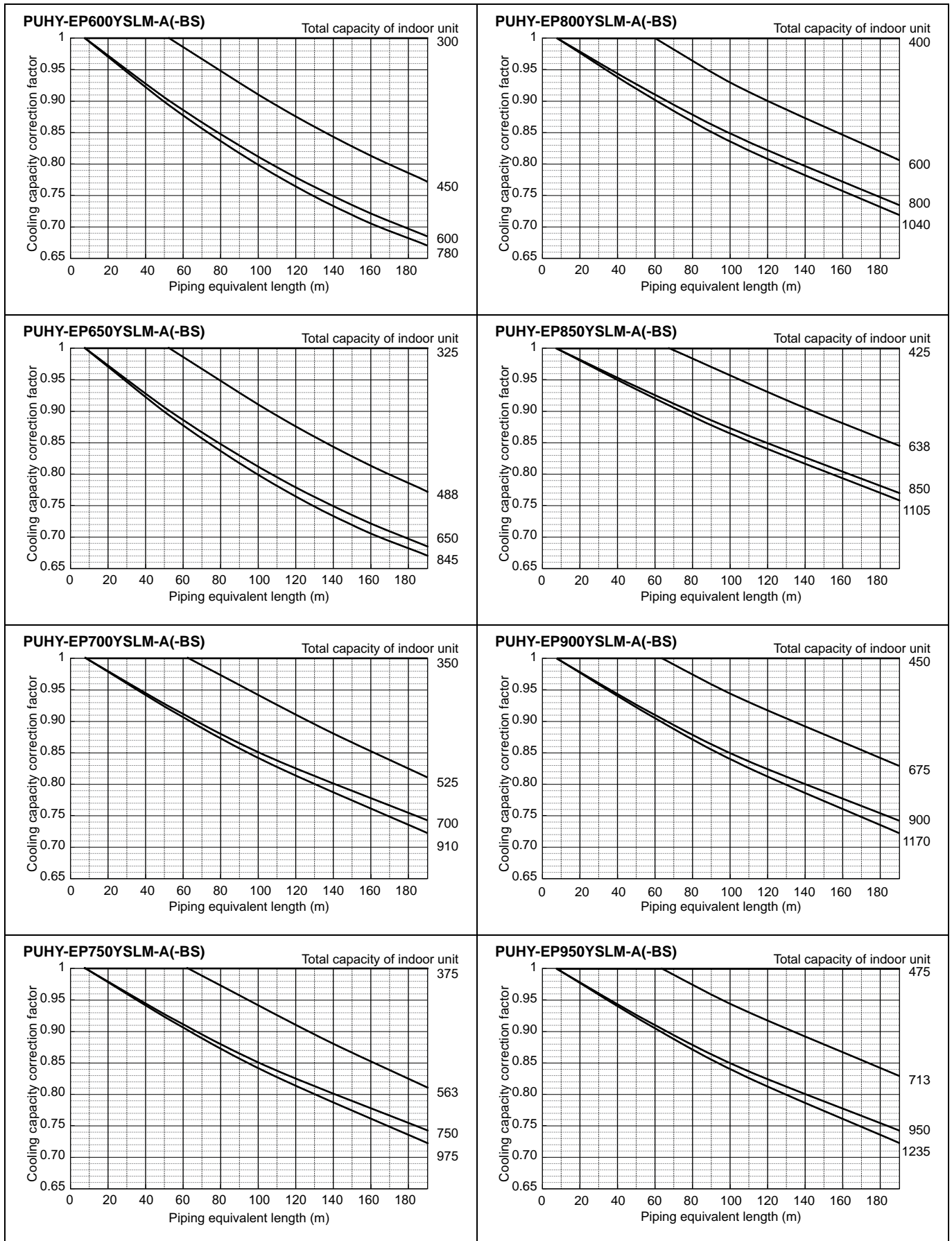

8. CAPACITY TABLES

Y (HIGH COP)

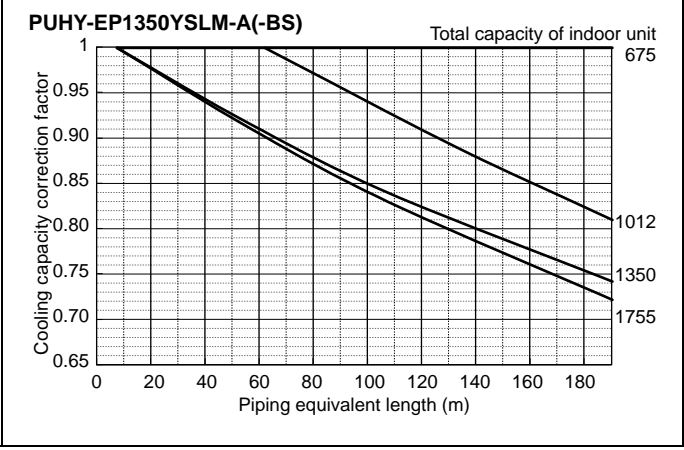
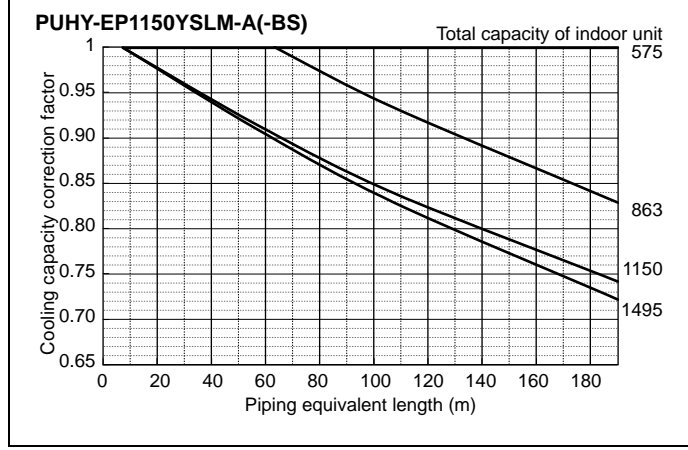
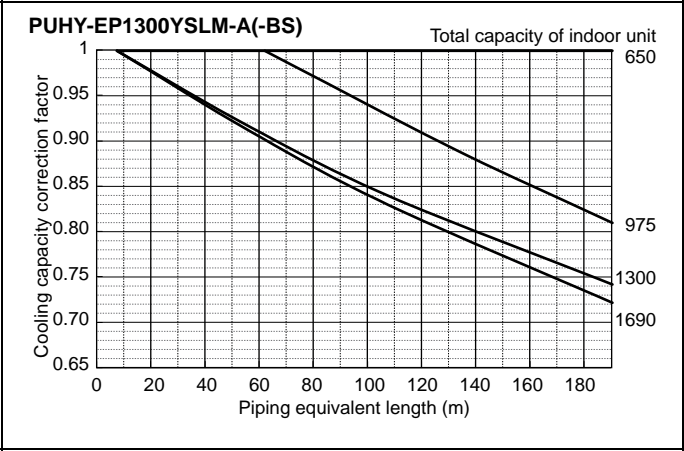
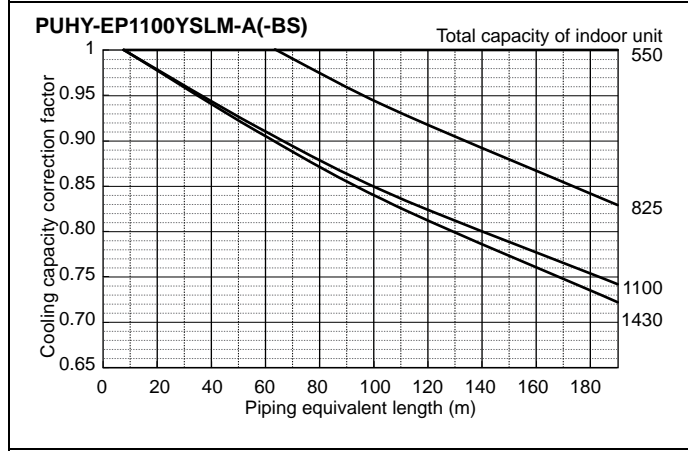
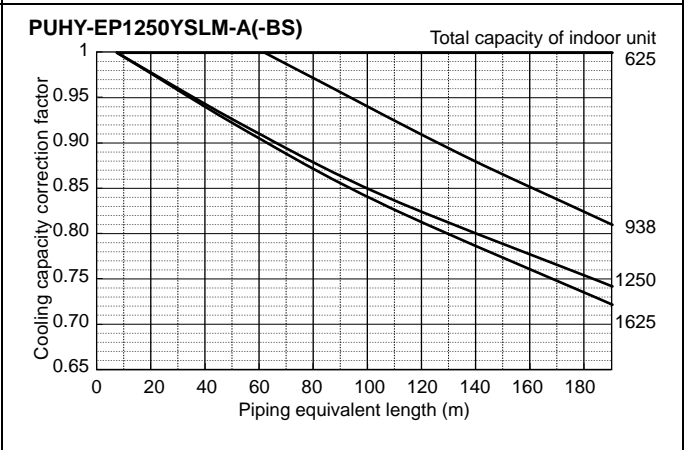
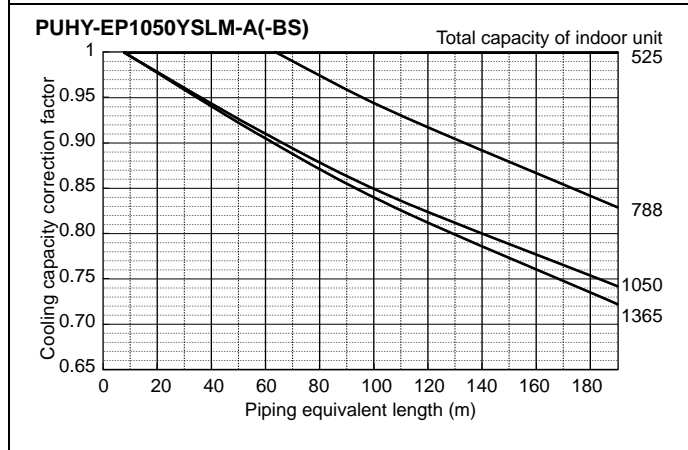
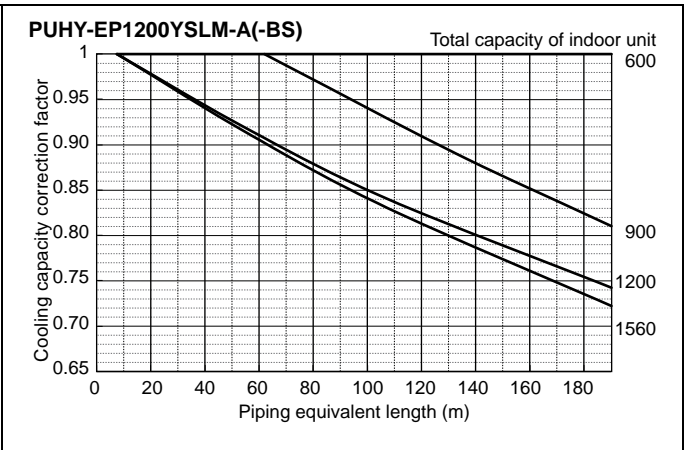
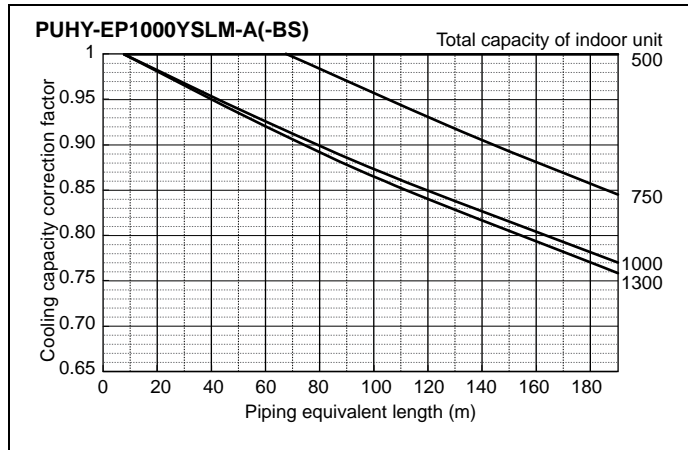

8-4-2. Heating capacity correction

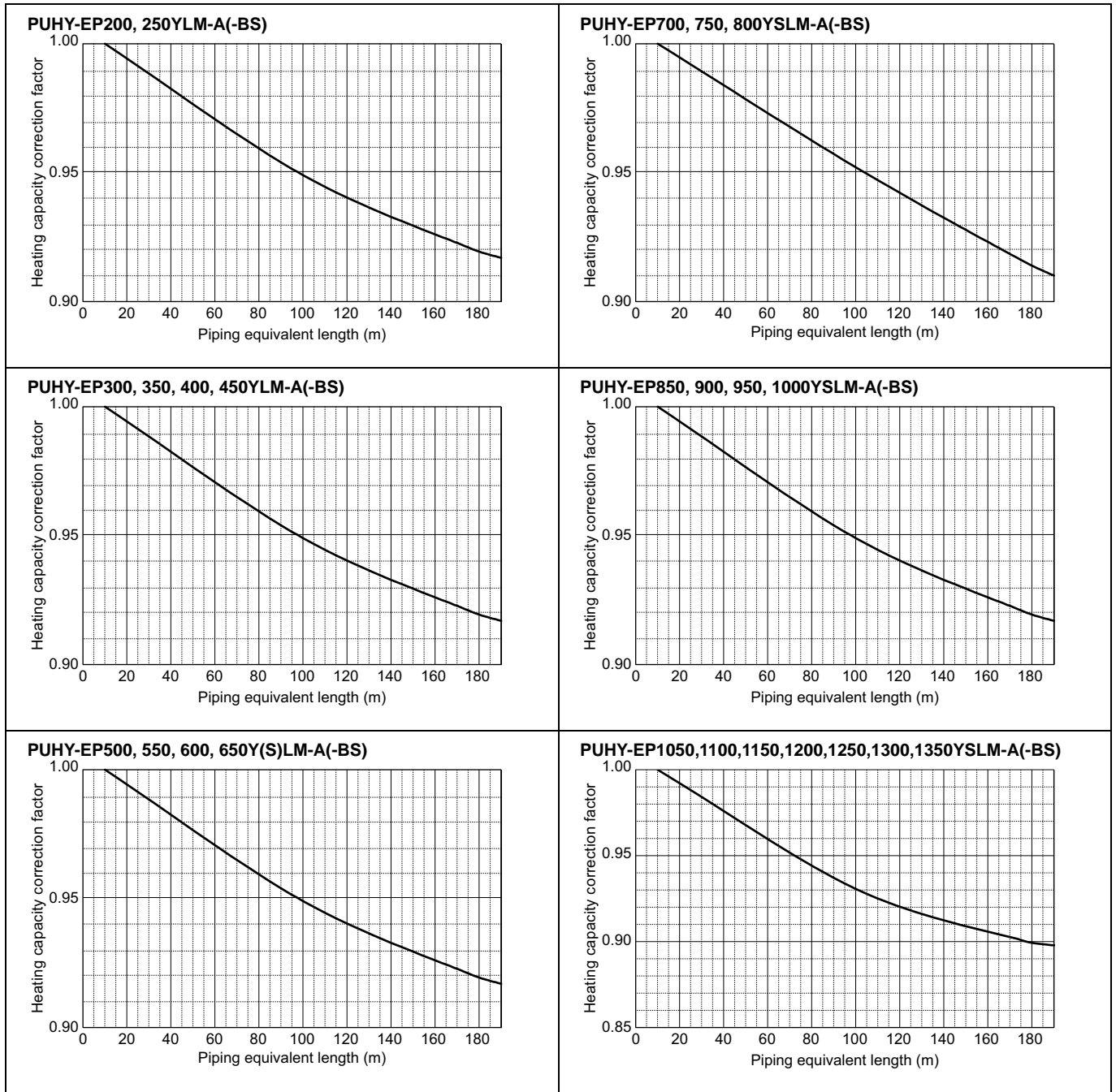

8-4-3. How to obtain the equivalent piping length

- 1 **PUHY-EP200YLM-A(-BS)**
Equivalent length = (Actual piping length to the farthest indoor unit) + (0.42 × number of bends in the piping) m
- 2 **PUHY-EP250YLM-A(-BS)**
Equivalent length = (Actual piping length to the farthest indoor unit) + (0.42 × number of bends in the piping) m
- 3 **PUHY-EP300YLM-A(-BS)**
Equivalent length = (Actual piping length to the farthest indoor unit) + (0.47 × number of bends in the piping) m
- 4 **PUHY-EP350YLM-A(-BS)**
Equivalent length = (Actual piping length to the farthest indoor unit) + (0.47 × number of bends in the piping) m
- 5 **PUHY-EP400, 450, 500, 550, 600, 650Y(S)LM-A(-BS)**
Equivalent length = (Actual piping length to the farthest indoor unit) + (0.50 × number of bends in the piping) m
- 6 **PUHY-EP700, 750, 800YSLM-A(-BS)**
Equivalent length = (Actual piping length to the farthest indoor unit) + (0.70 × number of bends in the piping) m
- 7 **PUHY-EP850, 900, 950, 1000, 1050, 1100, 1150, 1200, 1250, 1300, 1350YSLM-A(-BS)**
Equivalent length = (Actual piping length to the farthest indoor unit) + (0.80 × number of bends in the piping) m

8-5. Correction at frost and defrost

Due to frost at the outdoor heat exchanger and the automatic defrost operation, the heating capacity of the outdoor unit can be calculated by multiplying the correction factor shown in the table below.

Table of correction factor at frost and defrost

Outdoor inlet air temp. °C	6	4	2	1	0	-2	-4	-6	-8	-10	-20
Outdoor inlet air temp. °F	43	39	36	34	32	28	25	21	18	14	-4
PUHY-EP200YLM-A(-BS)	1.00	0.95	0.84	0.825	0.83	0.87	0.90	0.95	0.95	0.95	0.95
PUHY-EP250YLM-A(-BS)	1.00	0.95	0.84	0.825	0.83	0.87	0.90	0.95	0.95	0.95	0.95
PUHY-EP300YLM-A(-BS)	1.00	0.95	0.84	0.825	0.83	0.87	0.90	0.95	0.95	0.95	0.95
PUHY-EP350YLM-A(-BS)	1.00	0.95	0.84	0.825	0.83	0.87	0.90	0.95	0.95	0.95	0.95
PUHY-EP400YLM-A(-BS)	1.00	0.93	0.82	0.80	0.82	0.86	0.90	0.90	0.95	0.95	0.95
PUHY-EP450YLM-A(-BS)	1.00	0.93	0.82	0.80	0.82	0.86	0.90	0.90	0.95	0.95	0.95
PUHY-EP500YLM-A(-BS)	1.00	0.93	0.82	0.80	0.82	0.86	0.90	0.90	0.95	0.95	0.95
PUHY-EP550YSLM-A(-BS)	1.00	0.94	0.87	0.86	0.87	0.88	0.90	0.90	0.93	0.93	0.93
PUHY-EP600YSLM-A(-BS)	1.00	0.94	0.87	0.86	0.87	0.88	0.90	0.90	0.93	0.93	0.93
PUHY-EP650YSLM-A(-BS)	1.00	0.94	0.87	0.86	0.87	0.88	0.90	0.90	0.93	0.93	0.93
PUHY-EP700YSLM-A(-BS)	1.00	0.98	0.89	0.88	0.89	0.90	0.92	0.95	0.95	0.95	0.95
PUHY-EP750YSLM-A(-BS)	1.00	0.98	0.89	0.88	0.89	0.90	0.92	0.95	0.95	0.95	0.95
PUHY-EP800YSLM-A(-BS)	1.00	0.98	0.89	0.88	0.89	0.90	0.92	0.95	0.95	0.95	0.95
PUHY-EP850YSLM-A(-BS)	1.00	0.94	0.87	0.86	0.87	0.88	0.90	0.90	0.93	0.93	0.93
PUHY-EP900YSLM-A(-BS)	1.00	0.94	0.87	0.86	0.87	0.88	0.90	0.90	0.93	0.93	0.93
PUHY-EP950YSLM-A(-BS)	1.00	0.95	0.84	0.825	0.83	0.87	0.90	0.95	0.95	0.95	0.95
PUHY-EP1000YSLM-A(-BS)	1.00	0.95	0.84	0.825	0.83	0.87	0.90	0.95	0.95	0.95	0.95
PUHY-EP1050YSLM-A(-BS)	1.00	0.95	0.84	0.825	0.83	0.87	0.90	0.95	0.95	0.95	0.95
PUHY-EP1100YSLM-A(-BS)	1.00	0.95	0.84	0.825	0.83	0.87	0.90	0.95	0.95	0.95	0.95
PUHY-EP1150YSLM-A(-BS)	1.00	0.95	0.84	0.825	0.83	0.87	0.90	0.95	0.95	0.95	0.95
PUHY-EP1200YSLM-A(-BS)	1.00	0.93	0.82	0.80	0.82	0.86	0.90	0.90	0.95	0.95	0.95
PUHY-EP1250YSLM-A(-BS)	1.00	0.93	0.82	0.80	0.82	0.86	0.90	0.90	0.95	0.95	0.95
PUHY-EP1300YSLM-A(-BS)	1.00	0.93	0.82	0.80	0.82	0.86	0.90	0.90	0.95	0.95	0.95
PUHY-EP1350YSLM-A(-BS)	1.00	0.93	0.82	0.80	0.82	0.86	0.90	0.90	0.95	0.95	0.95

9-1. JOINT

CITY MULTI units can be easily connected by using Joint sets and Header sets provided by Mitsubishi Electric. Four kinds of Joint sets are available for use. Refer to section 3 in "System Design" or the Installation Manual that comes with the Joint set for how to install the Joint set.

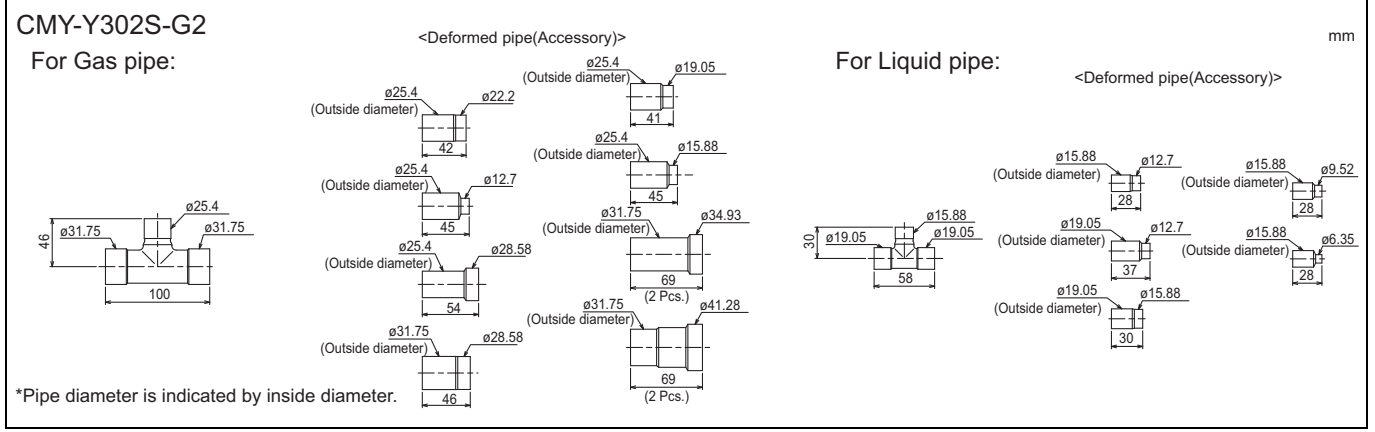
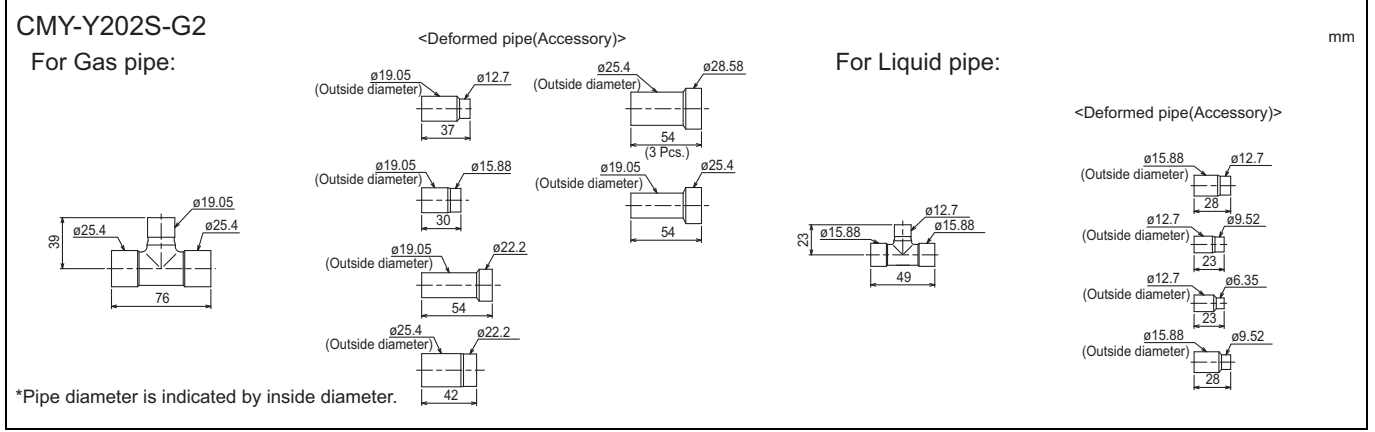
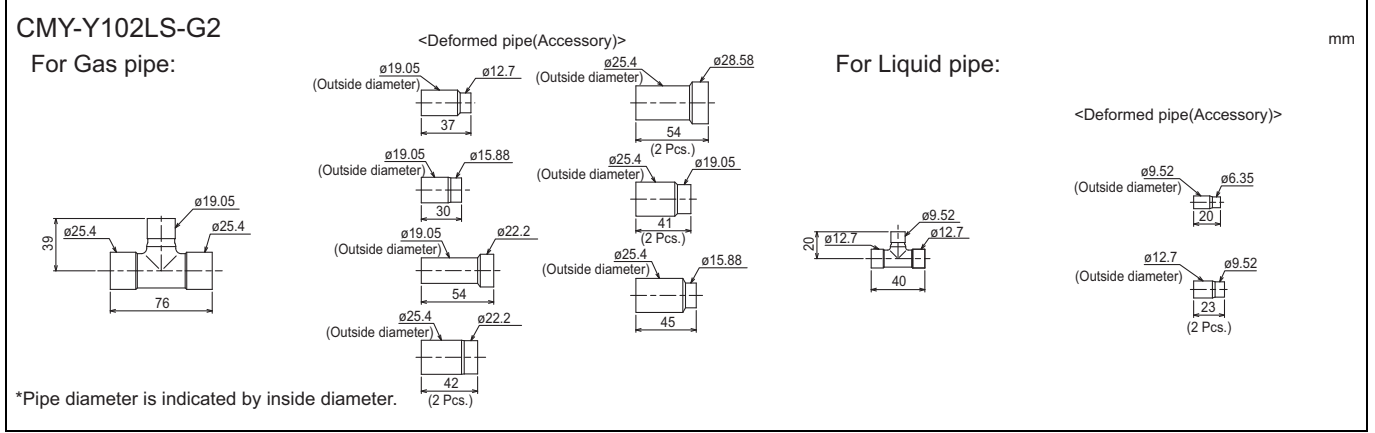
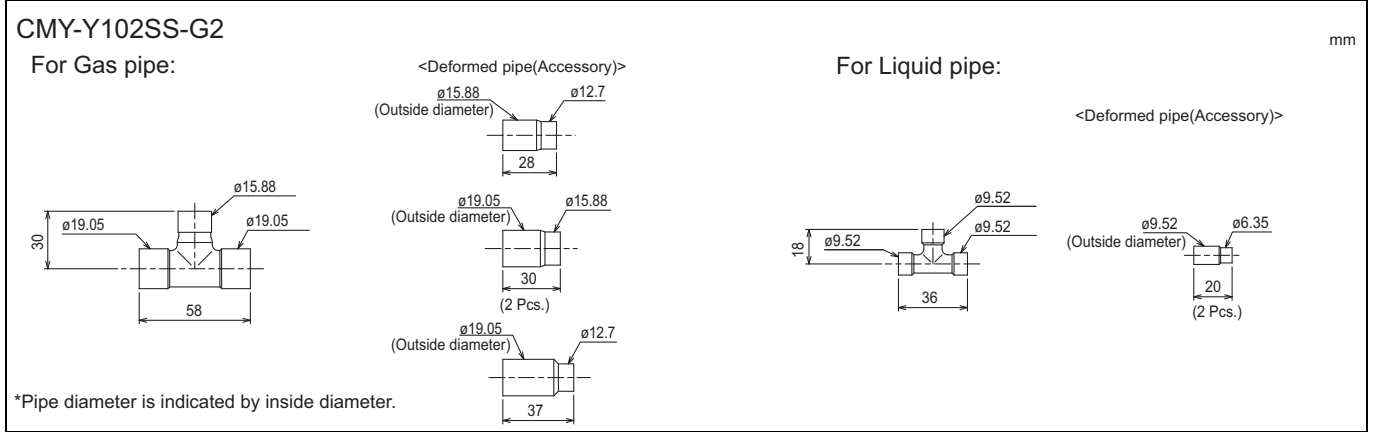

9-2. HEADER

CITY MULTI units can be easily connected by using Joint sets and Header sets provided by Mitsubishi Electric. Three kinds of Header sets are available for use. Refer to section 3 in "System Design" or the Installation Manual that comes with the Header set for how to install the Header set.

CMY-Y104-G Ref.: CMY_Y104-G_EXD_EUDB_SI mm

For Gas pipe:

<Deformed pipe(Accessory)>

(3 Pcs.)

For Liquid pipe:

<Deformed pipe(Accessory)>

(3 Pcs.)

ID: Inner Diameter OD: Outer Diameter
 NOTE: Besides above mentioned accessories, caps for pipe of φ 6.35, φ 9.52, φ 12.7, φ 15.88 (each diameter 1 piece) are included in the Header set.

CMY-Y108-G Ref.: CMY_Y108-G_EXD_EUDB_SI mm

For Gas pipe:

<Deformed pipe(Accessory)>

(5 Pcs.)
(2 Pcs.)

For Liquid pipe:

<Deformed pipe(Accessory)>

(6 Pcs.)

ID: Inner Diameter OD: Outer Diameter
 NOTE: Besides above mentioned accessories, caps for pipe of φ 6.35, φ 9.52, φ 12.7, φ 15.88 (each diameter 2 pieces) and 1 cap for pipe of φ 19.05 are included in the Header set.

CMY-Y1010-G Ref.: CMY_Y1010-G_EXD_EUDB_SI mm

For Gas pipe:

<Deformed pipe(Accessory)>

(2 Pcs.)
(2 Pcs.)
(5 Pcs.)
(3 Pcs.)

For Liquid pipe:

<Deformed pipe(Accessory)>

(5 Pcs.)
(5 Pcs.)

ID: Inner Diameter OD: Outer Diameter
 NOTE: Besides above mentioned accessories, caps for pipe of φ 6.35, φ 9.52, φ 12.7, φ 15.88 (each diameter 2 pieces) and 1 cap for pipe of φ 19.05 are included in the Header set.

9-3. OUTDOOR TWINNING KIT

The following optional Outdoor Twinning Kit is needed to use to combine multiple refrigerant pipes. Refer to the chapter entitled System Design Section for the details of selecting a proper twinning kit.

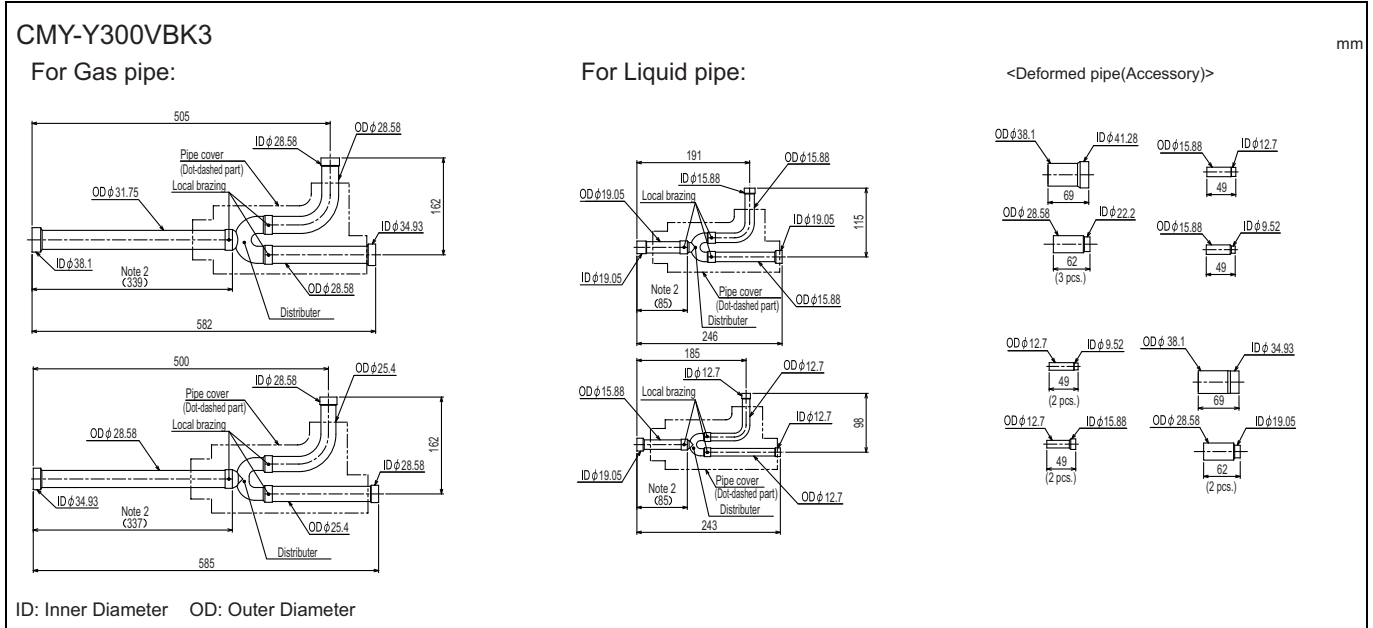
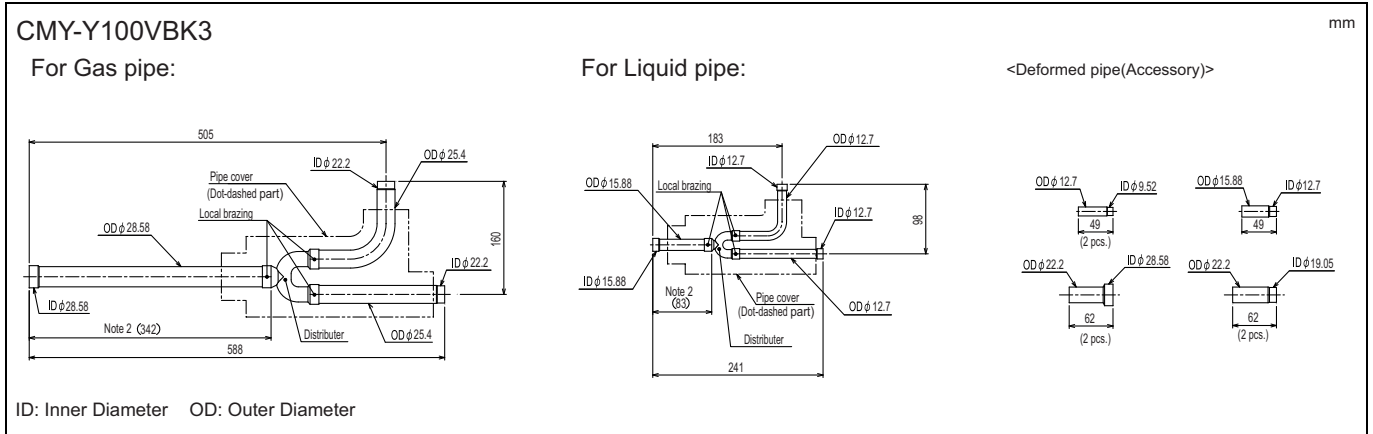

Note 1. Refer to the figure below for the installation position of the twinning pipe.

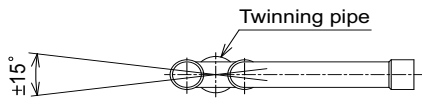

Slope of the twinning pipes are at an angle within $\pm 15^\circ$ to the horizontal plane.

2. Use the attached pipe to braze the port-opening of the twinning pipe.
3. Pipe diameter is indicated by inside diameter.
4. Only use the twinning pipe by Mitsubishi (optional parts).

9-4. RELAY BOX

If there is a risk that the drain water will freeze inside the outdoor unit, the installation of a base heater is recommended. PAC-BH02KTY-E is a relay box for controlling the electric base heater. For details, refer to the relay box Installation Manual.

Y (HIGH COP)

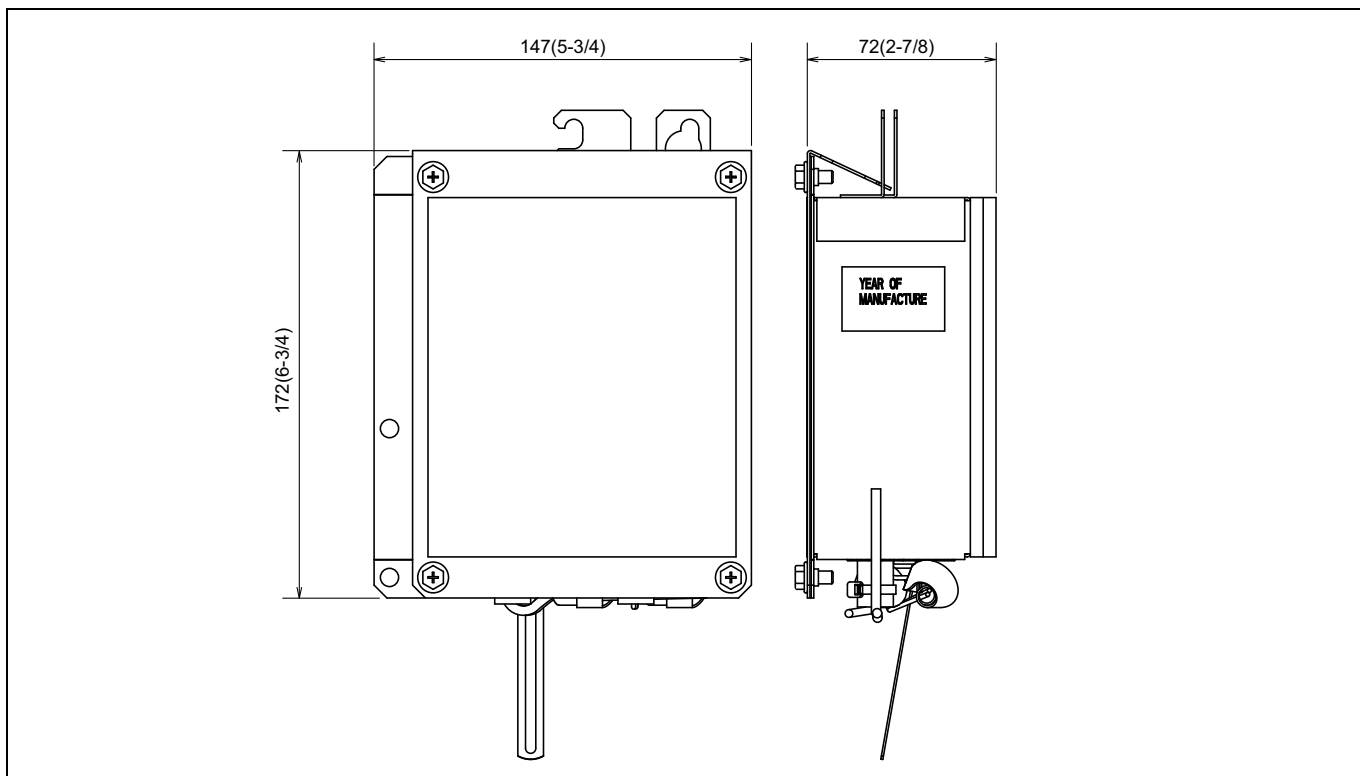

9-5. BASE HEATER

If there is a risk that the drain water will freeze inside the outdoor unit, the installation of a base heater is recommended. For details, refer to the base heater Installation Manual.

PAC-BH04EHT-E (for S module)

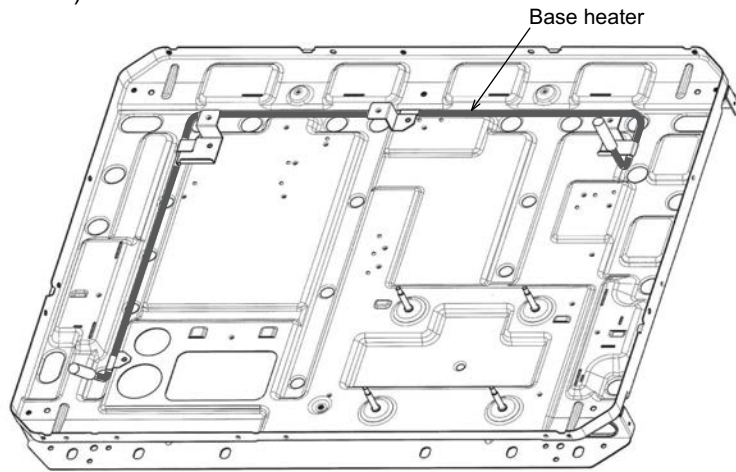

PAC-BH05EHT-E (for L module)

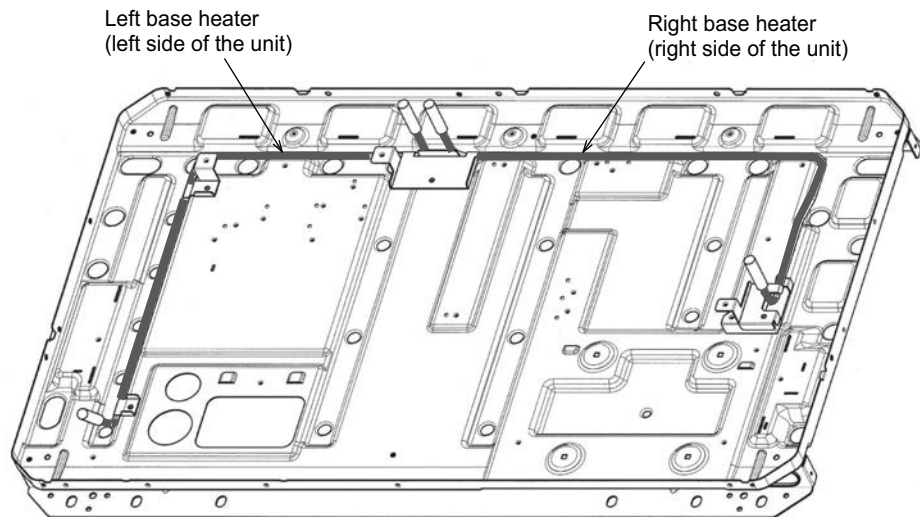

PAC-BH06EHT-E (for XL module)

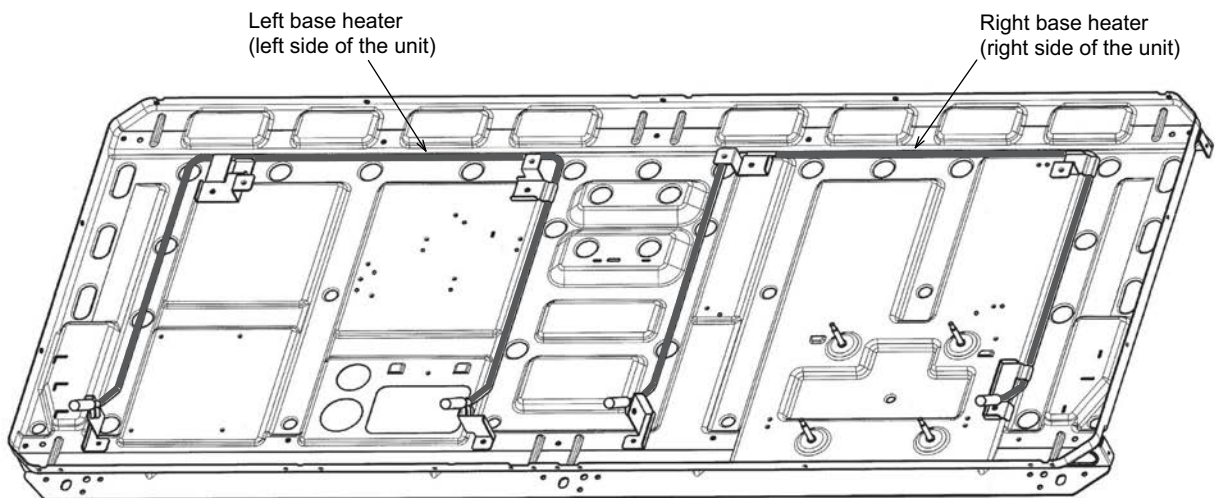

OUTDOOR UNITS

1. SPECIFICATIONS	2 - 214
2. EXTERNAL DIMENSIONS	2 - 229
3. CENTER OF GRAVITY	2 - 240
4. ELECTRICAL WIRING DIAGRAMS	2 - 241
5. SOUND LEVELS	2 - 243
6. VIBRATION LEVEL	2 - 249
7. OPERATION TEMPERATURE RANGE	2 - 250
8. CAPACITY TABLES	2 - 251
8-1. Selection of Cooling/Heating Units	2 - 252
8-2. Correction by temperature	2 - 254
8-3. Correction by total indoor	2 - 274
8-4. Correction by refrigerant piping length	2 - 283
8-5. Correction by port counts of the BC controller	2 - 286
8-6. Correction at frost and defrost	2 - 286
9. OPTIONAL PARTS	2 - 287
9-1. JOINT	2 - 287
9-2. OUTDOOR TWINNING KIT	2 - 288
9-3. JOINT KIT "CMY-R160-J1" FOR BC CONTROLLER	2 - 290
9-4. RELAY BOX	2 - 291
9-5. BASE HEATER	2 - 292

1. SPECIFICATIONS

YKB/YLM

Model			PURY-P200YLM-A1 (-BS)	PURY-P250YLM-A1 (-BS)	
Power source			3-phase 4-wire 380-400-415 V 50/60 Hz		
Cooling capacity (Nominal)	*1	kW	22.4	28.0	
		kcal/h	20,000	25,000	
		BTU/h	76,400	95,500	
	*1	Power input	kW	5.29	6.98
		Current input	A	8.9-8.4-8.1	11.7-11.1-10.7
		EER	kW/kW	4.23	4.01
Temp. range of cooling	*3	Indoor	W.B.	15.0~24.0°C (59~75°F)	
		Outdoor	D.B.	-5.0~46.0°C (23~115°F)	
Heating capacity (Nominal)	*2	kW	25.0	31.5	
		kcal/h	21,500	27,100	
		BTU/h	85,300	107,500	
	*2	Power input	kW	5.49	7.32
		Current input	A	9.2-8.8-8.4	12.3-11.7-11.3
		COP	kW/kW	4.55	4.30
Temp. range of heating	*3	Indoor	D.B.	15.0~27.0°C (59~81°F)	
		Outdoor	W.B.	-20.0~15.5°C (-4~60°F)	
Indoor unit connectable	Total capacity		50~150%		
	Model/Quantity		P15~P250/1~20		
Sound pressure level (measured in anechoic room)	dB <A>		59		
Sound power level (measured in anechoic room)	dB <A>		82.5		
Refrigerant piping diameter	High pressure		mm (in.) 15.88 (5/8) Brazed		
	Low pressure		mm (in.) 19.05 (3/4) Brazed		
FAN	Type x Quantity		Propeller fan x 1		
	Air flow rate	m ³ /min		185	
		L/s		3,083	
		cfm		6,532	
	Control, Driving mechanism		Inverter-control, Direct-driven by motor		
	Motor output	kW	0.92 x 1		
*4 External static press.		0 Pa (0 mmH ₂ O)			
Compressor	Type x Quantity		Inverter scroll hermetic compressor		
	Manufacture		AC&R Works, MITSUBISHI ELECTRIC CORPORATION		
	Starting method		Inverter		
	Motor output	kW	5.6		
	Case heater	kW	- (- V)		
	Lubricant		MEL32		
External finish			Pre-coated galvanized steel sheets (+powder coating for -BS type) <MUNSELL 5Y 8/1 or similar>		
External dimension H x W x D			mm 1,710 (1,650 without legs) x 920 x 740 in. 67-3/8 (65 without legs) x 36-1/4 x 29-3/16		
Protection devices	High pressure protection		High pressure sensor, High pressure switch at 4.15 MPa (601 psi)		
	Inverter circuit (COMP./FAN)		Over-heat protection, Over-current protection		
	Compressor		Over-heat protection		
	Fan motor		Over-current protection		
Refrigerant	Type x original charge		R410A x 9.5 kg (21 lbs)		
	Control		Indoor LEV and BC controller		
Net weight	kg (lbs)		205 (452)		
Heat exchanger			Salt-resistant cross fin & copper tube		
HIC circuit (HIC: Heat Inter-Changer)			-		
Defrosting method			Auto-defrost mode (Reversed refrigerant cycle, Hot gas)		
Drawing	External		WKJ94T176		
	Wiring		WKE94G041		
Standard attachment	Document		Installation Manual		
	Accessory		Refrigerant conn. pipe		
Optional parts			Joint: CMY-Y102SS-G2,CMY-Y102LS-G2,CMY-R160-J1 BC controller: CMB-P104,105,106,108,1010,1013,1016V-G1 Main BC controller: CMB-P108,1010,1013,1016V-GA1 Sub BC controller: CMB-P104,108V-GB1,CMB-P1016V-HB1		
Remarks			Details on foundation work, duct work, insulation work, electrical wiring, power source switch, and other items shall be referred to the Installation Manual. Due to continuing improvement, above specifications may be subject to change without notice.		

Notes:	Unit converter
1.Nominal cooling conditions (subject to JIS B8615-2) Indoor: 27°C D.B./19°C W.B. (81°F D.B./66°F W.B.), Outdoor: 35°C D.B./24°C W.B. (95°F D.B./75°F W.B.) Pipe length: 7.5 m (24-9/16 ft.), Level difference: 0 m (0 ft.)	BTU/h =kW x 3,412
2.Nominal heating conditions (subject to JIS B8615-2) Indoor: 20°C D.B. (68°F D.B.), Outdoor: 7°C D.B./6°C W.B. (45°F D.B./43°F W.B.) Pipe length: 7.5 m (24-9/16 ft.), Level difference: 0 m (0 ft.)	cfm =m ³ /min x 35.31
3.-5°C D.B. (23°F D.B.)/-6°C W.B. (21°F W.B.) to 21°C D.B. (70°F D.B.)/15.5°C W.B. (60°F W.B.) with cooling/heating mixed operation.	lbs =kg/0.4536
4.External static pressure option is available (30 Pa, 60 Pa/3.1 mmH ₂ O, 6.1 mmH ₂ O).	*Above specification data is subject to rounding variation.

1. SPECIFICATIONS

YKB/YLM

Model		PURY-P300YLM-A1 (-BS)		PURY-P350YLM-A1 (-BS)	
Power source		3-phase 4-wire 380-400-415 V 50/60 Hz		3-phase 4-wire 380-400-415 V 50/60 Hz	
Cooling capacity (Nominal)	*1	kW	33.5	40.0	
		kcal/h	30,000	35,000	
		BTU/h	114,300	136,500	
	Power input	kW	9.10	11.76	
		A	15.3-14.5-14.0	19.8-18.8-18.1	
EER	kW/kW	3.68	3.40		
Temp. range of cooling	*3 Indoor	W.B.	15.0~24.0°C (59~75°F)	15.0~24.0°C (59~75°F)	
	Outdoor	D.B.	-5.0~46.0°C (23~115°F)	-5.0~46.0°C (23~115°F)	
Heating capacity (Nominal)	*2	kW	37.5	45.0	
		kcal/h	32,300	40,000	
		BTU/h	128,000	153,500	
	Power input	kW	9.37	11.59	
		A	15.8-15.0-14.4	19.5-18.5-17.9	
COP	kW/kW	4.00	3.88		
Temp. range of heating	*3 Indoor	D.B.	15.0~27.0°C (59~81°F)	15.0~27.0°C (59~81°F)	
	Outdoor	W.B.	-20.0~15.5°C (-4~60°F)	-20.0~15.5°C (-4~60°F)	
Indoor unit connectable	Total capacity	50~150% of outdoor unit capacity		50~150% of outdoor unit capacity	
	Model/Quantity	P15~P250/1~30		P15~P250/1~35	
Sound pressure level (measured in anechoic room)	dB <A>	62.5		62.5	
Sound power level (measured in anechoic room)	dB <A>	86		86	
Refrigerant piping diameter	High pressure	mm (in.)	19.05 (3/4) Brazed	19.05 (3/4) Brazed	
	Low pressure	mm (in.)	22.2 (7/8) Brazed	28.58 (1-1/8) Brazed	
FAN	Type x Quantity		Propeller fan x 1		
	Air flow rate	m ³ /min	230	230	
		L/s	3,833	3,833	
		cfm	8,121	8,121	
	Control, Driving mechanism		Inverter-control, Direct-driven by motor		
	Motor output	kW	0.92 x 1	0.92 x 1	
*4 External static press.		0 Pa (0 mmH ₂ O)			
Compressor	Type x Quantity		Inverter scroll hermetic compressor		
	Manufacture		AC&R Works, MITSUBISHI ELECTRIC CORPORATION		
	Starting method		Inverter		
	Motor output	kW	8.1	10.5	
	Case heater	kW	- (- V)	- (- V)	
	Lubricant		MEL32		
External finish		Pre-coated galvanized steel sheets (+powder coating for -BS type) <MUNSELL 5Y 8/1 or similar>			
External dimension H x W x D	mm		1,710 (1,650 without legs) x 1,220 x 740		
	in.		67-3/8 (65 without legs) x 48-1/16 x 29-3/16		
Protection devices	High pressure protection		High pressure sensor, High pressure switch at 4.15 MPa (601 psi)		
	Inverter circuit (COMP./FAN)		Over-heat protection, Over-current protection		
	Compressor		Over-heat protection		
	Fan motor		Over-current protection		
Refrigerant	Type x original charge		R410A x 10.3 kg (23 lbs)		
	Control		Indoor LEV and BC controller		
Net weight	kg (lbs)	248 (547)			
Heat exchanger		Salt-resistant cross fin & copper tube			
HIC circuit (HIC: Heat Inter-Changer)		-			
Defrosting method		Auto-defrost mode (Reversed refrigerant cycle, Hot gas)			
Drawing	External	WKJ94T177			
	Wiring	WKE94G041			
Standard attachment	Document	Installation Manual			
	Accessory	Refrigerant conn. pipe			
Optional parts		Joint: CMY-Y102SS-G2,CMY-Y102LS-G2,CMY-R160-J1 BC controller: CMB-P104,105,106,108,1010,1013,1016V-G1 Main BC controller: CMB-P108,1010,1013,1016V-GA1 Sub BC controller: CMB-P104,108V-GB1,CMB-P1016V-HB1			
Remarks		Details on foundation work, duct work, insulation work, electrical wiring, power source switch, and other items shall be referred to the Installation Manual. Due to continuing improvement, above specifications may be subject to change without notice.			

Notes:	Unit converter
1.Nominal cooling conditions (subject to JIS B8615-2) Indoor: 27°C.D.B./19°C.W.B. (81°F.D.B./66°F.W.B.), Outdoor: 35°C.D.B./24°C.W.B. (95°F.D.B./75°F.W.B.) Pipe length: 7.5 m (24-9/16 ft.), Level difference: 0 m (0 ft.)	BTU/h =kW x 3,412
2.Nominal heating conditions (subject to JIS B8615-2) Indoor: 20°C.D.B. (68°F.D.B.), Outdoor: 7°C.D.B./6°C.W.B. (45°F.D.B./43°F.W.B.) Pipe length: 7.5 m (24-9/16 ft.), Level difference: 0 m (0 ft.)	cfm =m ³ /min x 35.31
3.-5°C.D.B. (23°F.D.B.)/-6°C.W.B. (21°F.W.B.) to 21°C.D.B. (70°F.D.B.)/15.5°C.W.B. (60°F.W.B.) with cooling/heating mixed operation.	lbs =kg/0.4536
4.External static pressure option is available (30 Pa, 60 Pa/3.1 mmH ₂ O, 6.1 mmH ₂ O).	*Above specification data is subject to rounding variation.

1. SPECIFICATIONS

YKB/YLM

Model			PURY-P400YLM-A1 (-BS)	PURY-P450YLM-A1 (-BS)	
Power source			3-phase 4-wire 380-400-415 V 50/60 Hz	3-phase 4-wire 380-400-415 V 50/60 Hz	
Cooling capacity (Nominal)	*1	kW	45.0	50.0	
		kcal/h	40,000	45,000	
		BTU/h	153,500	170,600	
	*1	Power input	kW	13.71	14.32
		Current input	A	23.1-21.9-21.1	24.1-22.9-22.1
		EER	kW/kW	3.28	3.49
Temp. range of cooling	*3	Indoor	W.B.	15.0~24.0°C (59~75°F)	
		Outdoor	D.B.	-5.0~46.0°C (23~115°F)	
Heating capacity (Nominal)	*2	kW	45.0	56.0	
		kcal/h	40,000	50,000	
		BTU/h	153,500	191,100	
	*2	Power input	kW	11.42	14.93
		Current input	A	19.2-18.3-17.6	25.2-23.9-23.0
		COP	kW/kW	3.94	3.75
Temp. range of heating	*3	Indoor	D.B.	15.0~27.0°C (59~81°F)	
		Outdoor	W.B.	-20.0~15.5°C (-4~60°F)	
Indoor unit connectable	Total capacity		50~150% of outdoor unit capacity	50~150% of outdoor unit capacity	
	Model/Quantity		P15~P250/1~40	P15~P250/1~45	
Sound pressure level (measured in anechoic room)		dB <A>	62.5	62.5	
Sound power level (measured in anechoic room)		dB <A>	86	86	
Refrigerant piping diameter	High pressure		mm (in.)	22.2 (7/8) Brazed	
	Low pressure		mm (in.)	28.58 (1-1/8) Brazed	
FAN	Type x Quantity		Propeller fan x 1	Propeller fan x 2	
	Air flow rate	m ³ /min	230	320	
		L/s	3,833	5,333	
		cfm	8,121	11,299	
	Control, Driving mechanism		Inverter-control, Direct-driven by motor	Inverter-control, Direct-driven by motor	
	Motor output	kW	0.92 x 1	0.92 x 2	
*4 External static press.		0 Pa (0 mmH ₂ O)	0 Pa (0 mmH ₂ O)		
Compressor	Type x Quantity		Inverter scroll hermetic compressor	Inverter scroll hermetic compressor	
	Manufacture		AC&R Works, MITSUBISHI ELECTRIC CORPORATION	AC&R Works, MITSUBISHI ELECTRIC CORPORATION	
	Starting method		Inverter	Inverter	
	Motor output	kW	10.9	12.4	
	Case heater	kW	- (- V)	- (- V)	
	Lubricant		MEL32	MEL32	
External finish			Pre-coated galvanized steel sheets (+powder coating for -BS type) <MUNSELL 5Y 8/1 or similar>	Pre-coated galvanized steel sheets (+powder coating for -BS type) <MUNSELL 5Y 8/1 or similar>	
External dimension H x W x D		mm	1,710 (1,650 without legs) x 1,220 x 740	1,710 (1,650 without legs) x 1,750 x 740	
		in.	67-3/8 (65 without legs) x 48-1/16 x 29-3/16	67-3/8 (65 without legs) x 68-15/16 x 29-3/16	
Protection devices	High pressure protection		High pressure sensor, High pressure switch at 4.15 MPa (601 psi)	High pressure sensor, High pressure switch at 4.15 MPa (601 psi)	
	Inverter circuit (COMP./FAN)		Over-heat protection, Over-current protection	Over-heat protection, Over-current protection	
	Compressor		Over-heat protection	Over-heat protection	
	Fan motor		Over-current protection	Over-current protection	
Refrigerant	Type x original charge		R410A x 10.3 kg (23 lbs)	R410A x 11.8 kg (27 lbs)	
	Control		Indoor LEV and BC controller	Indoor LEV and BC controller	
Net weight		kg (lbs)	246 (543)	321 (708)	
Heat exchanger			Salt-resistant cross fin & copper tube	Salt-resistant cross fin & copper tube	
HIC circuit (HIC: Heat Inter-Changer)			-	-	
Defrosting method			Auto-defrost mode (Reversed refrigerant cycle, Hot gas)	Auto-defrost mode (Reversed refrigerant cycle, Hot gas)	
Drawing	External		WKJ94T177	WKJ94T178	
	Wiring		WKE94G041	WKE94G042	
Standard attachment	Document		Installation Manual	Installation Manual	
	Accessory		Refrigerant conn. pipe	Refrigerant conn. pipe	
Optional parts			Joint: CMY-Y102SS-G2,CMY-Y102LS-G2,CMY-R160-J1 Main BC controller: CMB-P108,1010,1013,1016V-GA1 Sub BC controller: CMB-P104,108V-GB1,CMB-P1016V-HB1	Joint: CMY-Y102SS-G2,CMY-Y102LS-G2,CMY-R160-J1 Main BC controller: CMB-P108,1010,1013,1016V-GA1 Sub BC controller: CMB-P104,108V-GB1,CMB-P1016V-HB1	
Remarks			Details on foundation work, duct work, insulation work, electrical wiring, power source switch, and other items shall be referred to the Installation Manual. Due to continuing improvement, above specifications may be subject to change without notice.		

Notes:	Unit converter
1.Nominal cooling conditions (subject to JIS B8615-2) Indoor: 27°C D.B./19°C W.B. (81°F D.B./66°F W.B.), Outdoor: 35°C D.B./24°C W.B. (95°F D.B./75°F W.B.) Pipe length: 7.5 m (24-9/16 ft.), Level difference: 0 m (0 ft.)	BTU/h =kW x 3,412
2.Nominal heating conditions (subject to JIS B8615-2) Indoor: 20°C D.B. (68°F D.B.), Outdoor: 7°C D.B./6°C W.B. (45°F D.B./43°F W.B.) Pipe length: 7.5 m (24-9/16 ft.), Level difference: 0 m (0 ft.)	cfm =m ³ /min x 35.31
3.-5°C D.B. (23°F D.B.)/-6°C W.B. (21°F W.B.) to 21°C D.B. (70°F D.B.)/15.5°C W.B. (60°F W.B.) with cooling/heating mixed operation.	lbs =kg/0.4536
4.External static pressure option is available (30 Pa, 60 Pa/3.1 mmH ₂ O, 6.1 mmH ₂ O).	*Above specification data is subject to rounding variation.

1. SPECIFICATIONS

YKB/YLM

R2

Model		PURY-P500YLM-A1 (-BS)		
Power source		3-phase 4-wire 380-400-415 V 50/60 Hz		
Cooling capacity (Nominal)	*1	kW	56.0	
		kcal/h	50,000	
	*1	BTU/h	191,100	
		Power input	kW	17.77
		Current input	A	29.9-28.4-27.4
	EER	kW/kW	3.15	
Temp. range of cooling	*3	Indoor	W.B.	15.0~24.0°C (59~75°F)
		Outdoor	D.B.	-5.0~46.0°C (23~115°F)
Heating capacity (Nominal)	*2	kW	58.0	
		kcal/h	50,000	
	*2	BTU/h	197,900	
		Power input	kW	16.06
		Current input	A	27.1-25.7-24.8
	COP	kW/kW	3.61	
Temp. range of heating	*3	Indoor	D.B.	15.0~27.0°C (59~81°F)
		Outdoor	W.B.	-20.0~15.5°C (-4~60°F)
Indoor unit connectable	Total capacity		50~150% of outdoor unit capacity	
	Model/Quantity		P15~P250/1~50	
Sound pressure level (measured in anechoic room)		dB <A>	63.5	
Sound power level (measured in anechoic room)		dB <A>	87	
Refrigerant piping diameter	High pressure		mm (in.)	22.2 (7/8) Brazed
	Low pressure		mm (in.)	28.58 (1-1/8) Brazed
FAN	Type x Quantity		Propeller fan x 2	
	Air flow rate	m ³ /min	380	
		L/s	6,333	
		cfm	13,418	
	Control, Driving mechanism		Inverter-control, Direct-driven by motor	
*4	Motor output	kW	0.92 x 2	
External static press.		0 Pa (0 mmH ₂ O)		
Compressor	Type x Quantity		Inverter scroll hermetic compressor	
	Manufacture		AC&R Works, MITSUBISHI ELECTRIC CORPORATION	
	Starting method		Inverter	
	Motor output	kW	13.4	
	Case heater	kW	- (- V)	
Lubricant		MEL32		
External finish		Pre-coated galvanized steel sheets (+powder coating for -BS type) <MUNSELL 5Y 8/1 or similar>		
External dimension H x W x D		mm	1,710 (1,650 without legs) x 1,750 x 740	
		in.	67-3/8 (65 without legs) x 68-15/16 x 29-3/16	
Protection devices	High pressure protection		High pressure sensor, High pressure switch at 4.15 MPa (601 psi)	
	Inverter circuit (COMP./FAN)		Over-heat protection, Over-current protection	
	Compressor		Over-heat protection	
	Fan motor		Over-current protection	
Refrigerant	Type x original charge		R410A x 11.8 kg (27 lbs)	
	Control		Indoor LEV and BC controller	
Net weight		kg (lbs)	321 (708)	
Heat exchanger		Salt-resistant cross fin & copper tube		
HIC circuit (HIC: Heat Inter-Changer)		-		
Defrosting method		Auto-defrost mode (Reversed refrigerant cycle, Hot gas)		
Drawing	External		WKJ94T178	
	Wiring		WKE94G042	
Standard attachment	Document		Installation Manual	
	Accessory		Refrigerant conn. pipe	
Optional parts		Joint: CMY-Y102SS-G2, CMY-Y102LS-G2, CMY-R160-J1 Main BC controller: CMB-P108, 1010, 1013, 1016V-GA1 Sub BC controller: CMB-P104, 108V-GB1, CMB-P1016V-HB1		
Remarks		Details on foundation work, duct work, insulation work, electrical wiring, power source switch, and other items shall be referred to the Installation Manual. Due to continuing improvement, above specifications may be subject to change without notice.		

Notes:	Unit converter
1. Nominal cooling conditions (subject to JIS B8615-2) Indoor: 27°C D.B./19°C W.B. (81°F D.B./66°F W.B.), Outdoor: 35°C D.B./24°C W.B. (95°F D.B./75°F W.B.) Pipe length: 7.5 m (24-9/16 ft.), Level difference: 0 m (0 ft.)	BTU/h = kW x 3,412
2. Nominal heating conditions (subject to JIS B8615-2) Indoor: 20°C D.B. (68°F D.B.), Outdoor: 7°C D.B./6°C W.B. (45°F D.B./43°F W.B.) Pipe length: 7.5 m (24-9/16 ft.), Level difference: 0 m (0 ft.)	cfm = m ³ /min x 35.31
3. -5°C D.B. (23°F D.B.)/-6°C W.B. (21°F W.B.) to 21°C D.B. (70°F D.B.)/15.5°C W.B. (60°F W.B.) with cooling/heating mixed operation.	lbs = kg/0.4536
4. External static pressure option is available (30 Pa, 60 Pa/3.1 mmH ₂ O, 6.1 mmH ₂ O).	*Above specification data is subject to rounding variation.

1. SPECIFICATIONS

YKB/YLM

Model		PURY-P400YSLM-A1 (-BS)	
Power source		3-phase 4-wire 380-400-415 V 50/60 Hz	
Cooling capacity (Nominal)	*1	kW	45.0
		kcal/h	40,000
		BTU/h	153,500
	Power input	kW	10.97
		A	18.5-17.5-16.9
EER	kW/kW	4.10	
Temp. range of cooling	*3 Indoor	W.B.	15.0~24.0°C (59~75°F)
	Outdoor	D.B.	-5.0~46.0°C (23~115°F)
Heating capacity (Nominal)	*2	kW	50.0
		kcal/h	45,000
		BTU/h	170,600
	Power input	kW	10.98
		A	18.5-17.6-16.9
COP	kW/kW	4.55	
Temp. range of heating	*3 Indoor	D.B.	15.0~27.0°C (59~81°F)
	Outdoor	W.B.	-20.0~15.5°C (-4~60°F)
Indoor unit connectable	Total capacity		50~150% of outdoor unit capacity
	Model/Quantity		P15~P250/1~40
Sound pressure level (measured in anechoic room)		dB <A>	62
Sound power level (measured in anechoic room)		dB <A>	85.5
Refrigerant piping diameter	High pressure		22.2 (7/8) Brazed
	Low pressure		28.58 (1-1/8) Brazed

Set Model				
Model		PURY-P200YLM-A1 (-BS)	PURY-P200YLM-A1 (-BS)	
FAN	Type x Quantity	Propeller fan x 1	Propeller fan x 1	
	Air flow rate	m ³ /min	185	185
		L/s	3,083	3,083
		cfm	6,532	6,532
	Control, Driving mechanism		Inverter-control, Direct-driven by motor	Inverter-control, Direct-driven by motor
	Motor output	kW	0.92 x 1	0.92 x 1
*4 External static press.		0 Pa (0 mmH ₂ O)	0 Pa (0 mmH ₂ O)	
Compressor	Type x Quantity	Inverter scroll hermetic compressor	Inverter scroll hermetic compressor	
	Manufacture		AC&R Works, MITSUBISHI ELECTRIC CORPORATION	
	Starting method		Inverter	
	Motor output	kW	5.6	
	Case heater	kW	- (- V)	
Lubricant		MEL32	MEL32	
External finish		Pre-coated galvanized steel sheets (+powder coating for -BS type) <MUNSELL 5Y 8/1 or similar>	Pre-coated galvanized steel sheets (+powder coating for -BS type) <MUNSELL 5Y 8/1 or similar>	
External dimension H x W x D	mm	1,710 (1,650 without legs) x 920 x 740	1,710 (1,650 without legs) x 920 x 740	
	in.	67-3/8 (65 without legs) x 36-1/4 x 29-3/16	67-3/8 (65 without legs) x 36-1/4 x 29-3/16	
Protection devices	High pressure protection		High pressure sensor, High pressure switch at 4.15 MPa (601 psi)	
	Inverter circuit (COMP./FAN)		Over-heat protection, Over-current protection	
	Compressor		Over-heat protection	
	Fan motor		Over-current protection	
Refrigerant	Type x original charge		R410A x 9.5 kg (21 lbs)	
	Control		Indoor LEV and BC controller	
Net weight	kg (lbs)	205 (452)	205 (452)	
Heat exchanger		Salt-resistant cross fin & copper tube		
HIC circuit (HIC: Heat Inter-Changer)				
Pipe between unit and distributor	High pressure	mm (in.)	15.88 (5/8) Brazed	
	Low pressure	mm (in.)	19.05 (3/4) Brazed	
Defrosting method				
Drawing	External		WKJ94T179	
	Wiring		WKE94G041	
Standard attachment	Document		Installation Manual	
	Accessory		Refrigerant conn. pipe	
Optional parts				
Outdoor Twinning kit: CMY-R100VBK-A Joint: CMY-Y102S-G2, CMY-Y102L-G2, CMY-R160-J1 Main BC controller: CMB-P108, 1010, 1013, 1016V-GA1 Sub BC controller: CMB-P104, 108V-GB1, CMB-P1016V-HB1				
Remarks		Details on foundation work, duct work, insulation work, electrical wiring, power source switch, and other items shall be referred to the Installation Manual. Due to continuing improvement, above specifications may be subject to change without notice.		

Notes:	Unit converter
1. Nominal cooling conditions (subject to JIS B8615-2) Indoor: 27°C D.B./19°C W.B. (81°F D.B./66°F W.B.), Outdoor: 35°C D.B./24°C W.B. (95°F D.B./75°F W.B.) Pipe length: 7.5 m (24-9/16 ft.), Level difference: 0 m (0 ft.)	BTU/h = kW x 3.412
2. Nominal heating conditions (subject to JIS B8615-2) Indoor: 20°C D.B. (68°F D.B.), Outdoor: 7°C D.B./6°C W.B. (45°F D.B./43°F W.B.) Pipe length: 7.5 m (24-9/16 ft.), Level difference: 0 m (0 ft.)	cfm = m ³ /min x 35.31
3. -5°C D.B. (23°F D.B.)/-6°C W.B. (21°F W.B.) to 21°C D.B. (70°F D.B.)/15.5°C W.B. (60°F W.B.) with cooling/heating mixed operation.	lbs = kg/0.4536
4. External static pressure option is available (30 Pa, 60 Pa/3.1 mmH ₂ O, 6.1 mmH ₂ O).	*Above specification data is subject to rounding variation.

1. SPECIFICATIONS

Model			PURY-P450YSLM-A1 (-BS)	
Power source			3-phase 4-wire 380-400-415 V 50/60 Hz	
Cooling capacity (Nominal)	*1	kW	50.0	
		kcal/h	45,000	
		BTU/h	170,600	
	Power input	kW	12.50	
		A	21.1-20.0-19.3	
EER	kW/kW	4.00		
Temp. range of cooling	*3 Indoor	W.B.	15.0~24.0°C (59~75°F)	
	Outdoor	D.B.	-5.0~46.0°C (23~115°F)	
Heating capacity (Nominal)	*2	kW	56.0	
		kcal/h	48,200	
		BTU/h	191,100	
	Power input	kW	12.64	
		A	21.3-20.2-19.5	
COP	kW/kW	4.43		
Temp. range of heating	*3 Indoor	D.B.	15.0~27.0°C (59~81°F)	
	Outdoor	W.B.	-20.0~15.5°C (-4~60°F)	
Indoor unit connectable	Total capacity		50~150% of outdoor unit capacity	
	Model/Quantity		P15-P250/1-45	
Sound pressure level (measured in anechoic room)		dB <A>	62.5	
Sound power level (measured in anechoic room)		dB <A>	86	
Refrigerant piping diameter	High pressure	mm (in.)	22.2 (7/8) Brazed	
	Low pressure	mm (in.)	28.58 (1-1/8) Brazed	

Set Model			PURY-P200YLM-A1 (-BS)		PURY-P250YLM-A1 (-BS)	
Model			Propeller fan x 1		Propeller fan x 1	
FAN	Type x Quantity		185		185	
	Air flow rate	m ³ /min	3,083		3,083	
		L/s	6,532		6,532	
		cfm				
	Control, Driving mechanism		Inverter-control, Direct-driven by motor		Inverter-control, Direct-driven by motor	
*4 Motor output	kW	0.92 x 1		0.92 x 1		
External static press.		0 Pa (0 mmH ₂ O)		0 Pa (0 mmH ₂ O)		
Compressor			Inverter scroll hermetic compressor		Inverter scroll hermetic compressor	
Manufacture			AC&R Works, MITSUBISHI ELECTRIC CORPORATION		AC&R Works, MITSUBISHI ELECTRIC CORPORATION	
Starting method			Inverter		Inverter	
Motor output		kW	5.6		6.9	
Case heater		kW	- (- V)		- (- V)	
Lubricant			MEL32		MEL32	
External finish			Pre-coated galvanized steel sheets (+powder coating for -BS type) <MUNSELL 5Y 8/1 or similar>		Pre-coated galvanized steel sheets (+powder coating for -BS type) <MUNSELL 5Y 8/1 or similar>	
External dimension H x W x D		mm	1,710 (1,650 without legs) x 920 x 740		1,710 (1,650 without legs) x 920 x 740	
		in.	67-3/8 (65 without legs) x 36-1/4 x 29-3/16		67-3/8 (65 without legs) x 36-1/4 x 29-3/16	
Protection devices	High pressure protection		High pressure sensor, High pressure switch at 4.15 MPa (601 psi)		High pressure sensor, High pressure switch at 4.15 MPa (601 psi)	
	Inverter circuit (COMP./FAN)		Over-heat protection, Over-current protection		Over-heat protection, Over-current protection	
	Compressor		Over-heat protection		Over-heat protection	
	Fan motor		Over-current protection		Over-current protection	
Refrigerant	Type x original charge		R410A x 9.5 kg (21 lbs)		R410A x 9.5 kg (21 lbs)	
	Control		Indoor LEV and BC controller			
Net weight		kg (lbs)	205 (452)		205 (452)	
Heat exchanger			Salt-resistant cross fin & copper tube		Salt-resistant cross fin & copper tube	
HIC circuit (HIC: Heat Inter-Changer)			-		-	
Pipe between unit and distributor	High pressure	mm (in.)	15.88 (5/8) Brazed		19.05 (3/4) Brazed	
	Low pressure	mm (in.)	19.05 (3/4) Brazed		-	
Defrosting method			Auto-defrost mode (Reversed refrigerant cycle, Hot gas)			
Drawing	External		WKJ94T179			
	Wiring		WKE94G041		WKE94G041	
Standard attachment	Document		Installation Manual			
	Accessory		Refrigerant conn. pipe			
Optional parts			Outdoor Twinning kit: CMY-R100VBK-A Joint: CMY-Y102S-G2, CMY-Y102L-G2, CMY-R160-J1 Main BC controller: CMB-P108, 1010, 1013, 1016V-GA1 Sub BC controller: CMB-P104, 108V-GB1, CMB-P1016V-HB1			
Remarks			Details on foundation work, duct work, insulation work, electrical wiring, power source switch, and other items shall be referred to the Installation Manual. Due to continuing improvement, above specifications may be subject to change without notice.			

Notes:	Unit converter
1. Nominal cooling conditions (subject to JIS B8615-2) Indoor: 27°C D.B./19°C W.B. (81°F D.B./66°F W.B.), Outdoor: 35°C D.B./24°C W.B. (95°F D.B./75°F W.B.) Pipe length: 7.5 m (24-9/16 ft.), Level difference: 0 m (0 ft.)	BTU/h = kW x 3,412
2. Nominal heating conditions (subject to JIS B8615-2) Indoor: 20°C D.B. (68°F D.B.), Outdoor: 7°C D.B./6°C W.B. (45°F D.B./43°F W.B.) Pipe length: 7.5 m (24-9/16 ft.), Level difference: 0 m (0 ft.)	cfm = m ³ /min x 35.31
3. -5°C D.B. (23°F D.B.)/-6°C W.B. (21°F W.B.) to 21°C D.B. (70°F D.B.)/15.5°C W.B. (60°F W.B.) with cooling/heating mixed operation.	lbs = kg/0.4536
4. External static pressure option is available (30 Pa, 60 Pa/3.1 mmH ₂ O, 6.1 mmH ₂ O).	*Above specification data is subject to rounding variation.

1. SPECIFICATIONS

YKB/YLM

Model			PURY-P500YSLM-A1 (-BS)		
Power source			3-phase 4-wire 380-400-415 V 50/60 Hz		
Cooling capacity (Nominal)	*1	kW	56.0		
		kcal/h	50,000		
		BTU/h	191,100		
	Power input	kW	14.39		
		A	24.2-23.0-22.2		
EER	kW/kW	3.89			
Temp. range of cooling	*3 Indoor	W.B.	15.0~24.0°C (59~75°F)		
	Outdoor	D.B.	-5.0~46.0°C (23~115°F)		
Heating capacity (Nominal)	*2	kW	63.0		
		kcal/h	54,200		
		BTU/h	215,000		
	Power input	kW	14.65		
		A	24.7-23.4-22.6		
COP	kW/kW	4.30			
Temp. range of heating	*3 Indoor	D.B.	15.0~27.0°C (59~81°F)		
	Outdoor	W.B.	-20.0~15.5°C (-4~60°F)		
Indoor unit connectable	Total capacity		50~150% of outdoor unit capacity		
	Model/Quantity		P15~P250/1~50		
Sound pressure level (measured in anechoic room)		dB <A>	63		
Sound power level (measured in anechoic room)		dB <A>	86.5		
Refrigerant piping diameter	High pressure	mm (in.)	22.2 (7/8) Brazed		
	Low pressure	mm (in.)	28.58 (1-1/8) Brazed		

Set Model					
Model		PURY-P250YLM-A1 (-BS)		PURY-P250YLM-A1 (-BS)	
FAN	Type x Quantity		Propeller fan x 1		Propeller fan x 1
	Air flow rate	m ³ /min	185		185
		L/s	3,083		3,083
		cfm	6,532		6,532
	Control, Driving mechanism		Inverter-control, Direct-driven by motor		Inverter-control, Direct-driven by motor
*4 Motor output	kW	0.92 x 1		0.92 x 1	
External static press.		0 Pa (0 mmH ₂ O)		0 Pa (0 mmH ₂ O)	
Compressor	Type x Quantity		Inverter scroll hermetic compressor		Inverter scroll hermetic compressor
	Manufacture		AC&R Works, MITSUBISHI ELECTRIC CORPORATION		AC&R Works, MITSUBISHI ELECTRIC CORPORATION
	Starting method		Inverter		Inverter
	Motor output	kW	6.9		6.9
	Case heater	kW	- (- V)		- (- V)
Lubricant		MEL32		MEL32	
External finish		Pre-coated galvanized steel sheets (+powder coating for -BS type) <MUNSELL 5Y 8/1 or similar>		Pre-coated galvanized steel sheets (+powder coating for -BS type) <MUNSELL 5Y 8/1 or similar>	
External dimension H x W x D		mm	1,710 (1,650 without legs) x 920 x 740		1,710 (1,650 without legs) x 920 x 740
		in.	67-3/8 (65 without legs) x 36-1/4 x 29-3/16		67-3/8 (65 without legs) x 36-1/4 x 29-3/16
Protection devices	High pressure protection		High pressure sensor, High pressure switch at 4.15 MPa (601 psi)		High pressure sensor, High pressure switch at 4.15 MPa (601 psi)
	Inverter circuit (COMP./FAN)		Over-heat protection, Over-current protection		Over-heat protection, Over-current protection
	Compressor		Over-heat protection		Over-heat protection
	Fan motor		Over-current protection		Over-current protection
Refrigerant	Type x original charge		R410A x 9.5 kg (21 lbs)		R410A x 9.5 kg (21 lbs)
	Control		Indoor LEV and BC controller		
Net weight		kg (lbs)	205 (452)		205 (452)
Heat exchanger		Salt-resistant cross fin & copper tube			
HIC circuit (HIC: Heat Inter-Changer)		-			
Pipe between unit and distributor	High pressure	mm (in.)	19.05 (3/4) Brazed		19.05 (3/4) Brazed
	Low pressure	mm (in.)	22.2 (7/8) Brazed		-
Defrosting method		Auto-defrost mode (Reversed refrigerant cycle, Hot gas)			
Drawing	External		WKJ94T179		
	Wiring		WKE94G041		WKE94G041
Standard attachment	Document		Installation Manual		
	Accessory		Refrigerant conn. pipe		
Optional parts		Outdoor Twinning kit: CMY-R100VBK-A Joint: CMY-Y102S-G2, CMY-Y102L-G2, CMY-R160-J1 Main BC controller: CMB-P108, 1010, 1013, 1016V-GA1 Sub BC controller: CMB-P104, 108V-GB1, CMB-P1016V-HB1			
Remarks		Details on foundation work, duct work, insulation work, electrical wiring, power source switch, and other items shall be referred to the Installation Manual. Due to continuing improvement, above specifications may be subject to change without notice.			

Notes:		Unit converter
1. Nominal cooling conditions (subject to JIS B8615-2) Indoor: 27°C D.B./19°C W.B. (81°F D.B./66°F W.B.), Outdoor: 35°C D.B./24°C W.B. (95°F D.B./75°F W.B.) Pipe length: 7.5 m (24-9/16 ft.), Level difference: 0 m (0 ft.)		BTU/h = kW x 3,412
2. Nominal heating conditions (subject to JIS B8615-2) Indoor: 20°C D.B. (68°F D.B.), Outdoor: 7°C D.B./6°C W.B. (45°F D.B./43°F W.B.) Pipe length: 7.5 m (24-9/16 ft.), Level difference: 0 m (0 ft.)		cfm = m ³ /min x 35.31
3. -5°C D.B. (23°F D.B.)/-6°C W.B. (21°F W.B.) to 21°C D.B. (70°F D.B.)/15.5°C W.B. (60°F W.B.) with cooling/heating mixed operation.		lbs = kg/0.4536
4. External static pressure option is available (30 Pa, 60 Pa/3.1 mmH ₂ O, 6.1 mmH ₂ O).		*Above specification data is subject to rounding variation.

1. SPECIFICATIONS

Model			PURY-P550YSLM-A1 (-BS)	
Power source			3-phase 4-wire 380-400-415 V 50/60 Hz	
Cooling capacity (Nominal)	*1	kW	63.0	
		kcal/h	54,200	
		BTU/h	215,000	
	Power input	kW	16.89	
		Current input	A	28.5-27.0-26.1
EER		kW/kW	3.73	
Temp. range of cooling	*3 Indoor	W.B.	15.0~24.0°C (59~75°F)	
	Outdoor	D.B.	-5.0~46.0°C (23~115°F)	
Heating capacity (Nominal)	*2	kW	69.0	
		kcal/h	59,300	
		BTU/h	235,400	
	Power input	kW	16.62	
		Current input	A	28.0-26.6-25.6
COP		kW/kW	4.15	
Temp. range of heating	*3 Indoor	D.B.	15.0~27.0°C (59~81°F)	
	Outdoor	W.B.	-20.0~15.5°C (-4~60°F)	
Indoor unit connectable	Total capacity		50~150% of outdoor unit capacity	
	Model/Quantity		P15-P250/2-50	
Sound pressure level (measured in anechoic room)		dB <A>	64.5	
Sound power level (measured in anechoic room)		dB <A>	88	
Refrigerant piping diameter	High pressure	mm (in.)	28.58 (1-1/8) Brazed	
	Low pressure	mm (in.)	28.58 (1-1/8) Brazed	

Set Model

Model			PURY-P250YLM-A1 (-BS)		PURY-P300YLM-A1 (-BS)	
FAN	Type x Quantity		Propeller fan x 1		Propeller fan x 1	
	Air flow rate	m ³ /min	185		230	
		L/s	3,083		3,833	
		cfm	6,532		8,121	
	Control, Driving mechanism		Inverter-control, Direct-driven by motor		Inverter-control, Direct-driven by motor	
	*4 Motor output	kW	0.92 x 1		0.92 x 1	
External static press.		0 Pa (0 mmH ₂ O)		0 Pa (0 mmH ₂ O)		
Compressor	Type x Quantity		Inverter scroll hermetic compressor		Inverter scroll hermetic compressor	
	Manufacture		AC&R Works, MITSUBISHI ELECTRIC CORPORATION		AC&R Works, MITSUBISHI ELECTRIC CORPORATION	
	Starting method		Inverter		Inverter	
	Motor output	kW	6.9		8.1	
	Case heater	kW	- (- V)		- (- V)	
Lubricant		MEL32		MEL32		
External finish			Pre-coated galvanized steel sheets (+powder coating for -BS type) <MUNSELL 5Y 8/1 or similar>		Pre-coated galvanized steel sheets (+powder coating for -BS type) <MUNSELL 5Y 8/1 or similar>	
External dimension H x W x D			mm 1,710 (1,650 without legs) x 920 x 740		mm 1,710 (1,650 without legs) x 1,220 x 740	
			in. 67-3/8 (65 without legs) x 36-1/4 x 29-3/16		in. 67-3/8 (65 without legs) x 48-1/16 x 29-3/16	
Protection devices	High pressure protection		High pressure sensor, High pressure switch at 4.15 MPa (601 psi)		High pressure sensor, High pressure switch at 4.15 MPa (601 psi)	
	Inverter circuit (COMP./FAN)		Over-heat protection, Over-current protection		Over-heat protection, Over-current protection	
	Compressor		Over-heat protection		Over-heat protection	
	Fan motor		Over-current protection		Over-current protection	
Refrigerant	Type x original charge		R410A x 9.5 kg (21 lbs)		R410A x 10.3 kg (23 lbs)	
	Control		Indoor LEV and BC controller			
Net weight		kg (lbs)	205 (452)		248 (547)	
Heat exchanger			Salt-resistant cross fin & copper tube		Salt-resistant cross fin & copper tube	
HIC circuit (HIC: Heat Inter-Changer)			-			
Pipe between unit and distributor	High pressure	mm (in.)	19.05 (3/4) Brazed		19.05 (3/4) Brazed	
	Low pressure	mm (in.)	22.2 (7/8) Brazed		-	
Defrosting method			Auto-defrost mode (Reversed refrigerant cycle, Hot gas)			
Drawing	External		WKJ94T180			
	Wiring		WKE94G041		WKE94G041	
Standard attachment	Document		Installation Manual			
	Accessory		Refrigerant conn. pipe			
Optional parts			Outdoor Twinning kit: CMY-R100VBK2 Joint: CMY-Y102SS-G2, CMY-Y102LS-G2, CMY-R160-J1 Main BC controller: CMB-P108, 1010, 1013, 1016V-GA1 Sub BC controller: CMB-P104, 108V-GB1, CMB-P1016V-HB1			
Remarks			Details on foundation work, duct work, insulation work, electrical wiring, power source switch, and other items shall be referred to the Installation Manual. Due to continuing improvement, above specifications may be subject to change without notice.			

Notes:

- Nominal cooling conditions (subject to JIS B8615-2)
Indoor: 27°C D.B./19°C W.B. (81°F D.B./66°F W.B.), Outdoor: 35°C D.B./24°C W.B. (95°F D.B./75°F W.B.)
Pipe length: 7.5 m (24-9/16 ft.), Level difference: 0 m (0 ft.)
- Nominal heating conditions (subject to JIS B8615-2)
Indoor: 20°C D.B. (68°F D.B.), Outdoor: 7°C D.B./6°C W.B. (45°F D.B./43°F W.B.)
Pipe length: 7.5 m (24-9/16 ft.), Level difference: 0 m (0 ft.)
- 5°C D.B. (23°F D.B.)/-6°C W.B. (21°F W.B.) to 21°C D.B. (70°F D.B.)/15.5°C W.B. (60°F W.B.) with cooling/heating mixed operation.
- External static pressure option is available (30 Pa, 60 Pa/3.1 mmH₂O, 6.1 mmH₂O).

Unit converter

BTU/h	=kW x 3,412
cfm	=m ³ /min x 35.31
lbs	=kg/0.4536

*Above specification data is subject to rounding variation.

1. SPECIFICATIONS

YKB/YLM

Model			PURY-P600YSLM-A1 (-BS)		
Power source			3-phase 4-wire 380-400-415 V 50/60 Hz		
Cooling capacity (Nominal)	*1	kW	69.0		
		kcal/h	59,300		
		BTU/h	235,400		
	Power input	kW	19.32		
		A	32.6-30.9-29.8		
EER	kW/kW	3.57			
Temp. range of cooling	*3 Indoor	W.B.	15.0~24.0°C (59~75°F)		
	Outdoor	D.B.	-5.0~46.0°C (23~115°F)		
Heating capacity (Nominal)	*2	kW	76.5		
		kcal/h	65,800		
		BTU/h	261,000		
	Power input	kW	19.12		
		A	32.2-30.6-29.5		
COP	kW/kW	4.00			
Temp. range of heating	*3 Indoor	D.B.	15.0~27.0°C (59~81°F)		
	Outdoor	W.B.	-20.0~15.5°C (-4~60°F)		
Indoor unit connectable	Total capacity		50~150% of outdoor unit capacity		
	Model/Quantity		P15~P250/2~50		
Sound pressure level (measured in anechoic room)		dB <A>	65.5		
Sound power level (measured in anechoic room)		dB <A>	89		
Refrigerant piping diameter	High pressure	mm (in.)	28.58 (1-1/8) Brazed		
	Low pressure	mm (in.)	28.58 (1-1/8) Brazed		

Set Model					
Model		PURY-P300YLM-A1 (-BS)		PURY-P300YLM-A1 (-BS)	
FAN	Type x Quantity		Propeller fan x 1		Propeller fan x 1
	Air flow rate	m ³ /min	230		230
		L/s	3,833		3,833
		cfm	8,121		8,121
	Control, Driving mechanism		Inverter-control, Direct-driven by motor		Inverter-control, Direct-driven by motor
	Motor output	kW	0.92 x 1		0.92 x 1
*4 External static press.			0 Pa (0 mmH ₂ O)		0 Pa (0 mmH ₂ O)
Compressor	Type x Quantity		Inverter scroll hermetic compressor		Inverter scroll hermetic compressor
	Manufacture		AC&R Works, MITSUBISHI ELECTRIC CORPORATION		AC&R Works, MITSUBISHI ELECTRIC CORPORATION
	Starting method		Inverter		Inverter
	Motor output	kW	8.1		8.1
	Case heater	kW	- (- V)		- (- V)
	Lubricant		MEL32		MEL32
External finish		Pre-coated galvanized steel sheets (+powder coating for -BS type) <MUNSELL 5Y 8/1 or similar>		Pre-coated galvanized steel sheets (+powder coating for -BS type) <MUNSELL 5Y 8/1 or similar>	
External dimension H x W x D		mm	1,710 (1,650 without legs) x 1,220 x 740		1,710 (1,650 without legs) x 1,220 x 740
		in.	67-3/8 (65 without legs) x 48-1/16 x 29-3/16		67-3/8 (65 without legs) x 48-1/16 x 29-3/16
Protection devices	High pressure protection		High pressure sensor, High pressure switch at 4.15 MPa (601 psi)		High pressure sensor, High pressure switch at 4.15 MPa (601 psi)
	Inverter circuit (COMP./FAN)		Over-heat protection, Over-current protection		Over-heat protection, Over-current protection
	Compressor		Over-heat protection		Over-heat protection
	Fan motor		Over-current protection		Over-current protection
Refrigerant	Type x original charge		R410A x 10.3 kg (23 lbs)		R410A x 10.3 kg (23 lbs)
	Control		Indoor LEV and BC controller		
Net weight		kg (lbs)	248 (547)		248 (547)
Heat exchanger		Salt-resistant cross fin & copper tube			
HIC circuit (HIC: Heat Inter-Changer)		-			
Pipe between unit and distributor	High pressure	mm (in.)	19.05 (3/4) Brazed		19.05 (3/4) Brazed
	Low pressure	mm (in.)	22.2 (7/8) Brazed		-
Defrosting method		Auto-defrost mode (Reversed refrigerant cycle, Hot gas)			
Drawing	External		WKJ94T181		
	Wiring		WKE94G041		WKE94G041
Standard attachment	Document		Installation Manual		
	Accessory		Refrigerant conn. pipe		
Optional parts		Outdoor Twinning kit: CMY-R100VBK2 Joint: CMY-Y102SS-G2, CMY-Y102LS-G2, CMY-R160-J1 Main BC controller: CMB-P108, 1010, 1013, 1016V-GA1 Sub BC controller: CMB-P104, 108V-GB1, CMB-P1016V-HB1			
Remarks		Details on foundation work, duct work, insulation work, electrical wiring, power source switch, and other items shall be referred to the Installation Manual. Due to continuing improvement, above specifications may be subject to change without notice.			

Notes:		Unit converter	
1. Nominal cooling conditions (subject to JIS B8615-2) Indoor: 27°C D.B./19°C W.B. (81°F D.B./66°F W.B.), Outdoor: 35°C D.B./24°C W.B. (95°F D.B./75°F W.B.) Pipe length: 7.5 m (24-9/16 ft.), Level difference: 0 m (0 ft.)		BTU/h	=kW x 3,412
2. Nominal heating conditions (subject to JIS B8615-2) Indoor: 20°C D.B. (68°F D.B.), Outdoor: 7°C D.B./6°C W.B. (45°F D.B./43°F W.B.) Pipe length: 7.5 m (24-9/16 ft.), Level difference: 0 m (0 ft.)		cfm	=m ³ /min x 35.31
3. -5°C D.B. (23°F D.B.)/-6°C W.B. (21°F W.B.) to 21°C D.B. (70°F D.B.)/15.5°C W.B. (60°F W.B.) with cooling/heating mixed operation.		lbs	=kg/0.4536
4. External static pressure option is available (30 Pa, 60 Pa/3.1 mmH ₂ O, 6.1 mmH ₂ O).		*Above specification data is subject to rounding variation.	

1. SPECIFICATIONS

Model			PURY-P650YSLM-A1 (-BS)	
Power source			3-phase 4-wire 380-400-415 V 50/60 Hz	
Cooling capacity (Nominal)	*1	kW	73.0	
		kcal/h	62,800	
		BTU/h	249,100	
	Power input	kW	21.28	
		Current input	A	35.9-34.1-32.8
EER		kW/kW	3.43	
Temp. range of cooling	*3	Indoor	W.B.	15.0~24.0°C (59~75°F)
		Outdoor	D.B.	-5.0~46.0°C (23~115°F)
Heating capacity (Nominal)	*2	kW	81.5	
		kcal/h	70,100	
		BTU/h	278,100	
	Power input	kW	20.68	
		Current input	A	34.9-33.1-31.9
COP		kW/kW	3.94	
Temp. range of heating	*3	Indoor	D.B.	15.0~27.0°C (59~81°F)
		Outdoor	W.B.	-20.0~15.5°C (-4~60°F)
Indoor unit connectable	Total capacity		50~150% of outdoor unit capacity	
	Model/Quantity		P15-P250/2-50	
Sound pressure level (measured in anechoic room)		dB <A>	65.5	
Sound power level (measured in anechoic room)		dB <A>	89	
Refrigerant piping diameter	High pressure	mm (in.)	28.58 (1-1/8) Brazed	
	Low pressure	mm (in.)	28.58 (1-1/8) Brazed	

Set Model				
Model		PURY-P300YLM-A1 (-BS)		PURY-P350YLM-A1 (-BS)
FAN	Type x Quantity		Propeller fan x 1	
	Air flow rate	m ³ /min	230	
		L/s	3,833	
		cfm	8,121	
	Control, Driving mechanism		Inverter-control, Direct-driven by motor	
*4	Motor output	kW	0.92 x 1	
External static press.		0 Pa (0 mmH ₂ O)		0 Pa (0 mmH ₂ O)
Compressor	Type x Quantity		Inverter scroll hermetic compressor	
	Manufacture		AC&R Works, MITSUBISHI ELECTRIC CORPORATION	
	Starting method		Inverter	
	Motor output	kW	8.1	
	Case heater	kW	- (- V)	
Lubricant		MEL32		MEL32
External finish		Pre-coated galvanized steel sheets (+powder coating for -BS type) <MUNSELL 5Y 8/1 or similar>		Pre-coated galvanized steel sheets (+powder coating for -BS type) <MUNSELL 5Y 8/1 or similar>
External dimension H x W x D		mm	1,710 (1,650 without legs) x 1,220 x 740	
		in.	67-3/8 (65 without legs) x 48-1/16 x 29-3/16	
Protection devices	High pressure protection		High pressure sensor, High pressure switch at 4.15 MPa (601 psi)	
	Inverter circuit (COMP./FAN)		Over-heat protection, Over-current protection	
	Compressor		Over-heat protection	
	Fan motor		Over-current protection	
Refrigerant	Type x original charge		R410A x 10.3 kg (23 lbs)	
	Control		Indoor LEV and BC controller	
Net weight		kg (lbs)	248 (547)	
Heat exchanger		Salt-resistant cross fin & copper tube		Salt-resistant cross fin & copper tube
HIC circuit (HIC: Heat Inter-Changer)		-		-
Pipe between unit and distributor	High pressure	mm (in.)	19.05 (3/4) Brazed	
	Low pressure	mm (in.)	22.2 (7/8) Brazed	
Defrosting method		Auto-defrost mode (Reversed refrigerant cycle, Hot gas)		
Drawing	External		WKJ94T181	
	Wiring		WKE94G041	WKE94G041
Standard attachment	Document		Installation Manual	
	Accessory		Refrigerant conn. pipe	
Optional parts		Outdoor Twinning kit: CMY-R100VBK2 Joint: CMY-Y102SS-G2, CMY-Y102LS-G2, CMY-R160-J1 Main BC controller: CMB-P108, 1010, 1013, 1016V-GA1 Sub BC controller: CMB-P104, 108V-GB1, CMB-P1016V-HB1		
Remarks		Details on foundation work, duct work, insulation work, electrical wiring, power source switch, and other items shall be referred to the Installation Manual. Due to continuing improvement, above specifications may be subject to change without notice.		

Notes:		Unit converter
1. Nominal cooling conditions (subject to JIS B8615-2) Indoor: 27°C.D.B./19°C.W.B. (81°F.D.B./66°F.W.B.), Outdoor: 35°C.D.B./24°C.W.B. (95°F.D.B./75°F.W.B.) Pipe length: 7.5 m (24-9/16 ft.), Level difference: 0 m (0 ft.)		BTU/h =kW x 3,412
2. Nominal heating conditions (subject to JIS B8615-2) Indoor: 20°C.D.B. (68°F.D.B.), Outdoor: 7°C.D.B./6°C.W.B. (45°F.D.B./43°F.W.B.) Pipe length: 7.5 m (24-9/16 ft.), Level difference: 0 m (0 ft.)		cfm =m ³ /min x 35.31
3. -5°C.D.B. (23°F.D.B.)/-6°C.W.B. (21°F.W.B.) to 21°C.D.B. (70°F.D.B.)/15.5°C.W.B. (60°F.W.B.) with cooling/heating mixed operation.		lbs =kg/0.4536
4. External static pressure option is available (30 Pa, 60 Pa/3.1 mmH ₂ O, 6.1 mmH ₂ O).		*Above specification data is subject to rounding variation.

1. SPECIFICATIONS

YKB/YLM

Model			PURY-P700YSLM-A1 (-BS)	
Power source			3-phase 4-wire 380-400-415 V 50/60 Hz	
Cooling capacity (Nominal)	*1	kW	80.0	
		kcal/h	68,800	
		BTU/h	273,000	
	Power input	kW	24.24	
		Current input	A	40.9-38.8-37.4
EER		kW/kW	3.30	
Temp. range of cooling	*3 Indoor	W.B.	15.0~24.0°C (59~75°F)	
	Outdoor	D.B.	-5.0~46.0°C (23~115°F)	
Heating capacity (Nominal)	*2	kW	88.0	
		kcal/h	75,700	
		BTU/h	300,300	
	Power input	kW	22.68	
		Current input	A	38.2-36.3-35.0
COP		kW/kW	3.88	
Temp. range of heating	*3 Indoor	D.B.	15.0~27.0°C (59~81°F)	
	Outdoor	W.B.	-20.0~15.5°C (-4~60°F)	
Indoor unit connectable	Total capacity		50~150% of outdoor unit capacity	
	Model/Quantity		P15~P250/2~50	
Sound pressure level (measured in anechoic room)			dB <A>	
Sound power level (measured in anechoic room)			dB <A>	
Refrigerant piping diameter	High pressure		28.58 (1-1/8) Brazed	
	Low pressure		34.93 (1-3/8) Brazed	

Set Model			PURY-P350YLM-A1 (-BS)		PURY-P350YLM-A1 (-BS)	
FAN	Type x Quantity		Propeller fan x 1		Propeller fan x 1	
	Air flow rate	m ³ /min	230		230	
		L/s	3,833		3,833	
		cfm	8,121		8,121	
	Control, Driving mechanism		Inverter-control, Direct-driven by motor		Inverter-control, Direct-driven by motor	
*4	Motor output	kW	0.92 x 1		0.92 x 1	
	External static press.		0 Pa (0 mmH ₂ O)		0 Pa (0 mmH ₂ O)	
Compressor	Type x Quantity		Inverter scroll hermetic compressor		Inverter scroll hermetic compressor	
	Manufacture		AC&R Works, MITSUBISHI ELECTRIC CORPORATION		AC&R Works, MITSUBISHI ELECTRIC CORPORATION	
	Starting method		Inverter		Inverter	
	Motor output	kW	10.5		10.5	
	Case heater	kW	- (- V)		- (- V)	
	Lubricant		MEL32		MEL32	
External finish			Pre-coated galvanized steel sheets (+powder coating for -BS type) <MUNSELL 5Y 8/1 or similar>		Pre-coated galvanized steel sheets (+powder coating for -BS type) <MUNSELL 5Y 8/1 or similar>	
External dimension H x W x D			mm 1,710 (1,650 without legs) x 1,220 x 740 in. 67-3/8 (65 without legs) x 48-1/16 x 29-3/16		mm 1,710 (1,650 without legs) x 1,220 x 740 in. 67-3/8 (65 without legs) x 48-1/16 x 29-3/16	
Protection devices	High pressure protection		High pressure sensor, High pressure switch at 4.15 MPa (601 psi)		High pressure sensor, High pressure switch at 4.15 MPa (601 psi)	
	Inverter circuit (COMP./FAN)		Over-heat protection, Over-current protection		Over-heat protection, Over-current protection	
	Compressor		Over-heat protection		Over-heat protection	
	Fan motor		Over-current protection		Over-current protection	
Refrigerant	Type x original charge		R410A x 10.3 kg (23 lbs)		R410A x 10.3 kg (23 lbs)	
	Control		Indoor LEV and BC controller			
Net weight			kg (lbs)		248 (547)	
Heat exchanger			Salt-resistant cross fin & copper tube		Salt-resistant cross fin & copper tube	
HIC circuit (HIC: Heat Inter-Changer)			-			
Pipe between unit and distributor	High pressure	mm (in.)	19.05 (3/4) Brazed		19.05 (3/4) Brazed	
	Low pressure	mm (in.)	28.58 (1-1/8) Brazed		-	
Defrosting method			Auto-defrost mode (Reversed refrigerant cycle, Hot gas)			
Drawing	External		WKJ94T181			
	Wiring		WKE94G041		WKE94G041	
Standard attachment	Document		Installation Manual			
	Accessory		Refrigerant conn. pipe			
Optional parts			Outdoor Twinning kit: CMY-R200VBK2 Joint: CMY-Y102SS-G2, CMY-Y102LS-G2, CMY-R160-J1 Main BC controller: CMB-P1016V-HA1 Sub BC controller: CMB-P104, 108V-GB1, CMB-P1016V-HB1			
Remarks			Details on foundation work, duct work, insulation work, electrical wiring, power source switch, and other items shall be referred to the Installation Manual. Due to continuing improvement, above specifications may be subject to change without notice.			

Notes:	Unit converter
1. Nominal cooling conditions (subject to JIS B8615-2) Indoor: 27°C D.B./19°C W.B. (81°F D.B./66°F W.B.), Outdoor: 35°C D.B./24°C W.B. (95°F D.B./75°F W.B.) Pipe length: 7.5 m (24-9/16 ft.), Level difference: 0 m (0 ft.)	BTU/h = kW x 3,412
2. Nominal heating conditions (subject to JIS B8615-2) Indoor: 20°C D.B. (68°F D.B.), Outdoor: 7°C D.B./6°C W.B. (45°F D.B./43°F W.B.) Pipe length: 7.5 m (24-9/16 ft.), Level difference: 0 m (0 ft.)	cfm = m ³ /min x 35.31
3. -5°C D.B. (23°F D.B.)/-6°C W.B. (21°F W.B.) to 21°C D.B. (70°F D.B.)/15.5°C W.B. (60°F W.B.) with cooling/heating mixed operation.	lbs = kg/0.4536
4. External static pressure option is available (30 Pa, 60 Pa/3.1 mmH ₂ O, 6.1 mmH ₂ O).	*Above specification data is subject to rounding variation.

1. SPECIFICATIONS

Model			PURY-P750YSLM-A1 (-BS)	
Power source			3-phase 4-wire 380-400-415 V 50/60 Hz	
Cooling capacity (Nominal)	*1	kW	85.0	
		kcal/h	73,100	
		BTU/h	290,000	
	Power input	kW	26.23	
		Current input	A	44.2-42.0-40.5
EER		kW/kW	3.24	
Temp. range of cooling	*3 Indoor	W.B.	15.0-24.0°C (59-75°F)	
	Outdoor	D.B.	-5.0-46.0°C (23-115°F)	
Heating capacity (Nominal)	*2	kW	90.0	
		kcal/h	77,400	
		BTU/h	307,100	
	Power input	kW	23.01	
		Current input	A	38.8-36.9-35.5
COP		kW/kW	3.91	
Temp. range of heating	*3 Indoor	D.B.	15.0-27.0°C (59-81°F)	
	Outdoor	W.B.	-20.0-15.5°C (-4-60°F)	
Indoor unit connectable	Total capacity		50-150% of outdoor unit capacity	
	Model/Quantity		P15-P250/2-50	
Sound pressure level (measured in anechoic room)		dB <A>	65.5	
Sound power level (measured in anechoic room)		dB <A>	89	
Refrigerant piping diameter	High pressure	mm (in.)	28.58 (1-1/8) Brazed	
	Low pressure	mm (in.)	34.93 (1-3/8) Brazed	

Set Model			PURY-P350YLM-A1 (-BS)		PURY-P400YLM-A1 (-BS)	
Model			Propeller fan x 1		Propeller fan x 1	
FAN	Type x Quantity		230		230	
	Air flow rate	m ³ /min	3,833		3,833	
		L/s	8,121		8,121	
		cfm				
	Control, Driving mechanism		Inverter-control, Direct-driven by motor		Inverter-control, Direct-driven by motor	
*4 Motor output	kW	0.92 x 1		0.92 x 1		
	External static press.	0 Pa (0 mmH ₂ O)		0 Pa (0 mmH ₂ O)		
Compressor			Inverter scroll hermetic compressor		Inverter scroll hermetic compressor	
Manufacture			AC&R Works, MITSUBISHI ELECTRIC CORPORATION		AC&R Works, MITSUBISHI ELECTRIC CORPORATION	
Starting method			Inverter		Inverter	
Motor output	kW	10.5		10.9		
	Case heater	kW	- (- V)		- (- V)	
Lubricant			MEL32		MEL32	
External finish			Pre-coated galvanized steel sheets (+powder coating for -BS type) <MUNSELL 5Y 8/1 or similar>		Pre-coated galvanized steel sheets (+powder coating for -BS type) <MUNSELL 5Y 8/1 or similar>	
External dimension H x W x D			1,710 (1,650 without legs) x 1,220 x 740 67-3/8 (65 without legs) x 48-1/16 x 29-3/16		1,710 (1,650 without legs) x 1,220 x 740 67-3/8 (65 without legs) x 48-1/16 x 29-3/16	
Protection devices	High pressure protection		High pressure sensor, High pressure switch at 4.15 MPa (601 psi)		High pressure sensor, High pressure switch at 4.15 MPa (601 psi)	
	Inverter circuit (COMP./FAN)		Over-heat protection, Over-current protection		Over-heat protection, Over-current protection	
	Compressor		Over-heat protection		Over-heat protection	
	Fan motor		Over-current protection		Over-current protection	
Refrigerant	Type x original charge		R410A x 10.3 kg (23 lbs)		R410A x 10.3 kg (23 lbs)	
	Control		Indoor LEV and BC controller			
Net weight			248 (547)		246 (543)	
Heat exchanger			Salt-resistant cross fin & copper tube		Salt-resistant cross fin & copper tube	
HIC circuit (HIC: Heat Inter-Changer)			-			
Pipe between unit and distributor	High pressure	mm (in.)	19.05 (3/4) Brazed		22.2 (7/8) Brazed	
	Low pressure	mm (in.)	28.58 (1-1/8) Brazed		-	
Defrosting method			Auto-defrost mode (Reversed refrigerant cycle, Hot gas)			
Drawing	External		WKJ94T181			
	Wiring		WKE94G041		WKE94G041	
Standard attachment	Document		Installation Manual			
	Accessory		Refrigerant conn. pipe			
Optional parts			Outdoor Twinning kit: CMY-R200VBK2 Joint: CMY-Y102SS-G2, CMY-Y102LS-G2, CMY-R160-J1 Main BC controller: CMB-P1016V-HA1 Sub BC controller: CMB-P104, 108V-GB1, CMB-P1016V-HB1			
Remarks			Details on foundation work, duct work, insulation work, electrical wiring, power source switch, and other items shall be referred to the Installation Manual. Due to continuing improvement, above specifications may be subject to change without notice.			

Notes:	Unit converter
1. Nominal cooling conditions (subject to JIS B8615-2) Indoor: 27°C D.B./19°C W.B. (81°F D.B./66°F W.B.), Outdoor: 35°C D.B./24°C W.B. (95°F D.B./75°F W.B.) Pipe length: 7.5 m (24-9/16 ft.), Level difference: 0 m (0 ft.)	BTU/h = kW x 3,412
2. Nominal heating conditions (subject to JIS B8615-2) Indoor: 20°C D.B. (68°F D.B.), Outdoor: 7°C D.B./6°C W.B. (45°F D.B./43°F W.B.) Pipe length: 7.5 m (24-9/16 ft.), Level difference: 0 m (0 ft.)	cfm = m ³ /min x 35.31
3. -5°C D.B. (23°F D.B.)/-6°C W.B. (21°F W.B.) to 21°C D.B. (70°F D.B.)/15.5°C W.B. (60°F W.B.) with cooling/heating mixed operation.	lbs = kg/0.4536
4. External static pressure option is available (30 Pa, 60 Pa/3.1 mmH ₂ O, 6.1 mmH ₂ O).	*Above specification data is subject to rounding variation.

1. SPECIFICATIONS

YKB/YLM

Model			PURY-P800YSLM-A1 (-BS)		
Power source			3-phase 4-wire 380-400-415 V 50/60 Hz		
Cooling capacity (Nominal)	*1	kW	90.0		
		kcal/h	77,400		
		BTU/h	307,100		
	Power input	kW	28.30		
		A	47.7-45.3-43.7		
EER	kW/kW	3.18			
Temp. range of cooling	*3 Indoor	W.B.	15.0~24.0°C (59~75°F)		
	Outdoor	D.B.	-5.0~46.0°C (23~115°F)		
Heating capacity (Nominal)	*2	kW	90.0		
		kcal/h	77,400		
		BTU/h	307,100		
	Power input	kW	22.84		
		A	38.5-36.6-35.3		
COP	kW/kW	3.94			
Temp. range of heating	*3 Indoor	D.B.	15.0~27.0°C (59~81°F)		
	Outdoor	W.B.	-20.0~15.5°C (-4~60°F)		
Indoor unit connectable	Total capacity		50~150% of outdoor unit capacity		
	Model/Quantity		P15~P250/2~50		
Sound pressure level (measured in anechoic room)		dB <A>	65.5		
Sound power level (measured in anechoic room)		dB <A>	89		
Refrigerant piping diameter	High pressure	mm (in.)	28.58 (1-1/8) Brazed		
	Low pressure	mm (in.)	34.93 (1-3/8) Brazed		

Set Model					
Model		PURY-P400YLM-A1 (-BS)		PURY-P400YLM-A1 (-BS)	
FAN	Type x Quantity		Propeller fan x 1		Propeller fan x 1
	Air flow rate	m ³ /min	230		230
		L/s	3,833		3,833
		cfm	8,121		8,121
	Control, Driving mechanism		Inverter-control, Direct-driven by motor		Inverter-control, Direct-driven by motor
*4 Motor output	kW	0.92 x 1		0.92 x 1	
External static press.		0 Pa (0 mmH ₂ O)		0 Pa (0 mmH ₂ O)	
Compressor	Type x Quantity		Inverter scroll hermetic compressor		Inverter scroll hermetic compressor
	Manufacture		AC&R Works, MITSUBISHI ELECTRIC CORPORATION		AC&R Works, MITSUBISHI ELECTRIC CORPORATION
	Starting method		Inverter		Inverter
	Motor output	kW	10.9		10.9
	Case heater	kW	- (- V)		- (- V)
Lubricant		MEL32		MEL32	
External finish		Pre-coated galvanized steel sheets (+powder coating for -BS type) <MUNSELL 5Y 8/1 or similar>		Pre-coated galvanized steel sheets (+powder coating for -BS type) <MUNSELL 5Y 8/1 or similar>	
External dimension H x W x D		mm	1,710 (1,650 without legs) x 1,220 x 740		1,710 (1,650 without legs) x 1,220 x 740
		in.	67-3/8 (65 without legs) x 48-1/16 x 29-3/16		67-3/8 (65 without legs) x 48-1/16 x 29-3/16
Protection devices	High pressure protection		High pressure sensor, High pressure switch at 4.15 MPa (601 psi)		High pressure sensor, High pressure switch at 4.15 MPa (601 psi)
	Inverter circuit (COMP./FAN)		Over-heat protection, Over-current protection		Over-heat protection, Over-current protection
	Compressor		Over-heat protection		Over-heat protection
	Fan motor		Over-current protection		Over-current protection
Refrigerant	Type x original charge		R410A x 10.3 kg (23 lbs)		R410A x 10.3 kg (23 lbs)
	Control		Indoor LEV and BC controller		
Net weight		kg (lbs)	246 (543)		246 (543)
Heat exchanger		Salt-resistant cross fin & copper tube			
HIC circuit (HIC: Heat Inter-Changer)		-			
Pipe between unit and distributor	High pressure	mm (in.)	22.2 (7/8) Brazed		22.2 (7/8) Brazed
	Low pressure	mm (in.)	28.58 (1-1/8) Brazed		-
Defrosting method		Auto-defrost mode (Reversed refrigerant cycle, Hot gas)			
Drawing	External		WKJ94T181		
	Wiring		WKE94G041		WKE94G041
Standard attachment	Document		Installation Manual		
	Accessory		Refrigerant conn. pipe		
Optional parts		Outdoor Twinning kit: CMY-R200VBK2 Joint: CMY-Y102SS-G2, CMY-Y102LS-G2, CMY-R160-J1 Main BC controller: CMB-P1016V-HA1 Sub BC controller: CMB-P104, 108V-GB1, CMB-P1016V-HB1			
Remarks		Details on foundation work, duct work, insulation work, electrical wiring, power source switch, and other items shall be referred to the Installation Manual. Due to continuing improvement, above specifications may be subject to change without notice.			

Notes:		Unit converter	
1. Nominal cooling conditions (subject to JIS B8615-2) Indoor: 27°C D.B./19°C W.B. (81°F D.B./66°F W.B.), Outdoor: 35°C D.B./24°C W.B. (95°F D.B./75°F W.B.) Pipe length: 7.5 m (24-9/16 ft.), Level difference: 0 m (0 ft.)		BTU/h	=kW x 3,412
2. Nominal heating conditions (subject to JIS B8615-2) Indoor: 20°C D.B. (68°F D.B.), Outdoor: 7°C D.B./6°C W.B. (45°F D.B./43°F W.B.) Pipe length: 7.5 m (24-9/16 ft.), Level difference: 0 m (0 ft.)		cfm	=m ³ /min x 35.31
3. -5°C D.B. (23°F D.B.)/-6°C W.B. (21°F W.B.) to 21°C D.B. (70°F D.B.)/15.5°C W.B. (60°F W.B.) with cooling/heating mixed operation.		lbs	=kg/0.4536
4. External static pressure option is available (30 Pa, 60 Pa/3.1 mmH ₂ O, 6.1 mmH ₂ O).		*Above specification data is subject to rounding variation.	

1. SPECIFICATIONS

YKB/YLM

Model			PURY-P850YSLM-A1 (-BS)	
Power source			3-phase 4-wire 380-400-415 V 50/60 Hz	
Cooling capacity (Nominal)	*1	kW	96.0	
		kcal/h	82,600	
		BTU/h	327,600	
	Power input	kW	29.26	
		Current input	A	49.3-46.9-45.2
EER		kW/kW	3.28	
Temp. range of cooling	*3	Indoor	W.B.	15.0~24.0°C (59~75°F)
		Outdoor	D.B.	-5.0~46.0°C (23~115°F)
Heating capacity (Nominal)	*2	kW	101.0	
		kcal/h	86,900	
		BTU/h	344,600	
	Power input	kW	26.23	
		Current input	A	44.2-42.0-40.5
COP		kW/kW	3.85	
Temp. range of heating	*3	Indoor	D.B.	15.0~27.0°C (59~81°F)
		Outdoor	W.B.	-20.0~15.5°C (-4~60°F)
Indoor unit connectable	Total capacity		50~150% of outdoor unit capacity	
	Model/Quantity		P15-P250/2-50	
Sound pressure level (measured in anechoic room)		dB <A>	65.5	
Sound power level (measured in anechoic room)		dB <A>	89	
Refrigerant piping diameter	High pressure	mm (in.)	28.58 (1-1/8) Brazed	
	Low pressure	mm (in.)	41.28 (1-5/8) Brazed	

Set Model

Model			PURY-P400YLM-A1 (-BS)		PURY-P450YLM-A1 (-BS)	
FAN	Type x Quantity		Propeller fan x 1		Propeller fan x 2	
	Air flow rate	m ³ /min	230		320	
		L/s	3,833		5,333	
		cfm	8,121		11,299	
	Control, Driving mechanism		Inverter-control, Direct-driven by motor		Inverter-control, Direct-driven by motor	
	Motor output	kW	0.92 x 1		0.92 x 2	
*4 External static press.		0 Pa (0 mmH ₂ O)		0 Pa (0 mmH ₂ O)		
Compressor	Type x Quantity		Inverter scroll hermetic compressor		Inverter scroll hermetic compressor	
	Manufacture		AC&R Works, MITSUBISHI ELECTRIC CORPORATION		AC&R Works, MITSUBISHI ELECTRIC CORPORATION	
	Starting method		Inverter		Inverter	
	Motor output	kW	10.9		12.4	
	Case heater	kW	- (- V)		- (- V)	
Lubricant		MEL32		MEL32		
External finish			Pre-coated galvanized steel sheets (+powder coating for -BS type) <MUNSELL 5Y 8/1 or similar>		Pre-coated galvanized steel sheets (+powder coating for -BS type) <MUNSELL 5Y 8/1 or similar>	
External dimension H x W x D			mm 1,710 (1,650 without legs) x 1,220 x 740		mm 1,710 (1,650 without legs) x 1,750 x 740	
			in. 67-3/8 (65 without legs) x 48-1/16 x 29-3/16		in. 67-3/8 (65 without legs) x 68-15/16 x 29-3/16	
Protection devices	High pressure protection		High pressure sensor, High pressure switch at 4.15 MPa (601 psi)		High pressure sensor, High pressure switch at 4.15 MPa (601 psi)	
	Inverter circuit (COMP./FAN)		Over-heat protection, Over-current protection		Over-heat protection, Over-current protection	
	Compressor		Over-heat protection		Over-heat protection	
	Fan motor		Over-current protection		Over-current protection	
Refrigerant	Type x original charge		R410A x 10.3 kg (23 lbs)		R410A x 11.8 kg (27 lbs)	
	Control		Indoor LEV and BC controller			
Net weight		kg (lbs)	246 (543)		321 (708)	
Heat exchanger			Salt-resistant cross fin & copper tube		Salt-resistant cross fin & copper tube	
HIC circuit (HIC: Heat Inter-Changer)			-		-	
Pipe between unit and distributor	High pressure	mm (in.)	22.2 (7/8) Brazed		22.2 (7/8) Brazed	
	Low pressure	mm (in.)	28.58 (1-1/8) Brazed		-	
Defrosting method			Auto-defrost mode (Reversed refrigerant cycle, Hot gas)			
Drawing	External		WKJ94T182			
	Wiring		WKE94G041		WKE94G042	
Standard attachment	Document		Installation Manual			
	Accessory		Refrigerant conn. pipe			
Optional parts			Outdoor Twinning kit: CMY-R200XLVBK Joint: CMY-Y102SS-G2, CMY-Y102LS-G2, CMY-R160-J1 Main BC controller: CMB-P1016V-HA1 Sub BC controller: CMB-P104, 108V-GB1, CMB-P1016V-HB1			
Remarks			Details on foundation work, duct work, insulation work, electrical wiring, power source switch, and other items shall be referred to the Installation Manual. Due to continuing improvement, above specifications may be subject to change without notice.			

Notes:

- Nominal cooling conditions (subject to JIS B8615-2)
Indoor: 27°C D.B./19°C W.B. (81°F D.B./66°F W.B.), Outdoor: 35°C D.B./24°C W.B. (95°F D.B./75°F W.B.)
Pipe length: 7.5 m (24-9/16 ft.), Level difference: 0 m (0 ft.)
- Nominal heating conditions (subject to JIS B8615-2)
Indoor: 20°C D.B. (68°F D.B.), Outdoor: 7°C D.B./6°C W.B. (45°F D.B./43°F W.B.)
Pipe length: 7.5 m (24-9/16 ft.), Level difference: 0 m (0 ft.)
- 5°C D.B. (23°F D.B.)/-6°C W.B. (21°F W.B.) to 21°C D.B. (70°F D.B.)/15.5°C W.B. (60°F W.B.)
with cooling/heating mixed operation.
- External static pressure option is available (30 Pa, 60 Pa/3.1 mmH₂O, 6.1 mmH₂O).

Unit converter

BTU/h	=kW x 3,412
cfm	=m ³ /min x 35.31
lbs	=kg/0.4536

*Above specification data is subject to rounding variation.

1. SPECIFICATIONS

YKB/YLM

Model			PURY-P900YSLM-A1 (-BS)		
Power source			3-phase 4-wire 380-400-415 V 50/60 Hz		
Cooling capacity (Nominal)	*1	kW	101.0		
		kcal/h	86,900		
		BTU/h	344,600		
	Power input	kW	29.79		
		A	50.2-47.7-46.0		
EER	kW/kW	3.39			
Temp. range of cooling	*3 Indoor	W.B.	15.0~24.0°C (59~75°F)		
	Outdoor	D.B.	-5.0~46.0°C (23~115°F)		
Heating capacity (Nominal)	*2	kW	113.0		
		kcal/h	97,200		
		BTU/h	385,600		
	Power input	kW	30.13		
		A	50.8-48.3-46.5		
COP	kW/kW	3.75			
Temp. range of heating	*3 Indoor	D.B.	15.0~27.0°C (59~81°F)		
	Outdoor	W.B.	-20.0~15.5°C (-4~60°F)		
Indoor unit connectable	Total capacity		50~150% of outdoor unit capacity		
	Model/Quantity		P15~P250/2~50		
Sound pressure level (measured in anechoic room)		dB <A>	65.5		
Sound power level (measured in anechoic room)		dB <A>	89		
Refrigerant piping diameter	High pressure	mm (in.)	28.58 (1-1/8) Brazed		
	Low pressure	mm (in.)	41.28 (1-5/8) Brazed		

Set Model					
Model		PURY-P450YLM-A1 (-BS)		PURY-P450YLM-A1 (-BS)	
FAN	Type x Quantity		Propeller fan x 2		Propeller fan x 2
	Air flow rate	m ³ /min	320		320
		L/s	5,333		5,333
		cfm	11,299		11,299
	Control, Driving mechanism		Inverter-control, Direct-driven by motor		Inverter-control, Direct-driven by motor
*4 Motor output	kW	0.92 x 2		0.92 x 2	
External static press.		0 Pa (0 mmH ₂ O)		0 Pa (0 mmH ₂ O)	
Compressor	Type x Quantity		Inverter scroll hermetic compressor		Inverter scroll hermetic compressor
	Manufacture		AC&R Works, MITSUBISHI ELECTRIC CORPORATION		AC&R Works, MITSUBISHI ELECTRIC CORPORATION
	Starting method		Inverter		Inverter
	Motor output	kW	12.4		12.4
	Case heater	kW	- (- V)		- (- V)
Lubricant		MEL32		MEL32	
External finish		Pre-coated galvanized steel sheets (+powder coating for -BS type) <MUNSELL 5Y 8/1 or similar>		Pre-coated galvanized steel sheets (+powder coating for -BS type) <MUNSELL 5Y 8/1 or similar>	
External dimension H x W x D		mm	1,710 (1,650 without legs) x 1,750 x 740		1,710 (1,650 without legs) x 1,750 x 740
		in.	67-3/8 (65 without legs) x 68-15/16 x 29-3/16		67-3/8 (65 without legs) x 68-15/16 x 29-3/16
Protection devices	High pressure protection		High pressure sensor, High pressure switch at 4.15 MPa (601 psi)		High pressure sensor, High pressure switch at 4.15 MPa (601 psi)
	Inverter circuit (COMP./FAN)		Over-heat protection, Over-current protection		Over-heat protection, Over-current protection
	Compressor		Over-heat protection		Over-heat protection
	Fan motor		Over-current protection		Over-current protection
Refrigerant	Type x original charge		R410A x 11.8 kg (27 lbs)		R410A x 11.8 kg (27 lbs)
	Control		Indoor LEV and BC controller		
Net weight		kg (lbs)	321 (708)		321 (708)
Heat exchanger		Salt-resistant cross fin & copper tube			
HIC circuit (HIC: Heat Inter-Changer)		-			
Pipe between unit and distributor	High pressure	mm (in.)	22.2 (7/8) Brazed		22.2 (7/8) Brazed
	Low pressure	mm (in.)	28.58 (1-1/8) Brazed		-
Defrosting method		Auto-defrost mode (Reversed refrigerant cycle, Hot gas)			
Drawing	External		WKJ94T183		
	Wiring		WKE94G042		WKE94G042
Standard attachment	Document		Installation Manual		
	Accessory		Refrigerant conn. pipe		
Optional parts		Outdoor Twinning kit: CMY-R200XLVBK Joint: CMY-Y102SS-G2, CMY-Y102LS-G2, CMY-R160-J1 Main BC controller: CMB-P1016V-HA1 Sub BC controller: CMB-P104, 108V-GB1, CMB-P1016V-HB1			
Remarks		Details on foundation work, duct work, insulation work, electrical wiring, power source switch, and other items shall be referred to the Installation Manual. Due to continuing improvement, above specifications may be subject to change without notice.			

Notes:		Unit converter	
1. Nominal cooling conditions (subject to JIS B8615-2) Indoor: 27°C D.B./19°C W.B. (81°F D.B./66°F W.B.), Outdoor: 35°C D.B./24°C W.B. (95°F D.B./75°F W.B.) Pipe length: 7.5 m (24-9/16 ft.), Level difference: 0 m (0 ft.)		BTU/h	=kW x 3,412
2. Nominal heating conditions (subject to JIS B8615-2) Indoor: 20°C D.B. (68°F D.B.), Outdoor: 7°C D.B./6°C W.B. (45°F D.B./43°F W.B.) Pipe length: 7.5 m (24-9/16 ft.), Level difference: 0 m (0 ft.)		cfm	=m ³ /min x 35.31
3. -5°C D.B. (23°F D.B.)/-6°C W.B. (21°F W.B.) to 21°C D.B. (70°F D.B.)/15.5°C W.B. (60°F W.B.) with cooling/heating mixed operation.		lbs	=kg/0.4536
4. External static pressure option is available (30 Pa, 60 Pa/3.1 mmH ₂ O, 6.1 mmH ₂ O).		*Above specification data is subject to rounding variation.	

PURY-P200, 250YLM-A1 (-BS)

Unit : mm

<Accessories>

• Connecting pipe

<Low pressure>

- Pipe (ID ϕ 25.4×OD ϕ 19.05) ... P200 1pc.
- Pipe (ID ϕ 25.4×ID ϕ 22.2) ... P250 1pc.
- Elbow (ID ϕ 19.05×OD ϕ 19.05) ... P200 1pc.

<High pressure>

- Pipe (ID ϕ 25.4×OD ϕ 15.88) ... P200 1pc.
- Pipe (ID ϕ 15.88×ID ϕ 15.88) ... P200 1pc.
- Pipe (ID ϕ 25.4×OD ϕ 19.05) ... P250 1pc.
- Elbow (ID ϕ 19.05×OD ϕ 19.05) ... P250 1pc.

Note1. Please refer to the next page for information regarding necessary spacing around the unit and foundation work.

2. The detachable leg can be removed at site.

3. At brazing of pipes wrap the refrigerant service valve with wet cloth and keep the temperature of refrigerant service valve under 120°C.

Connecting pipe specifications

Model	Refrigerant pipe		Service valve	
	High pressure	Low pressure	High pressure	Low pressure
PURY-P200/YLM-A1(-BS)	ϕ 15.88 Brazed *1	ϕ 19.05 Brazed *1	ϕ 25.4	ϕ 25.4
PURY-P250/YLM-A1(-BS)	ϕ 19.05 Brazed *1	ϕ 22.2 Brazed *1	ϕ 25.4	ϕ 25.4

*1 Use the included connecting pipe and connect to the refrigerant service valve piping.

NO	Usage	Specifications
①	Front through hole	140 × 77 Knockout hole
②	Front through hole	ϕ 45 Knockout hole
	(Uses when twinning kit (optional parts) is mounted.)	
③	Bottom through hole	150 × 94 Knockout hole
④	Front through hole	ϕ 65 or ϕ 40 Knockout hole
⑤	Front through hole	ϕ 52 or ϕ 27 Knockout hole
⑥	Bottom through hole	ϕ 65 Knockout hole
⑦	Bottom through hole	ϕ 52 Knockout hole
⑧	For transmission cables	ϕ 34 Knockout hole

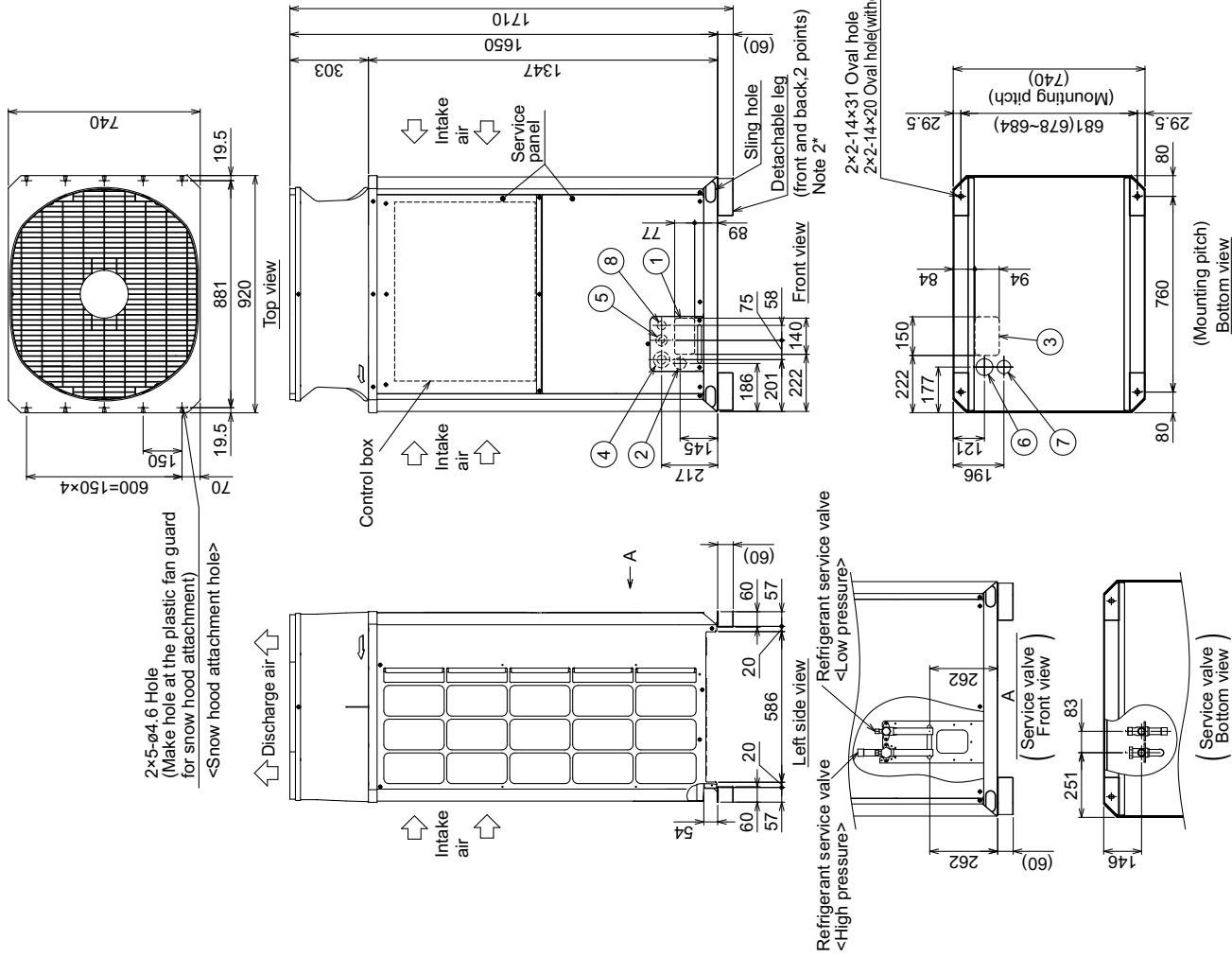

PURY-P200, 250YLM-A1 (-BS)

Unit : mm

R2

1. Required space around the unit

● In case of single installation

① Secure enough space around the unit as shown in the figure below.

With a space of at least 100mm to the wall on the back of the unit

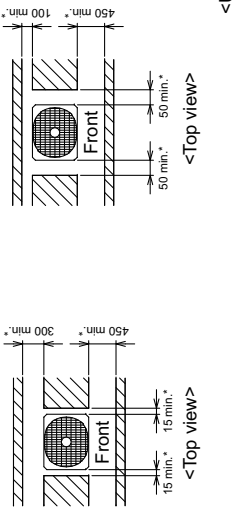

<Unit:mm>

② When the height of the walls on the front, back or on the sides<H> exceeds the wall height limit as defined below add the height that exceeds the height limit <h> to the figures that are marked with an asterisk.

<Wall height limit> Front: Up to the unit height
Back : Up to 500mm from the unit bottom
Side : Up to the unit height

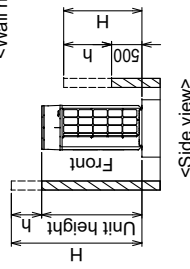

<Side view>

2. Foundation work

- ① Take into consideration the surface strength, water drainage route, piping route, and wiring route when preparing the installation site.
<Note that the drain water comes out of the unit during operation.>
- ② Build the foundation in such way that the corner of the installation leg is securely supported as shown in the right figure. (Fig. A, B)
When using a rubber isolating cushion, please ensure it is large enough to cover the entire width of each of the unit's legs.
- ③ The protrusion length of the anchor bolt must not exceed 30mm. (Fig. A, B)
- ④ Use four fixing plates as shown in the right figure <field supply required> when using post-installed anchor bolts. (Fig. C, D)
- ⑤ To prevent small animals and water and snow from entering the unit and damaging its parts, close the gap around the edges of through holes for pipes and wires with filler plates <field supply required>.
- ⑥ When the pipes or cables are routed at the bottom of the unit, make sure that the through hole at the base of the unit does not get blocked with the installation base.
- ⑦ Refer to the Installation Manual when installing units on an installation base.

● In case of collective installation

- ① When multiple units are installed adjacent to each other, secure enough space to allow for air circulation and walkway between groups of units as shown in the figures below.
- ② At least two sides must be left open.
- ③ As with the single installation, add the height that exceeds the height limit<h> to the figures that are marked with an asterisk.
- ④ If there is a wall at both the front and the rear of the unit, install up to six units consecutively in the side direction and provide a space of 1000mm or more as inlet space/ passage space for each six units.

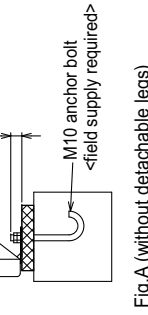
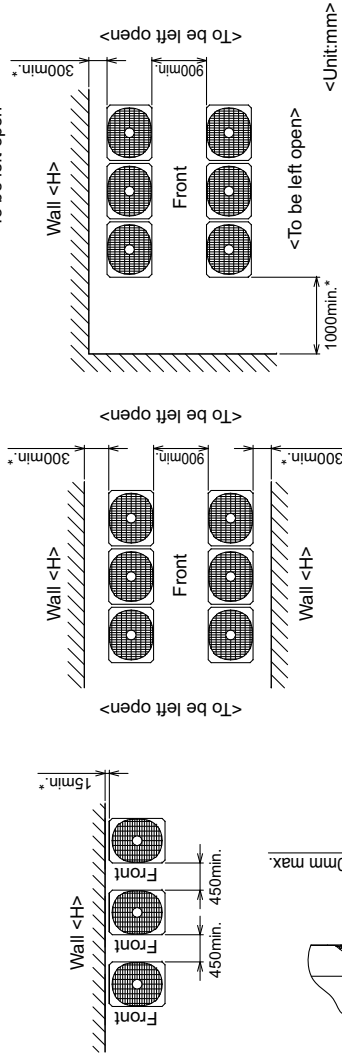
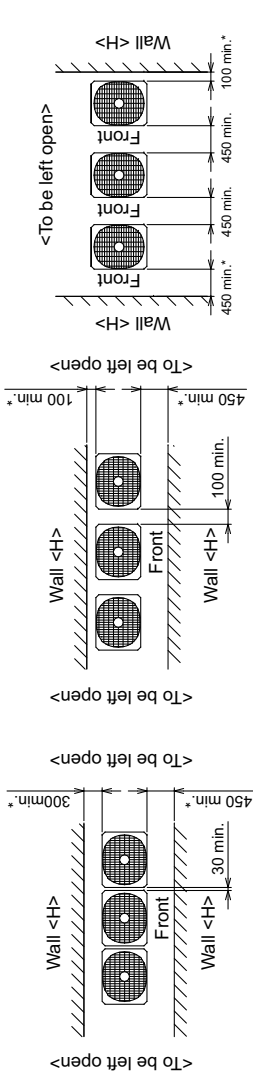

Fig. A (without detachable legs)

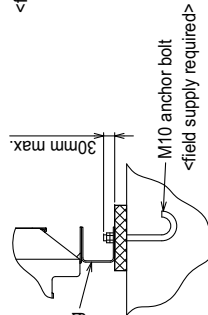

Fig. B (with detachable legs)

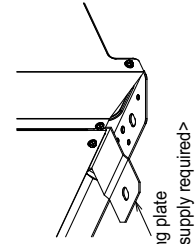

Fig. C (without detachable legs)

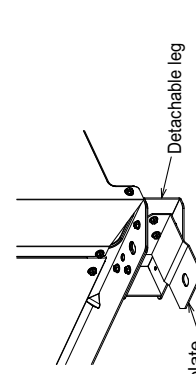

Fig. D (with detachable legs)

PURY-P300, 350, 400YLM-A1 (-BS)

Unit : mm

- <Accessories>
 ●Connecting pipe
 <Low pressure>
 ·Pipe (IDø25.4×IDø22.2) ... P300 1pc.
 ·Pipe (IDø28.58×IDø25.4) ... P350,P400 1pc.
 <High pressure>
 ·Pipe (IDø25.4×ODø19.05) ... P300,P350 1pc.
 ·Pipe (IDø25.4×IDø22.2) ... P400 1pc.
 ·Elbow(IDø19.05×ODø19.05) ... P300,P350 1pc.

Note 1. Please refer to the next page for information regarding necessary spacing around the unit and foundation work.
 2. The detachable leg can be removed at site.
 3. At brazing of pipes, wrap the refrigerant service valve with wet cloth and keep the temperature of refrigerant service valve under 120°C.

Connecting pipe specifications

Model	Refrigerant pipe		Diameter	
	High pressure	Low pressure	High pressure	Low pressure
PURY-P300YLM-A1(-BS)	ø19.05 Brazed *1	ø22.2 Brazed *1	ø25.4	ø25.4
PURY-P350YLM-A1(-BS)	ø19.05 Brazed *1	ø28.58 Brazed *1	ø25.4	ø25.4
PURY-P400YLM-A1(-BS)	ø22.2 Brazed *1	ø28.58 Brazed *1	ø25.4	ø25.4

*1 Use the included connecting pipe and connect to the refrigerant service valve piping.

NO.	Usage	Specifications
①	Front through hole	140 × 77 Knockout hole
②	Front through hole (Uses when twinning kit (optional parts) is mounted.)	ø45 Knockout hole
③	Bottom through hole	150 × 94 Knockout hole
④	Front through hole	ø65 or ø40 Knockout hole
⑤	Front through hole	ø52 or ø27 Knockout hole
⑥	Bottom through hole	ø65 Knockout hole
⑦	Bottom through hole	ø52 Knockout hole
⑧	For transmission cables	ø34 Knockout hole

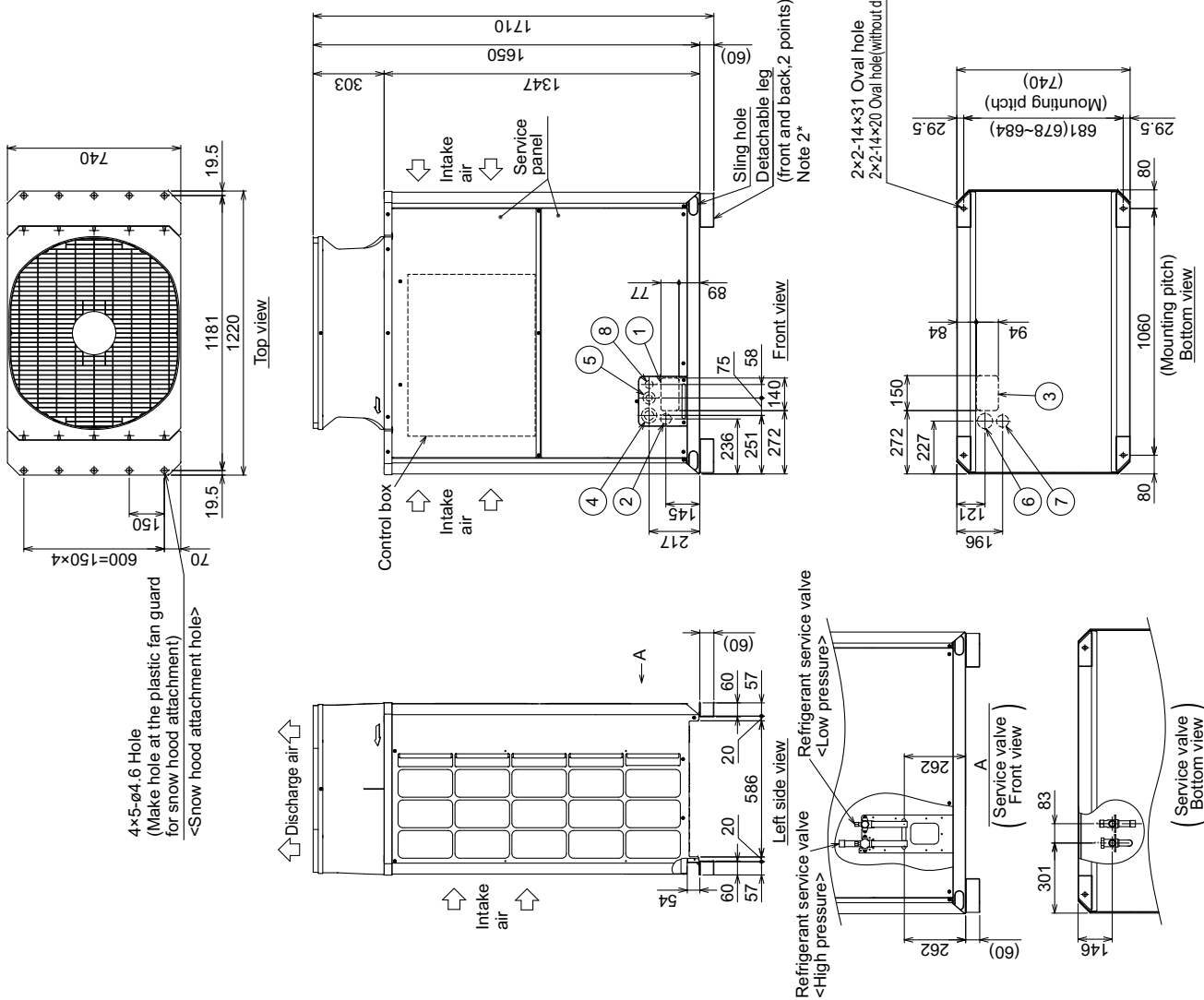

PURY-P300, 350, 400YLM-A1 (-BS)

Unit : mm

● In case of collective installation

- ① When multiple units are installed adjacent to each other, secure enough space to allow for air circulation and walkway between groups of units as shown in the figures below.
- ② At least two sides must be left open.
- ③ As with the single installation, add the height that exceeds the height limit<h> to the figures that are marked with an asterisk.
- ④ If there is a wall at both the front and the rear of the unit, install up to six units consecutively in the side direction and provide a space of 1000mm or more as inlet space/ passage space for each six units.

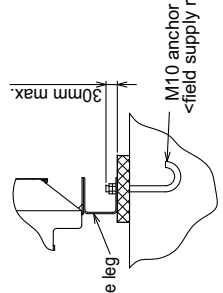
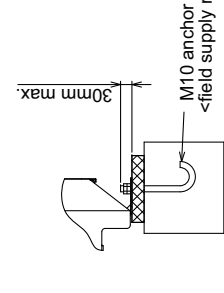
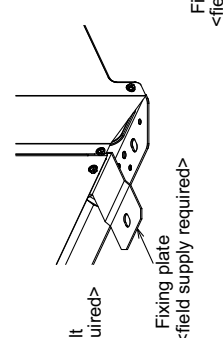
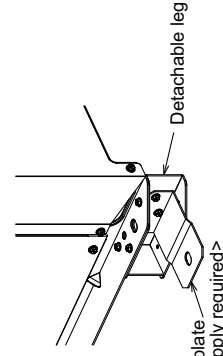
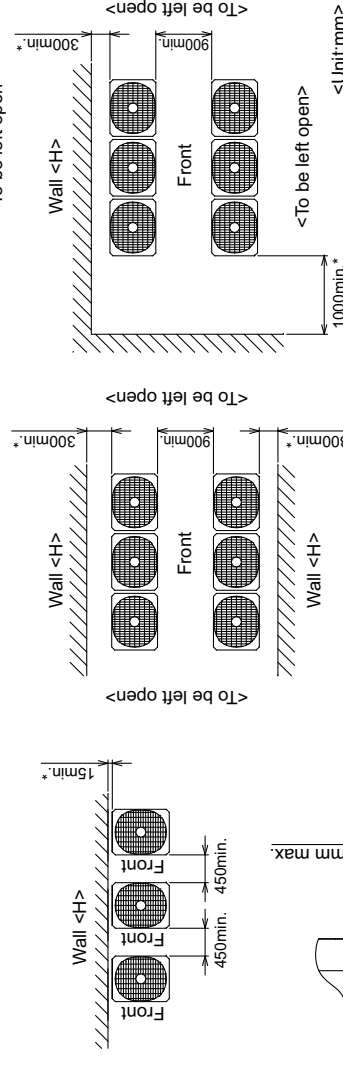
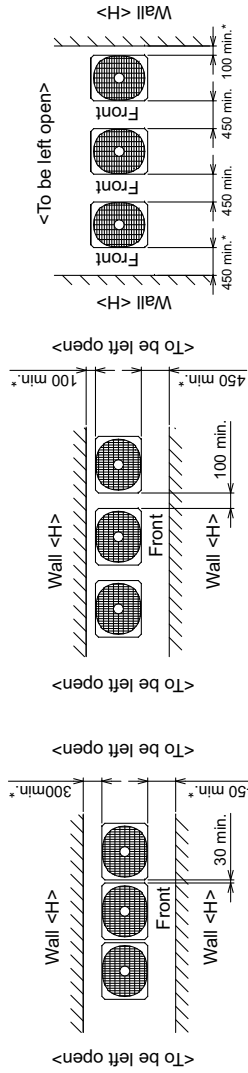

1. Required space around the unit

● In case of single installation

- ① Secure enough space around the unit as shown in the figure below.
 ·With a space of at least 100mm to the wall on the back of the unit
 ·With a space of at least 300mm to the wall on the back of the unit
 Diagrams showing top and side views with dimensions: 15mm, 50mm, 100mm, 450mm, 300mm, 50mm, 15mm. Labels include "Front", "<Top view>", "<Side view>", and "<Unit:mm>".
- ② When the height of the walls on the front, back or on the sides<h> exceeds the wall height limit as defined below add the height that exceeds the height limit<h> to the figures that are marked with an asterisk.
 Diagram showing side view with dimensions: 500mm, h, H. Labels include "Front", "Unit height", "h", "H", and "<Side view>".

<Wall height limit> Front :Up to the unit height
 Back :Up to 500mm from the unit bottom
 Side :Up to the unit height

2. Foundation work

- ① Take into consideration the surface strength, water drainage route, piping route, and wiring route when preparing the installation site.
 <Note that the drain water comes out of the unit during operation.>
- ② Build the foundation in such way that the corner of the installation leg is securely supported as shown in the right figure. (Fig.A,B)
 When using a rubber isolating cushion, please ensure it is large enough to cover the entire width of each of the unit's legs.
- ③ The protrusion length of the anchor bolt must not exceed 30mm. (Fig.A,B)
- ④ Use four fixing plates as shown in the right figure. <field supply required>
 when using post-installed anchor bolts. (Fig.C,D)
- ⑤ To prevent small animals and water and snow from entering the unit and damaging its parts, close the gap around the edges of through holes for pipes and wires with filler plates. <field supply required>.
- ⑥ When the pipes or cables are routed at the bottom of the unit, make sure that the through hole at the base of the unit does not get blocked with the installation base.
- ⑦ Refer to the Installation Manual when installing units on an installation base.

PURY-P450, 500YLM-A1 (-BS)

Unit : mm

- <Accessories>
- Connecting pipe
 - <Low pressure>
 - Elbow(IDø28.58×ODø28.58) ...P450,P500 1pc.
 - <High pressure>
 - Pipe (IDø25.4×IDø22.2) ...P450,P500 1pc.

Note 1. Please refer to the next page for information regarding necessary spacing around the unit and foundation work.
 2. The detachable leg can be removed at site.
 3. At brazing of pipes, wrap the refrigerant service valve with wet cloth and keep the temperature of refrigerant service valve under 120°C.

Connecting pipe specifications

Model	Refrigerant pipe		Service valve	
	High pressure	Low pressure	High pressure	Low pressure
PURY-P450YLM-A1(-BS)	ø22.2 Brazed *1	ø28.58 Brazed *1	ø25.4	ø28.58
PURY-P500YLM-A1(-BS)				

*1 Use the included connecting pipe and connect to the refrigerant service valve piping.

NO.	Usage	Specifications
①	Front through hole	140 × 77 Knockout hole
②	Front through hole	140 × 77 Knockout hole
	Front through hole (Uses when twinning kit (optional parts) is mounted.)	
③	Bottom through hole	ø45 Knockout hole
④	Front through hole	150 × 94 Knockout hole
⑤	Front through hole	ø65 or ø40 Knockout hole
⑥	Bottom through hole	ø52 or ø27 Knockout hole
⑦	Bottom through hole	ø65 Knockout hole
⑧	Bottom through hole	ø52 Knockout hole
⑨	Front through hole	ø34 Knockout hole

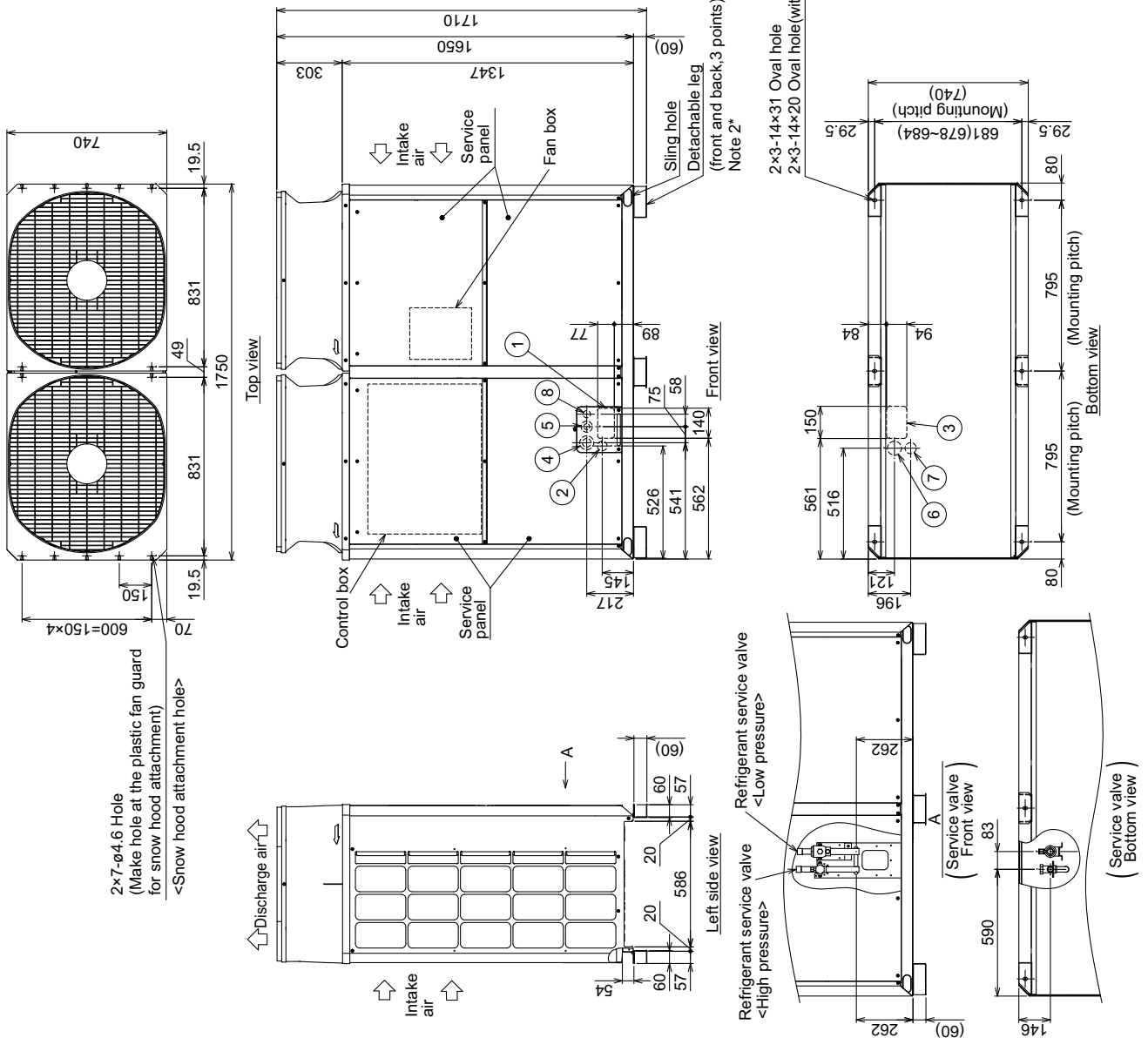

PURY-P450, 500YLM-A1 (-BS)

Unit : mm

● In case of collective installation

- When multiple units are installed adjacent to each other, secure enough space to allow for air circulation and walkway between groups of units as shown in the figures below.
- At least two sides must be left open.
- As with the single installation, add the height that exceeds the height limit<h> to the figures that are marked with an asterisk.
- If there is a wall at both the front and the rear of the unit, install up to three units consecutively in the side direction and provide a space of 1000mm or more as inlet space/ passage space for each three units.

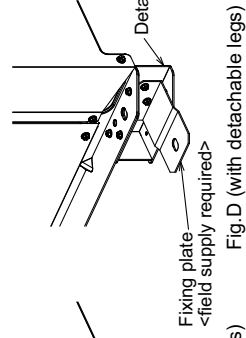
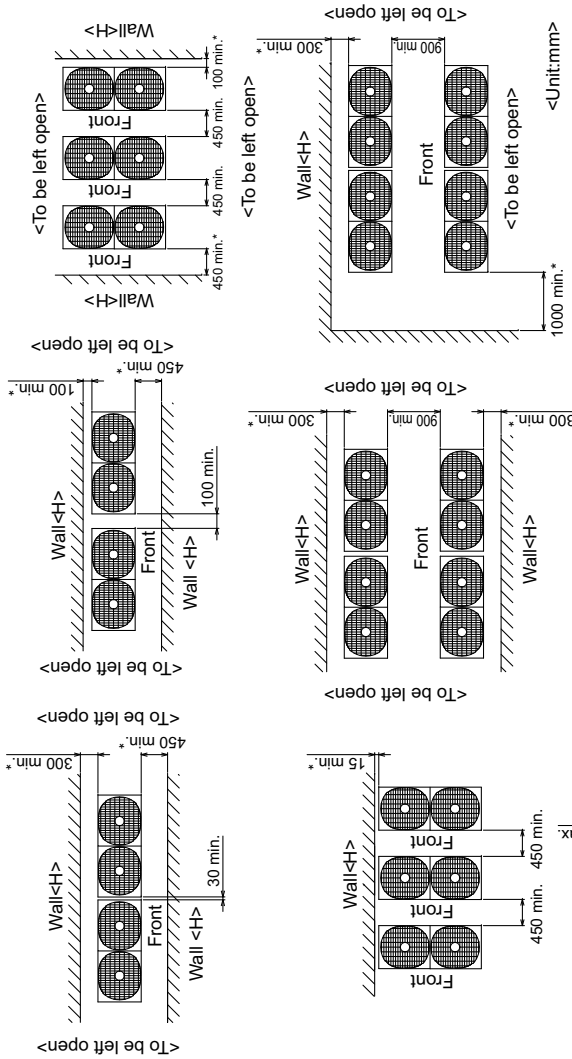

Fig. D (with detachable legs)

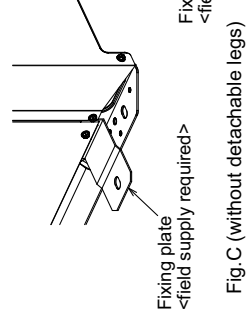
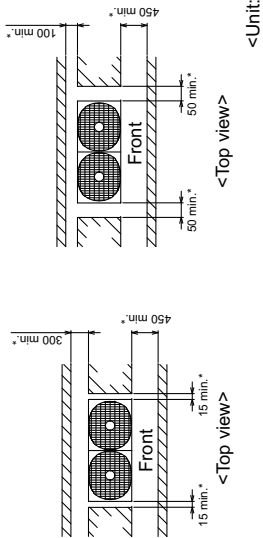

Fig. C (without detachable legs)

1. Required space around the unit

● In case of single installation

- Secure enough space around the unit as shown in the figure below.
 - With a space of at least 100mm to the wall on the back of the unit



- When the height of the walls on the front, back or on the sides<H> exceeds the wall height limit as defined below add the height that exceeds the height limit <h> to the figures that are marked with an asterisk.

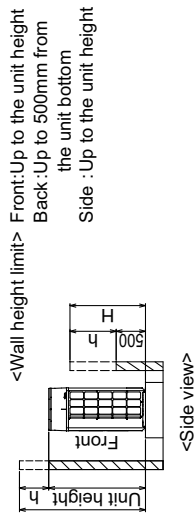

<Wall height limit> Front: Up to the unit height
Back: Up to 500mm from the unit bottom
Side : Up to the unit height

2. Foundation work

- Take into consideration the surface strength, water drainage route, piping route and wiring route when preparing the installation site.
 - Note that the drain water comes out of the unit during operation.>
- Build the foundation in such way that the corner of the installation leg is securely supported as shown in the right figure.(Fig.A,B)
 - When using a rubber isolating cushion, please ensure it is large enough to cover the entire width of each of the unit's legs.
- The protrusion length of the anchor bolt must not exceed 30mm.(Fig.A,B)
- Use four fixing plates as shown in the right figure <field supply required> when using post-installed anchor bolts.(Fig.C,D)
- To prevent small animals and water and snow from entering the unit and damaging its parts, close the gap around the edges of through holes for pipes and wires with filler plates <field supply required>.
- When the pipes or cables are routed at the bottom of the unit, make sure that the through hole at the base of the unit does not get blocked with the installation base.
- Refer to the Installation Manual when installing units on an installation base.

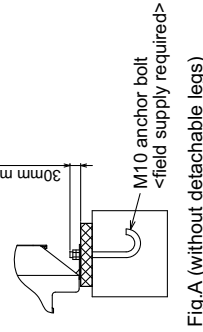

Fig. A (without detachable legs)

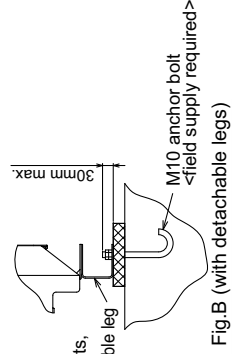
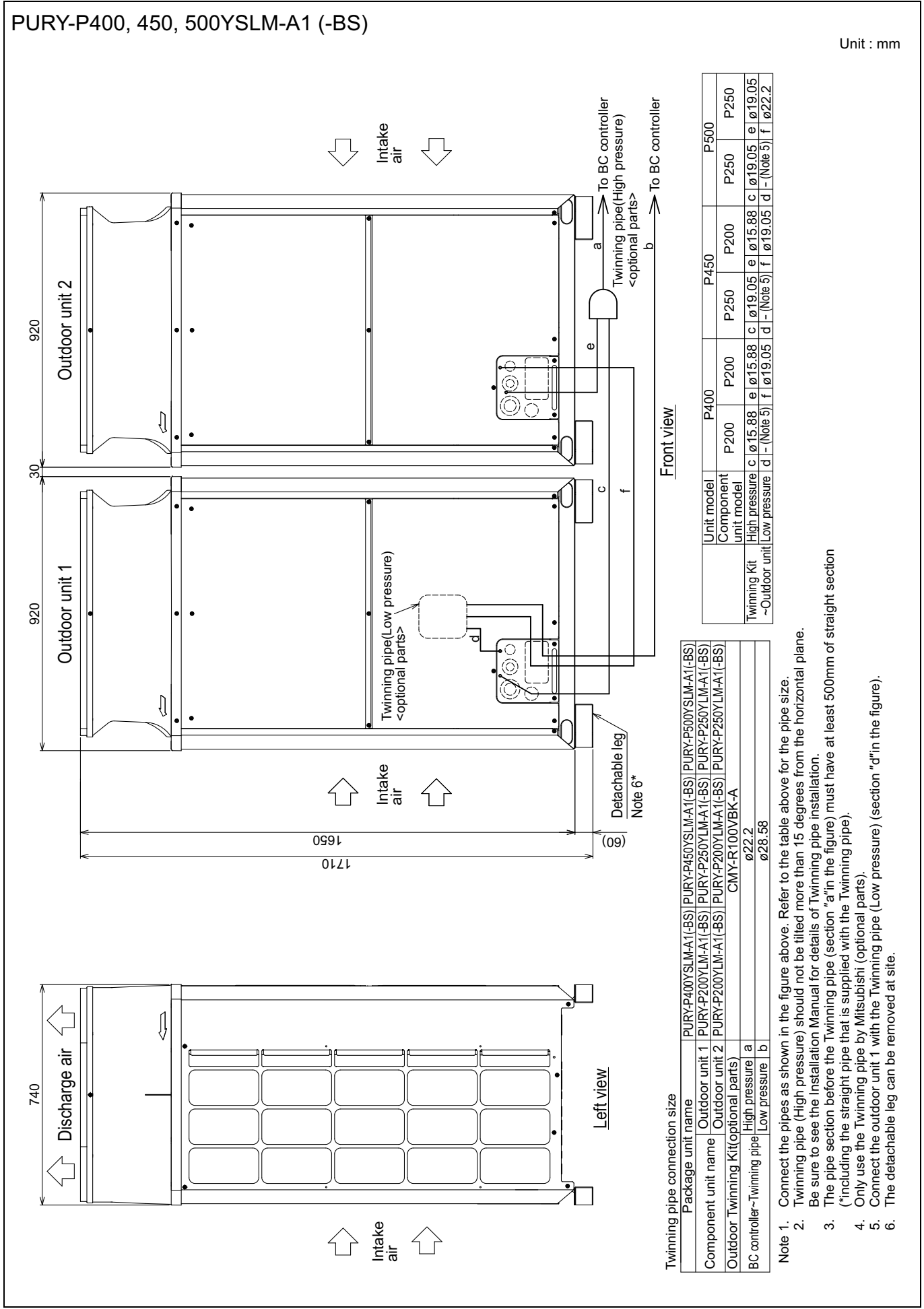
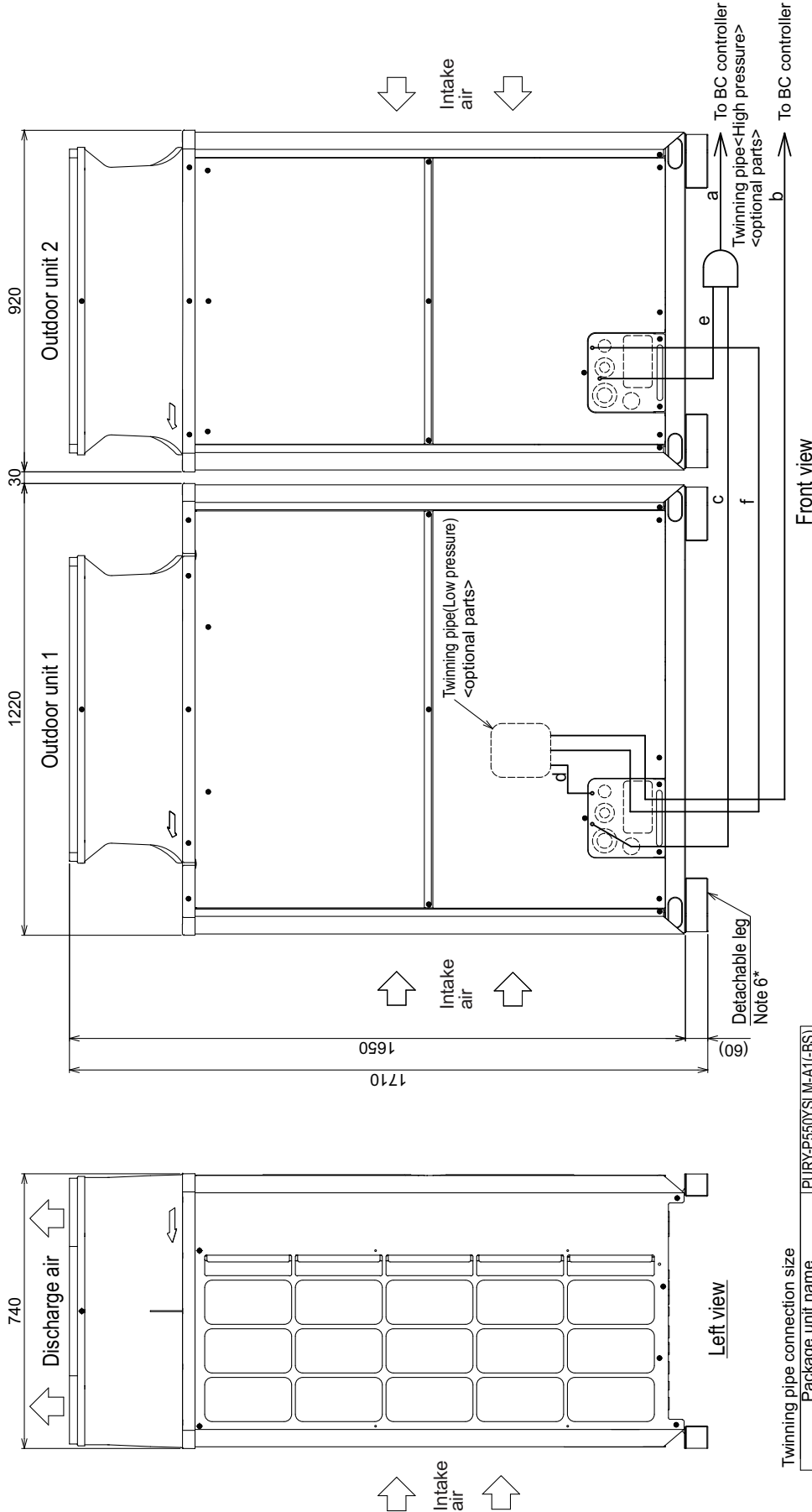

Fig. B (with detachable legs)



PURY-P550YSLM-A1 (-BS)

Unit : mm



Twinning pipe connection size

Package unit name	PURY-P550YSLM-A1(-BS)
Component unit name	Outdoor unit 1 PURY-P300YLM-A1(-BS) Outdoor unit 2 PURY-P250YLM-A1(-BS)
Outdoor Twinning Kit (optional parts)	CMY-R100VBK2
BC controller~ Twinning pipe	High pressure a Low pressure b
	ø28.58 ø28.58

Unit model	P550
Component unit model	P300 P250
Twinning Kit	High pressure c ø19.05 e ø19.05 Low pressure d - (Note 5) f ø22.2

- Note 1. Connect the pipes as shown in the figure above. Refer to the table above for the pipe size.
 2. Twinning pipe (High pressure) should not be tilted more than 15 degrees from the horizontal plane. Be sure to see the Installation Manual for details of Twinning pipe installation.
 3. The pipe section before the Twinning pipe (section "a" in the figure) must have at least 500mm of straight section (*including the straight pipe that is supplied with the Twinning pipe).
 4. Only use the Twinning pipe by Mitsubishi (optional parts).
 5. Connect the outdoor unit 1 with the Twinning pipe (Low pressure) (section "d" in the figure).
 6. The detachable leg can be removed at site.

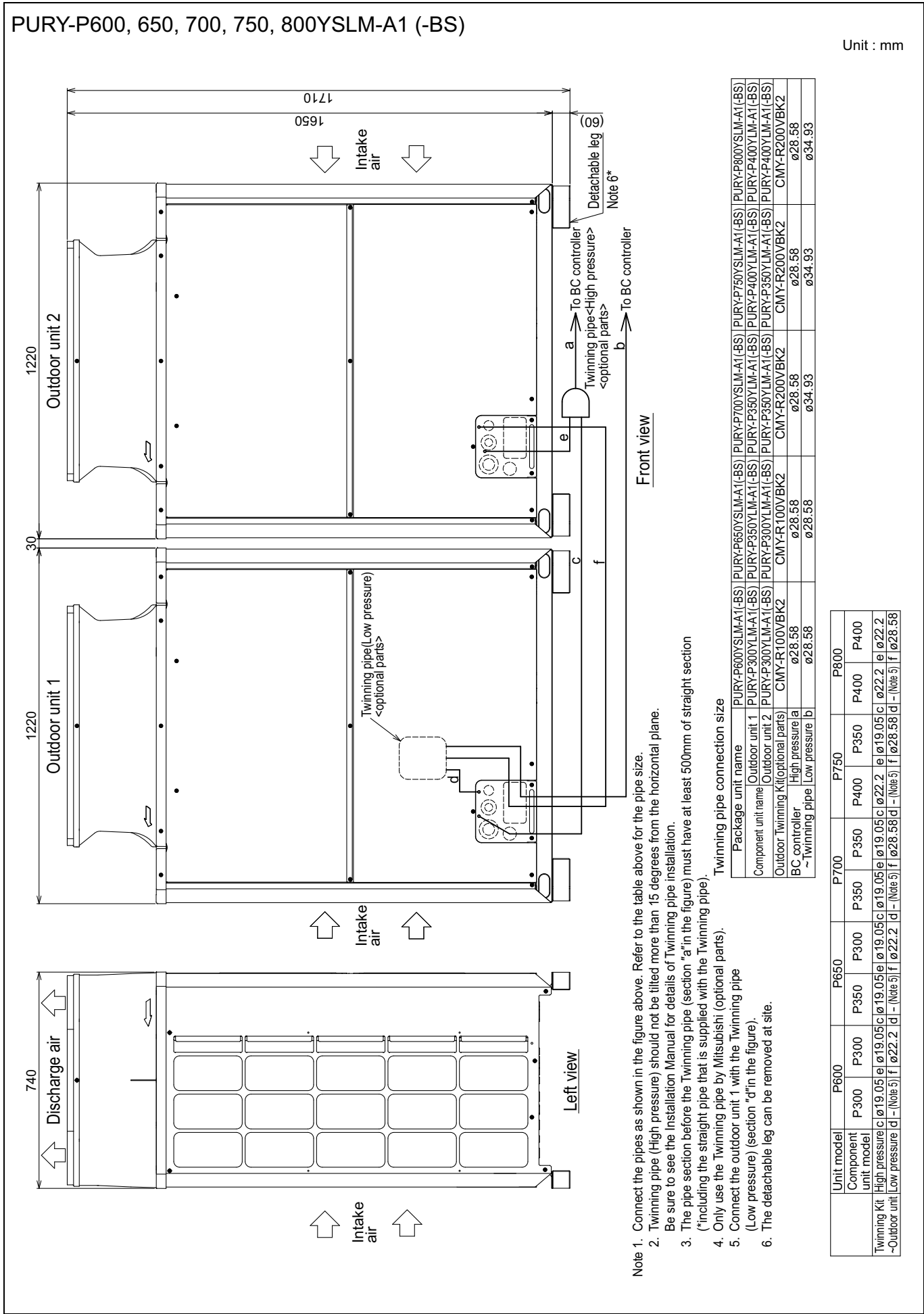

PURY-P850YSLM-A1 (-BS)

Unit : mm

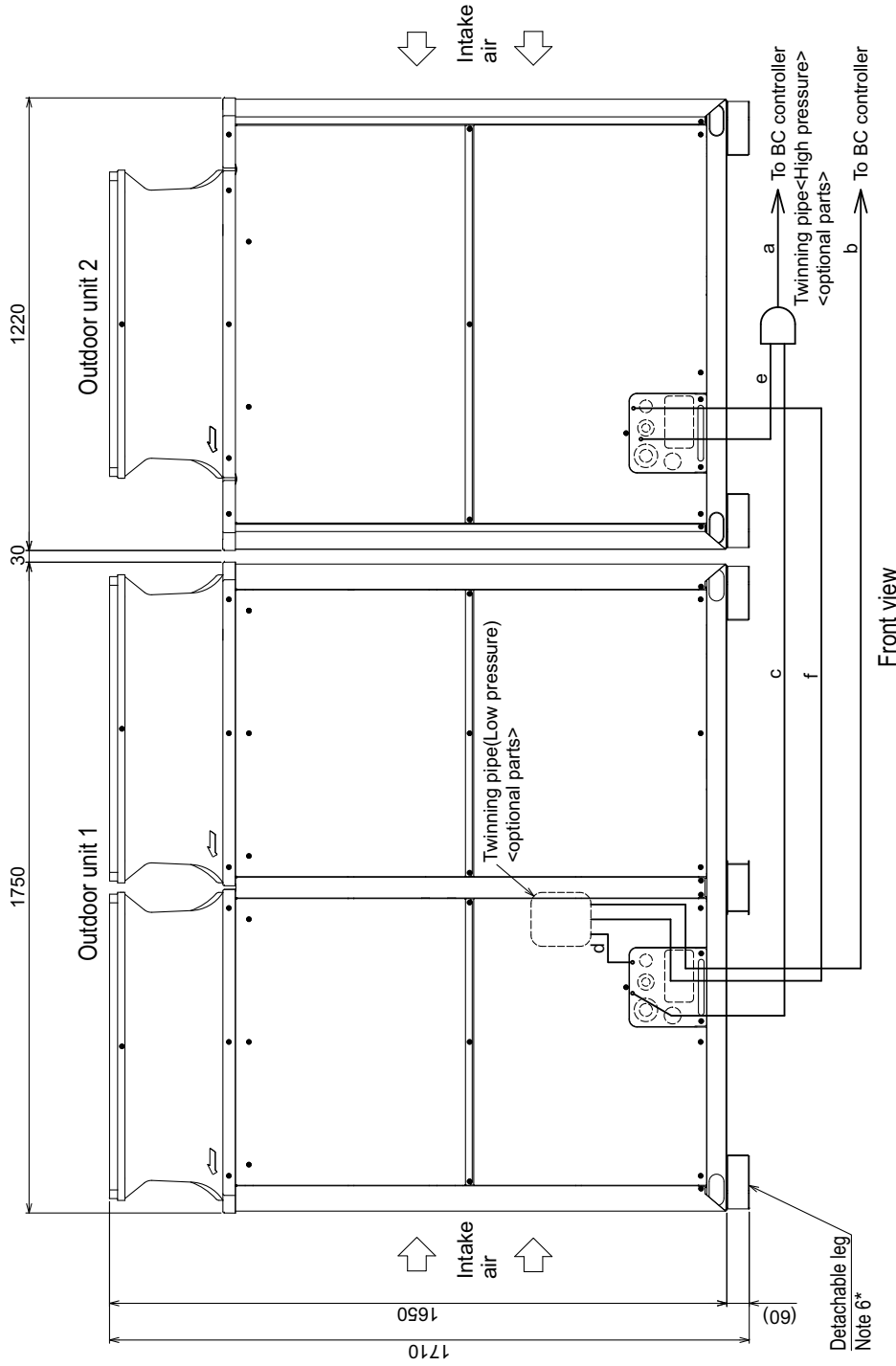

Front view

Left view

Twinning pipe connection size

Package unit name		PURY-P850YSLM-A1(-BS)	
Component unit name	Outdoor unit 1	PURY-P450YLM-A1(-BS)	P850
Outdoor Twinning Kit(optional parts)	Outdoor unit 2	PURY-P400YLM-A1(-BS)	P450
BC controller~Twinning pipe	High pressure	CMY-R200XLVBK	P400
	Low pressure	a	c
		ø28.58	ø22.2
		b	d
		ø41.28	ø28.58

Unit model		P850	
Component unit model	P450	P400	
Twinning Kit ~Outdoor unit	High pressure	c	e
	Low pressure	d - (Note 5)	f
		ø22.2	ø28.58

- Note 1. Connect the pipes as shown in the figure above. Refer to the table above for the pipe size.
 2. Twinning pipe (High pressure) should not be tilted more than 15 degrees from the horizontal plane. Be sure to see the Installation Manual for details of Twinning pipe installation.
 3. The pipe section before the Twinning pipe (section "a" in the figure) must have at least 500mm of straight section (*including the straight pipe that is supplied with the Twinning pipe).
 4. Only use the Twinning pipe by Mitsubishi (optional parts).
 5. Connect the outdoor unit 1 with the Twinning pipe (Low pressure) (section "d" in the figure).
 6. The detachable leg can be removed at site.

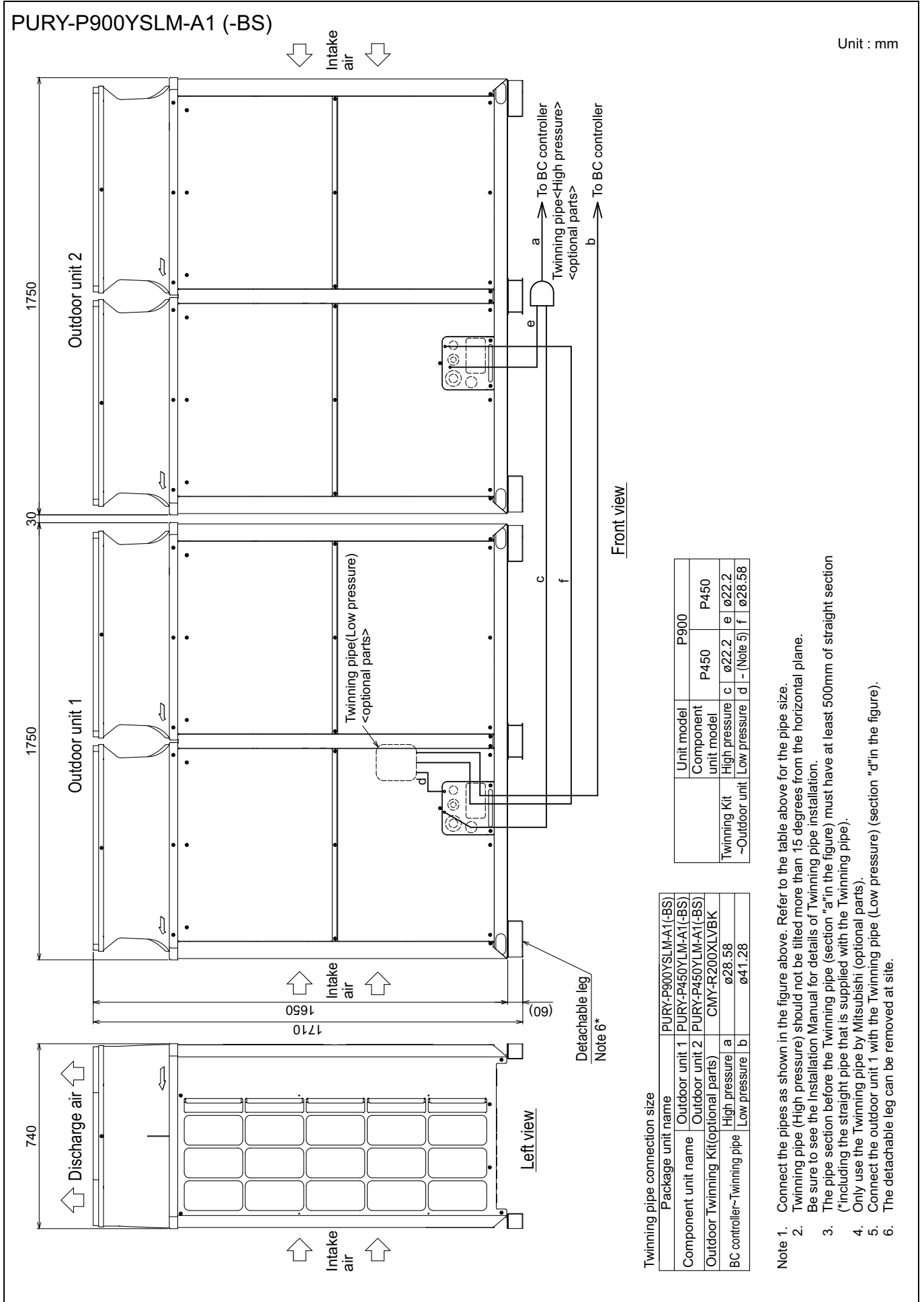

R2

PURY-P200, 250YLM-A1 (-BS)

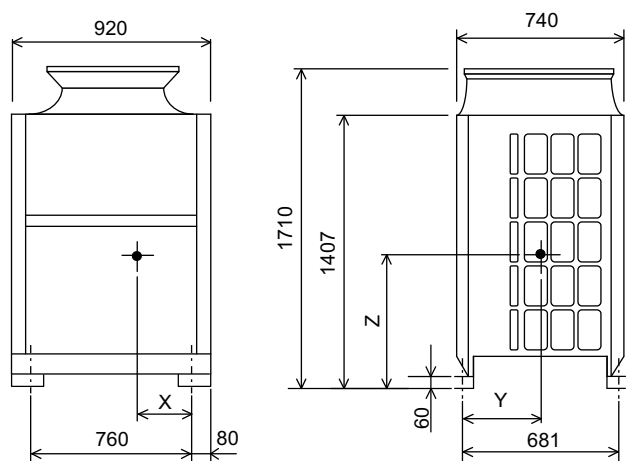

Unit : mm

Model	X	Y	Z
PURY-P200YLM-A1(-BS)	344	309	691
PURY-P250YLM-A1(-BS)	344	309	691

PURY-P300, 350, 400YLM-A1 (-BS)

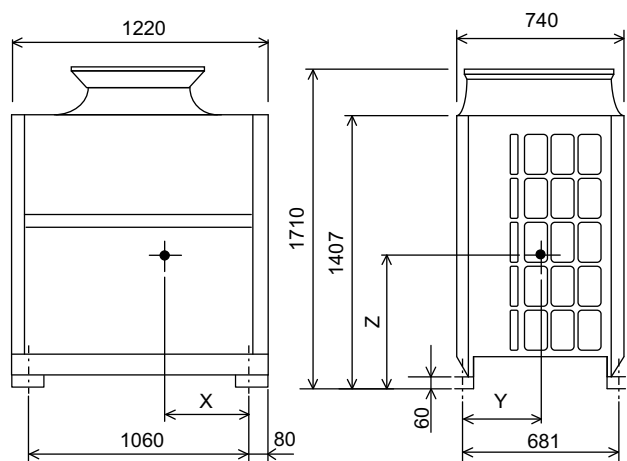

Unit : mm

Model	X	Y	Z
PURY-P300YLM-A1(-BS)	455	314	650
PURY-P350YLM-A1(-BS)	455	314	650
PURY-P400YLM-A1(-BS)	455	314	650

PURY-P450, 500YLM-A1 (-BS)

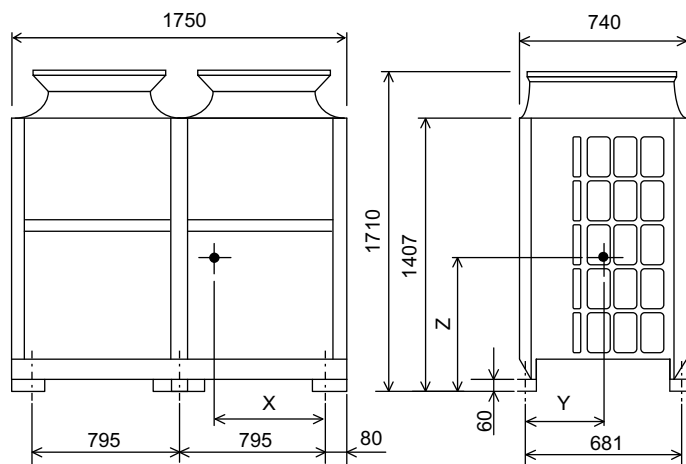

Unit : mm

Model	X	Y	Z
PURY-P450YLM-A1(-BS)	718	327	710
PURY-P500YLM-A1(-BS)	718	327	710

PURY-P200, 250, 300, 350, 400YLM-A1(-BS)

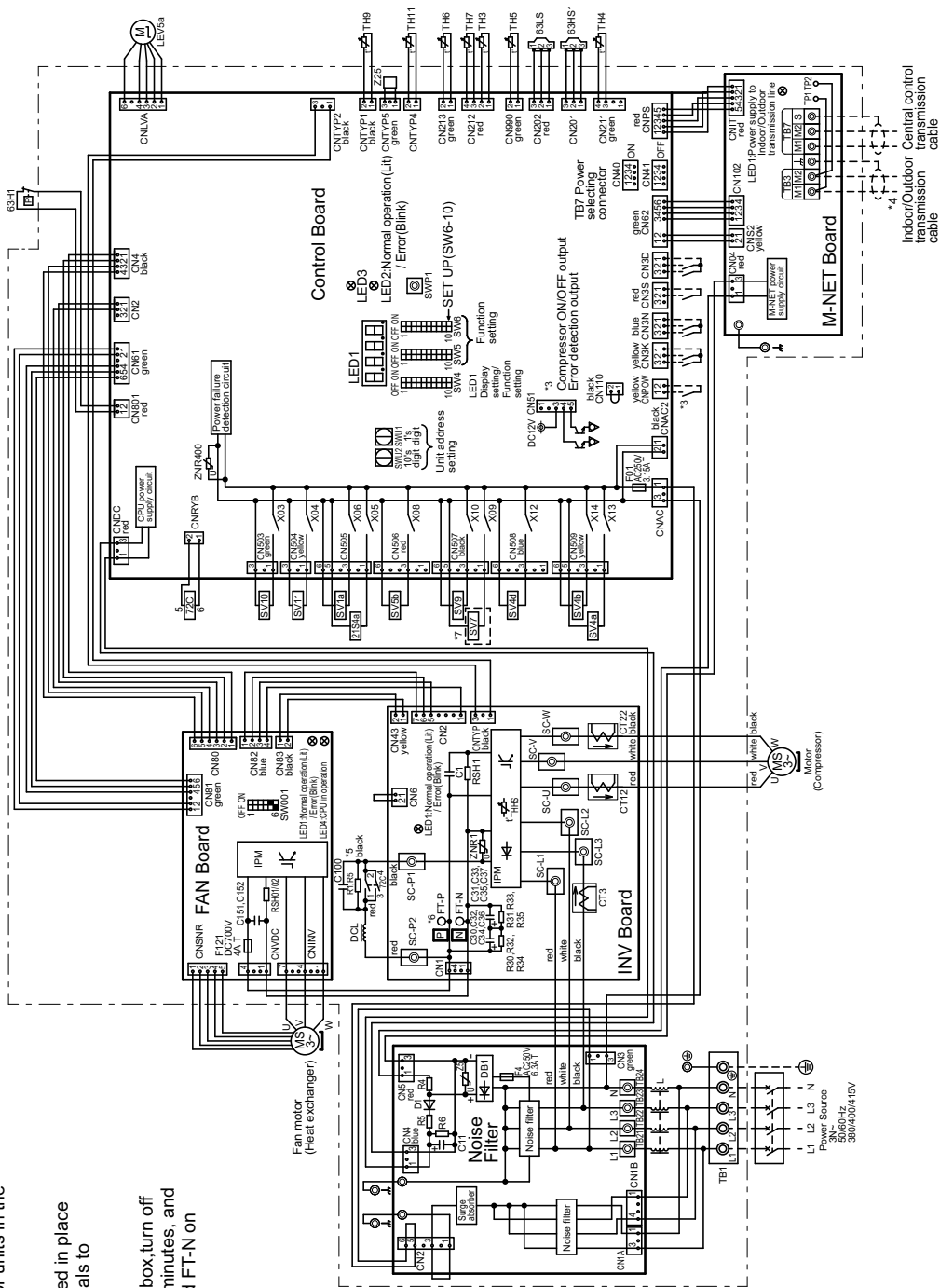

- *1. Single-dotted lines indicate wiring not supplied with the unit.
- *2. Dot-dash lines indicate the control box boundaries.
- *3. Refer to the Data book for connecting input/output signal connectors.
- *4. Daisy-chain terminals (TB3) on the outdoor units in the same refrigerant system together.
- *5. Faston terminals have a locking function. Make sure the terminals are securely locked in place after insertion. Press the tab on the terminals to removed them.
- *6. Control box houses high-voltage parts. Before inspecting the inside of the control box, turn off the power, keep the unit off for at least 10 minutes, and confirm that the voltage between FT-P and FT-N on INV Board has dropped to DC20V or less.
- *7. Difference of appliance.

Model name	appliance
P200/250/300/350/400	*7 do not exist
EP200/250/300/350	*7 exist

<Symbol explanation>

Symbol	Explanation
21S4a	4-way valve(Cooling/Heating switching)
63H1	High pressure protection for the outdoor unit
63HS1	Discharge pressure sensor
63LS	Low pressure sensor
Z2C	Magnetic relay (inverter main circuit)
C30-C37	Capacitor (inverter main circuit)
CT12, CT22, CT3	Current sensor(AC)
DCL	DC reactor
LEV5a	Choke coil (for high frequency noise reduction)
R1.5	Resistor
RSH1/02, RSH1	For inrush current prevention
SV1a	For current detection
SV4a, b, d	For opening/closing the bypass circuit under the OS
SV5b	Heat exchanger capacity control
SV7, SV9	Outdoor unit heat exchanger capacity control
SV10, SV11	For opening/closing the bypass circuit
TB1	Power supply
TB3	Indoor/Outdoor transmission cable
TB7	Central control transmission cable
TH3	Pipe temperature
TH4	Discharge pipe temperature
TH5	ACC inlet pipe temperature
TH6	Subcooled liquid refrigerant temperature
TH7	OA temperature
TH9, TH11	Heat exchanger outlet pipe temperature
THHS	IPM temperature
Z25	Function setting connector

R2

PURY-P450, 500YLM-A1(-BS)

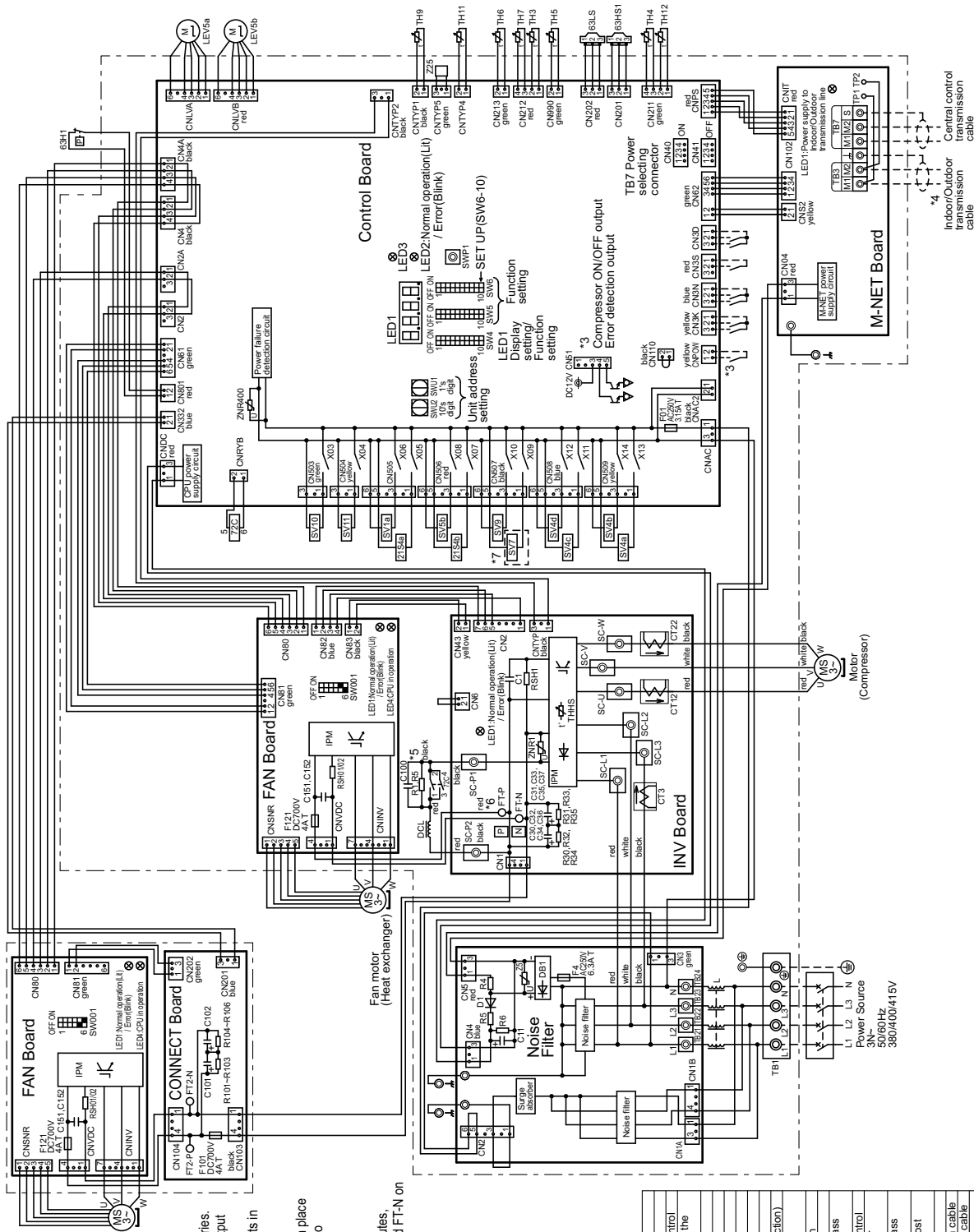

- *1. Single-dotted lines indicate wiring not supplied with the unit.
- *2. Dot-dash lines indicate the control box boundaries.
- *3. Refer to the Data book for connecting input/output signal connectors.
- *4. Daisy-chain terminals (TB3) on the outdoor units in the same refrigerant system together.
- *5. Faston terminals have a locking function. Make sure the terminals are securely locked in place after insertion. Press the tab on the terminals to removed them.
- *6. Control box houses high-voltage parts. Before inspecting the inside of the control box, turn off the power, keep the unit off for at least 10 minutes, and confirm that the voltage between FT-P and FT-N on INV Board has dropped to DC20V or less.
- *7. Difference of appliance.

Model name	appliance
P450/500	-7 do not exist
EP400/450	-7 exist

<Symbol explanation>

Symbol	Explanation
21SAa	4-way valve
21SAb	Cooling/Heating switching
63H1	Heat exchanger capacity control
63H1	Pressure switch
63H1	High pressure protection for the outdoor unit
63H5	Pressure
63H5	Discharge pressure
63H5	Low pressure
C30-C37	Capacitor (bypass main circuit)
C12,C12,C13	Capacitor (inverter main circuit)
DCL	DC reactor
L	Choke coil (for high frequency noise reduction)
LEV5a,b	Linear expansion valve (for the control of evaporating temperature)
RI.5	Resistor
RS102/RS91	For current detection
SV1a	For inrush current prevention
SV4a,b,c,d	Stenoid Valve
SV5b	For bypass circuit using the OS
SV7,SV9	Heat exchanger capacity control
SV10,SV11	Outdoor unit heat exchanger capacity control
SV10,SV11	For opening/closing the bypass circuit
SV10,SV11	For opening/closing the defrost circuit
TB1	Power supply
TB3	Indoor/Outdoor transmission cable
TB7	Central control transmission cable
TH3	Pipe temperature
TH4	Discharge pipe temperature
TH5	ACC inlet pipe temperature
TH6	Subcooled liquid refrigerant temperature
TH7	OA temperature
TH1,TH2	Heat exchanger outlet pipe temperature
TH5	Pipe temperature
ZS	Function setting connector

Measurement condition
PURY-P200, 250YLM-A1(-BS)

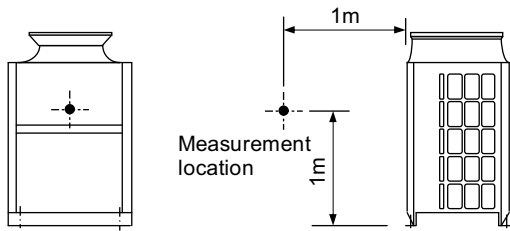

Measurement condition
PURY-P300, 350, 400YLM-A1(-BS)

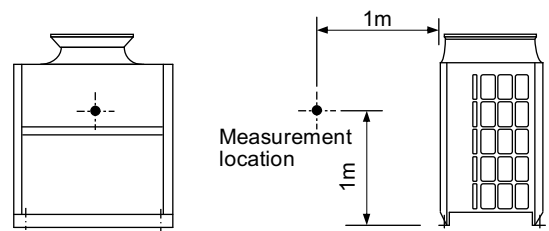

Sound level of PURY-P200YLM-A1(-BS)

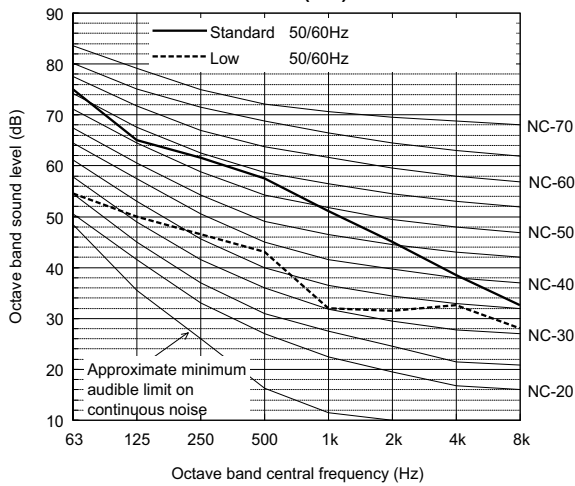

		63	125	250	500	1k	2k	4k	8k	dB(A)
Standard	50/60Hz	75.0	65.0	61.5	57.5	51.0	45.0	38.5	32.5	59.0
Low noise mode	50/60Hz	54.5	50.0	46.5	43.0	32.0	31.5	32.5	28.0	44.0

When Low noise mode is set, the A/C system's capacity is limited. The system could return to normal operation from Low noise mode automatically in the case that the operation condition is severe.

Sound level of PURY-P300YLM-A1(-BS)

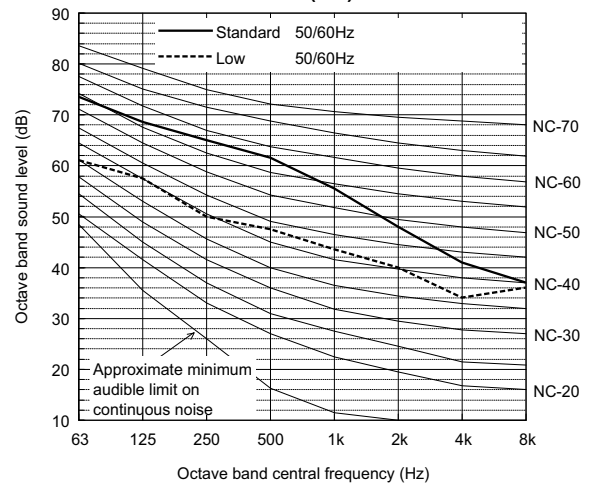

		63	125	250	500	1k	2k	4k	8k	dB(A)
Standard	50/60Hz	73.5	68.5	65.0	61.5	55.5	48.0	41.0	37.0	62.5
Low noise mode	50/60Hz	61.0	57.5	50.0	47.5	43.5	40.0	34.0	36.0	50.0

When Low noise mode is set, the A/C system's capacity is limited. The system could return to normal operation from Low noise mode automatically in the case that the operation condition is severe.

Sound level of PURY-P250YLM-A1(-BS)

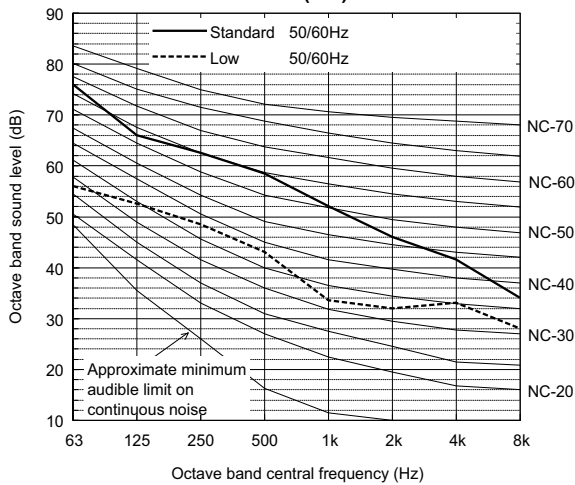

		63	125	250	500	1k	2k	4k	8k	dB(A)
Standard	50/60Hz	76.0	66.0	62.5	58.5	52.0	46.0	41.5	34.0	60.0
Low noise mode	50/60Hz	56.0	52.5	48.5	43.0	33.5	32.0	33.0	28.0	45.0

When Low noise mode is set, the A/C system's capacity is limited. The system could return to normal operation from Low noise mode automatically in the case that the operation condition is severe.

Sound level of PURY-P350YLM-A1(-BS)

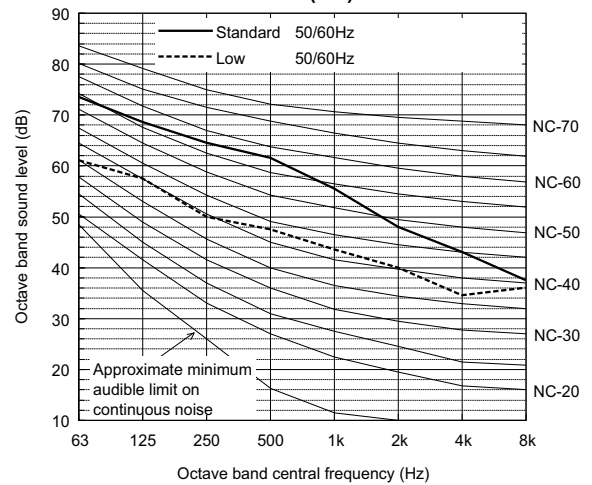

		63	125	250	500	1k	2k	4k	8k	dB(A)
Standard	50/60Hz	73.5	68.5	64.5	61.5	55.5	48.0	43.0	37.5	62.5
Low noise mode	50/60Hz	61.0	57.5	50.0	47.5	43.5	40.0	34.5	36.0	50.0

When Low noise mode is set, the A/C system's capacity is limited. The system could return to normal operation from Low noise mode automatically in the case that the operation condition is severe.

- Depending on the operation conditions, the unit generates noise caused by valve actuation, refrigerant flow, and pressure changes when operating normally. Please consider to avoid location where quietness is required. For BC controller, it is recommended to be installed in places such as ceilings of corridor, rest rooms and plant rooms.

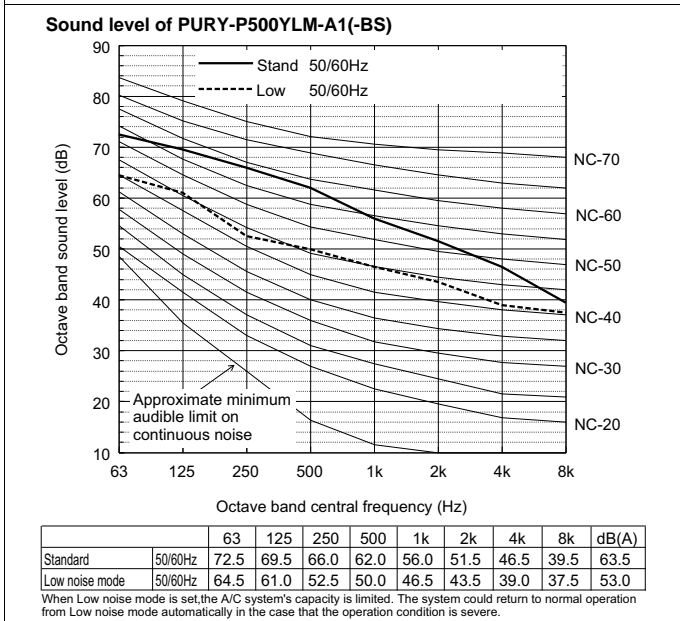
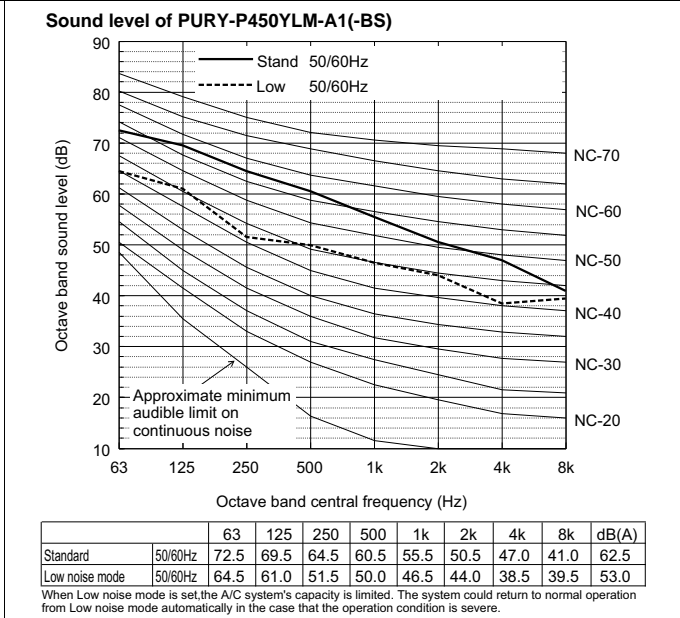
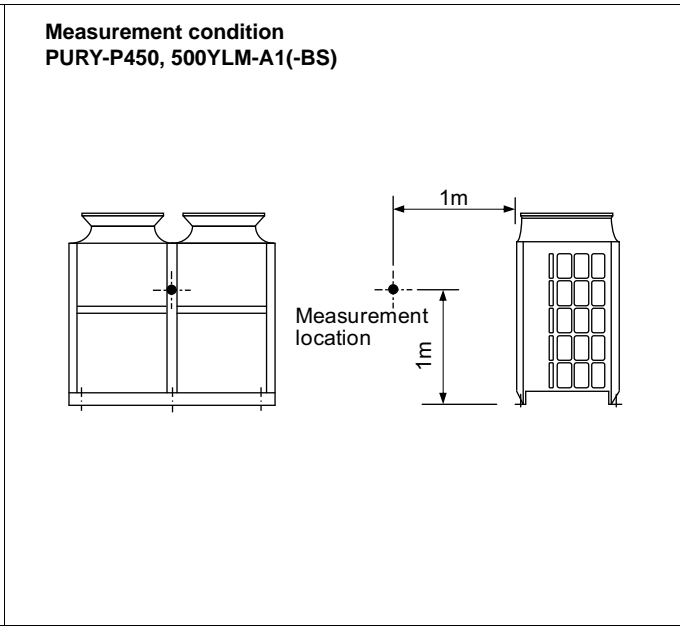
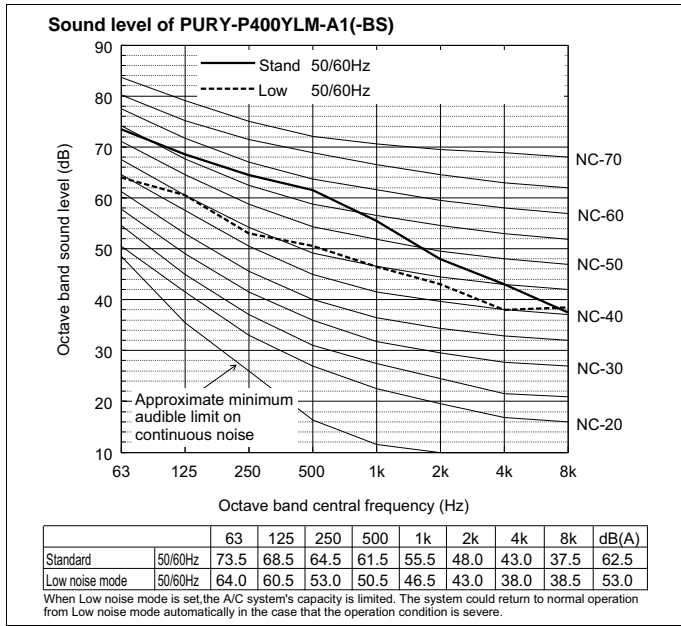

• Depending on the operation conditions, the unit generates noise caused by valve actuation, refrigerant flow, and pressure changes when operating normally. Please consider to avoid location where quietness is required. For BC controller, it is recommended to be installed in places such as ceilings of corridor, rest rooms and plant rooms.

Measurement condition
PURY-P400, 450, 500YSLM-A1(-BS)

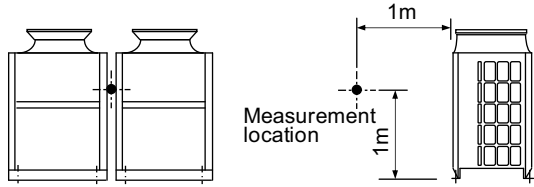

Sound level of PURY-P500YSLM-A1(-BS)

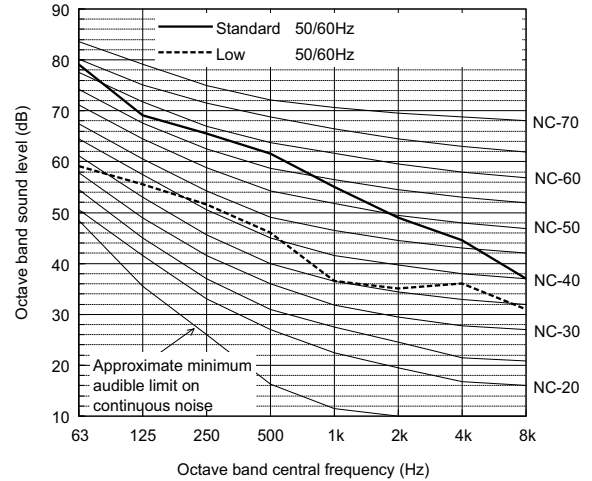

		63	125	250	500	1k	2k	4k	8k	dB(A)
Standard	50/60Hz	79.0	69.0	65.5	61.5	55.0	49.0	44.5	37.0	63.0
Low noise mode	50/60Hz	59.0	55.5	51.5	46.0	36.5	35.0	36.0	31.0	48.0

When Low noise mode is set, the A/C system's capacity is limited. The system could return to normal operation from Low noise mode automatically in the case that the operation condition is severe.

Sound level of PURY-P400YSLM-A1(-BS)

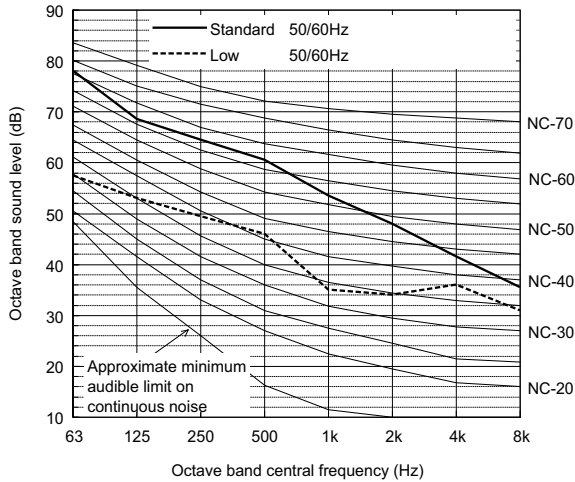

		63	125	250	500	1k	2k	4k	8k	dB(A)
Standard	50/60Hz	78.0	68.5	64.5	60.5	53.5	48.0	41.5	35.5	62.0
Low noise mode	50/60Hz	57.5	53.0	49.5	46.0	35.0	34.0	36.0	31.0	47.0

When Low noise mode is set, the A/C system's capacity is limited. The system could return to normal operation from Low noise mode automatically in the case that the operation condition is severe.

Sound level of PURY-P450YSLM-A1(-BS)

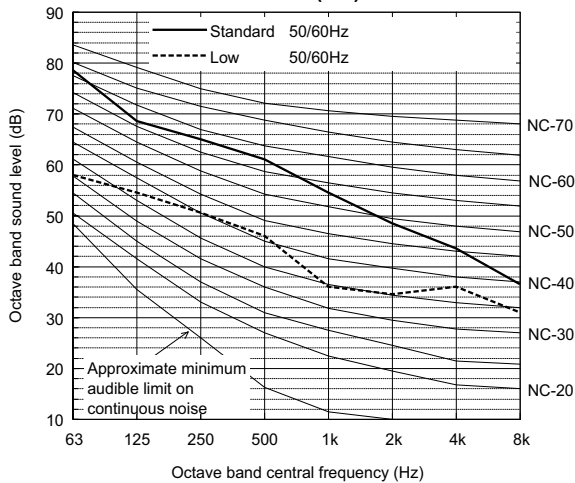

		63	125	250	500	1k	2k	4k	8k	dB(A)
Standard	50/60Hz	78.5	68.5	65.0	61.0	54.5	48.5	43.5	36.5	62.5
Low noise mode	50/60Hz	58.0	54.5	50.5	46.0	36.0	34.5	36.0	31.0	47.5

When Low noise mode is set, the A/C system's capacity is limited. The system could return to normal operation from Low noise mode automatically in the case that the operation condition is severe.

- Depending on the operation conditions, the unit generates noise caused by valve actuation, refrigerant flow, and pressure changes when operating normally. Please consider to avoid location where quietness is required. For BC controller, it is recommended to be installed in places such as ceilings of corridor, rest rooms and plant rooms.

R2

Measurement condition
PURY-P550YSLM-A1(-BS)

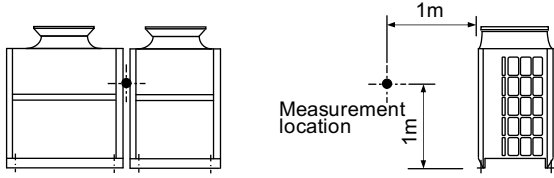

Measurement condition
PURY-P600, 650, 700, 750, 800YSLM-A1(-BS)

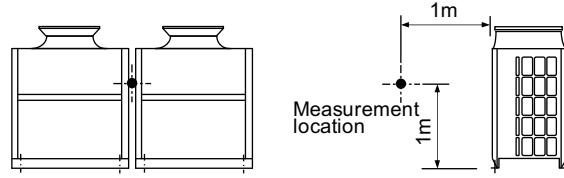

Sound level of PURY-P550YSLM-A1(-BS)

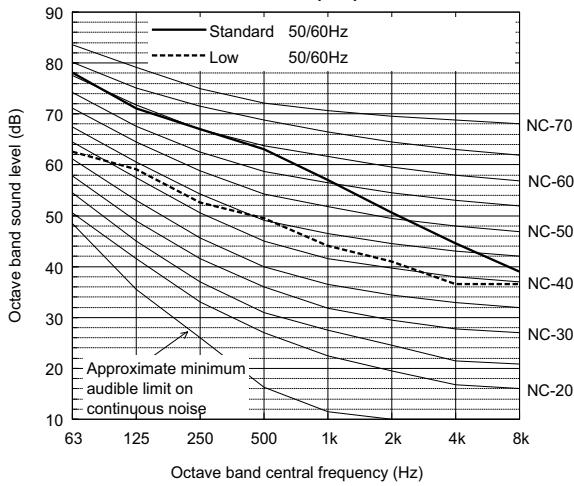

		63	125	250	500	1k	2k	4k	8k	dB(A)
Standard	50/60Hz	78.0	71.0	67.0	63.0	57.0	50.5	44.5	39.0	64.5
Low noise mode	50/60Hz	62.5	59.0	52.5	49.5	44.0	41.0	36.5	36.5	51.5

When Low noise mode is set, the A/C system's capacity is limited. The system could return to normal operation from Low noise mode automatically in the case that the operation condition is severe.

Sound level of PURY-P600YSLM-A1(-BS)

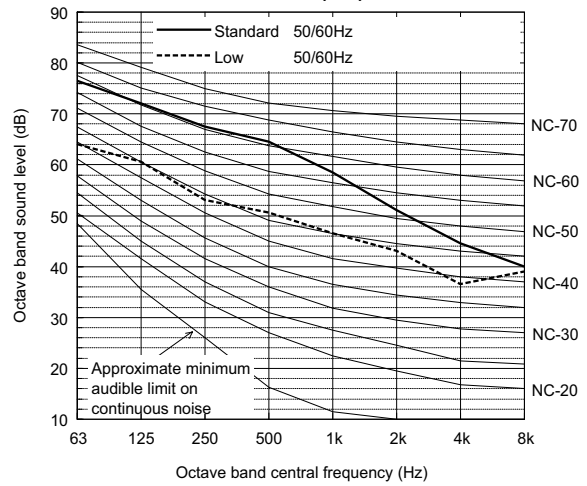

		63	125	250	500	1k	2k	4k	8k	dB(A)
Standard	50/60Hz	76.5	72.0	67.5	64.5	58.5	51.0	44.5	40.0	65.5
Low noise mode	50/60Hz	64.0	60.5	53.0	50.5	46.5	43.0	36.5	39.0	53.0

When Low noise mode is set, the A/C system's capacity is limited. The system could return to normal operation from Low noise mode automatically in the case that the operation condition is severe.

Sound level of PURY-P650YSLM-A1(-BS)

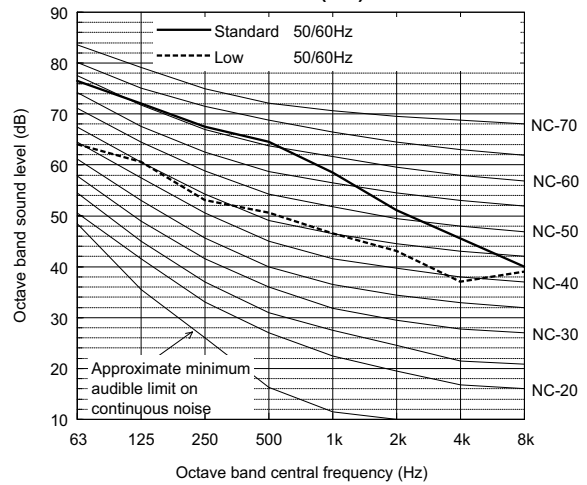

		63	125	250	500	1k	2k	4k	8k	dB(A)
Standard	50/60Hz	76.5	72.0	67.5	64.5	58.5	51.0	45.5	40.0	65.5
Low noise mode	50/60Hz	64.0	60.5	53.0	50.5	46.5	43.0	37.0	39.0	53.0

When Low noise mode is set, the A/C system's capacity is limited. The system could return to normal operation from Low noise mode automatically in the case that the operation condition is severe.

• Depending on the operation conditions, the unit generates noise caused by valve actuation, refrigerant flow, and pressure changes when operating normally. Please consider to avoid location where quietness is required. For BC controller, it is recommended to be installed in places such as ceilings of corridor, rest rooms and plant rooms.

Sound level of PURY-P700YSLM-A1(-BS)

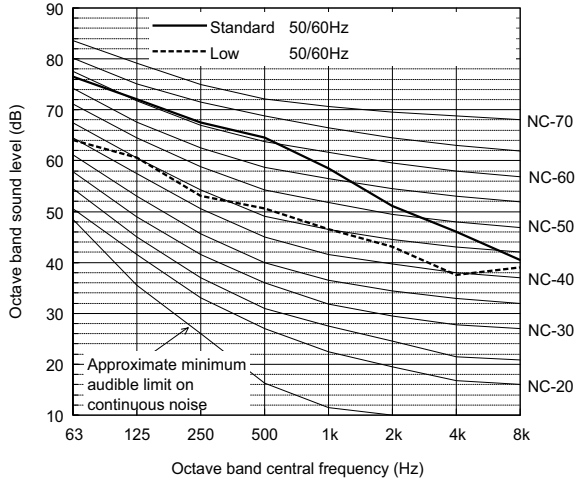

		63	125	250	500	1k	2k	4k	8k	dB(A)
Standard	50/60Hz	76.5	72.0	67.5	64.5	58.5	51.0	46.0	40.5	65.5
Low noise mode	50/60Hz	64.0	60.5	53.0	50.5	46.5	43.0	37.5	39.0	53.0

When Low noise mode is set, the A/C system's capacity is limited. The system could return to normal operation from Low noise mode automatically in the case that the operation condition is severe.

Measurement condition
PURY-P850YSLM-A1(-BS)

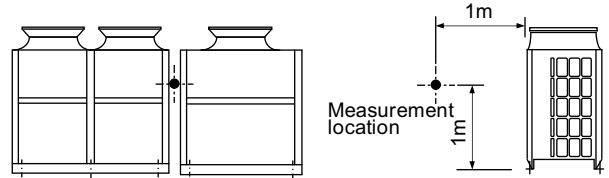

Sound level of PURY-P750YSLM-A1(-BS)

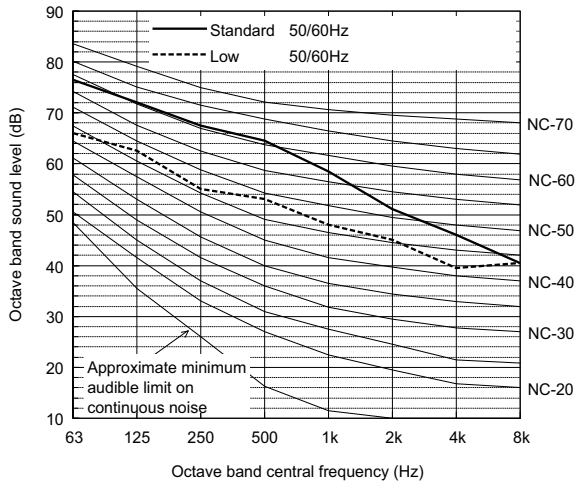

		63	125	250	500	1k	2k	4k	8k	dB(A)
Standard	50/60Hz	76.5	72.0	67.5	64.5	58.5	51.0	46.0	40.5	65.5
Low noise mode	50/60Hz	66.0	62.5	55.0	53.0	48.0	45.0	39.5	40.5	55.0

When Low noise mode is set, the A/C system's capacity is limited. The system could return to normal operation from Low noise mode automatically in the case that the operation condition is severe.

Sound level of PURY-P850YSLM-A1(-BS)

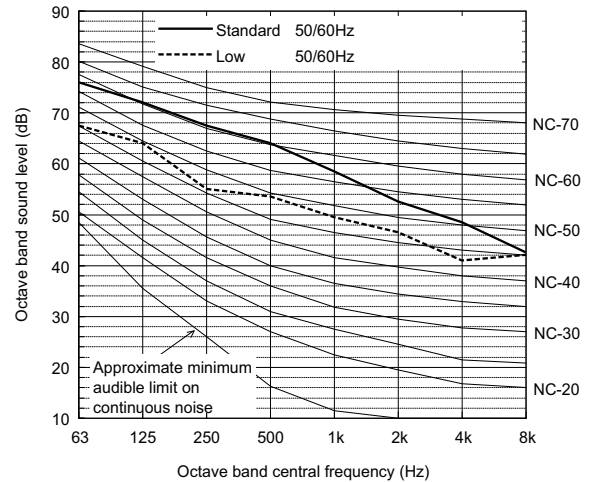

		63	125	250	500	1k	2k	4k	8k	dB(A)
Standard	50/60Hz	76.0	72.0	67.5	64.0	58.5	52.5	48.5	42.5	65.5
Low noise mode	50/60Hz	67.5	64.0	55.0	53.5	49.5	46.5	41.0	42.0	56.0

When Low noise mode is set, the A/C system's capacity is limited. The system could return to normal operation from Low noise mode automatically in the case that the operation condition is severe.

Sound level of PURY-P800YSLM-A1(-BS)

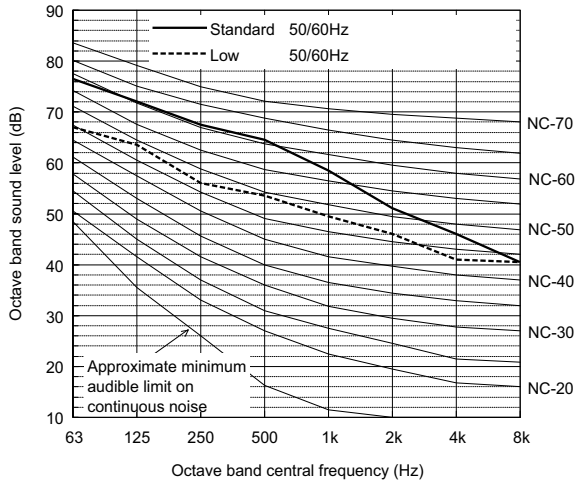

		63	125	250	500	1k	2k	4k	8k	dB(A)
Standard	50/60Hz	76.5	72.0	67.5	64.5	58.5	51.0	46.0	40.5	65.5
Low noise mode	50/60Hz	67.0	63.5	56.0	53.5	49.5	46.0	41.0	40.5	56.0

When Low noise mode is set, the A/C system's capacity is limited. The system could return to normal operation from Low noise mode automatically in the case that the operation condition is severe.

- Depending on the operation conditions, the unit generates noise caused by valve actuation, refrigerant flow, and pressure changes when operating normally. Please consider to avoid location where quietness is required. For BC controller, it is recommended to be installed in places such as ceilings of corridor, rest rooms and plant rooms.

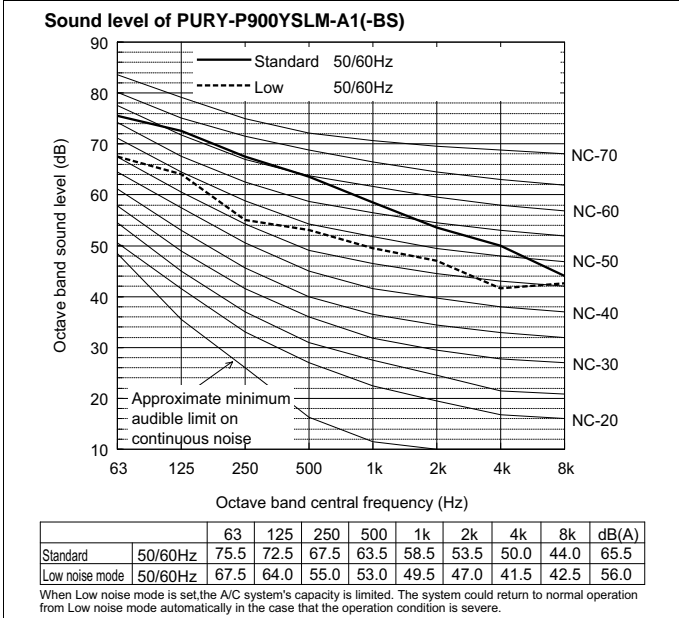
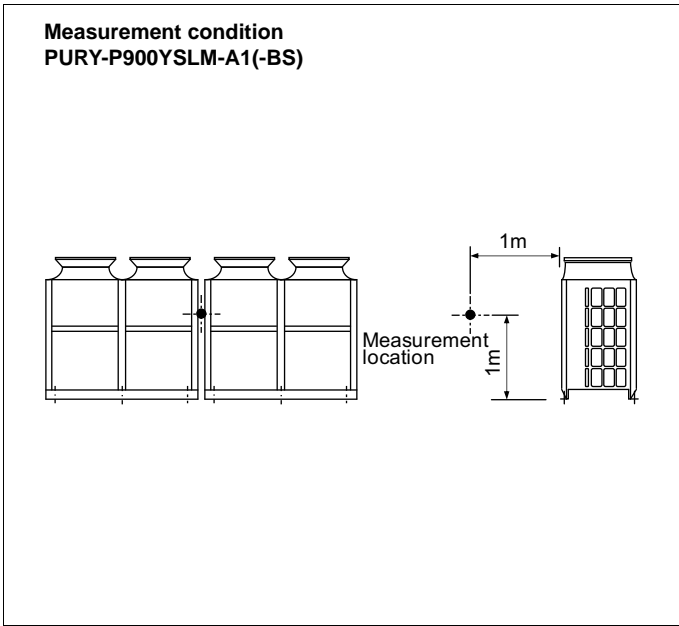

- Depending on the operation conditions, the unit generates noise caused by valve actuation, refrigerant flow, and pressure changes when operating normally. Please consider to avoid location where quietness is required. For BC controller, it is recommended to be installed in places such as ceilings of corridor, rest rooms and plant rooms.

[PURY-P200-500YLM, PURY-P400-900YSLM]

Measurement condition

Measurement frequency: 1 Hz-80 Hz

Measurement point: Ground surface 20 cm away from the unit leg

Installation condition: Direct installation on the concrete floor

Power source: 3-phase 4-wire 380-400-415 V 50/60 Hz

Operation condition: JIS condition (cooling, heating)

Measurement device: Vibration level meter for vibration pollution VM-1220C (JIS-compliant product)

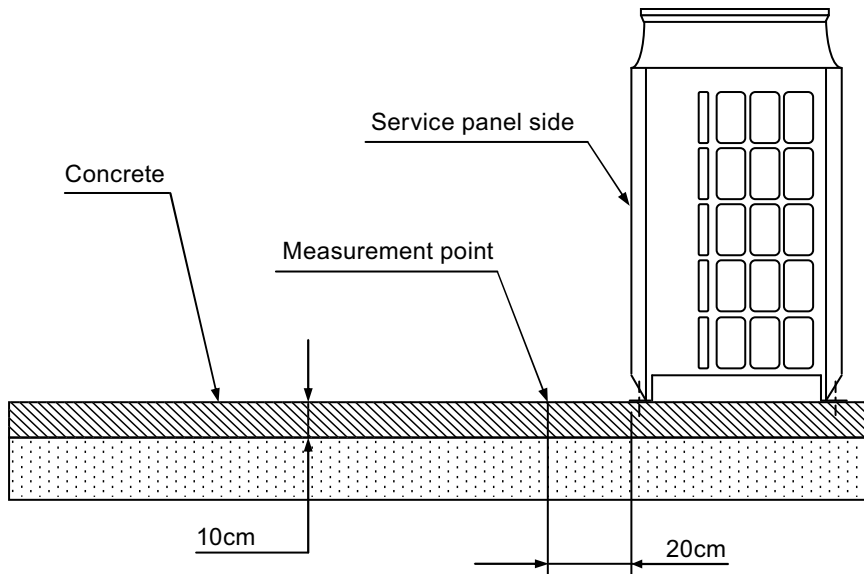

Vibration level

Model	Vibration level (dB)
PURY-P200YLM-A1 (-BS)	45
PURY-P250YLM-A1 (-BS)	46
PURY-P300YLM-A1 (-BS)	47
PURY-P350YLM-A1 (-BS)	47
PURY-P400YLM-A1 (-BS)	47
PURY-P450YLM-A1 (-BS)	47
PURY-P500YLM-A1 (-BS)	48
PURY-P400YSLM-A1 (-BS)	48
PURY-P450YSLM-A1 (-BS)	48.5
PURY-P500YSLM-A1 (-BS)	49
PURY-P550YSLM-A1 (-BS)	49.5
PURY-P600YSLM-A1 (-BS)	50
PURY-P650YSLM-A1 (-BS)	50
PURY-P700YSLM-A1 (-BS)	50
PURY-P750YSLM-A1 (-BS)	50
PURY-P800YSLM-A1 (-BS)	50
PURY-P850YSLM-A1 (-BS)	50
PURY-P900YSLM-A1 (-BS)	50

* Vibration level varies depending on the conditions of actual installation site.

R2

R2

• Cooling only

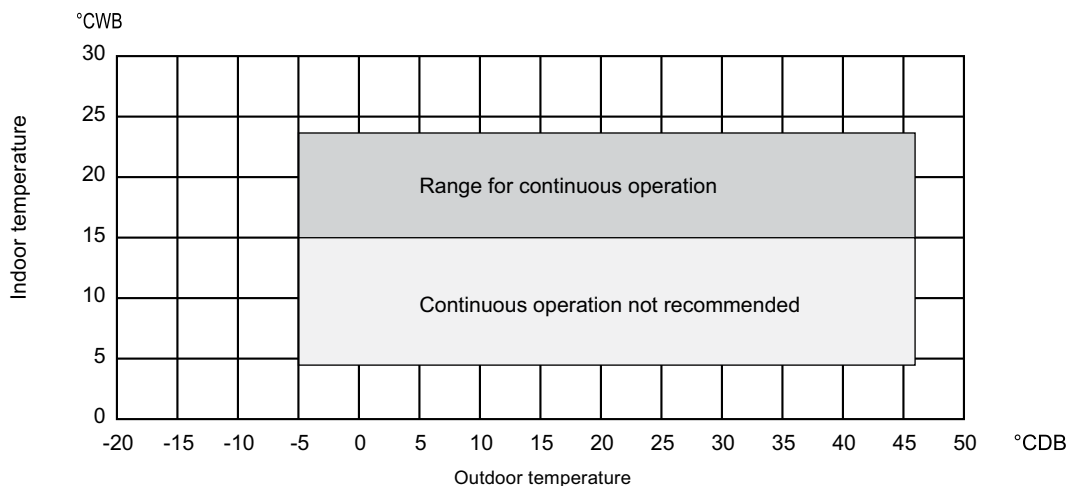

• Heating only

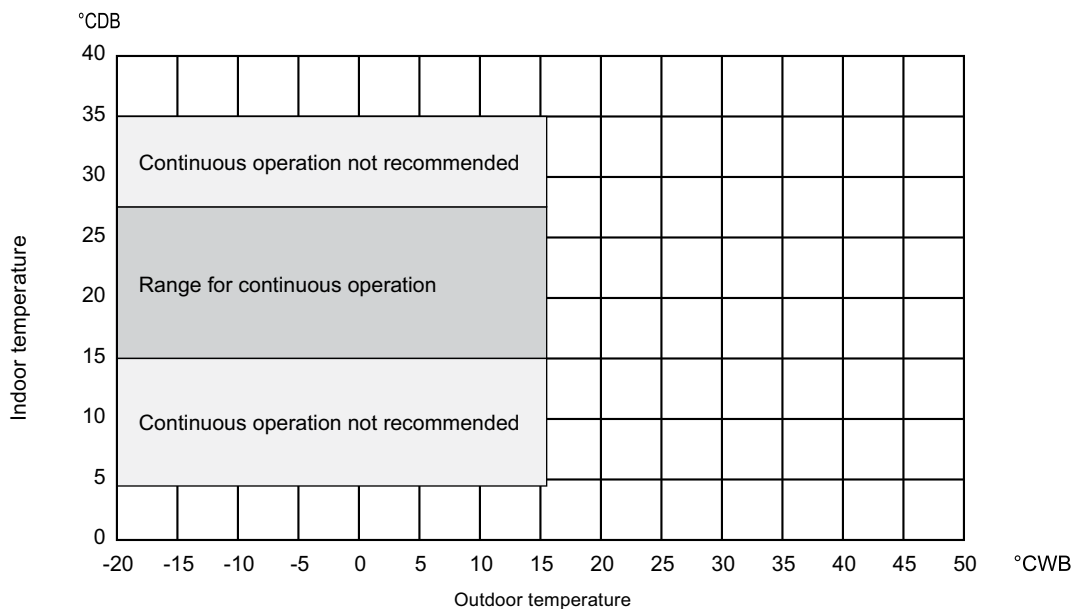

• Combination of cooling/heating operation (Cooling main or Heating main)

Outdoor temperature	Indoor temperature	
	Cooling	Heating
-10 to 21°CDB (14 to 70°FDB)	—	15 to 27°CDB (59 to 81°FDB)
-11 to 15.5°CWB (12.2 to 60°FWB)	15 to 24°CWB (59 to 75°FWB)	—

Section 8-1.

Shows an example of how to select the indoor and outdoor units according to the required heating/cooling load.

Section 8-2. through 8-6.

Show the actual correction data of indoor and outdoor units.

8-1. Selection of Cooling/Heating Units

<Cooling>

Design Condition	
Outdoor Design Dry Bulb Temperature	43 °C
Total Cooling Load	18.0 kW
Room1	
Indoor Design Dry Bulb Temperature	27 °C
Indoor Design Wet Bulb Temperature	20 °C
Cooling Load	8.0 kW
Room2	
Indoor Design Dry Bulb Temperature	24 °C
Indoor Design Wet Bulb Temperature	17 °C
Cooling Load	10.0 kW
<Other>	
Indoor/Outdoor Equivalent Piping Length	50 m

1. Cooling Calculation

(1) Temporary Selection of Indoor Units

Room1	PEFY-P80	9 kW (Rated)
Room2	PEFY-P100	11.2 kW (Rated)

(2) Total Indoor Units Capacity

$P80 + P100 = P180$

(3) Selection of Outdoor Unit

The P200 outdoor unit is selected as total indoor units capacity is P180

PUHY-P200	22.4 kW
-----------	---------

(4) Total Indoor Units Capacity Correction Calculation

Room1	Indoor Design Wet Bulb Temperature Correction (20°C)	1.04 (Refer to Fig.1)
Room2	Indoor Design Wet Bulb Temperature Correction (17°C)	0.95 (Refer to Fig.1)

Total Indoor Units Capacity (CTi)

$$CTi = \sum (\text{Indoor Unit Rating} \times \text{Indoor Design Temperature Correction})$$

$$= 9.0 \times 1.04 + 11.2 \times 0.95$$

$$= 20.0 \text{ kW}$$

(5) Outdoor Unit Correction Calculation

Outdoor Design Dry Bulb Temperature Correction (43°C)	0.94 (Refer to Fig.2)
Piping Length Correction (50 m)	0.94 (Refer to Fig.3)

Total Outdoor Unit Capacity (CTo)

$$CTo = \text{Outdoor Rating} \times \text{Outdoor Design Temperature Correction} \times \text{Piping Length Correction}$$

$$= 22.4 \times 0.94 \times 0.94$$

$$= 19.9 \text{ kW}$$

(6) Determination of Maximum System Capacity

Comparison of Capacity between Total Indoor Units Capacity (CTi) and Total Outdoor Unit Capacity (CTo)

$CTi = 20.0 > CTo = 19.9$, thus, select CTo.

$CTx = CTo = 19.9 \text{ kW}$

(7) Comparison with Essential Load

Against the essential load 18.0kW, the maximum system capacity is 19.9kW: Proper outdoor units have been selected.

(8) Calculation of Maximum Indoor Unit Capacity of Each Room

$CTx = CTo$, thus, calculate by the calculation below

Room1

$$\text{Maximum Capacity} \times \text{Room1 Capacity after the Temperature Correction} / (\text{Room1,2 Total Capacity after the Temperature Correction})$$

$$= 19.9 \times (9.0 \times 1.04) / (9.0 \times 1.04 + 11.2 \times 0.95)$$

$$= 9.3 \text{ kW} \quad \text{OK: fulfills the load 8.0kW}$$

Room2

$$\text{Maximum Capacity} \times \text{Room2 Capacity after the Temperature Correction} / (\text{Room1,2 Total Capacity after the Temperature Correction})$$

$$= 19.9 \times (11.2 \times 0.95) / (9.0 \times 1.04 + 11.2 \times 0.95)$$

$$= 10.6 \text{ kW} \quad \text{OK: fulfills the load 10.0kW}$$

Go on to the heating trial calculation since the selected units fulfill the cooling loads of Room 1, 2.

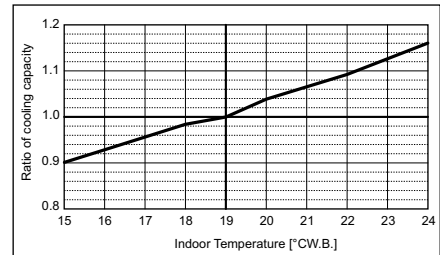

Fig.1 Indoor unit temperature correction
To be used to correct indoor unit only

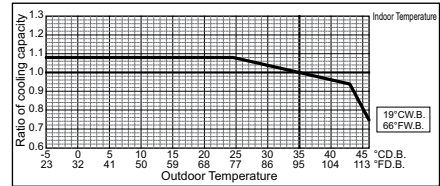

Fig.2 Outdoor unit temperature correction
To be used to correct outdoor unit only

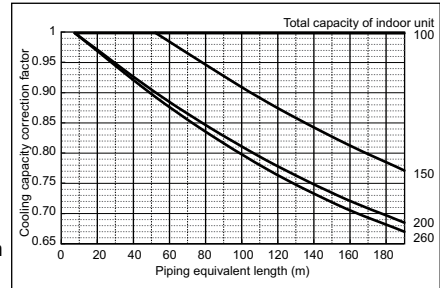

Fig.3 Correction of refrigerant piping length

<Heating>

Design Condition	
Outdoor Design Wet Bulb Temperature	-3 °C
Total Heating Load	20.5 kW
Room1	
Indoor Design Dry Bulb Temperature	21 °C
Heating Load	9.5 kW
Room2	
Indoor Design Dry Bulb Temperature	23 °C
Heating Load	11.0 kW
<Other>	
Indoor/Outdoor Equivalent Piping Length	50 m

2. Heating Calculation

(1) Temporary Selection of Indoor Units

Room1	PEFY-P80	10 kW (Rated)
Room2	PEFY-P100	12.5 kW (Rated)

(2) Total Indoor Units Capacity

P80 + P100 = P180

(3) Selection of Outdoor Unit

The P200 outdoor unit is selected as total indoor units capacity is P180

PUHY-P200	25.0 kW
-----------	---------

(4) Total Indoor Units Capacity Correction Calculation

Room1	Indoor Design Dry Bulb Temperature Correction (21°C)	0.97 (Refer to Fig.4)
Room2	Indoor Design Dry Bulb Temperature Correction (23°C)	0.90 (Refer to Fig.4)

Total Indoor Units Capacity (CTi)

$$CTi = \sum (\text{Indoor Unit Rating} \times \text{Indoor Design Temperature Correction})$$

$$= 10.0 \times 0.97 + 12.5 \times 0.90$$

$$= 21.0 \text{ kW}$$

(5) Outdoor Unit Correction Calculation

Outdoor Design Wet Bulb Temperature Correction (-3°C)	0.98 (Refer to Fig.5)
Piping Length Correction (50 m)	0.97 (Refer to Fig.6)
Defrost Correction	0.89 (Refer to Tbl.1)

Total Outdoor Unit Capacity (CTo)

$$CTo = \text{Outdoor Unit Rating} \times \text{Outdoor Design Temperature Correction} \times \text{Piping Length Correction} \times \text{Defrost Correction}$$

$$= 25.0 \times 0.98 \times 0.97 \times 0.89$$

$$= 21.1 \text{ kW}$$

(6) Determination of Maximum System Capacity

Comparison of Capacity between Total Indoor Units Capacity (CTi) and Total Outdoor Unit Capacity (CTo)

CTi = 21.0 < CTo = 21.1, thus, select CTi.

CTx = CTi = 21.0 kW

(7) Comparison with Essential Load

Against the essential load 20.5kW, the maximum system capacity is 21.0kW: Proper outdoor units have been selected.

(8) Calculation of Maximum Indoor Unit Capacity of Each Room

CTx = CTi, thus, calculate by the calculation below

Room1	Indoor Unit Rating × Indoor Design Temperature Correction	
	= 10.0 × 0.97	
	= 9.7 kW	OK: fulfills the load 9.5kW

Room2	Indoor Unit Rating × Indoor Design Temperature Correction	
	= 12.5 × 0.90	
	= 11.3 kW	OK: fulfills the load 11.0kW

Completed selecting units since the selected units fulfill the heating loads of Room 1, 2.

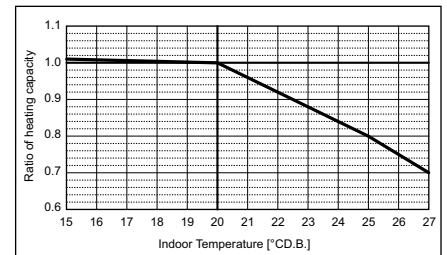

Fig.4 Indoor unit temperature correction
To be used to correct indoor unit only

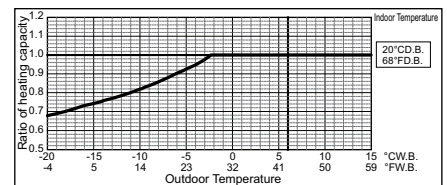

Fig.5 Outdoor unit temperature correction
To be used to correct outdoor unit only

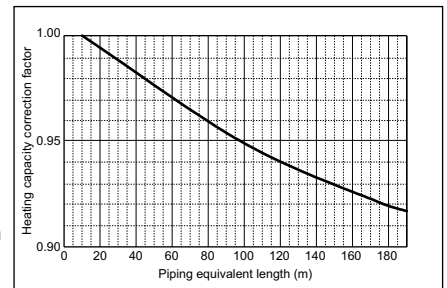

Fig.6 Correction of refrigerant piping length

Tbl.1 Table of correction factor at frost and defrost

Outdoor inlet air temp. °C	6	4	2	1	0	-2	-4	-6	-8	-10	-20
Outdoor inlet air temp. °F	43	39	36	34	32	28	25	21	18	14	-4
PUHY-P200	1.00	0.95	0.84	0.825	0.83	0.87	0.90	0.95	0.95	0.95	0.95
PUHY-P250	1.00	0.95	0.84	0.825	0.83	0.87	0.90	0.95	0.95	0.95	0.95
PUHY-P300	1.00	0.93	0.82	0.80	0.82	0.86	0.90	0.90	0.95	0.95	0.95
PUHY-P350	1.00	0.93	0.85	0.83	0.84	0.86	0.90	0.90	0.95	0.95	0.95
PUHY-P400	1.00	0.93	0.85	0.83	0.84	0.86	0.90	0.90	0.95	0.95	0.95

8-2. Correction by temperature

PURY-		P200YLM-A1	P250YLM-A1
Nominal Cooling Capacity	kW	22.4	28.0
	BTU/h	76,400	95,500
Input	kW	5.29	6.98

Indoor unit temperature correction
To be used to correct indoor unit capacity only

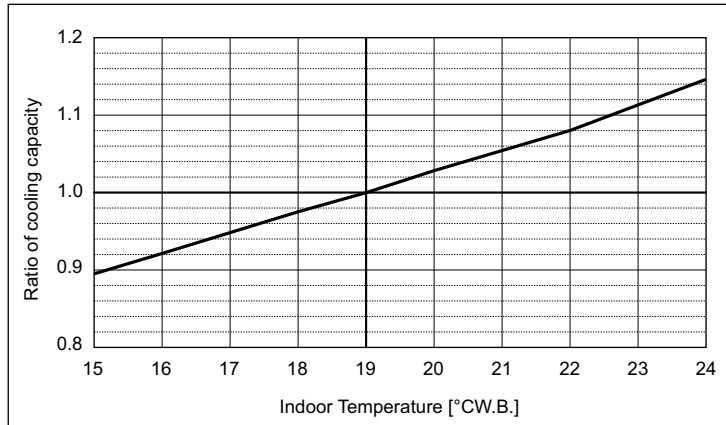

Outdoor unit temperature correction
To be used to correct outdoor unit only

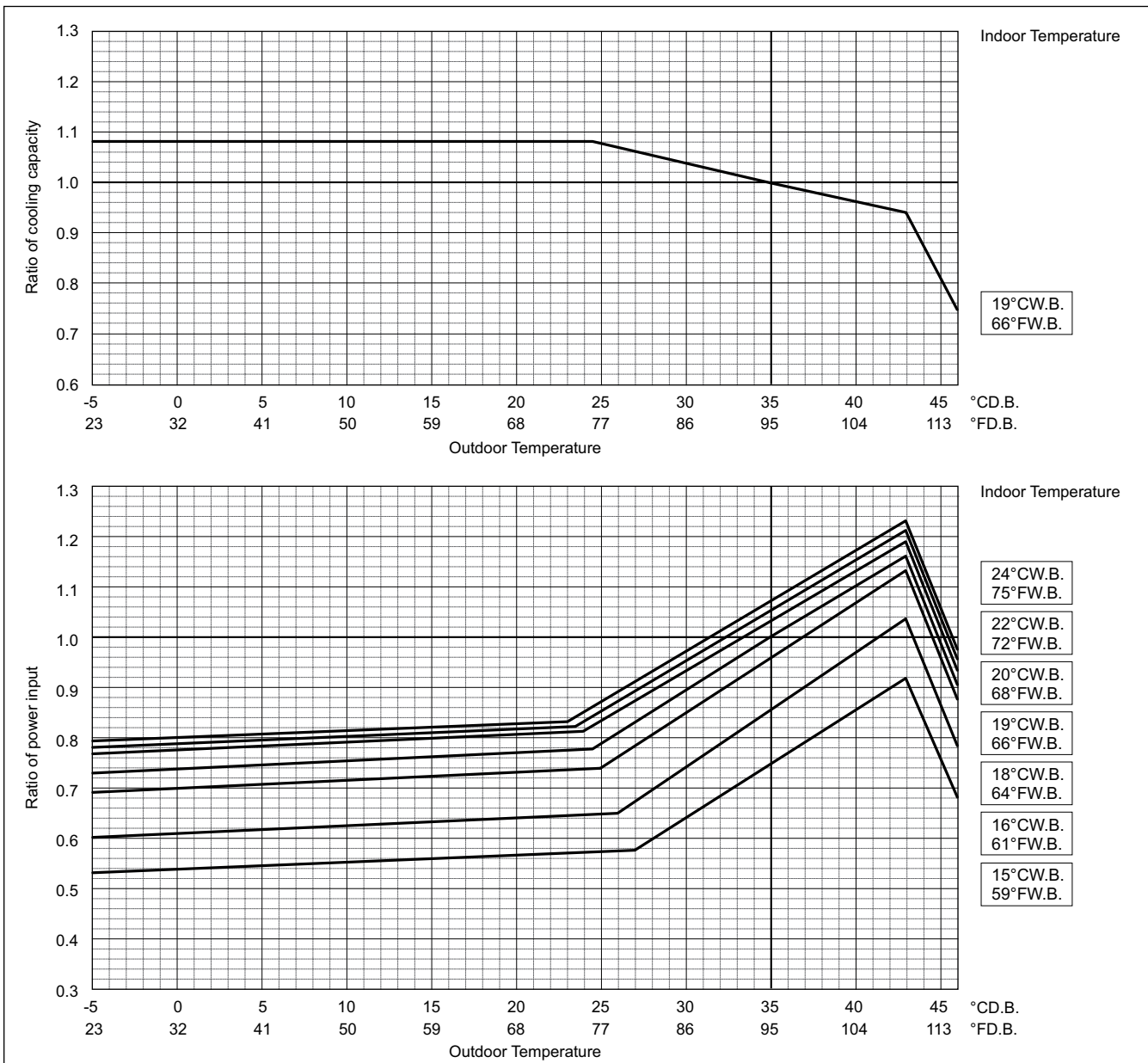

Outdoor unit power input is affected by the indoor and outdoor temperatures as shown in the graph above. Please consult the sales office for details.

	PURY-	P200YLM-A1	P250YLM-A1
Nominal Heating Capacity	kW	25.0	31.5
	BTU/h	85,300	107,500
Input	kW	5.49	7.32

Indoor unit temperature correction

To be used to correct indoor unit capacity only

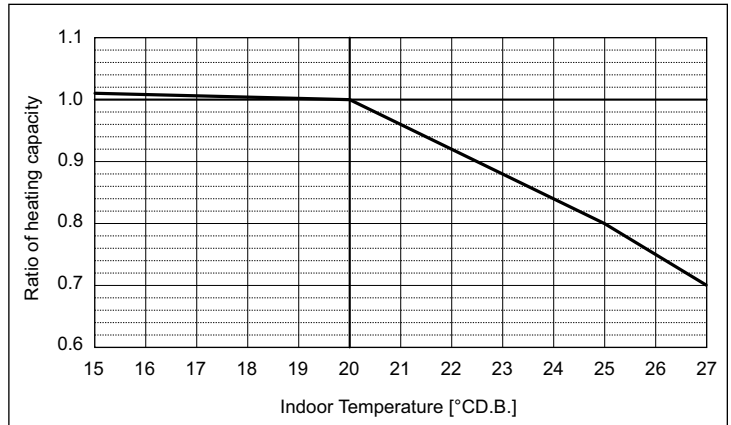

Outdoor unit temperature correction

To be used to correct outdoor unit only

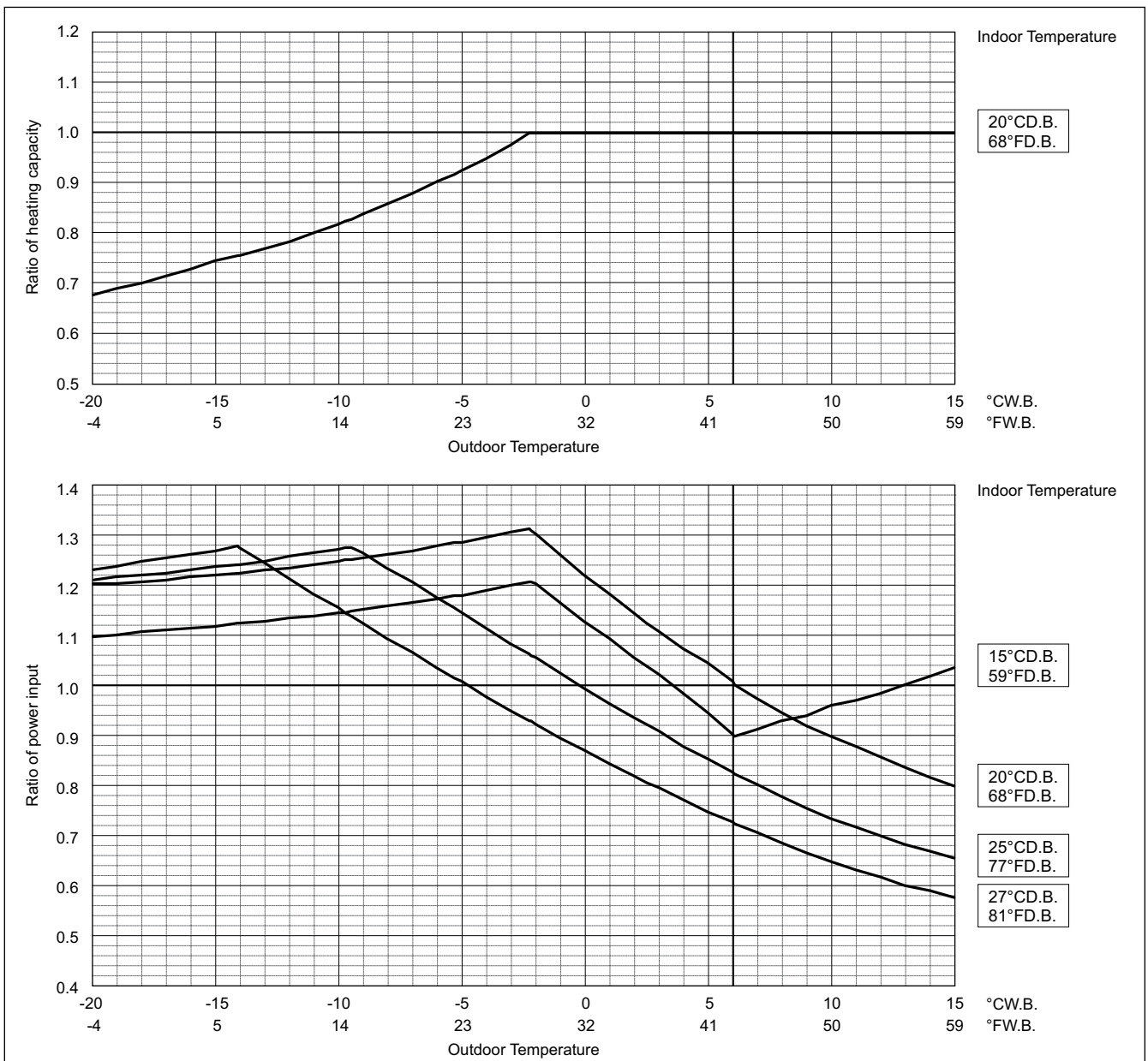

Outdoor unit power input is affected by the indoor and outdoor temperatures as shown in the graph above. Please consult the sales office for details.

R2

PURY-		P300YLM-A1	P350YLM-A1	P400YLM-A1
Nominal Cooling Capacity	kW	33.5	40.0	45.0
	BTU/h	114,300	136,500	153,500
Input	kW	9.10	11.76	13.71

PURY-		P400YSLM-A1
Nominal Cooling Capacity	kW	45.0
	BTU/h	153,500
Input	kW	10.97

Indoor unit temperature correction

To be used to correct indoor unit capacity only

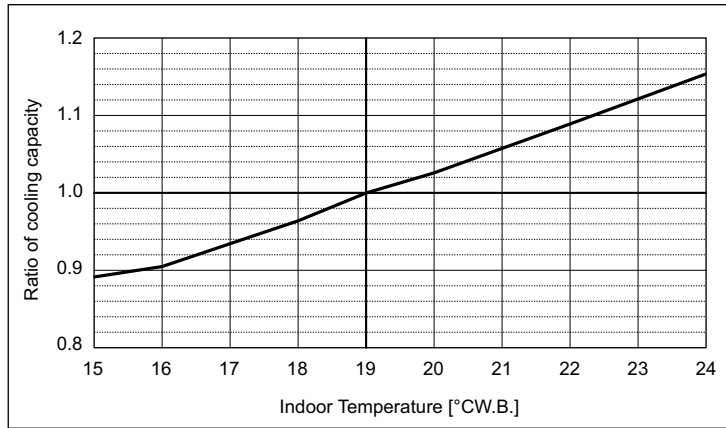

Outdoor unit temperature correction

To be used to correct outdoor unit only

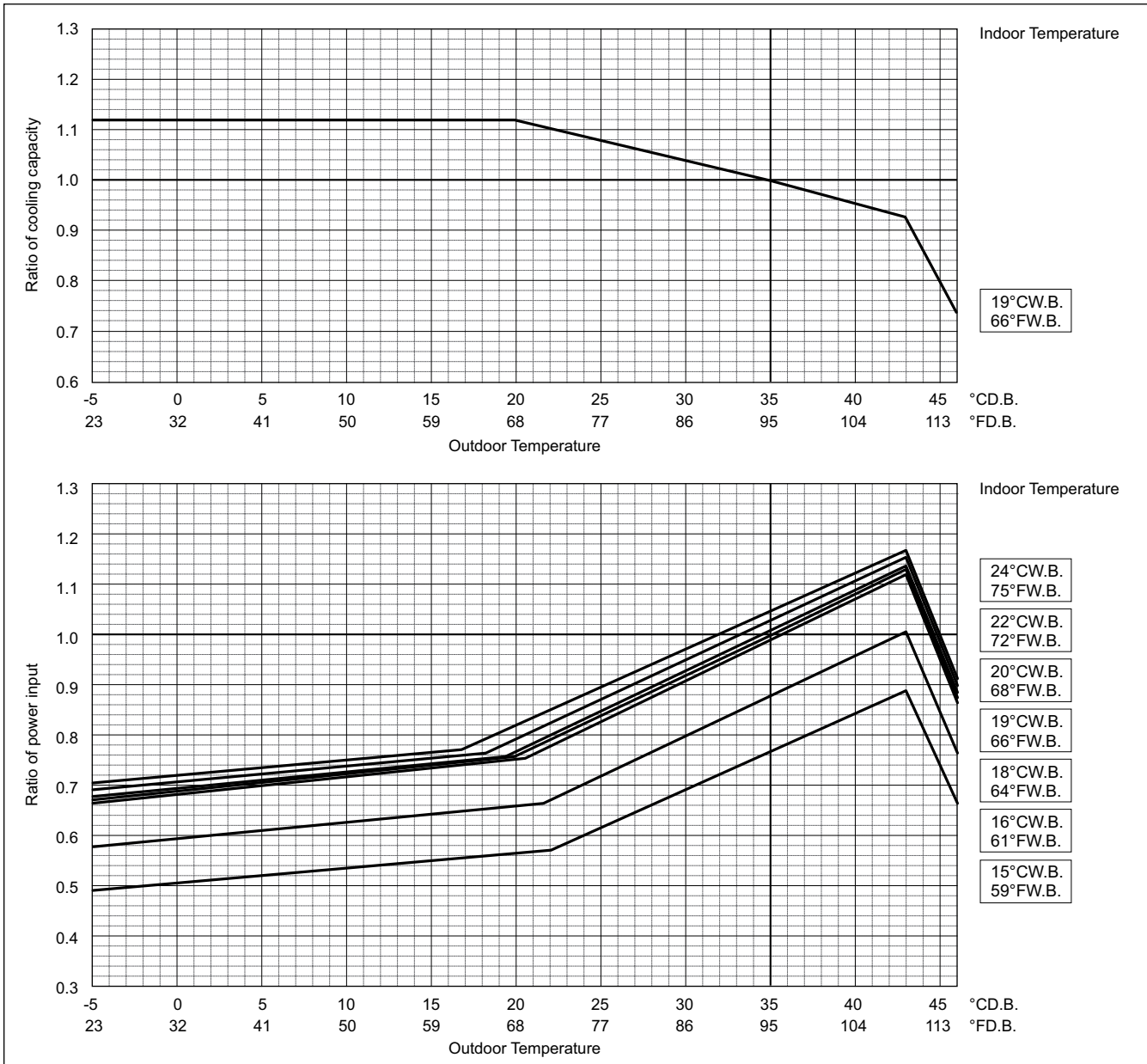

Outdoor unit power input is affected by the indoor and outdoor temperatures as shown in the graph above. Please consult the sales office for details.

PURY-		P300YLM-A1	P350YLM-A1	P400YLM-A1
Nominal Heating Capacity	kW	37.5	45.0	45.0
	BTU/h	128,000	153,500	153,500
Input	kW	9.37	11.59	11.42

PURY-		P400YSLM-A1
Nominal Heating Capacity	kW	50.0
	BTU/h	170,600
Input	kW	10.98

Indoor unit temperature correction
To be used to correct indoor unit capacity only

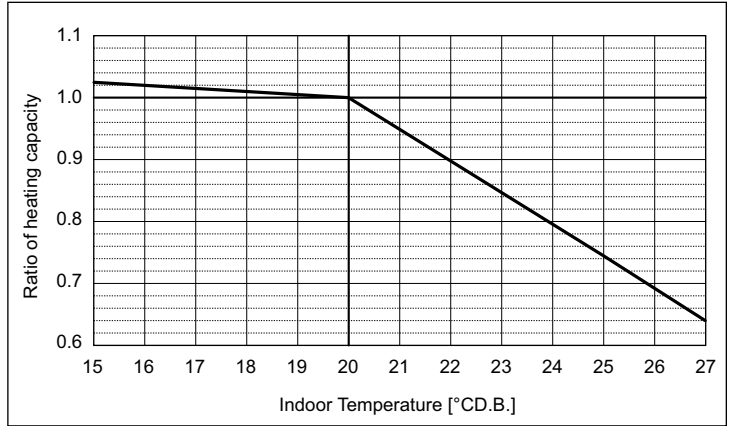

Outdoor unit temperature correction
To be used to correct outdoor unit only

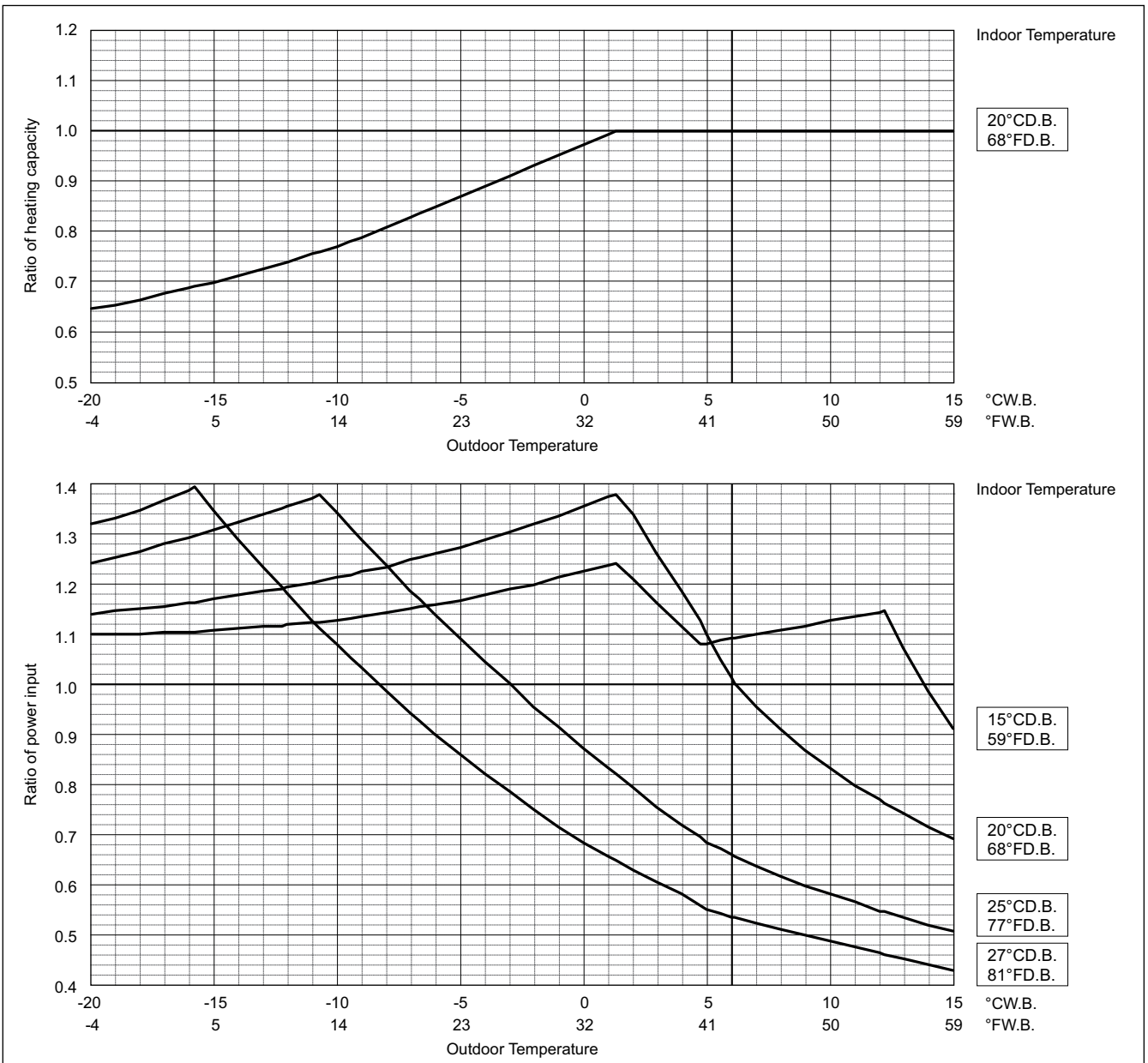

Outdoor unit power input is affected by the indoor and outdoor temperatures as shown in the graph above. Please consult the sales office for details.

R2

8. CAPACITY TABLES

R2

PURY-		P450YLM-A1	P500YLM-A1	P450YSLM-A1
Nominal Cooling Capacity	kW	50.0	56.0	50.0
	BTU/h	170,600	191,100	170,600
Input	kW	14.32	17.77	12.50

PURY-		P500YSLM-A1	P550YSLM-A1	P600YSLM-A1
Nominal Cooling Capacity	kW	56.0	63.0	69.0
	BTU/h	191,100	215,000	235,400
Input	kW	14.39	16.89	19.32

PURY-		P650YSLM-A1
Nominal Cooling Capacity	kW	73.0
	BTU/h	249,100
Input	kW	21.28

Indoor unit temperature correction

To be used to correct indoor unit capacity only

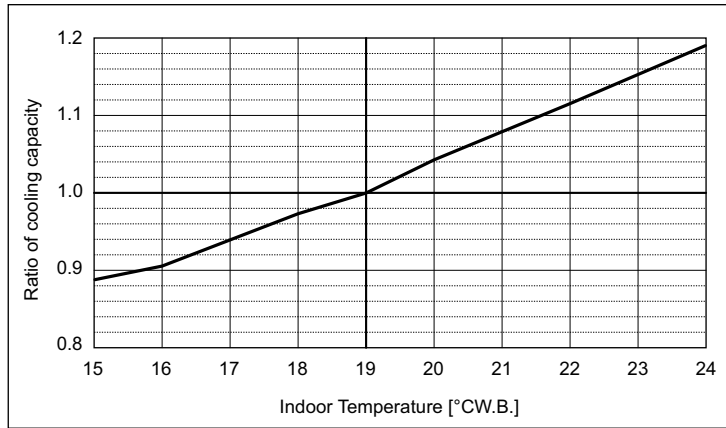

Outdoor unit temperature correction

To be used to correct outdoor unit only

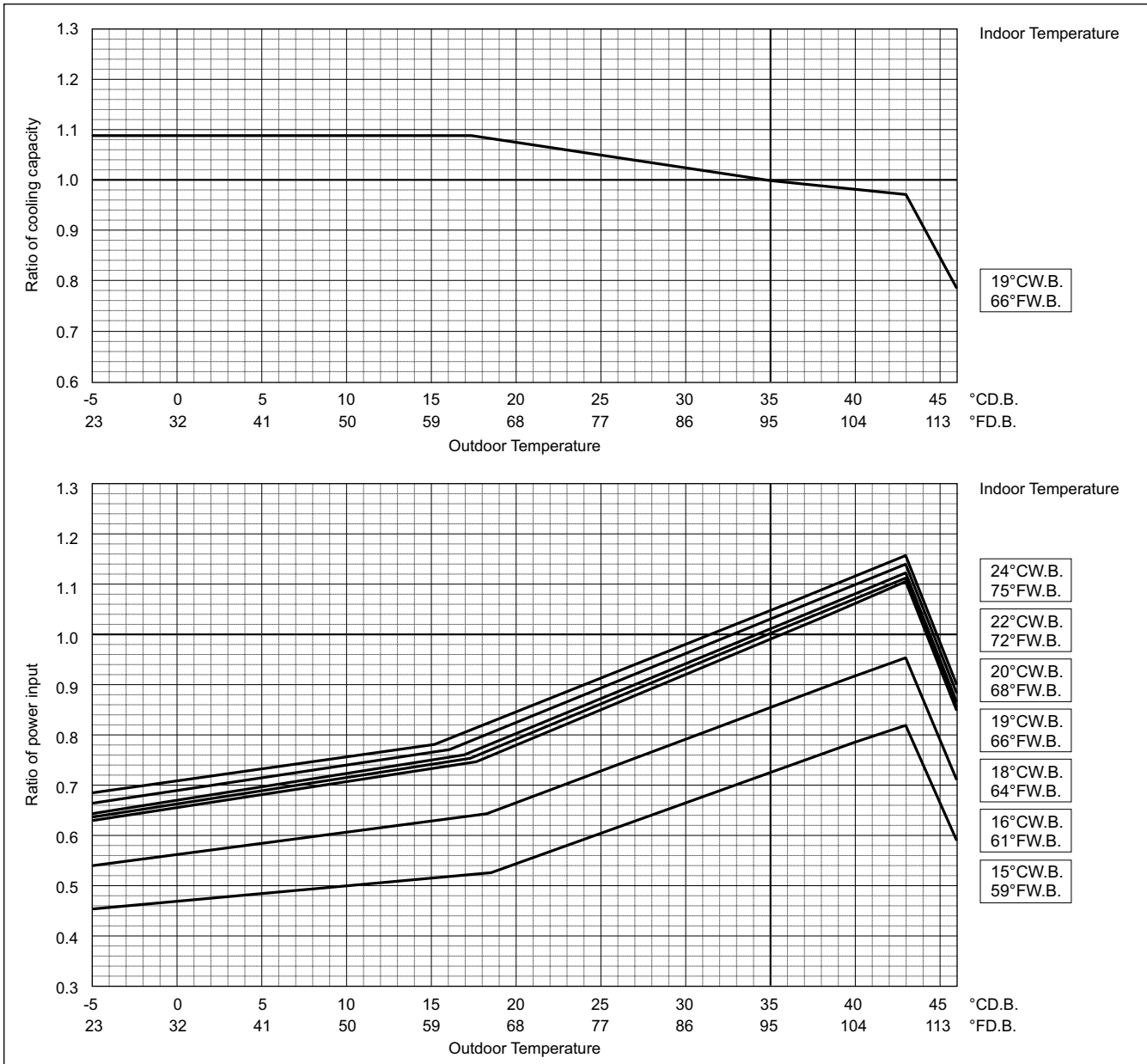

Outdoor unit power input is affected by the indoor and outdoor temperatures as shown in the graph above. Please consult the sales office for details.

8. CAPACITY TABLES

PURY-		P450YLM-A1	P500YLM-A1	P450YSLM-A1
Nominal Heating Capacity	kW	56.0	58.0	56.0
	BTU/h	191,100	197,900	191,100
Input	kW	14.93	16.06	12.64

PURY-		P500YSLM-A1	P550YSLM-A1	P600YSLM-A1
Nominal Heating Capacity	kW	63.0	69.0	76.5
	BTU/h	215,000	235,400	261,000
Input	kW	14.65	16.62	19.12

PURY-		P650YSLM-A1
Nominal Heating Capacity	kW	81.5
	BTU/h	278,100
Input	kW	20.68

Indoor unit temperature correction
To be used to correct indoor unit capacity only

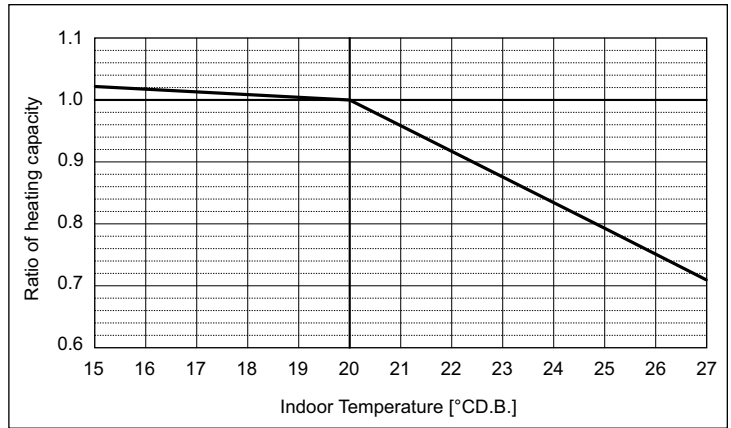

Outdoor unit temperature correction
To be used to correct outdoor unit only

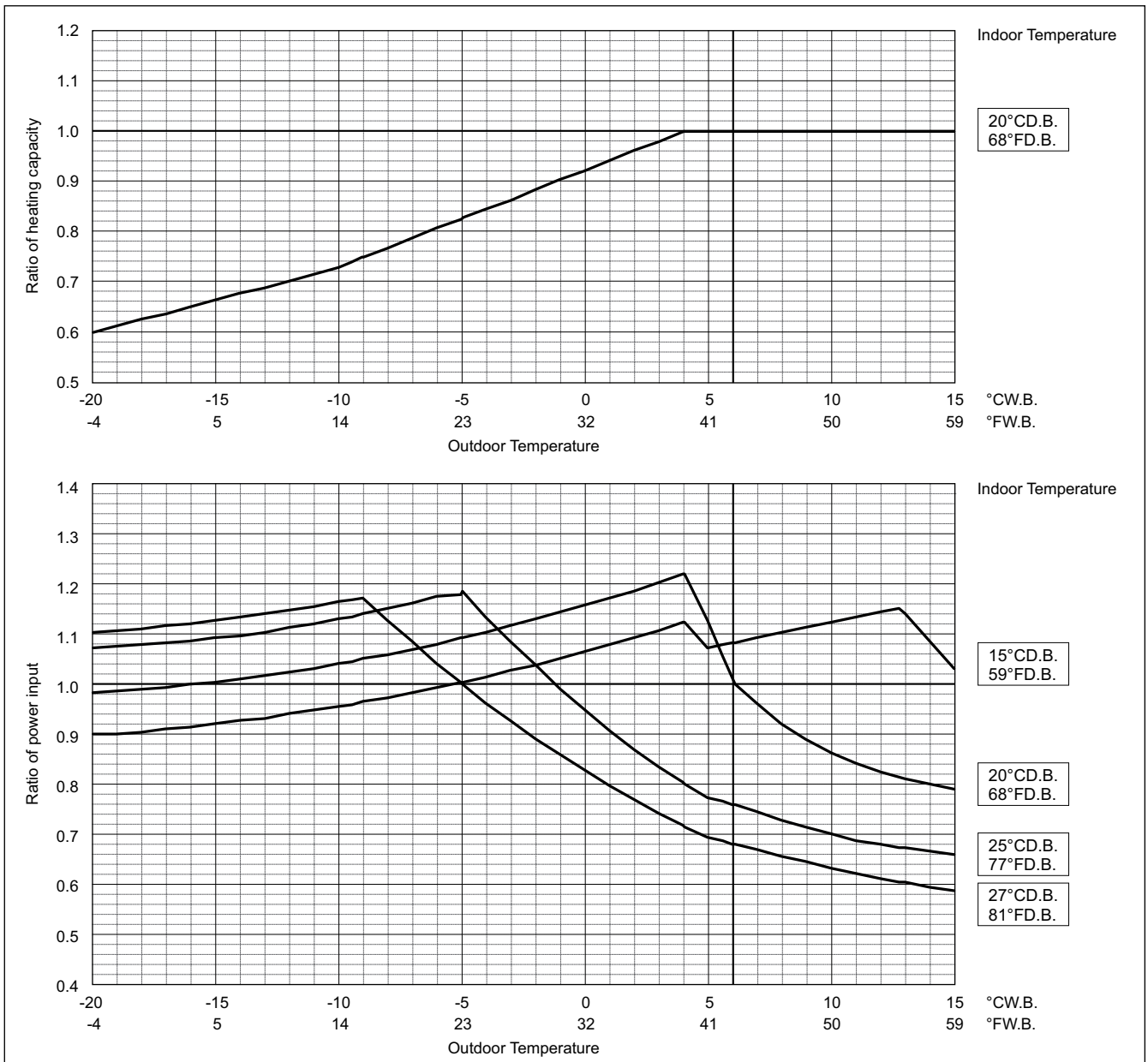

Outdoor unit power input is affected by the indoor and outdoor temperatures as shown in the graph above. Please consult the sales office for details.

PURY-		P700YSLM-A1	P750YSLM-A1	P800YSLM-A1
Nominal Cooling Capacity	kW	80.0	85.0	90.0
	BTU/h	273,000	290,000	307,100
Input	kW	24.24	26.23	28.30

Indoor unit temperature correction

To be used to correct indoor unit capacity only

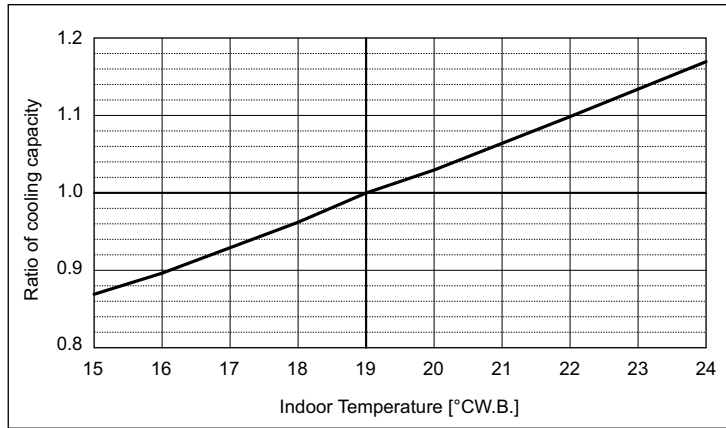

Outdoor unit temperature correction

To be used to correct outdoor unit only

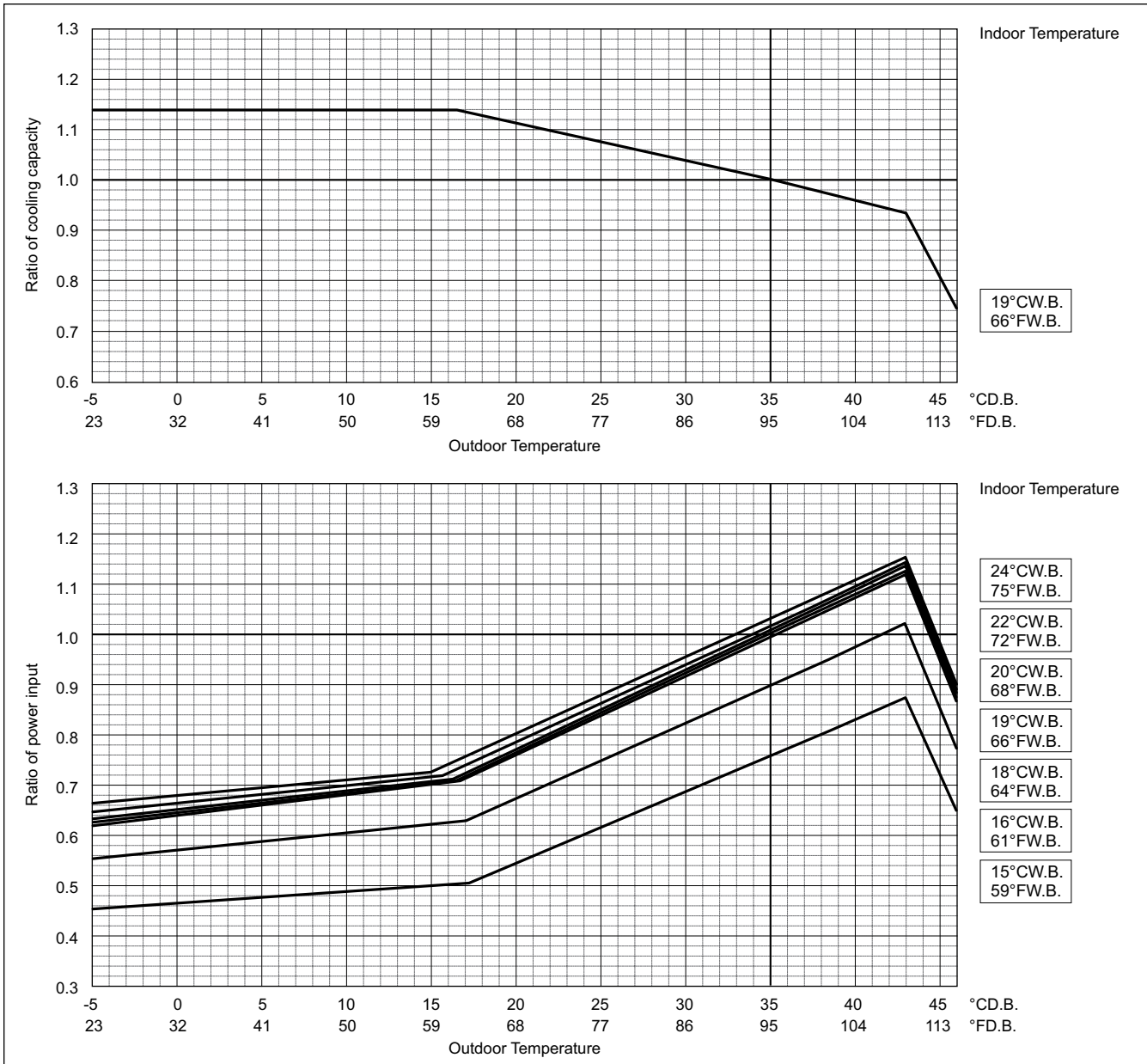

Outdoor unit power input is affected by the indoor and outdoor temperatures as shown in the graph above. Please consult the sales office for details.

PURY-		P700YSLM-A1	P750YSLM-A1	P800YSLM-A1
Nominal Heating Capacity	kW	88.0	90.0	90.0
	BTU/h	300,300	307,100	307,100
Input	kW	22.68	23.01	22.84

Indoor unit temperature correction

To be used to correct indoor unit capacity only

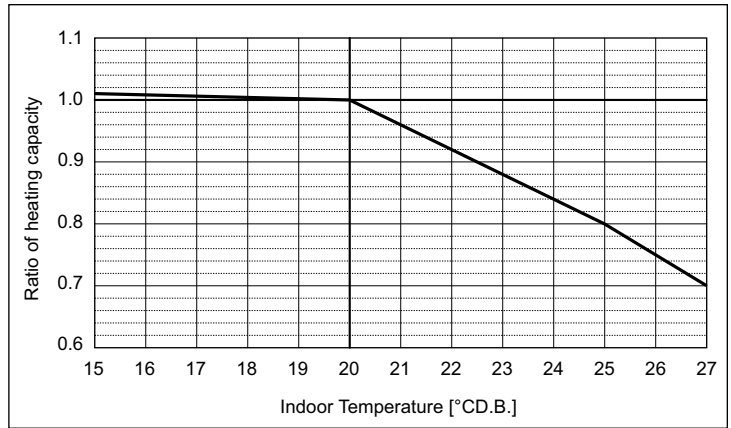

Outdoor unit temperature correction

To be used to correct outdoor unit only

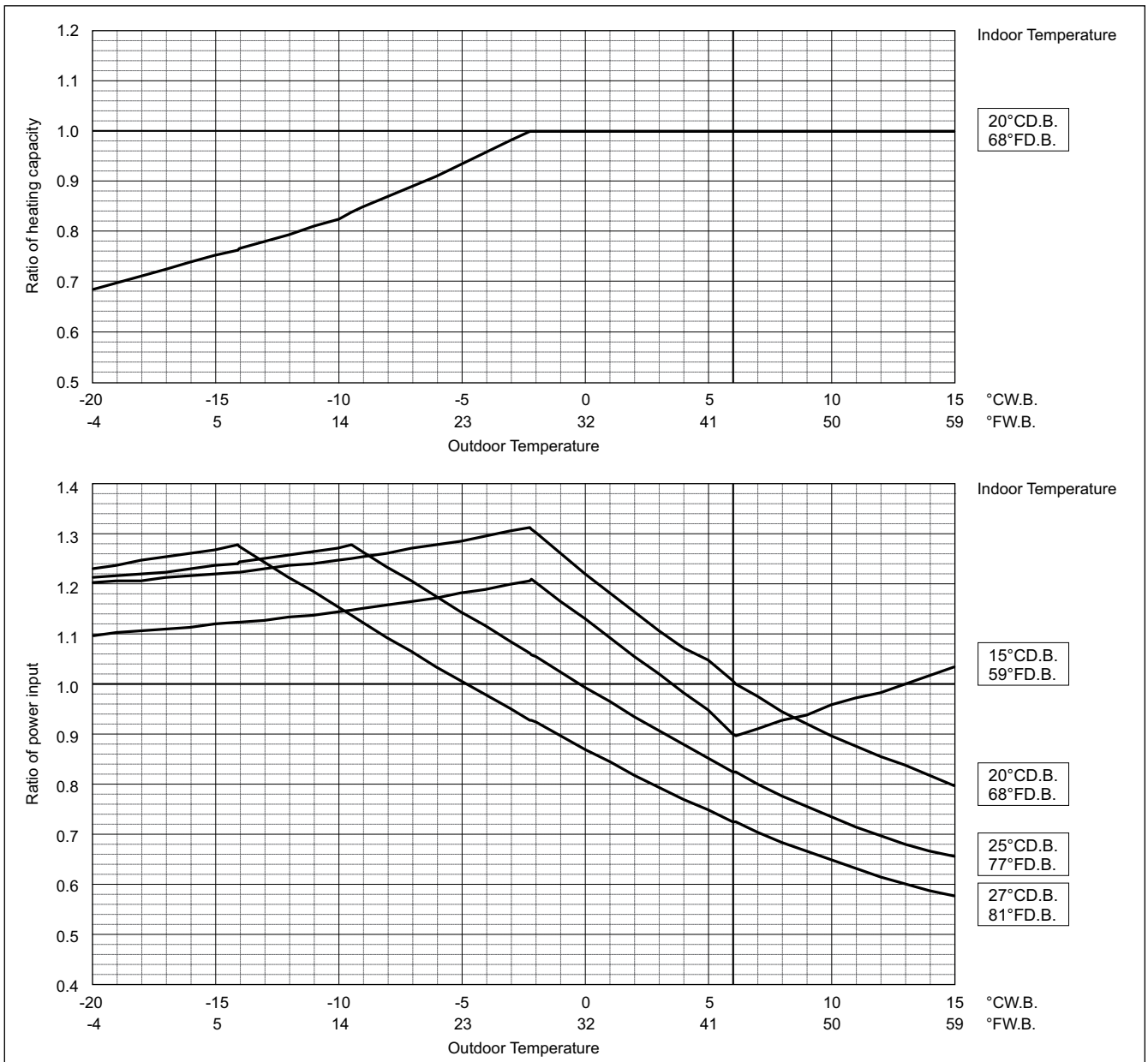

Outdoor unit power input is affected by the indoor and outdoor temperatures as shown in the graph above. Please consult the sales office for details.

R2

PURY-		P850YSLM-A1	P900YSLM-A1
Nominal Cooling Capacity	kW	96.0	101.0
	BTU/h	327,600	344,600
Input	kW	29.26	29.79

Indoor unit temperature correction

To be used to correct indoor unit capacity only

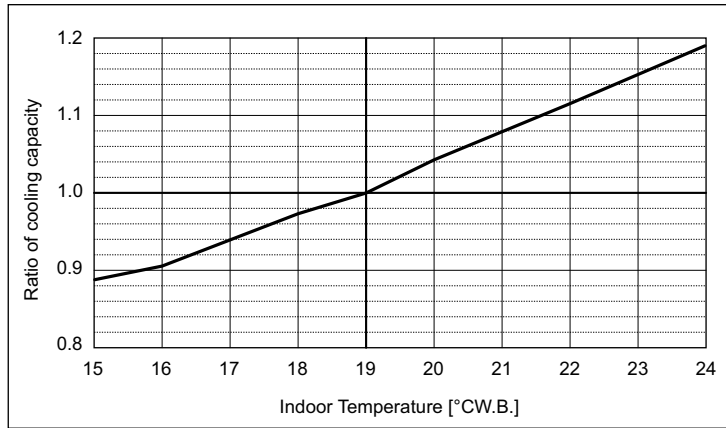

Outdoor unit temperature correction

To be used to correct outdoor unit only

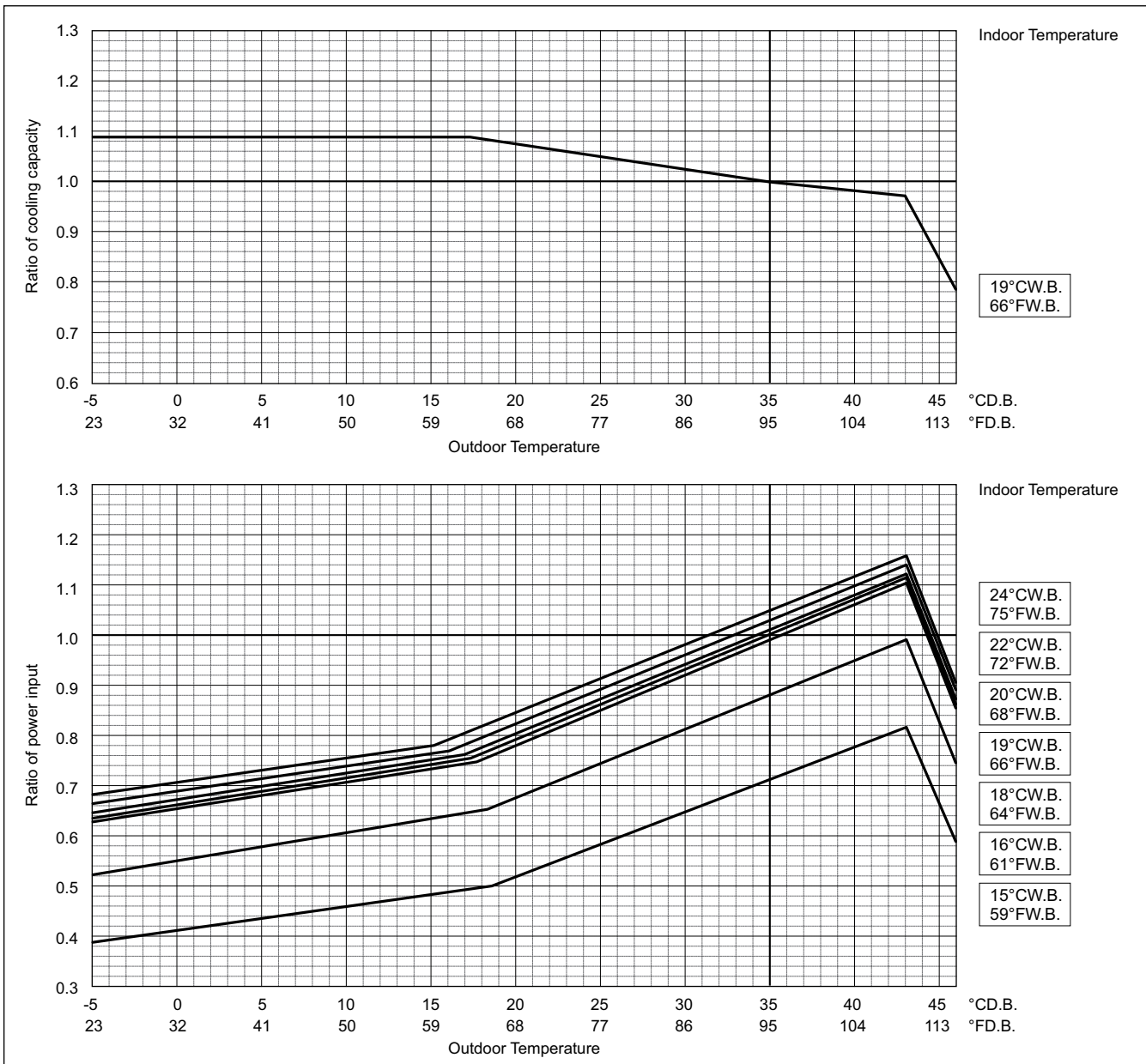

Outdoor unit power input is affected by the indoor and outdoor temperatures as shown in the graph above. Please consult the sales office for details.

PURY-	P850YSLM-A1	P900YSLM-A1
Nominal Heating Capacity	kW 101.0	113.0
	BTU/h 344,600	385,600
Input	kW 26.23	30.13

Indoor unit temperature correction

To be used to correct indoor unit capacity only

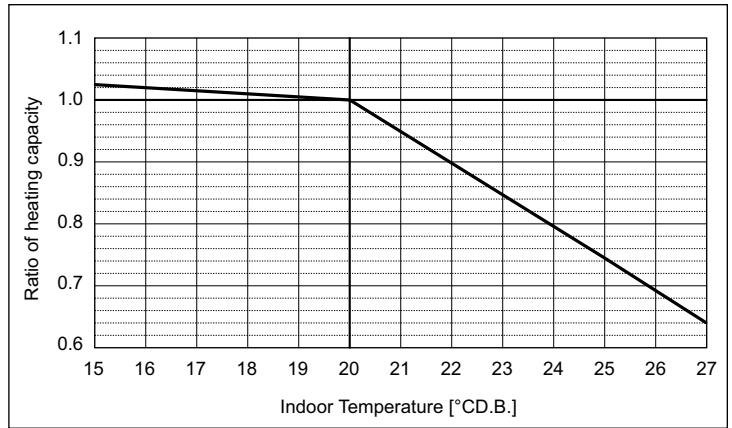

Outdoor unit temperature correction

To be used to correct outdoor unit only

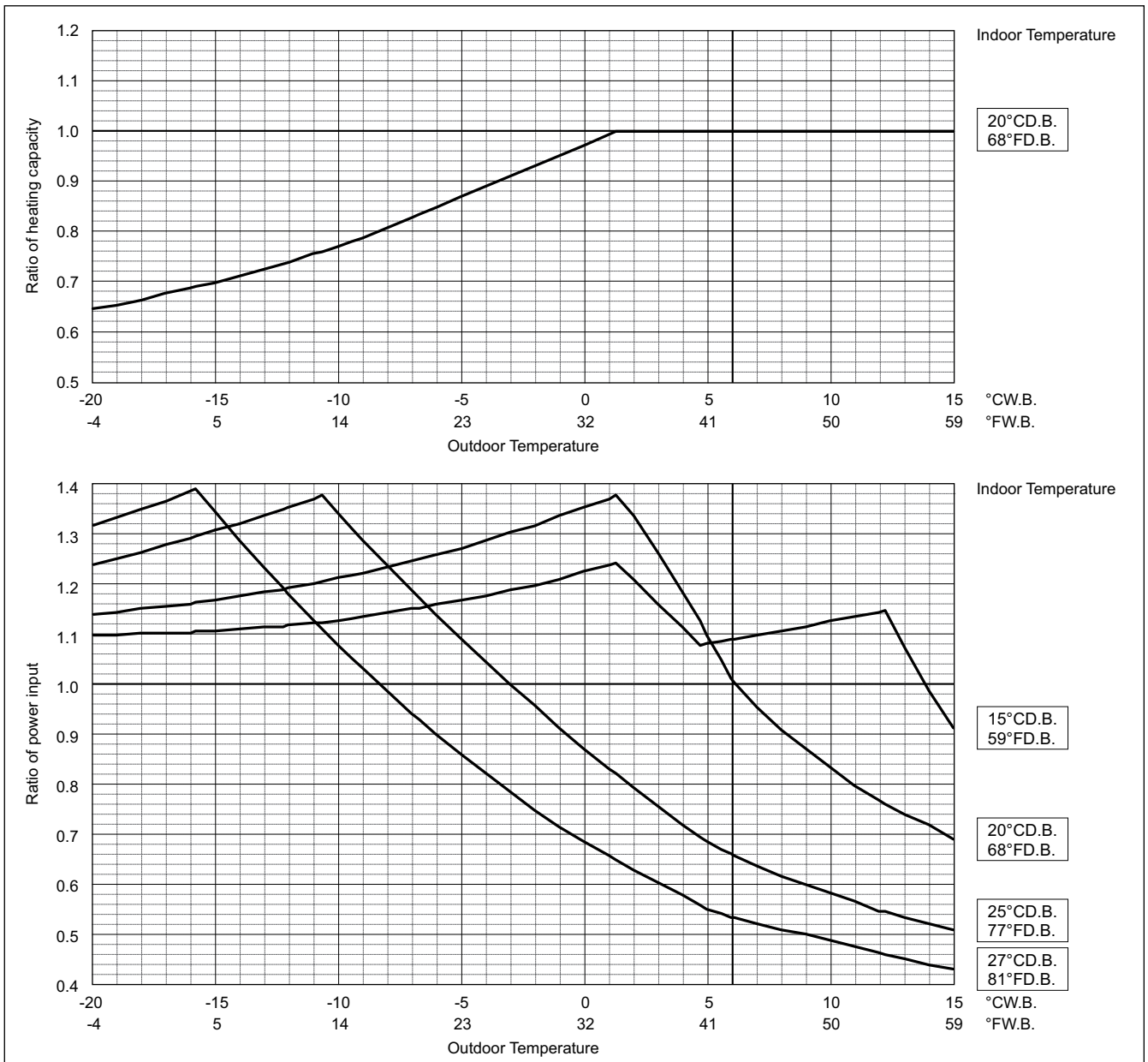

Outdoor unit power input is affected by the indoor and outdoor temperatures as shown in the graph above. Please consult the sales office for details.

R2

Correction by temperature (COP Priority Mode)

CITY MULTI could have various capacities at different designing temperatures. Using the nominal cooling/heating capacity values and the ratios below, the capacity can be found for various temperatures. To select COP priority mode, DipSW 6-2 must be set to ON.

PURY-	P200YLM-A1	P250YLM-A1
Nominal Cooling Capacity	22.4	28.0
Input	5.29	6.98

Indoor unit temperature correction

To be used to correct indoor unit capacity only

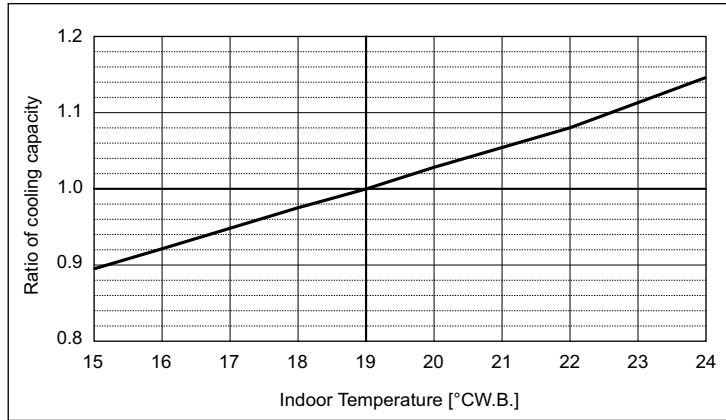

Outdoor unit temperature correction

To be used to correct outdoor unit only

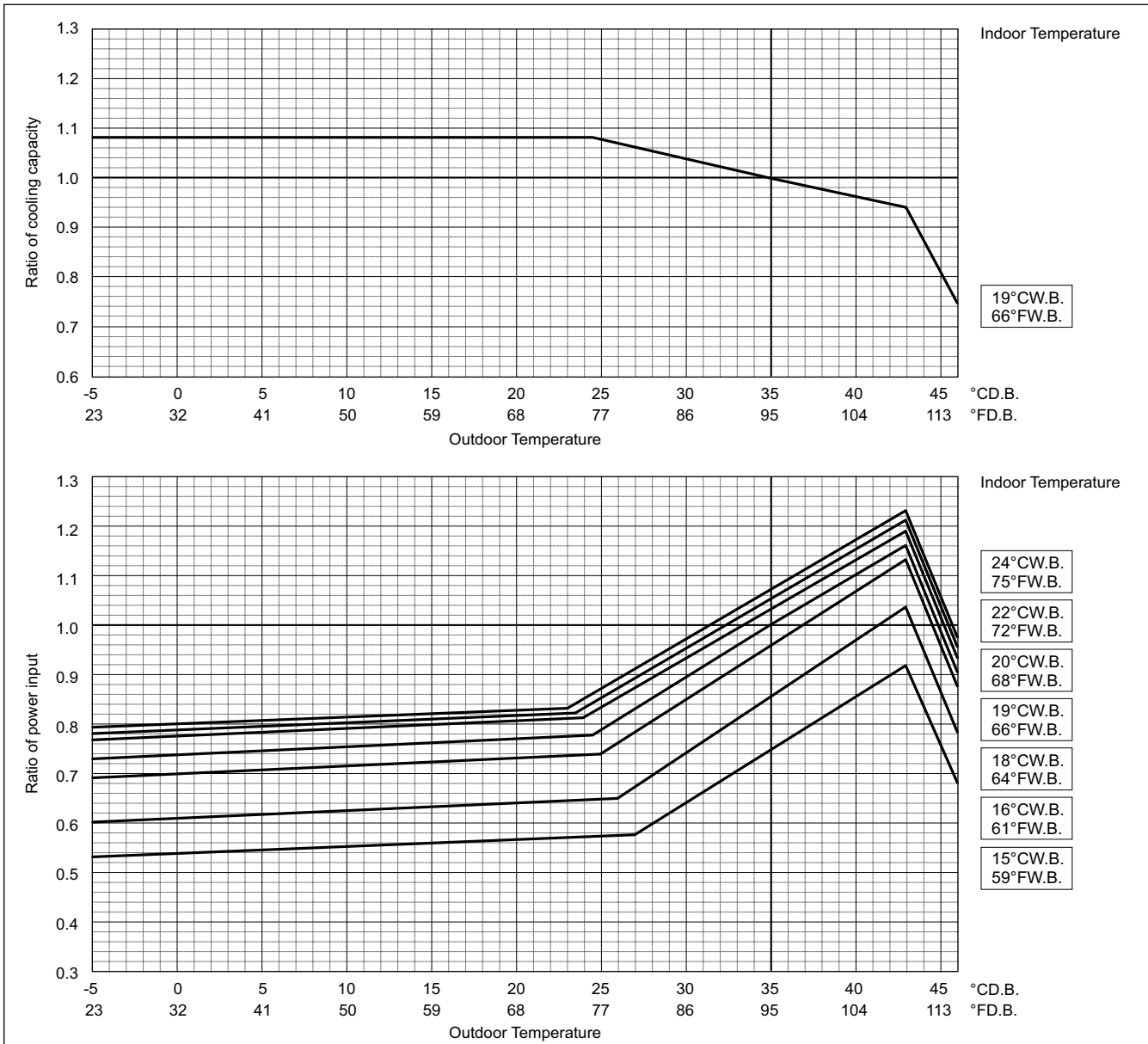

Outdoor unit power input is affected by the indoor and outdoor temperatures as shown in the graph above. Please consult the sales office for details.

	PURY-	P200YLM-A1	P250YLM-A1
Nominal Heating Capacity	kW	25.0	31.5
	BTU/h	85,300	107,500
Input	kW	5.49	7.32

Indoor unit temperature correction

To be used to correct indoor unit capacity only

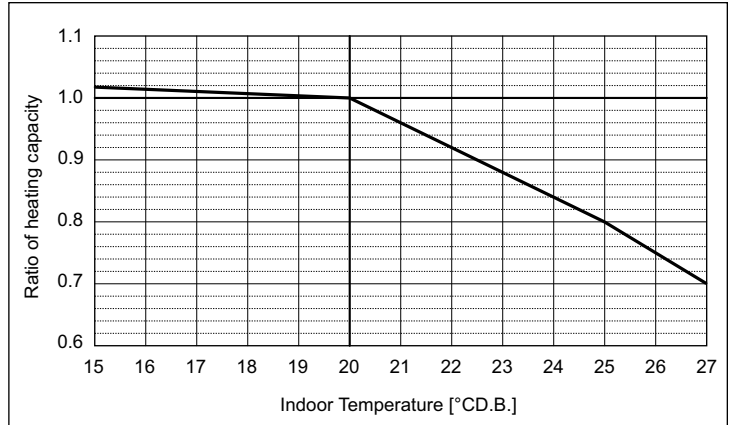

Outdoor unit temperature correction

To be used to correct outdoor unit only

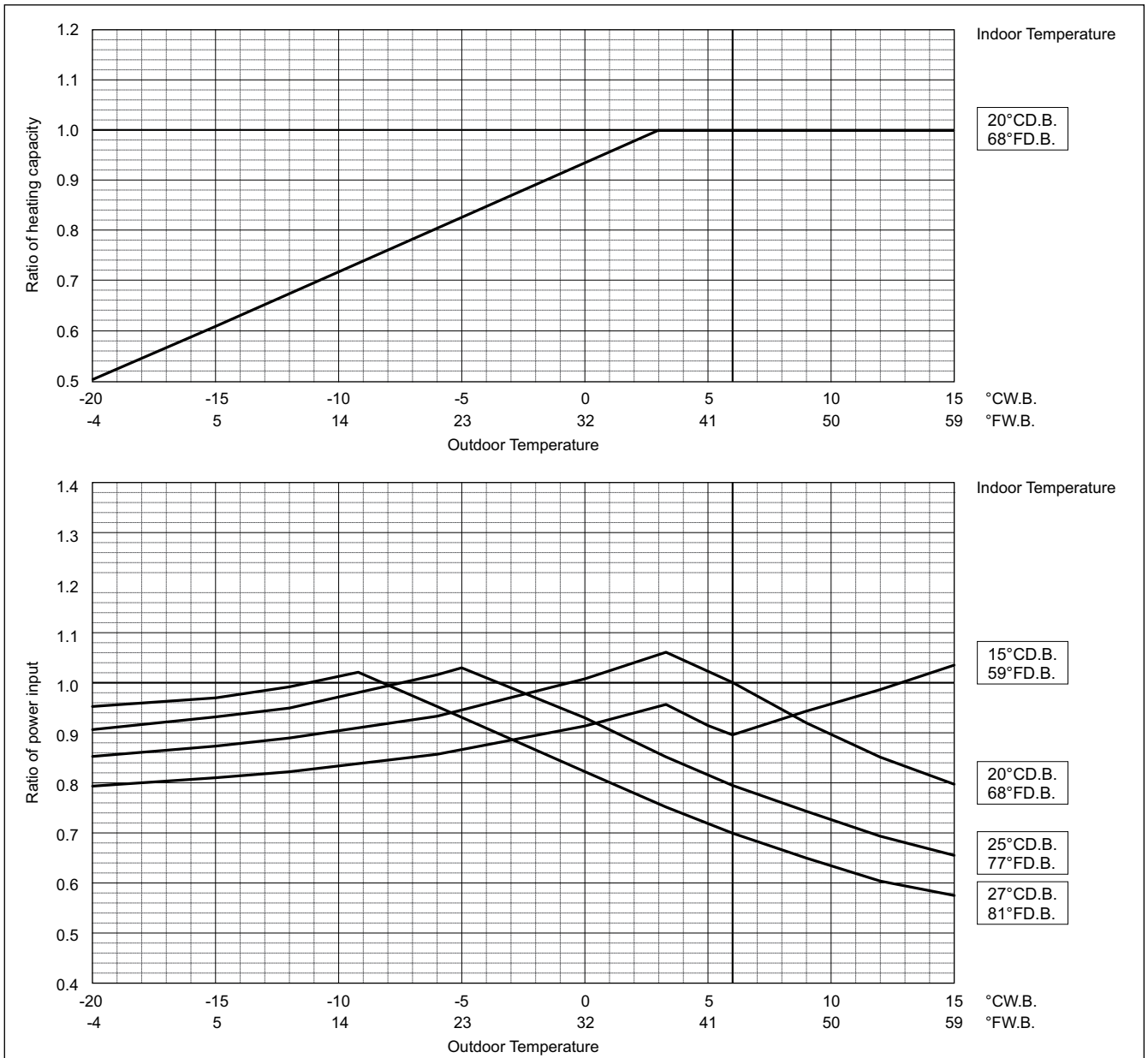

Outdoor unit power input is affected by the indoor and outdoor temperatures as shown in the graph above. Please consult the sales office for details.

PURY-		P300YLM-A1	P350YLM-A1	P400YLM-A1
Nominal Cooling Capacity	kW	33.5	40.0	45.0
	BTU/h	114,300	136,500	153,500
Input	kW	9.10	11.76	13.71

PURY-		P400YSLM-A1
Nominal Cooling Capacity	kW	45.0
	BTU/h	153,500
Input	kW	10.97

Indoor unit temperature correction

To be used to correct indoor unit capacity only

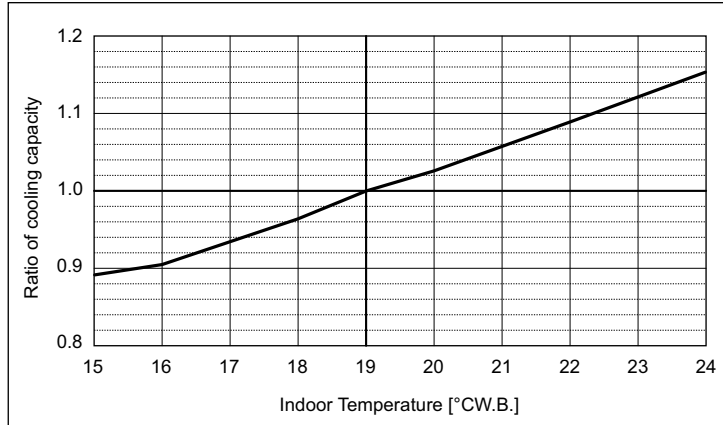

Outdoor unit temperature correction

To be used to correct outdoor unit only

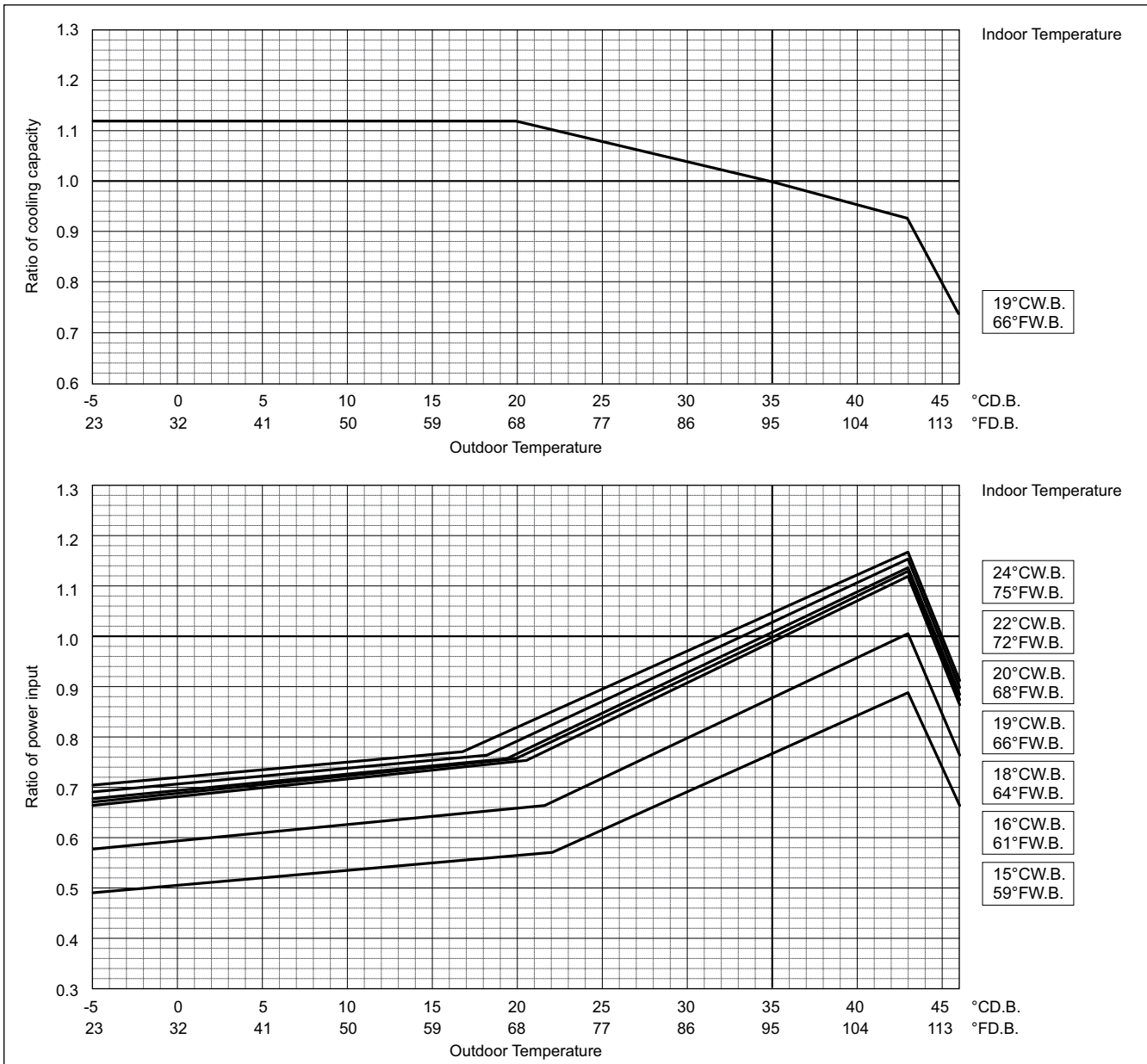

Outdoor unit power input is affected by the indoor and outdoor temperatures as shown in the graph above. Please consult the sales office for details.

	PURY-	P300YLM-A1	P350YLM-A1	P400YLM-A1
Nominal Heating Capacity	kW	37.5	45.0	45.0
	BTU/h	128,000	153,500	153,500
Input	kW	9.37	11.59	11.42

	PURY-	P400YSLM-A1
Nominal Heating Capacity	kW	50.0
	BTU/h	170,600
Input	kW	10.98

Indoor unit temperature correction
To be used to correct indoor unit capacity only

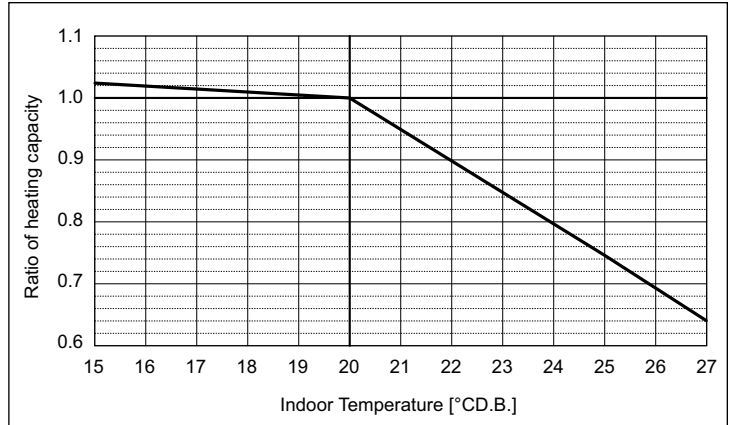

Outdoor unit temperature correction
To be used to correct outdoor unit only

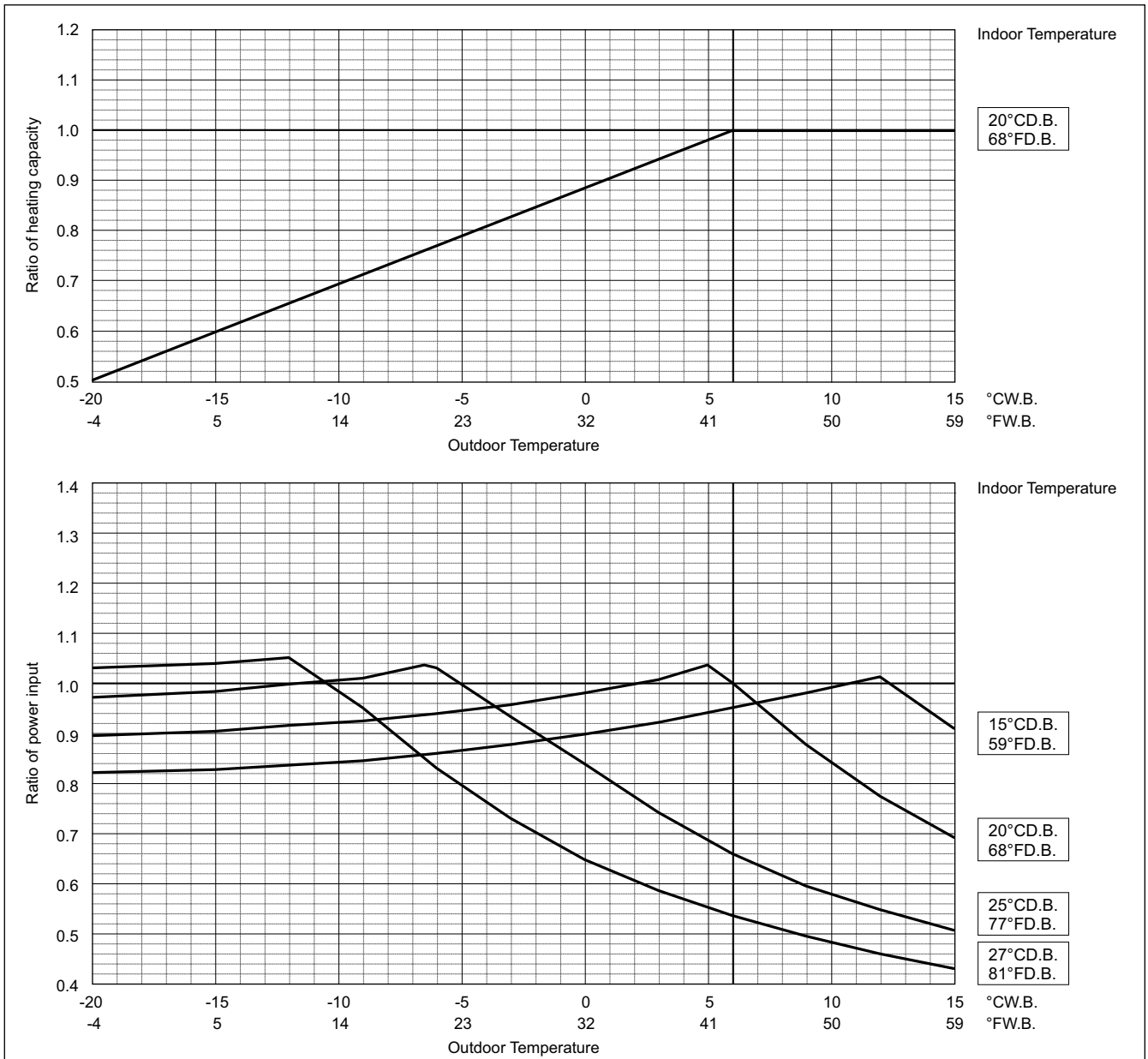

Outdoor unit power input is affected by the indoor and outdoor temperatures as shown in the graph above. Please consult the sales office for details.

PURY-		P450YLM-A1	P500YLM-A1	P450YSLM-A1
Nominal Cooling Capacity	kW	50.0	56.0	50.0
	BTU/h	170,600	191,100	170,600
Input	kW	14.32	17.77	12.50

PURY-		P500YSLM-A1	P550YSLM-A1	P600YSLM-A1
Nominal Cooling Capacity	kW	56.0	63.0	69.0
	BTU/h	191,100	215,000	235,400
Input	kW	14.39	16.89	19.32

PURY-		P650YSLM-A1
Nominal Cooling Capacity	kW	73.0
	BTU/h	249,100
Input	kW	21.28

Indoor unit temperature correction

To be used to correct indoor unit capacity only

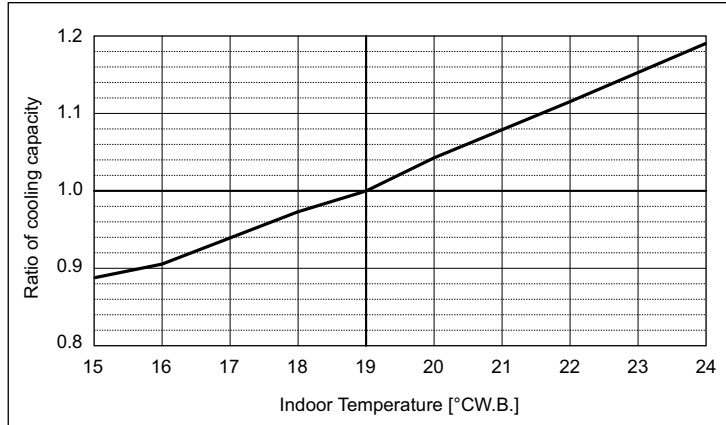

Outdoor unit temperature correction

To be used to correct outdoor unit only

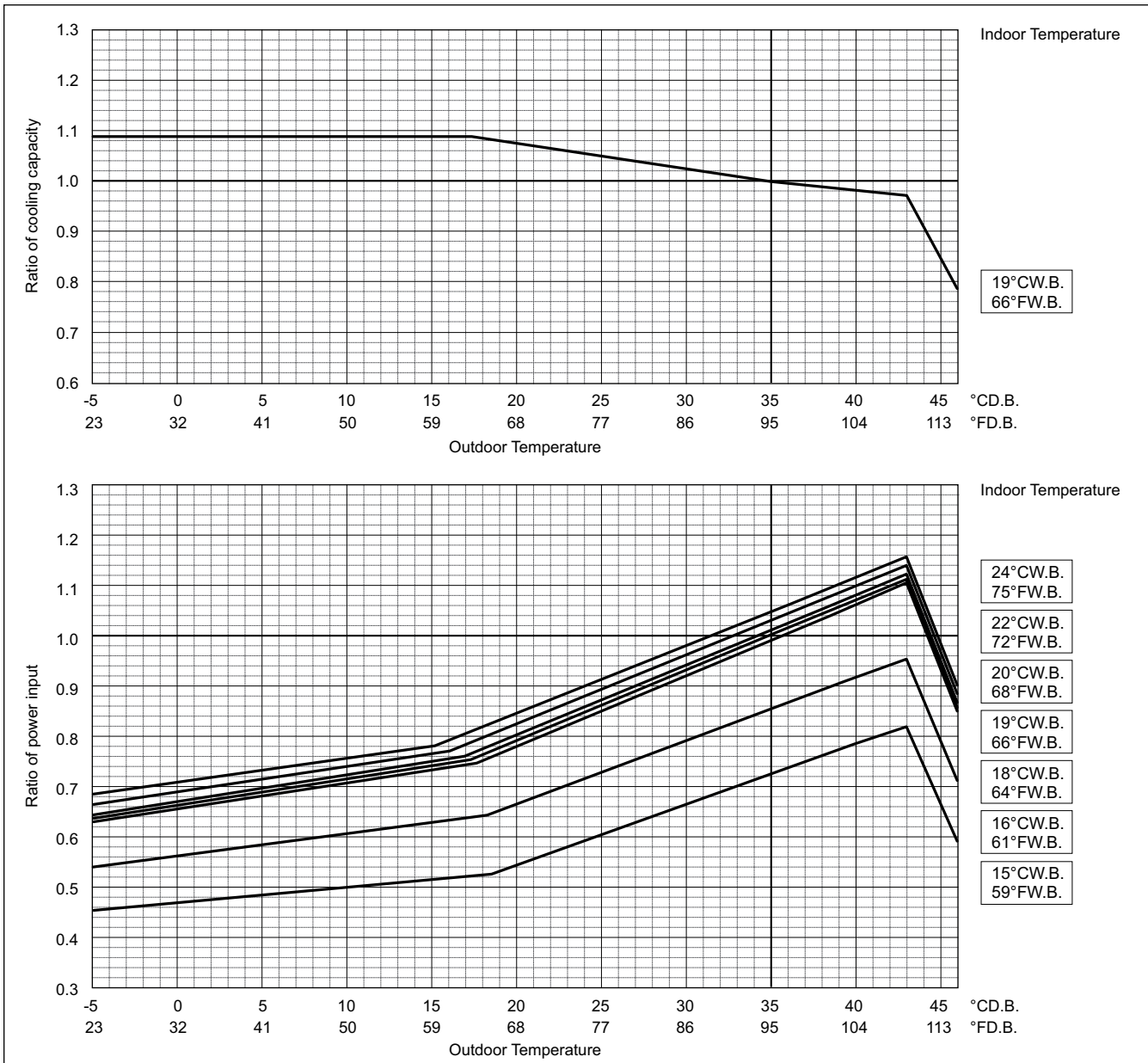

Outdoor unit power input is affected by the indoor and outdoor temperatures as shown in the graph above. Please consult the sales office for details.

8. CAPACITY TABLES

PURY-	P450YLM-A1	P500YLM-A1	P450YSLM-A1
Nominal Heating Capacity	kW 56.0	58.0	56.0
	BTU/h 191,100	197,900	191,100
Input	kW 14.93	16.06	12.64

PURY-	P500YSLM-A1	P550YSLM-A1	P600YSLM-A1
Nominal Heating Capacity	kW 63.0	69.0	76.5
	BTU/h 215,000	235,400	261,000
Input	kW 14.65	16.62	19.12

PURY-	P650YSLM-A1
Nominal Heating Capacity	kW 81.5
	BTU/h 278,100
Input	kW 20.68

Indoor unit temperature correction

To be used to correct indoor unit capacity only

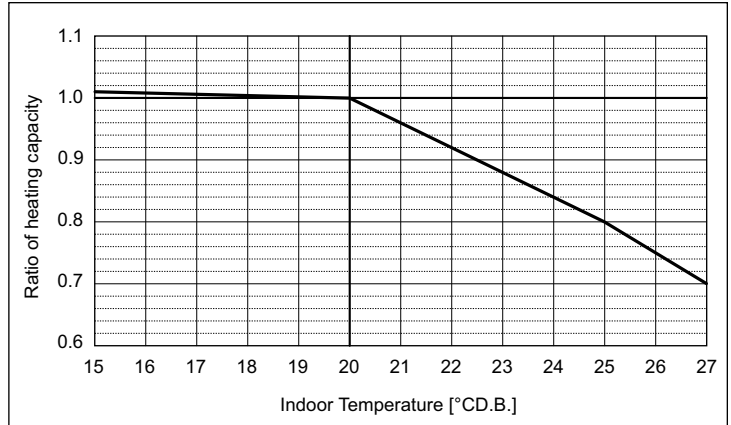

Outdoor unit temperature correction

To be used to correct outdoor unit only

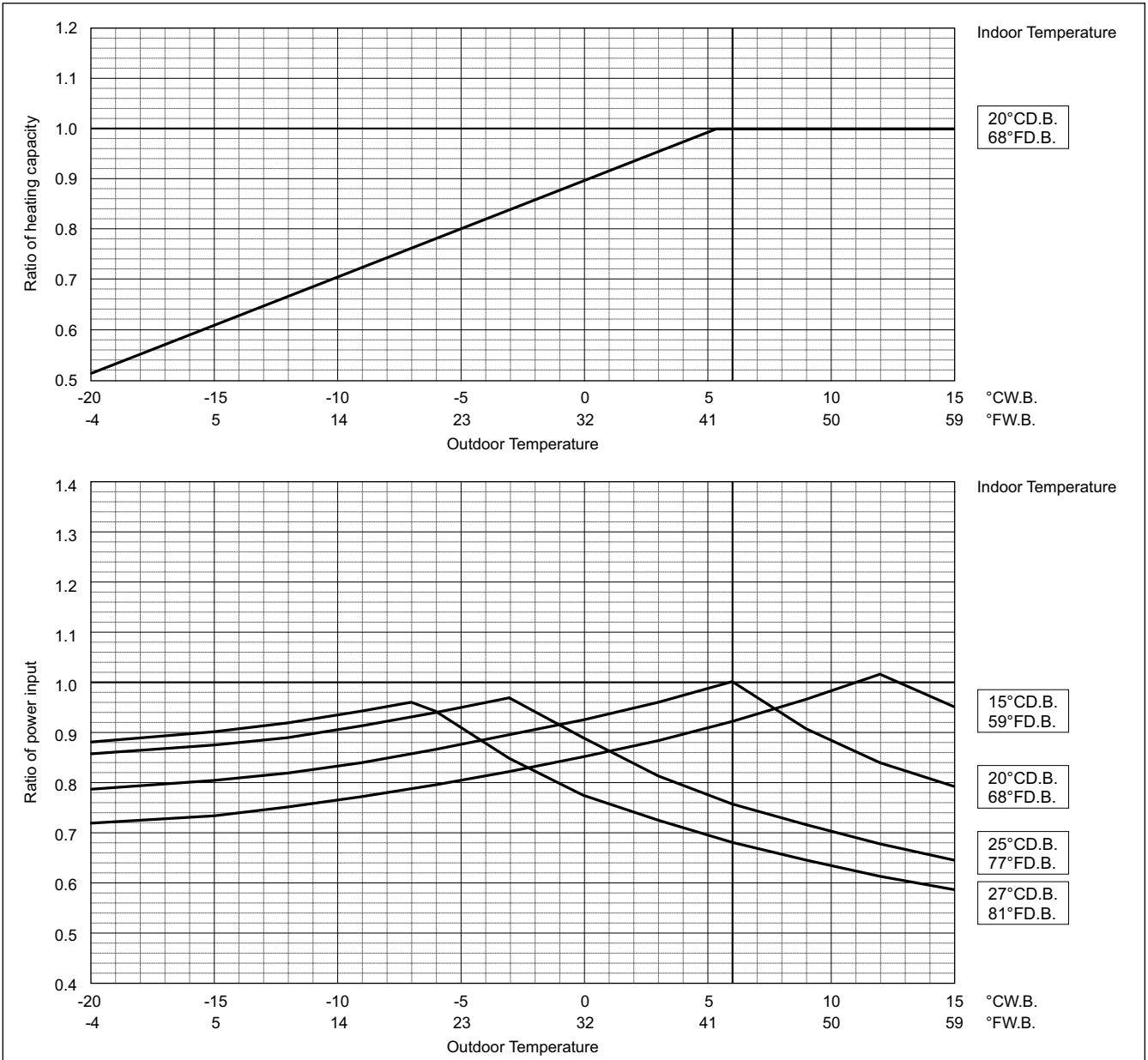

Outdoor unit power input is affected by the indoor and outdoor temperatures as shown in the graph above. Please consult the sales office for details.

R2

PURY-	P700YSLM-A1	P750YSLM-A1	P800YSLM-A1
Nominal Cooling Capacity	80.0	85.0	90.0
	BTU/h	273,000	290,000
Input	24.24	26.23	28.30
	kW		

Indoor unit temperature correction

To be used to correct indoor unit capacity only

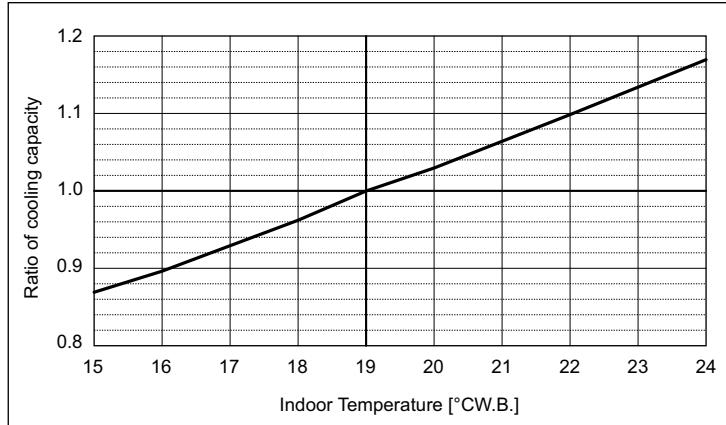

Outdoor unit temperature correction

To be used to correct outdoor unit only

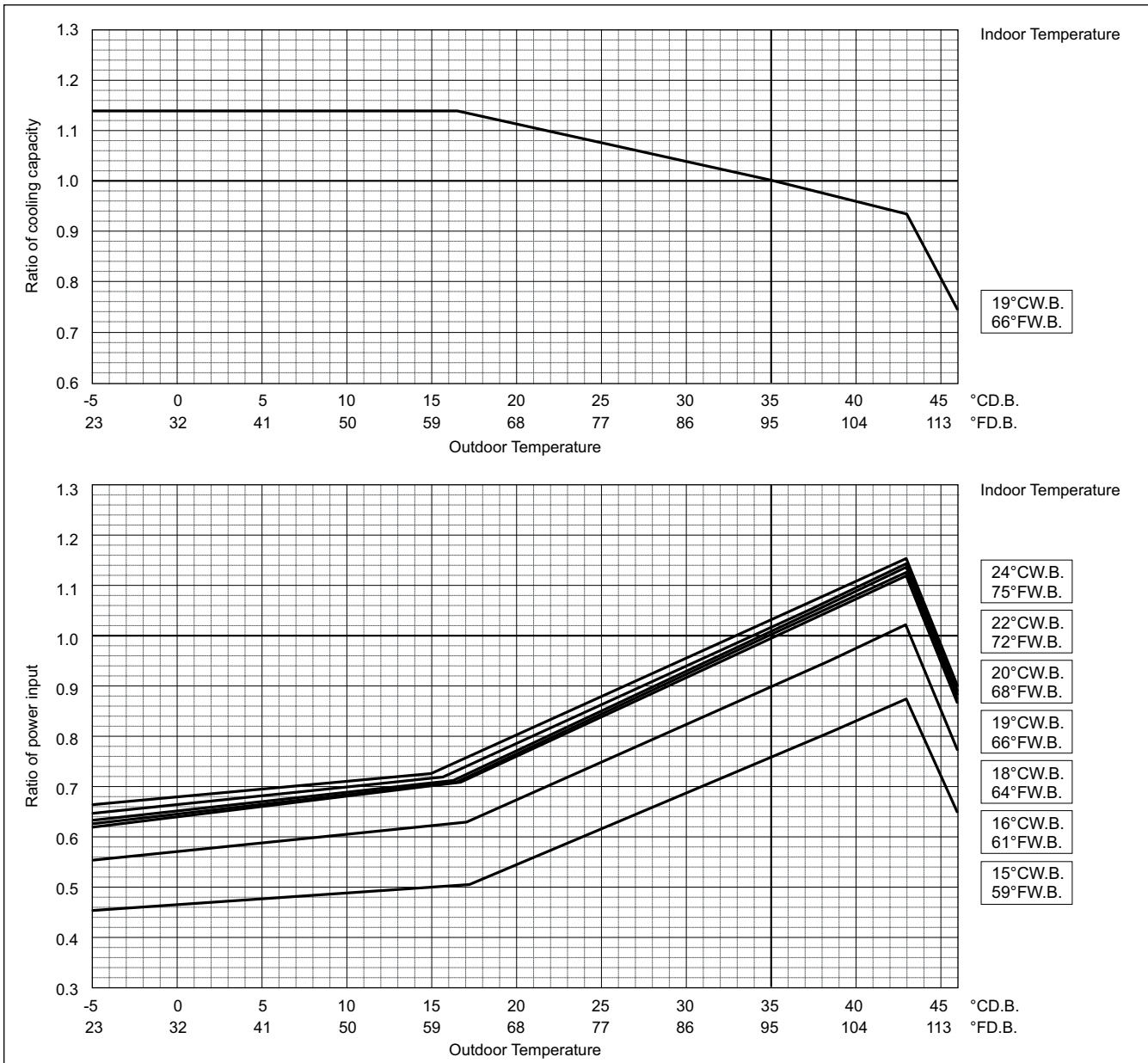

Outdoor unit power input is affected by the indoor and outdoor temperatures as shown in the graph above. Please consult the sales office for details.

PURY-	P700YSLM-A1	P750YSLM-A1	P800YSLM-A1
Nominal Heating Capacity	kW 88.0	90.0	90.0
	BTU/h 300,300	307,100	307,100
Input	kW 22.68	23.01	22.84

Indoor unit temperature correction

To be used to correct indoor unit capacity only

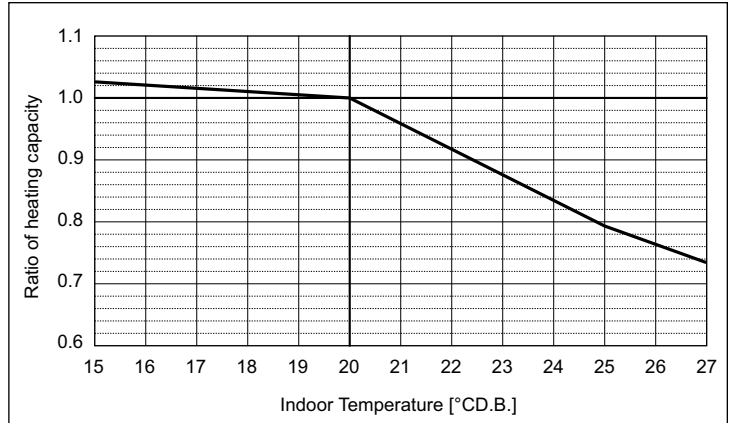

Outdoor unit temperature correction

To be used to correct outdoor unit only

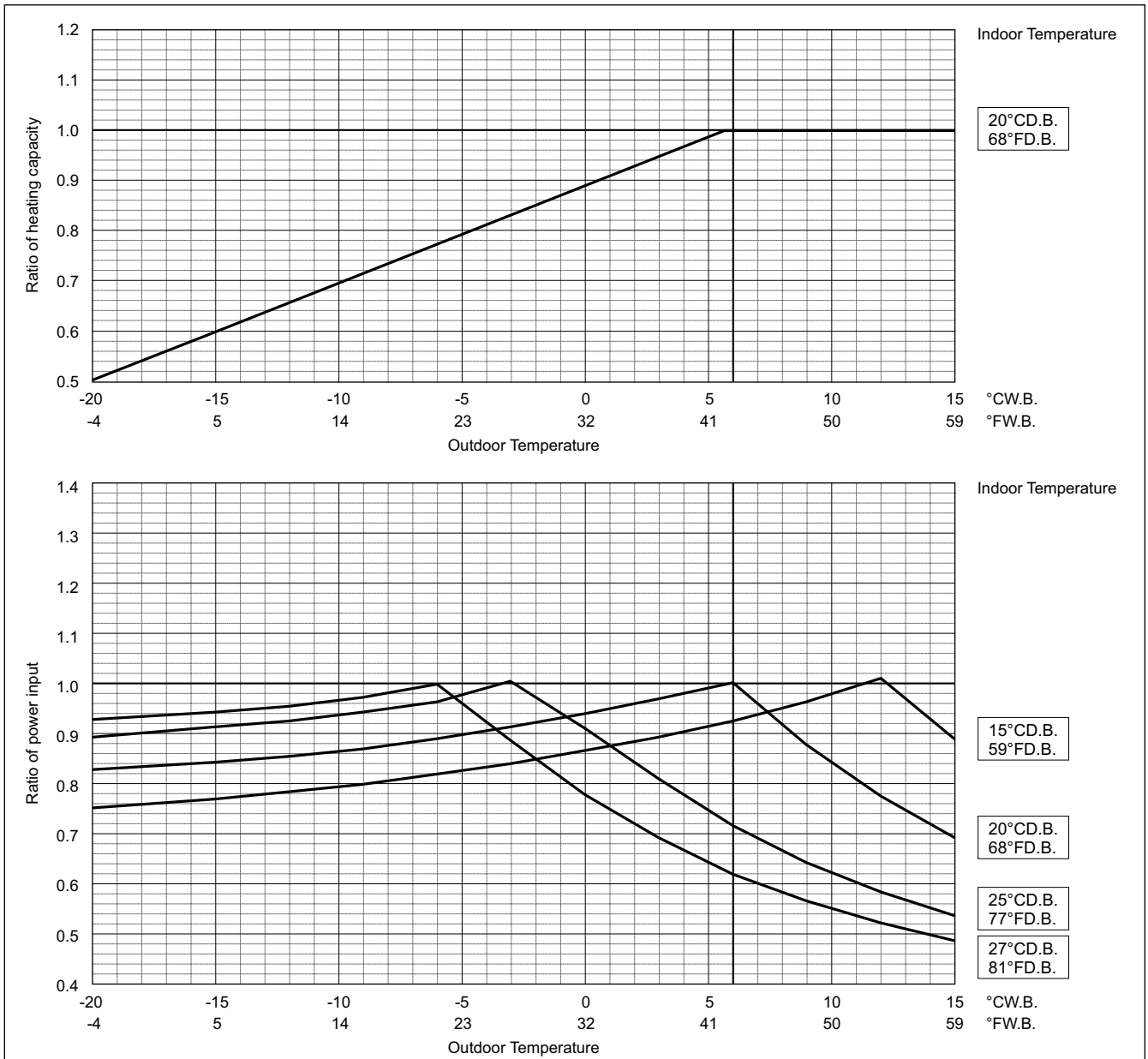

Outdoor unit power input is affected by the indoor and outdoor temperatures as shown in the graph above. Please consult the sales office for details.

PURY-	P850YSLM-A1	P900YSLM-A1
Nominal Cooling Capacity	96.0	101.0
BTU/h	327,600	344,600
Input	29.26	29.79
kW		

Indoor unit temperature correction

To be used to correct indoor unit capacity only

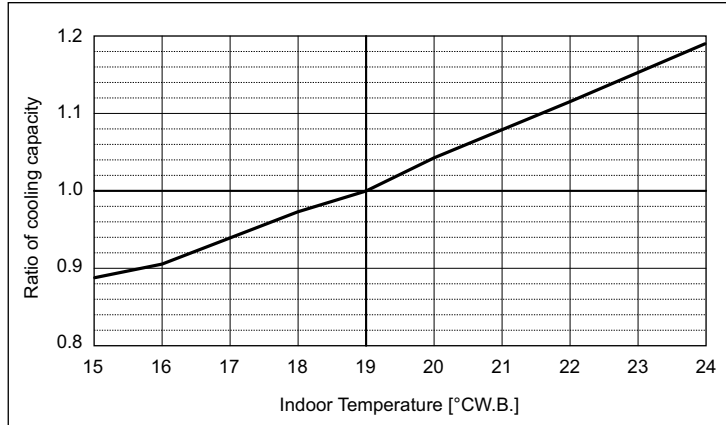

Outdoor unit temperature correction

To be used to correct outdoor unit only

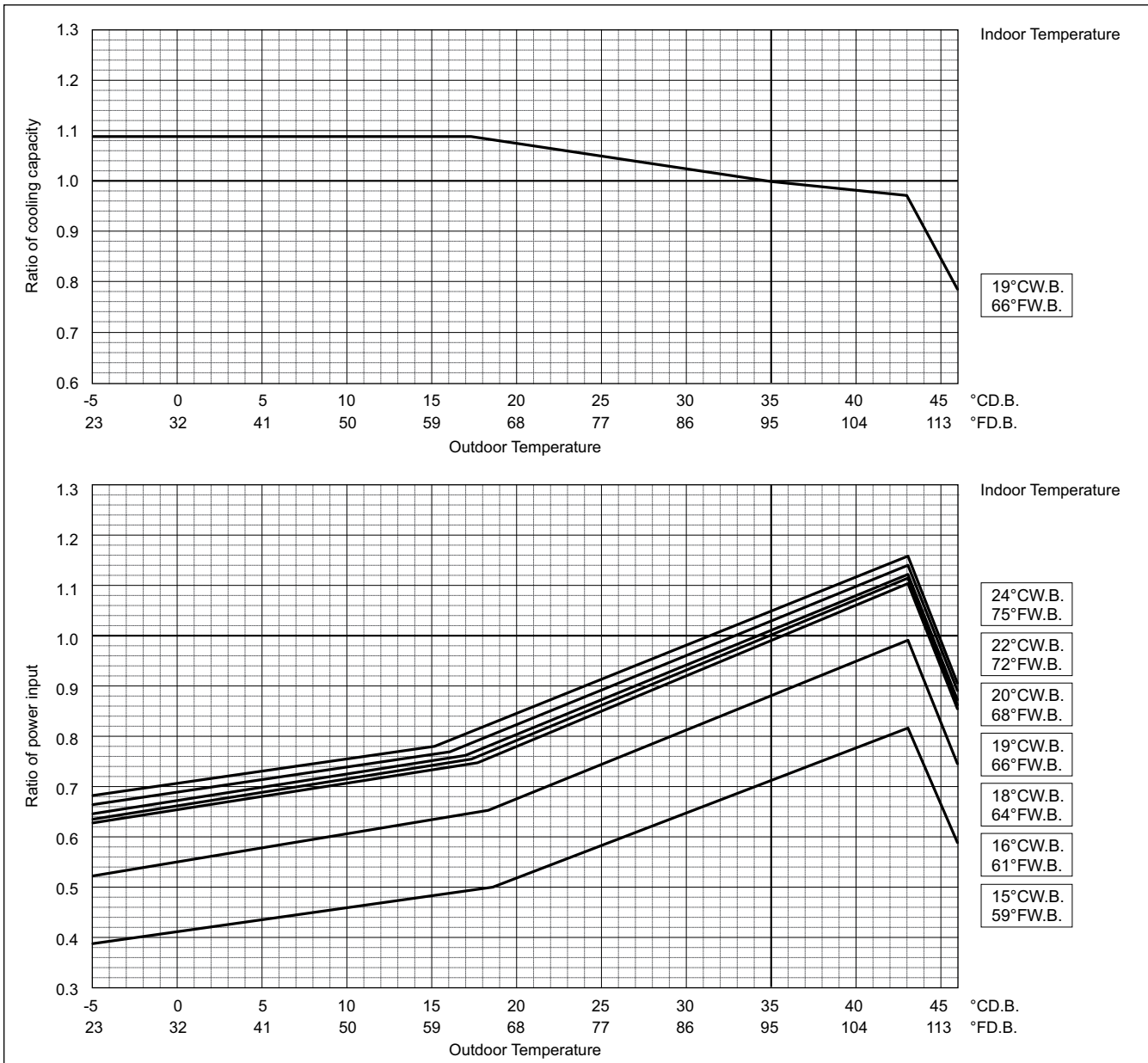

Outdoor unit power input is affected by the indoor and outdoor temperatures as shown in the graph above. Please consult the sales office for details.

PURY-	P850YSLM-A1	P900YSLM-A1
Nominal Heating Capacity	kW 101.0	113.0
	BTU/h 344,600	385,600
Input	kW 26.23	30.13

Indoor unit temperature correction

To be used to correct indoor unit capacity only

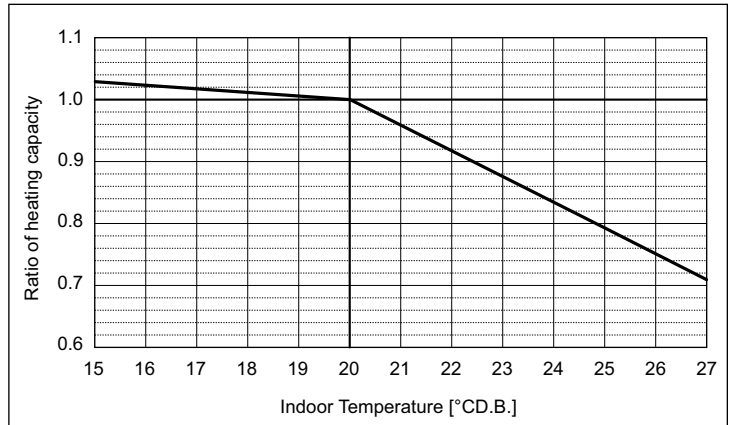

Outdoor unit temperature correction

To be used to correct outdoor unit only

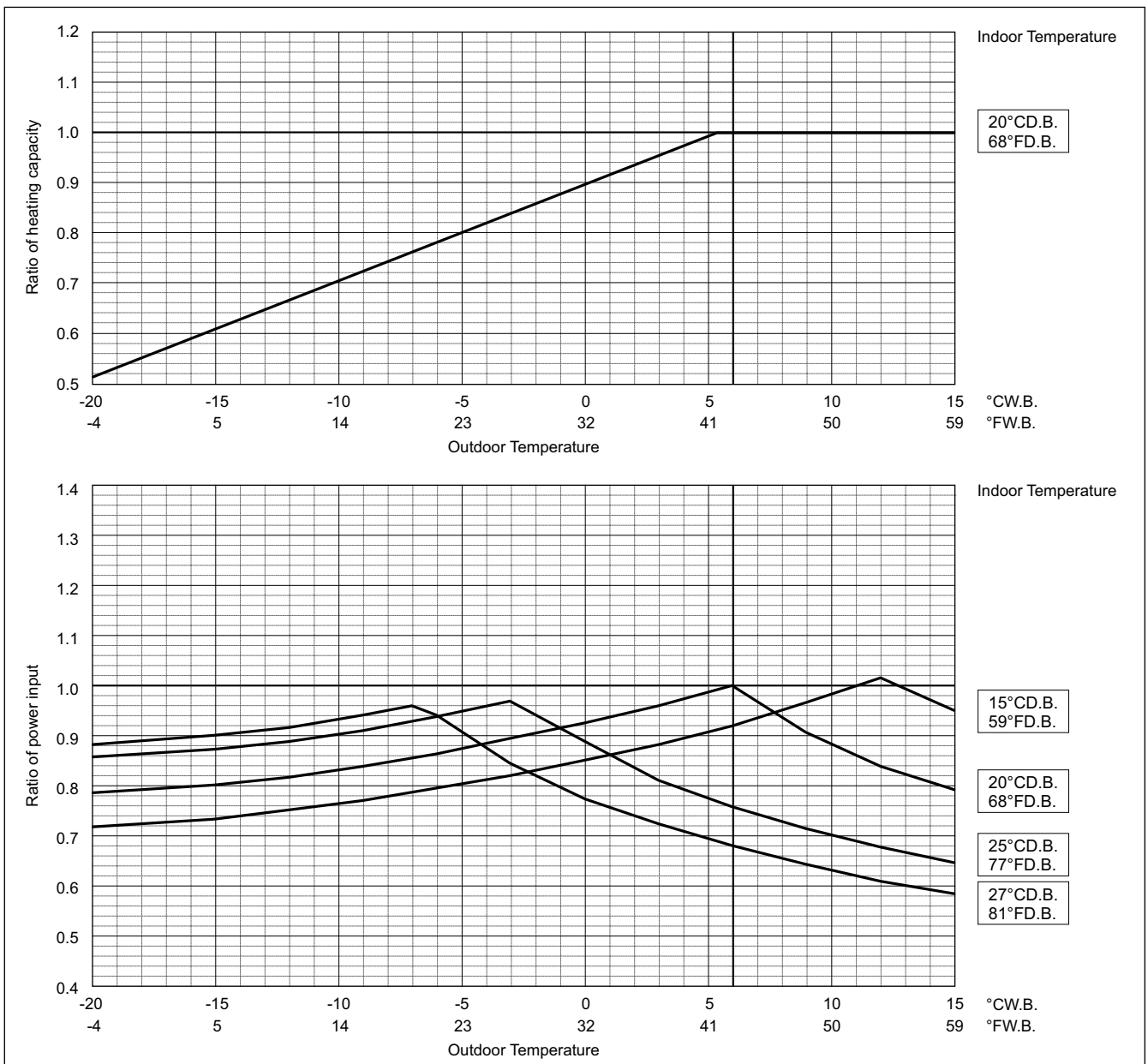

Outdoor unit power input is affected by the indoor and outdoor temperatures as shown in the graph above. Please consult the sales office for details.

R2

8-3. Correction by total indoor

PURY-P200YLM-A1		
Nominal Cooling Capacity	kW	22.4
	BTU/h	76,400
Input	kW	5.29

PURY-P200YLM-A1		
Nominal Heating Capacity	kW	25.0
	BTU/h	85,300
Input	kW	5.49

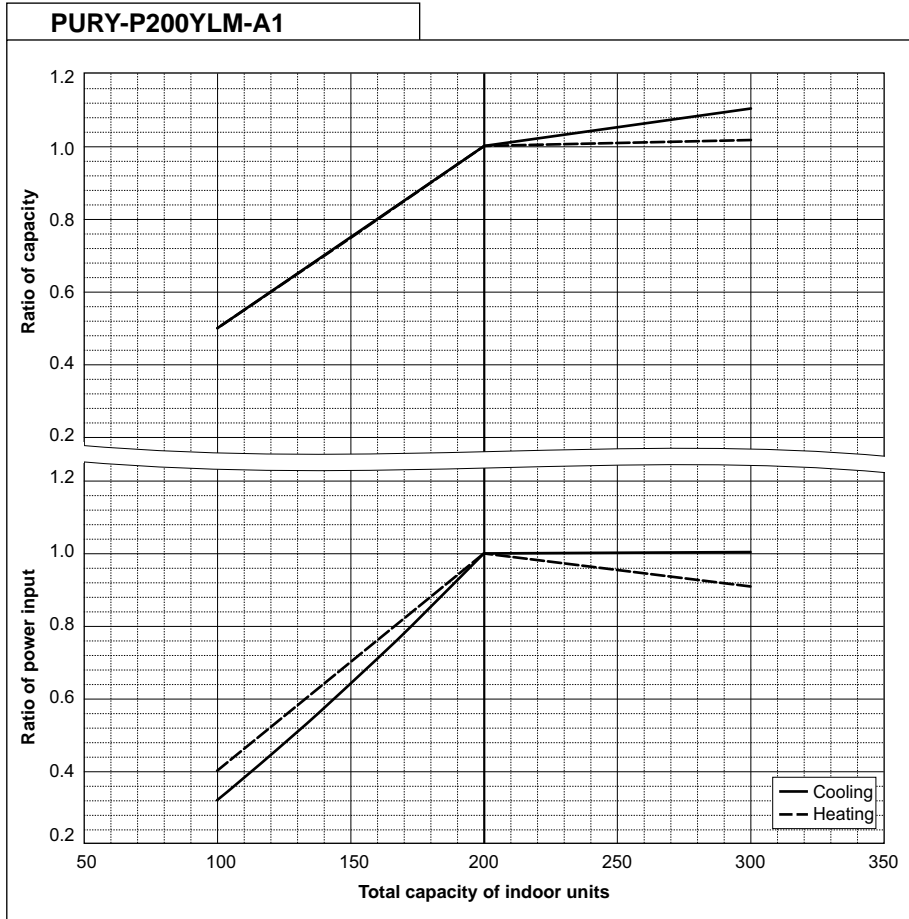

PURY-P250YLM-A1		
Nominal Cooling Capacity	kW	28.0
	BTU/h	95,500
Input	kW	6.98

PURY-P250YLM-A1		
Nominal Heating Capacity	kW	31.5
	BTU/h	107,500
Input	kW	7.32

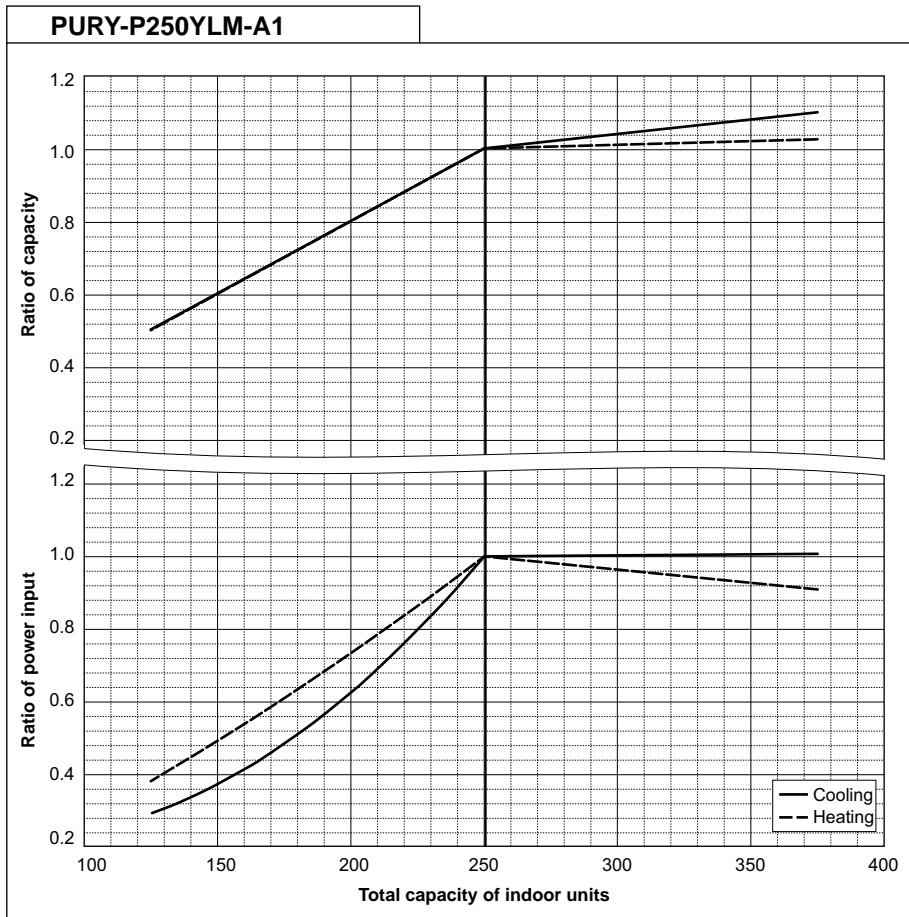

PURY-P300YLM-A1		
Nominal Cooling Capacity	kW	33.5
	BTU/h	114,300
Input	kW	9.10

PURY-P300YLM-A1		
Nominal Heating Capacity	kW	37.5
	BTU/h	128,000
Input	kW	9.37

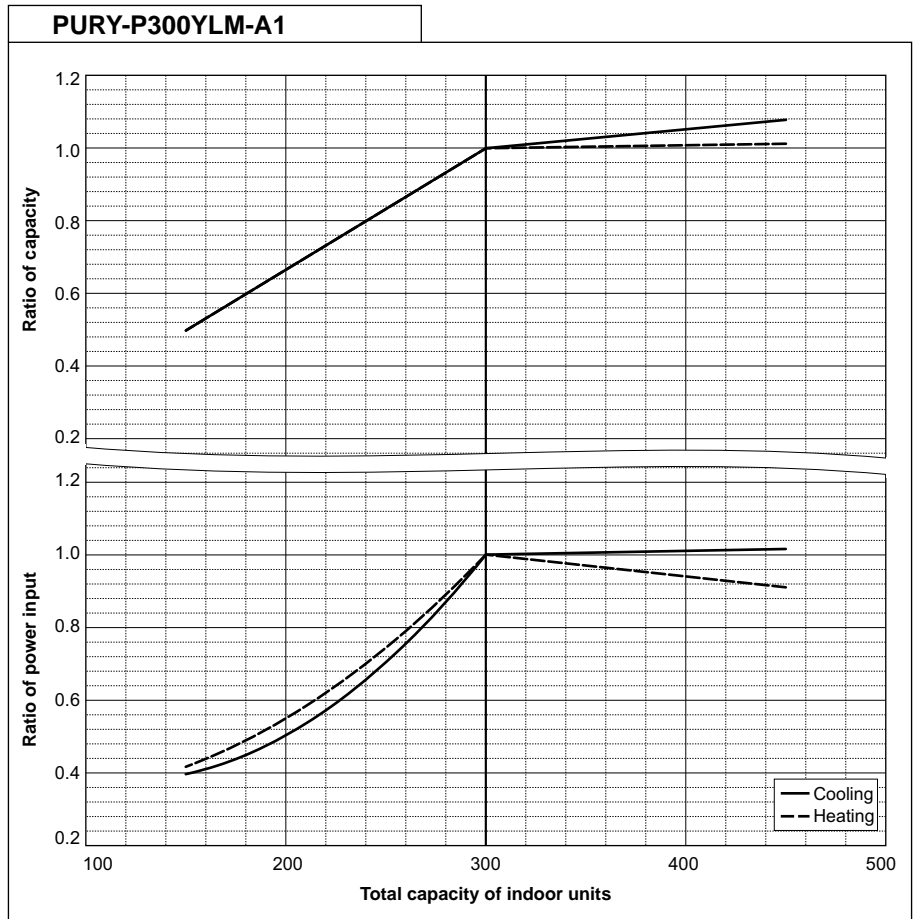

PURY-P350YLM-A1		
Nominal Cooling Capacity	kW	40.0
	BTU/h	136,500
Input	kW	11.76

PURY-P350YLM-A1		
Nominal Heating Capacity	kW	45.0
	BTU/h	153,500
Input	kW	11.59

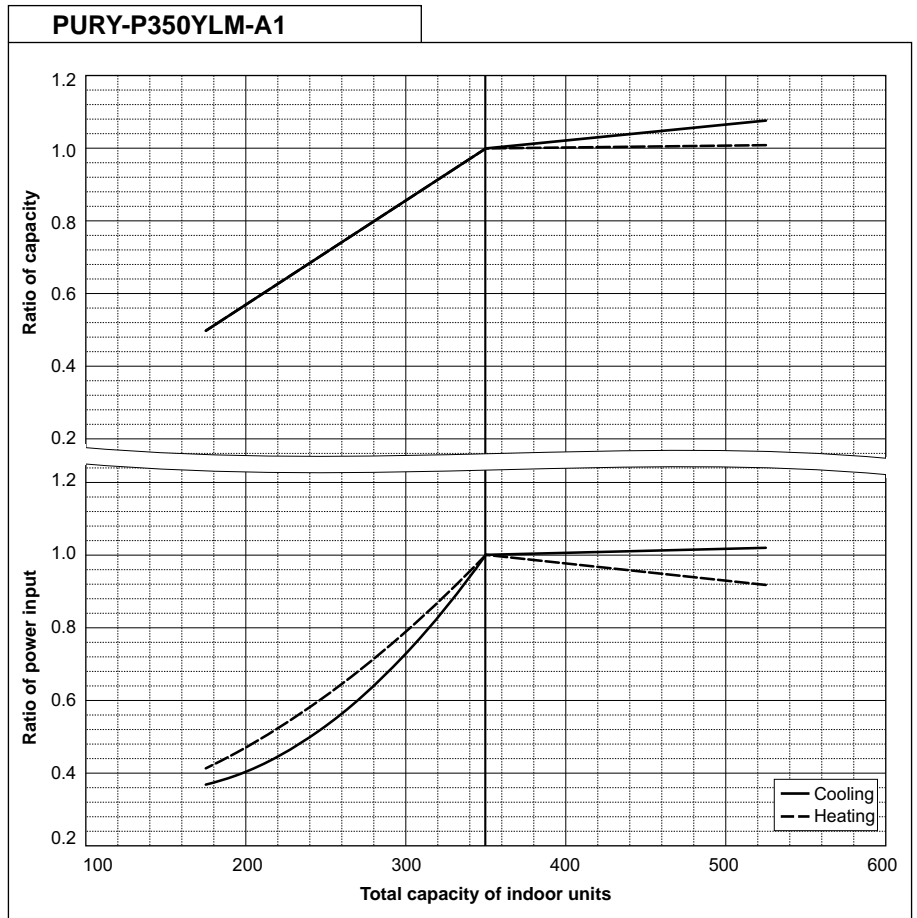

R2

R2

PURY-P400YLM-A1		
Nominal Cooling Capacity	kW	45.0
	BTU/h	153,500
Input	kW	13.71

PURY-P400YLM-A1		
Nominal Heating Capacity	kW	45.0
	BTU/h	153,500
Input	kW	11.42

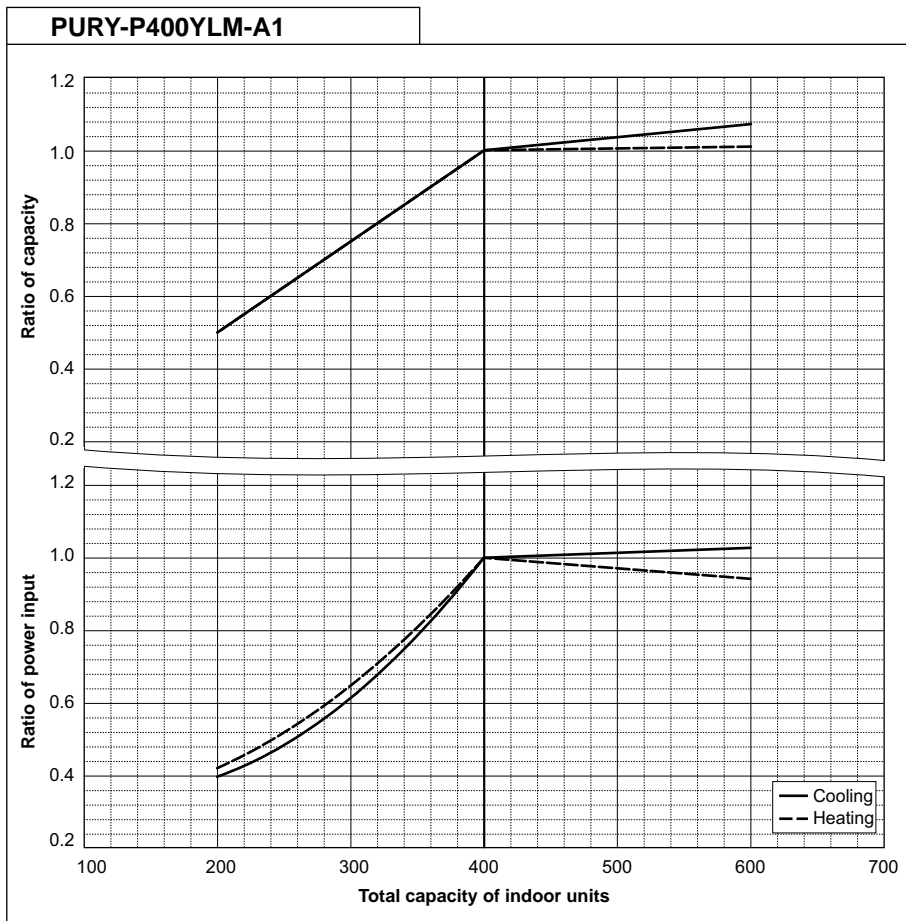

PURY-P450YLM-A1		
Nominal Cooling Capacity	kW	50.0
	BTU/h	170,600
Input	kW	14.32

PURY-P450YLM-A1		
Nominal Heating Capacity	kW	56.0
	BTU/h	191,100
Input	kW	14.93

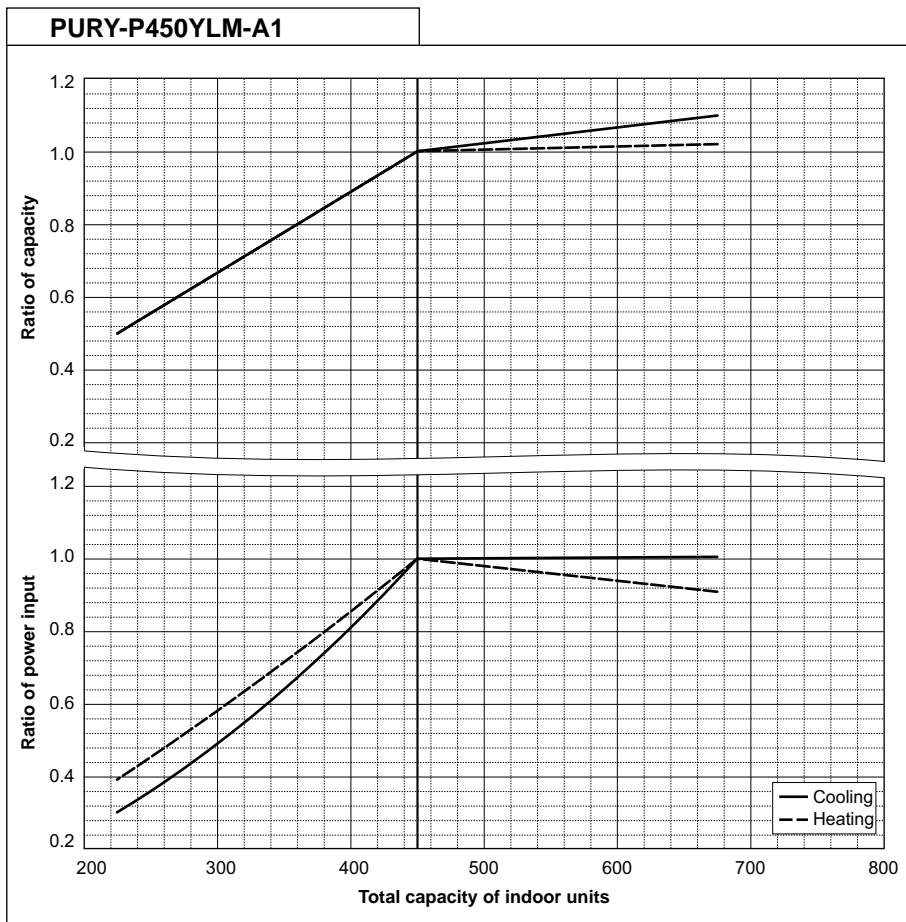

PURY-P500YLM-A1		
Nominal Cooling Capacity	kW	56.0
	BTU/h	191,100
Input	kW	17.77

PURY-P500YLM-A1		
Nominal Heating Capacity	kW	58.0
	BTU/h	197,900
Input	kW	16.06

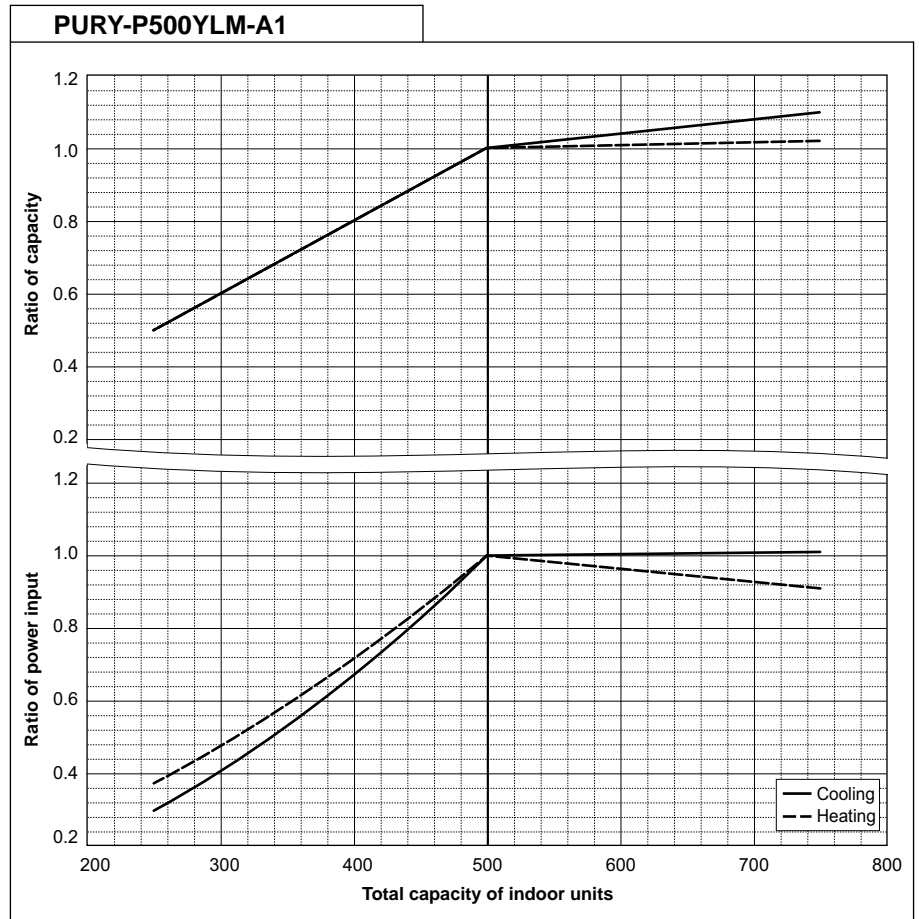

PURY-P400YSLM-A1		
Nominal Cooling Capacity	kW	45.0
	BTU/h	153,500
Input	kW	10.97

PURY-P400YSLM-A1		
Nominal Heating Capacity	kW	50.0
	BTU/h	170,600
Input	kW	10.98

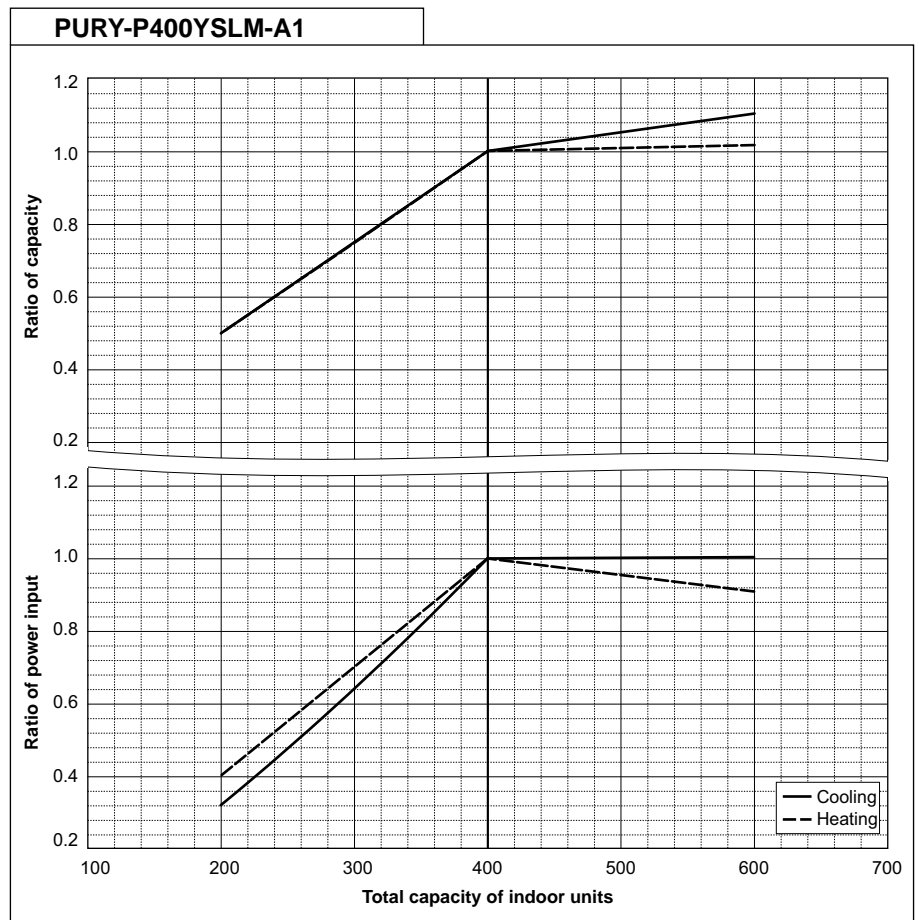

R2

8. CAPACITY TABLES

YKB/YLM

R2

PURY-P450YSLM-A1		
Nominal Cooling Capacity	kW	50.0
	BTU/h	170,600
Input	kW	12.50

PURY-P450YSLM-A1		
Nominal Heating Capacity	kW	56.0
	BTU/h	191,100
Input	kW	12.64

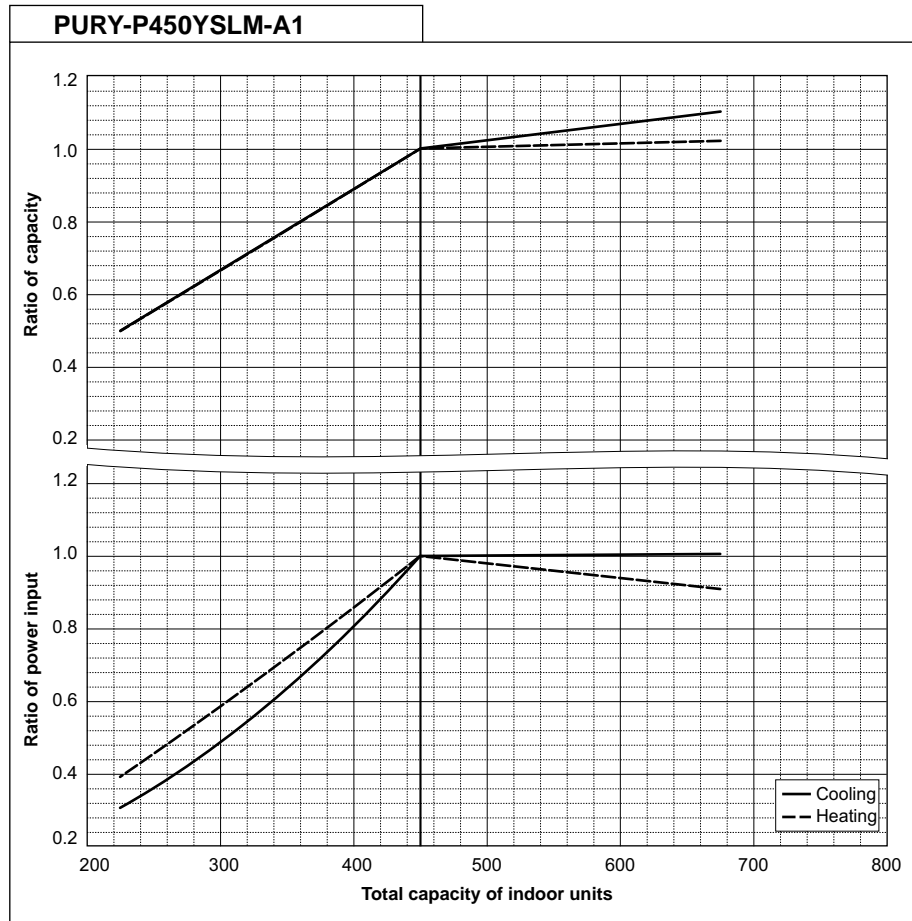

PURY-P500YSLM-A1		
Nominal Cooling Capacity	kW	56.0
	BTU/h	191,100
Input	kW	14.39

PURY-P500YSLM-A1		
Nominal Heating Capacity	kW	63.0
	BTU/h	215,000
Input	kW	14.65

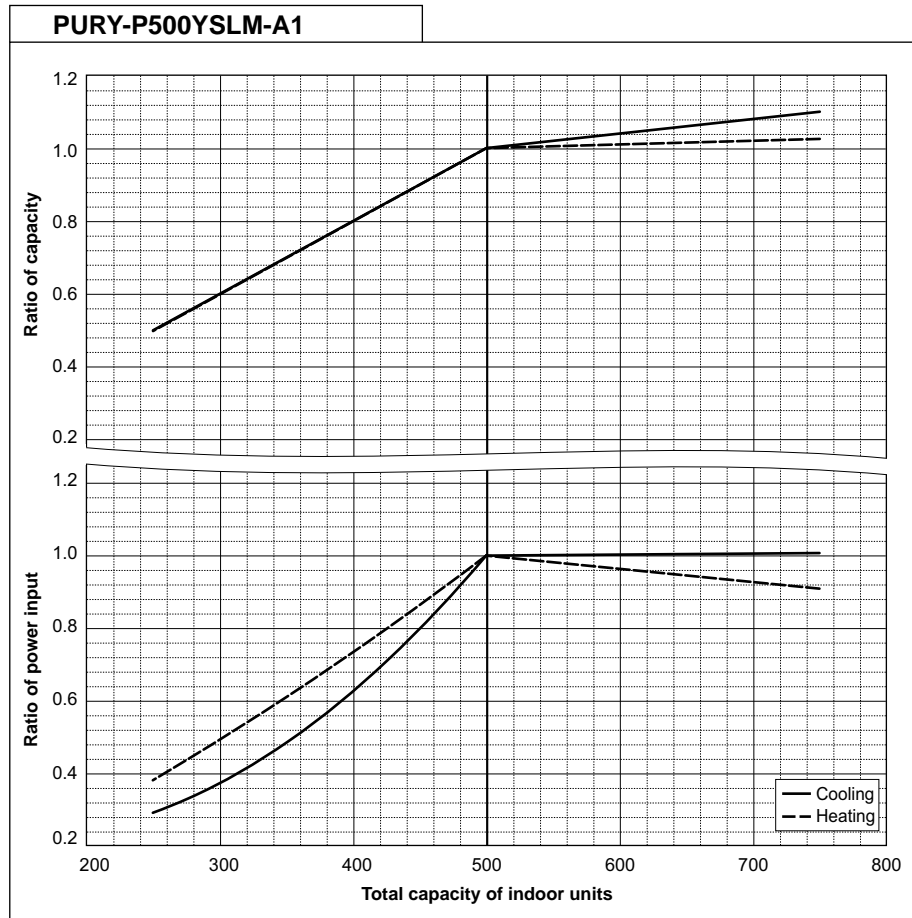

PURY-P550YSLM-A1		
Nominal Cooling Capacity	kW	63.0
	BTU/h	215,000
Input	kW	16.89

PURY-P550YSLM-A1		
Nominal Heating Capacity	kW	69.0
	BTU/h	235,400
Input	kW	16.62

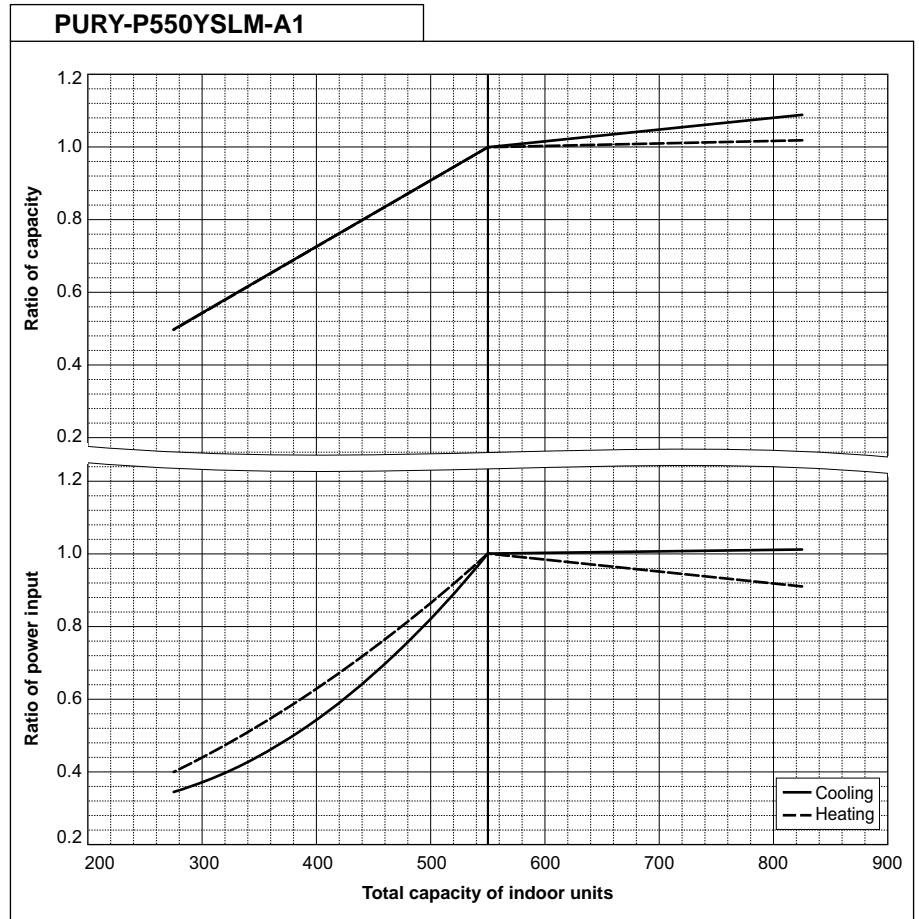

PURY-P600YSLM-A1		
Nominal Cooling Capacity	kW	69.0
	BTU/h	235,400
Input	kW	19.32

PURY-P600YSLM-A1		
Nominal Heating Capacity	kW	76.5
	BTU/h	261,000
Input	kW	19.12

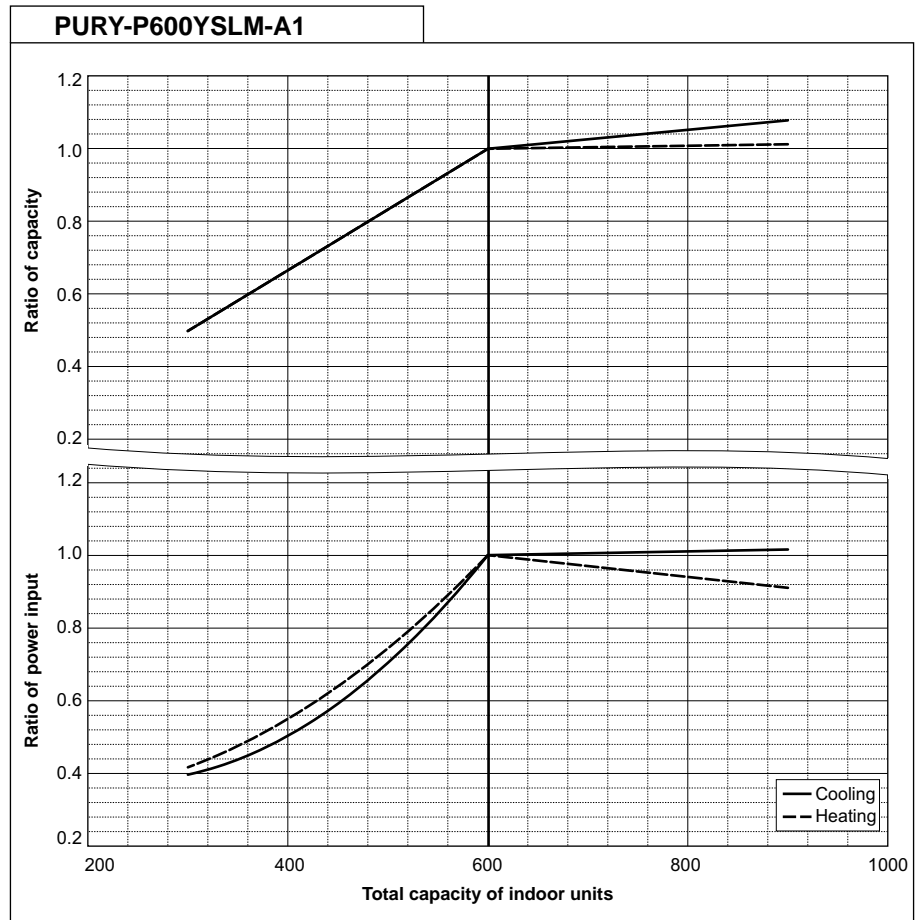

R2

8. CAPACITY TABLES

YKB/YLM

R2

PURY-P650YSLM-A1		
Nominal Cooling Capacity	kW	73.0
	BTU/h	249,100
Input	kW	21.28

PURY-P650YSLM-A1		
Nominal Heating Capacity	kW	81.5
	BTU/h	278,100
Input	kW	20.68

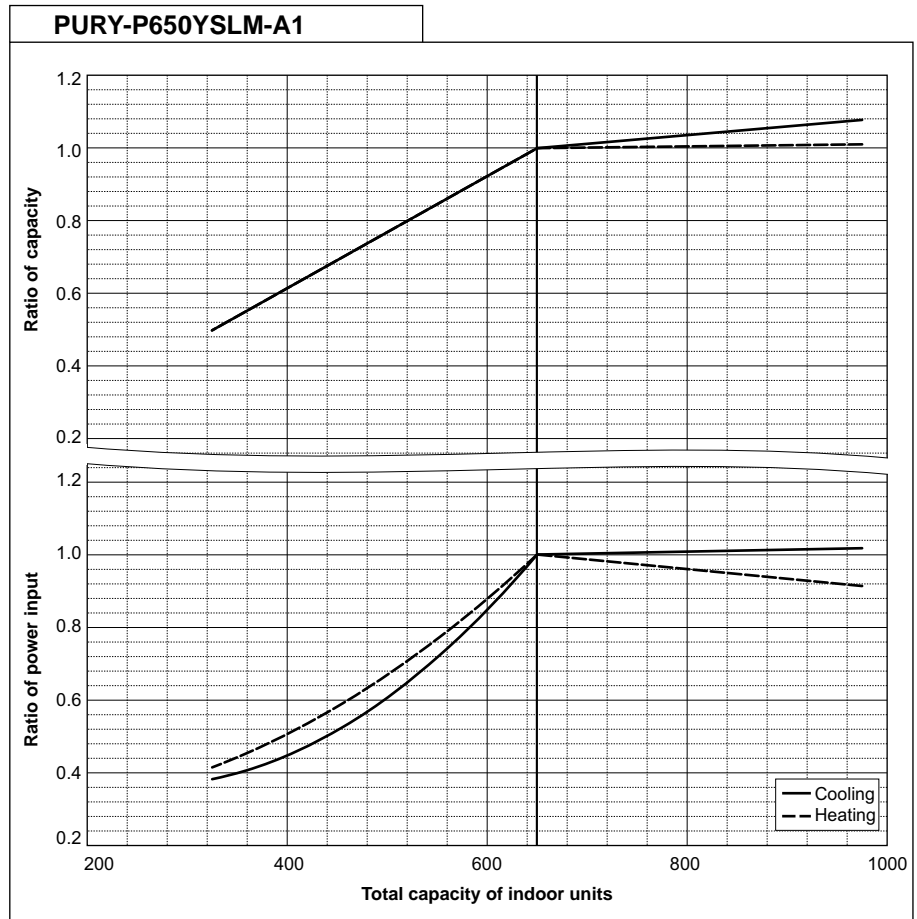

PURY-P700YSLM-A1		
Nominal Cooling Capacity	kW	80.0
	BTU/h	273,000
Input	kW	24.24

PURY-P700YSLM-A1		
Nominal Heating Capacity	kW	88.0
	BTU/h	300,300
Input	kW	22.68

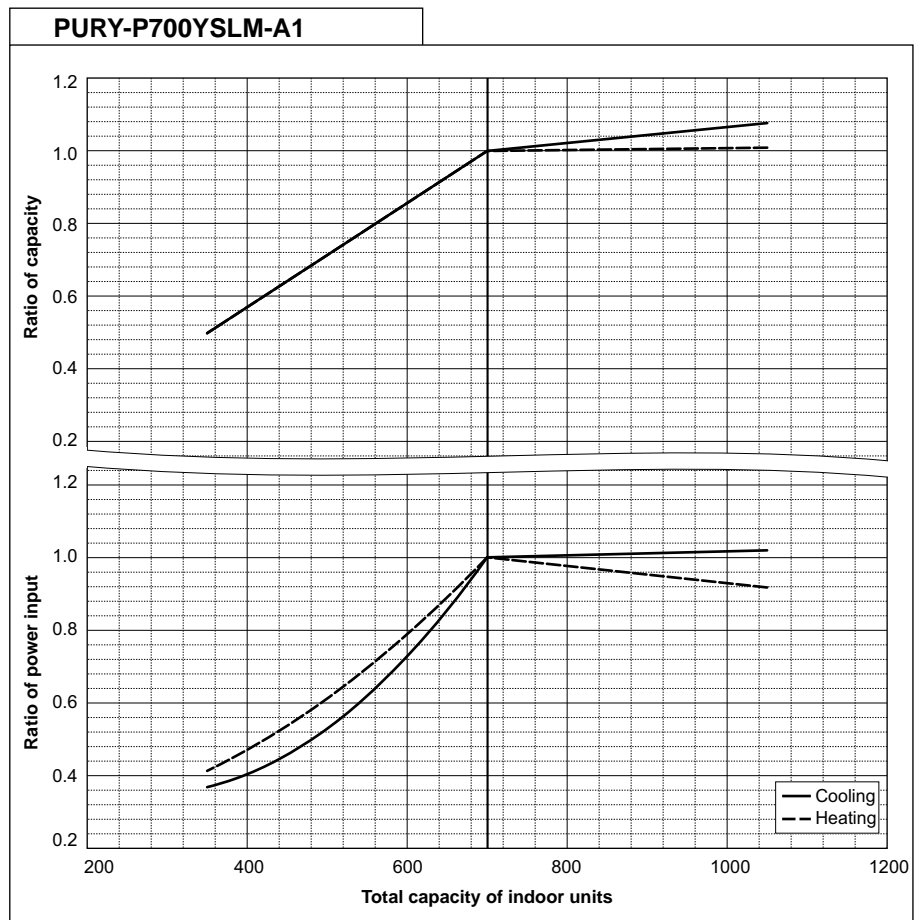

PURY-P750YSLM-A1		
Nominal Cooling Capacity	kW	85.0
	BTU/h	290,000
Input	kW	26.23

PURY-P750YSLM-A1		
Nominal Heating Capacity	kW	90.0
	BTU/h	307,100
Input	kW	23.01

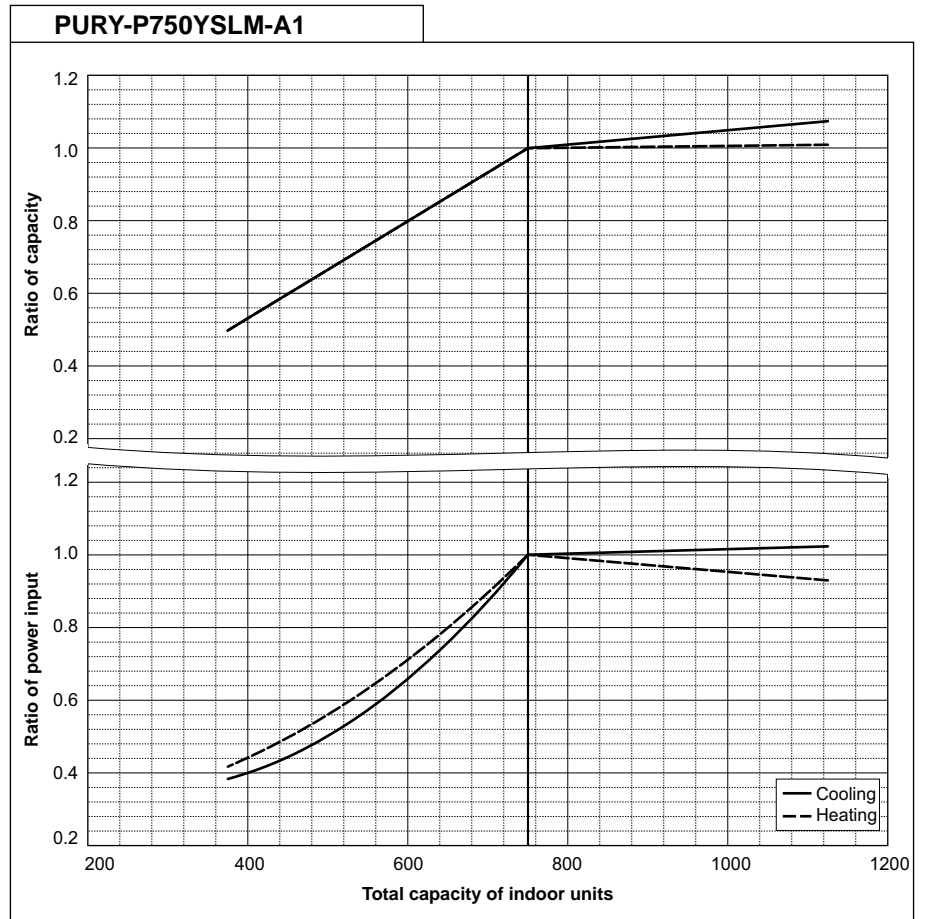

PURY-P800YSLM-A1		
Nominal Cooling Capacity	kW	90.0
	BTU/h	307,100
Input	kW	28.30

PURY-P800YSLM-A1		
Nominal Heating Capacity	kW	90.0
	BTU/h	307,100
Input	kW	22.84

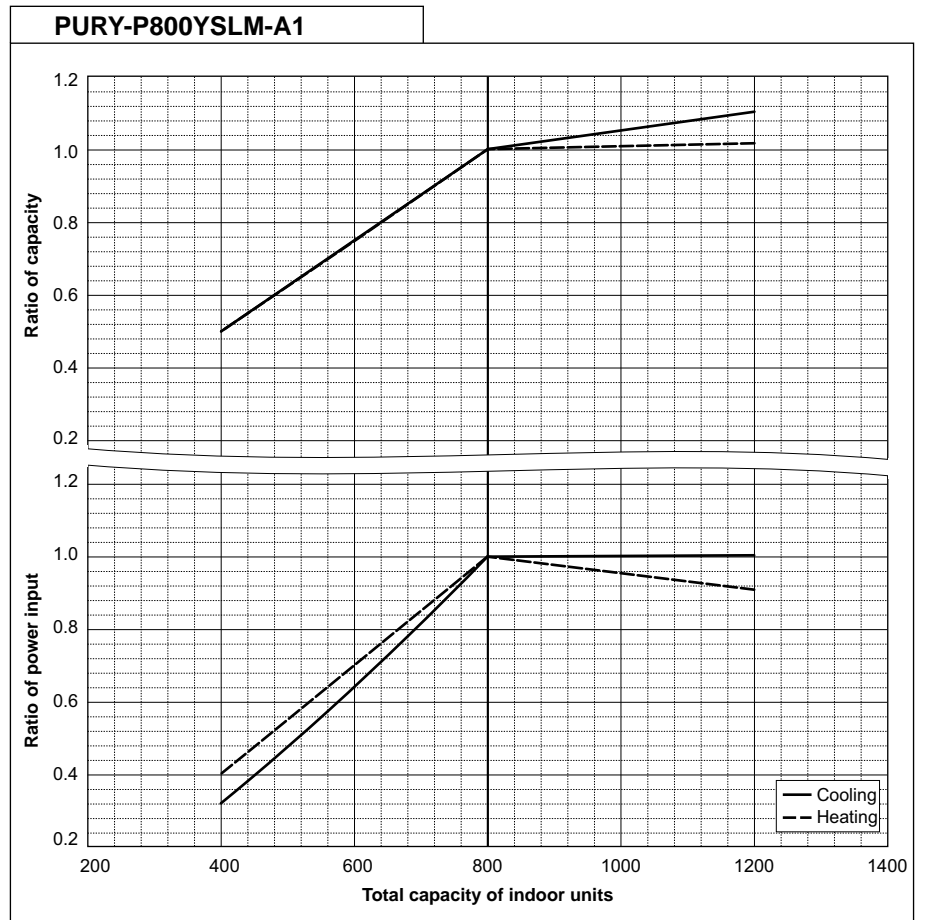

R2

PURY-P850YSLM-A1		
Nominal Cooling Capacity	kW	96.0
	BTU/h	327,600
Input	kW	29.26

PURY-P850YSLM-A1		
Nominal Heating Capacity	kW	101.0
	BTU/h	344,600
Input	kW	26.23

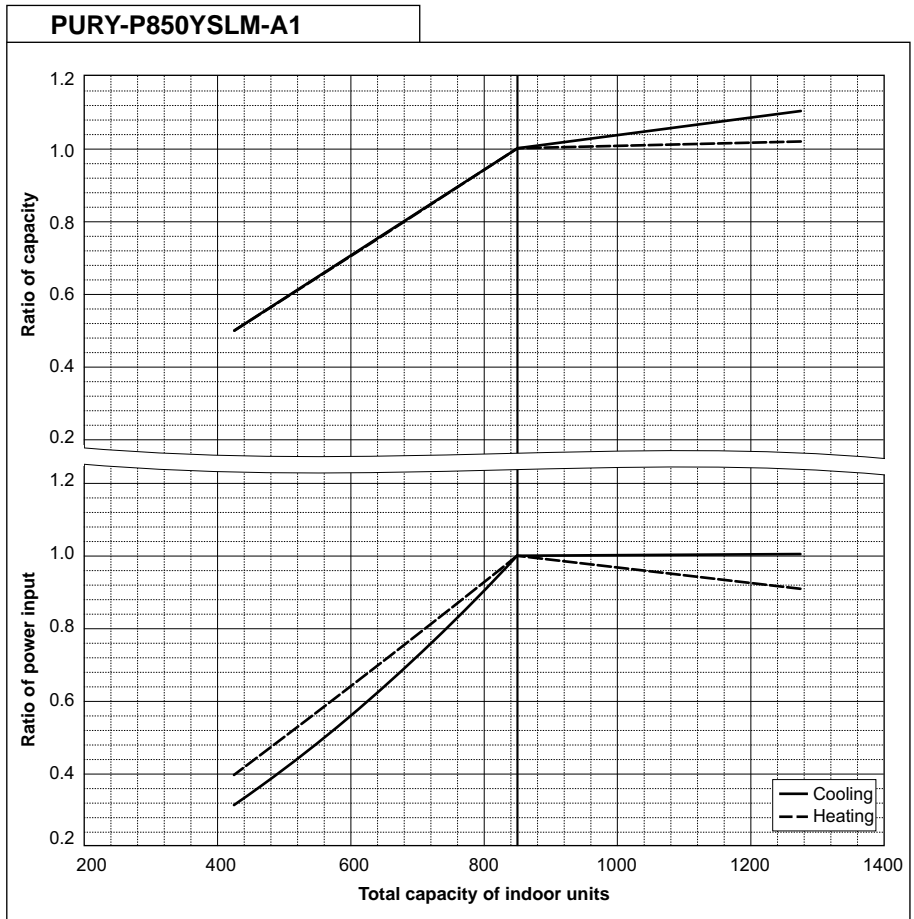

PURY-P900YSLM-A1		
Nominal Cooling Capacity	kW	101.0
	BTU/h	344,600
Input	kW	29.79

PURY-P900YSLM-A1		
Nominal Heating Capacity	kW	113.0
	BTU/h	385,600
Input	kW	30.13

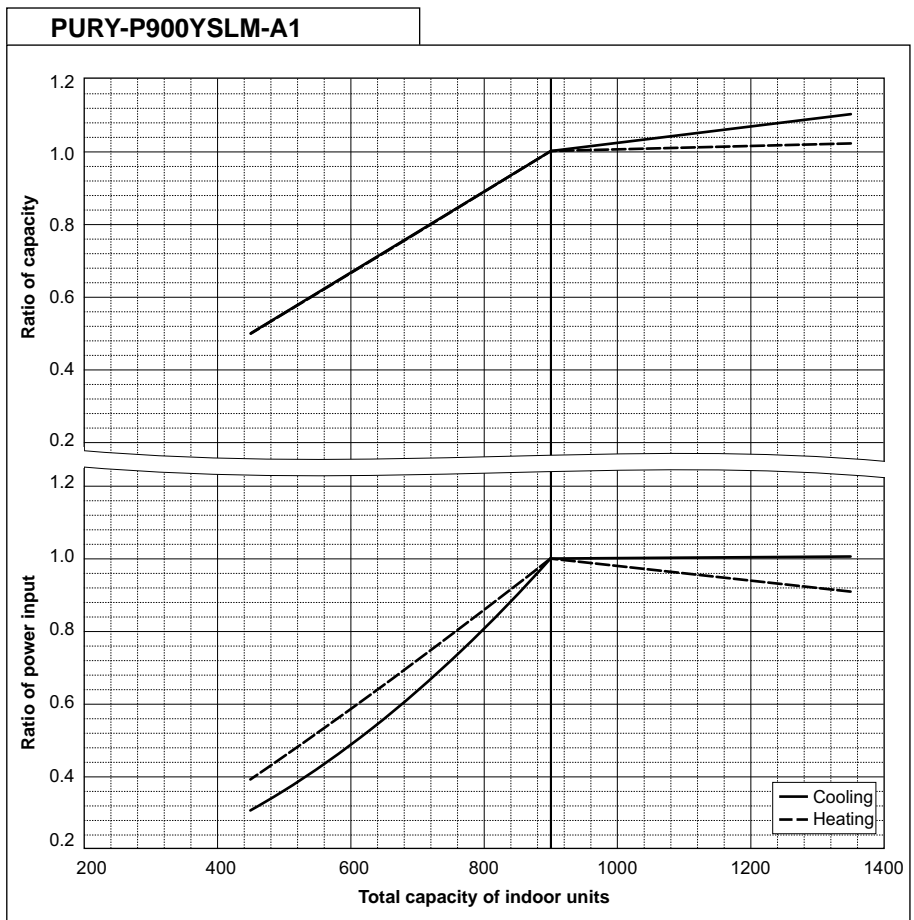

8-4. Correction by refrigerant piping length

CITY MULTI system can extend the piping flexibly within its limitation for the actual situation. However, a decrease of cooling/heating capacity could happen correspondently. Using following correction factor according to the equivalent length of the piping shown at 8-4-1 and 8-4-2, the capacity can be observed. 8-4-3 shows how to obtain the equivalent length of piping.

8-4-1. Cooling capacity correction

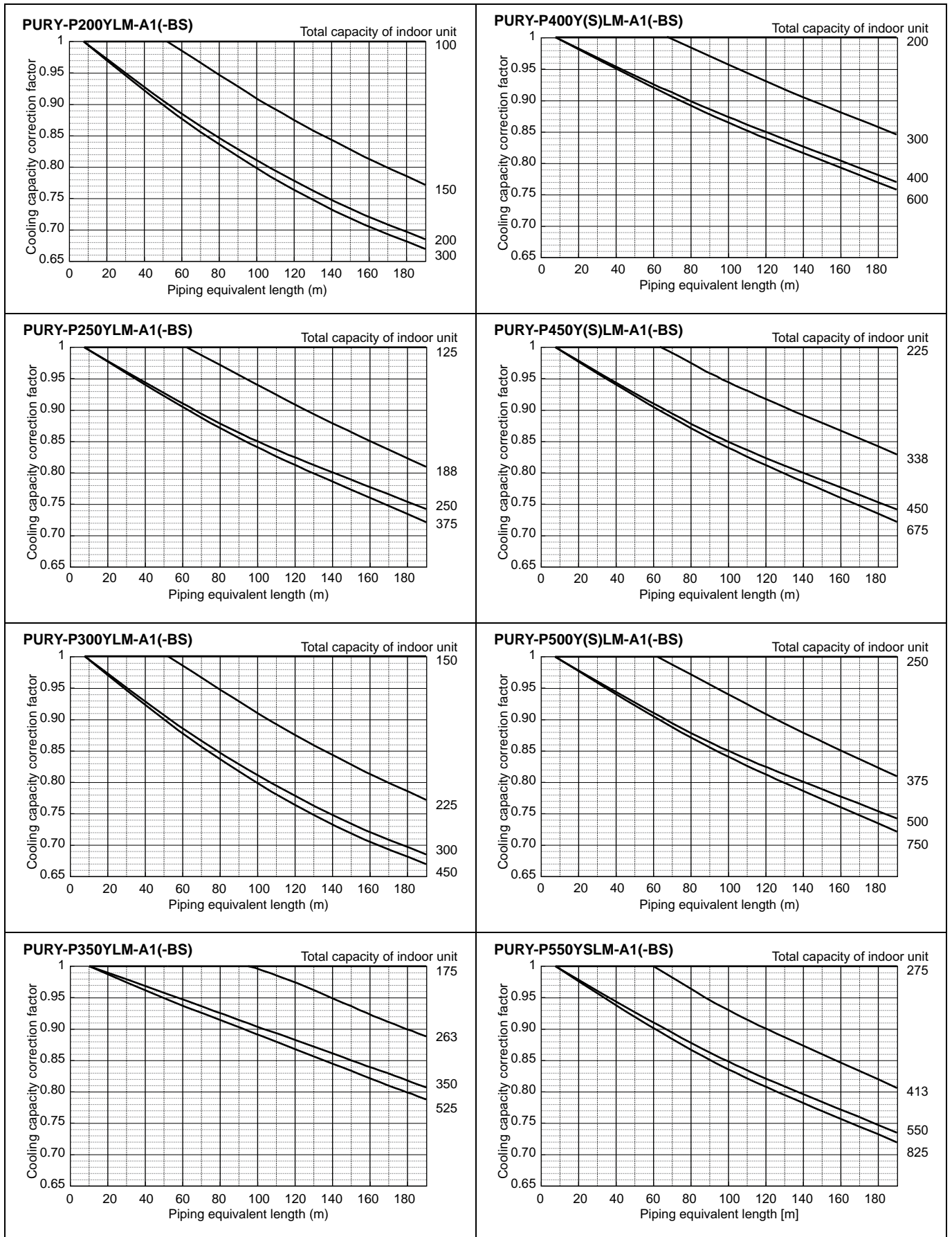

R2

8. CAPACITY TABLES

YKB/YLM

R2

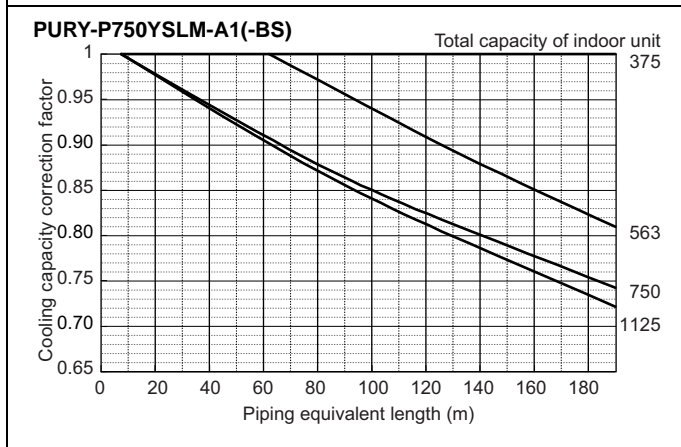
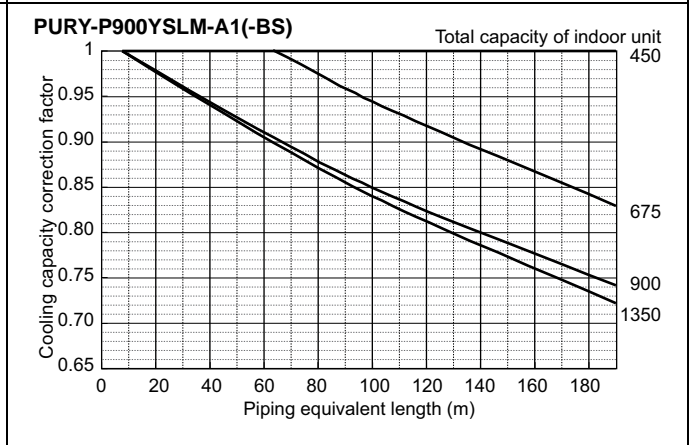
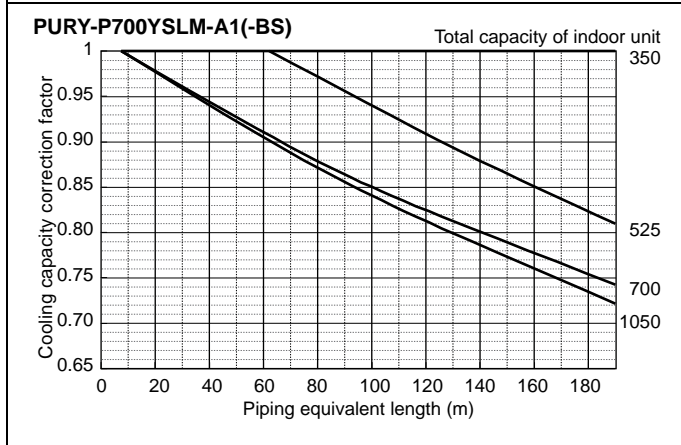
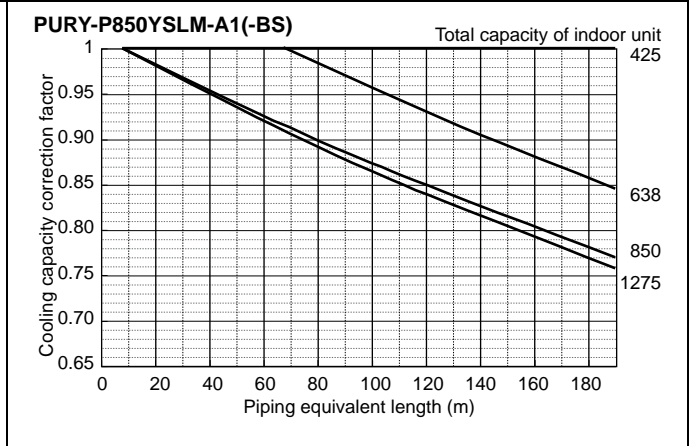
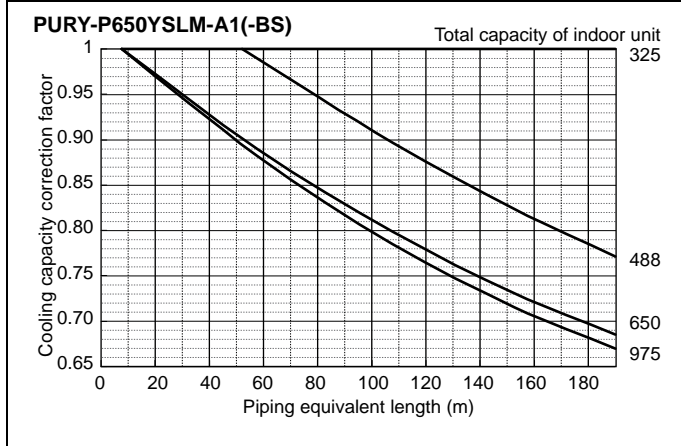
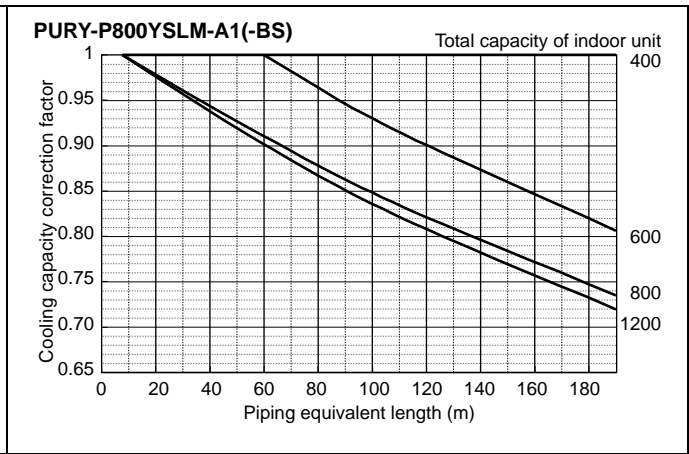
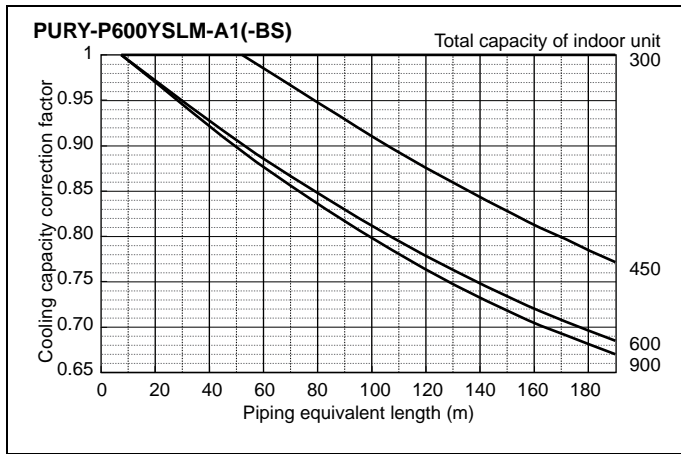

8-4-2. Heating capacity correction

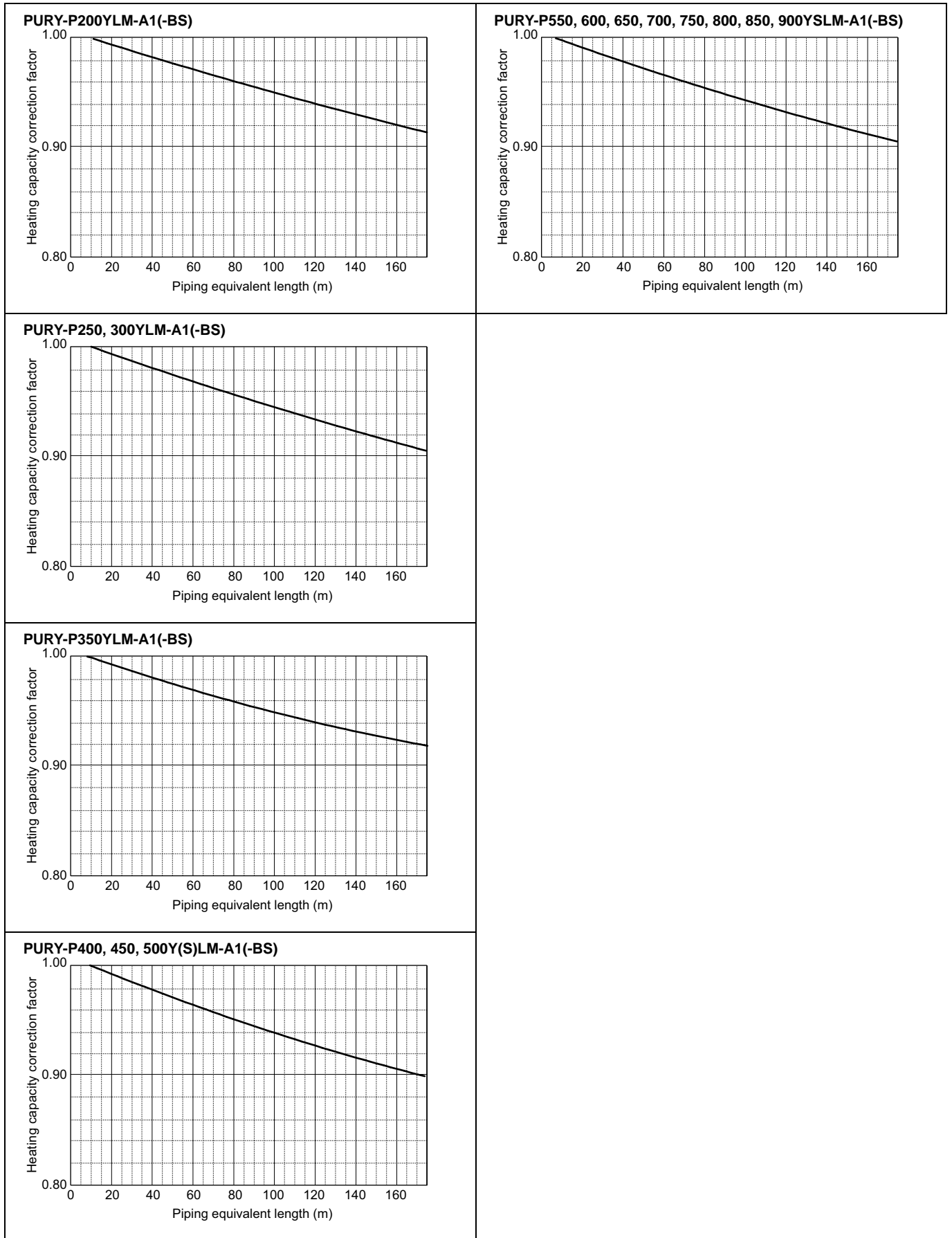

R2

8-4-3. How to obtain the equivalent piping length

- 1 **PURY-P200YLM-A1(-BS)**
Equivalent length = (Actual piping length to the farthest indoor unit) + (0.35 x number of bends in the piping) m
- 2 **PURY-P250, 300YLM-A1(-BS)**
Equivalent length = (Actual piping length to the farthest indoor unit) + (0.42 x number of bends in the piping) m
- 3 **PURY-P350YLM-A1(-BS)**
Equivalent length = (Actual piping length to the farthest indoor unit) + (0.47 x number of bends in the piping) m
- 4 **PURY-P400, 450, 500, 550, 600, 650Y(S)LM-A1(-BS)**
Equivalent length = (Actual piping length to the farthest indoor unit) + (0.50 x number of bends in the piping) m
- 5 **PURY-P700, 750, 800YSLM-A1(-BS)**
Equivalent length = (Actual piping length to the farthest indoor unit) + (0.70 x number of bends in the piping) m
- 6 **PURY-P850, 900YSLM-A1(-BS)**
Equivalent length = (Actual piping length to the farthest indoor unit) + (0.80 x number of bends in the piping) m

8-5. Correction by port counts of the BC controller

Indoor unit sizes P200 and P250 must be connected to 2 ports on the BC controller.

Indoor unit sizes from P100 to P140 should normally be connected to 2 ports on the BC controller (set BC controller DIP-SW 4-6 to its ON position).

In cases whereby indoor unit sizes from P100 to P140 are connected to only 1port on the BC controller (set BC controller DIP-SW 4-6 to its OFF position), the cooling capacity of the indoor unit should be multiplied by a correction factor of **0.97**.

8-6. Correction at frost and defrost

Due to frost at the outdoor heat exchanger and the automatic defrost operation, the heating capacity of the outdoor unit can be calculated by multiplying the correction factor shown in the table below.

Table of correction factor at frosting and defrosting

Outdoor inlet air temp. °C	6	4	2	1	0	-2	-4	-6	-8	-10	-20
Outdoor inlet air temp. °F	43	39	36	34	32	28	25	21	18	14	-4
PURY-P200YLM-A1(-BS)	1.00	0.95	0.84	0.83	0.83	0.87	0.90	0.95	0.95	0.95	0.95
PURY-P250YLM-A1(-BS)	1.00	0.95	0.84	0.83	0.83	0.87	0.90	0.95	0.95	0.95	0.95
PURY-P300YLM-A1(-BS)	1.00	0.93	0.82	0.80	0.82	0.86	0.90	0.90	0.95	0.95	0.95
PURY-P350YLM-A1(-BS)	1.00	0.93	0.85	0.83	0.84	0.86	0.90	0.90	0.95	0.95	0.95
PURY-P400Y(S)LM-A1(-BS)	1.00	0.95	0.90	0.87	0.88	0.89	0.90	0.95	0.95	0.95	0.95
PURY-P450Y(S)LM-A1(-BS)	1.00	0.98	0.89	0.87	0.89	0.90	0.92	0.95	0.95	0.95	0.95
PURY-P500Y(S)LM-A1(-BS)	1.00	0.98	0.89	0.86	0.89	0.90	0.92	0.95	0.95	0.95	0.95
PURY-P550YSLM-A1(-BS)	1.00	0.94	0.87	0.86	0.87	0.88	0.90	0.90	0.93	0.93	0.93
PURY-P600YSLM-A1(-BS)	1.00	0.94	0.84	0.86	0.87	0.88	0.90	0.90	0.93	0.93	0.93
PURY-P650YSLM-A1(-BS)	1.00	0.94	0.84	0.86	0.87	0.88	0.90	0.90	0.93	0.93	0.93
PURY-P700YSLM-A1(-BS)	1.00	0.98	0.89	0.88	0.89	0.90	0.92	0.95	0.95	0.95	0.95
PURY-P750YSLM-A1(-BS)	1.00	0.98	0.89	0.88	0.89	0.90	0.92	0.95	0.95	0.95	0.95
PURY-P800YSLM-A1(-BS)	1.00	0.98	0.89	0.88	0.89	0.90	0.92	0.95	0.95	0.95	0.95
PURY-P850YSLM-A1(-BS)	1.00	0.98	0.89	0.88	0.89	0.90	0.92	0.95	0.95	0.95	0.95
PURY-P900YSLM-A1(-BS)	1.00	0.98	0.89	0.88	0.89	0.90	0.92	0.95	0.95	0.95	0.95

9-1. JOINT

CITY MULTI units can be easily connected by using Joint sets and Header sets provided by Mitsubishi Electric. Three kinds of Joint sets are available for use. Refer to section 3 in "System Design" or the Installation Manual that comes with the Joint set for how to install the Joint set.

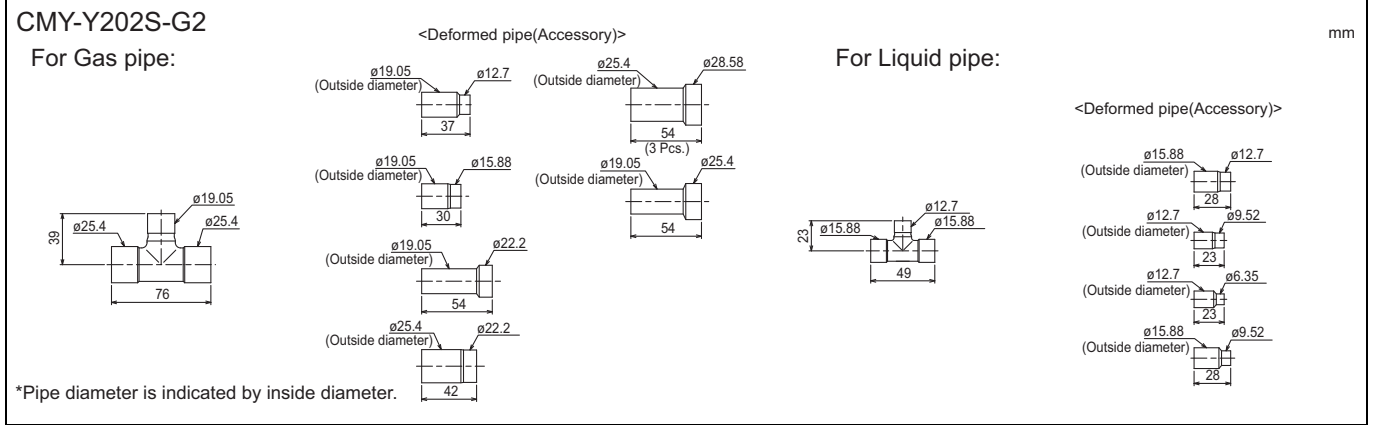
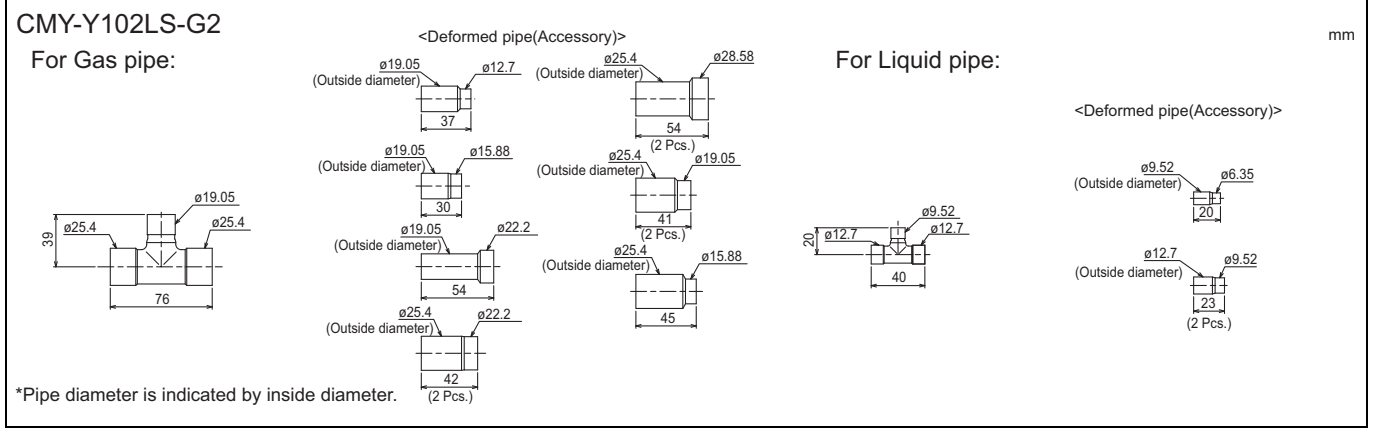
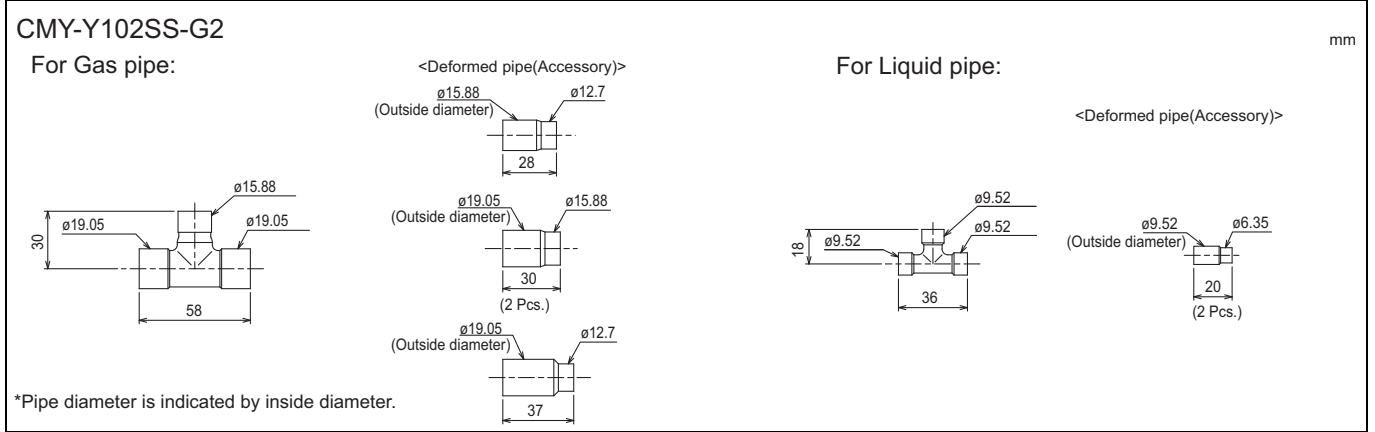

9-2. OUTDOOR TWINNING KIT

The following optional Outdoor Twinning Kit is needed to use to combine multiple refrigerant pipes. Refer to the chapter entitled System Design Section for the details of selecting a proper twinning kit.

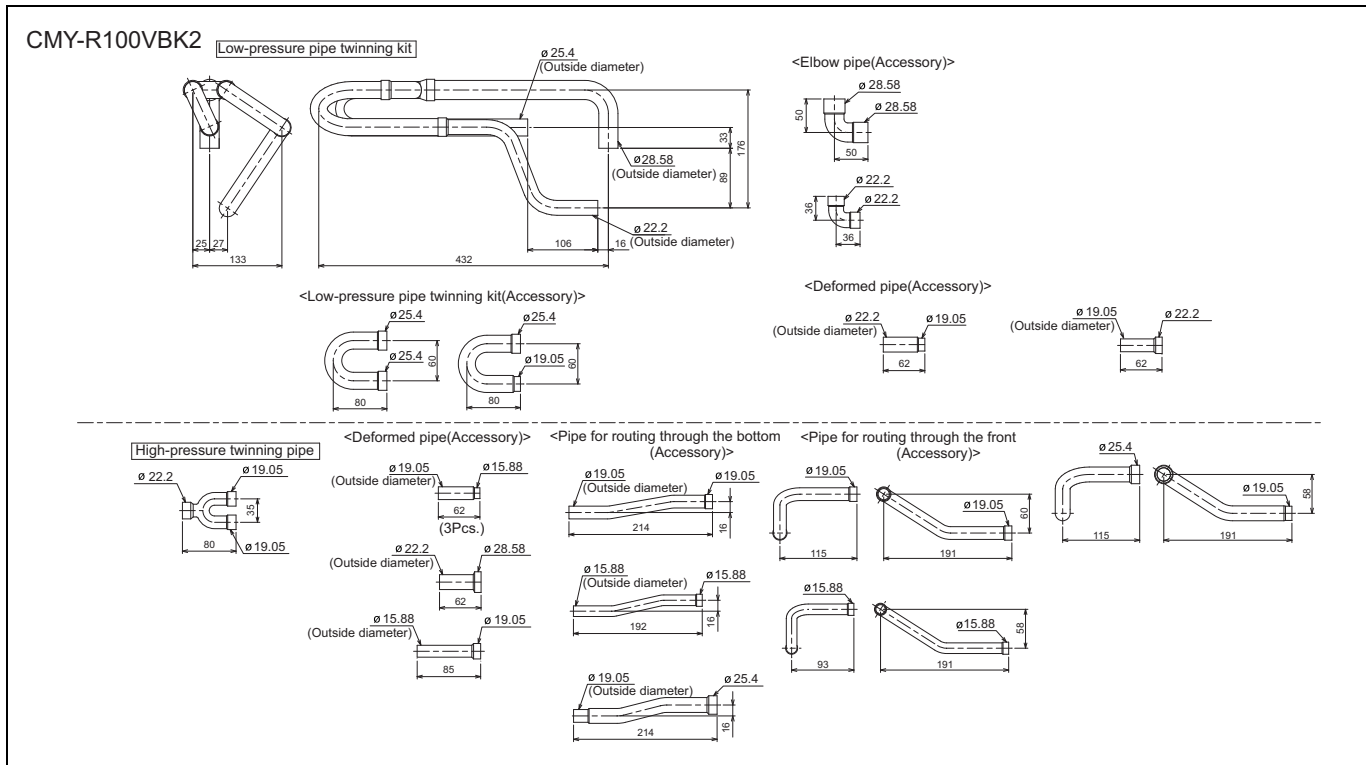
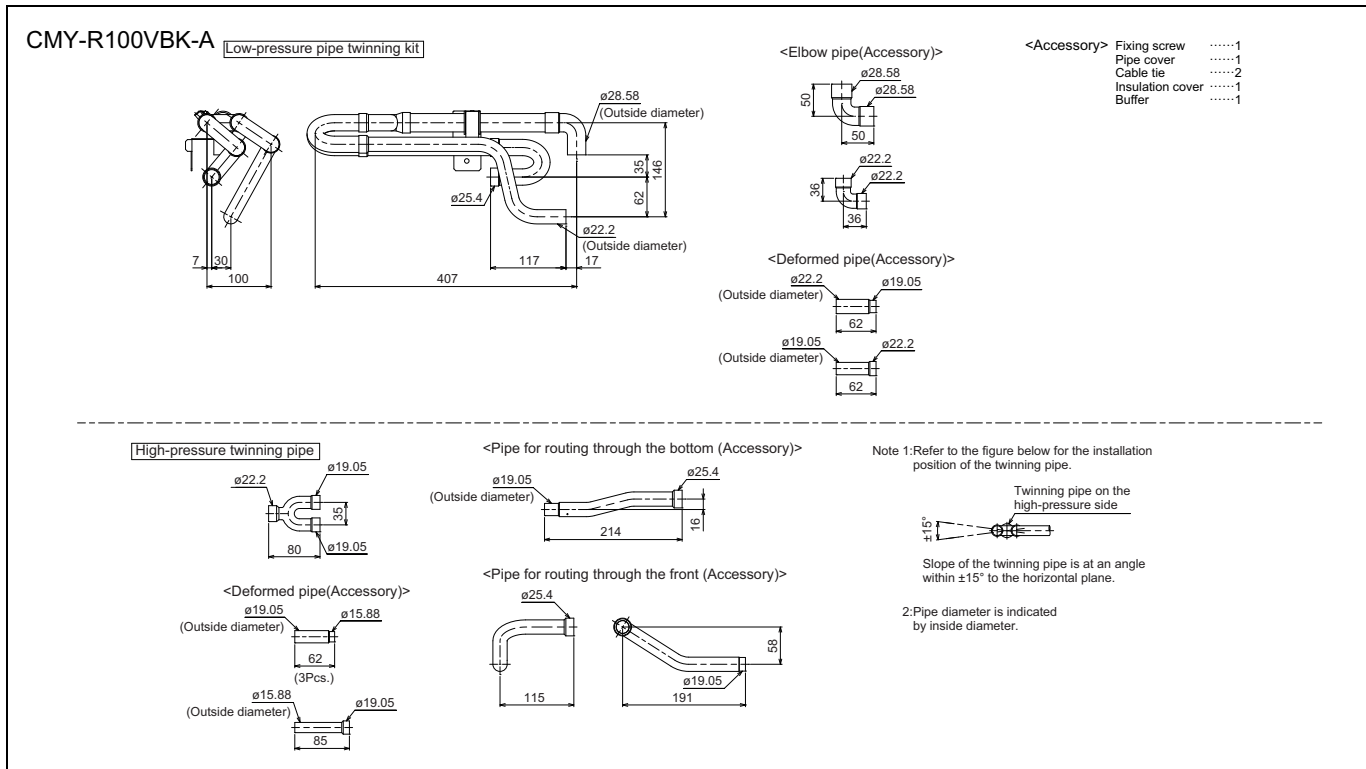

Note 1. Refer to the figure below for the installation position of the twinning pipe.

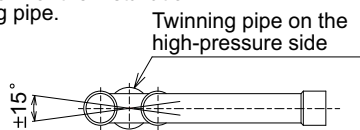

Slope of the twinning pipe is at an angle within $\pm 15^\circ$ to the horizontal plane.

2. Use the attached pipe to braze the port-opening of the distributor.
3. Pipe diameter is indicated by inside diameter.
4. Only use the Twinning pipe by Mitsubishi (optional parts).

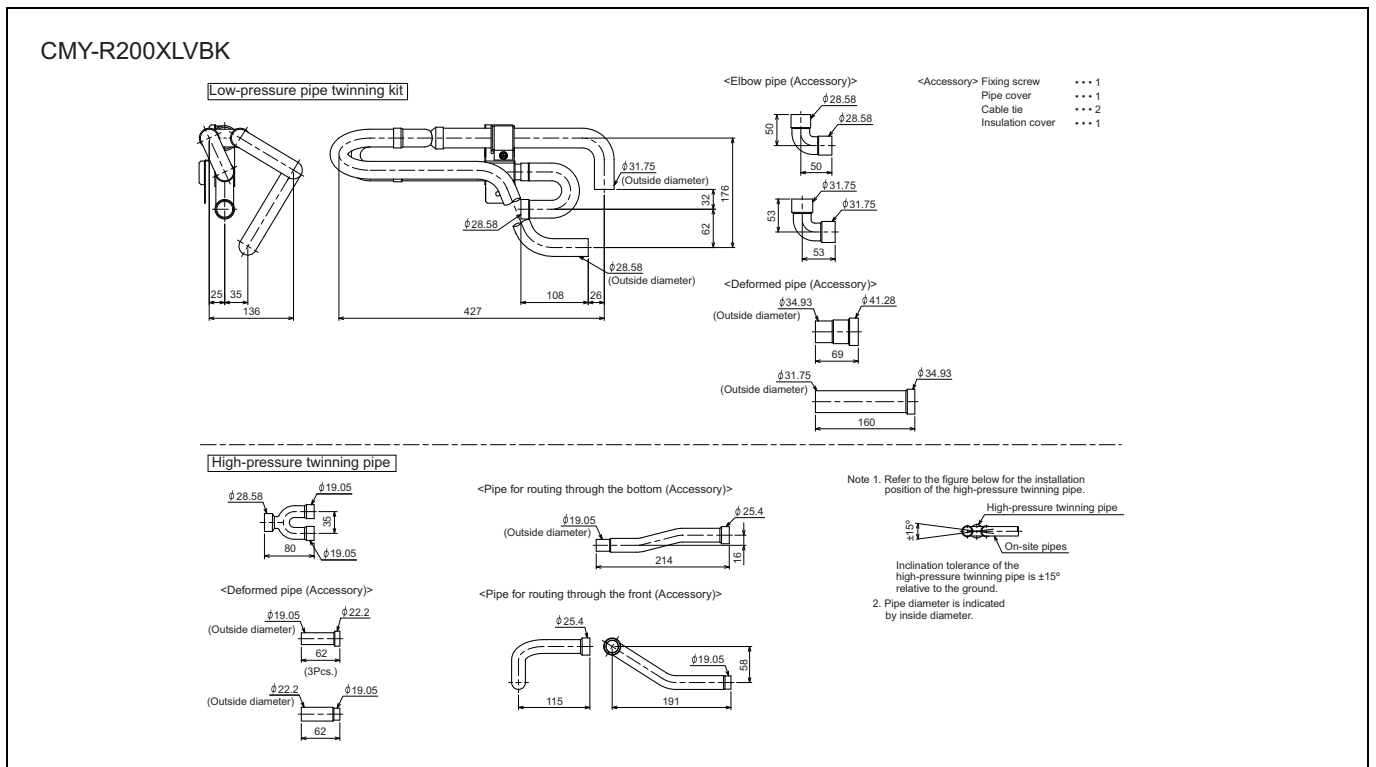
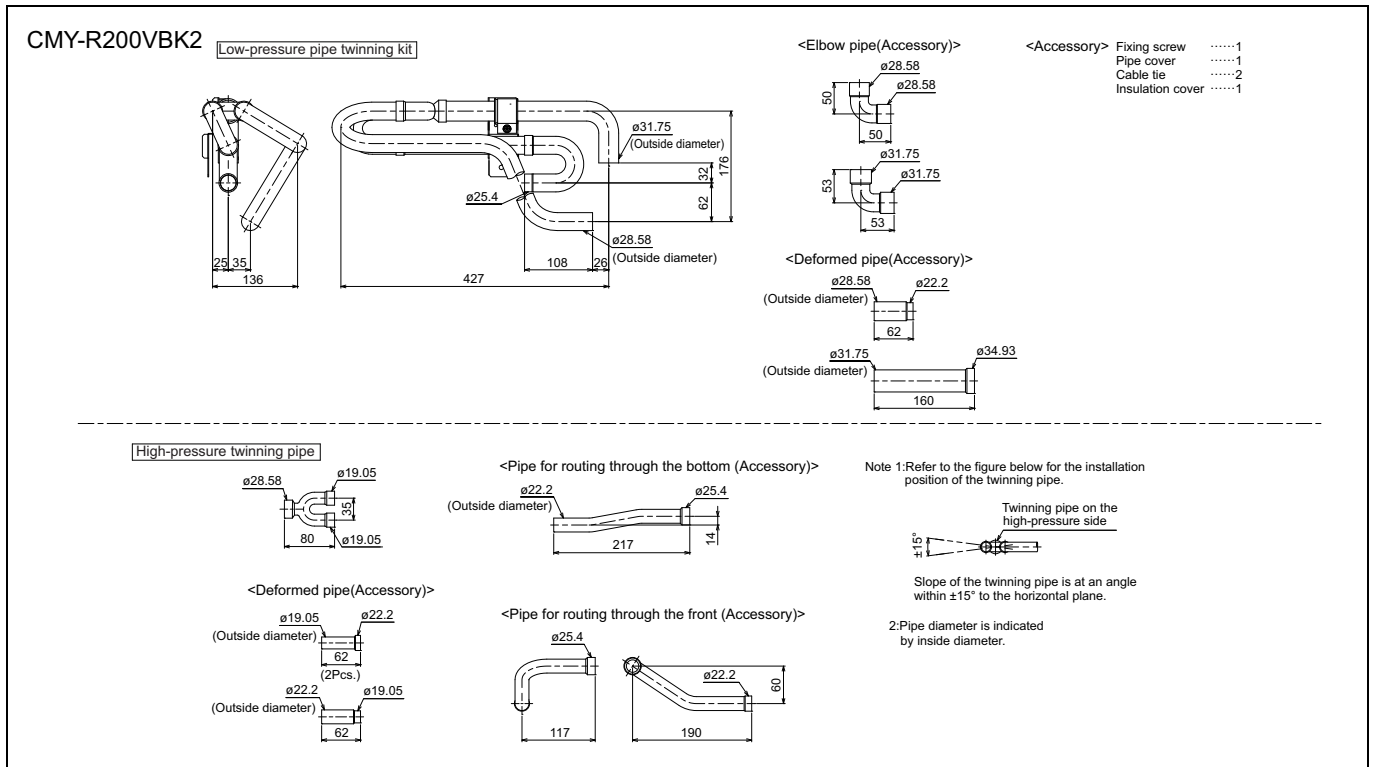

Note 1. Refer to the figure below for the installation position of the twinning pipe.

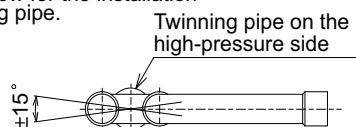

Slope of the twinning pipe is at an angle within $\pm 15^\circ$ to the horizontal plane.

2. Use the attached pipe to braze the port-opening of the distributor.
3. Pipe diameter is indicated by inside diameter.
4. Only use the Twinning pipe by Mitsubishi (optional parts) .

9-3. JOINT KIT "CMY-R160-J1" FOR BC CONTROLLER

Joint kit "CMY-R160-J1" for BC controller is used to combine 2 ports of the BC controller at a PURY-(E)P-Y(S)LM-A(1) system so as to enable down-stream Indoor capacity above P80 as shown in Fig. 1.

The Joint kit include following items:

① Instruction	② Joint pipe (Small)	③ Joint pipe (Large)	④ Cover 1	⑤ Cover 2	⑥ Cover 3	⑦ Band	⑧ Reducer 1	⑨ Reducer 2
This sheet 1pc	1pc	1pc	2pcs	1pc for gas side	1pc for liquid side	8pcs	OD19.05-ID22.2 1pc	OD19.05-ID15.88 1pc

Please prepare the following items in the field. ① Tape for insulation material sealing ② Extension pipe for refrigerant circuit

② Joint pipe (for liquid side)

③ Joint pipe (for gas side)

mm(in.)

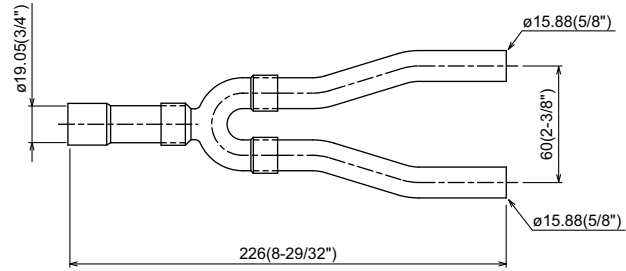
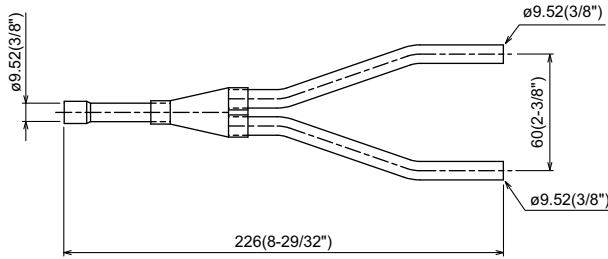

1. Designing CMY-R160-J1 to a PURY-(E)P-Y(S)LM-A(1) system

The maximum down-stream Indoor capacity for 1 port of BC controller is P80. When the down-stream Indoor capacity is above P80, Joint kit CMY-R160-J1 is needed to combined 2 ports of BC controller to enlarge the capacity, like Group 2 and 3 in Fig. 1.

Maximum 3 Indoor units are allowed to connect to 1 port of BC controller or 2 combined ports of BC controller using CMY-R160-J1.

When connecting Indoor units to 1 port of BC controller or 2 combined ports of BC controller using CMY-R160-J1 or CMY-Y102SS-G2 is applicable, like Group 1 and 2 in Fig. 1

Caution: Mixed cooling and heating mode at the same time for Indoor units connecting to 1 port or 2 combined ports is not available.

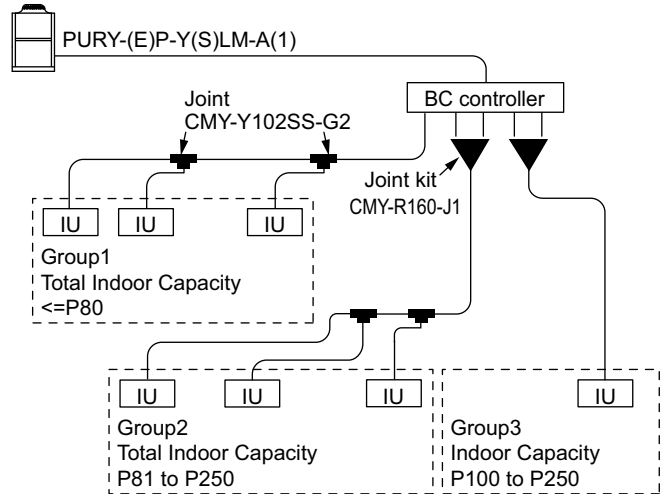

Fig.1. CMY-R160-J1 applying scheme

2. Piping at the installation site

The connection of CMY-R160-J1 to BC controller and pipe leading to Indoor units is referable to Fig. 2. Non-oxidized brazing is necessary. All piping must be careful to avoid foreign material getting inside.

After piping and air-tight testing, insulation work to the Joint and pipe should be done. Details is available at the Installation Manual.

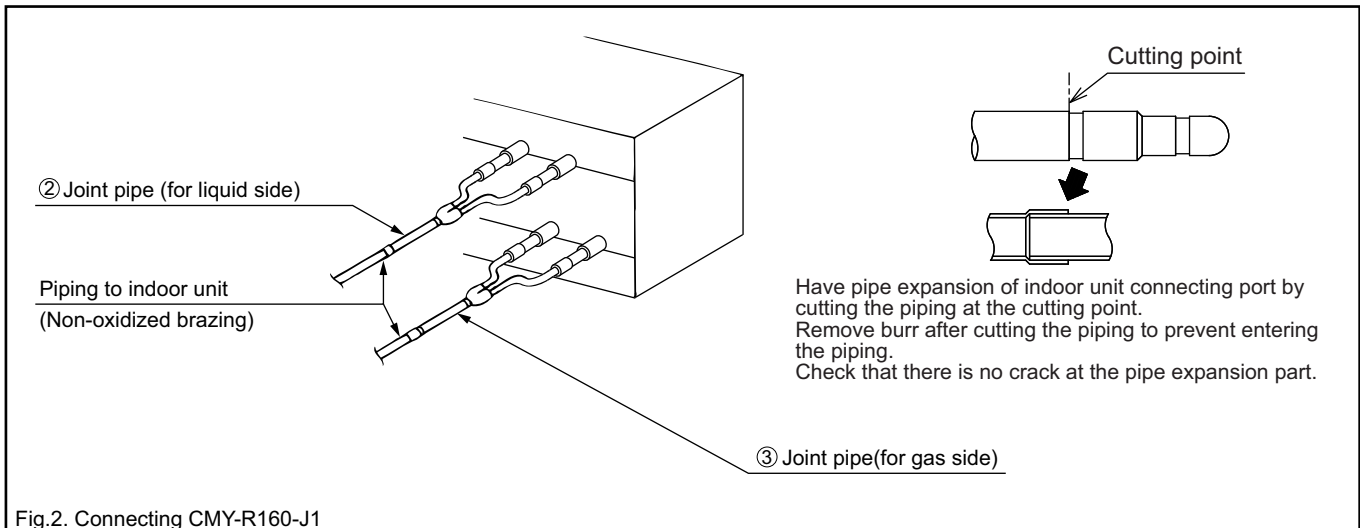
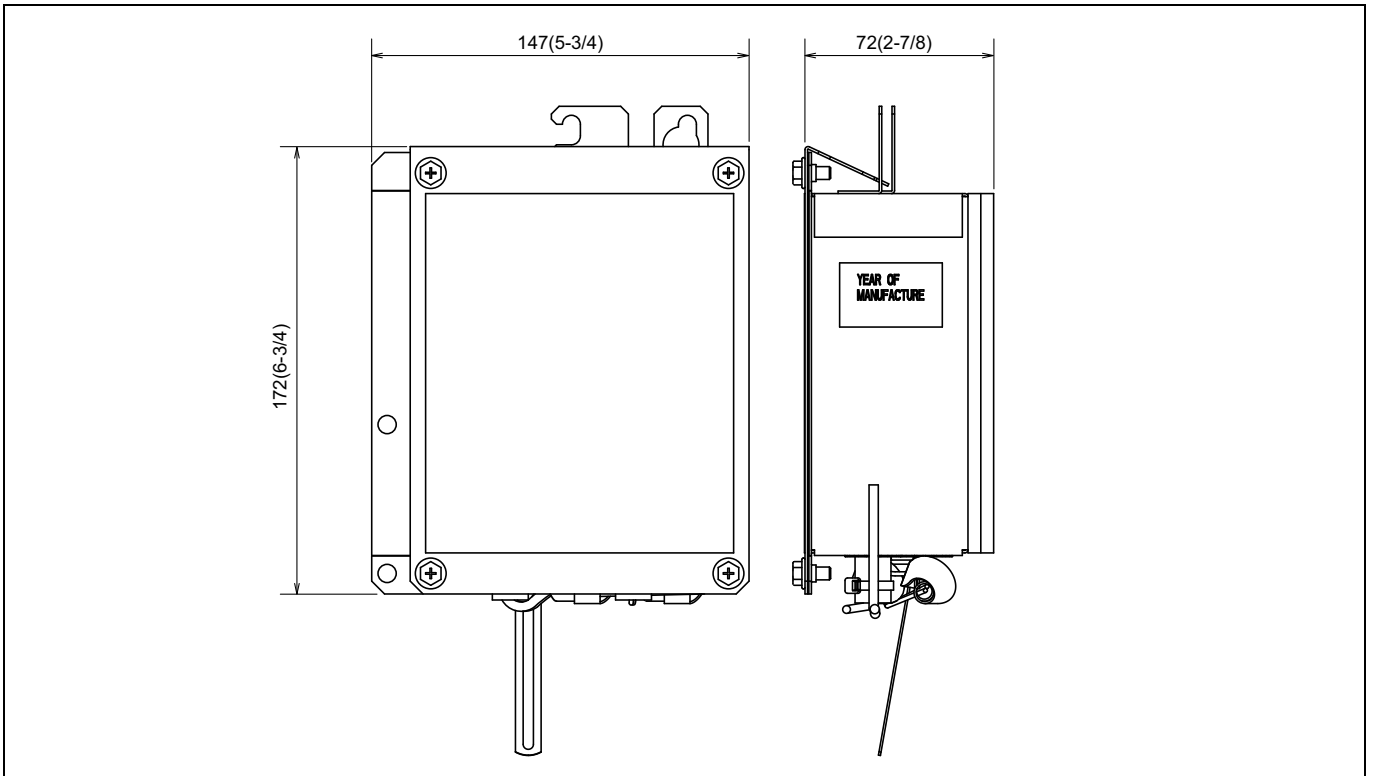

Fig.2. Connecting CMY-R160-J1

9-4. RELAY BOX

If there is a risk that the drain water will freeze inside the outdoor unit, the installation of a base heater is recommended. PAC-BH02KTY-E is a relay box for controlling the electric base heater. For details, refer to the relay box Installation Manual.



R2

9-5. BASE HEATER

If there is a risk that the drain water will freeze inside the outdoor unit, the installation of a base heater is recommended. For details, refer to the base heater Installation Manual.

R2

PAC-BH04EHT-E (for S module)

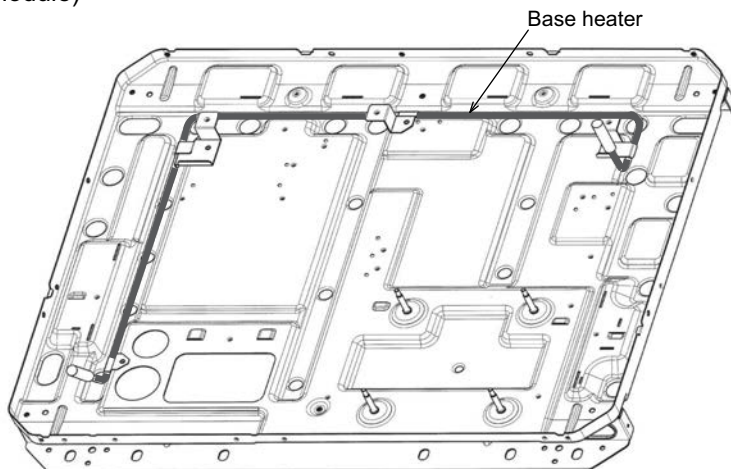

PAC-BH05EHT-E (for L module)

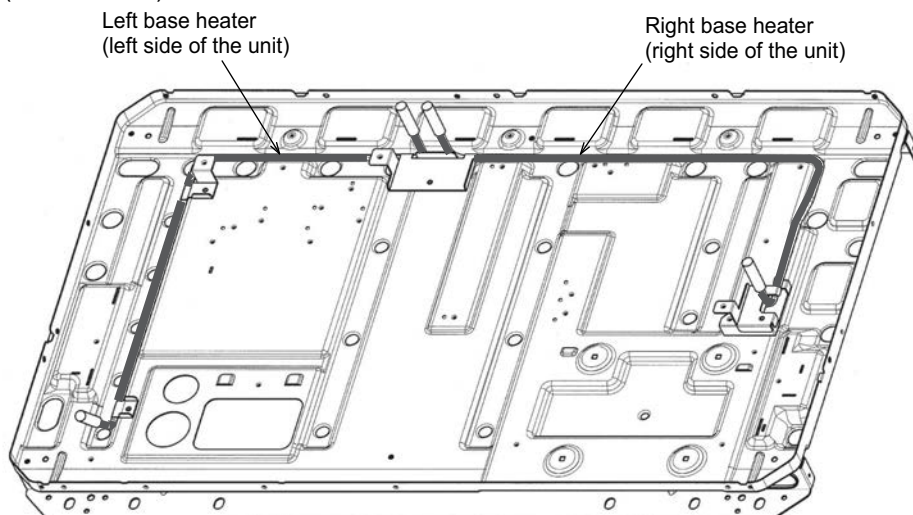

PAC-BH06EHT-E (for XL module)

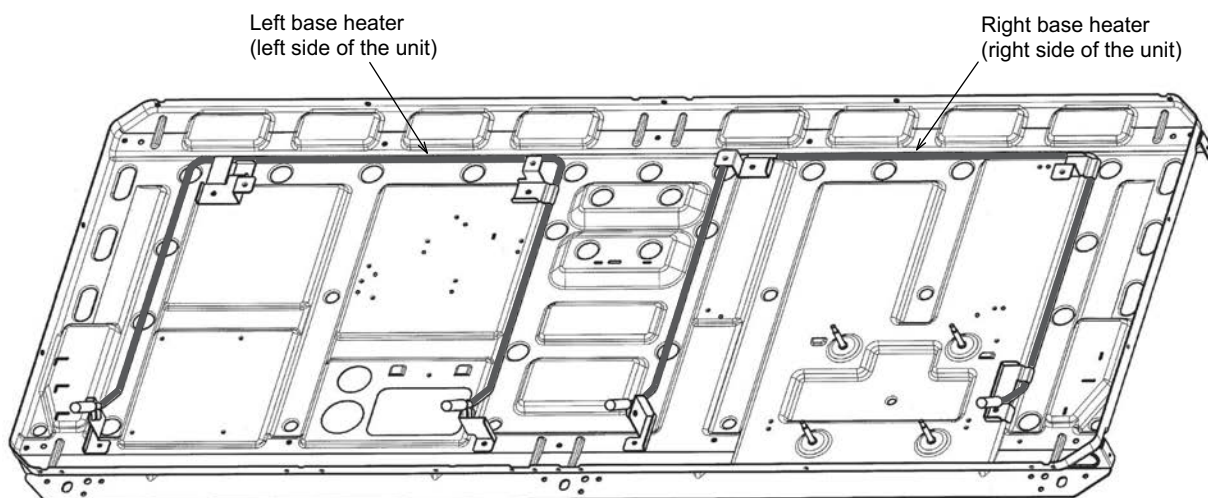

OUTDOOR UNITS

1. SPECIFICATIONS	2 - 294
2. EXTERNAL DIMENSIONS	2 - 306
3. CENTER OF GRAVITY	2 - 316
4. ELECTRICAL WIRING DIAGRAMS	2 - 317
5. SOUND LEVELS	2 - 320
6. VIBRATION LEVEL	2 - 325
7. OPERATION TEMPERATURE RANGE	2 - 326
8. CAPACITY TABLES	2 - 327
8-1. Selection of Cooling/Heating Units	2 - 328
8-2. Correction by temperature	2 - 330
8-3. Correction by total indoor	2 - 350
8-4. Correction by refrigerant piping length	2 - 358
8-5. Correction by port counts of the BC controller	2 - 361
8-6. Correction at frost and defrost	2 - 361
9. OPTIONAL PARTS	2 - 362
9-1. JOINT	2 - 362
9-2. OUTDOOR TWINNING KIT	2 - 363
9-3. JOINT KIT CMY-R160-J1 FOR BC CONTROLLER	2 - 364
9-4. RELAY BOX	2 - 365
9-5. BASE HEATER	2 - 366

1. SPECIFICATIONS

YKB/YLM

R2 (HIGH COP)

Model			PURY-EP200YLM-A (-BS)	PURY-EP250YLM-A (-BS)	
Power source			3-phase 4-wire 380-400-415 V 50/60 Hz		
Cooling capacity (Nominal)	*1	kW	22.4	28.0	
		kcal/h	20,000	25,000	
		BTU/h	76,400	95,500	
	*1	Power input	kW	5.48	7.25
		Current input	A	9.2-8.7-8.4	12.2-11.6-11.2
		EER	kW/kW	4.08	3.86
Temp. range of cooling	*3	Indoor	W.B.	15.0~24.0°C (59~75°F)	15.0~24.0°C (59~75°F)
		Outdoor	D.B.	-5.0~46.0°C (23~115°F)	-5.0~46.0°C (23~115°F)
Heating capacity (Nominal)	*2	kW	25.0	31.5	
		kcal/h	21,500	27,100	
		BTU/h	85,300	107,500	
	*2	Power input	kW	6.41	8.45
		Current input	A	10.8-10.2-9.9	14.2-13.5-13.0
		COP	kW/kW	3.90	3.72
Temp. range of heating	*3	Indoor	D.B.	15.0~27.0°C (59~81°F)	15.0~27.0°C (59~81°F)
		Outdoor	W.B.	-20.0~15.5°C (-4~60°F)	-20.0~15.5°C (-4~60°F)
Indoor unit connectable	Total capacity		50~150%	50~150% of outdoor unit capacity	
	Model/Quantity		P15-P250/1~20	P15-P250/1~25	
Sound pressure level (measured in anechoic room)		dB <A>	59	60	
Sound power level (measured in anechoic room)		dB <A>	82.5	83.5	
Refrigerant piping diameter	High pressure	mm (in.)	15.88 (5/8) Brazed	19.05 (3/4) Brazed	
	Low pressure	mm (in.)	19.05 (3/4) Brazed	22.2 (7/8) Brazed	
FAN	Type x Quantity		Propeller fan x 1		
	Air flow rate	m ³ /min	185	185	
		L/s	3,083	3,083	
		cfm	6,532	6,532	
	Control, Driving mechanism		Inverter-control, Direct-driven by motor		
	Motor output	kW	0.92 x 1	0.92 x 1	
*4	External static press.		0 Pa (0 mmH ₂ O)	0 Pa (0 mmH ₂ O)	
Compressor	Type x Quantity		Inverter scroll hermetic compressor		
	Manufacture		AC&R Works, MITSUBISHI ELECTRIC CORPORATION		
	Starting method		Inverter		
	Motor output	kW	5.6	6.9	
	Case heater	kW	- (- V)	- (- V)	
	Lubricant		MEL32		
External finish			Pre-coated galvanized steel sheets (+powder coating for -BS type) <MUNSELL 5Y 8/1 or similar>	Pre-coated galvanized steel sheets (+powder coating for -BS type) <MUNSELL 5Y 8/1 or similar>	
External dimension H x W x D		mm	1,710 (1,650 without legs) x 920 x 740	1,710 (1,650 without legs) x 920 x 740	
		in.	67-3/8 (65 without legs) x 36-1/4 x 29-3/16	67-3/8 (65 without legs) x 36-1/4 x 29-3/16	
Protection devices	High pressure protection		High pressure sensor, High pressure switch at 4.15 MPa (601 psi)	High pressure sensor, High pressure switch at 4.15 MPa (601 psi)	
	Inverter circuit (COMP./FAN)		Over-heat protection, Over-current protection	Over-heat protection, Over-current protection	
	Compressor		Over-heat protection	Over-heat protection	
	Fan motor		Over-current protection	Over-current protection	
Refrigerant	Type x original charge		R410A x 8.5 kg (19 lbs)	R410A x 8.5 kg (19 lbs)	
	Control		Indoor LEV and BC controller	Indoor LEV and BC controller	
Net weight		kg (lbs)	218 (481)	218 (481)	
Heat exchanger			Salt-resistant cross fin & aluminium tube		
HIC circuit (HIC: Heat Inter-Changer)			-		
Defrosting method			Auto-defrost mode (Reversed refrigerant cycle, Hot gas)		
Drawing	External		WKJ94L353	WKJ94L353	
	Wiring		WKE94C948	WKE94C948	
Standard attachment	Document		Installation Manual	Installation Manual	
	Accessory		Refrigerant conn. pipe	Refrigerant conn. pipe	
Optional parts			Joint: CMY-Y102SS-G2,CMY-Y102LS-G2,CMY-R160-J1 BC controller: CMB-P104,105,106,108,1010,1013,1016V-G1 Main BC controller: CMB-P108,1010,1013,1016V-GA1 Sub BC controller: CMB-P104,108V-GB1,CMB-P1016V-HB1	Joint: CMY-Y102SS-G2,CMY-Y102LS-G2,CMY-R160-J1 BC controller: CMB-P104,105,106,108,1010,1013,1016V-G1 Main BC controller: CMB-P108,1010,1013,1016V-GA1 Sub BC controller: CMB-P104,108V-GB1,CMB-P1016V-HB1	
Remarks			Details on foundation work, duct work, insulation work, electrical wiring, power source switch, and other items shall be referred to the Installation Manual. Due to continuing improvement, above specifications may be subject to change without notice.		

Notes:	Unit converter
1.Nominal cooling conditions (subject to JIS B8615-1) Indoor: 27°C D.B./19°C W.B. (81°F D.B./66°F W.B.), Outdoor: 35°C D.B./24°C W.B. (95°F D.B./75°F W.B.) Pipe length: 7.5 m (24-9/16 ft.), Level difference: 0 m (0 ft.)	BTU/h =kW x 3,412
2.Nominal heating conditions (subject to JIS B8615-1) Indoor: 20°C D.B. (68°F D.B.), Outdoor: 7°C D.B./6°C W.B. (45°F D.B./43°F W.B.) Pipe length: 7.5 m (24-9/16 ft.), Level difference: 0 m (0 ft.)	cfm =m ³ /min x 35.31
3.-5°C D.B. (23°F D.B.)/-6°C W.B. (21°F W.B.) to 21°C D.B. (70°F D.B.)/15.5°C W.B. (60°F W.B.) with cooling/heating mixed operation.	lbs =kg/0.4536
4.External static pressure option is available (30 Pa, 60 Pa/3.1 mmH ₂ O, 6.1 mmH ₂ O).	*Above specification data is subject to rounding variation.

1. SPECIFICATIONS

YKB/YLM

R2 (HIGH COP)

Model			PURY-EP300YLM-A (-BS)	PURY-EP350YLM-A (-BS)	
Power source			3-phase 4-wire 380-400-415 V 50/60 Hz		
Cooling capacity (Nominal)	*1	kW	33.5	40.0	
		kcal/h	30,000	35,000	
		BTU/h	114,300	136,500	
	Power input	kW	9.20	12.57	
		Current input	A	15.5-14.7-14.2	21.2-20.1-19.4
EER		kW/kW	3.64	3.18	
Temp. range of cooling	*3	Indoor	W.B.	15.0~24.0°C (59~75°F)	15.0~24.0°C (59~75°F)
		Outdoor	D.B.	-5.0~46.0°C (23~115°F)	-5.0~46.0°C (23~115°F)
Heating capacity (Nominal)	*2	kW	37.5	45.0	
		kcal/h	32,300	40,000	
		BTU/h	128,000	153,500	
	Power input	kW	9.97	12.93	
		Current input	A	16.8-15.9-15.4	21.8-20.7-19.9
COP		kW/kW	3.76	3.48	
Temp. range of heating	*3	Indoor	D.B.	15.0~27.0°C (59~81°F)	15.0~27.0°C (59~81°F)
		Outdoor	W.B.	-20.0~15.5°C (-4~60°F)	-20.0~15.5°C (-4~60°F)
Indoor unit connectable	Total capacity		50~150% of outdoor unit capacity		
	Model/Quantity		P15~P250/1~30		
Sound pressure level (measured in anechoic room)		dB <A>	62.5	62.5	
Sound power level (measured in anechoic room)		dB <A>	86	86	
Refrigerant piping diameter	High pressure	mm (in.)	19.05 (3/4) Brazed	19.05 (3/4) Brazed	
	Low pressure	mm (in.)	22.2 (7/8) Brazed	28.58 (1-1/8) Brazed	
FAN	Type x Quantity		Propeller fan x 1		
	Air flow rate	m ³ /min	230	230	
		L/s	3,833	3,833	
		cfm	8,121	8,121	
	Control, Driving mechanism		Inverter-control, Direct-driven by motor		
Motor output	kW	0.92 x 1	0.92 x 1		
*4 External static press.		0 Pa (0 mmH ₂ O)			
Compressor	Type x Quantity		Inverter scroll hermetic compressor		
	Manufacture		AC&R Works, MITSUBISHI ELECTRIC CORPORATION		
	Starting method		Inverter		
	Motor output	kW	8.1	10.5	
	Case heater	kW	- (- V)	- (- V)	
	Lubricant		MEL32		
External finish			Pre-coated galvanized steel sheets (+powder coating for -BS type) <MUNSELL 5Y 8/1 or similar>		
External dimension H x W x D			mm 1,710 (1,650 without legs) x 1,220 x 740 in. 67-3/8 (65 without legs) x 48-1/16 x 29-3/16		
Protection devices	High pressure protection		High pressure sensor, High pressure switch at 4.15 MPa (601 psi)		
	Inverter circuit (COMP./FAN)		Over-heat protection, Over-current protection		
	Compressor		Over-heat protection		
	Fan motor		Over-current protection		
Refrigerant	Type x original charge		R410A x 9.3 kg (21 lbs)		
	Control		Indoor LEV and BC controller		
Net weight		kg (lbs)	260 (574)	260 (574)	
Heat exchanger			Salt-resistant cross fin & aluminium tube		
HIC circuit (HIC: Heat Inter-Changer)			-		
Defrosting method			Auto-defrost mode (Reversed refrigerant cycle, Hot gas)		
Drawing	External		WKJ94L356		
	Wiring		WKE94C948		
Standard attachment	Document		Installation Manual		
	Accessory		Refrigerant conn. pipe		
Optional parts			Joint: CMY-Y102SS-G2, CMY-Y102LS-G2, CMY-R160-J1 BC controller: CMB-P104,105,106,108,1010,1013,1016V-G1 Main BC controller: CMB-P108,1010,1013,1016V-GA1 Sub BC controller: CMB-P104,108V-GB1,CMB-P1016V-HB1		
Remarks			Details on foundation work, duct work, insulation work, electrical wiring, power source switch, and other items shall be referred to the Installation Manual. Due to continuing improvement, above specifications may be subject to change without notice.		

Notes:	Unit converter
1. Nominal cooling conditions (subject to JIS B8615-1) Indoor: 27°C D.B./19°C W.B. (81°F D.B./66°F W.B.), Outdoor: 35°C D.B./24°C W.B. (95°F D.B./75°F W.B.) Pipe length: 7.5 m (24-9/16 ft.), Level difference: 0 m (0 ft.)	BTU/h =kW x 3,412 cfm =m ³ /min x 35.31 lbs =kg/0.4536
2. Nominal heating conditions (subject to JIS B8615-1) Indoor: 20°C D.B. (68°F D.B.), Outdoor: 7°C D.B./6°C W.B. (45°F D.B./43°F W.B.) Pipe length: 7.5 m (24-9/16 ft.), Level difference: 0 m (0 ft.)	
3. 5°C D.B. (23°F D.B.)/-6°C W.B. (21°F W.B.) to 21°C D.B. (70°F D.B.)/15.5°C W.B. (60°F W.B.) with cooling/heating mixed operation.	
4. External static pressure option is available (30 Pa, 60 Pa/3.1 mmH ₂ O, 6.1 mmH ₂ O).	*Above specification data is subject to rounding variation.

1. SPECIFICATIONS

YKB/YLM

R2 (HIGH COP)

Model			PURY-EP400YLM-A (-BS)	PURY-EP450YLM-A (-BS)
Power source			3-phase 4-wire 380-400-415 V 50/60 Hz	
Cooling capacity (Nominal)	*1	kW	45.0	50.0
		kcal/h	40,000	45,000
		BTU/h	153,500	170,600
	Power input	kW	12.56	14.83
		A	21.2-20.1-19.4	25.0-23.7-22.9
EER	kW/kW	3.58	3.37	
Temp. range of cooling	*3 Indoor	W.B.	15.0~24.0°C (59~75°F)	15.0~24.0°C (59~75°F)
	Outdoor	D.B.	-5.0~46.0°C (23~115°F)	-5.0~46.0°C (23~115°F)
Heating capacity (Nominal)	*2	kW	50.0	56.0
		kcal/h	43,000	50,000
		BTU/h	170,600	191,100
	Power input	kW	13.40	15.86
		A	22.6-21.4-20.7	26.7-25.4-24.5
COP	kW/kW	3.73	3.53	
Temp. range of heating	*3 Indoor	D.B.	15.0~27.0°C (59~81°F)	15.0~27.0°C (59~81°F)
	Outdoor	W.B.	-20.0~15.5°C (-4~60°F)	-20.0~15.5°C (-4~60°F)
Indoor unit connectable	Total capacity	50~150% of outdoor unit capacity		50~150% of outdoor unit capacity
	Model/Quantity	P15~P250/1~40		P15~P250/1~45
Sound pressure level (measured in anechoic room)	dB <A>	62.5		62.5
Sound power level (measured in anechoic room)	dB <A>	86		86
Refrigerant piping diameter	High pressure	mm (in.)	22.2 (7/8) Brazed	22.2 (7/8) Brazed
	Low pressure	mm (in.)	28.58 (1-1/8) Brazed	28.58 (1-1/8) Brazed
FAN	Type x Quantity		Propeller fan x 2	Propeller fan x 2
	Air flow rate	m ³ /min	320	320
		L/s	5,333	5,333
		cfm	11,299	11,299
	Control, Driving mechanism		Inverter-control, Direct-driven by motor	Inverter-control, Direct-driven by motor
	Motor output	kW	0.92 x 2	0.92 x 2
*4 External static press.		0 Pa (0 mmH ₂ O)	0 Pa (0 mmH ₂ O)	
Compressor	Type x Quantity		Inverter scroll hermetic compressor	Inverter scroll hermetic compressor
	Manufacture		AC&R Works, MITSUBISHI ELECTRIC CORPORATION	AC&R Works, MITSUBISHI ELECTRIC CORPORATION
	Starting method		Inverter	Inverter
	Motor output	kW	10.9	12.4
	Case heater	kW	- (- V)	- (- V)
	Lubricant		MEL32	MEL32
External finish			Pre-coated galvanized steel sheets (+powder coating for -BS type) <MUNSELL 5Y 8/1 or similar>	Pre-coated galvanized steel sheets (+powder coating for -BS type) <MUNSELL 5Y 8/1 or similar>
External dimension H x W x D		mm	1,710 (1,650 without legs) x 1,750 x 740	1,710 (1,650 without legs) x 1,750 x 740
		in.	67-3/8 (65 without legs) x 68-15/16 x 29-3/16	67-3/8 (65 without legs) x 68-15/16 x 29-3/16
Protection devices	High pressure protection		High pressure sensor, High pressure switch at 4.15 MPa (601 psi)	High pressure sensor, High pressure switch at 4.15 MPa (601 psi)
	Inverter circuit (COMP./FAN)		Over-heat protection, Over-current protection	Over-heat protection, Over-current protection
	Compressor		Over-heat protection	Over-heat protection
	Fan motor		Over-current protection	Over-current protection
Refrigerant	Type x original charge		R410A x 11.8 kg (27 lbs)	R410A x 11.8 kg (27 lbs)
	Control		Indoor LEV and BC controller	Indoor LEV and BC controller
Net weight	kg (lbs)	338 (746)		338 (746)
Heat exchanger			Salt-resistant cross fin & aluminium tube	
HIC circuit (HIC: Heat Inter-Changer)			-	
Defrosting method			Auto-defrost mode (Reversed refrigerant cycle, Hot gas)	
Drawing	External		WKJ94L359	WKJ94L359
	Wiring		WKE94C949	WKE94C949
Standard attachment	Document		Installation Manual	Installation Manual
	Accessory		Refrigerant conn. pipe	Refrigerant conn. pipe
Optional parts			Joint: CMY-Y102SS-G2,CMY-Y102LS-G2,CMY-R160-J1 Main BC controller: CMB-P108,1010,1013,1016V-GA1 Sub BC controller: CMB-P104,108V-GB1,CMB-P1016V-HB1	Joint: CMY-Y102SS-G2,CMY-Y102LS-G2,CMY-R160-J1 Main BC controller: CMB-P108,1010,1013,1016V-GA1 Sub BC controller: CMB-P104,108V-GB1,CMB-P1016V-HB1
Remarks			Details on foundation work, duct work, insulation work, electrical wiring, power source switch, and other items shall be referred to the Installation Manual. Due to continuing improvement, above specifications may be subject to change without notice.	

Notes:	Unit converter
1.Nominal cooling conditions (subject to JIS B8615-1) Indoor: 27°C D.B./19°C W.B. (81°F D.B./66°F W.B.), Outdoor: 35°C D.B./24°C W.B. (95°F D.B./75°F W.B.) Pipe length: 7.5 m (24-9/16 ft.), Level difference: 0 m (0 ft.)	BTU/h =kW x 3,412
2.Nominal heating conditions (subject to JIS B8615-1) Indoor: 20°C D.B. (68°F D.B.), Outdoor: 7°C D.B./6°C W.B. (45°F D.B./43°F W.B.) Pipe length: 7.5 m (24-9/16 ft.), Level difference: 0 m (0 ft.)	cfm =m ³ /min x 35.31
3.-5°C D.B. (23°F D.B.)/-6°C W.B. (21°F W.B.) to 21°C D.B. (70°F D.B.)/15.5°C W.B. (60°F W.B.) with cooling/heating mixed operation.	lbs =kg/0.4536
4.External static pressure option is available (30 Pa, 60 Pa/3.1 mmH ₂ O, 6.1 mmH ₂ O).	*Above specification data is subject to rounding variation.

1. SPECIFICATIONS

YKB/YLM

R2 (HIGH COP)

Model		PURY-EP500YLM-A (-BS)		
Power source		3-phase 4-wire 380-400-415 V 50/60 Hz		
Cooling capacity (Nominal)	*1	kW	56.0	
		kcal/h	50,000	
	*1	BTU/h	191,100	
		Power input	kW	18.30
		Current input	A	30.8-29.3-28.2
		EER	kW/kW	3.06
Temp. range of cooling	*3	Indoor	W.B.	15.0~24.0°C (59~75°F)
		Outdoor	D.B.	-5.0~46.0°C (23~115°F)
Heating capacity (Nominal)	*2	kW	63.0	
		kcal/h	54,200	
	*2	BTU/h	215,000	
		Power input	kW	19.54
		Current input	A	32.9-31.3-30.2
		COP	kW/kW	3.22
Temp. range of heating	*3	Indoor	D.B.	15.0~27.0°C (59~81°F)
		Outdoor	W.B.	-20.0~15.5°C (-4~60°F)
Indoor unit connectable	Total capacity		50~150% of outdoor unit capacity	
	Model/Quantity		P15~P250/1~50	
Sound pressure level (measured in anechoic room)		dB <A>	63.5	
Sound power level (measured in anechoic room)		dB <A>	87	
Refrigerant piping diameter	High pressure		mm (in.)	22.2 (7/8) Brazed
	Low pressure		mm (in.)	28.58 (1-1/8) Brazed
FAN	Type x Quantity		Propeller fan x 2	
	Air flow rate	m ³ /min	380	
		L/s	6,333	
		cfm	13,418	
	Control, Driving mechanism		Inverter-control, Direct-driven by motor	
	Motor output		kW	0.92 x 2
*4 External static press.			0 Pa (0 mmH ₂ O)	
Compressor	Type x Quantity		Inverter scroll hermetic compressor	
	Manufacture		AC&R Works, MITSUBISHI ELECTRIC CORPORATION	
	Starting method		Inverter	
	Motor output		kW	13.4
	Case heater		kW	0.045 (240 V)
	Lubricant			MEL32
External finish		Pre-coated galvanized steel sheets (+powder coating for -BS type) <MUNSELL 5Y 8/1 or similar>		
External dimension H x W x D		mm	1,710 (1,650 without legs) x 1,750 x 740	
		in.	67-3/8 (65 without legs) x 68-15/16 x 29-3/16	
Protection devices	High pressure protection		High pressure sensor, High pressure switch at 4.15 MPa (601 psi)	
	Inverter circuit (COMP./FAN)		Over-heat protection, Over-current protection	
	Compressor		Over-heat protection	
	Fan motor		Over-current protection	
Refrigerant	Type x original charge		R410A x 11.8 kg (27 lbs)	
	Control		Indoor LEV and BC controller	
Net weight		kg (lbs)	351 (774)	
Heat exchanger		Salt-resistant cross fin & aluminium tube		
HIC circuit (HIC: Heat Inter-Changer)		-		
Defrosting method		Auto-defrost mode (Reversed refrigerant cycle, Hot gas)		
Drawing	External		WKJ94L359	
	Wiring		WKE94G003	
Standard attachment	Document		Installation Manual	
	Accessory		Refrigerant conn. pipe	
Optional parts		Joint: CMY-Y102SS-G2, CMY-Y102LS-G2, CMY-R160-J1 Main BC controller: CMB-P108, 1010, 1013, 1016V-GA1 Sub BC controller: CMB-P104, 108V-GB1, CMB-P1016V-HB1		
Remarks		Details on foundation work, duct work, insulation work, electrical wiring, power source switch, and other items shall be referred to the Installation Manual. Due to continuing improvement, above specifications may be subject to change without notice.		

Notes:	Unit converter
1. Nominal cooling conditions (subject to JIS B8615-1) Indoor: 27°C D.B./19°C W.B. (81°F D.B./66°F W.B.), Outdoor: 35°C D.B./24°C W.B. (95°F D.B./75°F W.B.) Pipe length: 7.5 m (24-9/16 ft.), Level difference: 0 m (0 ft.)	BTU/h = kW x 3,412 cfm = m ³ /min x 35.31 lbs = kg/0.4536
2. Nominal heating conditions (subject to JIS B8615-1) Indoor: 20°C D.B. (68°F D.B.), Outdoor: 7°C D.B./6°C W.B. (45°F D.B./43°F W.B.) Pipe length: 7.5 m (24-9/16 ft.), Level difference: 0 m (0 ft.)	
3. 5°C D.B. (23°F D.B.)/-6°C W.B. (21°F W.B.) to 21°C D.B. (70°F D.B.)/15.5°C W.B. (60°F W.B.) with cooling/heating mixed operation.	
4. External static pressure option is available (30 Pa, 60 Pa/3.1 mmH ₂ O, 6.1 mmH ₂ O).	*Above specification data is subject to rounding variation.

1. SPECIFICATIONS

YKB/YLM

R2 (HIGH COP)

Model			PURY-EP550YSLM-A (-BS)		
Power source			3-phase 4-wire 380-400-415 V 50/60 Hz		
Cooling capacity (Nominal)	*1	kW	63.0		
		kcal/h	54,200		
		BTU/h	215,000		
	Power input	kW	17.35		
		Current input	A	29.2-27.8-26.8	
EER		kW/kW	3.63		
Temp. range of cooling	*3	Indoor	W.B.	15.0~24.0°C (59~75°F)	
		Outdoor	D.B.	-5.0~46.0°C (23~115°F)	
Heating capacity (Nominal)	*2	kW	69.0		
		kcal/h	59,300		
		BTU/h	235,400		
	Power input	kW	18.44		
		Current input	A	31.1-29.5-28.5	
COP		kW/kW	3.74		
Temp. range of heating	*3	Indoor	D.B.	15.0~27.0°C (59~81°F)	
		Outdoor	W.B.	-20.0~15.5°C (-4~60°F)	
Indoor unit connectable	Total capacity		50~150% of outdoor unit capacity		
	Model/Quantity		P15~P250/2~50		
Sound pressure level (measured in anechoic room)		dB <A>	64.5		
Sound power level (measured in anechoic room)		dB <A>	88		
Refrigerant piping diameter	High pressure	mm (in.)	28.58 (1-1/8) Brazed		
	Low pressure	mm (in.)	28.58 (1-1/8) Brazed		
Set Model					

Model			PURY-EP250YLM-A (-BS)			PURY-EP300YLM-A (-BS)		
FAN	Type x Quantity		Propeller fan x 1			Propeller fan x 1		
	Air flow rate	m ³ /min	185			230		
		L/s	3,083			3,833		
		cfm	6,532			8,121		
	Control, Driving mechanism		Inverter-control, Direct-driven by motor			Inverter-control, Direct-driven by motor		
	Motor output	kW	0.92 x 1			0.92 x 1		
*4	External static press.		0 Pa (0 mmH ₂ O)			0 Pa (0 mmH ₂ O)		
Compressor	Type x Quantity		Inverter scroll hermetic compressor			Inverter scroll hermetic compressor		
	Manufacture		AC&R Works, MITSUBISHI ELECTRIC CORPORATION			AC&R Works, MITSUBISHI ELECTRIC CORPORATION		
	Starting method		Inverter			Inverter		
	Motor output	kW	6.9			8.1		
	Case heater	kW	- (- V)			- (- V)		
Lubricant		MEL32			MEL32			
External finish		Pre-coated galvanized steel sheets (+powder coating for -BS type) <MUNSELL 5Y 8/1 or similar>			Pre-coated galvanized steel sheets (+powder coating for -BS type) <MUNSELL 5Y 8/1 or similar>			
External dimension H x W x D		mm	1,710 (1,650 without legs) x 920 x 740			1,710 (1,650 without legs) x 1,220 x 740		
		in.	67-3/8 (65 without legs) x 36-1/4 x 29-3/16			67-3/8 (65 without legs) x 48-1/16 x 29-3/16		
Protection devices	High pressure protection		High pressure sensor, High pressure switch at 4.15 MPa (601 psi)			High pressure sensor, High pressure switch at 4.15 MPa (601 psi)		
	Inverter circuit (COMP./FAN)		Over-heat protection, Over-current protection			Over-heat protection, Over-current protection		
	Compressor		Over-heat protection			Over-heat protection		
	Fan motor		Over-current protection			Over-current protection		
Refrigerant	Type x original charge		R410A x 8.5 kg (19 lbs)			R410A x 9.3 kg (21 lbs)		
	Control		Indoor LEV and BC controller					
Net weight		kg (lbs)	218 (481)			260 (574)		
Heat exchanger		Salt-resistant cross fin & aluminium tube			Salt-resistant cross fin & aluminium tube			
HIC circuit (HIC: Heat Inter-Changer)								
Pipe between unit and distributor	High pressure	mm (in.)	19.05 (3/4) Brazed			19.05 (3/4) Brazed		
	Low pressure	mm (in.)	22.2 (7/8) Brazed					
Defrosting method		Auto-defrost mode (Reversed refrigerant cycle, Hot gas)						
Drawing	External		WKJ94L367					
	Wiring		WKE94C948			WKE94C948		
Standard attachment	Document		Installation Manual					
	Accessory		Refrigerant conn. pipe					
Optional parts		Outdoor Twinning kit: CMY-ER200VBK Joint: CMY-Y102SS-G2, CMY-Y102LS-G2, CMY-R160-J1 Main BC controller: CMB-P108, 1010, 1013, 1016V-GA1 Sub BC controller: CMB-P104, 108V-GB1, CMB-P1016V-HB1						
Remarks		Details on foundation work, duct work, insulation work, electrical wiring, power source switch, and other items shall be referred to the Installation Manual. Due to continuing improvement, above specifications may be subject to change without notice.						

Notes:		Unit converter	
1. Nominal cooling conditions (subject to JIS B8615-1) Indoor: 27°C D.B./19°C W.B. (81°F D.B./66°F W.B.), Outdoor: 35°C D.B./24°C W.B. (95°F D.B./75°F W.B.) Pipe length: 7.5 m (24-9/16 ft.), Level difference: 0 m (0 ft.)		BTU/h	=kW x 3,412
2. Nominal heating conditions (subject to JIS B8615-1) Indoor: 20°C D.B. (68°F D.B.), Outdoor: 7°C D.B./6°C W.B. (45°F D.B./43°F W.B.) Pipe length: 7.5 m (24-9/16 ft.), Level difference: 0 m (0 ft.)		cfm	=m ³ /min x 35.31
3. 5°C D.B. (23°F D.B.)/-6°C W.B. (21°F W.B.) to 21°C D.B. (70°F D.B.)/15.5°C W.B. (60°F W.B.) with cooling/heating mixed operation.		lbs	=kg/0.4536
4. External static pressure option is available (30 Pa, 60 Pa/3.1 mmH ₂ O, 6.1 mmH ₂ O).		*Above specification data is subject to rounding variation.	

1. SPECIFICATIONS

YKB/YLM

R2 (HIGH COP)

Model		PURY-EP600YSLM-A (-BS)		
Power source		3-phase 4-wire 380-400-415 V 50/60 Hz		
Cooling capacity (Nominal)	*1	kW	69.0	
		kcal/h	59,300	
		BTU/h	235,400	
		Power input	kW	19.54
		Current input	A	32.9-31.3-30.2
		EER	kW/kW	3.53
Temp. range of cooling	*3	Indoor	W.B.	15.0~24.0°C (59~75°F)
		Outdoor	D.B.	-5.0~46.0°C (23~115°F)
Heating capacity (Nominal)	*2	kW	76.5	
		kcal/h	65,800	
		BTU/h	261,000	
		Power input	kW	20.34
		Current input	A	34.3-32.6-31.4
		COP	kW/kW	3.76
Temp. range of heating	*3	Indoor	D.B.	15.0~27.0°C (59~81°F)
		Outdoor	W.B.	-20.0~15.5°C (-4~60°F)
Indoor unit connectable	Total capacity		50~150% of outdoor unit capacity	
	Model/Quantity		P15-P250/2-50	
Sound pressure level (measured in anechoic room)		dB <A>	65.5	
Sound power level (measured in anechoic room)		dB <A>	89	
Refrigerant piping diameter		High pressure	mm (in.)	28.58 (1-1/8) Brazed
		Low pressure	mm (in.)	28.58 (1-1/8) Brazed

Set Model

Model		PURY-EP300YLM-A (-BS)		PURY-EP300YLM-A (-BS)		
FAN	Type x Quantity		Propeller fan x 1		Propeller fan x 1	
	Air flow rate	m ³ /min	230		230	
		L/s	3,833		3,833	
		cfm	8,121		8,121	
	Control, Driving mechanism		Inverter-control, Direct-driven by motor		Inverter-control, Direct-driven by motor	
	*4	Motor output	kW	0.92 x 1		0.92 x 1
External static press.		0 Pa (0 mmH ₂ O)		0 Pa (0 mmH ₂ O)		
Compressor	Type x Quantity		Inverter scroll hermetic compressor		Inverter scroll hermetic compressor	
	Manufacture		AC&R Works, MITSUBISHI ELECTRIC CORPORATION		AC&R Works, MITSUBISHI ELECTRIC CORPORATION	
	Starting method		Inverter		Inverter	
	Motor output	kW	8.1		8.1	
	Case heater	kW	- (- V)		- (- V)	
	Lubricant		MEL32		MEL32	
External finish		Pre-coated galvanized steel sheets (+powder coating for -BS type) <MUNSELL 5Y 8/1 or similar>		Pre-coated galvanized steel sheets (+powder coating for -BS type) <MUNSELL 5Y 8/1 or similar>		
External dimension H x W x D		mm	1,710 (1,650 without legs) x 1,220 x 740		1,710 (1,650 without legs) x 1,220 x 740	
		in.	67-3/8 (65 without legs) x 48-1/16 x 29-3/16		67-3/8 (65 without legs) x 48-1/16 x 29-3/16	
Protection devices	High pressure protection		High pressure sensor, High pressure switch at 4.15 MPa (601 psi)		High pressure sensor, High pressure switch at 4.15 MPa (601 psi)	
	Inverter circuit (COMP./FAN)		Over-heat protection, Over-current protection		Over-heat protection, Over-current protection	
	Compressor		Over-heat protection		Over-heat protection	
	Fan motor		Over-current protection		Over-current protection	
Refrigerant	Type x original charge		R410A x 9.3 kg (21 lbs)		R410A x 9.3 kg (21 lbs)	
	Control		Indoor LEV and BC controller			
Net weight	kg (lbs)	260 (574)		260 (574)		
Heat exchanger			Salt-resistant cross fin & aluminium tube		Salt-resistant cross fin & aluminium tube	
HIC circuit (HIC: Heat Inter-Changer)		-				
Pipe between unit and distributor	High pressure	mm (in.)	19.05 (3/4) Brazed		19.05 (3/4)	
	Low pressure	mm (in.)	22.2 (7/8) Brazed		-	
Defrosting method		Auto-defrost mode (Reversed refrigerant cycle, Hot gas)				
Drawing	External	WKJ94L368				
	Wiring	WKE94C948		WKE94C948		
Standard attachment	Document	Installation Manual				
	Accessory	Refrigerant conn. pipe				
Optional parts		Outdoor Twinning kit: CMY-ER200VBK Joint: CMY-Y102SS-G2, CMY-Y102LS-G2, CMY-R160-J1 Main BC controller: CMB-P108, 1010, 1013, 1016V-GA1 Sub BC controller: CMB-P104, 108V-GB1, CMB-P1016V-HB1				
Remarks		Details on foundation work, duct work, insulation work, electrical wiring, power source switch, and other items shall be referred to the Installation Manual. Due to continuing improvement, above specifications may be subject to change without notice.				

Notes:

- Nominal cooling conditions (subject to JIS B8615-1)
Indoor: 27°C D.B./19°C W.B. (81°F D.B./66°F W.B.), Outdoor: 35°C D.B./24°C W.B. (95°F D.B./75°F W.B.)
Pipe length: 7.5 m (24-9/16 ft.), Level difference: 0 m (0 ft.)
- Nominal heating conditions (subject to JIS B8615-1)
Indoor: 20°C D.B. (68°F D.B.), Outdoor: 7°C D.B./6°C W.B. (45°F D.B./43°F W.B.)
Pipe length: 7.5 m (24-9/16 ft.), Level difference: 0 m (0 ft.)
- 5°C D.B. (23°F D.B.)/-6°C W.B. (21°F W.B.) to 21°C D.B. (70°F D.B.)/15.5°C W.B. (60°F W.B.)
with cooling/heating mixed operation.
- External static pressure option is available (30 Pa, 60 Pa/3.1 mmH₂O, 6.1 mmH₂O).

Unit converter	
BTU/h	=kW x 3,412
cfm	=m ³ /min x 35.31
lbs	=kg/0.4536
*Above specification data is subject to rounding variation.	

1. SPECIFICATIONS

YKB/YLM

R2 (HIGH COP)

Model			PURY-EP650YSLM-A (-BS)	
Power source			3-phase 4-wire 380-400-415 V 50/60 Hz	
Cooling capacity (Nominal)	*1	kW	73.0	
		kcal/h	62,800	
		BTU/h	249,100	
	Power input	kW	22.12	
		Current input	A	37.3-35.4-34.1
EER		kW/kW	3.30	
Temp. range of cooling	*3 Indoor	W.B.	15.0~24.0°C (59~75°F)	
	Outdoor	D.B.	-5.0~46.0°C (23~115°F)	
Heating capacity (Nominal)	*2	kW	81.5	
		kcal/h	70,100	
		BTU/h	278,100	
	Power input	kW	22.51	
		Current input	A	38.0-36.1-34.7
COP		kW/kW	3.62	
Temp. range of heating	*3 Indoor	D.B.	15.0~27.0°C (59~81°F)	
	Outdoor	W.B.	-20.0~15.5°C (-4~60°F)	
Indoor unit connectable	Total capacity		50~150% of outdoor unit capacity	
	Model/Quantity		P15~P250/2~50	
Sound pressure level (measured in anechoic room)			dB <A>	
Sound power level (measured in anechoic room)			dB <A>	
Refrigerant			High pressure	
piping diameter			Low pressure	

Set Model			PURY-EP300YLM-A (-BS)		PURY-EP350YLM-A (-BS)	
FAN	Type x Quantity		Propeller fan x 1		Propeller fan x 1	
	Air flow rate	m ³ /min	230		230	
		L/s	3,833		3,833	
		cfm	8,121		8,121	
	Control, Driving mechanism		Inverter-control, Direct-driven by motor		Inverter-control, Direct-driven by motor	
*4 Motor output	kW	0.92 x 1		0.92 x 1		
External static press.		0 Pa (0 mmH ₂ O)		0 Pa (0 mmH ₂ O)		
Compressor	Type x Quantity		Inverter scroll hermetic compressor		Inverter scroll hermetic compressor	
	Manufacture		AC&R Works, MITSUBISHI ELECTRIC CORPORATION		AC&R Works, MITSUBISHI ELECTRIC CORPORATION	
	Starting method		Inverter		Inverter	
	Motor output	kW	8.1		10.5	
	Case heater	kW	- (- V)		- (- V)	
	Lubricant		MEL32		MEL32	
External finish			Pre-coated galvanized steel sheets (+powder coating for -BS type) <MUNSELL 5Y 8/1 or similar>		Pre-coated galvanized steel sheets (+powder coating for -BS type) <MUNSELL 5Y 8/1 or similar>	
External dimension H x W x D			mm 1,710 (1,650 without legs) x 1,220 x 740 67-3/8 (65 without legs) x 48-1/16 x 29-3/16		mm 1,710 (1,650 without legs) x 1,220 x 740 67-3/8 (65 without legs) x 48-1/16 x 29-3/16	
Protection devices	High pressure protection		High pressure sensor, High pressure switch at 4.15 MPa (601 psi)		High pressure sensor, High pressure switch at 4.15 MPa (601 psi)	
	Inverter circuit (COMP./FAN)		Over-heat protection, Over-current protection		Over-heat protection, Over-current protection	
	Compressor		Over-heat protection		Over-heat protection	
	Fan motor		Over-current protection		Over-current protection	
Refrigerant	Type x original charge		R410A x 9.3 kg (21 lbs)		R410A x 9.3 kg (21 lbs)	
	Control		Indoor LEV and BC controller			
Net weight			kg (lbs)		260 (574)	
Heat exchanger			Salt-resistant cross fin & aluminium tube		Salt-resistant cross fin & aluminium tube	
HIC circuit (HIC: Heat Inter-Changer)			-			
Pipe between unit and distributor	High pressure	mm (in.)	19.05 (3/4) Brazed		19.05 (3/4) Brazed	
	Low pressure	mm (in.)	22.2 (7/8) Brazed		-	
Defrosting method			Auto-defrost mode (Reversed refrigerant cycle, Hot gas)			
Drawing	External		WKJ94L368			
	Wiring		WKE94C948		WKE94C948	
Standard attachment	Document		Installation Manual			
	Accessory		Refrigerant conn. pipe			
Optional parts			Outdoor Twinning kit: CMY-ER200VBK Joint: CMY-Y102SS-G2, CMY-Y102LS-G2, CMY-R160-J1 Main BC controller: CMB-P108, 1010, 1013, 1016V-GA1 Sub BC controller: CMB-P104, 108V-GB1, CMB-P1016V-HB1			
Remarks			Details on foundation work, duct work, insulation work, electrical wiring, power source switch, and other items shall be referred to the Installation Manual. Due to continuing improvement, above specifications may be subject to change without notice.			

Notes:	Unit converter
1. Nominal cooling conditions (subject to JIS B8615-1) Indoor: 27°C D.B./19°C W.B. (81°F D.B./66°F W.B.), Outdoor: 35°C D.B./24°C W.B. (95°F D.B./75°F W.B.) Pipe length: 7.5 m (24-9/16 ft.), Level difference: 0 m (0 ft.)	BTU/h = kW x 3,412
2. Nominal heating conditions (subject to JIS B8615-1) Indoor: 20°C D.B. (68°F D.B.), Outdoor: 7°C D.B./6°C W.B. (45°F D.B./43°F W.B.) Pipe length: 7.5 m (24-9/16 ft.), Level difference: 0 m (0 ft.)	cfm = m ³ /min x 35.31
3. -5°C D.B. (23°F D.B.)/-6°C W.B. (21°F W.B.) to 21°C D.B. (70°F D.B.)/15.5°C W.B. (60°F W.B.) with cooling/heating mixed operation.	lbs = kg/0.4536
4. External static pressure option is available (30 Pa, 60 Pa/3.1 mmH ₂ O, 6.1 mmH ₂ O).	*Above specification data is subject to rounding variation.

1. SPECIFICATIONS

YKB/YLM

R2 (HIGH COP)

Model		PURY-EP700YSLM-A (-BS)		
Power source		3-phase 4-wire 380-400-415 V 50/60 Hz		
Cooling capacity (Nominal)	*1	kW	80.0	
		kcal/h	68,800	
		BTU/h	273,000	
		Power input	kW	25.97
		Current input	A	43.8-41.6-40.1
		EER	kW/kW	3.08
Temp. range of cooling	*3	Indoor	W.B.	15.0~24.0°C (59~75°F)
		Outdoor	D.B.	-5.0~46.0°C (23~115°F)
Heating capacity (Nominal)	*2	kW	88.0	
		kcal/h	75,700	
		BTU/h	300,300	
		Power input	kW	25.28
		Current input	A	42.6-40.5-39.0
		COP	kW/kW	3.48
Temp. range of heating	*3	Indoor	D.B.	15.0~27.0°C (59~81°F)
		Outdoor	W.B.	-20.0~15.5°C (-4~60°F)
Indoor unit connectable	Total capacity			50~150% of outdoor unit capacity
	Model/Quantity			P15-P250/2-50
Sound pressure level (measured in anechoic room)		dB <A>	65.5	
Sound power level (measured in anechoic room)		dB <A>	89	
Refrigerant piping diameter	High pressure		mm (in.)	28.58 (1-1/8) Brazed
	Low pressure		mm (in.)	34.93 (1-3/8) Brazed

Set Model

Model		PURY-EP350YLM-A (-BS)		PURY-EP350YLM-A (-BS)		
FAN	Type x Quantity		Propeller fan x 1		Propeller fan x 1	
	Air flow rate	m ³ /min	230		230	
		L/s	3,833		3,833	
		cfm	8,121		8,121	
	Control, Driving mechanism		Inverter-control, Direct-driven by motor		Inverter-control, Direct-driven by motor	
	*4	Motor output	kW	0.92 x 1		0.92 x 1
External static press.		0 Pa (0 mmH ₂ O)		0 Pa (0 mmH ₂ O)		
Compressor	Type x Quantity		Inverter scroll hermetic compressor		Inverter scroll hermetic compressor	
	Manufacture		AC&R Works, MITSUBISHI ELECTRIC CORPORATION		AC&R Works, MITSUBISHI ELECTRIC CORPORATION	
	Starting method		Inverter		Inverter	
	Motor output	kW	10.5		10.5	
	Case heater	kW	- (- V)		- (- V)	
	Lubricant		MEL32		MEL32	
External finish		Pre-coated galvanized steel sheets (+powder coating for -BS type) <MUNSELL 5Y 8/1 or similar>		Pre-coated galvanized steel sheets (+powder coating for -BS type) <MUNSELL 5Y 8/1 or similar>		
External dimension H x W x D		mm	1,710 (1,650 without legs) x 1,220 x 740		1,710 (1,650 without legs) x 1,220 x 740	
		in.	67-3/8 (65 without legs) x 48-1/16 x 29-3/16		67-3/8 (65 without legs) x 48-1/16 x 29-3/16	
Protection devices	High pressure protection		High pressure sensor, High pressure switch at 4.15 MPa (601 psi)		High pressure sensor, High pressure switch at 4.15 MPa (601 psi)	
	Inverter circuit (COMP./FAN)		Over-heat protection, Over-current protection		Over-heat protection, Over-current protection	
	Compressor		Over-heat protection		Over-heat protection	
	Fan motor		Over-current protection		Over-current protection	
Refrigerant	Type x original charge		R410A x 9.3 kg (21 lbs)		R410A x 9.3 kg (21 lbs)	
	Control		Indoor LEV and BC controller			
Net weight		kg (lbs)	260 (574)		260 (574)	
Heat exchanger		Salt-resistant cross fin & aluminium tube		Salt-resistant cross fin & aluminium tube		
HIC circuit (HIC: Heat Inter-Changer)		-				
Pipe between unit and distributor	High pressure	mm (in.)	19.05 (3/4) Brazed		19.05 (3/4) Brazed	
	Low pressure	mm (in.)	28.58 (1-1/8) Brazed		-	
Defrosting method		Auto-defrost mode (Reversed refrigerant cycle, Hot gas)				
Drawing	External		WKJ94L368			
	Wiring		WKE94C948		WKE94C948	
Standard attachment	Document		Installation Manual			
	Accessory		Refrigerant conn. pipe			
Optional parts		Outdoor Twinning kit: CMY-ER200VBK Joint: CMY-Y102SS-G2, CMY-Y102LS-G2, CMY-R160-J1 Main BC controller: CMB-P1016V-HA1 Sub BC controller: CMB-P104, 108V-GB1, CMB-P1016V-HB1				
Remarks		Details on foundation work, duct work, insulation work, electrical wiring, power source switch, and other items shall be referred to the Installation Manual. Due to continuing improvement, above specifications may be subject to change without notice.				

Notes:

- Nominal cooling conditions (subject to JIS B8615-1)
Indoor: 27°C D.B./19°C W.B. (81°F D.B./66°F W.B.), Outdoor: 35°C D.B./24°C W.B. (95°F D.B./75°F W.B.)
Pipe length: 7.5 m (24-9/16 ft.), Level difference: 0 m (0 ft.)
- Nominal heating conditions (subject to JIS B8615-1)
Indoor: 20°C D.B. (68°F D.B.), Outdoor: 7°C D.B./6°C W.B. (45°F D.B./43°F W.B.)
Pipe length: 7.5 m (24-9/16 ft.), Level difference: 0 m (0 ft.)
- 5°C D.B. (23°F D.B.)/-6°C W.B. (21°F W.B.) to 21°C D.B. (70°F D.B.)/15.5°C W.B. (60°F W.B.)
with cooling/heating mixed operation.
- External static pressure option is available (30 Pa, 60 Pa/3.1 mmH₂O, 6.1 mmH₂O).

Unit converter	
BTU/h	=kW x 3,412
cfm	=m ³ /min x 35.31
lbs	=kg/0.4536
*Above specification data is subject to rounding variation.	

1. SPECIFICATIONS

YKB/YLM

R2 (HIGH COP)

Model			PURY-EP750YSLM-A (-BS)	
Power source			3-phase 4-wire 380-400-415 V 50/60 Hz	
Cooling capacity (Nominal)	*1	kW	85.0	
		kcal/h	73,100	
		BTU/h	290,000	
	Power input	kW	25.99	
		Current input	A	43.8-41.6-40.1
EER		kW/kW	3.27	
Temp. range of cooling	*3 Indoor	W.B.	15.0~24.0°C (59~75°F)	
	Outdoor	D.B.	-5.0~46.0°C (23~115°F)	
Heating capacity (Nominal)	*2	kW	95.0	
		kcal/h	81,700	
		BTU/h	324,100	
	Power input	kW	26.38	
		Current input	A	44.5-42.3-40.7
COP		kW/kW	3.60	
Temp. range of heating	*3 Indoor	D.B.	15.0~27.0°C (59~81°F)	
	Outdoor	W.B.	-20.0~15.5°C (-4~60°F)	
Indoor unit connectable	Total capacity		50~150% of outdoor unit capacity	
	Model/Quantity		P15~P250/2~50	
Sound pressure level (measured in anechoic room)			dB <A>	
			65.5	
Sound power level (measured in anechoic room)			dB <A>	
			89	
Refrigerant piping diameter	High pressure		mm (in.)	
	Low pressure		mm (in.)	
		28.58 (1-1/8) Brazed		
		34.93 (1-3/8) Brazed		

Set Model			PURY-EP350YLM-A (-BS)		PURY-EP400YLM-A (-BS)	
FAN	Type x Quantity		Propeller fan x 1		Propeller fan x 2	
	Air flow rate	m ³ /min	230		320	
		L/s	3,833		5,333	
		cfm	8,121		11,299	
	Control, Driving mechanism		Inverter-control, Direct-driven by motor		Inverter-control, Direct-driven by motor	
*4 External static press.	Motor output		kW		kW	
			0.92 x 1		0.92 x 2	
			0 Pa (0 mmH ₂ O)		0 Pa (0 mmH ₂ O)	
Compressor	Type x Quantity		Inverter scroll hermetic compressor		Inverter scroll hermetic compressor	
	Manufacture		AC&R Works, MITSUBISHI ELECTRIC CORPORATION		AC&R Works, MITSUBISHI ELECTRIC CORPORATION	
	Starting method		Inverter		Inverter	
	Motor output		kW		kW	
			10.5		10.9	
	Case heater		kW		kW	
		-		-		
Lubricant		MEL32		MEL32		
External finish			Pre-coated galvanized steel sheets (+powder coating for -BS type) <MUNSELL 5Y 8/1 or similar>		Pre-coated galvanized steel sheets (+powder coating for -BS type) <MUNSELL 5Y 8/1 or similar>	
External dimension H x W x D			mm		mm	
			1,710 (1,650 without legs) x 1,220 x 740		1,710 (1,650 without legs) x 1,750 x 740	
			in.		in.	
			67-3/8 (65 without legs) x 48-1/16 x 29-3/16		67-3/8 (65 without legs) x 68-15/16 x 29-3/16	
Protection devices	High pressure protection		High pressure sensor, High pressure switch at 4.15 MPa (601 psi)		High pressure sensor, High pressure switch at 4.15 MPa (601 psi)	
	Inverter circuit (COMP./FAN)		Over-heat protection, Over-current protection		Over-heat protection, Over-current protection	
	Compressor		Over-heat protection		Over-heat protection	
	Fan motor		Over-current protection		Over-current protection	
Refrigerant	Type x original charge		R410A x 9.3 kg (21 lbs)		R410A x 11.8 kg (27 lbs)	
	Control		Indoor LEV and BC controller			
Net weight			kg (lbs)		kg (lbs)	
			260 (574)		338 (746)	
Heat exchanger			Salt-resistant cross fin & aluminium tube		Salt-resistant cross fin & aluminium tube	
HIC circuit (HIC: Heat Inter-Changer)						
Pipe between unit and distributor	High pressure		mm (in.)		mm (in.)	
	Low pressure		mm (in.)		mm (in.)	
		19.05 (3/4) Brazed		22.2 (7/8) Brazed		
		28.58 (1-1/8) Brazed				
Defrosting method			Auto-defrost mode (Reversed refrigerant cycle, Hot gas)			
Drawing	External		WKJ94L369			
	Wiring		WKE94C948		WKE94C949	
Standard attachment	Document		Installation Manual			
	Accessory		Refrigerant conn. pipe			
Optional parts			Outdoor Twinning kit: CMY-ER200VBK Joint: CMY-Y102SS-G2, CMY-Y102LS-G2, CMY-R160-J1 Main BC controller: CMB-P1016V-HA1 Sub BC controller: CMB-P104, 108V-GB1, CMB-P1016V-HB1			
Remarks			Details on foundation work, duct work, insulation work, electrical wiring, power source switch, and other items shall be referred to the Installation Manual. Due to continuing improvement, above specifications may be subject to change without notice.			

Notes:	Unit converter
1. Nominal cooling conditions (subject to JIS B8615-1) Indoor: 27°C D.B./19°C W.B. (81°F D.B./66°F W.B.), Outdoor: 35°C D.B./24°C W.B. (95°F D.B./75°F W.B.) Pipe length: 7.5 m (24-9/16 ft.), Level difference: 0 m (0 ft.)	BTU/h = kW x 3,412
2. Nominal heating conditions (subject to JIS B8615-1) Indoor: 20°C D.B. (68°F D.B.), Outdoor: 7°C D.B./6°C W.B. (45°F D.B./43°F W.B.) Pipe length: 7.5 m (24-9/16 ft.), Level difference: 0 m (0 ft.)	cfm = m ³ /min x 35.31
3. 5°C D.B. (23°F D.B.)/-6°C W.B. (21°F W.B.) to 21°C D.B. (70°F D.B.)/15.5°C W.B. (60°F W.B.) with cooling/heating mixed operation.	lbs = kg/0.4536
4. External static pressure option is available (30 Pa, 60 Pa/3.1 mmH ₂ O, 6.1 mmH ₂ O).	*Above specification data is subject to rounding variation.

1. SPECIFICATIONS

YKB/YLM

R2 (HIGH COP)

Model		PURY-EP800YSLM-A (-BS)		
Power source		3-phase 4-wire 380-400-415 V 50/60 Hz		
Cooling capacity (Nominal)	*1	kW	90.0	
		kcal/h	77,400	
		BTU/h	307,100	
		Power input	kW	25.93
		Current input	A	43.7-41.5-40.0
		EER	kW/kW	3.47
Temp. range of cooling	*3	Indoor	D.B.	15.0-24.0°C (59-75°F)
		Outdoor	D.B.	-5.0-46.0°C (23-115°F)
Heating capacity (Nominal)	*2	kW	100.0	
		kcal/h	86,000	
		BTU/h	341,200	
		Power input	kW	26.80
		Current input	A	45.2-42.9-41.4
		COP	kW/kW	3.73
Temp. range of heating	*3	Indoor	D.B.	15.0-27.0°C (59-81°F)
		Outdoor	W.B.	-20.0-15.5°C (-4-60°F)
Indoor unit connectable	Total capacity		50-150% of outdoor unit capacity	
	Model/Quantity		P15-P250/2-50	
Sound pressure level (measured in anechoic room)	dB <A>		65.5	
Sound power level (measured in anechoic room)	dB <A>		89	
Refrigerant piping diameter	High pressure	mm (in.)	28.58 (1-1/8) Brazed	
	Low pressure	mm (in.)	34.93 (1-3/8) Brazed	

Set Model

Model		PURY-EP400YLM-A (-BS)		PURY-EP400YLM-A (-BS)		
FAN	Type x Quantity		Propeller fan x 2		Propeller fan x 2	
	Air flow rate	m ³ /min	320		320	
		L/s	5,333		5,333	
		cfm	11,299		11,299	
	Control, Driving mechanism		Inverter-control, Direct-driven by motor		Inverter-control, Direct-driven by motor	
	Motor output	kW	0.92 x 2		0.92 x 2	
*4	External static press.		0 Pa (0 mmH ₂ O)		0 Pa (0 mmH ₂ O)	
Compressor	Type x Quantity		Inverter scroll hermetic compressor		Inverter scroll hermetic compressor	
	Manufacture		AC&R Works, MITSUBISHI ELECTRIC CORPORATION		AC&R Works, MITSUBISHI ELECTRIC CORPORATION	
	Starting method		Inverter		Inverter	
	Motor output	kW	10.9		10.9	
	Case heater	kW	- (- V)		- (- V)	
	Lubricant		MEL32		MEL32	
External finish		Pre-coated galvanized steel sheets (+powder coating for -BS type) <MUNSELL 5Y 8/1 or similar>		Pre-coated galvanized steel sheets (+powder coating for -BS type) <MUNSELL 5Y 8/1 or similar>		
External dimension H x W x D		mm	1,710 (1,650 without legs) x 1,750 x 740		1,710 (1,650 without legs) x 1,750 x 740	
		in.	67-3/8 (65 without legs) x 68-15/16 x 29-3/16		67-3/8 (65 without legs) x 68-15/16 x 29-3/16	
Protection devices	High pressure protection		High pressure sensor, High pressure switch at 4.15 MPa (601 psi)		High pressure sensor, High pressure switch at 4.15 MPa (601 psi)	
	Inverter circuit (COMP./FAN)		Over-heat protection, Over-current protection		Over-heat protection, Over-current protection	
	Compressor		Over-heat protection		Over-heat protection	
	Fan motor		Over-current protection		Over-current protection	
Refrigerant	Type x original charge		R410A x 11.8 kg (27 lbs)		R410A x 11.8 kg (27 lbs)	
	Control		Indoor LEV and BC controller			
Net weight	kg (lbs)		338 (746)		338 (746)	
Heat exchanger			Salt-resistant cross fin & aluminium tube		Salt-resistant cross fin & aluminium tube	
HIC circuit (HIC: Heat Inter-Changer)						
Pipe between unit and distributor	High pressure	mm (in.)	22.2 (7/8) Brazed		22.2 (7/8) Brazed	
	Low pressure	mm (in.)	28.58 (1-1/8) Brazed			
Defrosting method		Auto-defrost mode (Reversed refrigerant cycle, Hot gas)				
Drawing	External		WKJ94L370			
	Wiring		WKE94C949		WKE94C949	
Standard attachment	Document		Installation Manual			
	Accessory		Refrigerant conn. pipe			
Optional parts		Outdoor Twinning kit: CMY-ER200VBK Joint: CMY-Y102SS-G2, CMY-Y102LS-G2, CMY-R160-J1 Main BC controller: CMB-P1016V-HA1 Sub BC controller: CMB-P104, 108V-GB1, CMB-P1016V-HB1				
Remarks		Details on foundation work, duct work, insulation work, electrical wiring, power source switch, and other items shall be referred to the Installation Manual. Due to continuing improvement, above specifications may be subject to change without notice.				

Notes:

- Nominal cooling conditions (subject to JIS B8615-1)
Indoor: 27°C D.B./19°C W.B. (81°F D.B./66°F W.B.), Outdoor: 35°C D.B./24°C W.B. (95°F D.B./75°F W.B.)
Pipe length: 7.5 m (24-9/16 ft.), Level difference: 0 m (0 ft.)
- Nominal heating conditions (subject to JIS B8615-1)
Indoor: 20°C D.B. (68°F D.B.), Outdoor: 7°C D.B./6°C W.B. (45°F D.B./43°F W.B.)
Pipe length: 7.5 m (24-9/16 ft.), Level difference: 0 m (0 ft.)
- 5°C D.B. (23°F D.B.)/-6°C W.B. (21°F W.B.) to 21°C D.B. (70°F D.B.)/15.5°C W.B. (60°F W.B.)
with cooling/heating mixed operation.
- External static pressure option is available (30 Pa, 60 Pa/3.1 mmH₂O, 6.1 mmH₂O).

Unit converter	
BTU/h	=kW x 3,412
cfm	=m ³ /min x 35.31
lbs	=kg/0.4536
*Above specification data is subject to rounding variation.	

1. SPECIFICATIONS

YKB/YLM

R2 (HIGH COP)

Model			PURY-EP850YSLM-A (-BS)	
Power source			3-phase 4-wire 380-400-415 V 50/60 Hz	
Cooling capacity (Nominal)	*1	kW	96.0	
		kcal/h	82,600	
		BTU/h	327,600	
	Power input	kW	28.48	
		Current input	A	
EER		kW/kW		
Temp. range of cooling	*3 Indoor	W.B.	15.0~24.0°C (59~75°F)	
	Outdoor	D.B.	-5.0~46.0°C (23~115°F)	
Heating capacity (Nominal)	*2	kW	108.0	
		kcal/h	92,900	
		BTU/h	368,500	
	Power input	kW	29.75	
		Current input	A	
COP		kW/kW		
Temp. range of heating	*3 Indoor	D.B.	15.0~27.0°C (59~81°F)	
	Outdoor	W.B.	-20.0~15.5°C (-4~60°F)	
Indoor unit connectable	Total capacity		50~150% of outdoor unit capacity	
	Model/Quantity		P15~P250/2~50	
Sound pressure level (measured in anechoic room)			dB <A>	
Sound power level (measured in anechoic room)			dB <A>	
Refrigerant			High pressure	
piping diameter			Low pressure	

Set Model			PURY-EP400YLM-A (-BS)		PURY-EP450YLM-A (-BS)	
Model			PURY-EP400YLM-A (-BS)		PURY-EP450YLM-A (-BS)	
FAN	Type x Quantity		Propeller fan x 2		Propeller fan x 2	
	Air flow rate	m ³ /min	320		320	
		L/s	5,333		5,333	
		cfm	11,299		11,299	
	Control, Driving mechanism		Inverter-control, Direct-driven by motor		Inverter-control, Direct-driven by motor	
*4 Motor output		kW		0.92 x 2		
External static press.		0 Pa (0 mmH ₂ O)		0 Pa (0 mmH ₂ O)		
Compressor	Type x Quantity		Inverter scroll hermetic compressor		Inverter scroll hermetic compressor	
	Manufacture		AC&R Works, MITSUBISHI ELECTRIC CORPORATION		AC&R Works, MITSUBISHI ELECTRIC CORPORATION	
	Starting method		Inverter		Inverter	
	Motor output		kW		10.9	
	Case heater		kW		- (- V)	
	Lubricant		MEL32		MEL32	
External finish			Pre-coated galvanized steel sheets (+powder coating for -BS type) <MUNSELL 5Y 8/1 or similar>		Pre-coated galvanized steel sheets (+powder coating for -BS type) <MUNSELL 5Y 8/1 or similar>	
External dimension H x W x D			mm		1,710 (1,650 without legs) x 1,750 x 740	
			in.		67-3/8 (65 without legs) x 68-15/16 x 29-3/16	
Protection devices	High pressure protection		High pressure sensor, High pressure switch at 4.15 MPa (601 psi)		High pressure sensor, High pressure switch at 4.15 MPa (601 psi)	
	Inverter circuit (COMP./FAN)		Over-heat protection, Over-current protection		Over-heat protection, Over-current protection	
	Compressor		Over-heat protection		Over-heat protection	
	Fan motor		Over-current protection		Over-current protection	
Refrigerant	Type x original charge		R410A x 11.8 kg (27 lbs)		R410A x 11.8 kg (27 lbs)	
	Control		Indoor LEV and BC controller			
Net weight			kg (lbs)		338 (746)	
Heat exchanger			Salt-resistant cross fin & aluminium tube		Salt-resistant cross fin & aluminium tube	
HIC circuit (HIC: Heat Inter-Changer)			-			
Pipe between unit and distributor	High pressure		mm (in.)		22.2 (7/8) Brazed	
	Low pressure		mm (in.)		28.58 (1-1/8) Brazed	
Defrosting method			Auto-defrost mode (Reversed refrigerant cycle, Hot gas)			
Drawing	External		WKJ94L370			
	Wiring		WKE94C949		WKE94C949	
Standard attachment	Document		Installation Manual			
	Accessory		Refrigerant conn. pipe			
Optional parts			Outdoor Twinning kit: CMY-ER200VBK Joint: CMY-Y102SS-G2, CMY-Y102LS-G2, CMY-R160-J1 Main BC controller: CMB-P1016V-HA1 Sub BC controller: CMB-P104, 108V-GB1, CMB-P1016V-HB1			
Remarks			Details on foundation work, duct work, insulation work, electrical wiring, power source switch, and other items shall be referred to the Installation Manual. Due to continuing improvement, above specifications may be subject to change without notice.			

Notes:	Unit converter
1. Nominal cooling conditions (subject to JIS B8615-1) Indoor: 27°C D.B./19°C W.B. (81°F D.B./66°F W.B.), Outdoor: 35°C D.B./24°C W.B. (95°F D.B./75°F W.B.) Pipe length: 7.5 m (24-9/16 ft.), Level difference: 0 m (0 ft.)	BTU/h = kW x 3,412
2. Nominal heating conditions (subject to JIS B8615-1) Indoor: 20°C D.B. (68°F D.B.), Outdoor: 7°C D.B./6°C W.B. (45°F D.B./43°F W.B.) Pipe length: 7.5 m (24-9/16 ft.), Level difference: 0 m (0 ft.)	cfm = m ³ /min x 35.31
3. 5°C D.B. (23°F D.B.)/-6°C W.B. (21°F W.B.) to 21°C D.B. (70°F D.B.)/15.5°C W.B. (60°F W.B.) with cooling/heating mixed operation.	lbs = kg/0.4536
4. External static pressure option is available (30 Pa, 60 Pa/3.1 mmH ₂ O, 6.1 mmH ₂ O).	*Above specification data is subject to rounding variation.

1. SPECIFICATIONS

YKB/YLM

R2 (HIGH COP)

Model		PURY-EP900YSLM-A (-BS)		
Power source		3-phase 4-wire 380-400-415 V 50/60 Hz		
Cooling capacity (Nominal)	*1	kW	101.0	
		kcal/h	86,900	
	*1	BTU/h	344,600	
		Power input	kW	30.98
		Current input	A	52.2-49.6-47.8
		EER	kW/kW	3.26
Temp. range of cooling	*3	Indoor	D.B.	15.0~24.0°C (59~75°F)
		Outdoor	D.B.	-5.0~46.0°C (23~115°F)
Heating capacity (Nominal)	*2	kW	113.0	
		kcal/h	97,200	
	*2	BTU/h	385,600	
		Power input	kW	32.01
		Current input	A	54.0-51.3-49.4
		COP	kW/kW	3.53
Temp. range of heating	*3	Indoor	D.B.	15.0~27.0°C (59~81°F)
		Outdoor	W.B.	-20.0~15.5°C (-4~60°F)
Indoor unit connectable	Total capacity			50~150% of outdoor unit capacity
	Model/Quantity			P15-P250/2-50
Sound pressure level (measured in anechoic room)		dB <A>	65.5	
Sound power level (measured in anechoic room)		dB <A>	89	
Refrigerant piping diameter	High pressure		mm (in.)	28.58 (1-1/8) Brazed
	Low pressure		mm (in.)	41.28 (1-5/8) Brazed

Set Model

Model		PURY-EP450YLM-A (-BS)		PURY-EP450YLM-A (-BS)		
FAN	Type x Quantity		Propeller fan x 2		Propeller fan x 2	
	Air flow rate	m ³ /min	320		320	
		L/s	5,333		5,333	
		cfm	11,299		11,299	
	Control, Driving mechanism		Inverter-control, Direct-driven by motor		Inverter-control, Direct-driven by motor	
	*4	Motor output	kW	0.92 x 2		0.92 x 2
External static press.		0 Pa (0 mmH ₂ O)		0 Pa (0 mmH ₂ O)		
Compressor	Type x Quantity		Inverter scroll hermetic compressor		Inverter scroll hermetic compressor	
	Manufacture		AC&R Works, MITSUBISHI ELECTRIC CORPORATION		AC&R Works, MITSUBISHI ELECTRIC CORPORATION	
	Starting method		Inverter		Inverter	
	Motor output	kW	12.4		12.4	
	Case heater	kW	- (- V)		- (- V)	
	Lubricant		MEL32		MEL32	
External finish		Pre-coated galvanized steel sheets (+powder coating for -BS type) <MUNSELL 5Y 8/1 or similar>		Pre-coated galvanized steel sheets (+powder coating for -BS type) <MUNSELL 5Y 8/1 or similar>		
External dimension H x W x D		mm	1,710 (1,650 without legs) x 1,750 x 740		1,710 (1,650 without legs) x 1,750 x 740	
		in.	67-3/8 (65 without legs) x 68-15/16 x 29-3/16		67-3/8 (65 without legs) x 68-15/16 x 29-3/16	
Protection devices	High pressure protection		High pressure sensor, High pressure switch at 4.15 MPa (601 psi)		High pressure sensor, High pressure switch at 4.15 MPa (601 psi)	
	Inverter circuit (COMP./FAN)		Over-heat protection, Over-current protection		Over-heat protection, Over-current protection	
	Compressor		Over-heat protection		Over-heat protection	
	Fan motor		Over-current protection		Over-current protection	
Refrigerant	Type x original charge		R410A x 11.8 kg (27 lbs)		R410A x 11.8 kg (27 lbs)	
	Control		Indoor LEV and BC controller			
Net weight		kg (lbs)	338 (746)		338 (746)	
Heat exchanger		Salt-resistant cross fin & aluminium tube		Salt-resistant cross fin & aluminium tube		
HIC circuit (HIC: Heat Inter-Changer)		-		-		
Pipe between unit and distributor	High pressure	mm (in.)	22.2 (7/8) Brazed		22.2 (7/8) Brazed	
	Low pressure	mm (in.)	28.58 (1-1/8) Brazed		-	
Defrosting method		Auto-defrost mode (Reversed refrigerant cycle, Hot gas)				
Drawing	External		WKJ94L370			
	Wiring		WKE94C949		WKE94C949	
Standard attachment	Document		Installation Manual			
	Accessory		Refrigerant conn. pipe			
Optional parts		Outdoor Twinning kit: CMY-ER200VBK Joint: CMY-Y102SS-G2, CMY-Y102LS-G2, CMY-R160-J1 Main BC controller: CMB-P1016V-HA1 Sub BC controller: CMB-P104, 108V-GB1, CMB-P1016V-HB1				
Remarks		Details on foundation work, duct work, insulation work, electrical wiring, power source switch, and other items shall be referred to the Installation Manual. Due to continuing improvement, above specifications may be subject to change without notice.				

Notes:

- Nominal cooling conditions (subject to JIS B8615-1)
Indoor: 27°C D.B./19°C W.B. (81°F D.B./66°F W.B.), Outdoor: 35°C D.B./24°C W.B. (95°F D.B./75°F W.B.)
Pipe length: 7.5 m (24-9/16 ft.), Level difference: 0 m (0 ft.)
- Nominal heating conditions (subject to JIS B8615-1)
Indoor: 20°C D.B. (68°F D.B.), Outdoor: 7°C D.B./6°C W.B. (45°F D.B./43°F W.B.)
Pipe length: 7.5 m (24-9/16 ft.), Level difference: 0 m (0 ft.)
- 5°C D.B. (23°F D.B.)/-6°C W.B. (21°F W.B.) to 21°C D.B. (70°F D.B.)/15.5°C W.B. (60°F W.B.)
with cooling/heating mixed operation.
- External static pressure option is available (30 Pa, 60 Pa/3.1 mmH₂O, 6.1 mmH₂O).

Unit converter

BTU/h	=kW x 3,412
cfm	=m ³ /min x 35.31
lbs	=kg/0.4536

*Above specification data is subject to rounding variation.

PURY-EP200, 250YLM-A (-BS)

Unit : mm

R2 (HIGH COP)

- <Accessories>
 ●Connecting pipe
 <Low pressure>
 -Pipe (IDø28.58×ODø22.2) ... EP200,EP250 1pc.
 -Pipe (IDø22.2×ODø19.05) ... EP200 1pc.
 -Elbow(IDø28.58×ODø28.58) ... EP200,EP250 1pc.
 <High pressure>
 -Pipe (IDø25.4×IDø15.88) ... EP200 1pc.
 -Pipe (IDø25.4×ODø15.88) ... EP200 1pc.
 -Pipe (IDø25.4×IDø19.05) ... EP250 1pc.
 -Pipe (IDø25.4×ODø19.05) ... EP250 1pc.

Note 1, Please refer to the next page for information regarding necessary spacing around the unit and foundation work.
 2. The detachable leg can be removed at site.
 3. At brazing of pipes, wrap the refrigerant service valve with wet cloth and keep the temperature of refrigerant service valve under 120°C.
 4. Used only when a separately-sold unit is attached. Refer to the Installation Manual of the unit for details.

Connecting pipe specifications

Model	Refrigerant pipe		Service valve	
	High pressure	Low pressure	High pressure	Low pressure
PURY-EP200YLM-A(-BS)	ø15.88 Brazed *1	ø19.05 Brazed *1	ø25.4	ø28.58
PURY-EP250YLM-A(-BS)	ø19.05 Brazed *1	ø22.2 Brazed *1		

*1 Use the included connecting pipe and connect to the refrigerant service valve piping.

NO.	Usage	Specifications
①	Front through hole	140 × 77 Knockout hole
②	Front through hole	140 × 77 Knockout hole (Uses when twinning kit (optional parts) is mounted.)
	Bottom through hole	
③	Bottom through hole	150 × 94 Knockout hole
④	Front through hole	ø65 or ø40 Knockout hole
⑤	Front through hole	ø52 or ø27 Knockout hole
⑥	Bottom through hole	ø65 Knockout hole
⑦	Bottom through hole	ø52 Knockout hole
⑧	For transmission cables	Front through hole ø34 Knockout hole

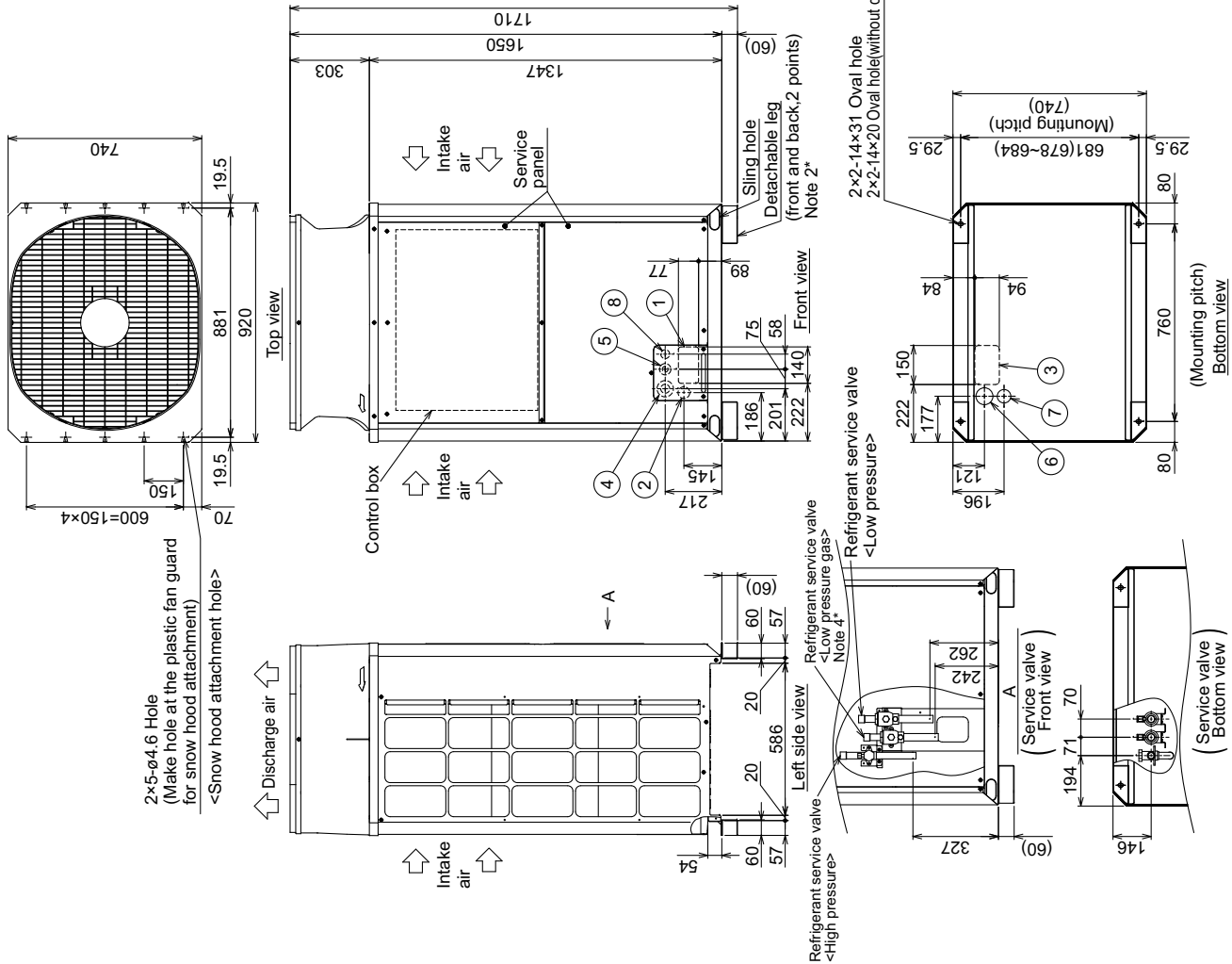

PURY-EP200, 250YLM-A (-BS)

Unit : mm

1. Required space around the unit

● In case of single installation

① Secure enough space around the unit as shown in the figure below.

· With a space of at least 300mm to the wall on the back of the unit

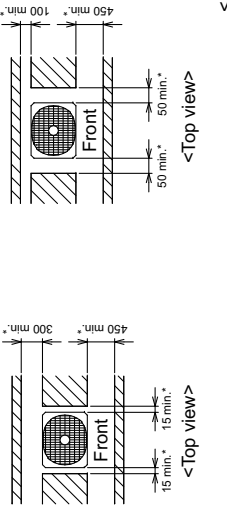

② When the height of the walls on the front, back or on the sides <H> exceeds the wall height limit as defined below add the height that exceeds the height limit <h> to the figures that are marked with an asterisk.

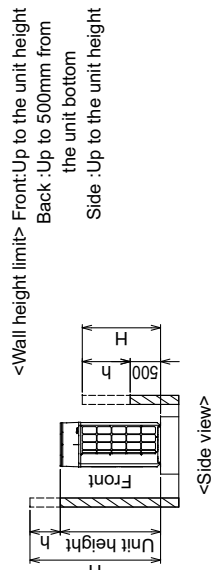

2. Foundation work

- Take into consideration the surface strength, water drainage route, piping route, and wiring route when preparing the installation site.
<Note that the drain water comes out of the unit during operation.>
- Build the foundation in such way that the corner of the installation leg is securely supported as shown in the right figure (Fig.A,B)
When using a rubber isolating cushion, please ensure it is large enough to cover the entire width of each of the unit's legs.
- The protrusion length of the anchor bolt must not exceed 30mm.(Fig.A,B)
- Use four fixing plates as shown in the right figure <field supply required> when using post-installed anchor bolts.(Fig.C,D)
- To prevent small animals and water and snow from entering the unit and damaging its parts, close the gap around the edges of through holes for pipes and wires with filler plates <field supply required>.
- When the pipes or cables are routed at the bottom of the unit, make sure that the through hole at the base of the unit does not get blocked with the installation base.
- Refer to the Installation Manual when installing units on an installation base.

● In case of collective installation

- When multiple units are installed adjacent to each other, secure enough space to allow for air circulation and walkway between groups of units as shown in the figures below.
- At least two sides must be left open.
- As with the single installation, add the height that exceeds the height limit <h> to the figures that are marked with an asterisk.
- If there is a wall at both the front and the rear of the unit, install up to six units consecutively in the side direction and provide a space of 1000mm or more as inlet space/ passage space for each six units.

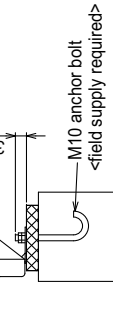
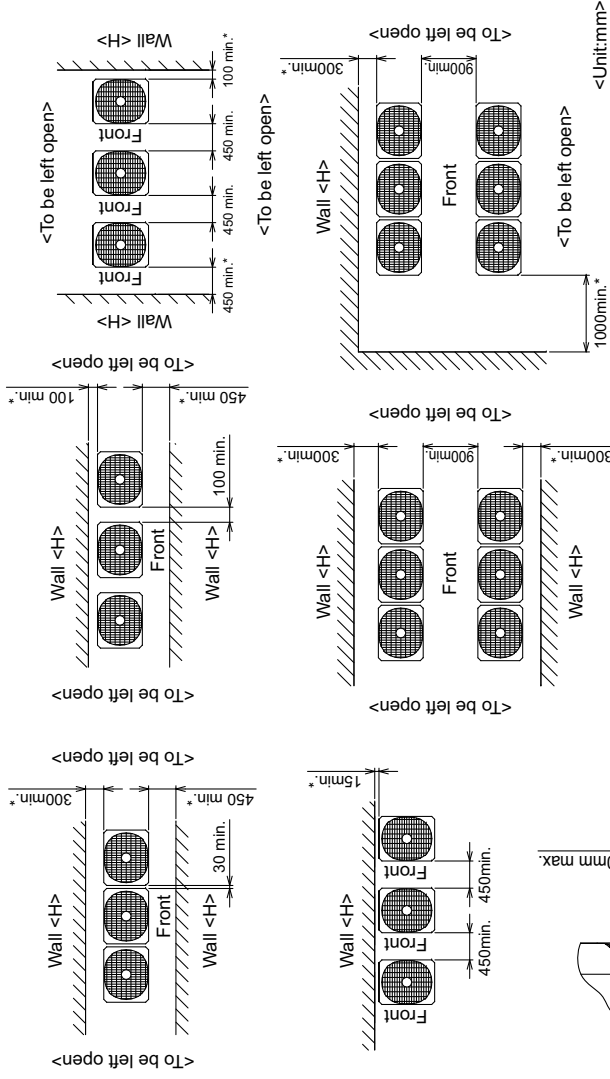

Fig.A (without detachable legs)

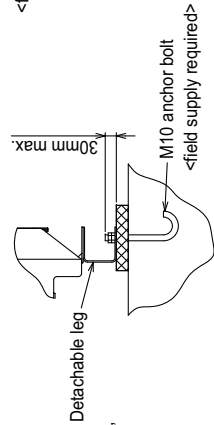

Fig.B (with detachable legs)

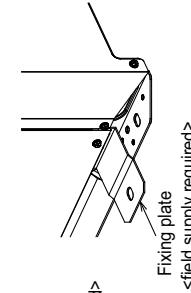

Fig.C (without detachable legs)

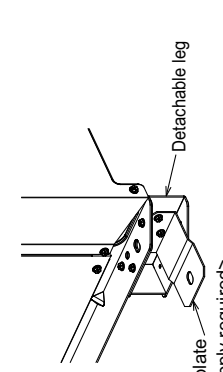

Fig.D (with detachable legs)

PURY-EP300, 350YLM-A (-BS)

Unit : mm

- <Accessories>
- Connecting pipe
 - <Low pressure>
 - Pipe (ID ϕ 28.58 \times OD ϕ 22.2) ... EP300 1pc.
 - Elbow (ID ϕ 28.58 \times OD ϕ 28.58) ... EP300.350 1pc.
 - <High pressure>
 - Pipe (ID ϕ 25.4 \times ID ϕ 19.05) ... EP300.350 1pc.
 - Pipe (ID ϕ 25.4 \times OD ϕ 19.05) ... EP300.350 1pc.

Note 1. Please refer to the next page for information regarding necessary spacing around the unit and foundation work.

- The detachable leg can be removed at site.
- At brazing of pipes, wrap the refrigerant service valve with wet cloth and keep the temperature of refrigerant service valve under 120°C.
- Used only when a separately-sold unit is attached. Refer to the Installation Manual of the unit for details.

Connecting pipe specifications

Model	Refrigerant pipe		Service valve	
	High pressure	Low pressure	High pressure	Low pressure
PURY-EP300YLM-A(-BS)	ϕ 22.2 Brazed *1	ϕ 19.05 Brazed *1	ϕ 25.4	ϕ 28.58
PURY-EP350YLM-A(-BS)	ϕ 28.58 Brazed *1	ϕ 28.58 Brazed *1	ϕ 25.4	ϕ 28.58

*1 Use the included connecting pipe and connect to the refrigerant service valve piping.

NO.	Usage	Specifications
①	Front through hole	140 x 77 Knockout hole
②	Front through hole	(Uses when twinning kit (optional parts) is mounted.)
	Bottom through hole	
③	Bottom through hole	150 x 94 Knockout hole
④	Front through hole	ϕ 65 or ϕ 40 Knockout hole
⑤	Front through hole	ϕ 62 or ϕ 27 Knockout hole
⑥	Bottom through hole	ϕ 65 Knockout hole
⑦	Bottom through hole	ϕ 62 Knockout hole
⑧	Front through hole	ϕ 34 Knockout hole

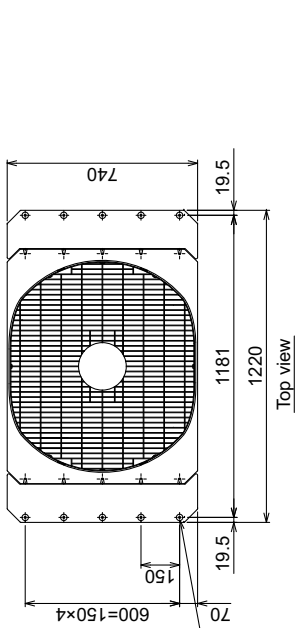

4x5- ϕ 4.6 Hole
(Make hole at the plastic fan guard for snow hood attachment)
<Snow hood attachment hole>

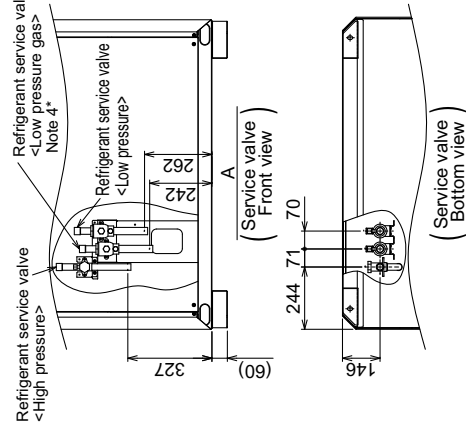
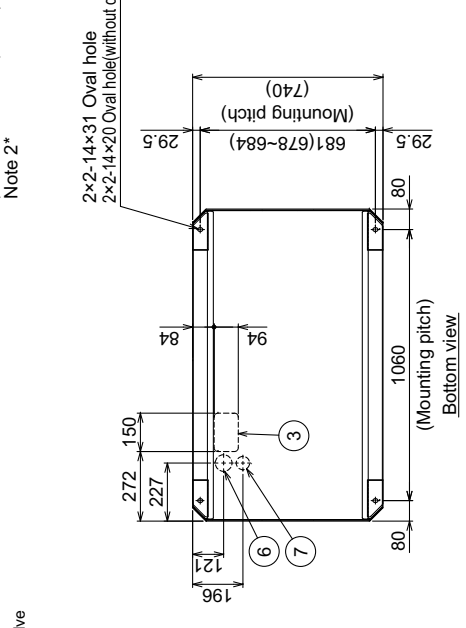
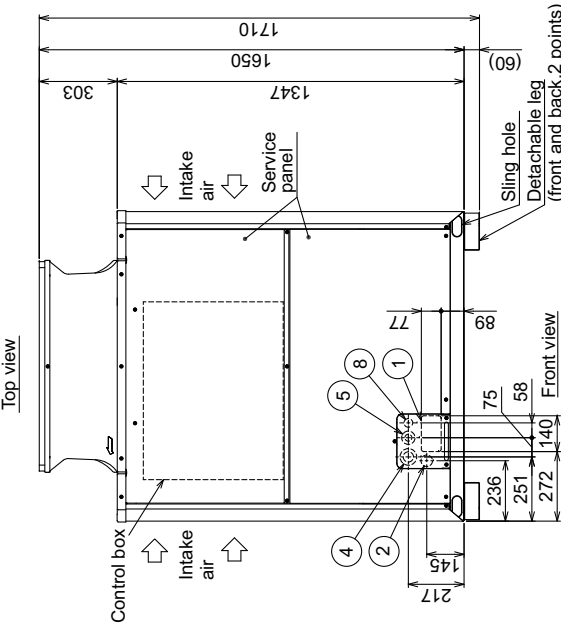

PURY-EP300, 350YLM-A (-BS)

Unit : mm

1. Required space around the unit

● In case of single installation

- ① Secure enough space around the unit as shown in the figure below.
 ·With a space of at least 300mm to the wall on the back of the unit

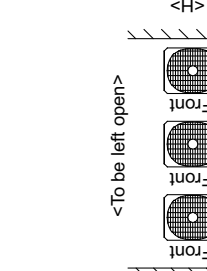

<Top view>
<Unit:mm>

● In case of collective installation

- ① When multiple units are installed adjacent to each other, secure enough space to allow for air circulation and walkway between groups of units as shown in the figures below.
- ② At least two sides must be left open.
- ③ As with the single installation, add the height that exceeds the height limit<h> to the figures that are marked with an asterisk.
- ④ If there is a wall at both the front and the rear of the unit, install up to six units consecutively in the side direction and provide a space of 1000mm or more as inlet space/ passage space for each six units.

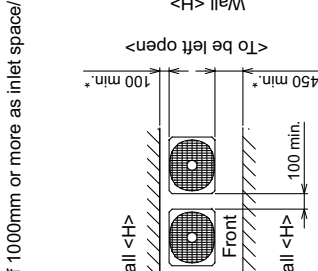

<Unit:mm>

2. Foundation work

- ① Take into consideration the surface strength, water drainage route, piping route, and wiring route when preparing the installation site.
 <Note that the drain water comes out of the unit during operation.>
- ② Build the foundation in such way that the corner of the installation leg is securely supported as shown in the right figure.(Fig.A,B)
 When using a rubber isolating cushion, please ensure it is large enough to cover the entire width of each of the unit's legs.
- ③ The protrusion length of the anchor bolt must not exceed 30mm.(Fig.A,B)
- ④ Use four fixing plates as shown in the right figure <field supply required> when using post-installed anchor bolts.(Fig.C,D)
- ⑤ To prevent small animals and water and snow from entering the unit and damaging its parts, close the gap around the edges of through holes for pipes and wires with filler plates <field supply required>.
- ⑥ When the pipes or cables are routed at the bottom of the unit, make sure that the through hole at the base of the unit does not get blocked with the installation base.
- ⑦ Refer to the Installation Manual when installing units on an installation base.

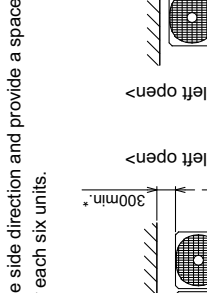

<Side view>
 <Wall height limit> Front: Up to the unit height
 Back: Up to 500mm from the unit bottom
 Side: Up to the unit height

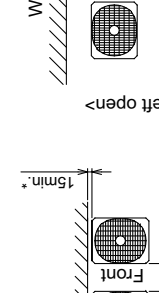

Fig.A (without detachable legs)

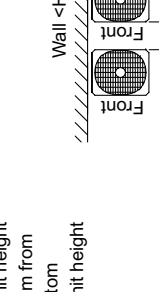

Fig.B (with detachable legs)

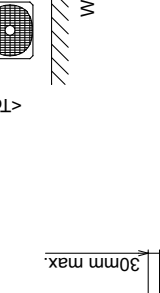

Fig.C (without detachable legs)

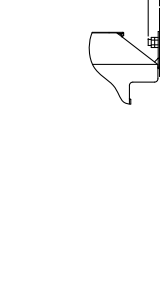

Fig.D (with detachable legs)

PURY-EP400, 450, 500YLM-A (-BS)

Unit : mm

- <Accessories>
 •Connecting pipe
 <Low pressure>
 ·Elbow (IDø28.58×ODø28.58) ... EP400,EP450,EP500 1pc.
 <High pressure>
 ·Pipe (IDø25.4×IDø22.2) ... EP400,EP450,EP500 1pc.
 ·Pipe (IDø25.4×ODø22.2) ... EP400,EP450,EP500 1pc.

Note 1. Please refer to the next page for information regarding necessary spacing around the unit and foundation work.
 2. The detachable leg can be removed at site.
 3. At brazing of pipes, wrap the refrigerant service valve with wet cloth and keep the temperature of refrigerant service valve under 120°C.
 4. Use only when a separately-sold unit is attached. Refer to the Installation Manual of the unit for details.

Connecting pipe specifications

Model	Refrigerant pipe		Diameter	
	High pressure	Low pressure	High pressure	Low pressure
PURY-EP400YLM-A(-BS)	ø22.2 Braze	ø28.58 Braze *1	ø25.4	ø28.58
PURY-EP450YLM-A(-BS)	ø22.2 Braze	ø28.58 Braze *1	ø25.4	ø28.58
PURY-EP500YLM-A(-BS)	ø22.2 Braze	ø28.58 Braze *1	ø25.4	ø28.58

*1 Use the included connecting pipe and connect to the refrigerant service valve piping.

NO.	Usage	Specifications
①	Front through hole	140 × 77 Knockout hole
②	For pipes (Uses when twinning kit (optional parts) is mounted.)	ø45 Knockout hole
③	Bottom through hole	150 × 94 Knockout hole
④	Front through hole	ø65 or ø40 Knockout hole
⑤	Front through hole	ø52 or ø27 Knockout hole
⑥	Bottom through hole	ø65 Knockout hole
⑦	Bottom through hole	ø52 Knockout hole
⑧	For transmission cables	ø34 Knockout hole

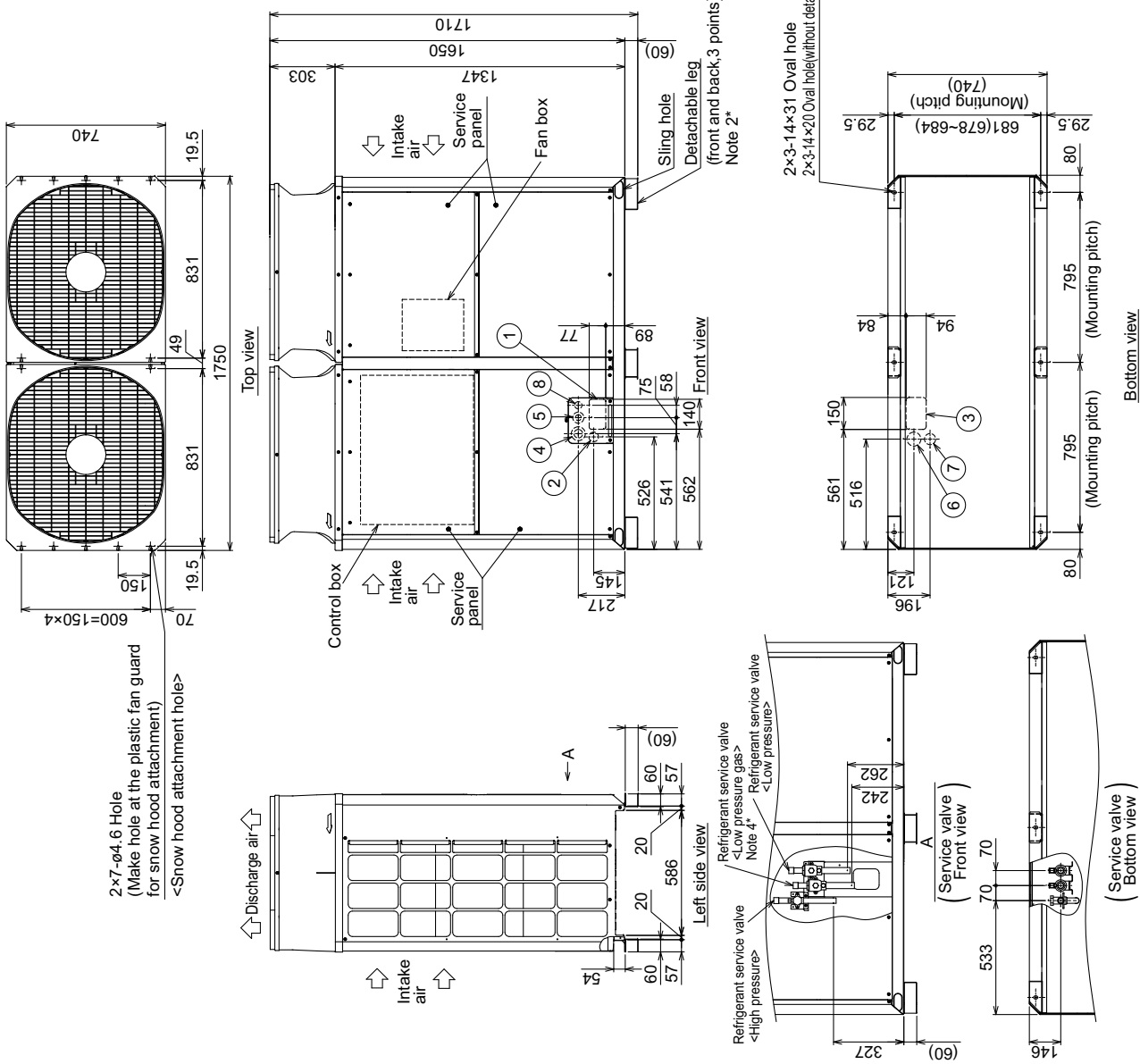

PURY-EP400, 450, 500YLM-A (-BS)

Unit : mm

1. Required space around the unit

● In case of single installation

- ① Secure enough space around the unit as shown in the figure below.
 - With a space of at least 300mm to the wall on the back of the unit

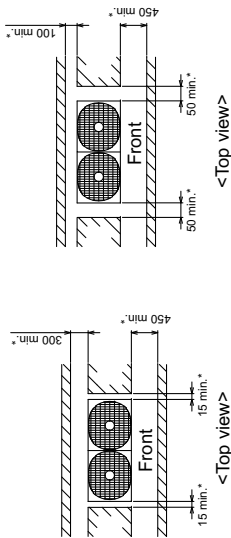

- ② When the height of the walls on the front, back or on the sides <H> exceeds the wall height limit as defined below add the height that exceeds the height limit <h> to the figures that are marked with an asterisk.

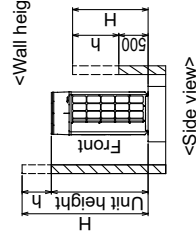

<Wall height limit> Front: Up to the unit height
 Back: Up to 500mm from the unit bottom
 Side : Up to the unit height

● In case of collective installation

- ① When multiple units are installed adjacent to each other, secure enough space to allow for air circulation and walkway between groups of units as shown in the figures below.
- ② At least two sides must be left open.
- ③ As with the single installation, add the height that exceeds the height limit <h> to the figures that are marked with an asterisk.
- ④ If there is a wall at both the front and the rear of the unit, install up to three units consecutively in the side direction and provide a space of 1000mm or more as inlet space/ passage space for each three units.

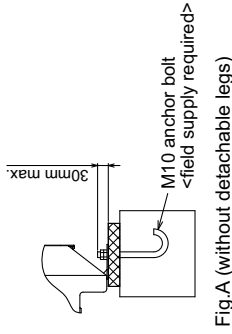
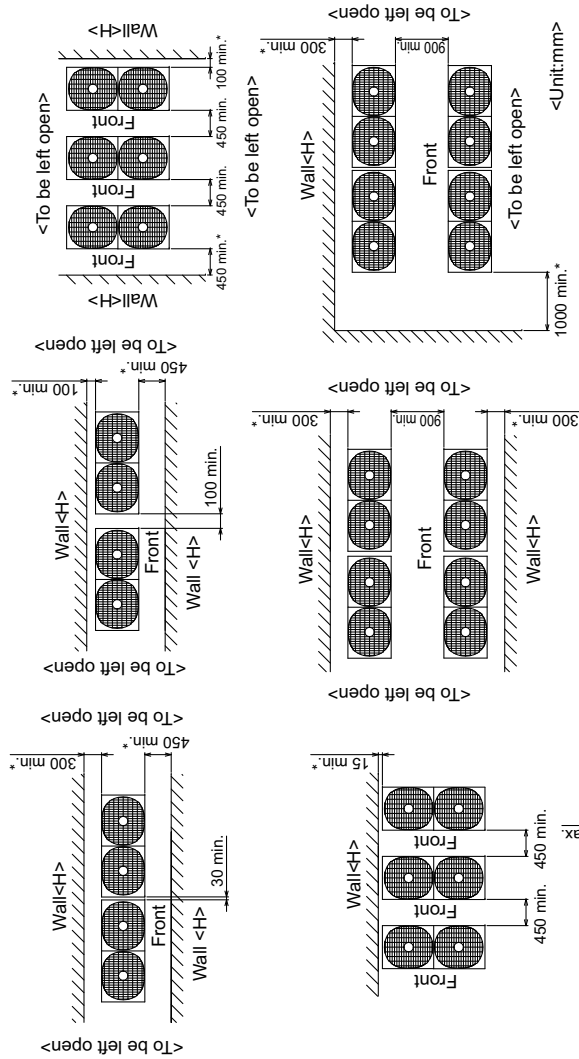

Fig.A (without detachable legs)

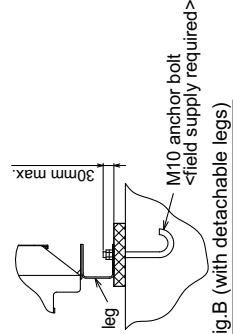

Fig.B (with detachable legs)

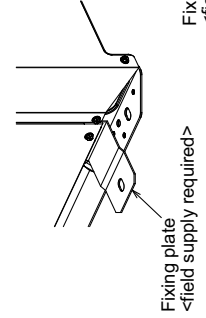

Fig.C (without detachable legs)

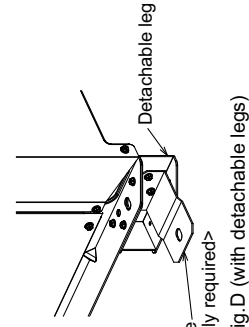

Fig.D (with detachable legs)

2. Foundation work

- ① Take into consideration the surface strength, water drainage route, piping route, and wiring route when preparing the installation site.
 - <Note that the drain water comes out of the unit during operation.>
- ② Build the foundation in such way that the corner of the installation leg is securely supported as shown in the right figure. (Fig.A,B)
 - When using a rubber isolating cushion, please ensure it is large enough to cover the entire width of each of the unit's legs.
- ③ The protrusion length of the anchor bolt must not exceed 30mm. (Fig.A,B)
- ④ Use four fixing plates as shown in the right figure <field supply required> when using post-installed anchor bolts. (Fig.C,D)
 - To prevent small animals and water and snow from entering the unit and damaging its parts, close the gap around the edges of through holes for pipes and wires with filler plates <field supply required>.
- ⑥ When the pipes or cables are routed at the bottom of the unit, make sure that the through hole at the base of the unit does not get blocked with the installation base.
- ⑦ Refer to the Installation Manual when installing units on an installation base.

PURY-EP550YSLM-A (-BS)

Unit : mm

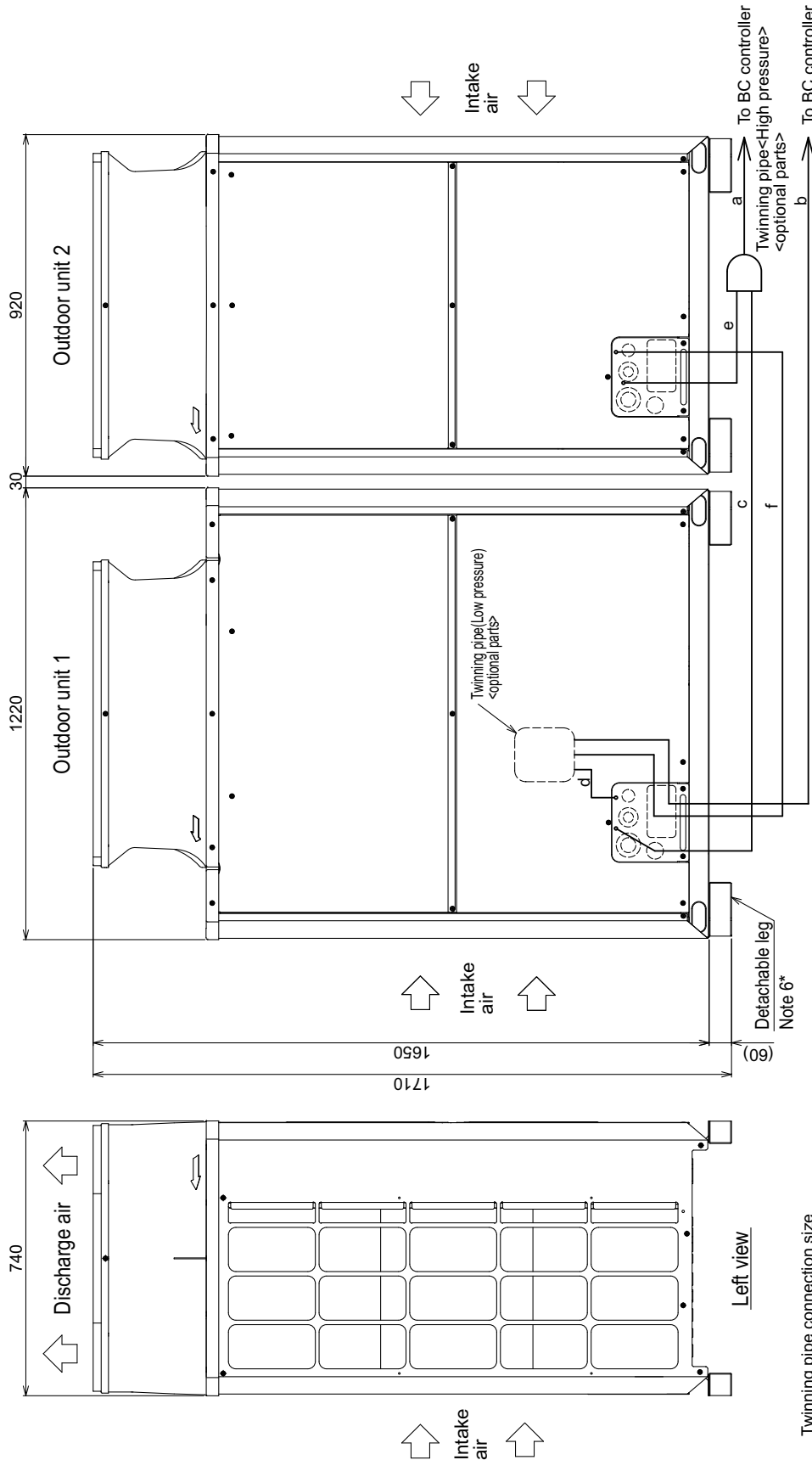

Front view

Unit model	EP550
Component unit model	EP250
Twinning Kit ~Outdoor unit	c ø19.05 e ø19.05 d - (Note 5) f ø22.2

Twinning pipe connection size

Package unit name	PURY-EP550YSLM-A(-BS)
Component unit name	Outdoor unit 1 PURY-EP300YLM-A(-BS) Outdoor unit 2 PURY-EP250YLM-A(-BS)
Outdoor Twinning Kit(optional parts)	CMY-ER200VBK
BC controller~Twinning pipe	High pressure a ø28.58 Low pressure b ø28.58

- Note 1. Connect the pipes as shown in the figure above. Refer to the table above for the pipe size.
 2. Twinning pipe (High pressure) should not be tilted more than 15 degrees from the horizontal plane.
 Be sure to see the Installation Manual for details of Twinning pipe installation.
 3. The pipe section before the Twinning pipe (section "a" in the figure) must have at least 500mm of straight section (*including the straight pipe that is supplied with the Twinning pipe).
 4. Only use the Twinning pipe by Mitsubishi (optional parts).
 5. Connect the outdoor unit 1 with the Twinning pipe (Low pressure) (section "d" in the figure).
 6. The detachable leg can be removed at site.

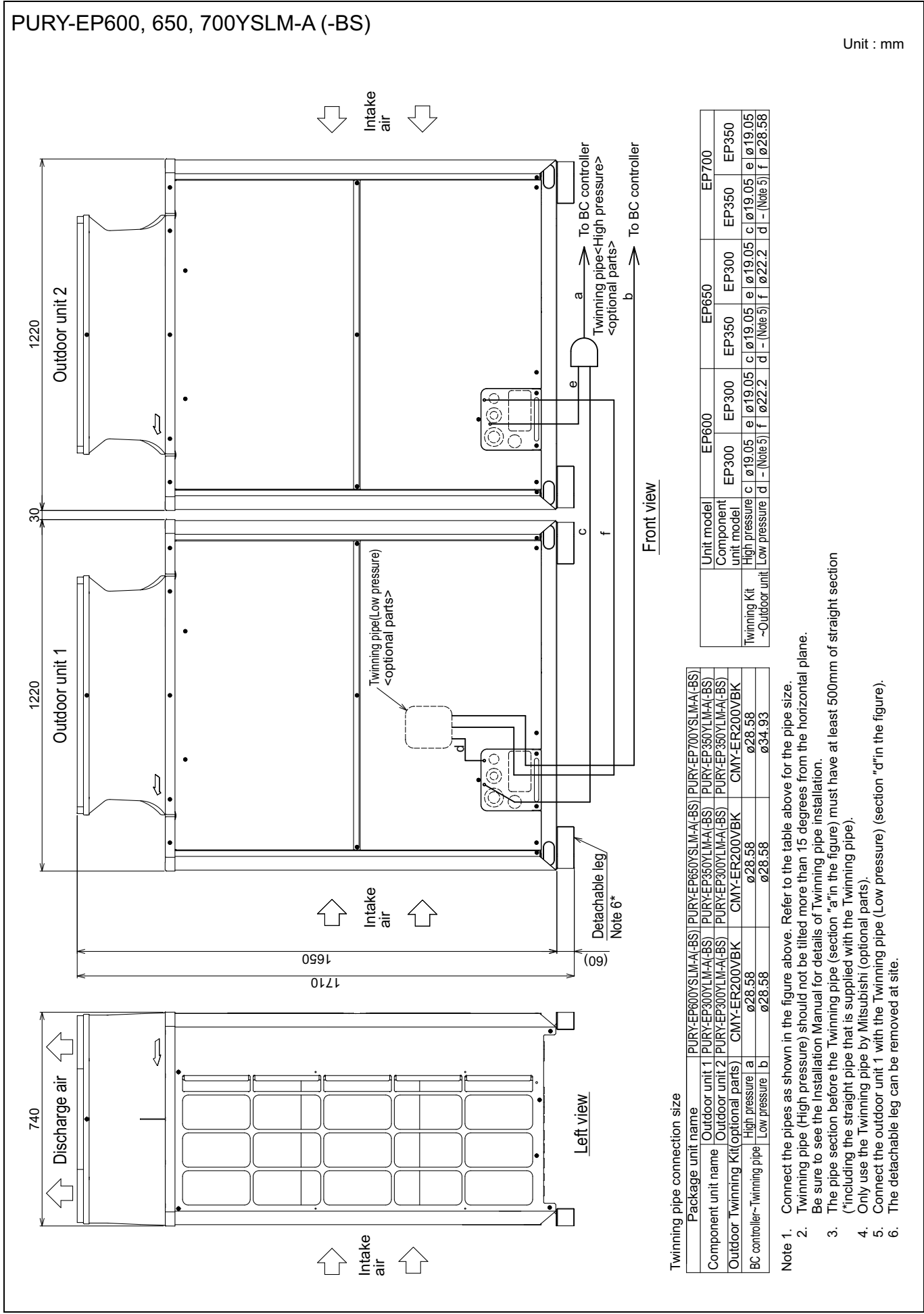

R2 (HIGH COP)

R2 (HIGH COP)

PURY-EP750YSLM-A (-BS)

Unit : mm

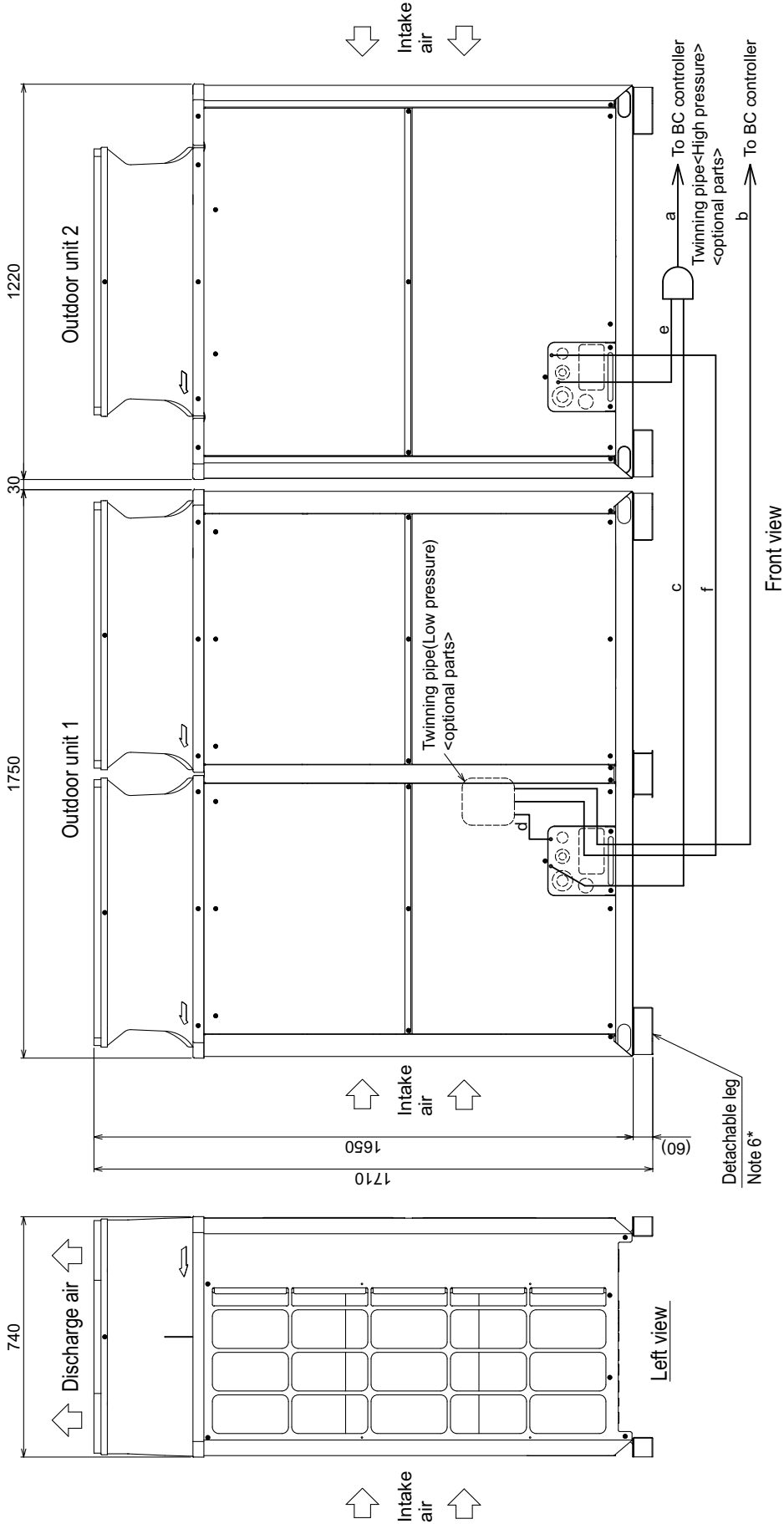

Front view

Left view

Unit model	EP750				
Component unit model	EP400	EP350			
Twinning Kit ~Outdoor unit	High pressure	c	ø22.2	e	ø19.05
	Low pressure	d - (Note 5)	f	ø28.58	

Twinning pipe connection size

Package unit name	PURY-EP750YSLM-A(-BS)		
Outdoor unit 1	PURY-EP400YLM-A(-BS)		
Outdoor unit 2	PURY-EP350YLM-A(-BS)		
Outdoor Twinning Kit(optional parts)	CMY-ER200VBK		
BC controller~Twinning pipe	High pressure	a	ø28.58
	Low pressure	b	ø34.93

- Note 1. Connect the pipes as shown in the figure above. Refer to the table above for the pipe size.
 2. Twinning pipe (High pressure) should not be tilted more than 15 degrees from the horizontal plane.
 Be sure to see the Installation Manual for details of Twinning pipe installation.
 3. The pipe section before the Twinning pipe (section "a" in the figure) must have at least 500mm of straight section (*including the straight pipe that is supplied with the Twinning pipe).
 4. Only use the Twinning pipe by Mitsubishi (optional parts).
 5. Connect the outdoor unit 1 with the Twinning pipe (Low pressure) (section "d" in the figure).
 6. The detachable leg can be removed at site.

Detachable leg
Note 6*

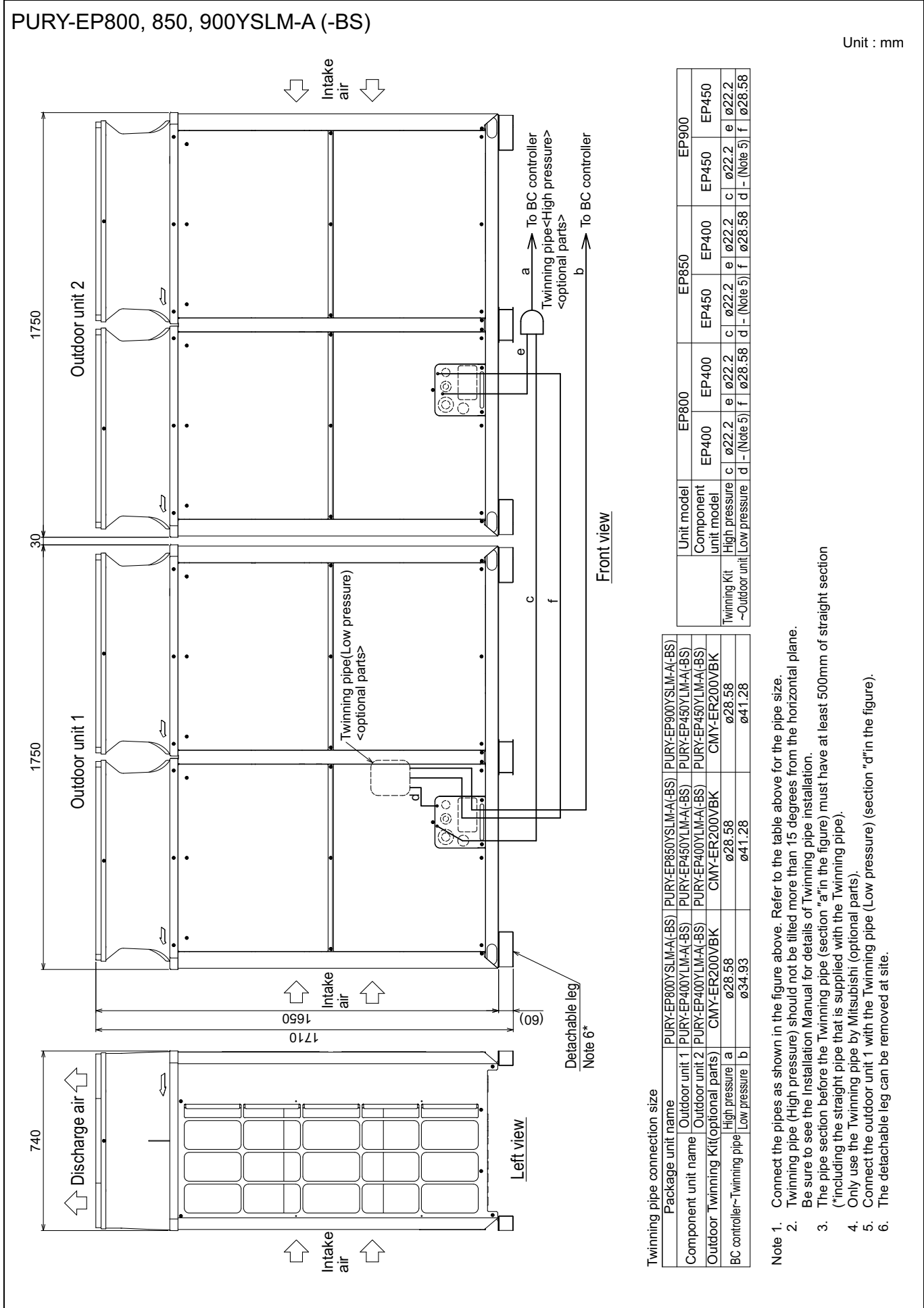

R2 (HIGH COP)

R2 (HIGH COP)

PURY-EP200, 250YLM-A (-BS)

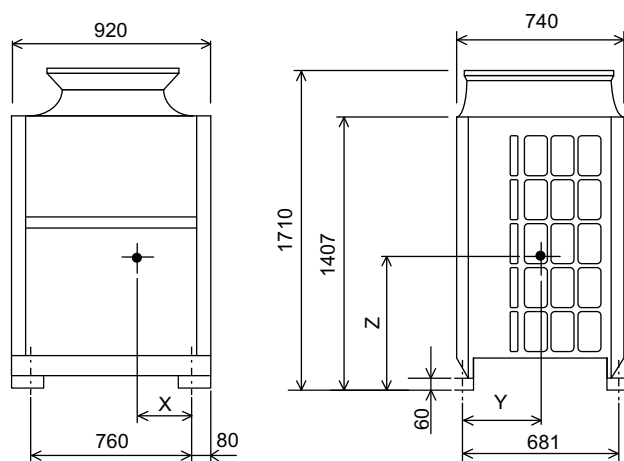

Unit : mm

Model	X	Y	Z
PURY-EP200YLM-A(-BS)	352	314	701
PURY-EP250YLM-A(-BS)	352	314	701

PURY-EP300, 350YLM-A (-BS)

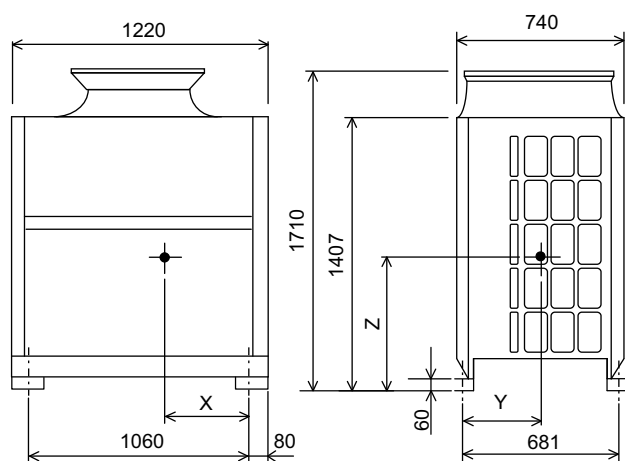

Unit : mm

Model	X	Y	Z
PURY-EP300YLM-A(-BS)	467	318	670
PURY-EP350YLM-A(-BS)	467	318	670

PURY-EP400, 450, 500YLM-A (-BS)

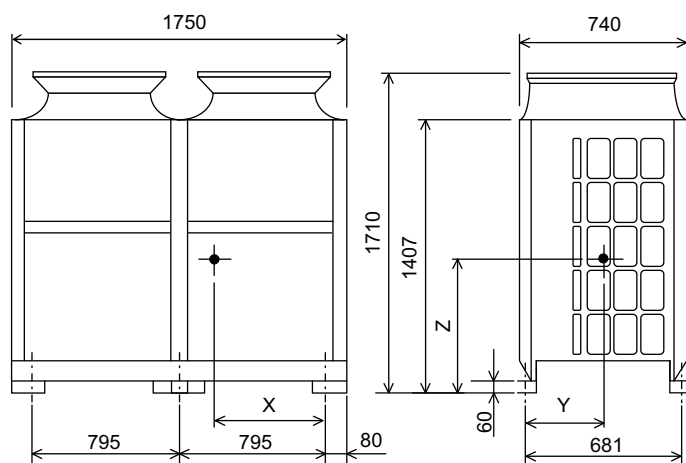

Unit : mm

Model	X	Y	Z
PURY-EP400YLM-A(-BS)	727	339	728
PURY-EP450YLM-A(-BS)	727	339	728
PURY-EP500YLM-A(-BS)	738	334	751

PURY-EP200, 250, 300, 350YLM-A(-BS)

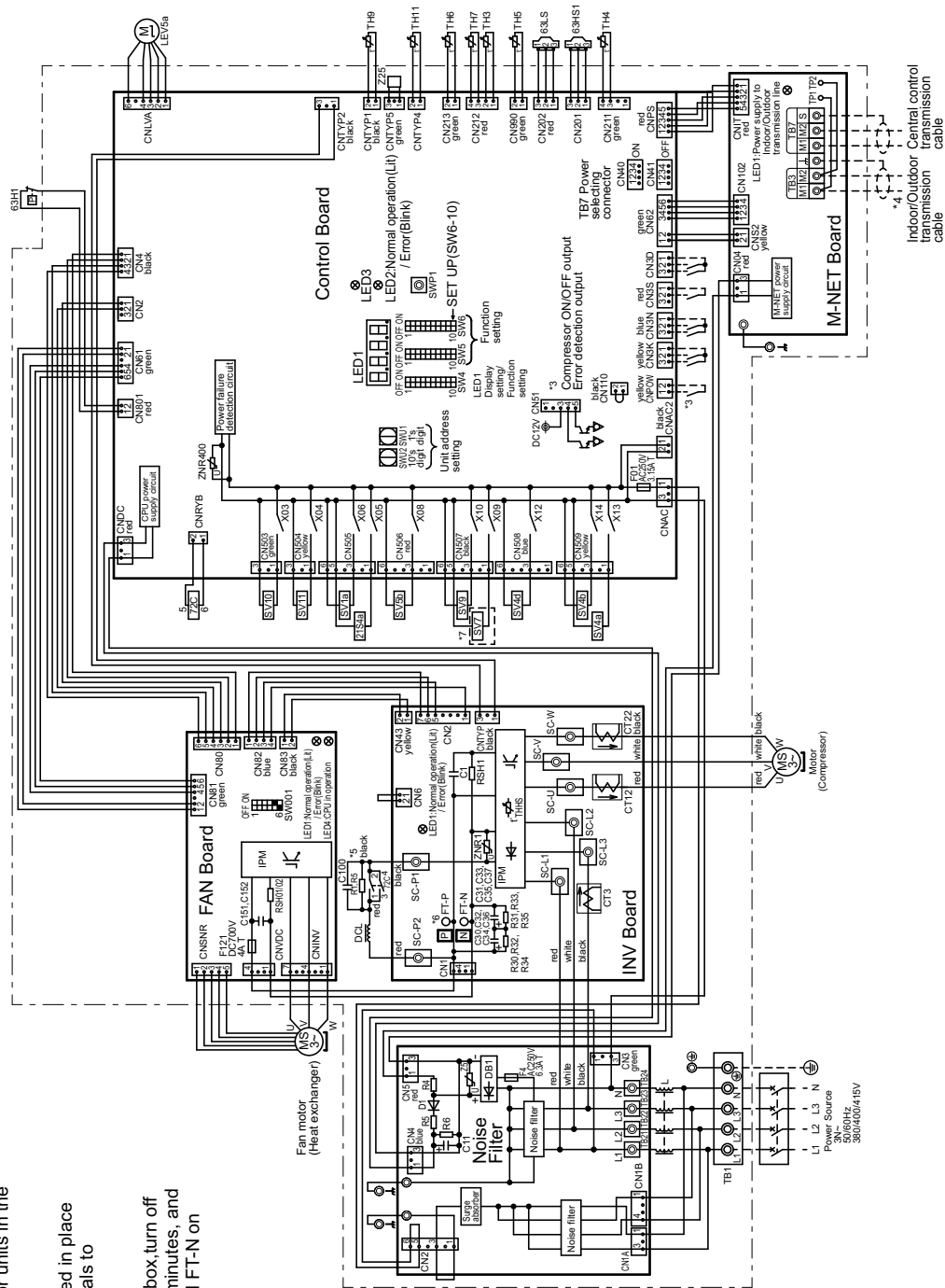

- *1. Single-dotted lines indicate wiring not supplied with the unit.
- *2. Dot-dash lines indicate the control box boundaries.
- *3. Refer to the Data book for connecting input/output signal connectors.
- *4. Daisy-chain terminals (TB3) on the outdoor units in the same refrigerant system together.
- *5. Faston terminals have a locking function. Make sure the terminals are securely locked in place after insertion. Press the tab on the terminals to removed them.
- *6. Control box houses high-voltage parts. Before inspecting the inside of the control box, turn off the power, keep the unit off for at least 10 minutes, and confirm that the voltage between FT-P and FT-N on INV Board has dropped to DC20V or less.
- *7. Difference of appliance.

Model name	appliance
P200/250/300/350/400	*7 do not exist
EP200/250/300/350	*7 exist

<Symbol explanation>

Symbol	Explanation
21SA4a	4-way valve(Cooling/Heating switching)
63H1	Pressure switch
63HS1	High pressure protection for the outdoor unit.
63LS	Pressure sensor
72C	Discharge pressure sensor
C30-C37	Low pressure sensor
C12, C122, C73	Magnetic relay(inverter main circuit)
DCL	Capacitor (inverter main circuit)
L	Current sensor(AC)
LEV6a	DC reactor
R1.5	Choke coil (for high frequency noise reduction) evaporating temperature)
RS10102, RS11	Resistor
SV1a	For inrush current prevention
SV4a, b, d	For current detection
SV5b	For opening/closing the bypass circuit under the O/S.
SV7, SV9	Heat exchanger capacity control capacity control
SV10, SV11	Outdoor unit heat exchanger capacity control
TB1	For opening/closing the bypass circuit
TB3	For opening/closing the defrost circuit
TB7	Power supply terminal block
TH3	Indoor/Outdoor transmission cable
TH4	Central control transmission cable
TH5	Pipe temperature
TH6	Discharge pipe temperature
TH7	ACC inlet pipe temperature
TH8, TH11	Subcooled liquid refrigerant temperature
THS	OA temperature
Z25	Heat exchanger outlet pipe temperature
	IPM temperature
	Function setting connector

PURY-EP400, 450YLM-A (-BS)

R2 (HIGH COP)

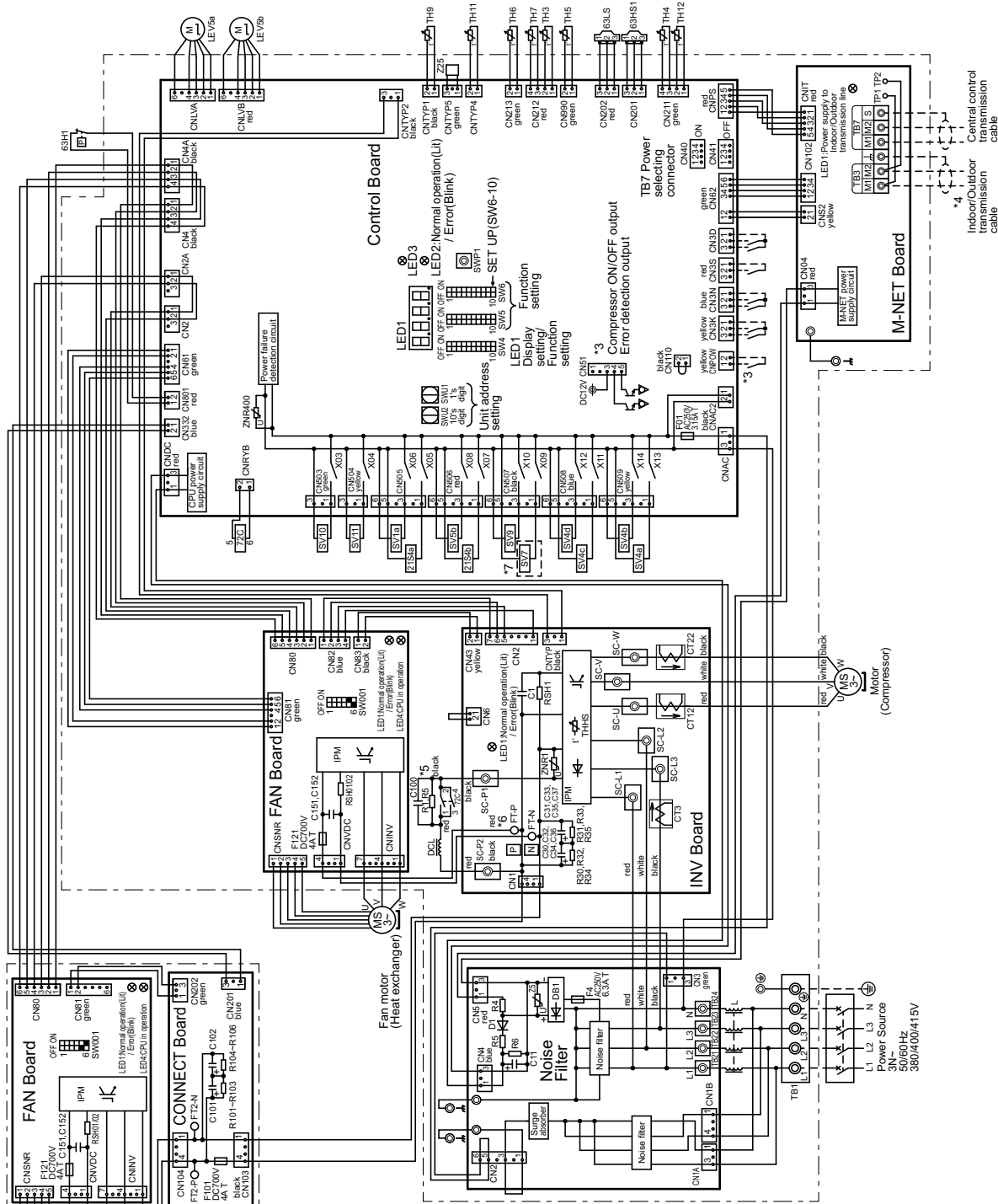

- *1. Single-dotted lines indicate wiring not supplied with the unit.
- *2. Dotted lines indicate the control box boundaries.
- *3. Refer to the Data Book for connecting input/output signal connectors.
- *4. Daisy-chain terminals (TB3) on the outdoor units in the same refrigerant system together.
- *5. Faston terminals have a locking function. Make sure the terminals are securely locked in place after insertion. Press the tab on the terminals to removed them.
- *6. Control box houses high-voltage parts. Before inspecting the inside of the control box, turn off the power, keep the unit off for at least 10 minutes, and confirm that the voltage between FT-P and FT-N on INV Board has dropped to DC20V or less.
- *7. Difference of appliance.

Model name	appliance
PA50/500	*7 do not exist
EP400/450	*7 exist

<Symbol explanation>

Symbol	Explanation
21S4a	4-way valve
21S4b	Cooling/heating switching
63H1	Heat exchanger capacity control pressure switch
63HS1	High pressure protection for the outdoor unit
93S	Pressure
93S	Discharge pressure
C30-C37	Low pressure
C12/C12(C1)	Magnetic relay (main circuit)
DCL	Capacitor (inverter main circuit)
DC reactor	Current sensor(AC)
LEV5a.b	Choke coil (for high frequency noise reduction)
RL5	Linear expansion valve (for the control of evaporating temperature)
R30/R31/R3H	Resistor
SV1a	For inrush current prevention
SV4a.b.c.d	For current detection
SV5b	Solenoid valve
SV7-SV9	Heat exchanger capacity control outdoor unit heat exchanger capacity control
SV10-SV11	For opening/closing the bypass circuit
TB1	For opening/closing the defrost circuit
TB2	Power supply
TB3	Indoor/Outdoor transmission cable
TB7	Central control transmission cable
TH3	Terminal block
TH4	Thermistor
TH5	Pipe temperature
TH6	Discharge pipe temperature
TH7	ACC inlet pipe temperature
TH8	Subcooled liquid refrigerant temperature
TH9	OA temperature
TH10	Heat exchanger outlet pipe temperature
TH11	Heat exchanger inlet pipe temperature
TH12	Heat exchanger inlet pipe temperature
ZZ3	Function setting connector

PURY-EP500YLM-A (-BS)

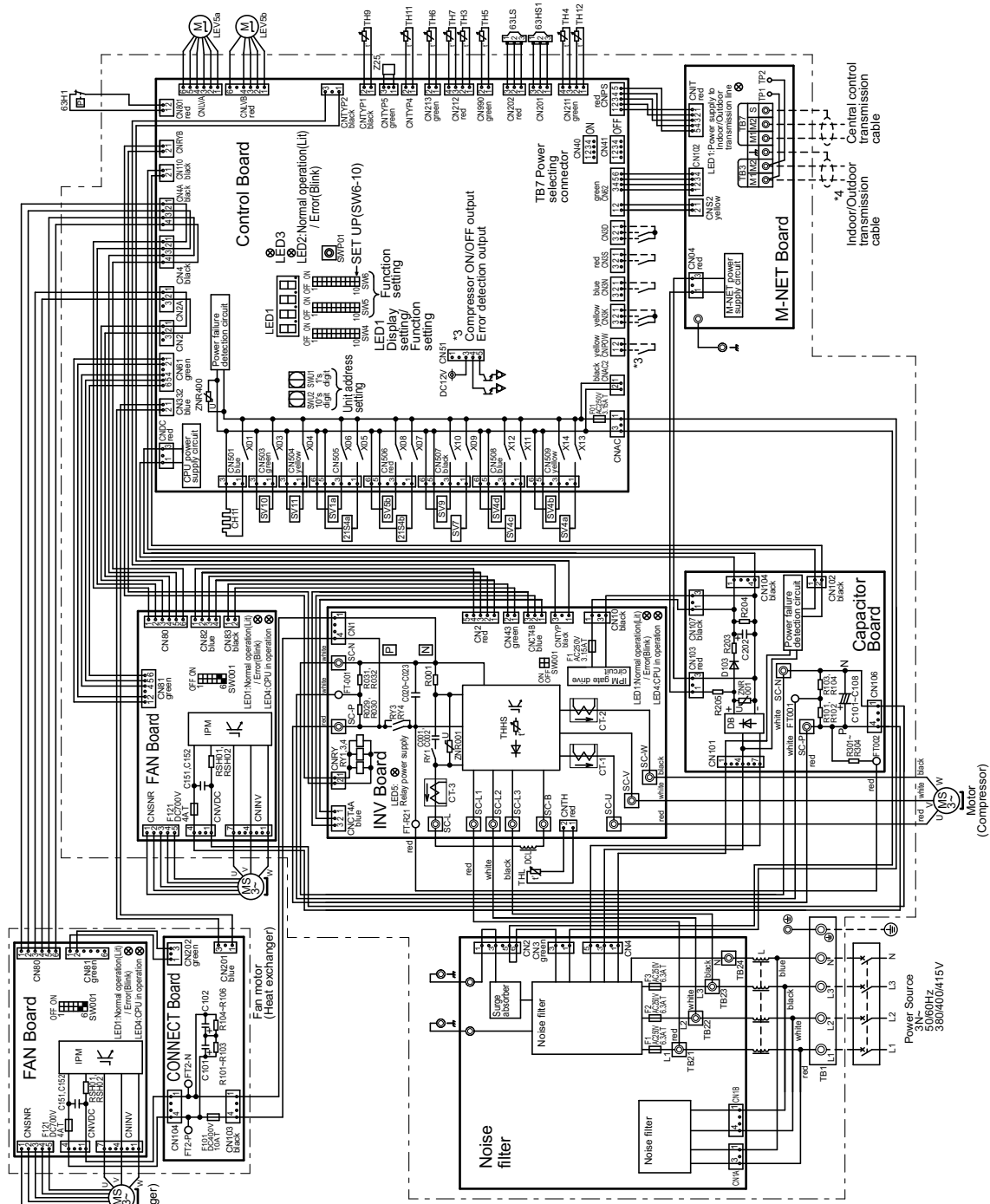

- *1. Single-dotted lines indicate wiring not supplied with the unit.
- *2. Dot-dash lines indicate the control box boundaries.
- *3. Refer to the Data book for connecting input/output signal connectors.
- *4. Daisy-chain terminals (TB3) on the outdoor units in the same refrigerant system together.
- *5. Faston terminals have a locking function. Make sure the terminals are securely locked in place after insertion. Press the tab on the terminals to removed them.
- *6. Control box houses high-voltage parts. Before inspecting the inside of the control box, turn off the power, keep the unit off for at least 10 minutes, and confirm that the voltage between SC-P and SC-N on Capacitor Board has dropped to DC20V or less.

<Symbol explanation>

Symbol	Explanation
21S4a	4-way valve
21S4b,c	Cooling/Heating switching
63H1	Heat exchanger capacity control
63H1	Pressure switch
63H1S	High pressure protection for the outdoor unit
63H1S	Discharge pressure sensor
RV1, RV4	Low pressure sensor
CT1, CT2	Magnetic relay
C001, C002	Inverter main circuit capacitor
CT-3	Inverter main circuit filter circuit
CH1	AC
DCL	DC
CH11	Crankcase heater (for heating the compressor)
L	DC reactor
LEV5a	Choke coil (for high frequency noise reduction)
LEV5b	Linear expansion valve
R307-R304	HIC bypass control
RS40, RS62	Pressure control, Refrigerant flow in HIC circuit
SV1a	Pressure control, Refrigerant flow rate control
SV4b-d	For inrush current prevention
SV7, SV9	For current detection
SV10, SV11	For opening/closing the bypass valve
TB1	Heat exchanger capacity control
TB3	Outdoor unit heat exchanger capacity control
TB7	For opening/closing the bypass circuit
TB8	Power supply
TH1, TH2	Indoor/Outdoor transmission cable terminal block
TH2	Subcool bypass outlet temperature
TH3	Pipe temperature
TH4	Discharge pipe temperature
TH5	ACC inlet pipe temperature
TH6	Subcool liquid refrigerant temperature
TH7	OA temperature
TH8, TH11, TH12	Heat exchanger outlet pipe temperature
THHS	IPM temperature
THL	DC reactor temperature
Z25	Function setting connector

R2 (HIGH COP)

Measurement condition
PURY-EP200, 250YLM-A(-BS)

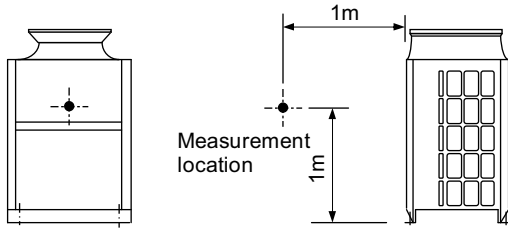

Measurement condition
PURY-EP300, 350YLM-A(-BS)

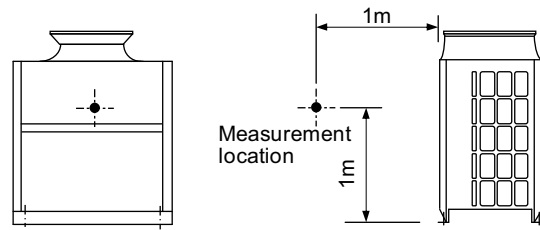

Sound level of PURY-EP200YLM-A(-BS)

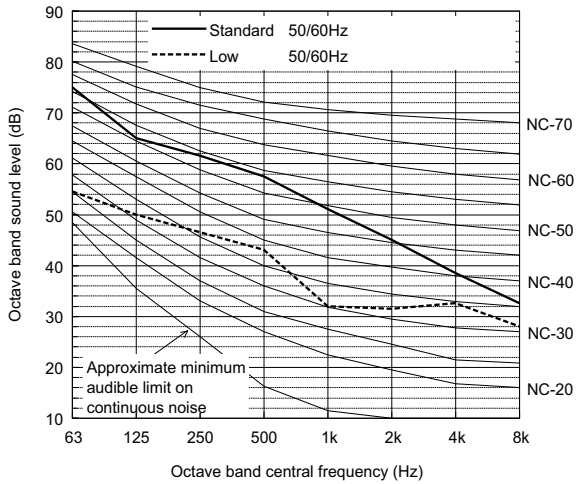

		63	125	250	500	1k	2k	4k	8k	dB(A)
Standard	50/60Hz	75.0	65.0	61.5	57.5	51.0	45.0	38.5	32.5	59.0
Low noise mode	50/60Hz	54.5	50.0	46.5	43.0	32.0	31.5	32.5	28.0	44.0

When Low noise mode is set, the A/C system's capacity is limited. The system could return to normal operation from Low noise mode automatically in the case that the operation condition is severe.

Sound level of PURY-EP300YLM-A(-BS)

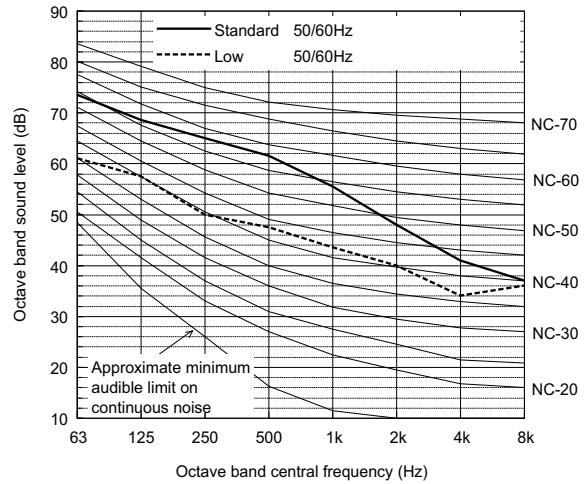

		63	125	250	500	1k	2k	4k	8k	dB(A)
Standard	50/60Hz	73.5	68.5	65.0	61.5	55.5	48.0	41.0	37.0	62.5
Low noise mode	50/60Hz	61.0	57.5	50.0	47.5	43.5	40.0	34.0	36.0	50.0

When Low noise mode is set, the A/C system's capacity is limited. The system could return to normal operation from Low noise mode automatically in the case that the operation condition is severe.

Sound level of PURY-EP250YLM-A(-BS)

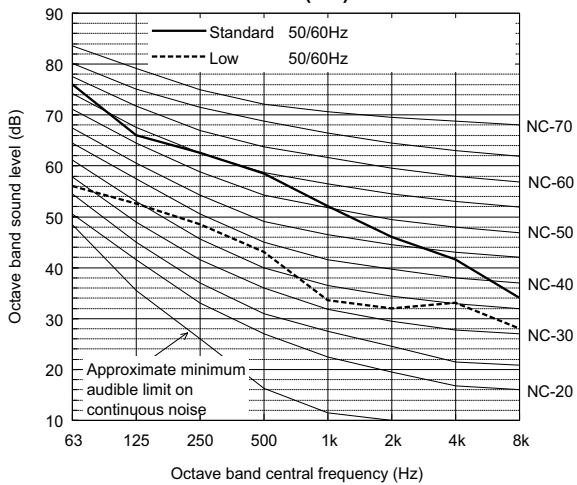

		63	125	250	500	1k	2k	4k	8k	dB(A)
Standard	50/60Hz	76.0	66.0	62.5	58.5	52.0	46.0	41.5	34.0	60.0
Low noise mode	50/60Hz	56.0	52.5	48.5	43.0	33.5	32.0	33.0	28.0	45.0

When Low noise mode is set, the A/C system's capacity is limited. The system could return to normal operation from Low noise mode automatically in the case that the operation condition is severe.

Sound level of PURY-EP350YLM-A(-BS)

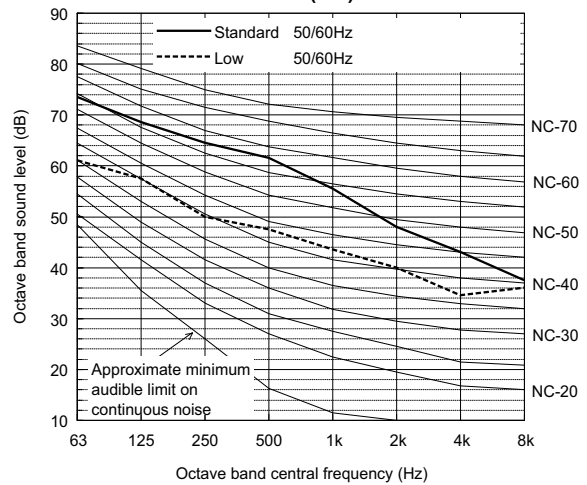

		63	125	250	500	1k	2k	4k	8k	dB(A)
Standard	50/60Hz	73.5	68.5	64.5	61.5	55.5	48.0	43.0	37.5	62.5
Low noise mode	50/60Hz	61.0	57.5	50.0	47.5	43.5	40.0	34.5	36.0	50.0

When Low noise mode is set, the A/C system's capacity is limited. The system could return to normal operation from Low noise mode automatically in the case that the operation condition is severe.

♦ Depending on the operation conditions, the unit generates noise caused by valve actuation, refrigerant flow, and pressure changes when operating normally. Please consider to avoid location where quietness is required. For BC controller, it is recommended to be installed in places such as ceilings of corridor, rest rooms and plant rooms.

Measurement condition
PURY-EP400, 450, 500YLM-A(-BS)

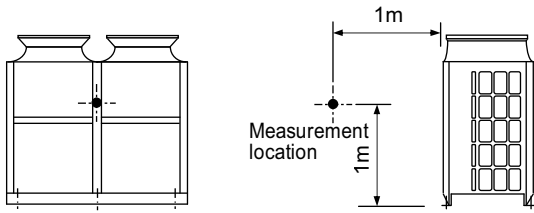

Sound level of PURY-EP500YLM-A(-BS)

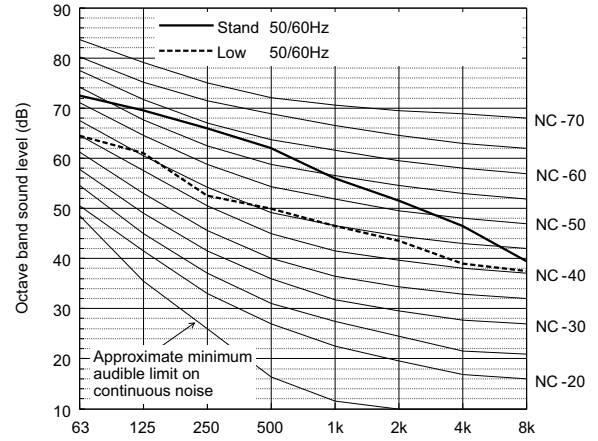

		63	125	250	500	1k	2k	4k	8k	dB(A)
Standard	50/60Hz	72.5	69.5	66.0	62.0	56.0	51.5	46.5	39.5	63.5
Low noise mode	50/60Hz	64.5	61.0	52.5	50.0	46.5	43.5	39.0	37.5	53.0

When Low noise mode is set, the A/C system's capacity is limited. The system could return to normal operation from Low noise mode automatically in the case that the operation condition is severe.

Sound level of PURY-EP400YLM-A(-BS)

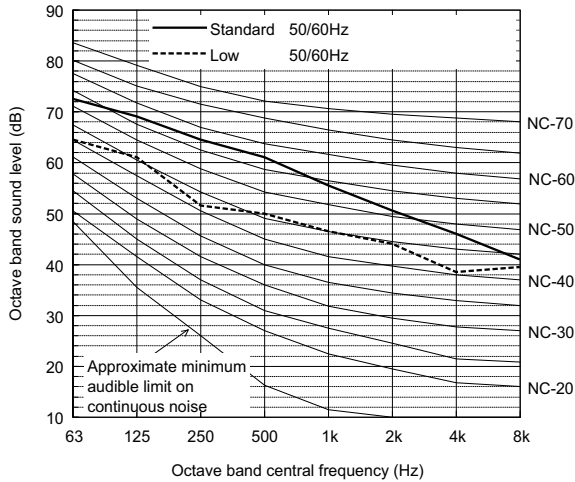

		63	125	250	500	1k	2k	4k	8k	dB(A)
Standard	50/60Hz	72.5	69.0	64.5	61.0	55.5	50.5	46.0	41.0	62.5
Low noise mode	50/60Hz	64.5	61.0	51.5	50.0	46.5	44.0	38.5	39.5	53.0

When Low noise mode is set, the A/C system's capacity is limited. The system could return to normal operation from Low noise mode automatically in the case that the operation condition is severe.

Sound level of PURY-EP450YLM-A(-BS)

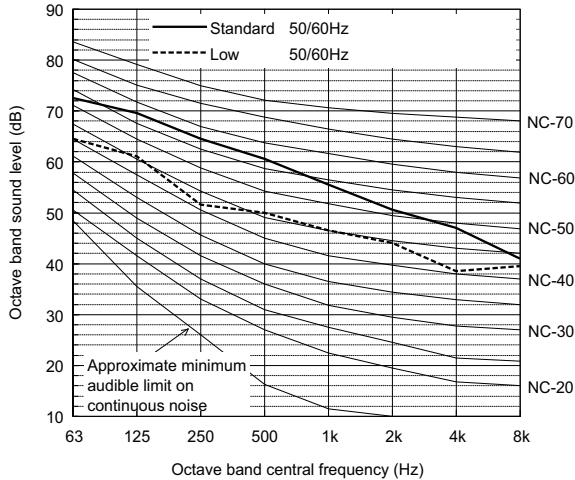

		63	125	250	500	1k	2k	4k	8k	dB(A)
Standard	50/60Hz	72.5	69.5	64.5	60.5	55.5	50.5	47.0	41.0	62.5
Low noise mode	50/60Hz	64.5	61.0	51.5	50.0	46.5	44.0	38.5	39.5	53.0

When Low noise mode is set, the A/C system's capacity is limited. The system could return to normal operation from Low noise mode automatically in the case that the operation condition is severe.

- Depending on the operation conditions, the unit generates noise caused by valve actuation, refrigerant flow, and pressure changes when operating normally. Please consider to avoid location where quietness is required. For BC controller, it is recommended to be installed in places such as ceilings of corridor, rest rooms and plant rooms.

Measurement condition
PURY-EP550YSLM-A(-BS)

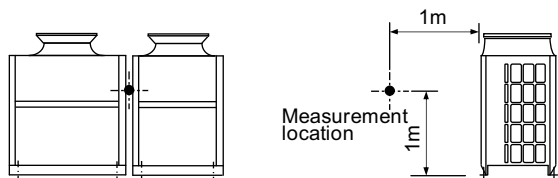

Measurement condition
PURY-EP600, 650, 700YSLM-A(-BS)

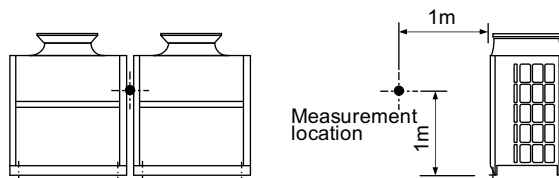

Sound level of PURY-EP550YSLM-A(-BS)

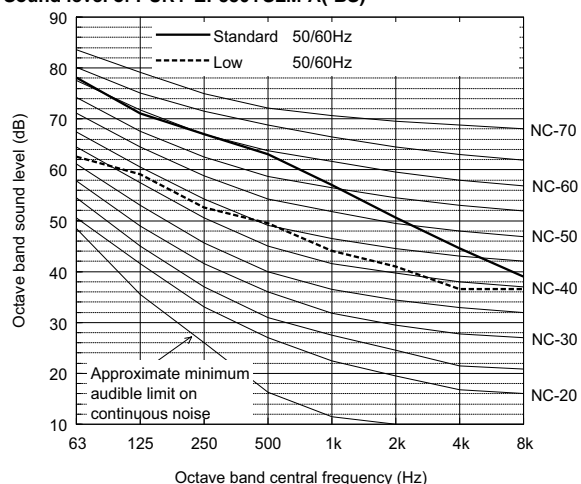

		63	125	250	500	1k	2k	4k	8k	dB(A)
Standard	50/60Hz	78.0	71.0	67.0	63.0	57.0	50.5	44.5	39.0	64.5
Low noise mode	50/60Hz	62.5	59.0	52.5	49.5	44.0	41.0	36.5	36.5	51.5

When Low noise mode is set, the A/C system's capacity is limited. The system could return to normal operation from Low noise mode automatically in the case that the operation condition is severe.

Sound level of PURY-EP600YSLM-A(-BS)

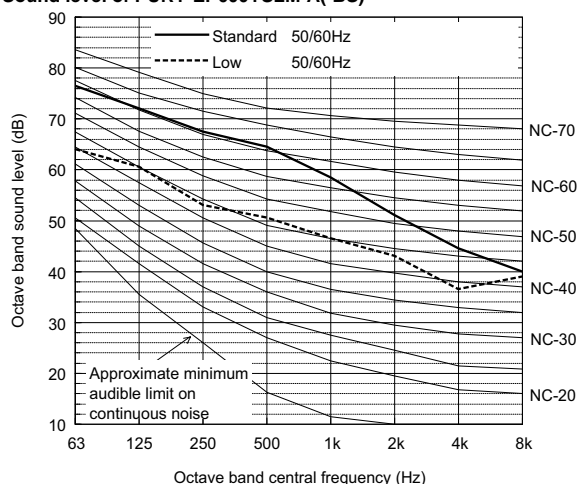

		63	125	250	500	1k	2k	4k	8k	dB(A)
Standard	50/60Hz	76.5	72.0	67.5	64.5	58.5	51.0	44.5	40.0	65.5
Low noise mode	50/60Hz	64.0	60.5	53.0	50.5	46.5	43.0	36.5	39.0	53.0

When Low noise mode is set, the A/C system's capacity is limited. The system could return to normal operation from Low noise mode automatically in the case that the operation condition is severe.

Sound level of PURY-EP650YSLM-A(-BS)

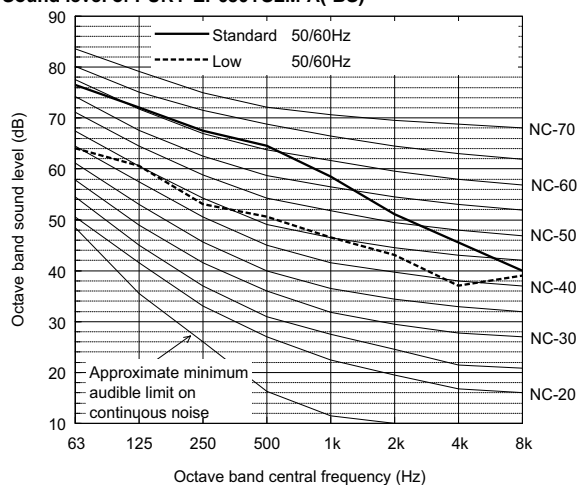

		63	125	250	500	1k	2k	4k	8k	dB(A)
Standard	50/60Hz	76.5	72.0	67.5	64.5	58.5	51.0	45.5	40.0	65.5
Low noise mode	50/60Hz	64.0	60.5	53.0	50.5	46.5	43.0	37.0	39.0	53.0

When Low noise mode is set, the A/C system's capacity is limited. The system could return to normal operation from Low noise mode automatically in the case that the operation condition is severe.

• Depending on the operation conditions, the unit generates noise caused by valve actuation, refrigerant flow, and pressure changes when operating normally. Please consider to avoid location where quietness is required. For BC controller, it is recommended to be installed in places such as ceilings of corridor, rest rooms and plant rooms.

Sound level of PURY-EP700YSLM-A(-BS)

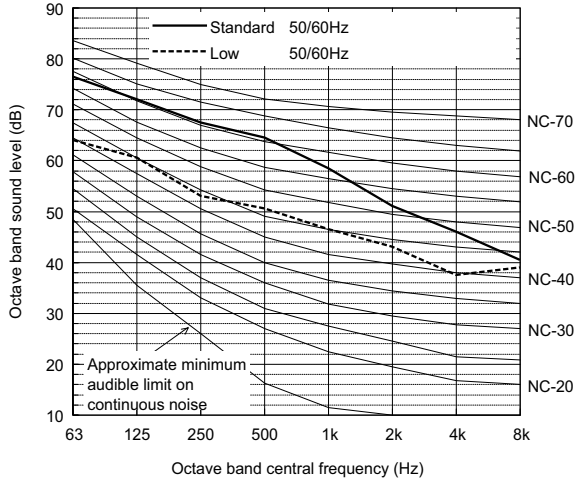

		63	125	250	500	1k	2k	4k	8k	dB(A)
Standard	50/60Hz	76.5	72.0	67.5	64.5	58.5	51.0	46.0	40.5	65.5
Low noise mode	50/60Hz	64.0	60.5	53.0	50.5	46.5	43.0	37.5	39.0	53.0

When Low noise mode is set, the A/C system's capacity is limited. The system could return to normal operation from Low noise mode automatically in the case that the operation condition is severe.

Measurement condition
PURY-EP750YSLM-A(-BS)

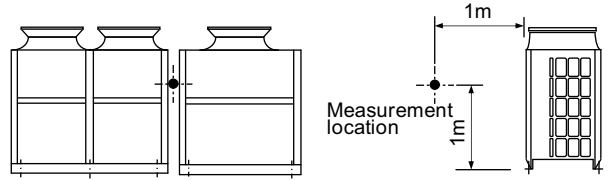

Sound level of PURY-EP750YSLM-A(-BS)

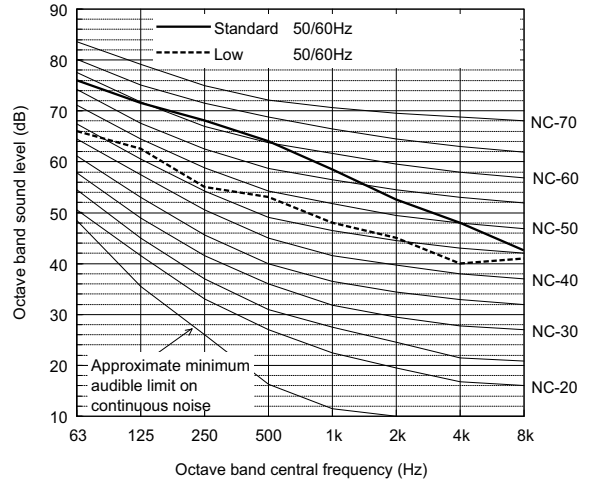

		63	125	250	500	1k	2k	4k	8k	dB(A)
Standard	50/60Hz	76.0	71.5	68.0	64.0	58.5	52.5	48.0	42.5	65.5
Low noise mode	50/60Hz	66.0	62.5	55.0	53.0	48.0	45.0	40.0	41.0	55.0

When Low noise mode is set, the A/C system's capacity is limited. The system could return to normal operation from Low noise mode automatically in the case that the operation condition is severe.

- Depending on the operation conditions, the unit generates noise caused by valve actuation, refrigerant flow, and pressure changes when operating normally. Please consider to avoid location where quietness is required. For BC controller, it is recommended to be installed in places such as ceilings of corridor, rest rooms and plant rooms.

Measurement condition
PURY-EP800, 850, 900YSLM-A(-BS)

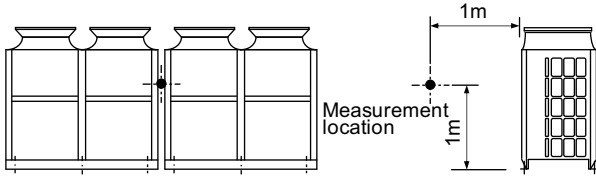

Sound level of PURY-EP900YSLM-A(-BS)

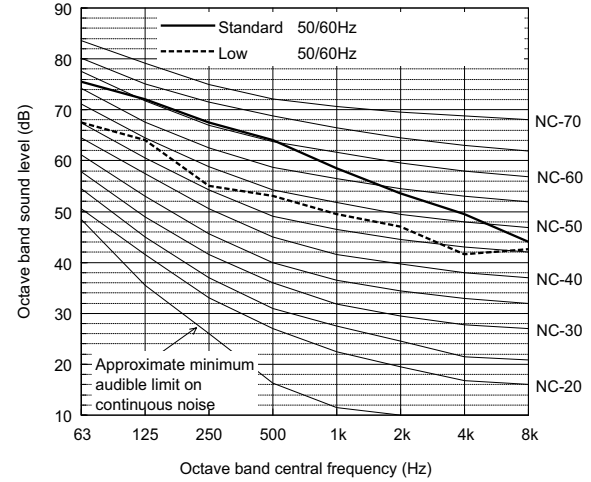

		63	125	250	500	1k	2k	4k	8k	dB(A)
Standard	50/60Hz	75.5	72.0	67.5	64.0	58.5	53.5	49.5	44.0	65.5
Low noise mode	50/60Hz	67.5	64.0	55.0	53.0	49.5	47.0	41.5	42.5	56.0

When Low noise mode is set, the A/C system's capacity is limited. The system could return to normal operation from Low noise mode automatically in the case that the operation condition is severe.

Sound level of PURY-EP800YSLM-A(-BS)

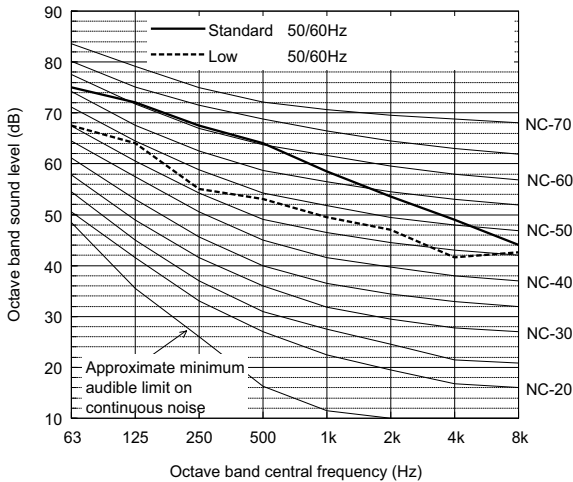

		63	125	250	500	1k	2k	4k	8k	dB(A)
Standard	50/60Hz	75.0	72.0	67.5	64.0	58.5	53.5	49.0	44.0	65.5
Low noise mode	50/60Hz	67.5	64.0	55.0	53.0	49.5	47.0	41.5	42.5	56.0

When Low noise mode is set, the A/C system's capacity is limited. The system could return to normal operation from Low noise mode automatically in the case that the operation condition is severe.

Sound level of PURY-EP850YSLM-A(-BS)

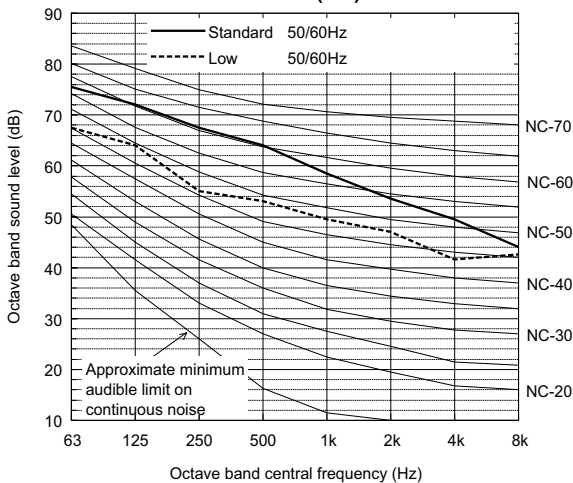

		63	125	250	500	1k	2k	4k	8k	dB(A)
Standard	50/60Hz	75.5	72.0	67.5	64.0	58.5	53.5	49.5	44.0	65.5
Low noise mode	50/60Hz	67.5	64.0	55.0	53.0	49.5	47.0	41.5	42.5	56.0

When Low noise mode is set, the A/C system's capacity is limited. The system could return to normal operation from Low noise mode automatically in the case that the operation condition is severe.

- Depending on the operation conditions, the unit generates noise caused by valve actuation, refrigerant flow, and pressure changes when operating normally. Please consider to avoid location where quietness is required. For BC controller, it is recommended to be installed in places such as ceilings of corridor, rest rooms and plant rooms.

[PURY-EP200-500YLM, PURY-EP550-900YSLM]

Measurement condition

Measurement frequency: 1 Hz-80 Hz

Measurement point: Ground surface 20 cm away from the unit leg

Installation condition: Direct installation on the concrete floor

Power source: 3-phase 4-wire 380-400-415 V 50/60 Hz

Operation condition: JIS condition (cooling, heating)

Measurement device: Vibration level meter for vibration pollution VM-1220C (JIS-compliant product)

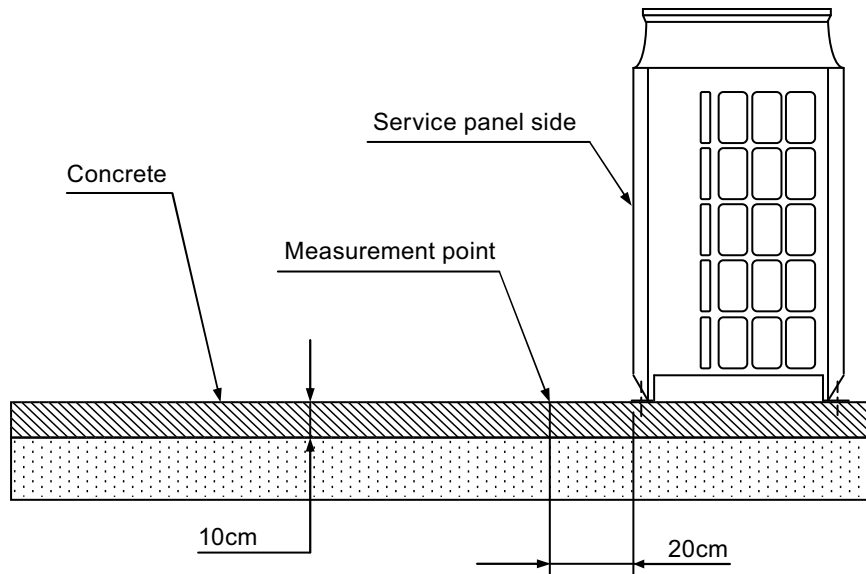

Vibration level

Model	Vibration level (dB)
PURY-EP200YLM-A (-BS)	45
PURY-EP250YLM-A (-BS)	46
PURY-EP300YLM-A (-BS)	47
PURY-EP350YLM-A (-BS)	47
PURY-EP400YLM-A (-BS)	47
PURY-EP450YLM-A (-BS)	47
PURY-EP500YLM-A (-BS)	48
PURY-EP550YSLM-A (-BS)	49.5
PURY-EP600YSLM-A (-BS)	50
PURY-EP650YSLM-A (-BS)	50
PURY-EP700YSLM-A (-BS)	50
PURY-EP750YSLM-A (-BS)	50
PURY-EP800YSLM-A (-BS)	50
PURY-EP850YSLM-A (-BS)	50
PURY-EP900YSLM-A (-BS)	50

R2 (HIGH COP)

• Cooling only

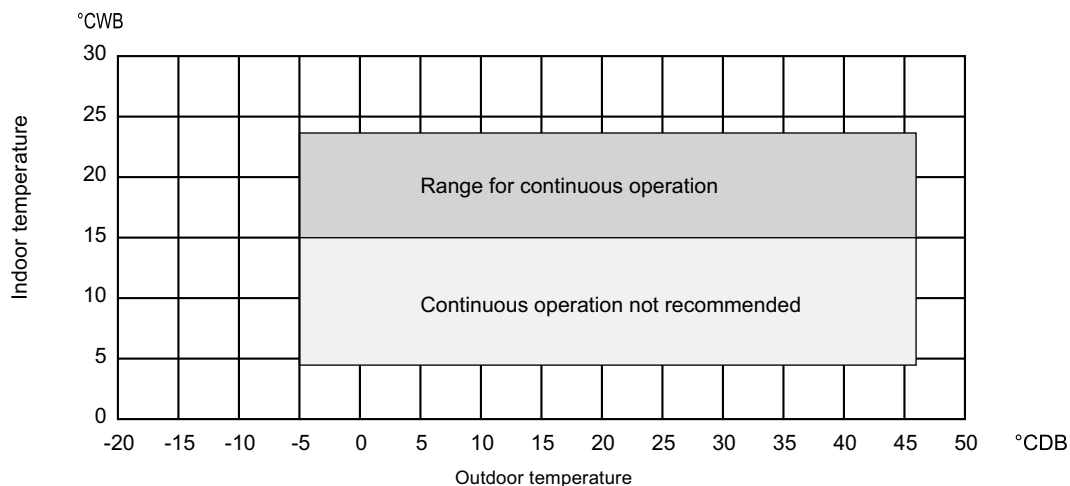

• Heating only

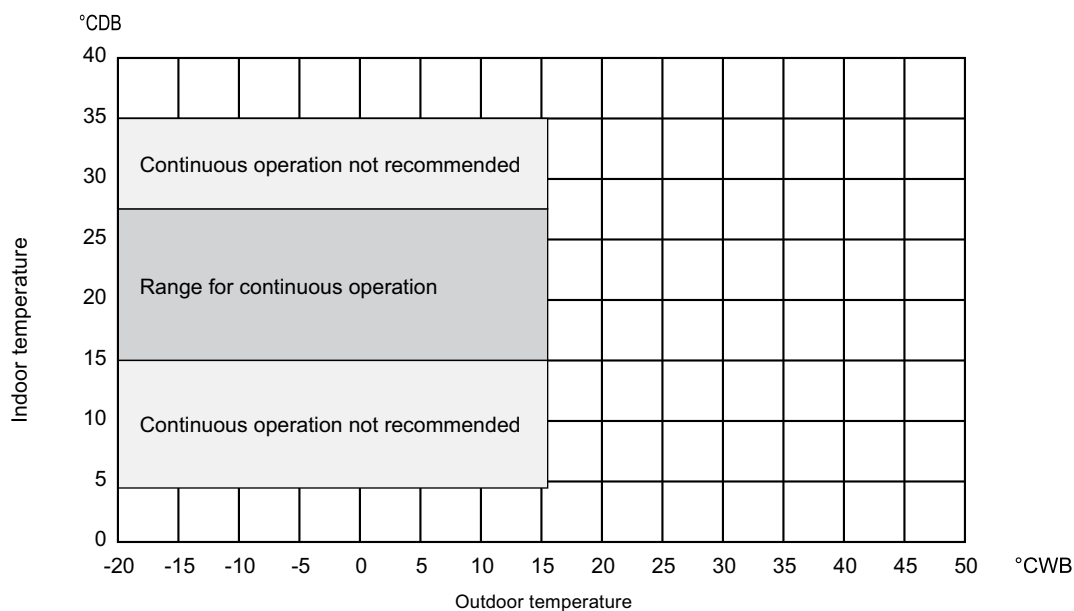

• Combination of cooling/heating operation (Cooling main or Heating main)

Outdoor temperature	Indoor temperature	
	Cooling	Heating
-10 to 21°CDB (14 to 70°FDB)	—	15 to 27°CDB (59 to 81°FDB)
-11 to 15.5°CWB (12.2 to 60°FWB)	15 to 24°CWB (59 to 75°FWB)	—

Section 8-1.

Shows an example of how to select the indoor and outdoor units according to the required heating/cooling load.

Section 8-2. through 8-6.

Show the actual correction data of indoor and outdoor units.

8-1. Selection of Cooling/Heating Units

<Cooling>

Design Condition	
Outdoor Design Dry Bulb Temperature	43 °C
Total Cooling Load	18.0 kW
Room1	
Indoor Design Dry Bulb Temperature	27 °C
Indoor Design Wet Bulb Temperature	20 °C
Cooling Load	8.0 kW
Room2	
Indoor Design Dry Bulb Temperature	24 °C
Indoor Design Wet Bulb Temperature	17 °C
Cooling Load	10.0 kW
<Other>	
Indoor/Outdoor Equivalent Piping Length	50 m

1. Cooling Calculation

(1) Temporary Selection of Indoor Units

Room1	PEFY-P80	9 kW (Rated)
Room2	PEFY-P100	11.2 kW (Rated)

(2) Total Indoor Units Capacity

$P80 + P100 = P180$

(3) Selection of Outdoor Unit

The P200 outdoor unit is selected as total indoor units capacity is P180

PUHY-P200	22.4 kW
-----------	---------

(4) Total Indoor Units Capacity Correction Calculation

Room1	Indoor Design Wet Bulb Temperature Correction (20°C)	1.04 (Refer to Fig.1)
Room2	Indoor Design Wet Bulb Temperature Correction (17°C)	0.95 (Refer to Fig.1)

Total Indoor Units Capacity (CTi)

$$CTi = \sum (\text{Indoor Unit Rating} \times \text{Indoor Design Temperature Correction})$$

$$= 9.0 \times 1.04 + 11.2 \times 0.95$$

$$= 20.0 \text{ kW}$$

(5) Outdoor Unit Correction Calculation

Outdoor Design Dry Bulb Temperature Correction (43°C)	0.94 (Refer to Fig.2)
Piping Length Correction (50 m)	0.94 (Refer to Fig.3)

Total Outdoor Unit Capacity (CTo)

$$CTo = \text{Outdoor Rating} \times \text{Outdoor Design Temperature Correction} \times \text{Piping Length Correction}$$

$$= 22.4 \times 0.94 \times 0.94$$

$$= 19.9 \text{ kW}$$

(6) Determination of Maximum System Capacity

Comparison of Capacity between Total Indoor Units Capacity (CTi) and Total Outdoor Unit Capacity (CTo)

$CTi = 20.0 > CTo = 19.9$, thus, select CTo.

$CTx = CTo = 19.9 \text{ kW}$

(7) Comparison with Essential Load

Against the essential load 18.0kW, the maximum system capacity is 19.9kW: Proper outdoor units have been selected.

(8) Calculation of Maximum Indoor Unit Capacity of Each Room

$CTx = CTo$, thus, calculate by the calculation below

Room1

$$\text{Maximum Capacity} \times \text{Room1 Capacity after the Temperature Correction} / (\text{Room1,2 Total Capacity after the Temperature Correction})$$

$$= 19.9 \times (9.0 \times 1.04) / (9.0 \times 1.04 + 11.2 \times 0.95)$$

$$= 9.3 \text{ kW} \quad \text{OK: fulfills the load 8.0kW}$$

Room2

$$\text{Maximum Capacity} \times \text{Room2 Capacity after the Temperature Correction} / (\text{Room1,2 Total Capacity after the Temperature Correction})$$

$$= 19.9 \times (11.2 \times 0.95) / (9.0 \times 1.04 + 11.2 \times 0.95)$$

$$= 10.6 \text{ kW} \quad \text{OK: fulfills the load 10.0kW}$$

Go on to the heating trial calculation since the selected units fulfill the cooling loads of Room 1, 2.

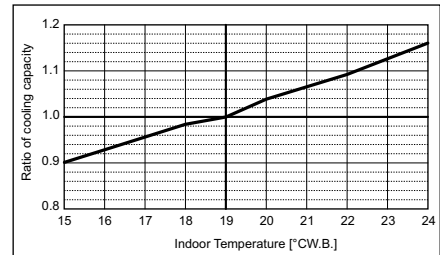

Fig.1 Indoor unit temperature correction
To be used to correct indoor unit only

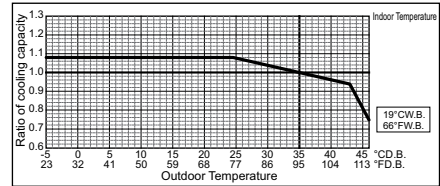

Fig.2 Outdoor unit temperature correction
To be used to correct outdoor unit only

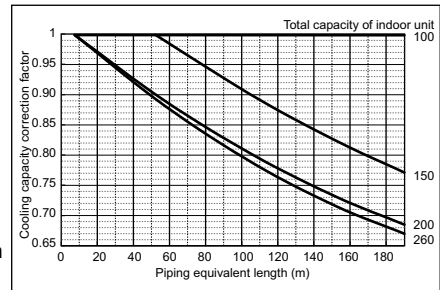

Fig.3 Correction of refrigerant piping length

<Heating>

Design Condition	
Outdoor Design Wet Bulb Temperature	-3 °C
Total Heating Load	20.5 kW
Room1	
Indoor Design Dry Bulb Temperature	21 °C
Heating Load	9.5 kW
Room2	
Indoor Design Dry Bulb Temperature	23 °C
Heating Load	11.0 kW
<Other>	
Indoor/Outdoor Equivalent Piping Length	50 m

2. Heating Calculation

(1) Temporary Selection of Indoor Units

Room1	PEFY-P80	10 kW (Rated)
Room2	PEFY-P100	12.5 kW (Rated)

(2) Total Indoor Units Capacity

P80 + P100 = P180

(3) Selection of Outdoor Unit

The P200 outdoor unit is selected as total indoor units capacity is P180

PUHY-P200	25.0 kW
-----------	---------

(4) Total Indoor Units Capacity Correction Calculation

Room1	Indoor Design Dry Bulb Temperature Correction (21°C)	0.97 (Refer to Fig.4)
Room2	Indoor Design Dry Bulb Temperature Correction (23°C)	0.90 (Refer to Fig.4)

Total Indoor Units Capacity (CTi)

$$CTi = \sum (\text{Indoor Unit Rating} \times \text{Indoor Design Temperature Correction})$$

$$= 10.0 \times 0.97 + 12.5 \times 0.90$$

$$= 21.0 \text{ kW}$$

(5) Outdoor Unit Correction Calculation

Outdoor Design Wet Bulb Temperature Correction (-3°C)	0.98 (Refer to Fig.5)
Piping Length Correction (50 m)	0.97 (Refer to Fig.6)
Defrost Correction	0.89 (Refer to Tbl.1)

Total Outdoor Unit Capacity (CTo)

$$CTo = \text{Outdoor Unit Rating} \times \text{Outdoor Design Temperature Correction} \times \text{Piping Length Correction} \times \text{Defrost Correction}$$

$$= 25.0 \times 0.98 \times 0.97 \times 0.89$$

$$= 21.1 \text{ kW}$$

(6) Determination of Maximum System Capacity

Comparison of Capacity between Total Indoor Units Capacity (CTi) and Total Outdoor Unit Capacity (CTo)

CTi = 21.0 < CTo = 21.1, thus, select CTi.

CTx = CTi = 21.0 kW

(7) Comparison with Essential Load

Against the essential load 20.5kW, the maximum system capacity is 21.0kW: Proper outdoor units have been selected.

(8) Calculation of Maximum Indoor Unit Capacity of Each Room

CTx = CTi, thus, calculate by the calculation below

Room1	Indoor Unit Rating × Indoor Design Temperature Correction	OK: fulfills the load 9.5kW
	= 10.0 × 0.97	
	= 9.7 kW	

Room2	Indoor Unit Rating × Indoor Design Temperature Correction	OK: fulfills the load 11.0kW
	= 12.5 × 0.90	
	= 11.3 kW	

Completed selecting units since the selected units fulfill the heating loads of Room 1, 2.

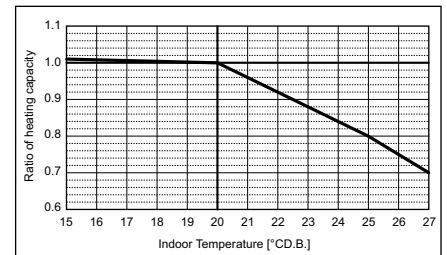

Fig.4 Indoor unit temperature correction
To be used to correct indoor unit only

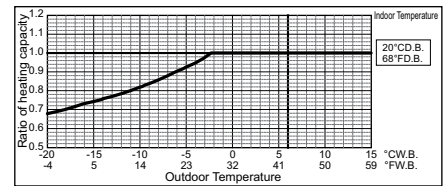

Fig.5 Outdoor unit temperature correction
To be used to correct outdoor unit only

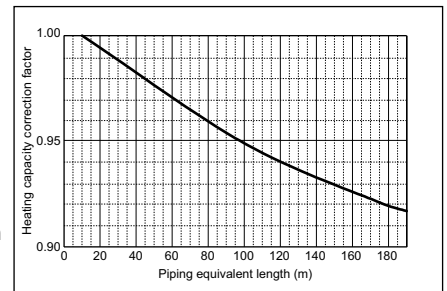

Fig.6 Correction of refrigerant piping length

Tbl.1 Table of correction factor at frost and defrost

Outdoor inlet air temp. °C	6	4	2	1	0	-2	-4	-6	-8	-10	-20
Outdoor inlet air temp. °F	43	39	36	34	32	28	25	21	18	14	-4
PUHY-P200	1.00	0.95	0.84	0.825	0.83	0.87	0.90	0.95	0.95	0.95	0.95
PUHY-P250	1.00	0.95	0.84	0.825	0.83	0.87	0.90	0.95	0.95	0.95	0.95
PUHY-P300	1.00	0.93	0.82	0.80	0.82	0.86	0.90	0.90	0.95	0.95	0.95
PUHY-P350	1.00	0.93	0.85	0.83	0.84	0.86	0.90	0.90	0.95	0.95	0.95
PUHY-P400	1.00	0.93	0.85	0.83	0.84	0.86	0.90	0.90	0.95	0.95	0.95

8-2. Correction by temperature

CITY MULTI could have varied capacity at different designing temperature. Using the nominal cooling/heating capacity value and the ratio below, the capacity can be observed at various temperature.

R2 (HIGH COP)

PURY-		EP200YLM-A	EP250YLM-A
Nominal Cooling Capacity	kW	22.4	28.0
	BTU/h	76,400	95,500
Input	kW	5.48	7.25

Indoor unit temperature correction

To be used to correct indoor unit capacity only

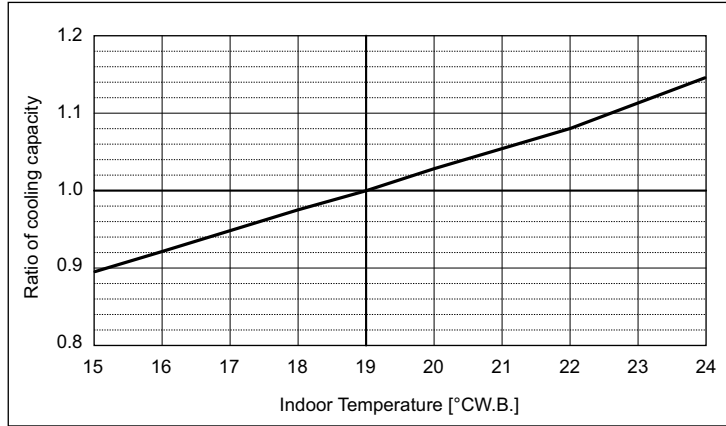

Outdoor unit temperature correction

To be used to correct outdoor unit only

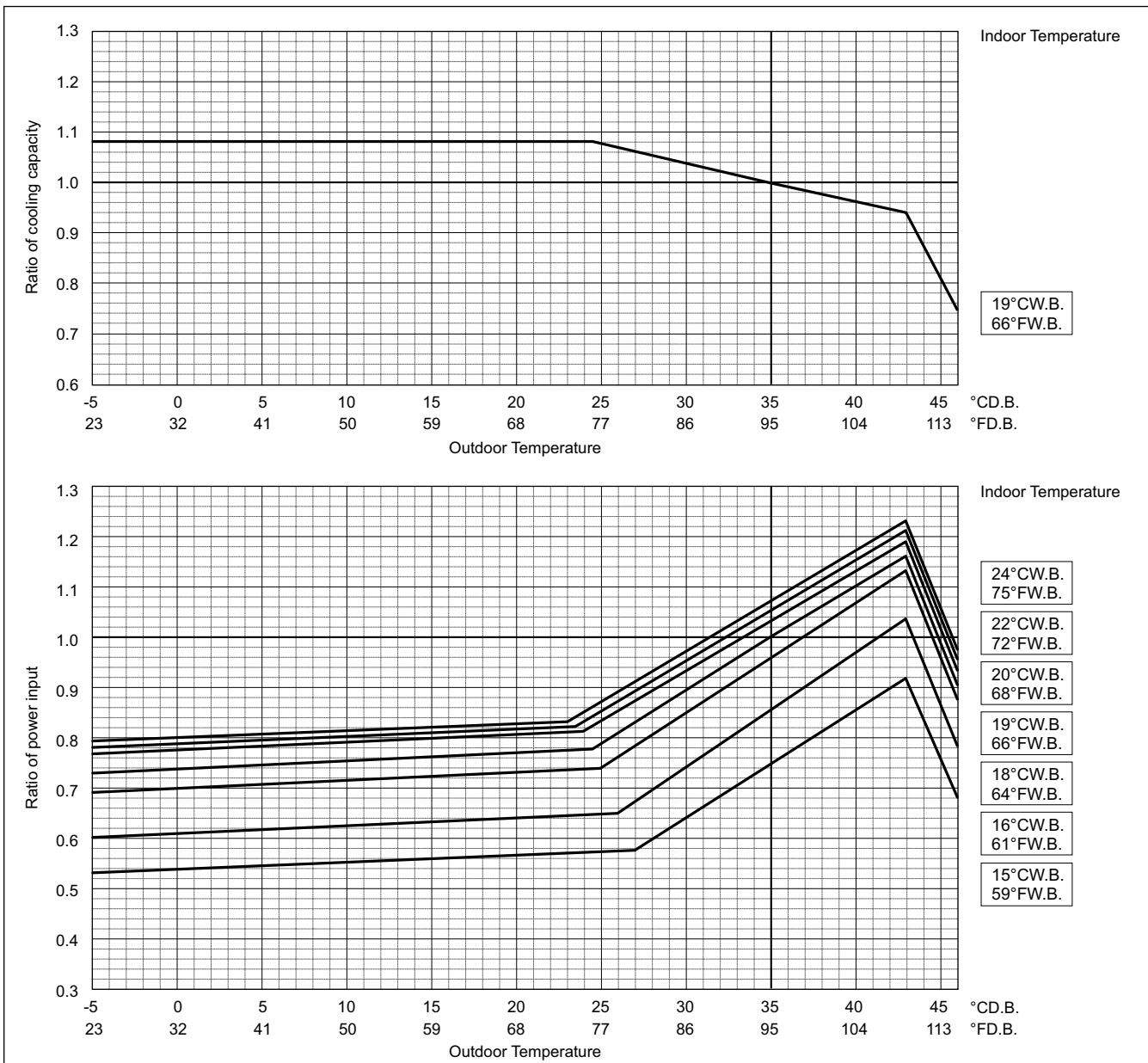

Outdoor unit power input is affected by the indoor and outdoor temperatures as shown in the graph above. Please consult the sales office for details.

PURY-	EP200YLM-A	EP250YLM-A
Nominal Heating Capacity	kW 25.0	31.5
	BTU/h 85,300	107,500
Input	kW 6.41	8.45

Indoor unit temperature correction

To be used to correct indoor unit capacity only

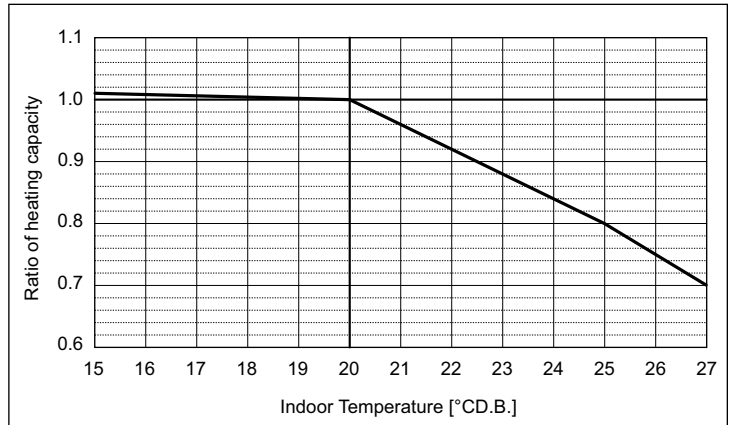

R2 (HIGH COP)

Outdoor unit temperature correction

To be used to correct outdoor unit only

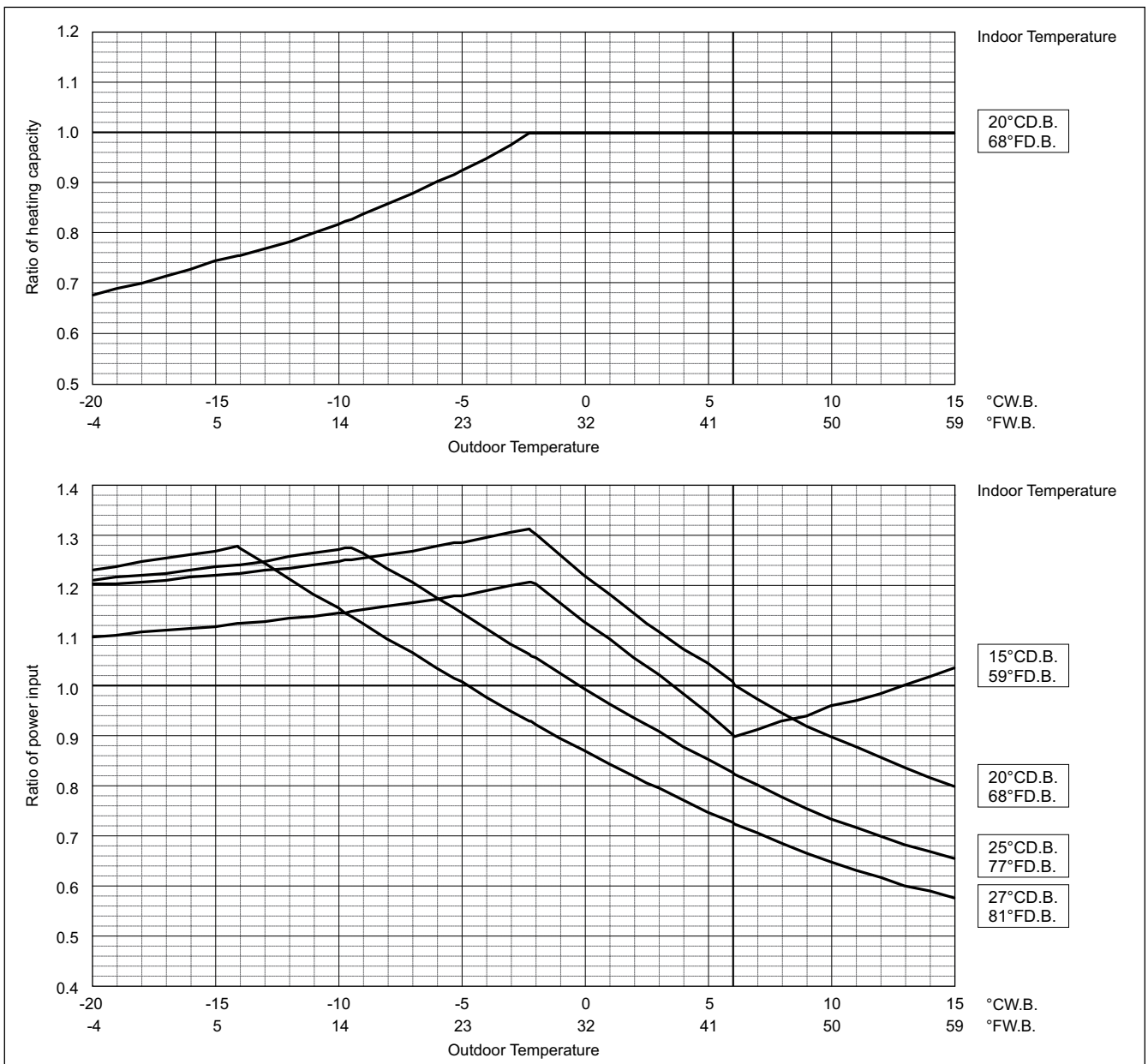

Outdoor unit power input is affected by the indoor and outdoor temperatures as shown in the graph above. Please consult the sales office for details.

R2 (HIGH COP)

PURY-		EP300YLM-A	EP350YLM-A	EP400YLM-A
Nominal Cooling Capacity	kW	33.5	40.0	45.0
	BTU/h	114,300	136,500	153,500
Input	kW	9.20	12.57	12.56

Indoor unit temperature correction

To be used to correct indoor unit capacity only

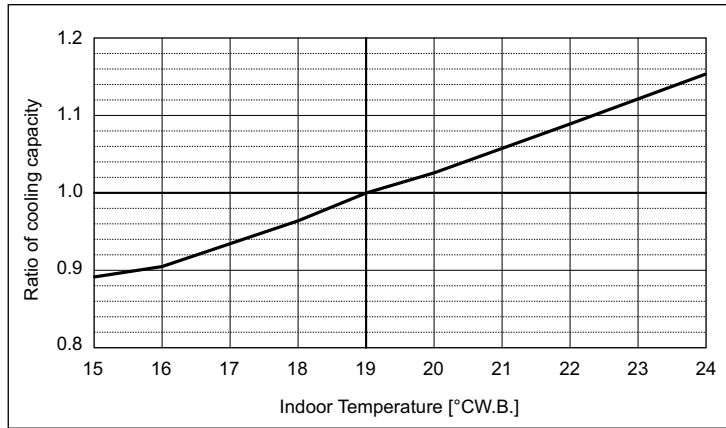

Outdoor unit temperature correction

To be used to correct outdoor unit only

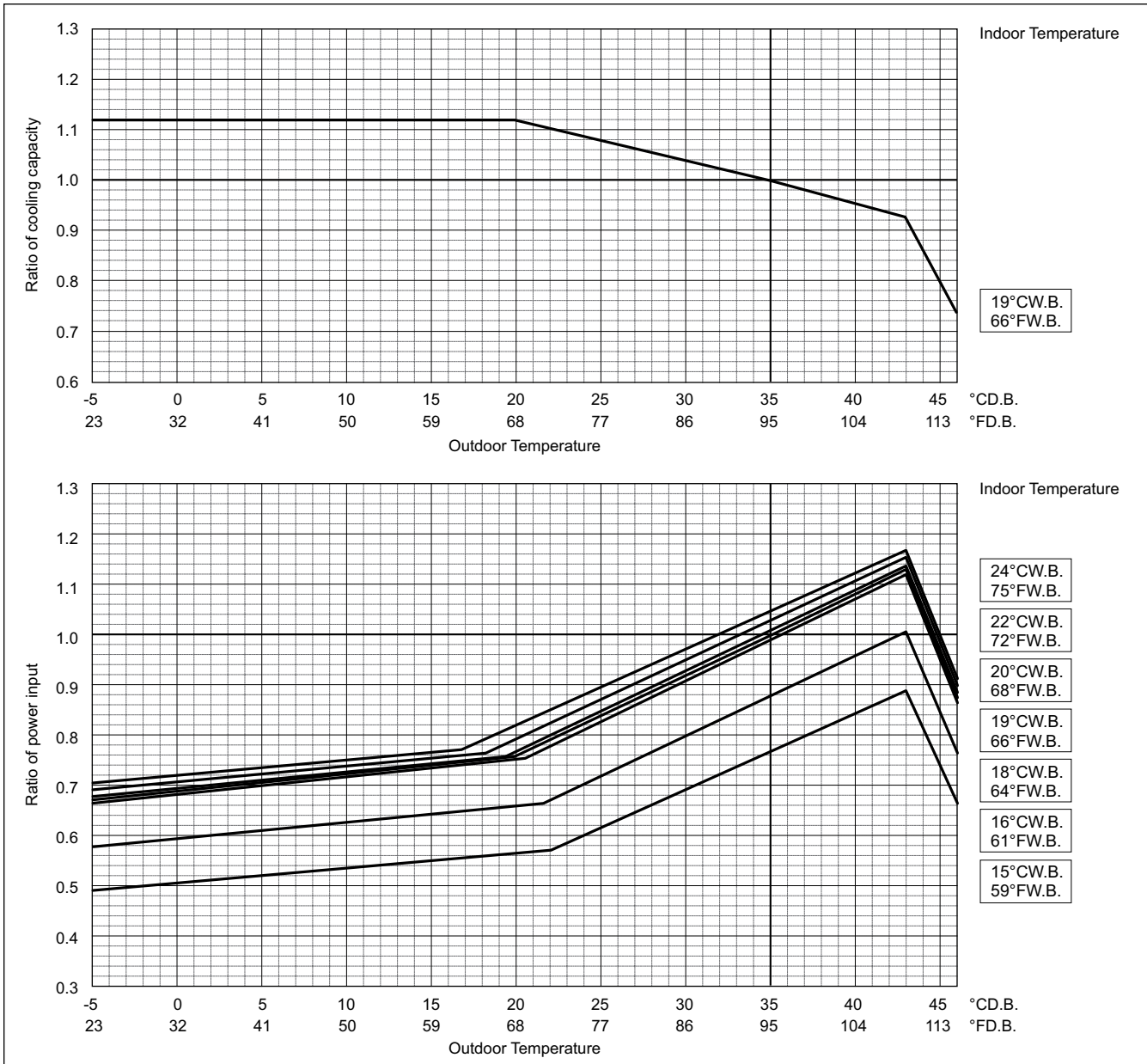

Outdoor unit power input is affected by the indoor and outdoor temperatures as shown in the graph above. Please consult the sales office for details.

PURY-	EP300YLM-A	EP350YLM-A	EP400YLM-A
Nominal Heating Capacity	kW 37.5	45.0	50.0
	BTU/h 128,000	153,500	170,600
Input	kW 9.97	12.93	13.40

Indoor unit temperature correction
To be used to correct indoor unit capacity only

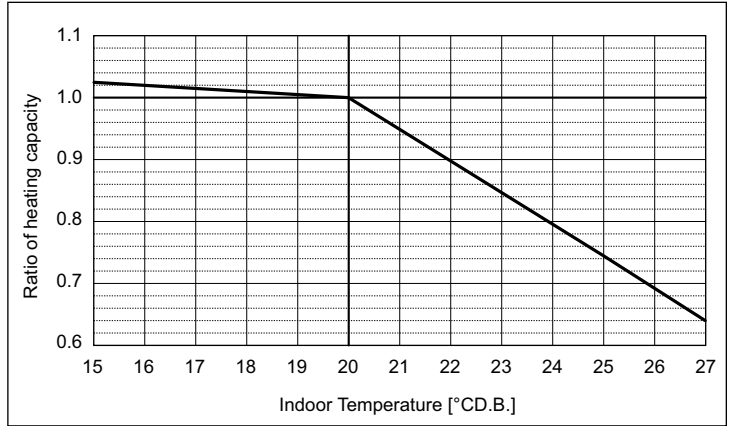

Outdoor unit temperature correction
To be used to correct outdoor unit only

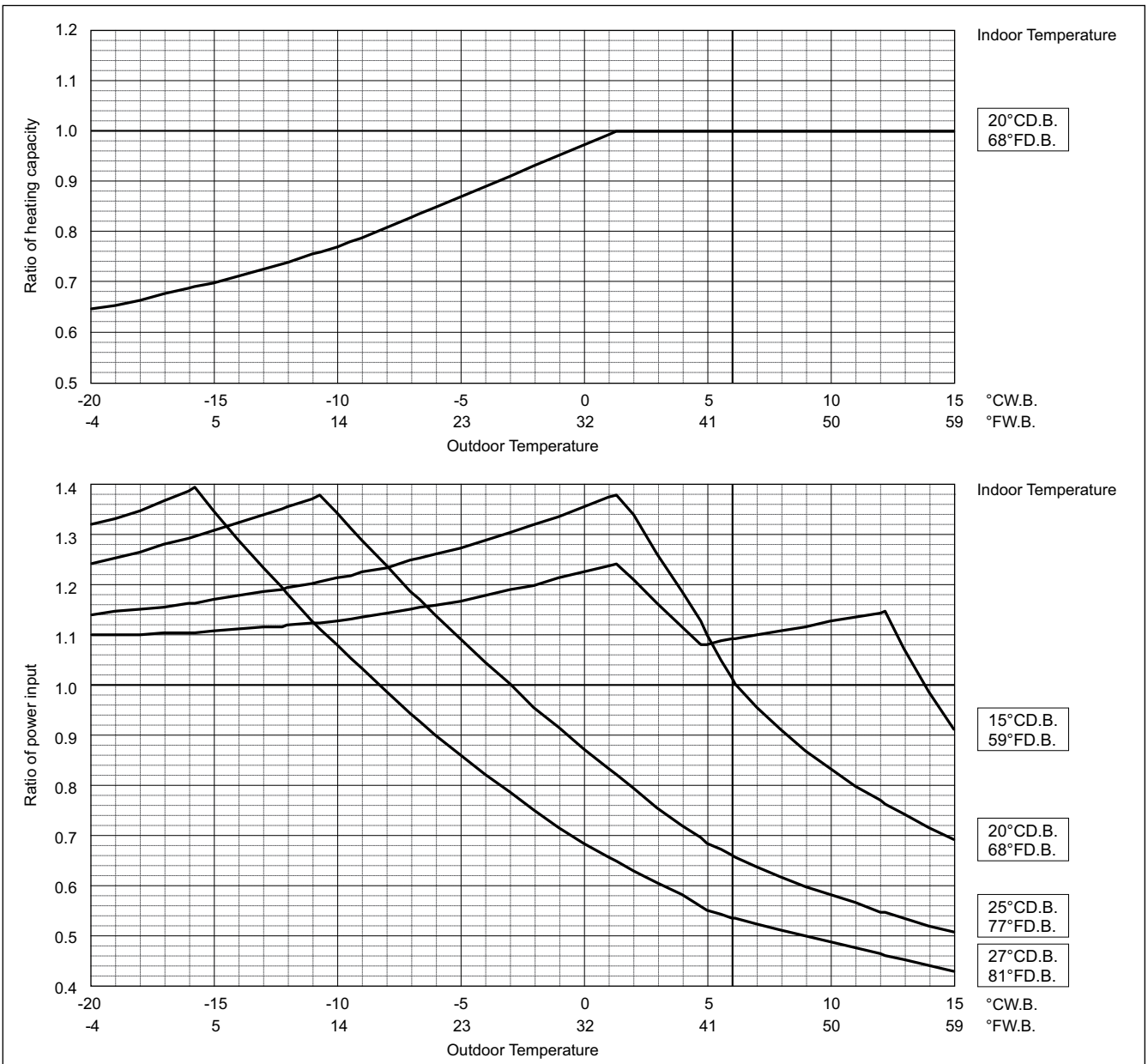

Outdoor unit power input is affected by the indoor and outdoor temperatures as shown in the graph above. Please consult the sales office for details.

R2 (HIGH COP)

8. CAPACITY TABLES

R2 (HIGH COP)

PURY-		EP450YLM-A	EP500YLM-A	EP550YSLM-A
Nominal Cooling Capacity	kW	50.0	56.0	63.0
	BTU/h	170,600	191,100	215,000
Input	kW	14.83	18.30	17.35

PURY-		EP600YSLM-A	EP650YSLM-A
Nominal Cooling Capacity	kW	69.0	73.0
	BTU/h	235,400	249,100
Input	kW	19.54	22.12

Indoor unit temperature correction
To be used to correct indoor unit capacity only

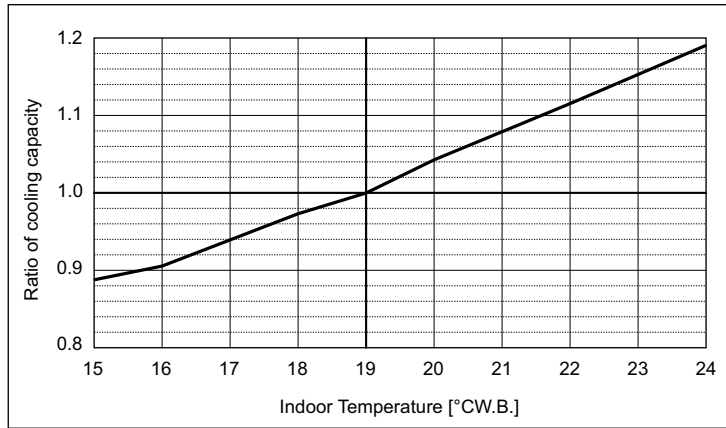

Outdoor unit temperature correction
To be used to correct outdoor unit only

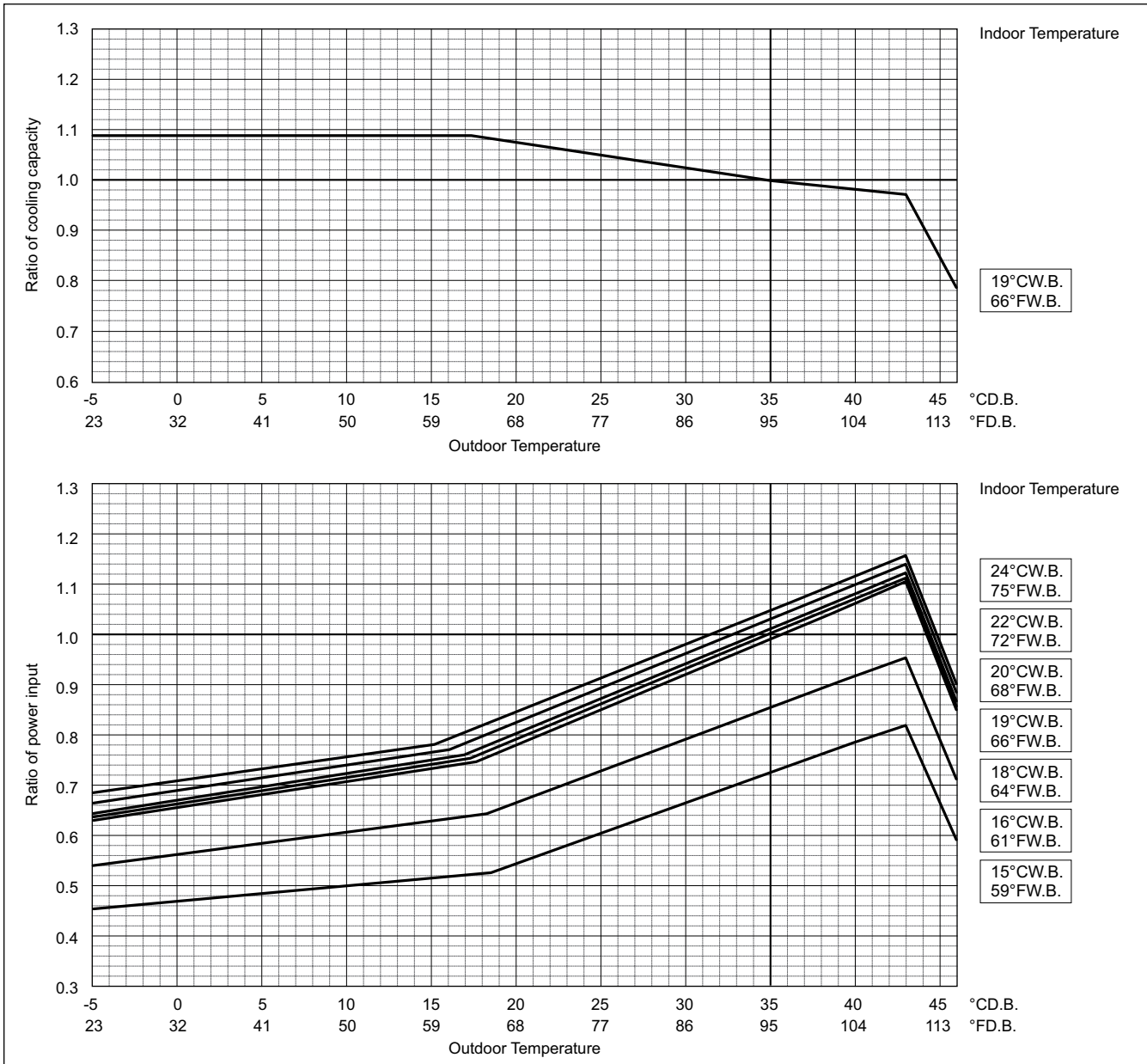

Outdoor unit power input is affected by the indoor and outdoor temperatures as shown in the graph above. Please consult the sales office for details.

PURY-		EP450YLM-A	EP500YLM-A	EP550YSLM-A
Nominal Heating Capacity	kW	56.0	63.0	69.0
	BTU/h	191,100	215,000	235,400
Input	kW	15.86	19.54	18.44

PURY-		EP600YSLM-A	EP650YSLM-A
Nominal Heating Capacity	kW	76.5	81.5
	BTU/h	261,000	278,100
Input	kW	20.34	22.51

Indoor unit temperature correction
To be used to correct indoor unit capacity only

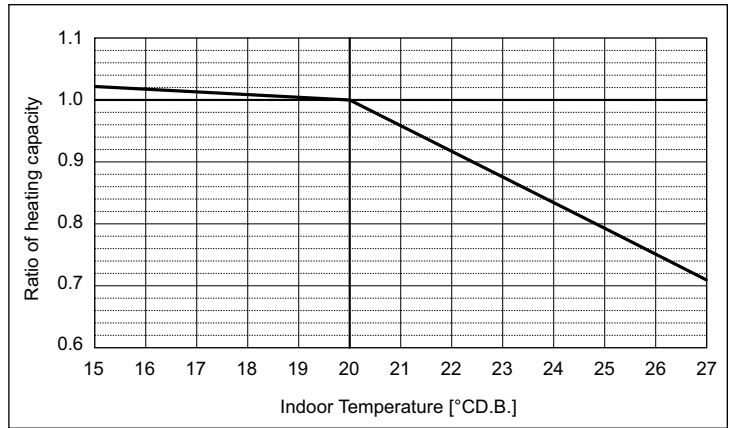

R2 (HIGH COP)

Outdoor unit temperature correction
To be used to correct outdoor unit only

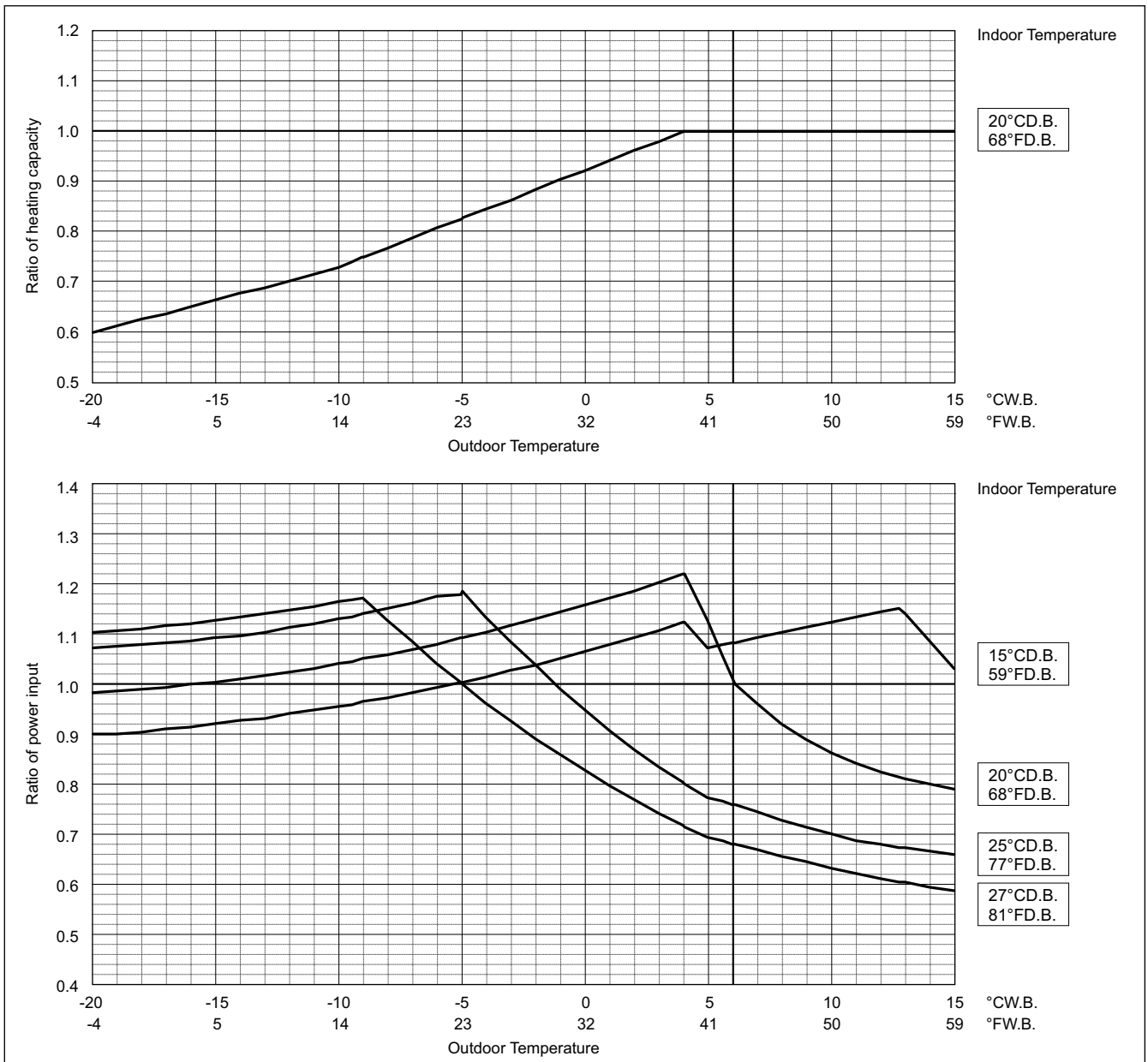

Outdoor unit power input is affected by the indoor and outdoor temperatures as shown in the graph above. Please consult the sales office for details.

R2 (HIGH COP)

PURY-		EP700YSLM-A	EP750YSLM-A	EP800YSLM-A
Nominal Cooling Capacity	kW	80.0	85.0	90.0
	BTU/h	273,000	290,000	307,100
Input	kW	25.97	25.99	25.93

Indoor unit temperature correction

To be used to correct indoor unit capacity only

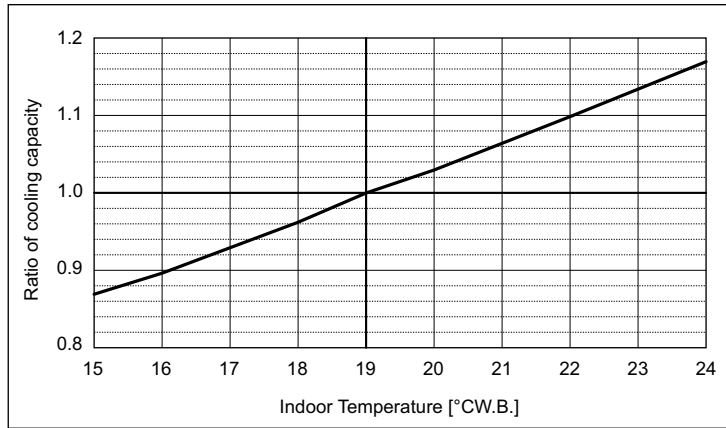

Outdoor unit temperature correction

To be used to correct outdoor unit only

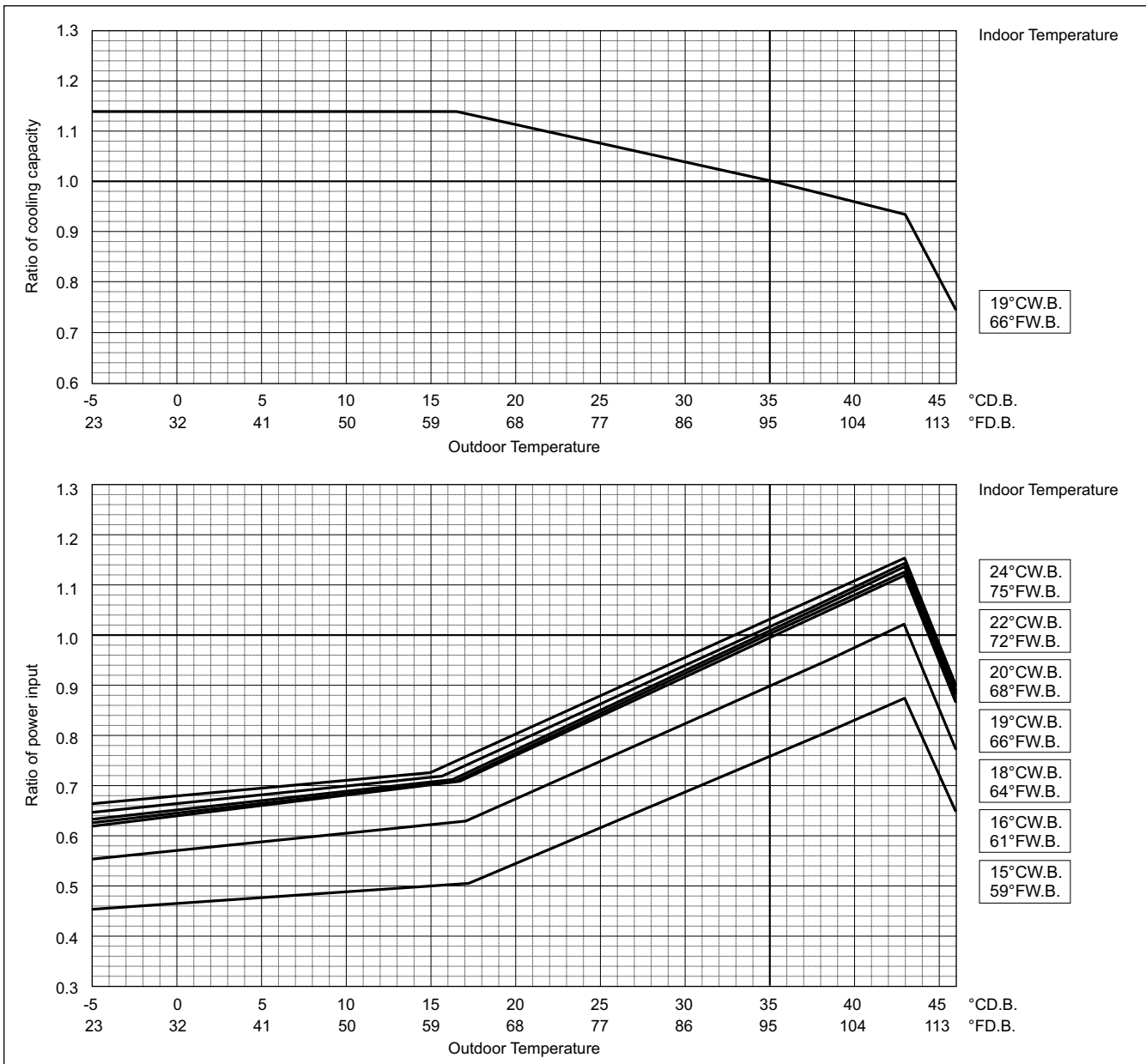

Outdoor unit power input is affected by the indoor and outdoor temperatures as shown in the graph above. Please consult the sales office for details.

PURY-		EP700YSLM-A	EP750YSLM-A	EP800YSLM-A
Nominal Heating Capacity	kW	88.0	95.0	100.0
	BTU/h	300,300	324,100	341,200
Input	kW	25.28	26.38	26.80

Indoor unit temperature correction

To be used to correct indoor unit capacity only

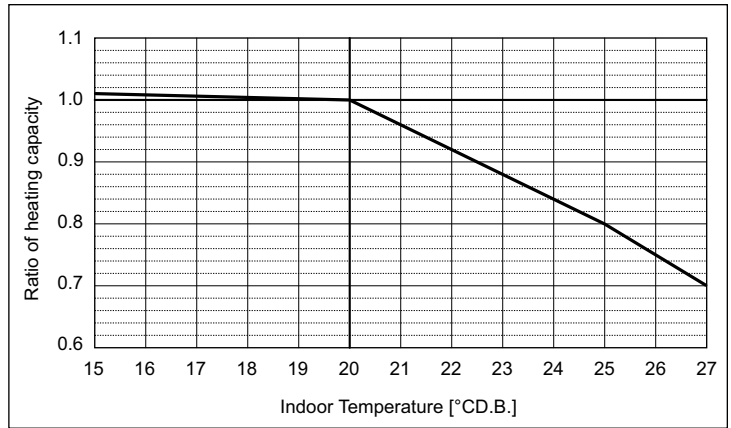

R2 (HIGH COP)

Outdoor unit temperature correction

To be used to correct outdoor unit only

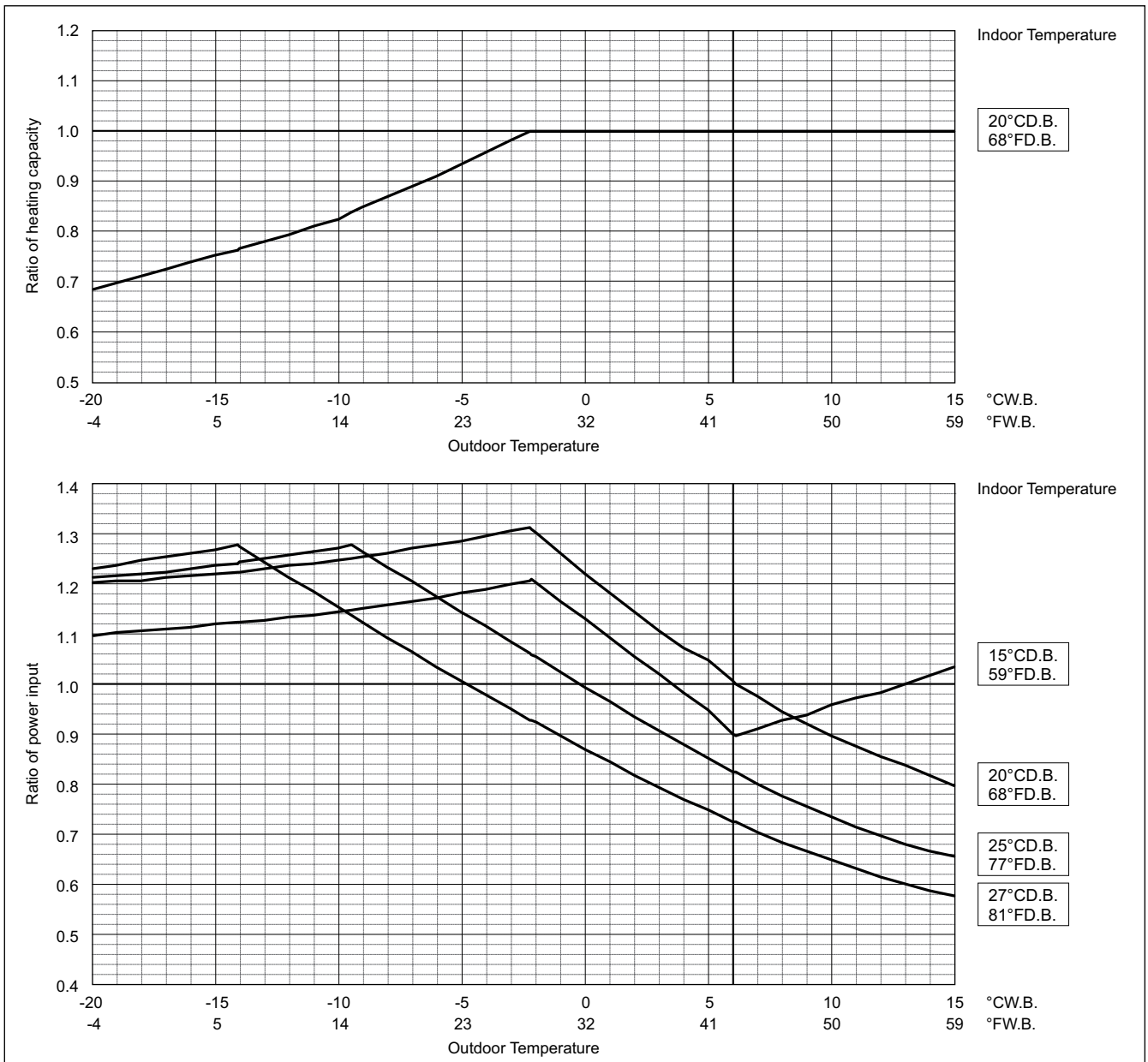

Outdoor unit power input is affected by the indoor and outdoor temperatures as shown in the graph above. Please consult the sales office for details.

R2 (HIGH COP)

PURY-		EP850YSLM-A	EP900YSLM-A
Nominal Cooling Capacity	kW	96.0	101.0
	BTU/h	327,600	344,600
Input	kW	28.48	30.98

Indoor unit temperature correction

To be used to correct indoor unit capacity only

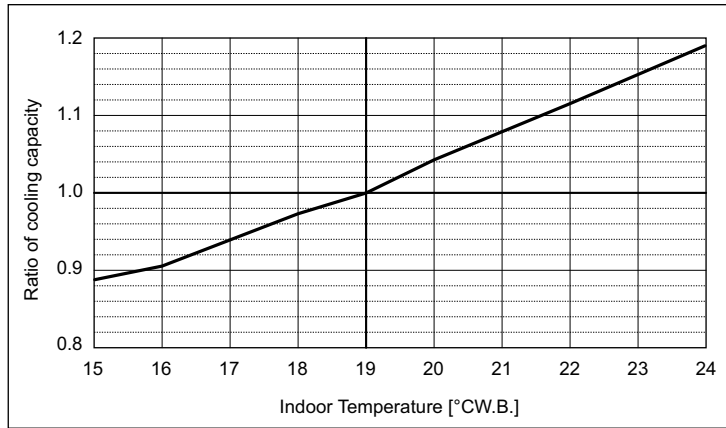

Outdoor unit temperature correction

To be used to correct outdoor unit only

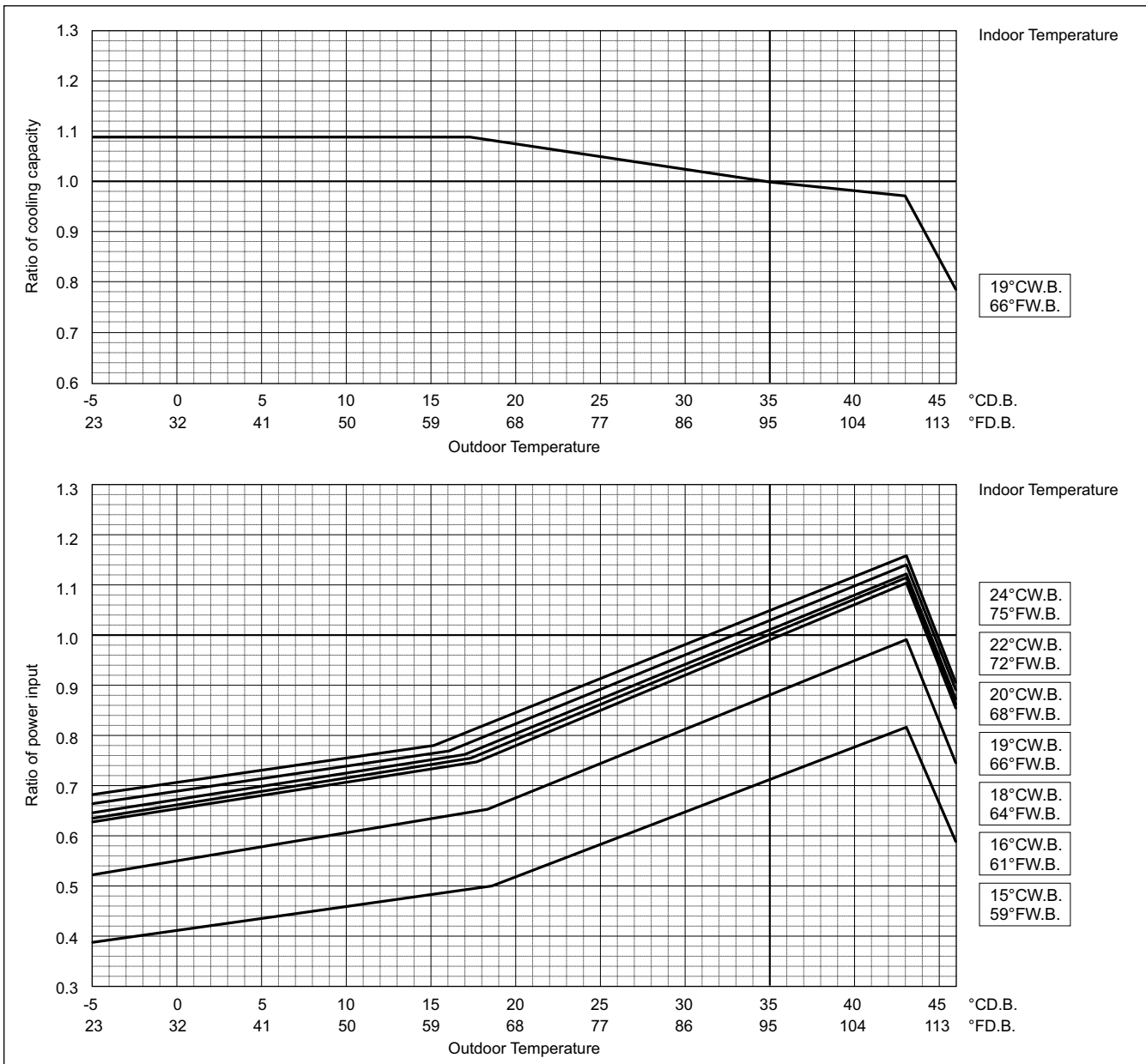

Outdoor unit power input is affected by the indoor and outdoor temperatures as shown in the graph above. Please consult the sales office for details.

	PURY-	EP850YSLM-A	EP900YSLM-A
Nominal Heating Capacity	kW	108.0	113.0
	BTU/h	368,500	385,600
Input	kW	29.75	32.01

Indoor unit temperature correction

To be used to correct indoor unit capacity only

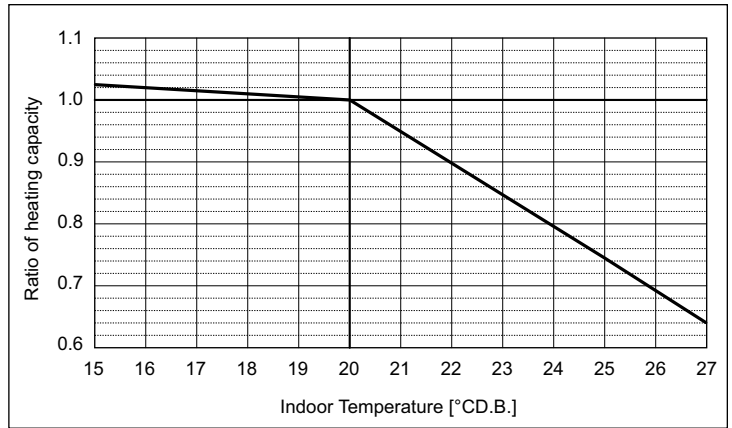

R2 (HIGH COP)

Outdoor unit temperature correction

To be used to correct outdoor unit only

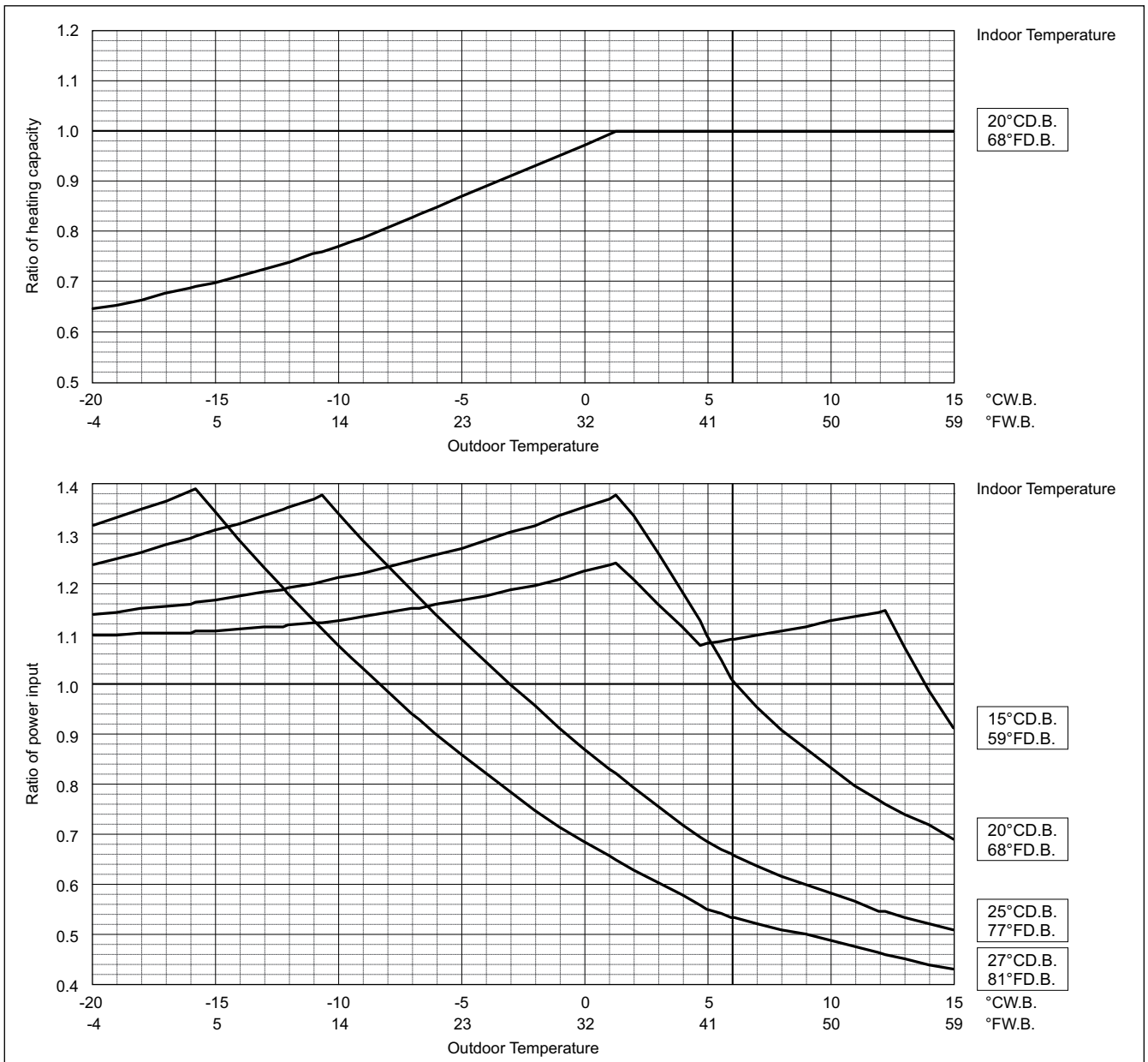

Outdoor unit power input is affected by the indoor and outdoor temperatures as shown in the graph above. Please consult the sales office for details.

Correction by temperature (COP Priority Mode)

CITY MULTI could have various capacities at different designing temperatures. Using the nominal cooling/heating capacity values and the ratios below, the capacity can be found for various temperatures. To select COP priority mode, DipSW 6-2 must be set to ON.

PURY-	EP200YLM-A	EP250YLM-A
Nominal Cooling Capacity	22.4	28.0
Input	5.48	7.25

Indoor unit temperature correction

To be used to correct indoor unit capacity only

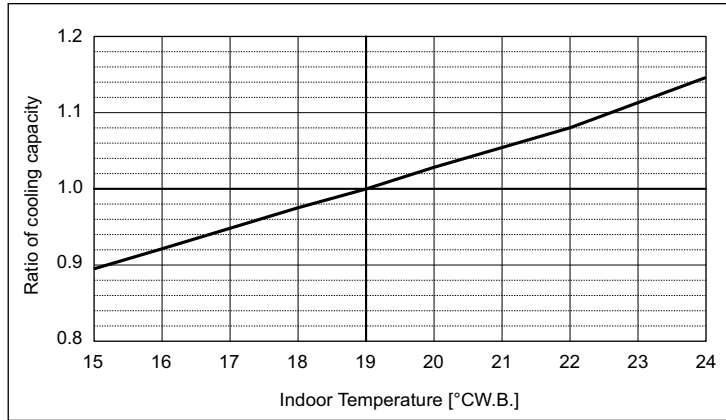

Outdoor unit temperature correction

To be used to correct outdoor unit only

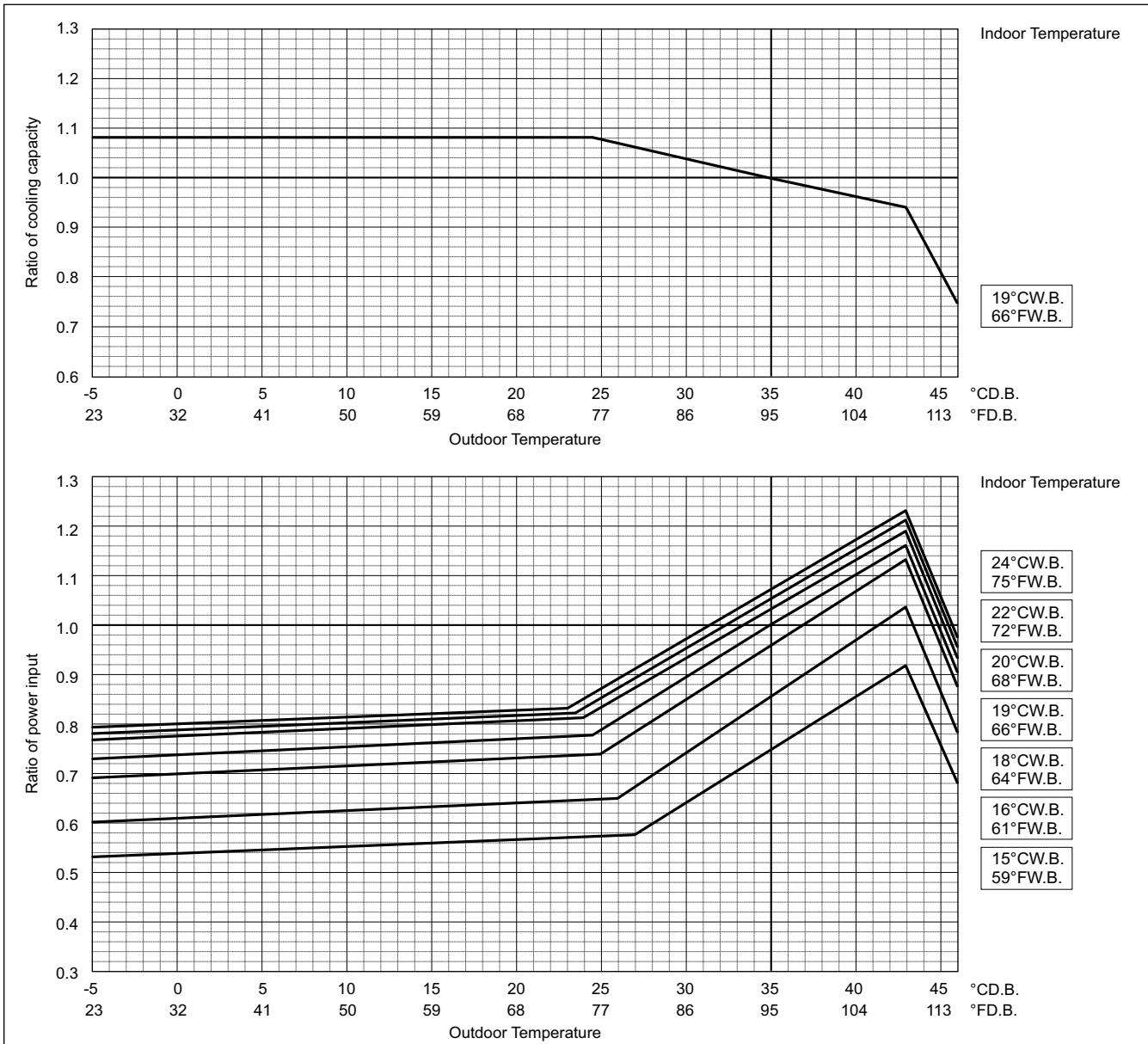

Outdoor unit power input is affected by the indoor and outdoor temperatures as shown in the graph above. Please consult the sales office for details.

	PURY-	EP200YLM-A	EP250YLM-A
Nominal Heating Capacity	kW	25.0	31.5
	BTU/h	85,300	107,500
Input	kW	6.41	8.45

Indoor unit temperature correction

To be used to correct indoor unit capacity only

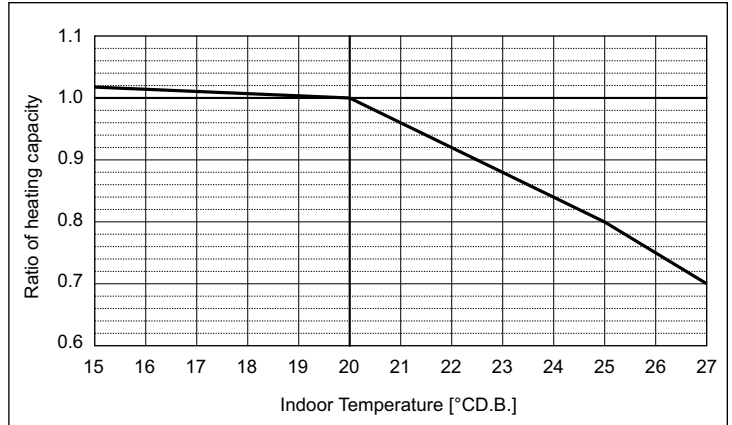

R2 (HIGH COP)

Outdoor unit temperature correction

To be used to correct outdoor unit only

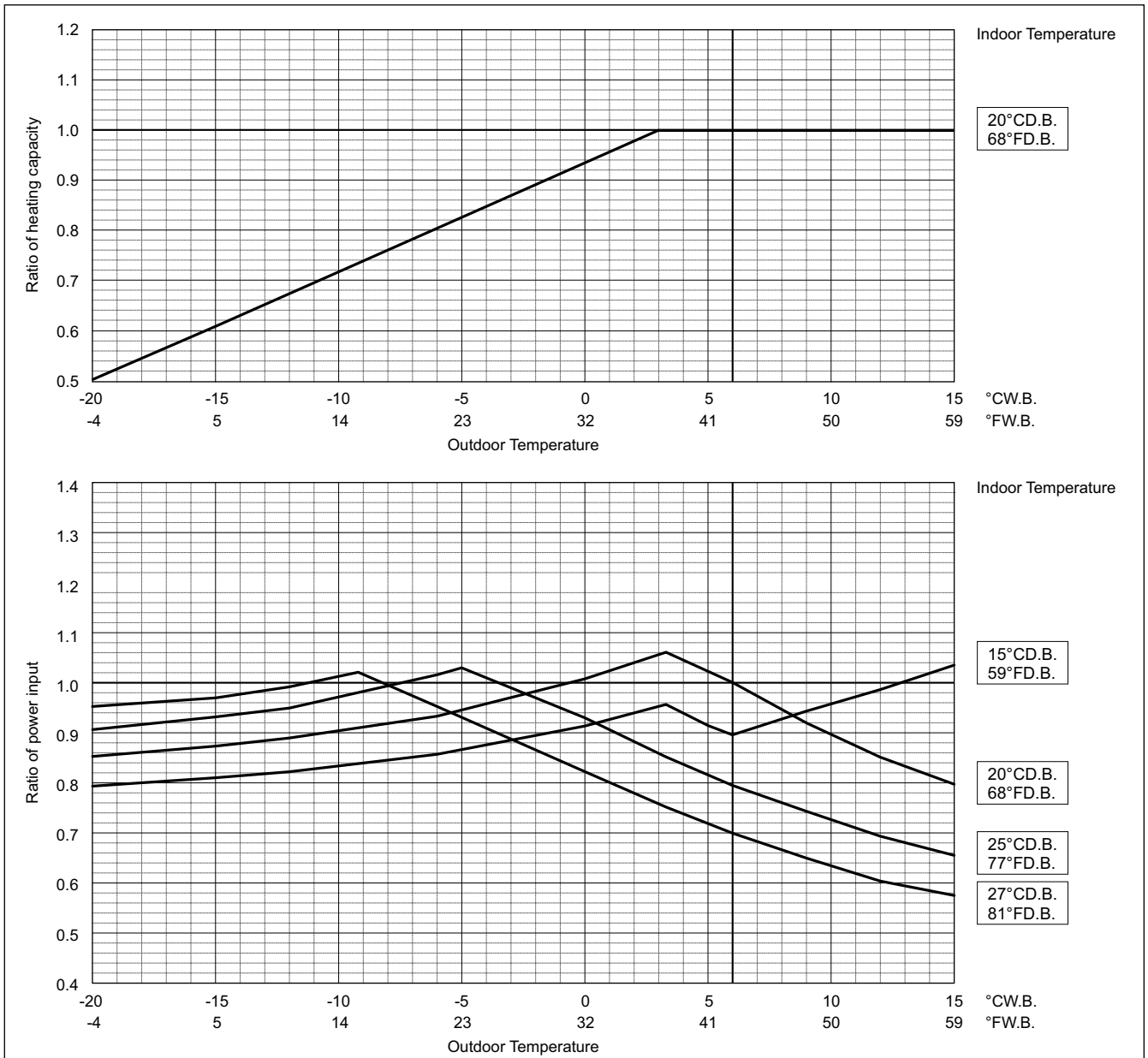

Outdoor unit power input is affected by the indoor and outdoor temperatures as shown in the graph above. Please consult the sales office for details.

8. CAPACITY TABLES

R2 (HIGH COP)

PURY-	EP300YLM-A	EP350YLM-A	EP400YLM-A	
Nominal Cooling Capacity	kW	33.5	40.0	45.0
	BTU/h	114,300	136,500	153,500
Input	kW	9.20	12.57	12.56

Indoor unit temperature correction

To be used to correct indoor unit capacity only

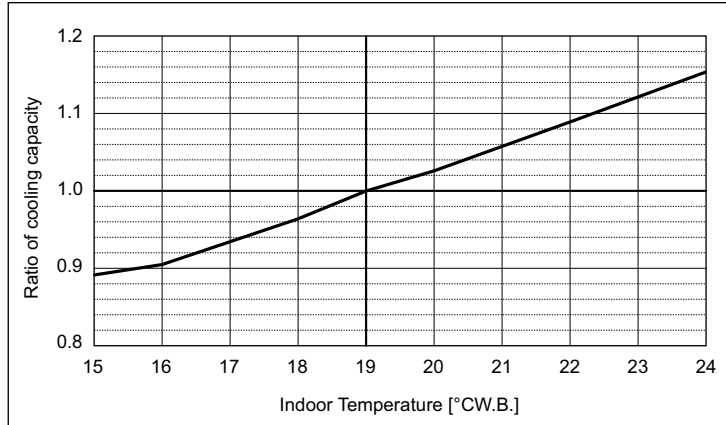

Outdoor unit temperature correction

To be used to correct outdoor unit only

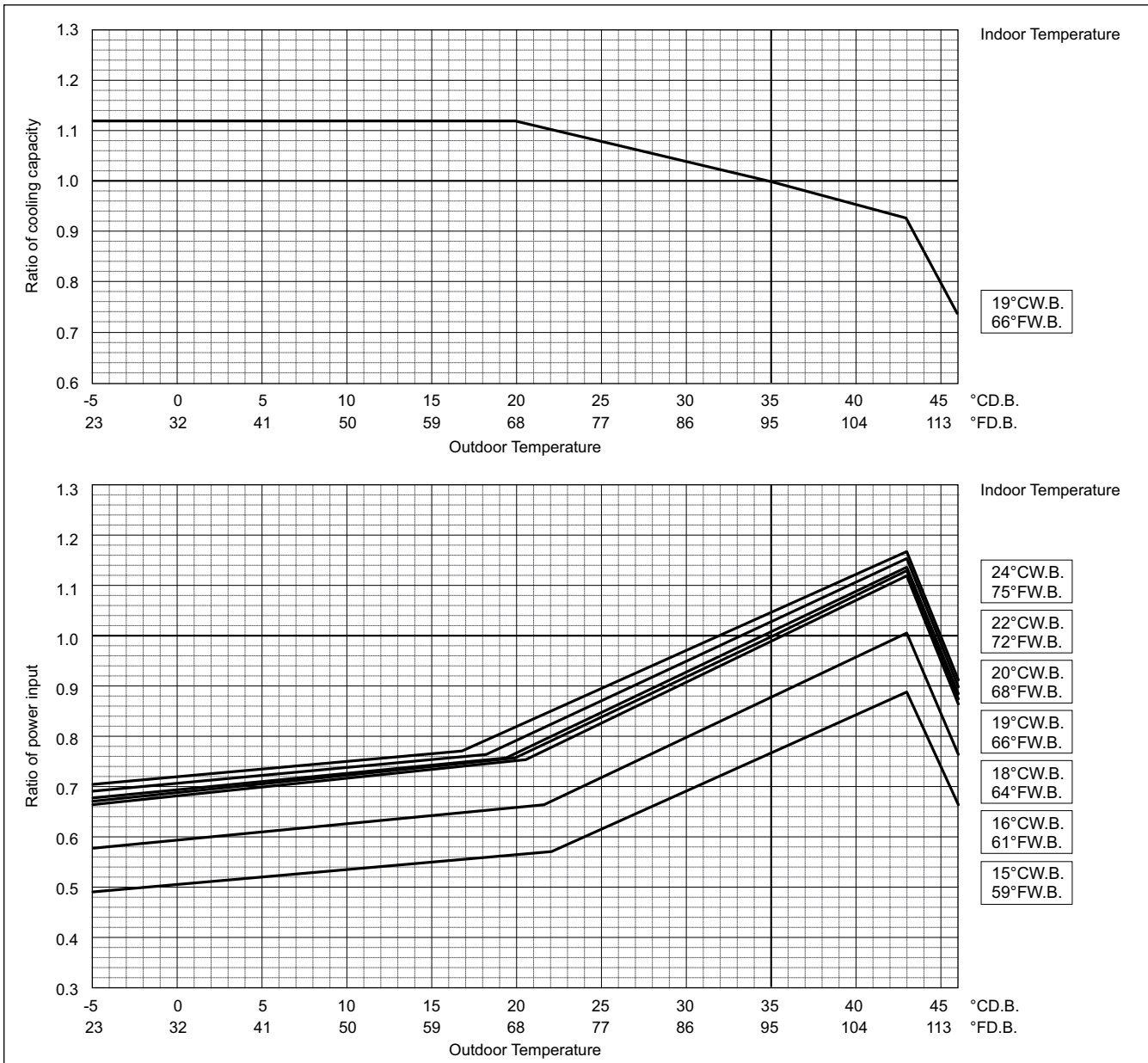

Outdoor unit power input is affected by the indoor and outdoor temperatures as shown in the graph above. Please consult the sales office for details.

	PURY-	EP300YLM-A	EP350YLM-A	EP400YLM-A
Nominal Heating Capacity	kW	37.5	45.0	50.0
	BTU/h	128,000	153,500	170,600
Input	kW	9.97	12.93	13.40

Indoor unit temperature correction
To be used to correct indoor unit capacity only

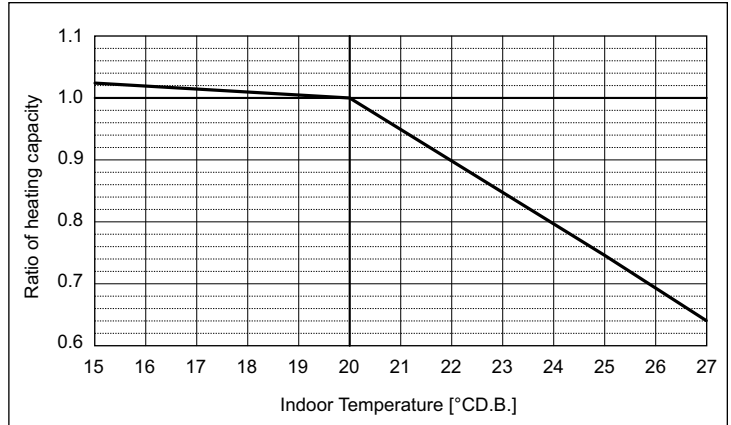

R2 (HIGH COP)

Outdoor unit temperature correction
To be used to correct outdoor unit only

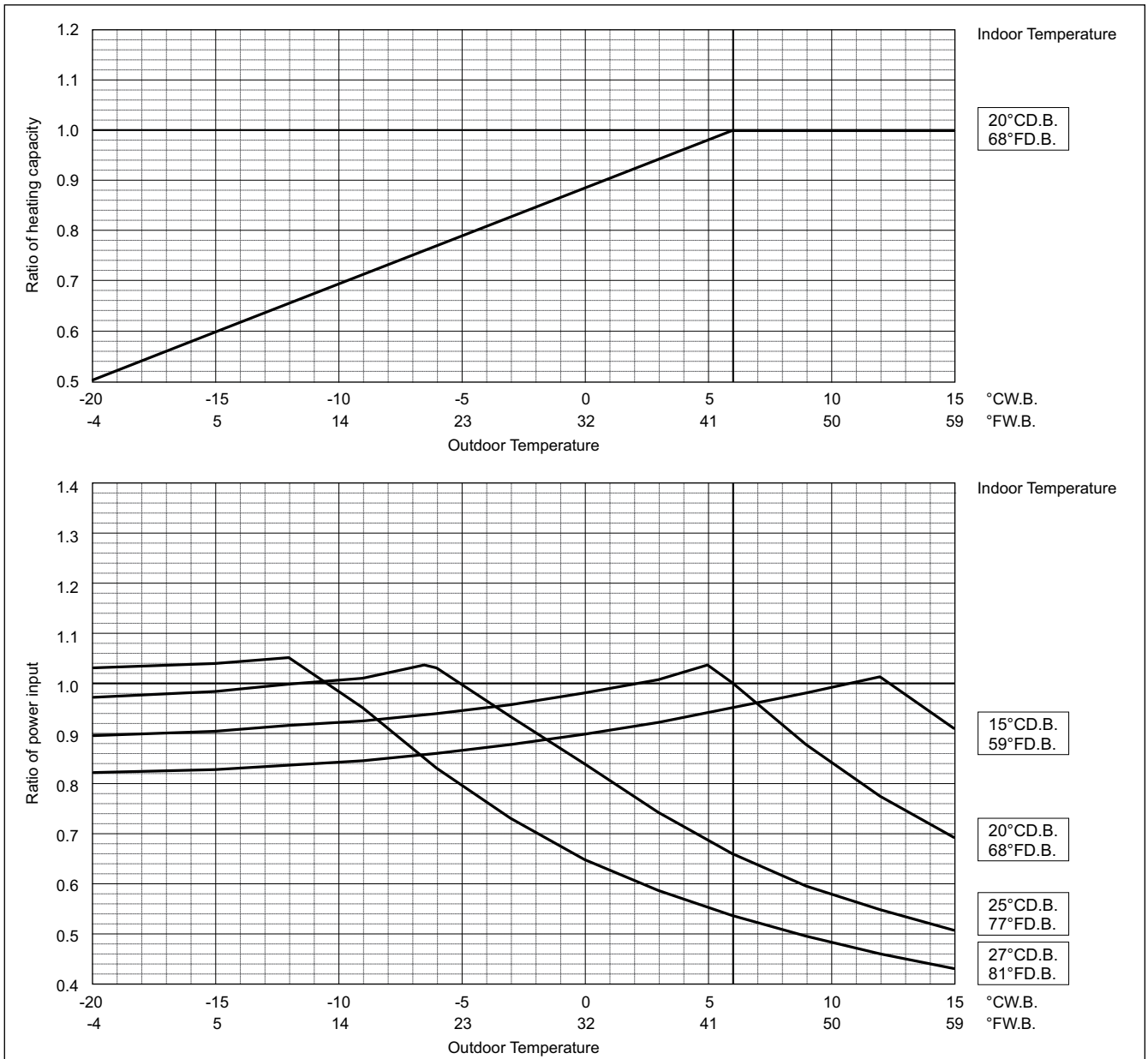

Outdoor unit power input is affected by the indoor and outdoor temperatures as shown in the graph above. Please consult the sales office for details.

8. CAPACITY TABLES

R2 (HIGH COP)

PURY-		EP450YLM-A	EP500YLM-A	EP550YLM-A
Nominal Cooling Capacity	kW	50.0	56.0	63.0
	BTU/h	170,600	191,100	215,000
Input	kW	14.83	18.30	17.35

PURY-		EP600YSLM-A	EP650YSLM-A
Nominal Cooling Capacity	kW	69.0	73.0
	BTU/h	235,400	249,100
Input	kW	19.54	22.12

Indoor unit temperature correction

To be used to correct indoor unit capacity only

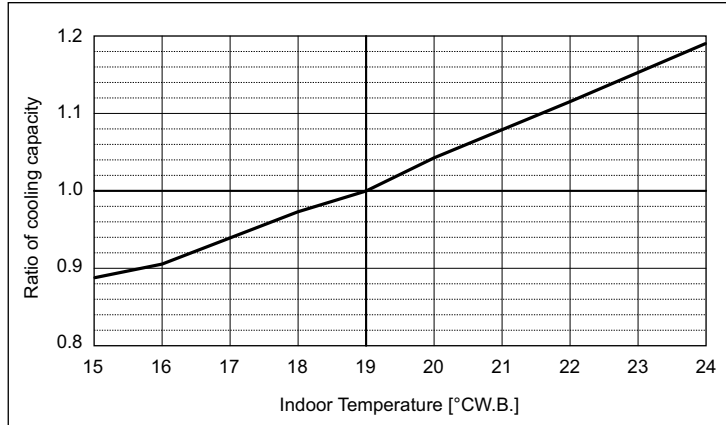

Outdoor unit temperature correction

To be used to correct outdoor unit only

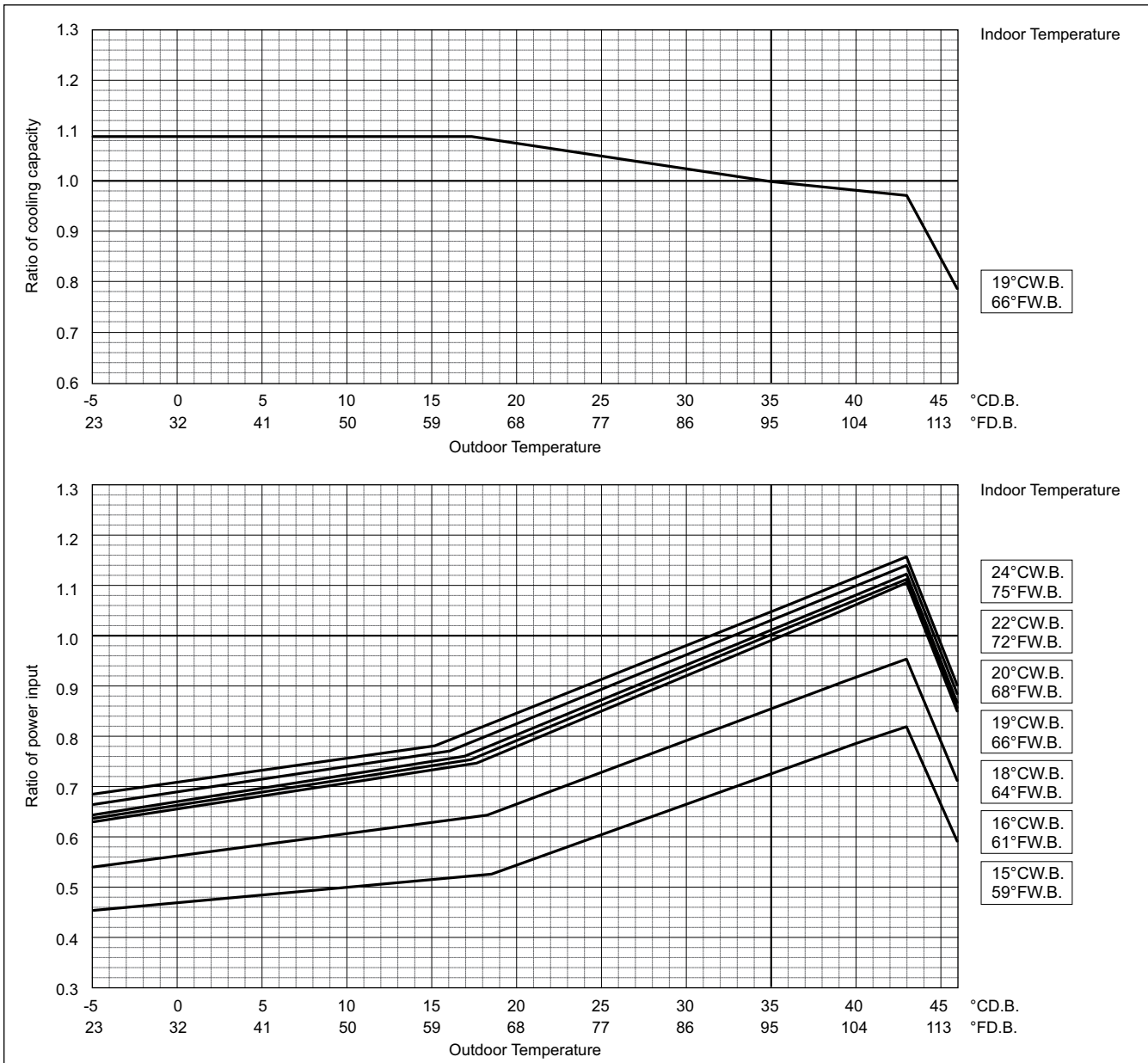

Outdoor unit power input is affected by the indoor and outdoor temperatures as shown in the graph above. Please consult the sales office for details.

PURY-	EP450YLM-A	EP500YLM-A	EP550YSLM-A
Nominal Heating Capacity kW	56.0	63.0	69.0
Nominal Heating Capacity BTU/h	191,100	215,000	235,400
Input kW	15.86	19.54	18.44

PURY-	EP600YSLM-A	EP650YSLM-A
Nominal Heating Capacity kW	76.5	81.5
Nominal Heating Capacity BTU/h	261,000	278,100
Input kW	20.34	22.51

Indoor unit temperature correction

To be used to correct indoor unit capacity only

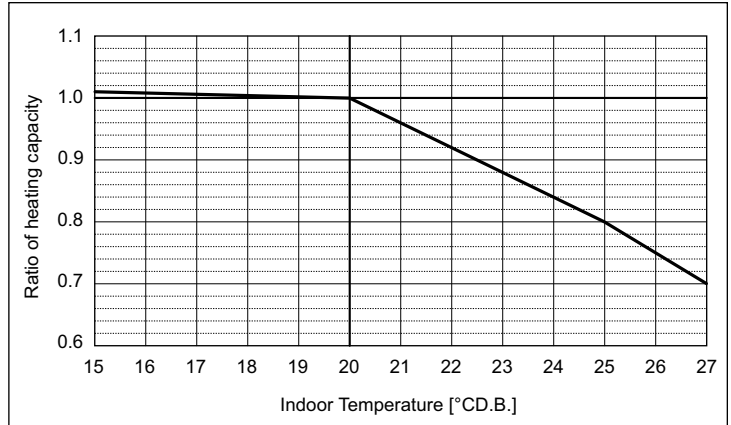

R2 (HIGH COP)

Outdoor unit temperature correction

To be used to correct outdoor unit only

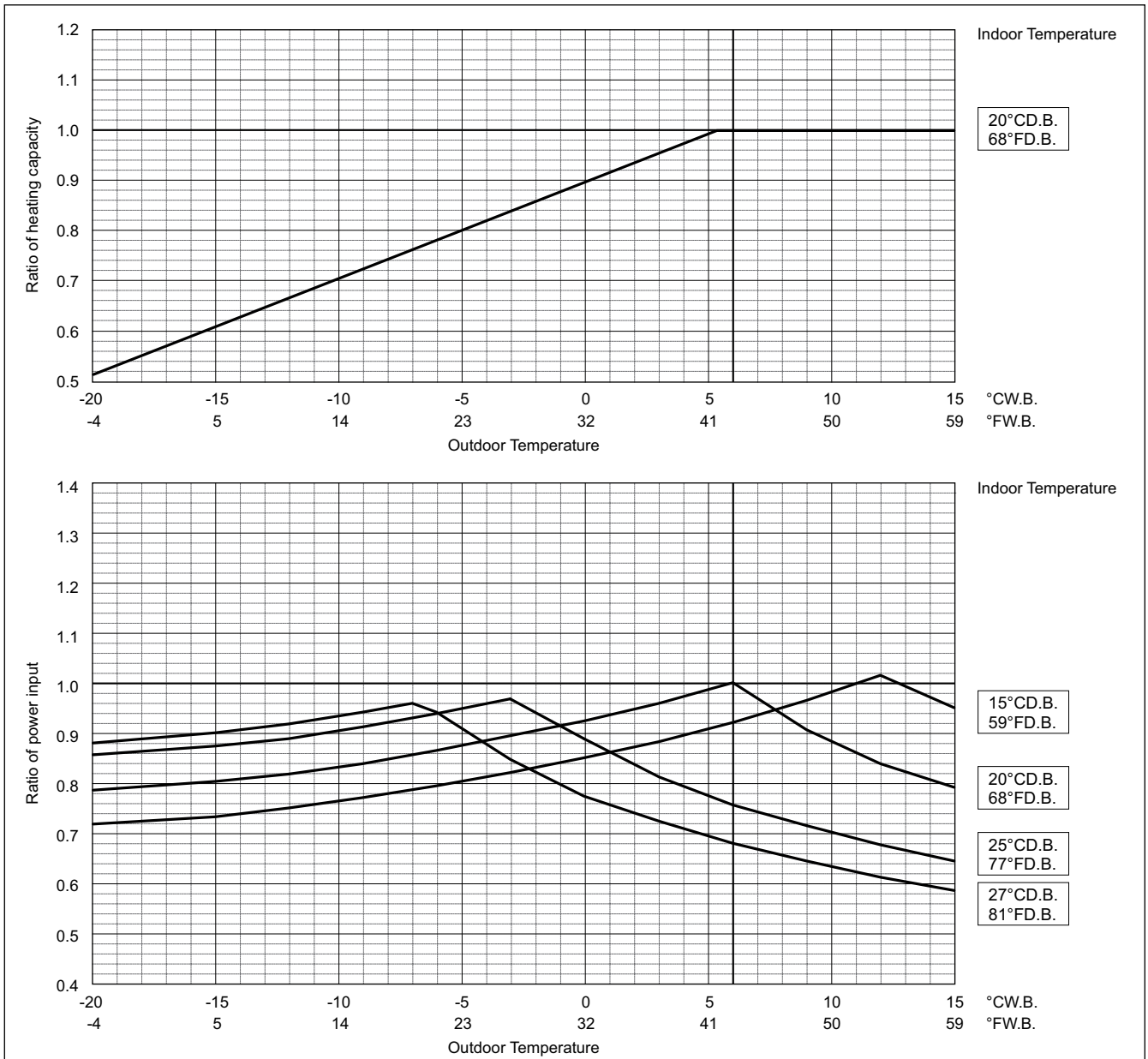

Outdoor unit power input is affected by the indoor and outdoor temperatures as shown in the graph above. Please consult the sales office for details.

8. CAPACITY TABLES

R2 (HIGH COP)

PURY-	EP700YSLM-A	EP750YSLM-A	EP800YSLM-A
Nominal Cooling Capacity	80.0	85.0	90.0
BTU/h	273,000	290,000	307,100
Input	25.97	25.99	25.93
kW			

Indoor unit temperature correction

To be used to correct indoor unit capacity only

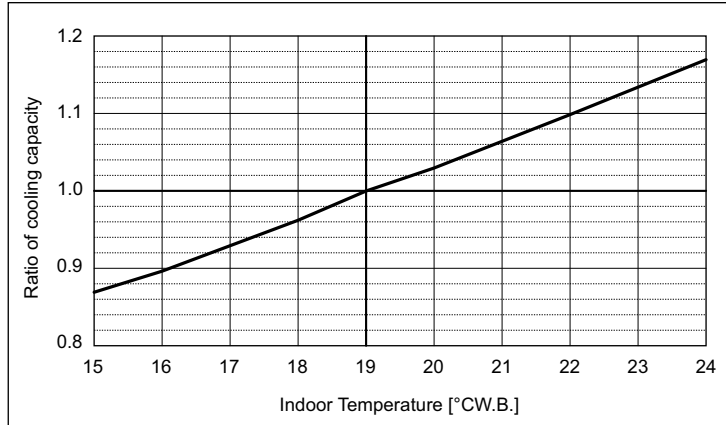

Outdoor unit temperature correction

To be used to correct outdoor unit only

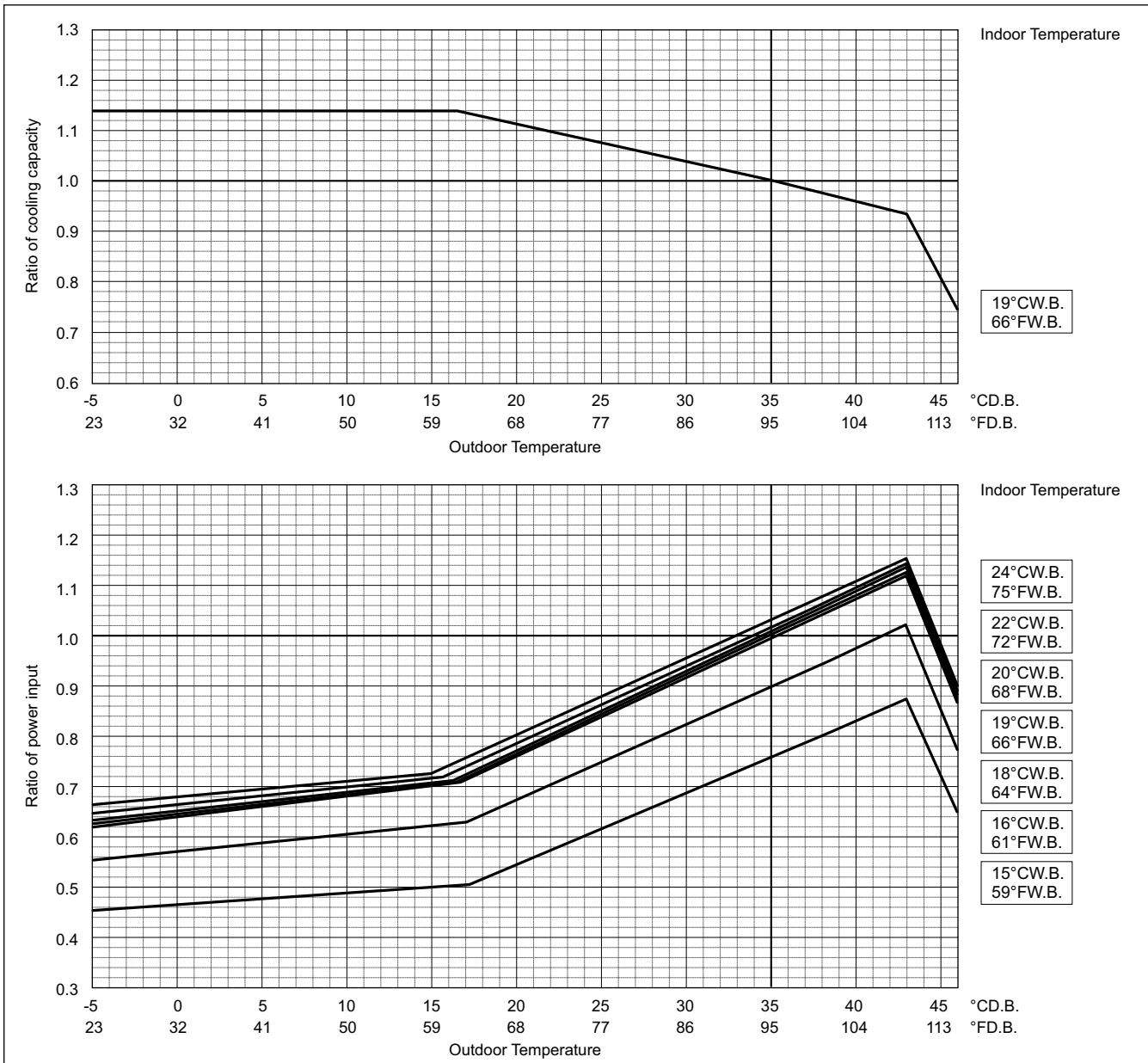

Outdoor unit power input is affected by the indoor and outdoor temperatures as shown in the graph above. Please consult the sales office for details.

PURY-	EP700YSLM-A	EP750YSLM-A	EP800YSLM-A
Nominal Heating Capacity	kW 88.0	95.0	100.0
	BTU/h 300,300	324,100	341,200
Input	kW 25.28	26.38	26.80

Indoor unit temperature correction

To be used to correct indoor unit capacity only

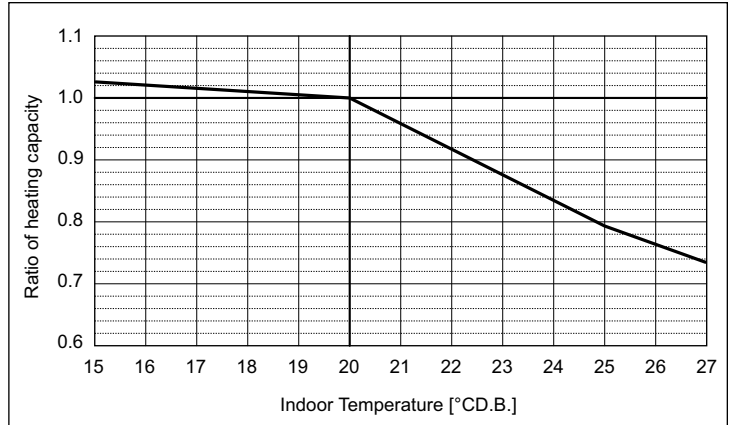

R2 (HIGH COP)

Outdoor unit temperature correction

To be used to correct outdoor unit only

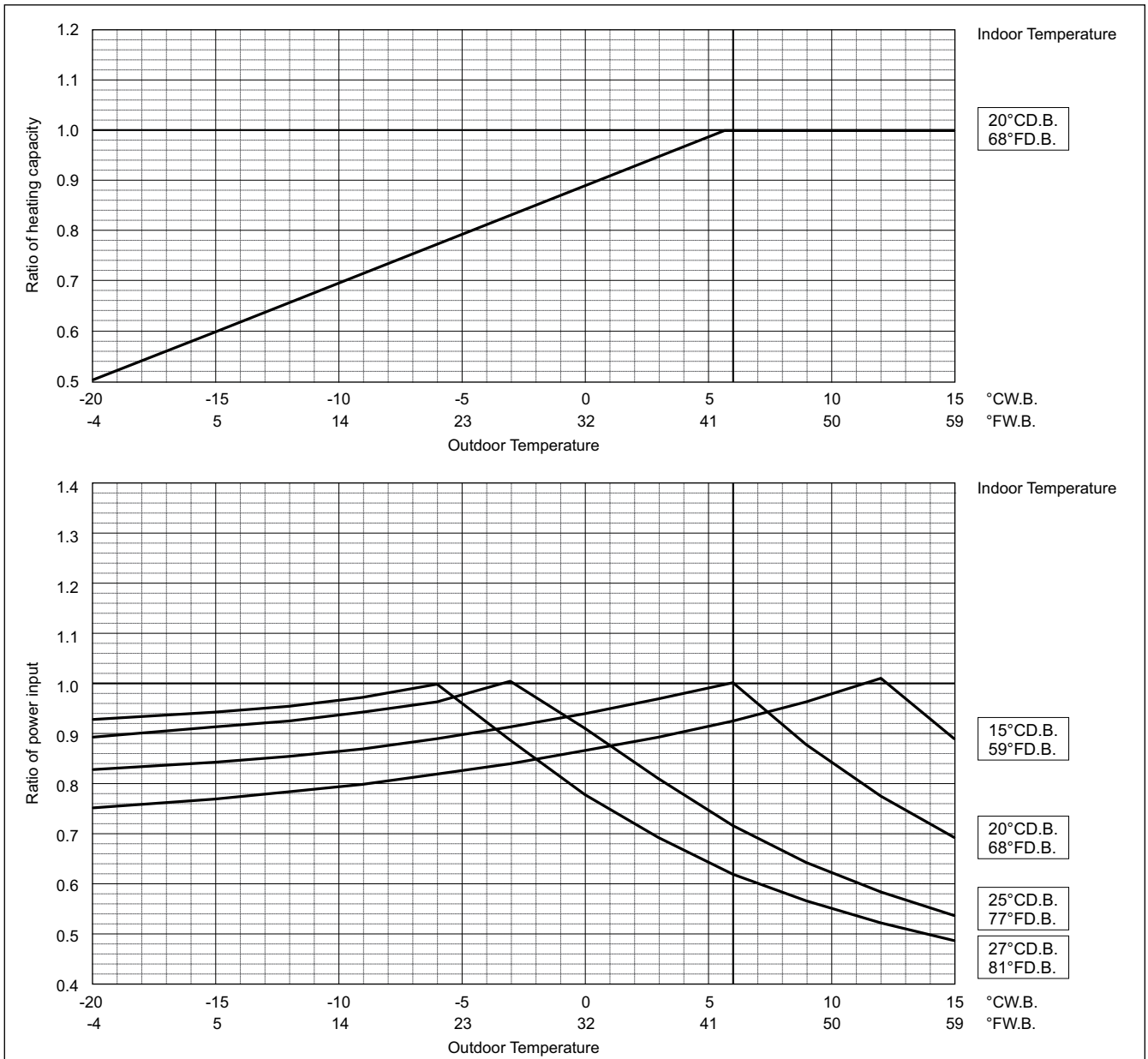

Outdoor unit power input is affected by the indoor and outdoor temperatures as shown in the graph above. Please consult the sales office for details.

8. CAPACITY TABLES

R2 (HIGH COP)

PURY-	EP850YSLM-A	EP900YSLM-A
Nominal Cooling Capacity kW	96.0	101.0
Nominal Cooling Capacity BTU/h	327,600	344,600
Input kW	28.48	30.98

Indoor unit temperature correction

To be used to correct indoor unit capacity only

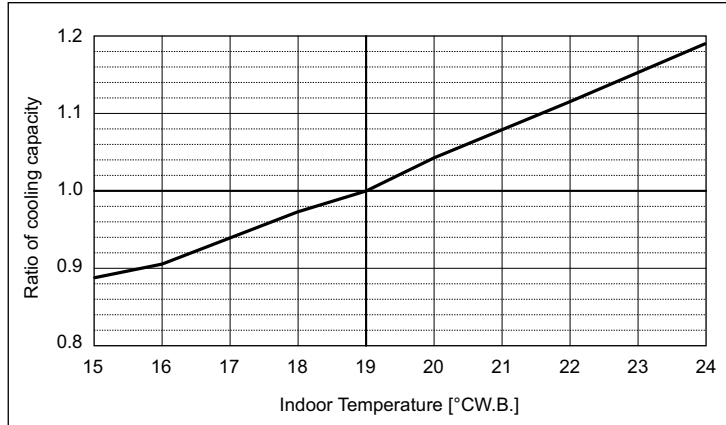

Outdoor unit temperature correction

To be used to correct outdoor unit only

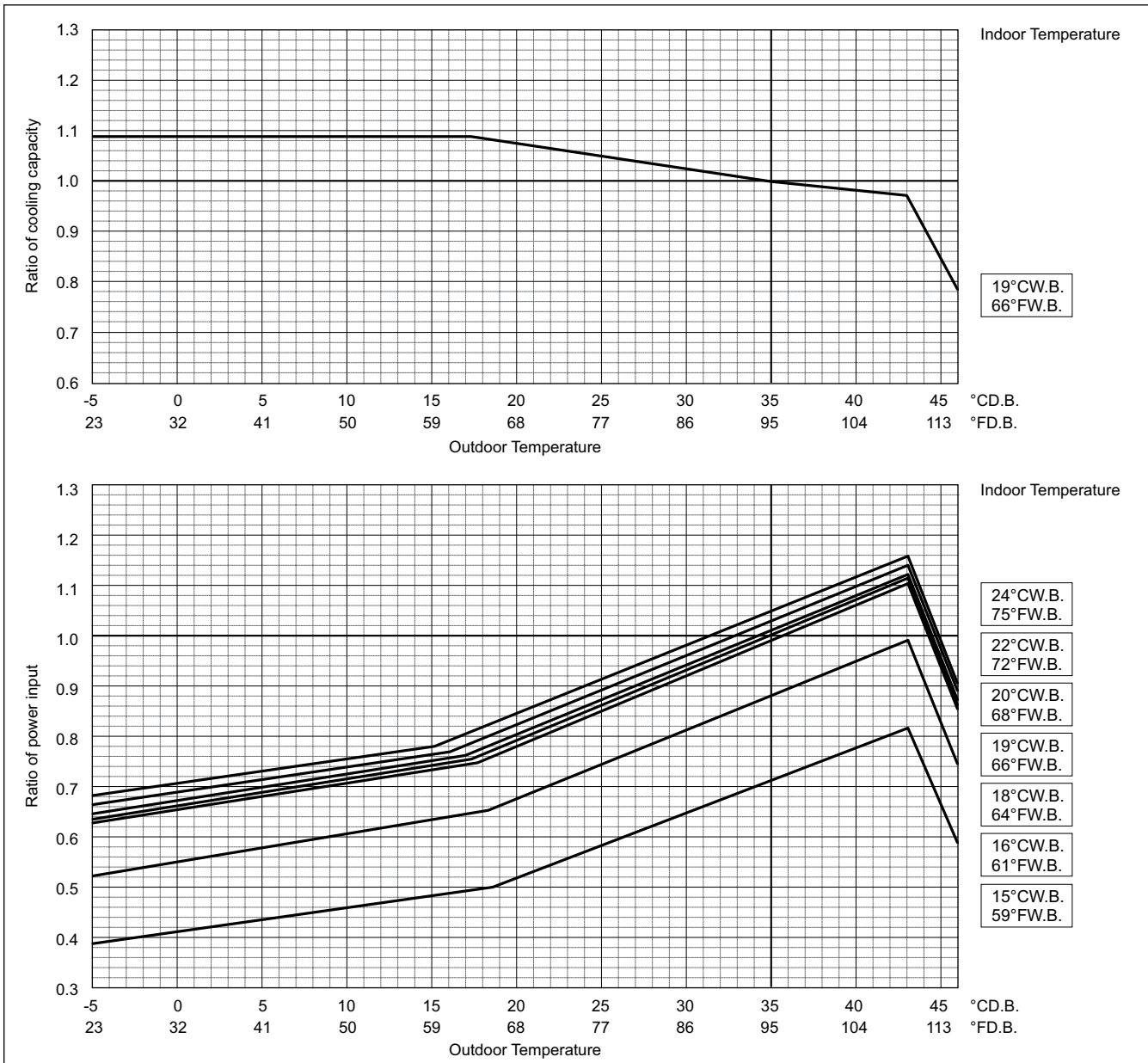

Outdoor unit power input is affected by the indoor and outdoor temperatures as shown in the graph above. Please consult the sales office for details.

PURY-	EP850YSLM-A	EP900YSLM-A
Nominal Heating Capacity kW	108.0	113.0
BTU/h	368,500	385,600
Input kW	29.75	32.01

Indoor unit temperature correction

To be used to correct indoor unit capacity only

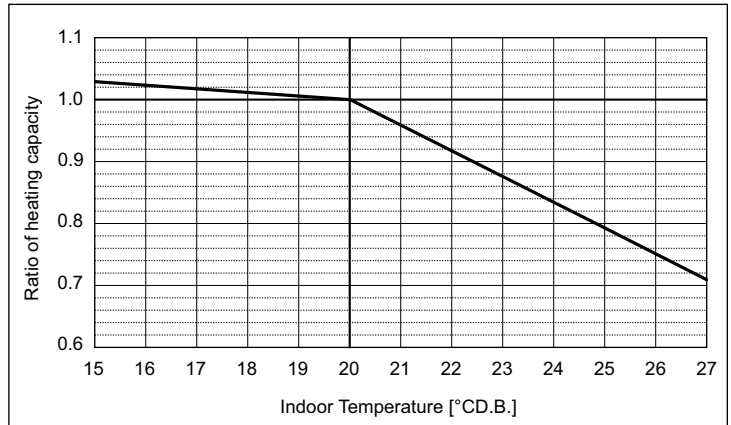

R2 (HIGH COP)

Outdoor unit temperature correction

To be used to correct outdoor unit only

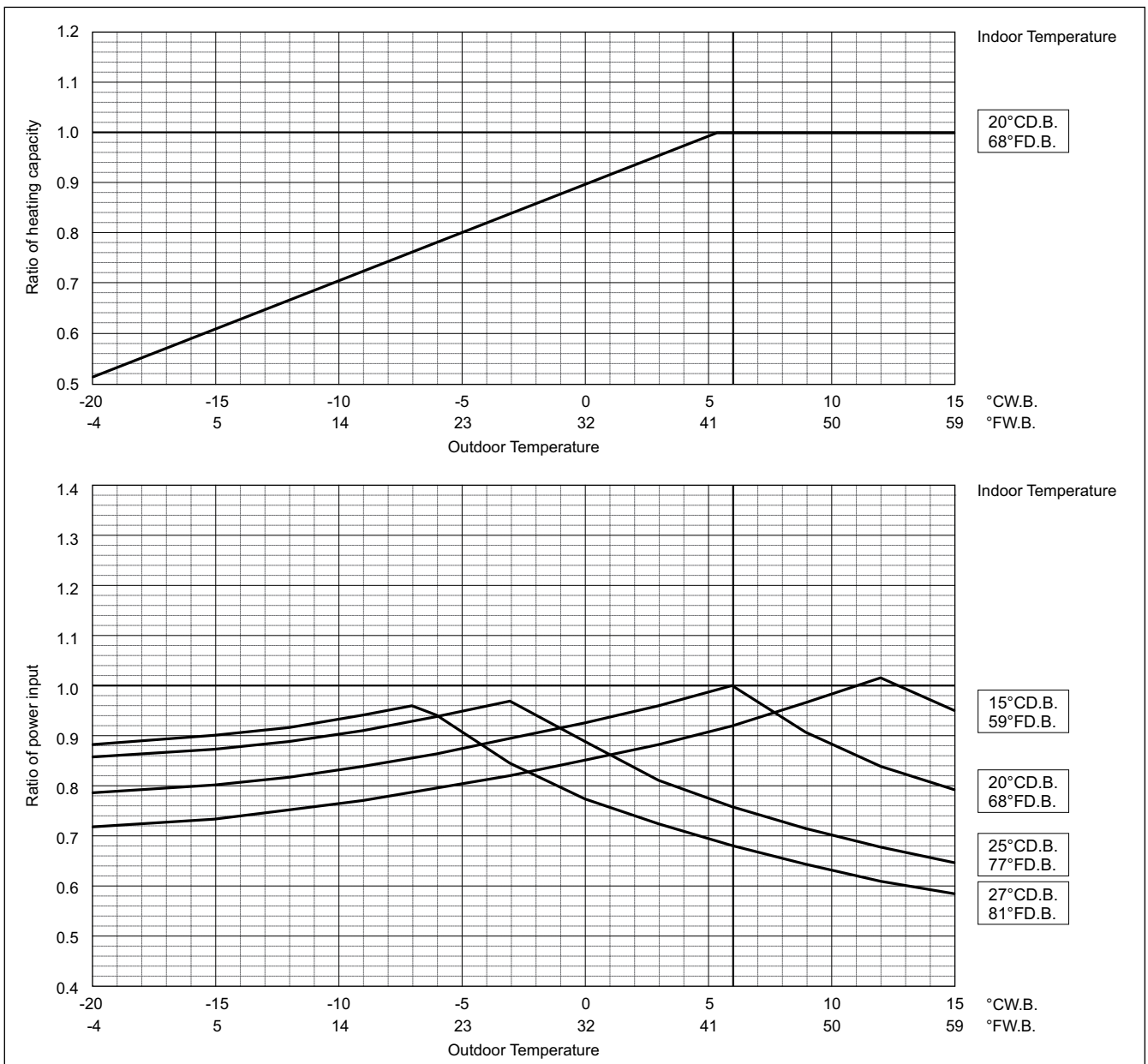

Outdoor unit power input is affected by the indoor and outdoor temperatures as shown in the graph above. Please consult the sales office for details.

8-3. Correction by total indoor

CITY MULTI system have different capacities and inputs when many combinations of indoor units with different total capacities are connected. Using following tables, the maximum capacity can be found to ensure the system is installed with enough capacity for a particular application.

R2 (HIGH COP)

PURY-EP200YLM-A		
Nominal Cooling Capacity	kW	22.4
	BTU/h	76,400
Input	kW	5.48

PURY-EP200YLM-A		
Nominal Heating Capacity	kW	25.0
	BTU/h	85,300
Input	kW	6.41

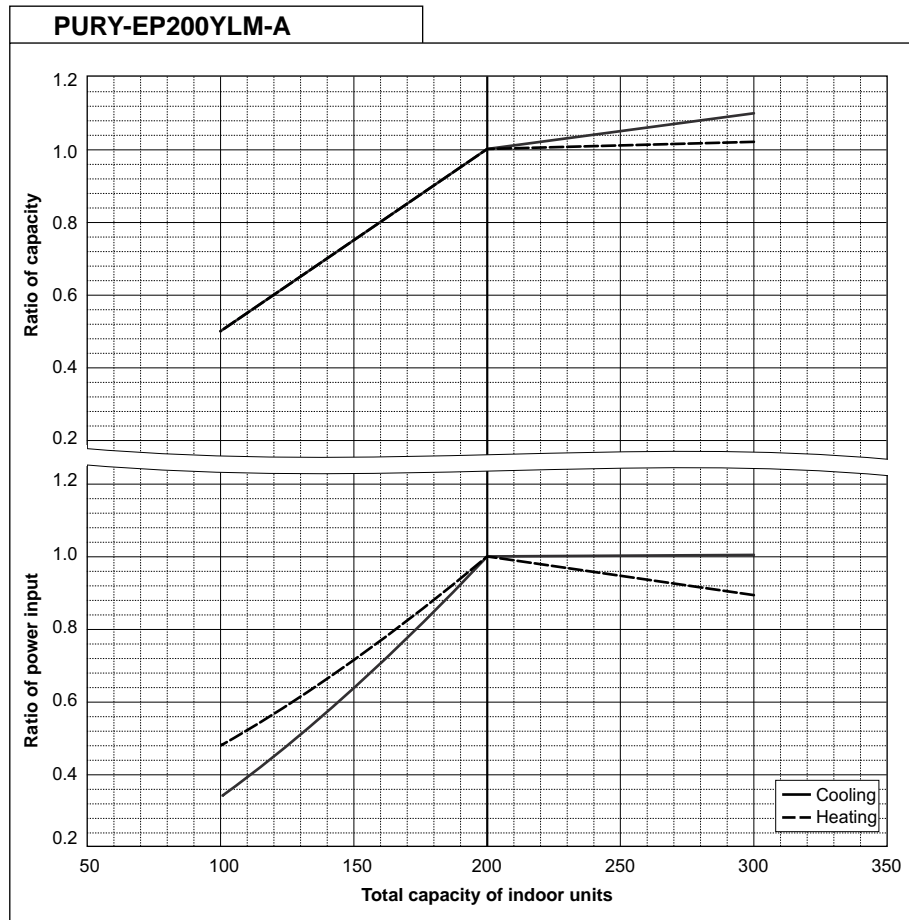

PURY-EP250YLM-A		
Nominal Cooling Capacity	kW	28.0
	BTU/h	95,500
Input	kW	7.25

PURY-EP250YLM-A		
Nominal Heating Capacity	kW	31.5
	BTU/h	107,500
Input	kW	8.45

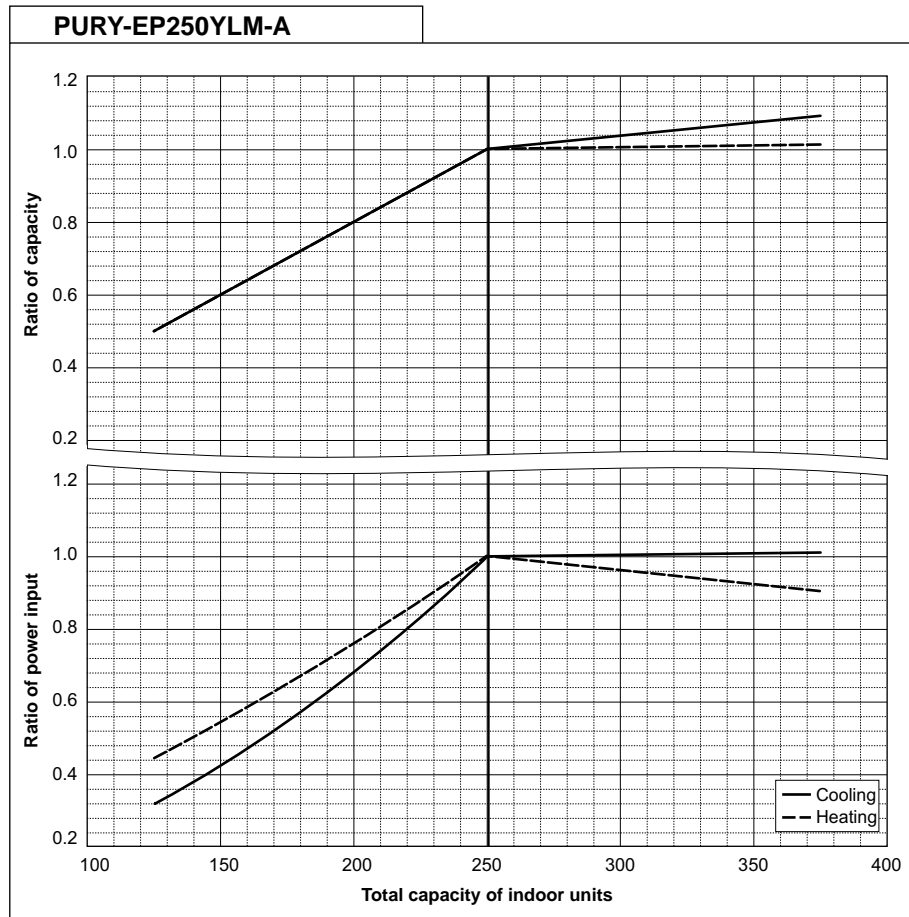

PURY-EP300YLM-A		
Nominal Cooling Capacity	kW	33.5
	BTU/h	114,300
Input	kW	9.20

PURY-EP300YLM-A		
Nominal Heating Capacity	kW	37.5
	BTU/h	128,000
Input	kW	9.97

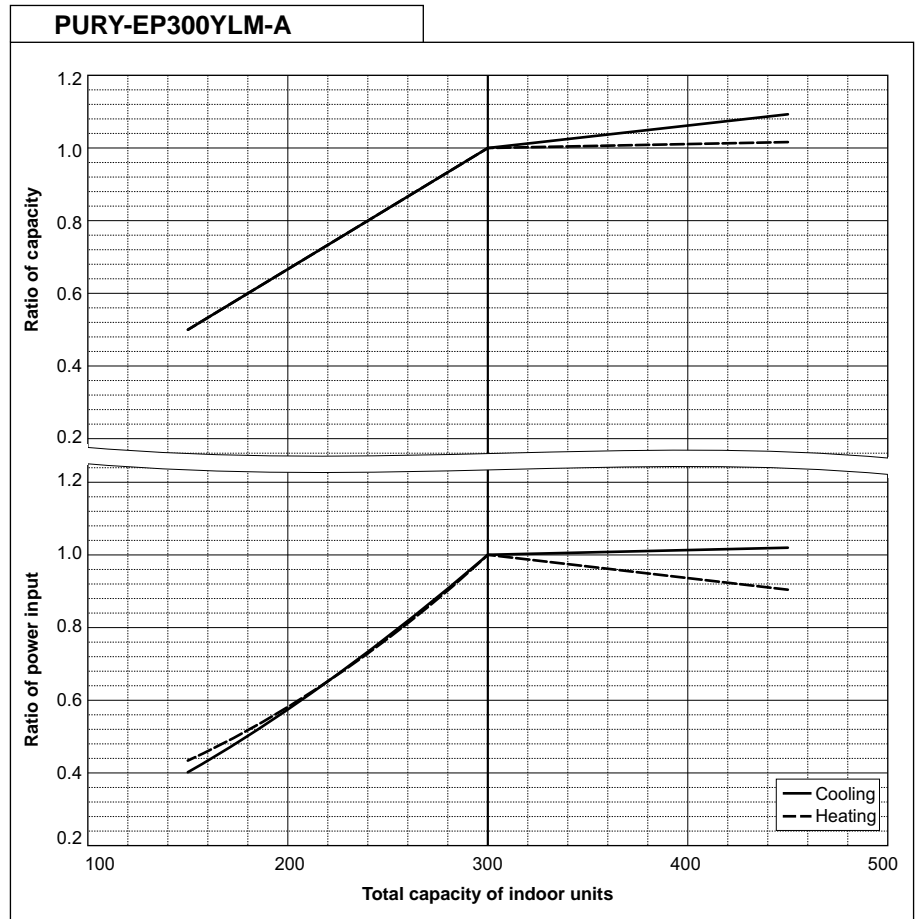

PURY-EP350YLM-A		
Nominal Cooling Capacity	kW	40.0
	BTU/h	136,500
Input	kW	12.57

PURY-EP350YLM-A		
Nominal Heating Capacity	kW	45.0
	BTU/h	153,500
Input	kW	12.93

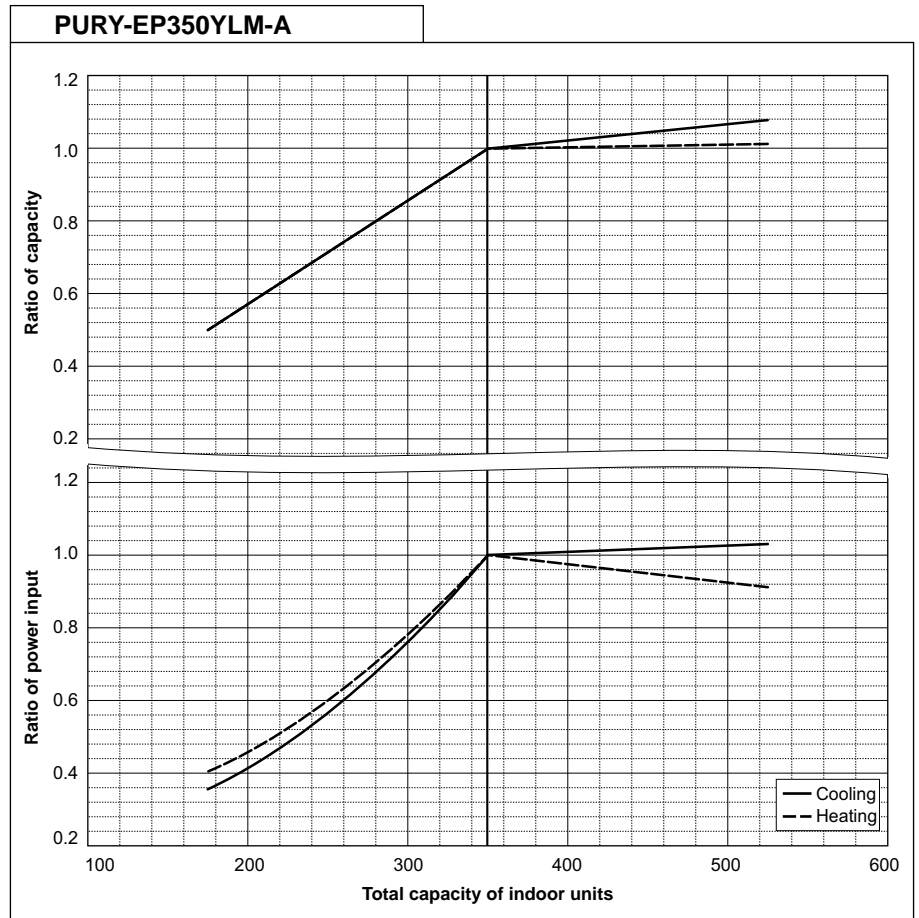

8. CAPACITY TABLES

YKB/YLM

R2 (HIGH COP)

PURY-EP400YLM-A		
Nominal Cooling Capacity	kW	45.0
	BTU/h	153,500
Input	kW	12.56

PURY-EP400YLM-A		
Nominal Heating Capacity	kW	50.0
	BTU/h	170,600
Input	kW	13.40

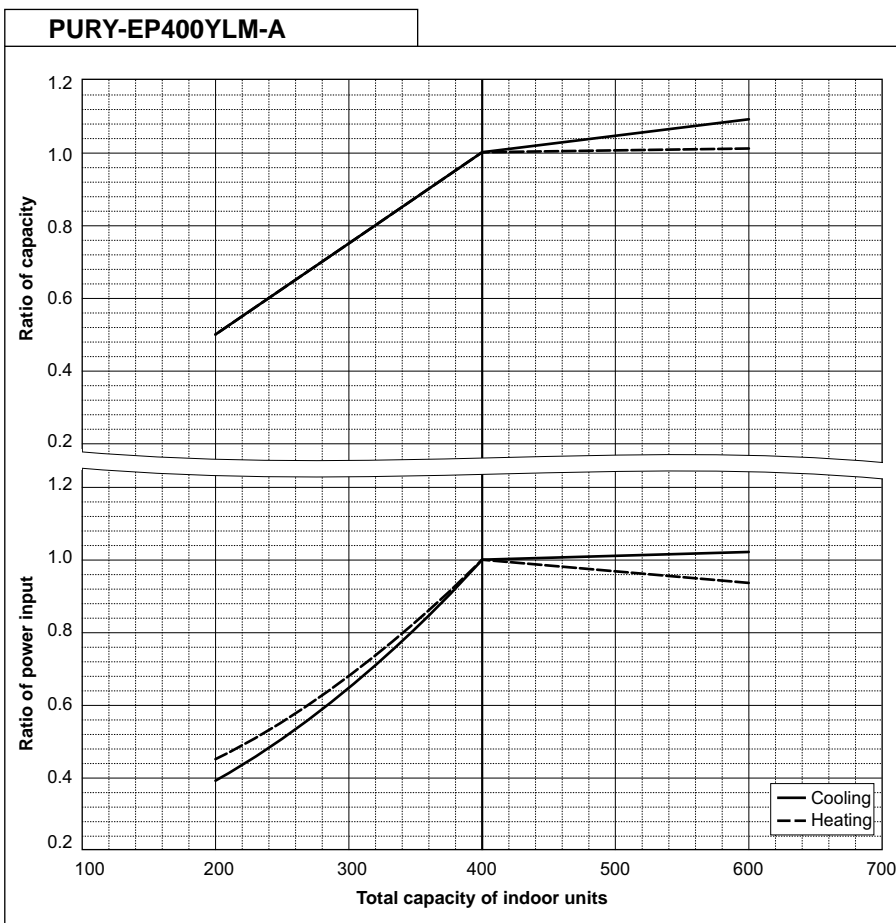

PURY-EP450YLM-A		
Nominal Cooling Capacity	kW	50.0
	BTU/h	170,600
Input	kW	14.83

PURY-EP450YLM-A		
Nominal Heating Capacity	kW	56.0
	BTU/h	191,100
Input	kW	15.86

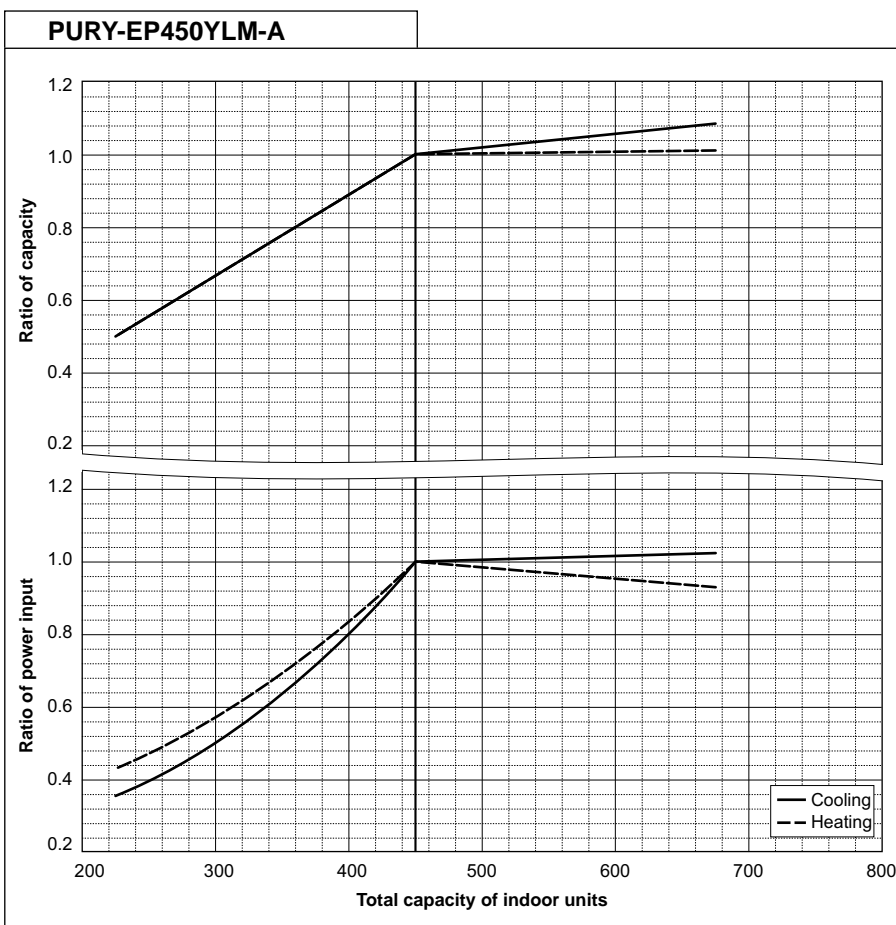

PURY-EP500YLM-A		
Nominal Cooling Capacity	kW	56.0
	BTU/h	191,100
Input	kW	18.30

PURY-EP500YLM-A		
Nominal Heating Capacity	kW	63.0
	BTU/h	215,000
Input	kW	19.54

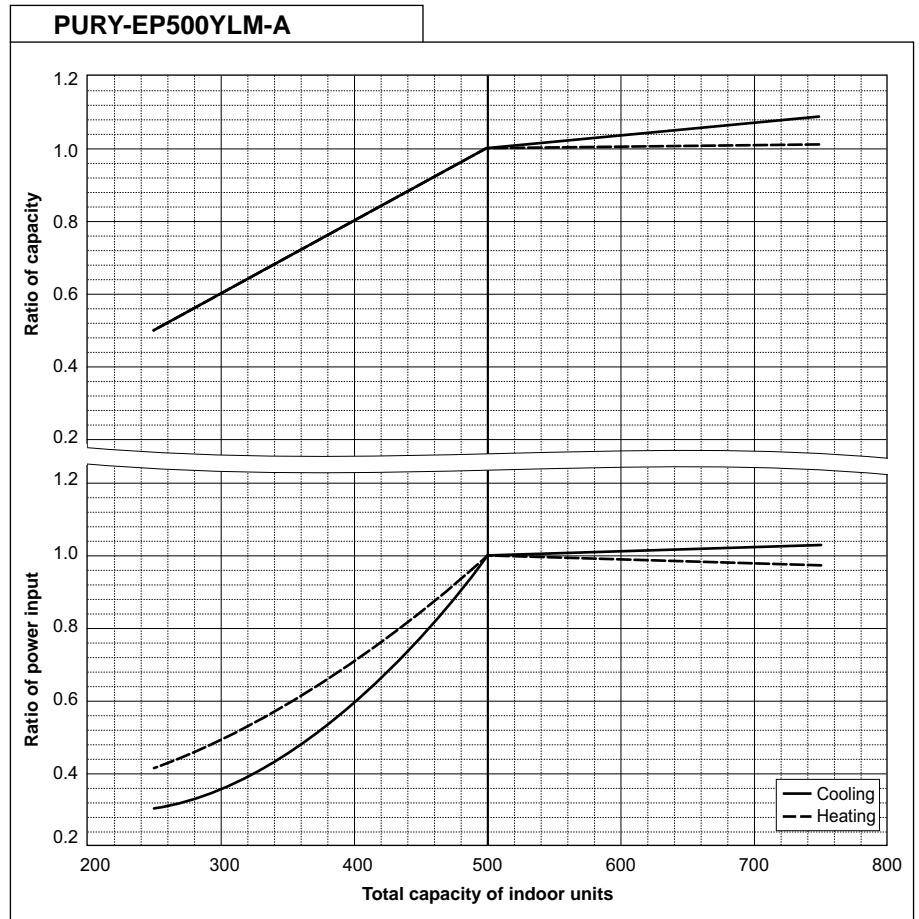

PURY-EP550YSLM-A		
Nominal Cooling Capacity	kW	63.0
	BTU/h	215,000
Input	kW	17.35

PURY-EP550YSLM-A		
Nominal Heating Capacity	kW	69.0
	BTU/h	235,400
Input	kW	18.44

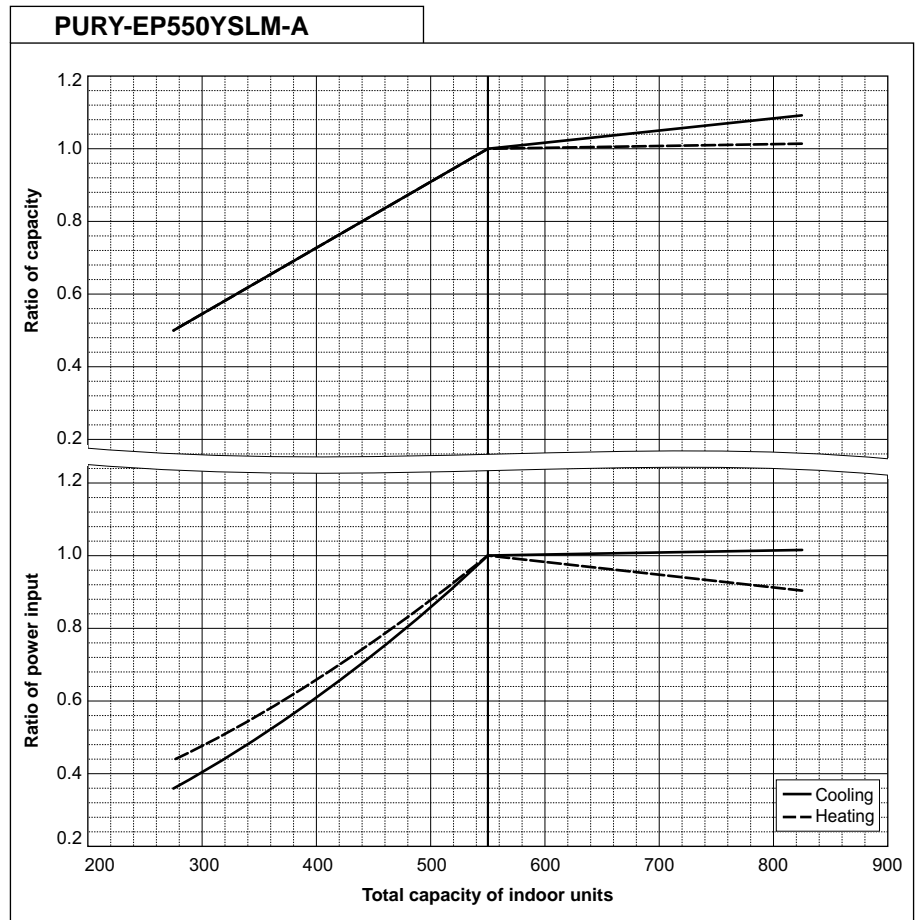

8. CAPACITY TABLES

YKB/YLM

R2 (HIGH COP)

PURY-EP600YSLM-A		
Nominal Cooling Capacity	kW	69.0
	BTU/h	235,400
Input	kW	19.54

PURY-EP600YSLM-A		
Nominal Heating Capacity	kW	76.5
	BTU/h	261,000
Input	kW	20.34

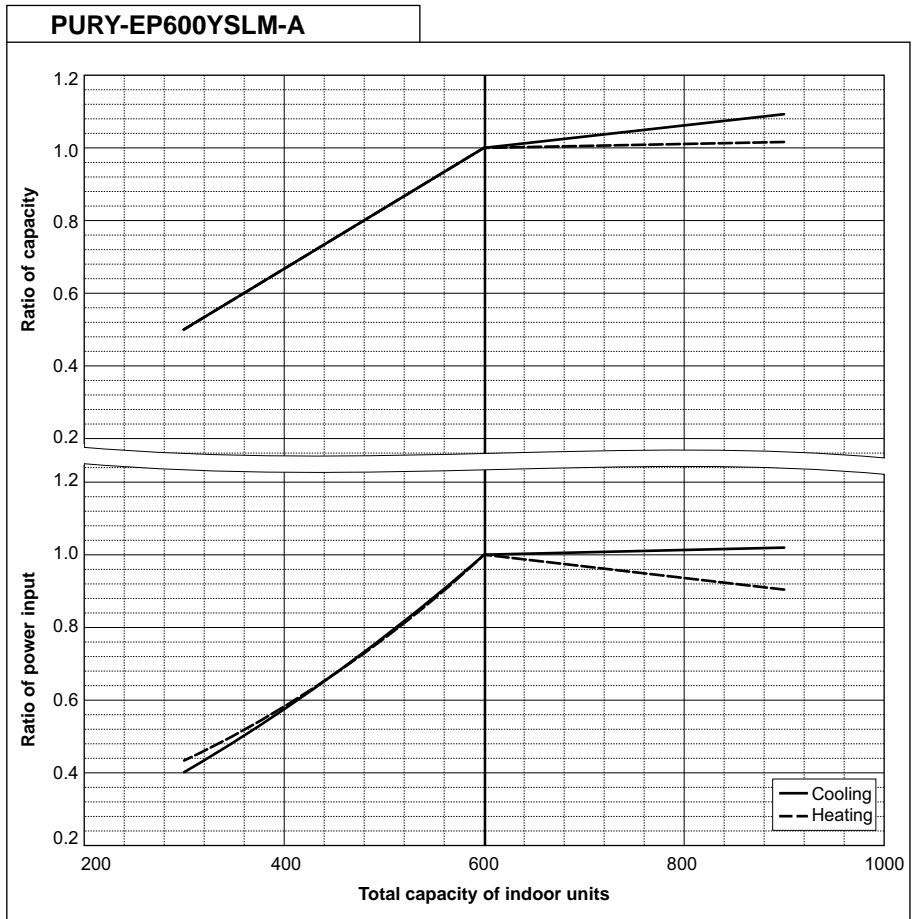

PURY-EP650YSLM-A		
Nominal Cooling Capacity	kW	73.0
	BTU/h	249,100
Input	kW	22.12

PURY-EP650YSLM-A		
Nominal Heating Capacity	kW	81.5
	BTU/h	278,100
Input	kW	22.51

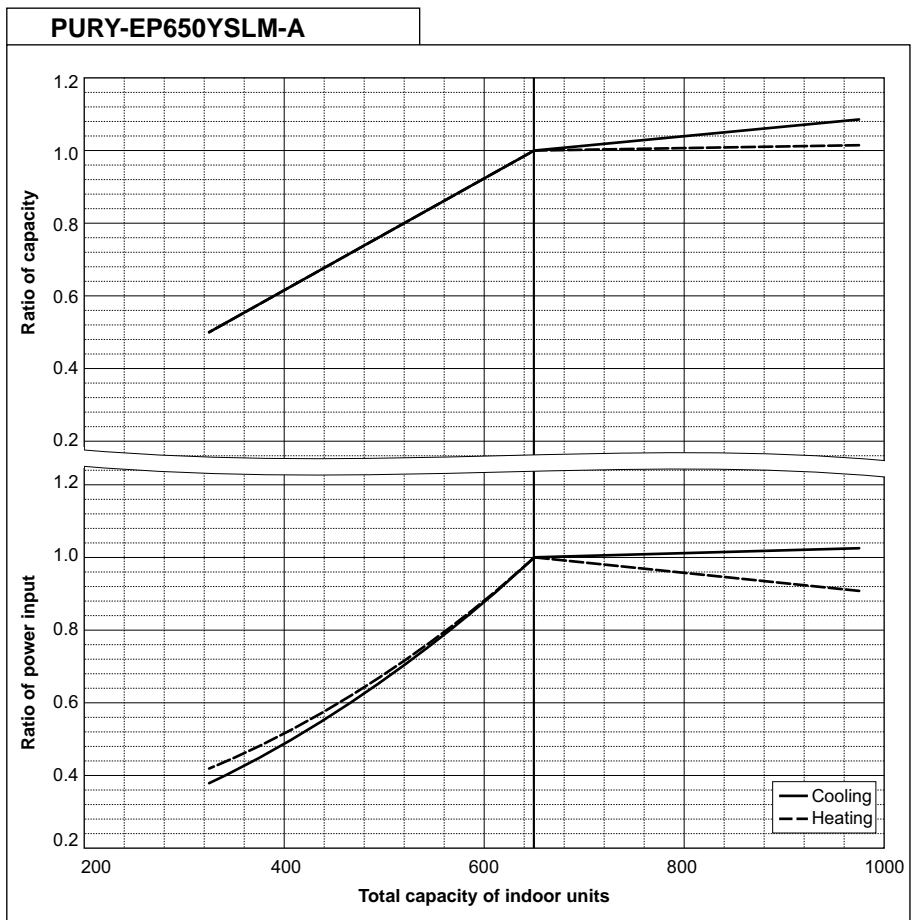

PURY-EP700YSLM-A		
Nominal Cooling Capacity	kW	80.0
	BTU/h	273,000
Input	kW	25.97

PURY-EP700YSLM-A		
Nominal Heating Capacity	kW	88.0
	BTU/h	300,300
Input	kW	25.28

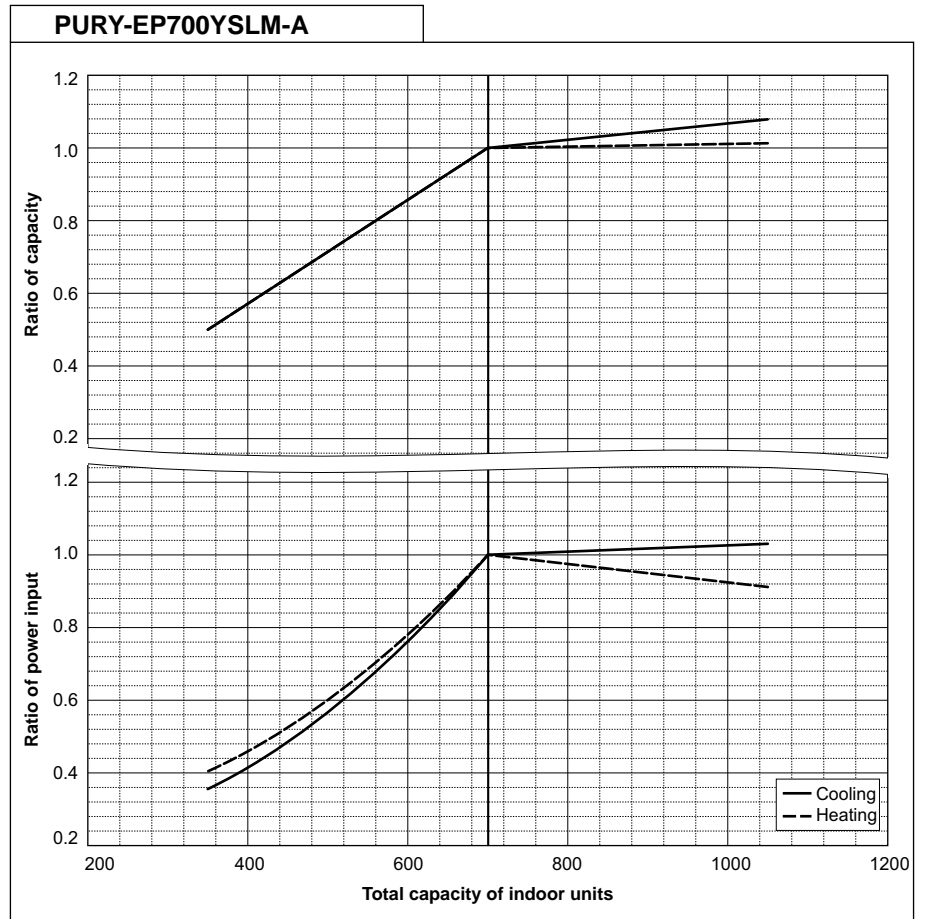

PURY-EP750YSLM-A		
Nominal Cooling Capacity	kW	85.0
	BTU/h	290,000
Input	kW	25.99

PURY-EP750YSLM-A		
Nominal Heating Capacity	kW	95.0
	BTU/h	324,100
Input	kW	26.38

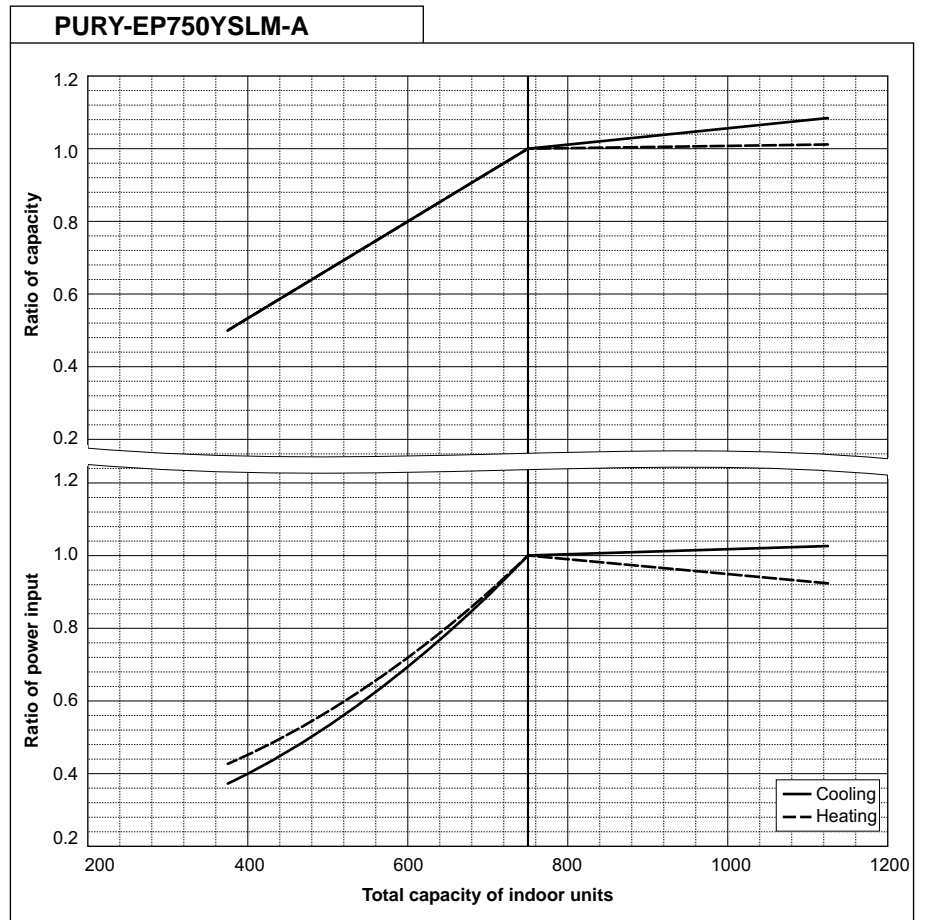

8. CAPACITY TABLES

YKB/YLM

R2 (HIGH COP)

PURY-EP800YSLM-A		
Nominal Cooling Capacity	kW	90.0
	BTU/h	307,100
Input	kW	25.93

PURY-EP800YSLM-A		
Nominal Heating Capacity	kW	100.0
	BTU/h	341,200
Input	kW	26.80

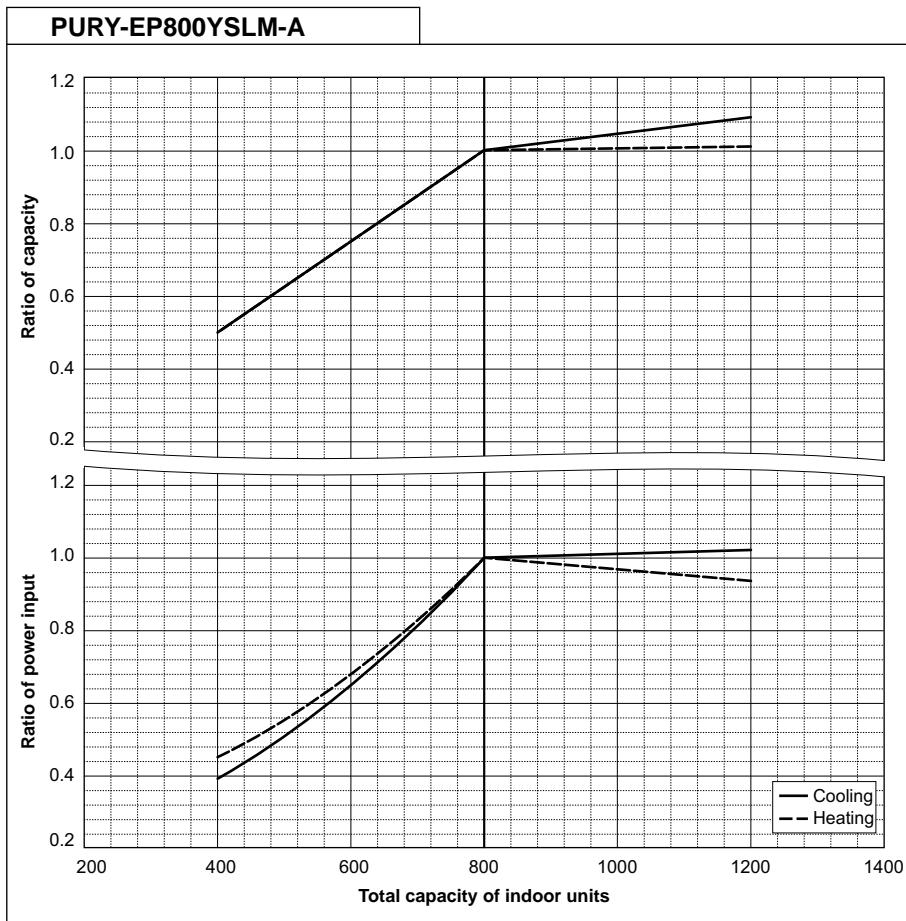

PURY-EP850YSLM-A		
Nominal Cooling Capacity	kW	96.0
	BTU/h	327,600
Input	kW	28.48

PURY-EP850YSLM-A		
Nominal Heating Capacity	kW	108.0
	BTU/h	368,500
Input	kW	29.75

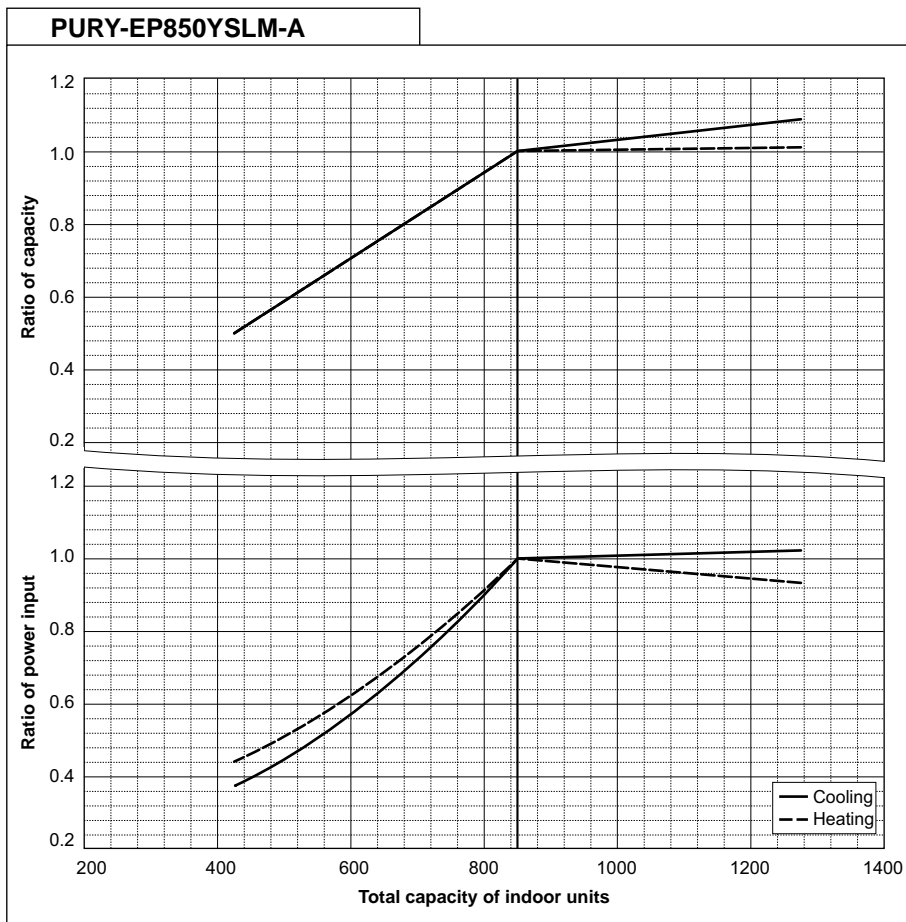

PURY-EP900YSLM-A		
Nominal Cooling Capacity	kW	101.0
	BTU/h	344,600
Input	kW	30.98

PURY-EP900YSLM-A		
Nominal Heating Capacity	kW	113.0
	BTU/h	385,600
Input	kW	32.01

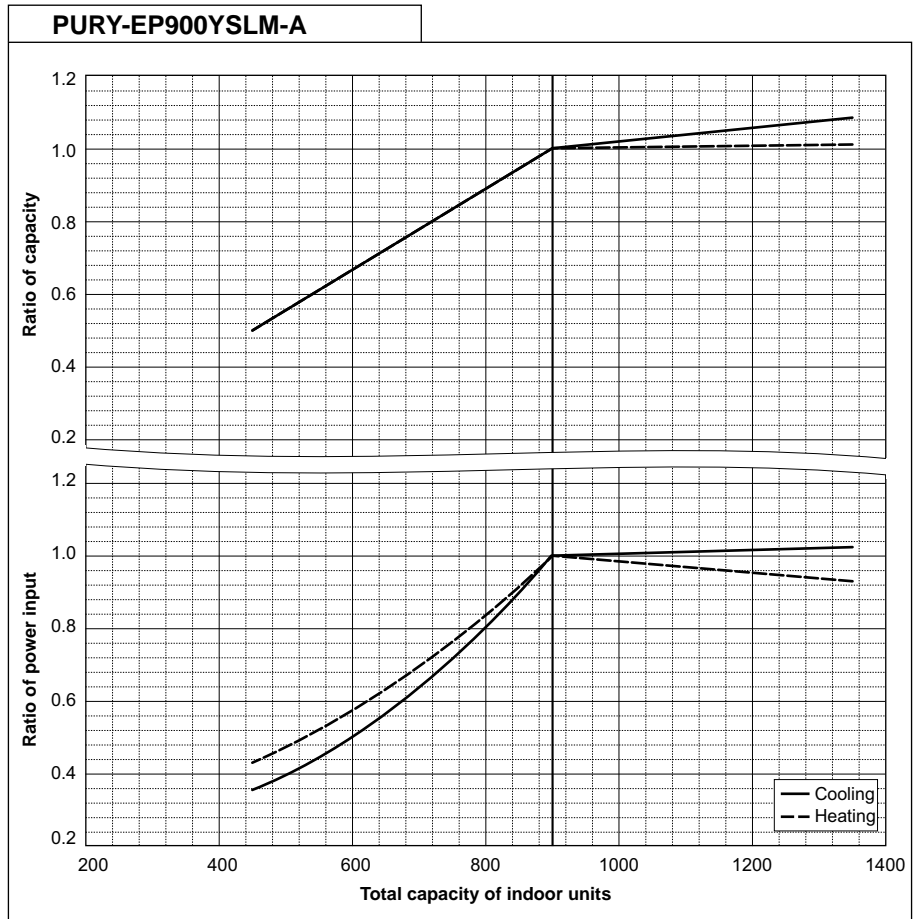

R2 (HIGH COP)

8-4. Correction by refrigerant piping length

CITY MULTI system can extend the piping flexibly within its limitation for the actual situation. However, a decrease of cooling/heating capacity could happen correspondently. Using following correction factor according to the equivalent length of the piping shown at 8-4-1 and 8-4-2, the capacity can be observed. 8-4-3 shows how to obtain the equivalent length of piping.

8-4-1. Cooling capacity correction

R2 (HIGH COP)

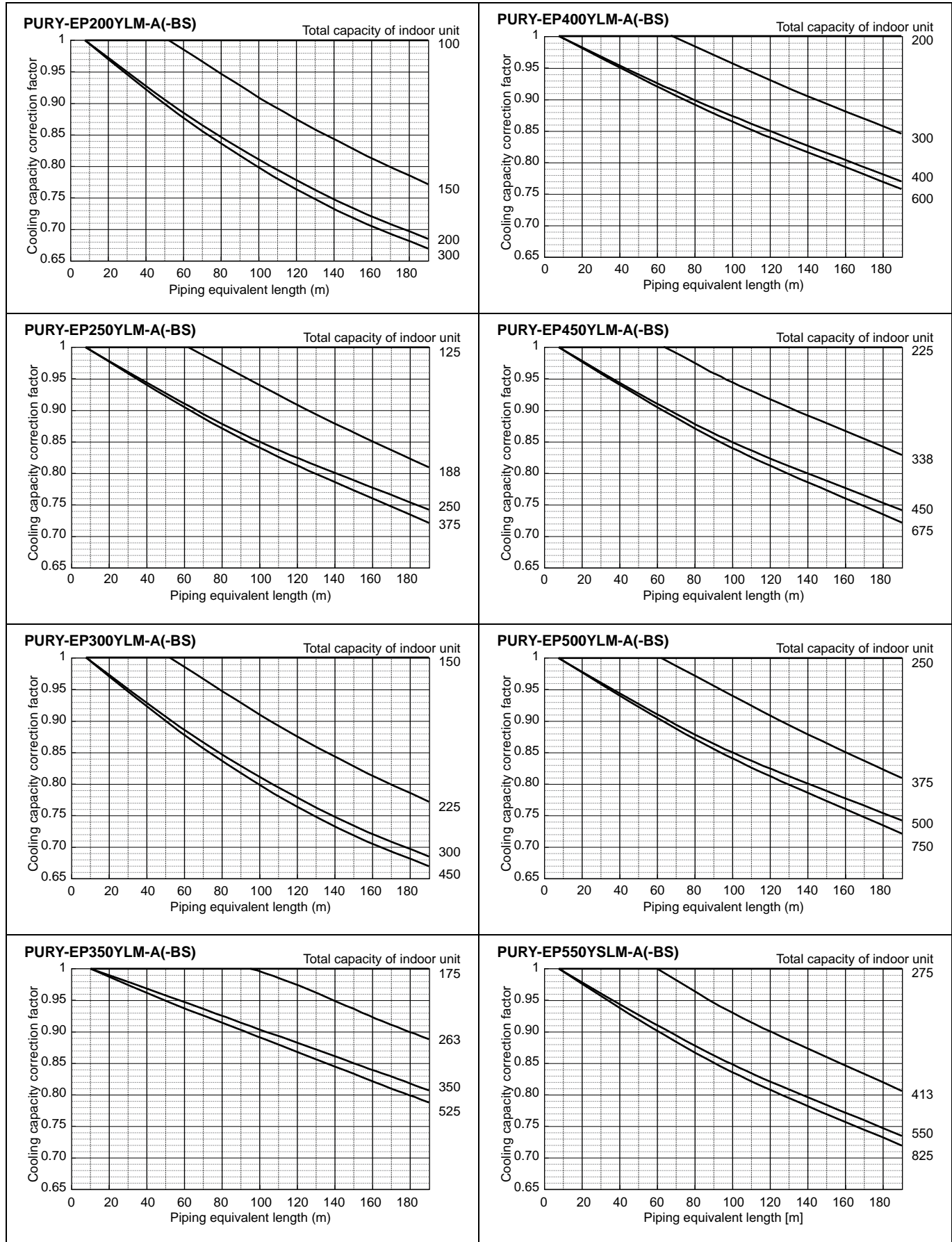

8. CAPACITY TABLES

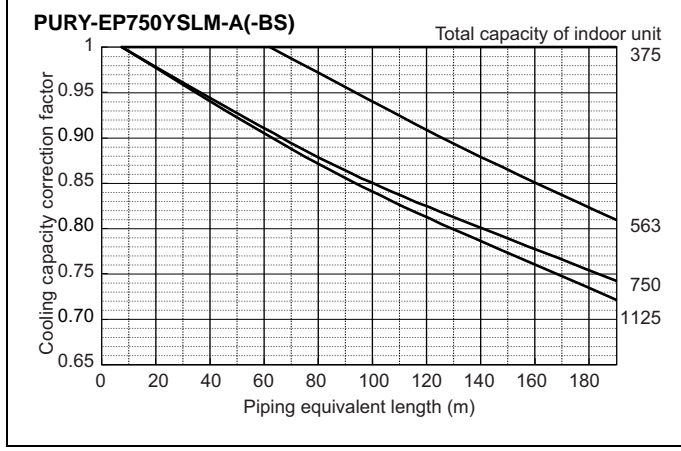
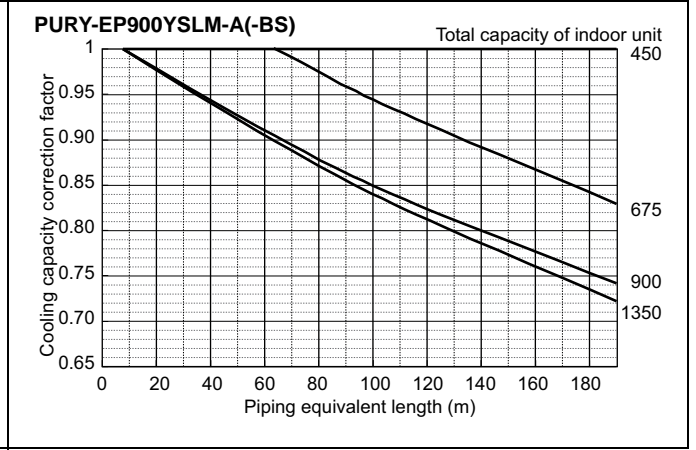
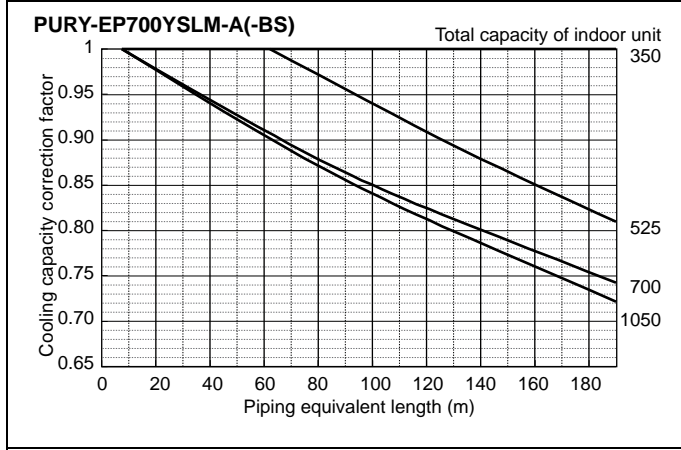
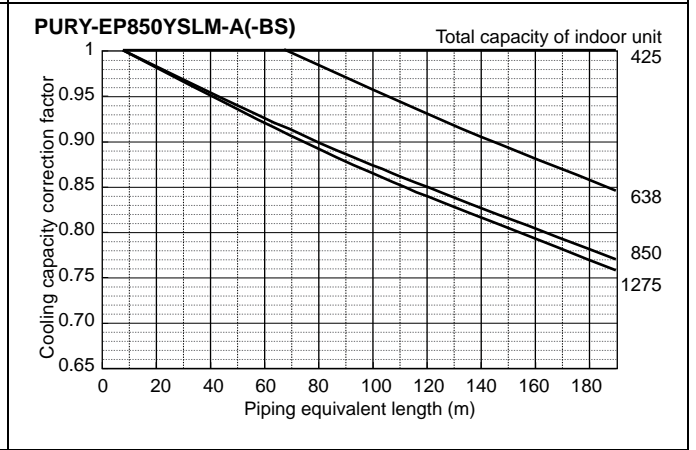
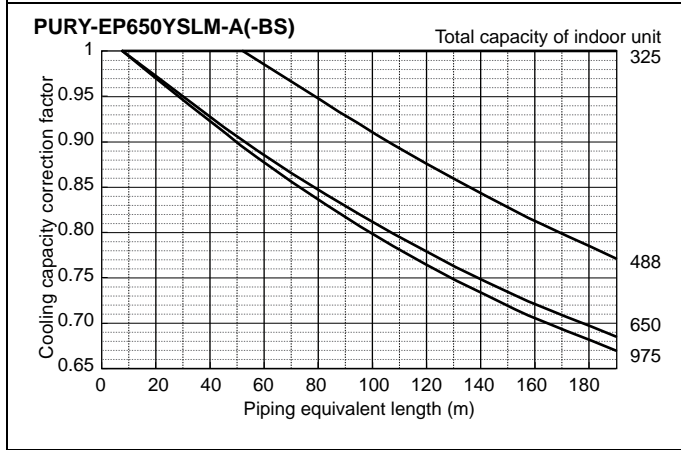
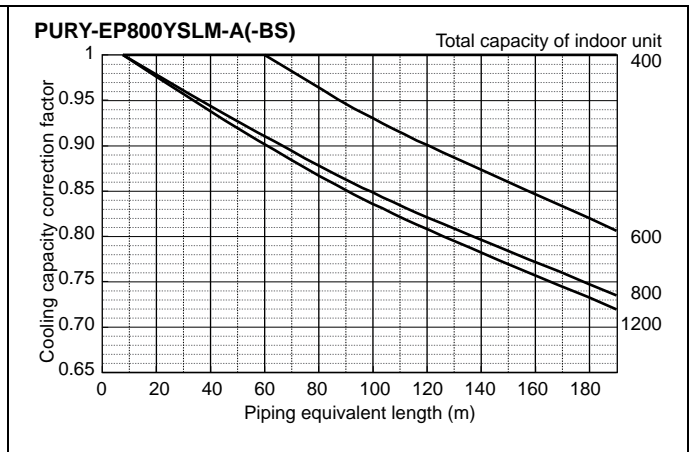
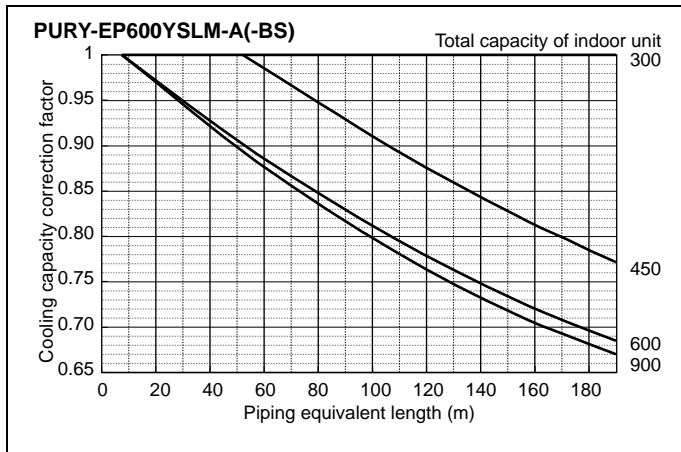

8-4-2. Heating capacity correction

R2 (HIGH COP)

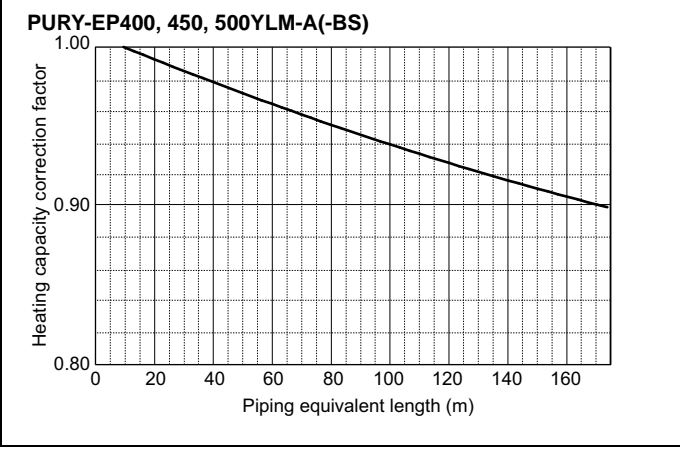
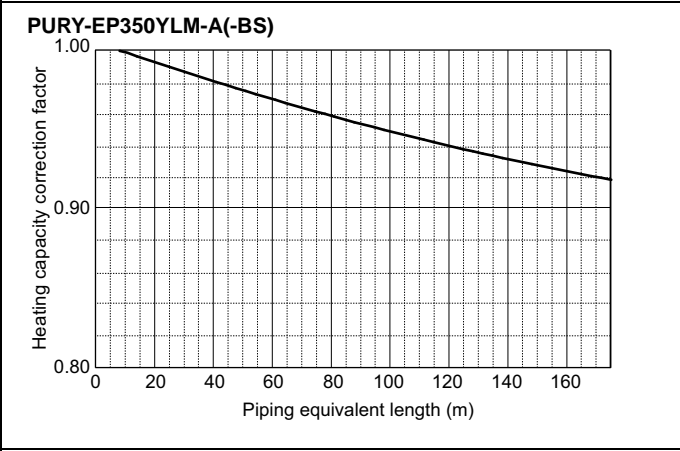
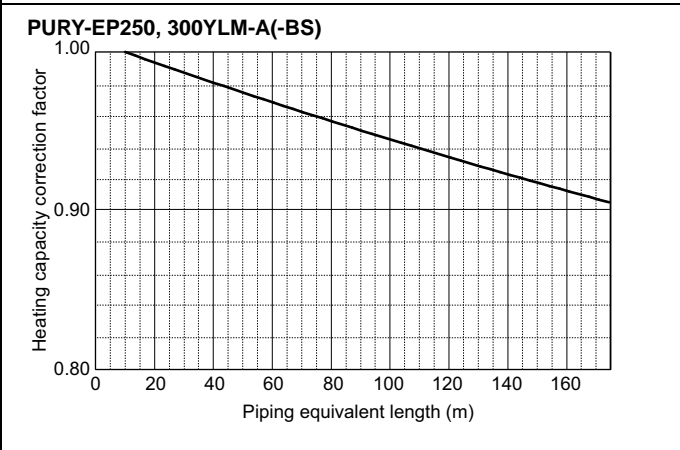
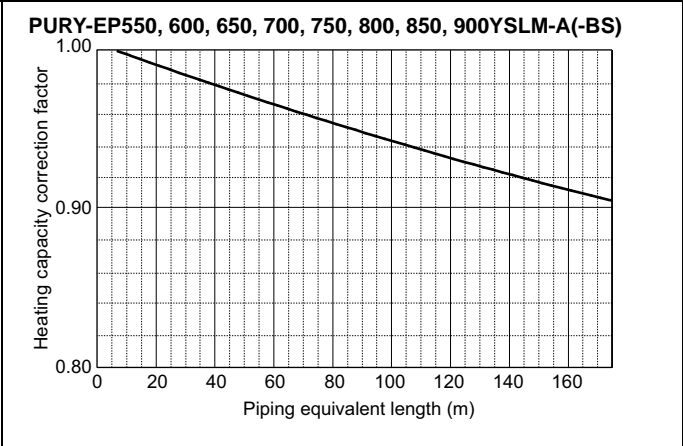
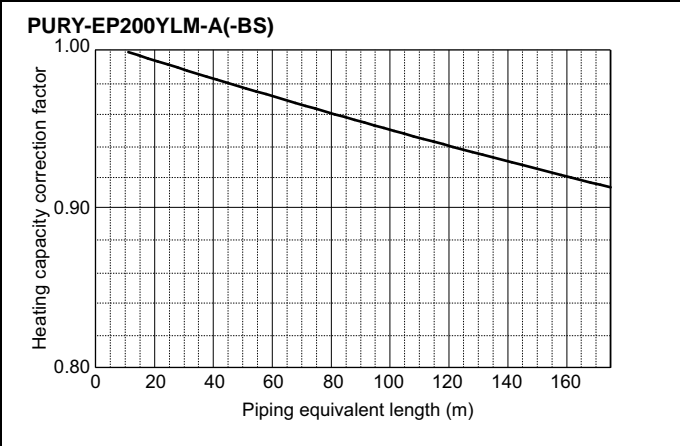

8-4-3. How to obtain the equivalent piping length

- 1 **PURY-EP200YLM-A(-BS)**
Equivalent length = (Actual piping length to the farthest indoor unit) + (0.35 × number of bends in the piping) m
- 2 **PURY-EP250, 300YLM-A(-BS)**
Equivalent length = (Actual piping length to the farthest indoor unit) + (0.42 × number of bends in the piping) m
- 3 **PURY-EP350YLM-A(-BS)**
Equivalent length = (Actual piping length to the farthest indoor unit) + (0.47 × number of bends in the piping) m
- 4 **PURY-EP400, 450, 500YLM-A(-BS), EP550, 600, 650YSLM-A(-BS)**
Equivalent length = (Actual piping length to the farthest indoor unit) + (0.50 × number of bends in the piping) m
- 5 **PURY-EP700YSLM-A(-BS)**
Equivalent length = (Actual piping length to the farthest indoor unit) + (0.70 × number of bends in the piping) m
- 6 **PURY-P850, 900YSLM-A(-BS)**
Equivalent length = (Actual piping length to the farthest indoor unit) + (0.80 × number of bends in the piping) m

8-5. Correction by port counts of the BC controller

Indoor unit sizes P200 and P250 must be connected to 2 ports on the BC controller.

Indoor unit sizes from P100 to P140 should normally be connected to 2 ports on the BC controller (set BC controller DIP-SW 4-6 to its ON position).

In cases whereby indoor unit sizes from P100 to P140 are connected to only 1port on the BC controller (set BC controller DIP-SW 4-6 to its OFF position), the cooling capacity of the indoor unit should be multiplied by a correction factor of **0.97**.

8-6. Correction at frost and defrost

Due to frost at the outdoor heat exchanger and the automatic defrost operation, the heating capacity of the outdoor unit can be calculated by multiplying the correction factor shown in the table below.

Table of correction factor at frosting and defrosting

Outdoor inlet air temp. °C	6	4	2	1	0	-2	-4	-6	-8	-10	-20
Outdoor inlet air temp. °F	43	39	36	34	32	28	25	21	18	14	-4
PURY-EP200YLM-A(-BS)	1.00	0.95	0.84	0.83	0.83	0.87	0.90	0.95	0.95	0.95	0.95
PURY-EP250YLM-A(-BS)	1.00	0.95	0.84	0.83	0.83	0.87	0.90	0.95	0.95	0.95	0.95
PURY-EP300YLM-A(-BS)	1.00	0.93	0.82	0.80	0.82	0.86	0.90	0.90	0.95	0.95	0.95
PURY-EP350YLM-A(-BS)	1.00	0.93	0.85	0.83	0.84	0.86	0.90	0.90	0.95	0.95	0.95
PURY-EP400YLM-A(-BS)	1.00	0.95	0.90	0.87	0.88	0.89	0.90	0.95	0.95	0.95	0.95
PURY-EP450YLM-A(-BS)	1.00	0.98	0.89	0.87	0.89	0.90	0.92	0.95	0.95	0.95	0.95
PURY-EP500YLM-A(-BS)	1.00	0.98	0.89	0.86	0.89	0.90	0.92	0.95	0.95	0.95	0.95
PURY-EP550YSLM-A(-BS)	1.00	0.94	0.87	0.86	0.87	0.88	0.90	0.90	0.93	0.93	0.93
PURY-EP600YSLM-A(-BS)	1.00	0.94	0.84	0.86	0.87	0.88	0.90	0.90	0.93	0.93	0.93
PURY-EP650YSLM-A(-BS)	1.00	0.94	0.84	0.86	0.87	0.88	0.90	0.90	0.93	0.93	0.93
PURY-EP700YSLM-A(-BS)	1.00	0.98	0.89	0.88	0.89	0.90	0.92	0.95	0.95	0.95	0.95
PURY-EP750YSLM-A(-BS)	1.00	0.98	0.89	0.88	0.89	0.90	0.92	0.95	0.95	0.95	0.95
PURY-EP800YSLM-A(-BS)	1.00	0.98	0.89	0.88	0.89	0.90	0.92	0.95	0.95	0.95	0.95
PURY-EP850YSLM-A(-BS)	1.00	0.98	0.89	0.88	0.89	0.90	0.92	0.95	0.95	0.95	0.95
PURY-EP900YSLM-A(-BS)	1.00	0.98	0.89	0.88	0.89	0.90	0.92	0.95	0.95	0.95	0.95

9-1. JOINT

CITY MULTI units can be easily connected by using Joint sets and Header sets provided by Mitsubishi Electric. Three kinds of Joint sets are available for use. Refer to section 3 in "System Design" or the Installation Manual that comes with the Joint set for how to install the Joint set.

R2 (HIGH COP)

CMY-Y102SS-G2

mm

For Gas pipe:

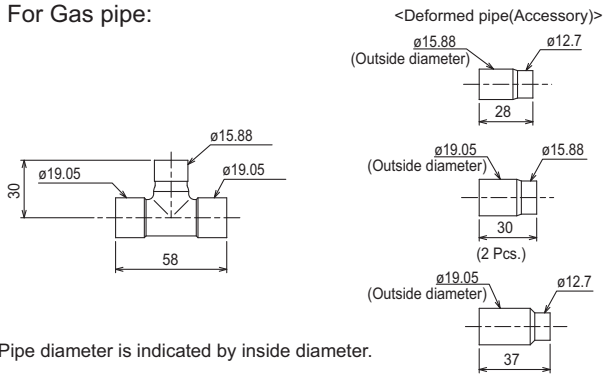

For Liquid pipe:

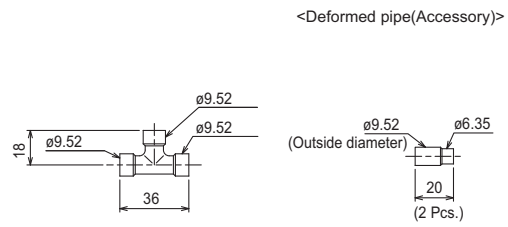

*Pipe diameter is indicated by inside diameter.

CMY-Y102LS-G2

mm

For Gas pipe:

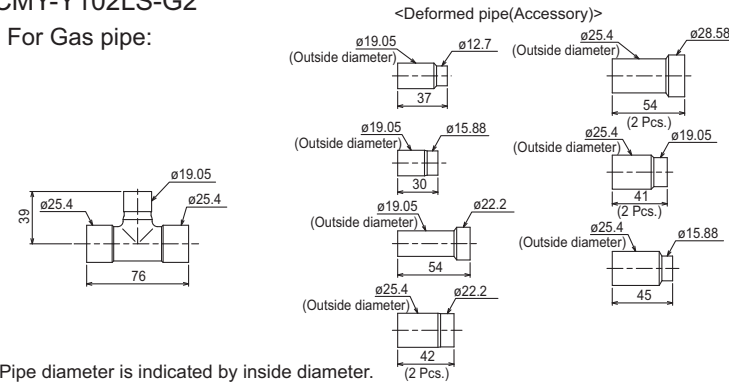

For Liquid pipe:

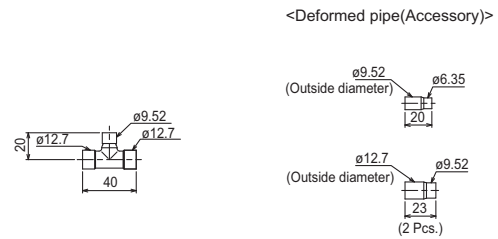

*Pipe diameter is indicated by inside diameter.

CMY-Y202S-G2

mm

For Gas pipe:

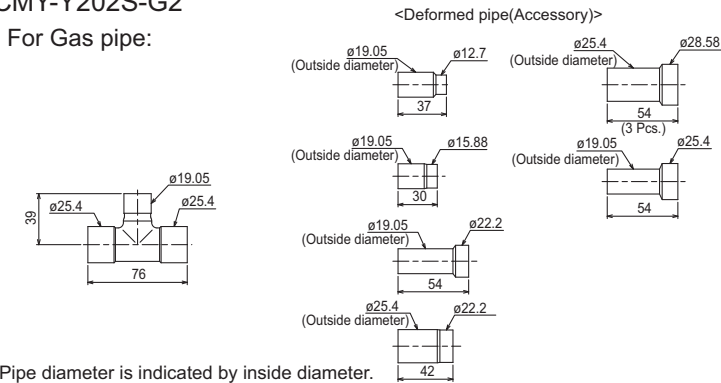

For Liquid pipe:

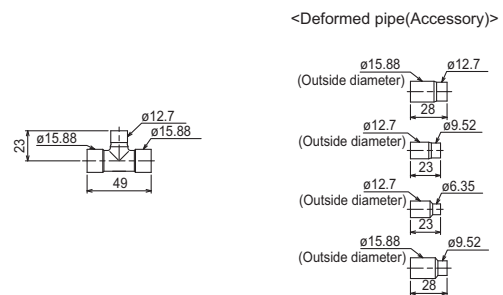

*Pipe diameter is indicated by inside diameter.

9-2. OUTDOOR TWINNING KIT

The following optional Outdoor Twinning Kit is needed to use to combine multiple refrigerant pipes. Refer to the chapter entitled System Design Section for the details of selecting a proper twinning kit.

CMY-ER100VBK-A Low-pressure pipe twinning kit

<Accessory> Fixing screw1
Pipe cover1
Cable tie2
Insulation cover1
Buffer1

<Elbow pipe(Accessory)>

[High-pressure twinning pipe]

<Pipe for routing through the bottom (Accessory)>

<Pipe for routing through the front (Accessory)>

Note 1: Refer to the figure below for the installation position of the twinning pipe.

Slope of the twinning pipe is at an angle within ±15° to the horizontal plane.

2: Pipe diameter is indicated by inside diameter.

CMY-ER200VBK Low-pressure pipe twinning kit

<Accessory> Fixing screw1
Pipe cover1
Cable tie2
Insulation cover1

<Elbow pipe(Accessory)>

<Deformed pipe(Accessory)>

[High-pressure twinning pipe]

<Pipe for routing through the bottom (Accessory)>

<Pipe for routing through the front (Accessory)>

Note 1: Refer to the figure below for the installation position of the twinning pipe.

Slope of the twinning pipe is at an angle within ±15° to the horizontal plane.

2: Pipe diameter is indicated by inside diameter.

Note 1. Refer to the figure below for the installation position of the twinning pipe.

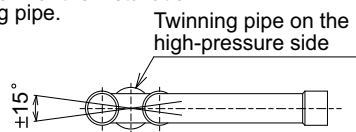

Slope of the twinning pipe is at an angle within ±15° to the horizontal plane.

2. Use the attached pipe to braze the port-opening of the distributor.
3. Pipe diameter is indicated by inside diameter.
4. Only use the Twinning pipe by Mitsubishi (optional parts) .

9-3. JOINT KIT CMY-R160-J1 FOR BC CONTROLLER

Joint kit "CMY-R160-J1" for BC controller is used to combine 2 ports of the BC controller at a PURY-(E)P-Y(S)LM-A(1) system so as to enable down-stream Indoor capacity above P80 as shown in Fig. 1.

The Joint kit include following items:

① Instruction	② Joint pipe(Small)	③ Joint pipe(Large)	④ Cover 1	⑤ Cover 2	⑥ Cover 3	⑦ Band	⑧ Reducer 1	⑨ Reducer 2
This sheet 1pc	1pc	1pc	2pcs	1pc for gas side	1pc for liquid side	8pcs	OD19.05-ID22.2 1pc	OD19.05-ID15.88 1pc

Please prepare the following items in the field. ① Tape for insulation material sealing ② Extension pipe for refrigerant circuit

② Joint pipe (for liquid side)

③ Joint pipe (for gas side)

mm(in.)

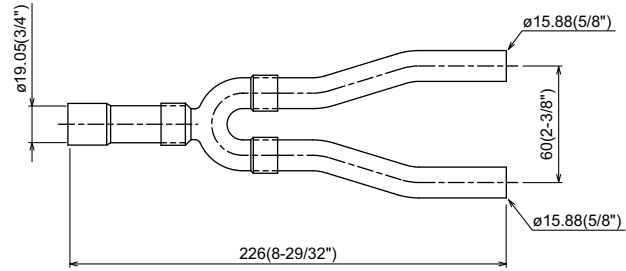
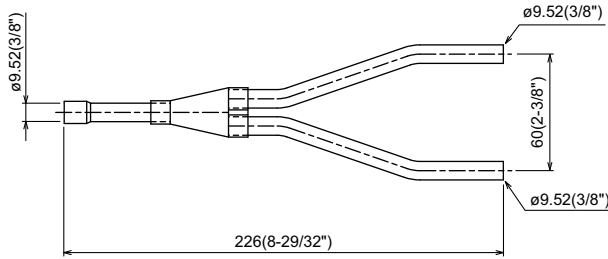

1. Designing CMY-R160-J1 to a PURY-(E)P-Y(S)LM-A(1) system

The maximum down-stream Indoor capacity for 1 port of BC controller is P80. When the down-stream Indoor capacity is above P80, Joint kit CMY-R160-J1 is needed to combined 2 ports of BC controller to enlarge the capacity, like Group 2 and 3 in Fig. 1.

Maximum 3 Indoor units are allowed to connect to 1 port of BC controller or 2 combined ports of BC controller using CMY-R160-J1.

When connecting Indoor units to 1 port of BC controller or 2 combined ports of BC controller using CMY-R160-J1 or CMY-Y102SS-G2 is applicable, like Group 1 and 2 in Fig. 1

Caution: Mixed cooling and heating mode at the same time for Indoor units connecting to 1 port or 2 combined ports is not available.

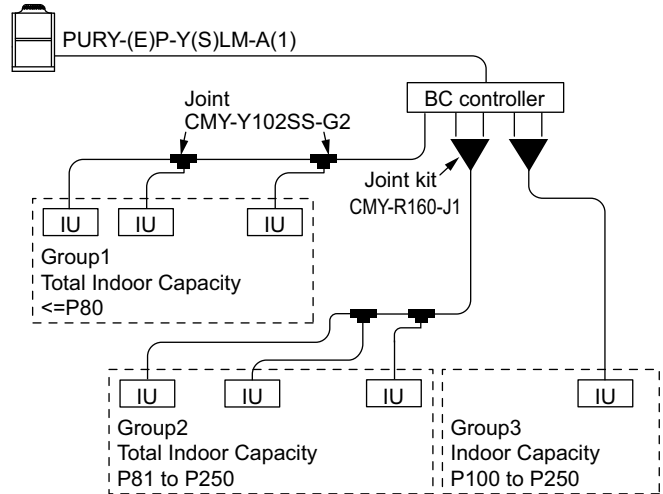

Fig.1. CMY-R160-J1 applying scheme

2. Piping at the installation site

The connection of CMY-R160-J1 to BC controller and pipe leading to Indoor units is referable to Fig. 2. Non-oxidized brazing is necessary. All piping must be careful to avoid foreign material getting inside.

After piping and air-tight testing, insulation work to the Joint and pipe should be done. Details is available at the Installation Manual.

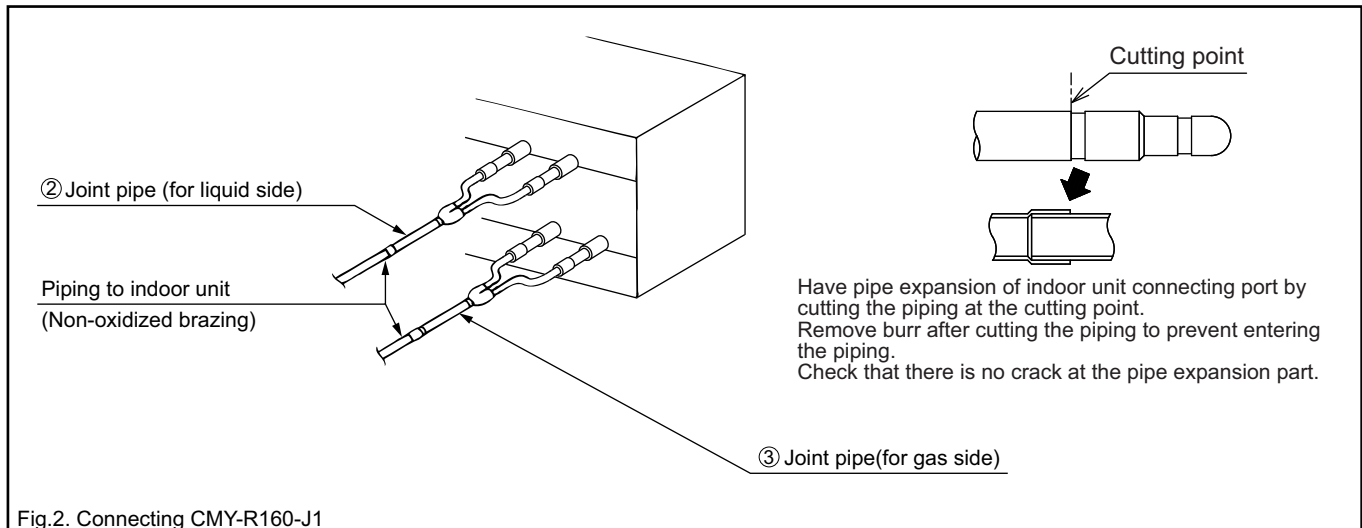
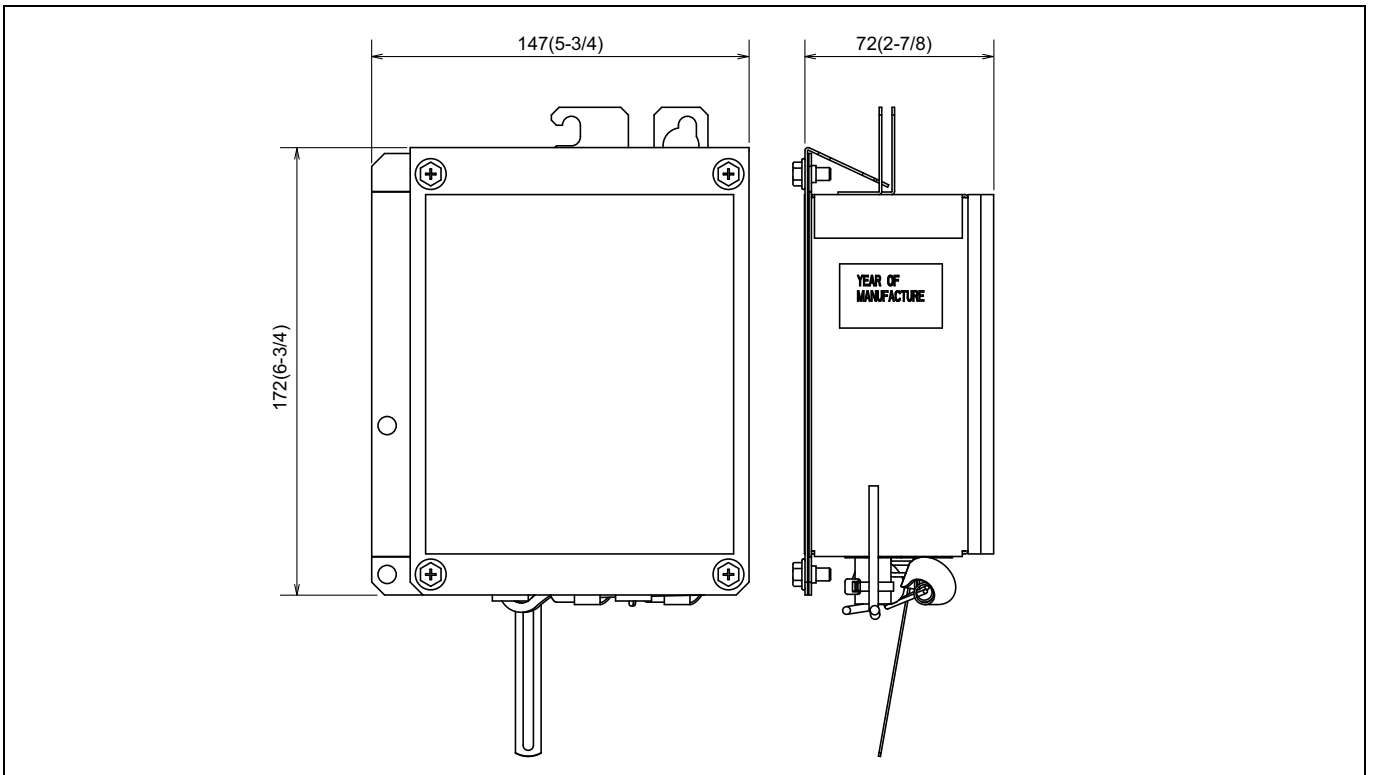

Fig.2. Connecting CMY-R160-J1

9-4. RELAY BOX

If there is a risk that the drain water will freeze inside the outdoor unit, the installation of a base heater is recommended. PAC-BH02KTY-E is a relay box for controlling the electric base heater. For details, refer to the relay box Installation Manual.



R2 (HIGH COP)

9-5. BASE HEATER

If there is a risk that the drain water will freeze inside the outdoor unit, the installation of a base heater is recommended. For details, refer to the base heater Installation Manual.

R2 (HIGH COP)

PAC-BH04EHT-E (for S module)

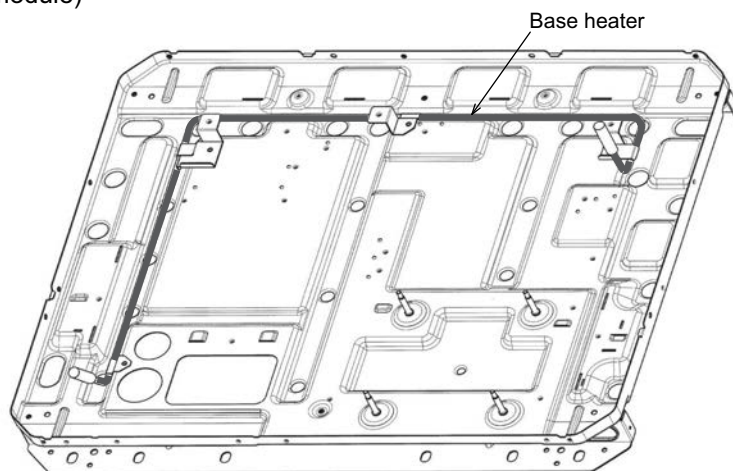

PAC-BH05EHT-E (for L module)

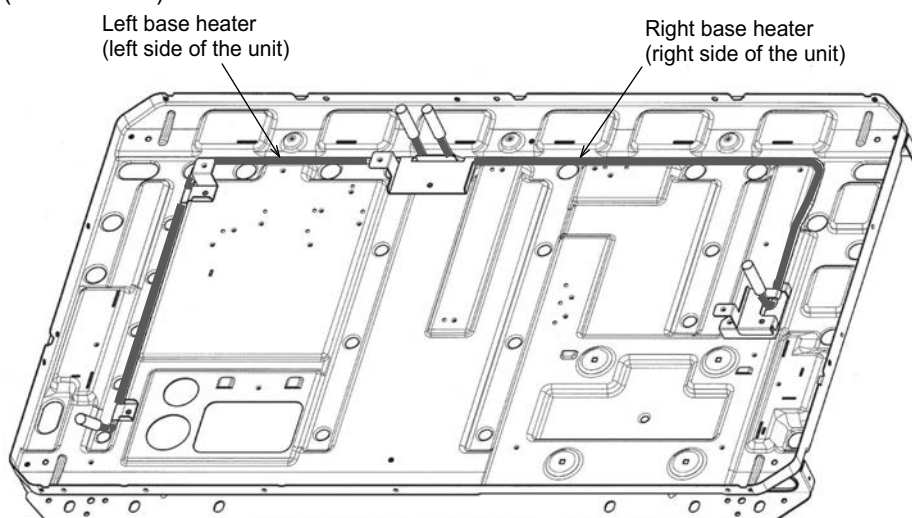

PAC-BH06EHT-E (for XL module)

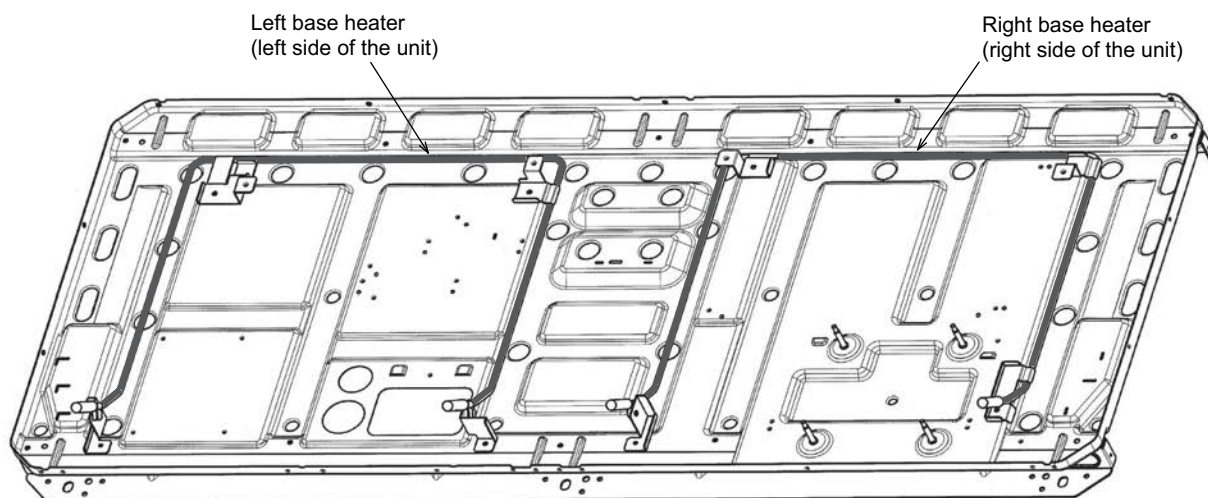

CITY MULTI

3. CONTROLLER

1. Air-conditioner Network System (MELANS)	3 - 2
1-1.Function table of controllers	3 - 3
2. Local remote controller	3 - 4
2-1.MA remote controller [PAR-31MAA].....	3 - 4
2-2.Smart ME Controller [PAR-U02MEDA]	3 - 5
2-3.Simple MA remote controller [PAC-YT52CRA]	3 - 6
2-4.Wireless remote controller [PAR-FL32MA/PAR-FA32MA/PAR-SA9FA/PAR-SL94B-E]	3 - 7
2-5.LOSSNAY remote controller for LGH-RVX-E [PZ-61DR-E]	3 - 8
2-6.LOSSNAY remote controller for LGH-RVX-E [PZ-43SMF-E].....	3 - 9
3. System remote controller.....	3 - 10
3-1.ON/OFF remote controller [PAC-YT40ANRA].....	3 - 10
3-2.Advanced touch controller [AT-50B].....	3 - 12
3-3.Centralized controller [AE-200E/AE-50E].....	3 - 20
3-4.Centralized controller [AG-150A].....	3 - 32
3-5.Centralized controller [EB-50GU-J]	3 - 41
3-6.Centralized controller [GB-50ADA-J].....	3 - 49
3-7.Power supply unit [PAC-SC51KUA]	3 - 56
3-8.Expansion Controller [PAC-YG50ECA]	3 - 58
3-9.Integrated centralized control software [TG-2000A]	3 - 61
3-10.Electric amount count software [PAC-YG11CDA]	3 - 66
3-11.PLC software for general equipment [PAC-YG21CDA].....	3 - 67
3-12.BACnet [®] interface [BAC-HD150]	3 - 68
3-13.PLC software for demand input [PAC-YG41CDA].....	3 - 70
3-14.LONWORKS [®] interface [LMAP04-E].....	3 - 72
3-15.Transmission booster [PAC-SF46EPA].....	3 - 75
3-16.AHC ADAPTER [PAC-IF01AHC-J].....	3 - 76
3-17.PI controller [PAC-YG60MCA].....	3 - 81
3-18.DIDO controller [PAC-YG66DCA]	3 - 87
3-19.AI controller [PAC-YG63MCA].....	3 - 97
4. System component	3 - 106
4-1.Y, R2 series.....	3 - 106
4-2.Outdoor unit input/output connector	3 - 108
4-3.Indoor unit "E" type input/output connector	3 - 109

System Controller

MITSUBISHI ELECTRIC's Air-conditioner Network System (MELANS) leads air conditioner management a PC browser and Network era.

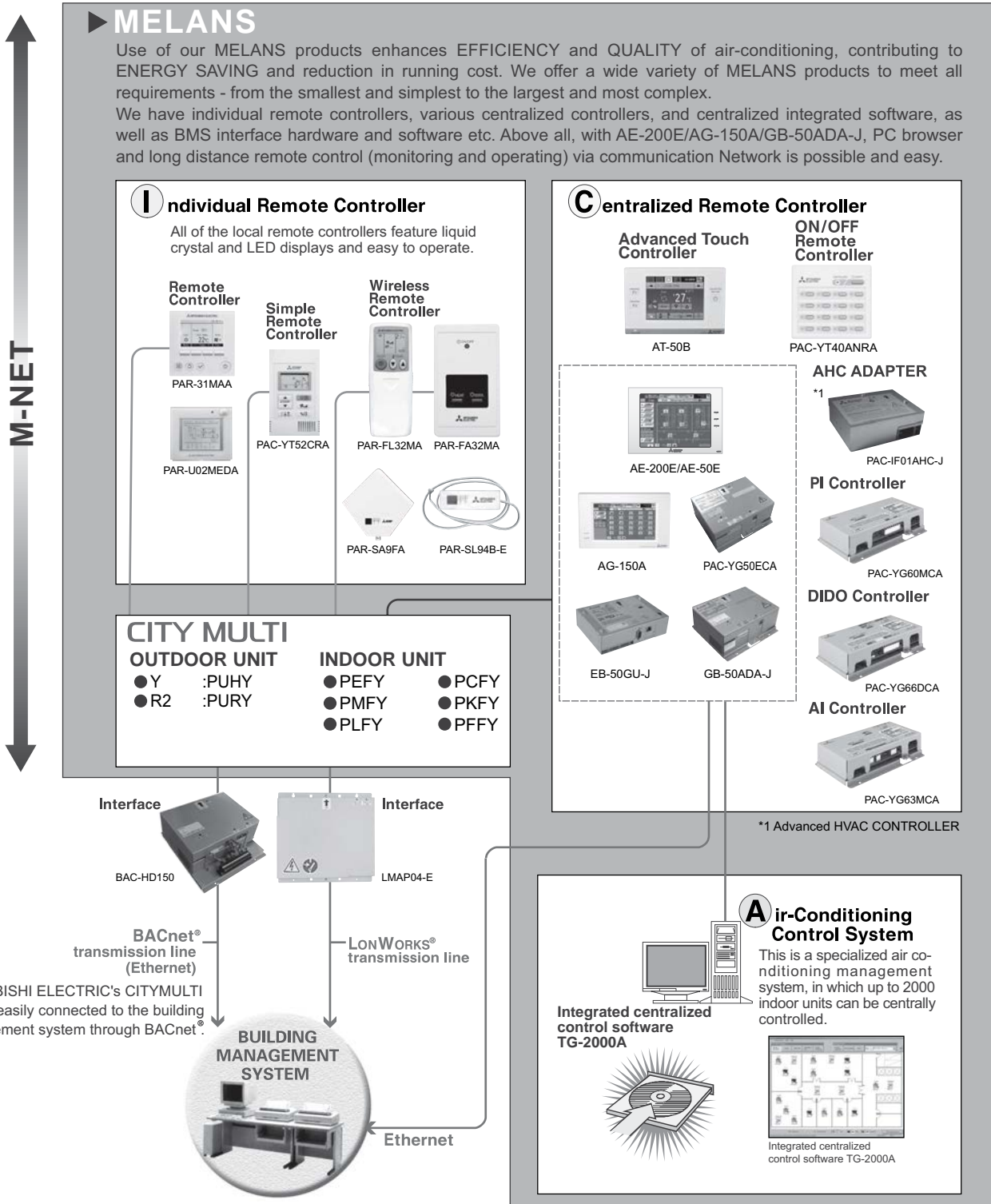

*Some controllers cannot be used in combination with certain models of devices.

1-1. Function table of controllers

Model	Local remote controller *10							System controller *10											
	PAR-31MAA	PAR-U02MEDA	PAC-YT52CRA	PAR-FL32MA	PAC-YT40ANRA	AT-50B	AE-200E	AE-200E + AE-50E	AG-150A	AG-150A + PAC-YG50ECA	EB-50GU-J	GB-50ADA-J	TG-2000A *4*5						
Controllable Groups / Indoors (Group / Indoor) *9	1 / 16	1 / 16	1 / 16	1 / 16	16 / 50	50 / 50	50 / 50	200 / 200	50 / 50	150 / 150	50 / 50	50 / 50	2000 / 2000						
■Operating																			
ON / OFF	○	○	○	○	◎	◎	◎	◎	◎	◎	◎	◎	◎						
Mode (cool / heat / dry / fan)	○	○	○	○	N	◎	◎	◎	◎	◎	◎	◎	◎						
Temperature-set	○	○	○	○	N	◎	◎	◎	◎	◎	◎	◎	◎						
Dual set point *11	○	○	○	N	○	◎	◎	◎	◎	◎	◎	◎	◎						
Local Permit / Prohibit	N	N	N	N	N	◎	◎	◎	◎	◎	◎	◎	◎						
Fan speed	○	○	○	○	N	◎	◎	◎	◎	◎	◎	◎	◎						
Air-flow direction	○	○	○	○	N	◎	◎	◎	◎	◎	◎	◎	◎						
■Status monitoring																			
ON / OFF	○	○	○	○	◎	◎	◎	◎	◎	◎	◎	◎	◎						
Mode (cool / heat / dry / fan)	○	○	○	○	N	○	○	○	○	○	○	○	○						
Temperature-set	○	○	○	○	N	○	○	○	○	○	○	○	○						
Local Permit / Prohibit	○	○	○	○	○	○	○	○	○	○	○	○	○						
Fan speed	○	○	○	○	N	○	○	○	○	○	○	○	○						
Air-flow direction	○	○	○	○	N	○	○	○	○	○	○	○	○						
Indoor temperature	○	○	○	N	N	○	○	○	○	○	○	○	○						
Filter sign	○	○	N	N	N	◎	◎	◎	◎	◎	◎	◎	◎						
Error flashing	○	○	○	○	◎	◎	◎	◎	◎	◎	◎	◎	◎						
Error code	○	○	○	N	○	○	○	○	○	○	○	○	○						
Operation hour	N	N	N	N	N	N	N	N	N	N	N	N	N						
■Scheduling																			
One-day	○	○	N	N	N	○	◎	◎	◎	◎	◎	◎	◎						
Times of ON / OFF per day	1	1	N	1	N	16	24	24	24	24	24	24	24						
Weekly	○	○	N	N	N	○	◎	◎	◎	◎	◎	◎	◎						
Times of ON / OFF per week	8 x 7	8 x 7	N	N	N	16 x 7	24 x 7	24 x 7	24 x 7	24 x 7	24 x 7	24 x 7	24 x 7						
Annual	N	N	N	N	N	N	◎	◎	◎	◎	◎	◎	◎						
Optimized start-up	N	N	N	N	N	N	○	○	○	○	○	○	○						
Auto-off timer	○	○	N	N	N	N	N	N	N	N	N	N	N						
Min. timer setting unit (minute)	5	5	N	10	N	5	1	1	1	1	1	1	1						
■Recording																			
Error record	○	N	N	N	N	○	○	○	○	○	○	○	○						
Daily / monthly report	N	N	N	N	N	N	N	N	N	N	N	N	N						
Electricity charge	N	N	N	N	N	N	N	N	N	N	N	N	N						
Energy management data	N	N	N	N	N	N	●	●	●	●	●	●	●						
■Other																			
Temp-set limitation by Local R / C	○	○	○	N	N	N	N	N	N	N	N	N	N						
Temp-set limitation by System controller *4	○*6	○	○*6	N	N	○*6	N	○*2*6	N	○*2*6	N	○*2*6	◎*6						
Operation-lock	○	○	○	N	N	◎	N	N	N	N	N	N	N						
Night setback	○	○	N	N	N	◎	○	○*2	○	○*2	○	○*2	○						
Sliding temperature control	N	N	N	N	N	○	○*2	○	○*2	○	○*2	○	○*2						
■Management (Group / Interlocked)																			
Ventilation interlock	N / ○	N / ○	N / ○	N	○	○	○ / ○ ²	○	○ / ○ ²	○	○ / ○ ²	○	○ / ○						
Group setting	○*1	○	○*1	N	○	○	○ / ○ ²	○	○ / ○ ²	○	○ / ○ ²	○	○						
Block setting	N	N	N	N	N	N	○*2	○	○*2	○	○*2	○	○						
Revision of electricity charge	N	N	N	N	N	N	N	N	N	N	N	N	□●						
■Operating on LOSSNAY interlocked (Group / Interlocked)																			
ON / OFF	N / ○	N / ○	N / ○	N / ○ ⁸	◎ / ◎ ³	◎ / ◎	◎ / ◎	◎ / ◎	◎ / ◎	◎ / ◎	◎ / ◎	◎ / ◎	◎ / ◎						
Fan speed	N / ○	N / ○	N	N	N	◎ / ◎	◎ / ◎	◎ / ◎	◎ / ◎	◎ / ◎	◎ / ◎	◎ / ◎	◎ / ◎						
Ventilation mode	N / N	N	N	N	N	◎ / N	◎ / N	◎ / N	◎ / N	◎ / N	◎ / N	◎ / N	◎ / N						
■Status monitoring on LOSSNAY interlocked (Group / Interlocked)																			
ON / OFF	N / ○	N / ○	N / ○	N	N	○ / ○	◎ / ◎	◎ / ◎	◎ / ◎	◎ / ◎	◎ / ◎	◎ / ◎	◎ / ◎						
Fan speed	N / ○	N / ○	N	N	N	○ / ○	◎ / ◎	◎ / ◎	◎ / ◎	◎ / ◎	◎ / ◎	◎ / ◎	◎ / ◎						
Ventilation mode	N	N	N	N	N	○ / N	◎ / N	◎ / N	◎ / N	◎ / N	◎ / N	◎ / N	◎ / N						

◎: Each group / Batched ; ○: Each group ; □: Block (for CITY MULTI Indoor unit, not for all Mr.SLIM) ; ●: AE-200E/AE-50E/AG-150A/GB-50ADA-J/EB-50GU-J license registration possible.
 (●): License registration for the optional functions required N : Not Available (Not Used.) △: Batched only ; ▲: Batched handling (for maintenance) ■: Block

*1. Group setting via wiring between Indoor units with cross-over cable;
 *2. Installation possible at Initial setting web browser;
 *3. Inter-lock is set at Local remote controller.
 *4. AE-200E/AE-50E/AG-150A/EB-50GU-J/GB-50ADA-J license registration to AE-200E/AE-50E/AG-150A/EB-50GU-J/GB-50ADA-J is required to monitor and operate the units by browser and TG-2000A.
 5. AG-150A connected with PAC-YG50ECA is compatible with TG-2000A Ver.6.10 or later. GB-50ADA-J is compatible with TG-2000A Ver. 6.30* or later. EB-50GU-J is compatible with TG-2000A Ver. 6.40A or later. AE-200E/AE-50E is compatible with TG-2000A Ver. 6.50* or later.
 *6. This function can be set only on the ME remote controller. This function cannot be used with the MA/Simple MA remote controller.
 (But, the validity of this function with the MA/Simple MA remote controller depends on the indoor unit model, and there are possibilities that this function can be used with them.)
 *7. This function is available only when applying together with TG-2000A, AE-200E, AE-50E, AG-150A, GB-50ADA-J, and EB-50GU-J.
 *8. Inter-lock is set from system controllers (Except PAC-YT40ANRA) or local remote controllers.
 *9. The maximum number of controllable units decreases depending on the indoor unit model.
 *10. For indoor use only.
 *11. This function is supported only when all the indoor units, remote controllers, and system controllers that are connected to a given group features the function.
 *12. For the availability of the function, please contact your local distributor.

LOSSNAY remote controller PZ-52SF	
■Controllable LOSSNAY Groups	1
■Controllable LOSSNAY unit	16
■Operating	
ON/OFF	○
Mode (automatic ventilation/vent-heat interchange/normal ventilation)	○
Local Permit-Prohibit	N
Fan speed	○
Air flow direction	N
■Scheduling	N
■Recording	N

■Management	
Group setting	○
Block setting	N
■Status monitoring	
ON/OFF	○
Mode (automatic ventilation/vent-heat interchange/normal ventilation)	○
Local Permit-Prohibit	○
Fan speed	○
Air flow direction	N
Filter sign	○
Error flashing	○
Error code	○

Air conditioner control system interface
LMAP04-E: LONWorks® Interface
 Controls up to 50 Groups/ 50 units, for details, refer to its description.
BAC-HD150: BACnet® Interface
 Controls up to 50 Groups/ 50 units, up to 150 Groups/ 150 units with three expansion controllers for details, refer to its description.

○ : Each group, N: Not Available

2-1. MA remote controller [PAR-31MAA]



Dual Set Point

■ Functions

1. Operation/Display

○:Each group X:Not available

Item	Description	Setting	Display
ON/OFF	Switches between ON and OFF.	○	○
Operation mode switching	Switches among Cool/Dry/Fan/Auto/Heat.	○	○
Room temp. setting *3	The temperature can be set within the following range. Cool/Dry : 19°C - 30°C (14°C - 30°C) / 67°F - 87°F (57°F - 87°F) Heat : 17°C - 28°C (17°C - 28°C) / 63°F - 83°F (63°F - 83°F) Auto : 19°C - 28°C (17°C - 28°C) / 67°F - 83°F (63°F - 83°F) () For PEFY/PPFY by setting DipSW 7-1 to ON and limits to N16H fan speed only. * Range of temperature settings vary depending on model.	○	○
Fan speed setting	Changes fan speed. * Available fan speeds vary depending on the model.	○	○
Air flow direction setting	Changes airflow direction. * Available airflow directions vary depending on the model.	○	○
Louver setting	Switches between louver ON/OFF.	○	○
Ventilation equipment control	Interlocked setting and interlocked operation setting with the City Multi LOSSNAY units can be made. The Stop/Low/High settings of the ventilation equipment can be controlled.	○	○
Auto descending panel *1	Raises and lowers the automatic elevating panel.	○	○
backlight	Pressing any button turns the backlight on and it will stay lit for a certain period of time depending on the screen.	X	○
Main display mode setting	The Main display can be displayed in two different modes: "Full" and "Basic."	○	○
Clock *2	Date (year/month/day) and time (hour/minute) can be set. The set time as well as the day of the week will be displayed on the Main display. It is also possible to set not to display the time on the Main display.	○	○
Clock display	The clock can be displayed in 12-hour format (AM/PM before or after the time) and 24-hour format.	○	○
Room temp. display *3	Displays the room temperature on the Main display in the "Full" mode during operation.	-	○
Error information	When an error occurs, an error code and the unit address appear. Air conditioning unit model, serial number, and contact number can be set to appear when an error occurs. (The information above needs to be entered in advance.) * An error code may not appear depending on the error.	-	○
Filter information	A filter sign will appear when it is time to clean the filter.	-	○

● Backlit LCD

● Can be set and shown by 0.5°C degree.

■ External dimension

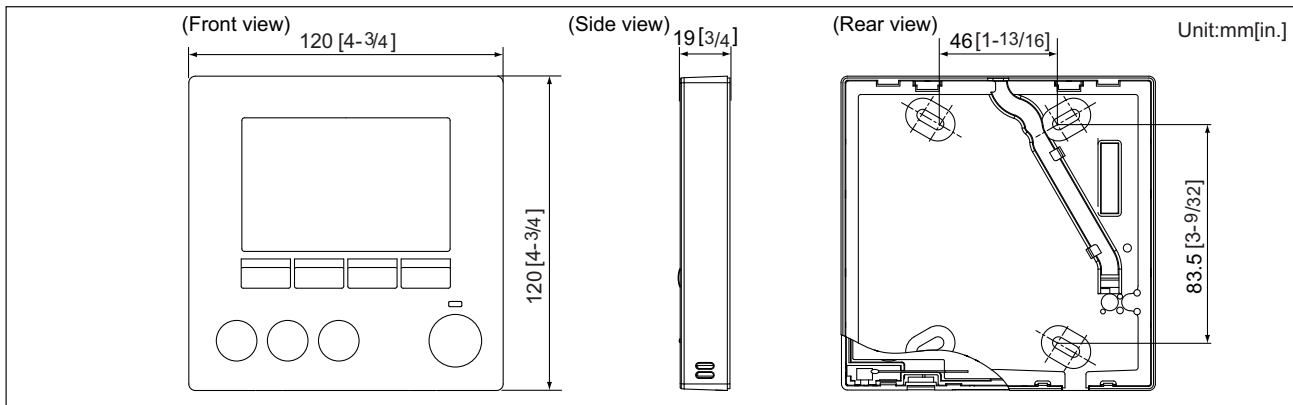

2. Schedule and timer setting

○:Each group X:Not available

Item	Description	Setting	Display
Timer	ON/OFF timer Turns ON and OFF daily at a set time. • Time can be set in 5-minute increments. • It is also possible to set the ON time only or the OFF time only. Auto-OFF timer Turns off the unit after a certain period of operation. • Operation time can be set to a value from 30 to 240 minutes in 10-minute increments.	○	○
Weekly timer	Weekly ON/OFF times and set temperatures can be set. • Time can be set in 5-minute increments. Up to 8 schedule patterns can be set per day of the week. * Not valid when the ON/OFF timer is set.	○	○
Night setback	The temperature range and the start/stop times can be set.	○	○

3. Restriction settings

○:Each group X:Not available

Item	Description	Setting	Display
Allows/disallows local operation	The following operation can be prohibited by making certain settings on the centralized controller: ON/OFF, operation mode setting, temperature setting, and filter sign reset. * While an operation is prohibited, the operation icon lights up (only on the Main display in the "Full" mode).	X	○
Operation lock	The following operation can be prohibited respectively: ON/OFF, operation mode setting, temperature setting, and airflow direction setting.	○	○
Temperature range restriction	The room temperature range for each operation mode can be restricted.	○	○
Auto return	The units operate at the preset temperature after a designated period. (Time can be set to a value from 30 to 120 in 10-minute increments.) * Not valid when the temperature setting range is restricted.	○	X
password	Administrator password (required for schedule setting etc.) and Maintenance password (required for test run and function setting etc.) can be set.	○	X

4. Miscellaneous items

○:Each group X:Not available

Item	Description	Setting	Display
Language Selection	Select the display language from the following 8 languages. English, French, German, Spanish, Italian, Portuguese, Swedish, and Russian	○	○
Contrast	Adjusts LCD contrast.	○	○
Manual vane Angle *1	Fixes the vane position for each air outlet.	○	X
Service *1	Contains Test run, Function setting, Refrigerant volume check, Refrigerant leak check, Smooth maintenance, Request code, and Error history.	○	○

*1 This function is active only for the units that support the function.

*2 The clock is accurate within 50 seconds per month (at the temperature of 25°C [77°F]). The clock is backed up for 7 days.

*3 Temperature will be displayed either in Centigrade in 0.5- or 1-degree increments, or in Fahrenheit, depending on the indoor unit model and the display mode setting on the remote controller.

■ System example

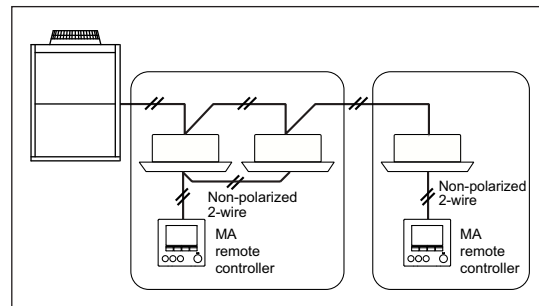

*When a PAR-31MAA is connected to a group, no other MA remote controllers can be connected to the same group.

2-2. Smart ME Controller [PAR-U02MEDA]

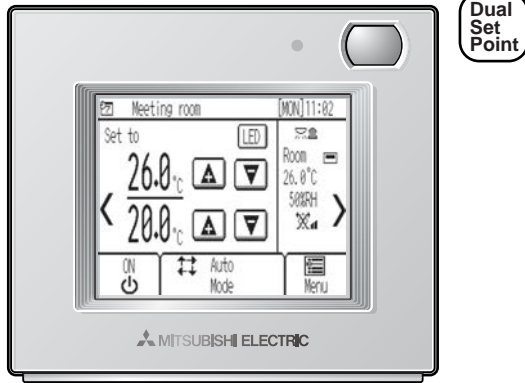

- Smart ME Controller is a remote controller designed to control Mitsubishi Electric's air conditioning units and also allows for the control of other manufacturer's products connected via Mitsubishi Electric's AHC (Advanced HVAC CONTROLLER).
- It can control up to sixteen indoor units and one AHC.
- Smart ME Controller features such basic functions as operations and monitoring of air conditioning units and schedule-control functions and is equipped with four built-in sensors (temperature, humidity, occupancy, brightness), which enable an integrated control of the system, including the humidifiers and ventilation units connected to the system via AHC, to help create a comfortable environment. When the built-in occupancy sensor detects vacancy in a specific zone, the controller uses its internal function to reduce energy-consumption.

■ Functions

1. Operation/Display

○:Each group X:Not available

Item	Description	Setting	Display
ON/OFF	Switches between ON and OFF.	○	○
Operation mode switching	Switches among Cool/Dry/Fan/Auto/Heat. *Available operation mode varies depending on the model.	○	○
Room temp. setting	The temperature can be set within the following range. Cool/Dry: 19°C - 35°C/67°F - 95°F Heat: 4.5°C - 28°C/40°F - 83°F Auto (single set point): 19°C - 28°C/67°F - 83°F Auto (dual set points) [Cool] Same as the set temp. range for Cool mode. [Heat] Same as the set temp. range for Heat mode. * Set temperature range varies depending on the model.	○	○
Fan speed setting	Changes fan speed. * Available fan speeds vary depending on the model.	○	○
Air flow direction setting	Changes airflow direction. * Available airflow directions vary depending on the model.	○	○
Louver setting	Switches between louver ON/OFF. * Available Louver setting vary depending on the model.	○	○
Ventilation equipment control	Interlocked setting and interlocked operation setting with the City Multi LOSSNAY units can be made. The Stop/Low/High settings of the ventilation equipment can be controlled.	○	○
Backlight	Touching the screen turns the backlight on. It will stay lit for the amount of time that was specified on the MENU screen.	○	○
Clock display	Date (year/month/day) and time (hour/minute) can be set. The set time as well as the day of the week will be displayed on the Home display. The clock can be displayed in 12-hour format (AM/PM before or after the time) and 24-hour format.	○	○
Daylight saving	Sets the daylight saving time period.	○	○
Room temp. / humidity display	Displays the room temperature and humidity on the Home display.	—	○
Error information	When an error occurs, an error code and the unit address appear. Contact number can be set to appear when an error occurs. (The information above needs to be entered on the Service menu.)	—	○
Filter information	A filter sign will appear when it is time to clean the filter.	—	○

2. Schedule and timer setting

○:Each group X:Not available

Item	Description	Setting	Display
Schedule (Weekly timer)	Weekly ON/OFF times, operation mode, and set temperatures can be set. • Time can be set in 5-minute increments. Up to 8 schedule patterns can be set per day of the week. * Not valid when the ON/OFF timer is set.	○	○
Timer	ON/OFF timer Turns ON and OFF daily at a set time. • Time can be set in 5-minute increments. • It is also possible to set the ON time only or the OFF time only. Auto-OFF timer Turns off the unit after a certain period of operation. • Operation time can be set to a value from 30 to 240 in 10-minute increments.	○	○
Night setback	The temperature range and the start/stop times can be set.	○	○

3. Energy-save control assist function

○:Each group X:Not available

Item	Description	Setting	Display
Energy-save control during vacancy	When vacancy is detected by the occupancy sensor, the energy-save control assist function is activated. Four control types are available for selection: ON/OFF/Set temperature/Fan speed/Thermo-off. The brightness sensor can be used in conjunction with the occupancy sensor to detect the occupancy/vacancy status more accurately.	○	○

4. Restriction settings

○:Each group X:Not available

Item	Description	Setting	Display
Allows/disallows local operation	The following operation can be prohibited by making certain settings on the centralized controller: ON/OFF, operation mode setting, temperature setting, fan speed, air direction, and filter sign reset. * While an operation is prohibited, the operation icon lights up.	X	○
Operation lock	The following operation can be prohibited respectively: ON/OFF, operation mode setting, temperature setting, and airflow direction setting.	○	○
Temperature range restriction	The room temperature range for each operation mode can be restricted.	○	○
Auto return	The units operate at the preset temperature after a designated period. (Time can be set to a value from 10 to 120 in 10-minute increments.) * Not valid when the temperature setting range is restricted.	○	X
Password	User password (required for schedule setting etc.) and Service password (required for test run and function setting etc.) can be set.	○	X

5. AHC control functions

○:Each group X:Not available

Item	Description	Setting	Display
Status monitor	Displays the status of general equipments connected to the AHC.	X	○
Humidity setting	Sets the humidity level in 1% increments for the humidifier connected to the AHC, if any.	○	○

6. Miscellaneous items

○:Each group X:Not available

Item	Description	Setting	Display
Language Selection	Select the display language from the following 8 languages. English, French, Spanish, German, Italian, Russian, Portuguese, and Swedish.	○	○
Service	Contains Set up and Test run.	○	○

■ System example

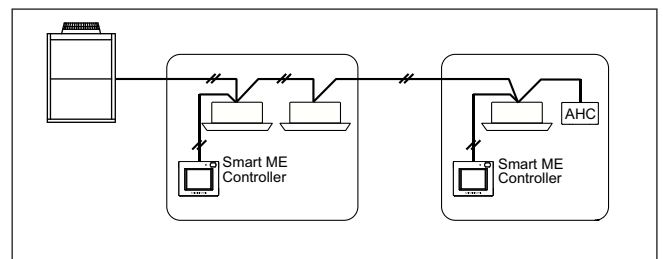

■ External dimension

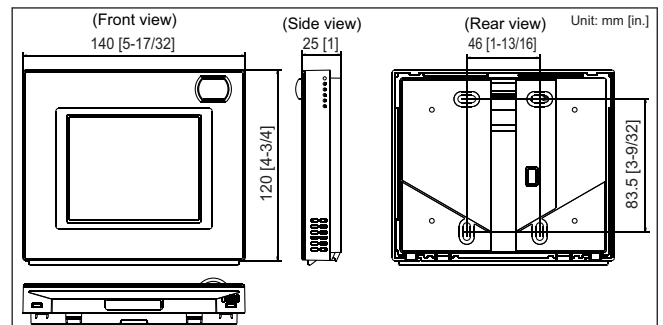

2-3. Simple MA remote controller [PAC-YT52CRA]

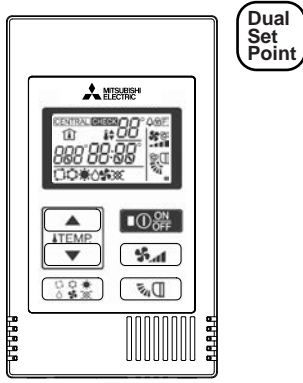

■ Functions

□ : Each unit ○ : Each group ■ : Each block
 △ : Each floor ⊙ : Collective × : Not available

Item	Description	Operations	Display
ON/OFF	Changes between ON and OFF.	○	○
Operation mode switching *1	Select from COOL, DRYING, FAN, AUTO, and HEAT.	○	○
Room temp. Setting *1	The temperature can be set within the following range. Cool/Drying: 19°C - 35°C/67°F - 95°F Heat: 5°C - 28°C/40°F - 83°F Auto (single set point): 19°C - 28°C/67°F - 83°F Auto (dual set points) [Cool] Same as the set temp. range for Cool mode. [Heat] Same as the set temp. range for Heat mode. * Set temperature range varies depending on the model.	○	○
Fan speed setting	Changes the fan speed. *The settable fan speed varies depending on the indoor unit model to be connected.	○	○
Vane setting	Switches the vane directions. *The settable vane direction varies depending on the indoor unit model to be connected.	○	○
Ventilation equipment control	When the CITY MULTI indoor unit is connected, interlocked setting of the CITY MULTI LOSSNAY unit is possible. When the Mr. SLIM indoor unit (A-control) is connected, interlocked operation of the microcomputer-type LOSSNAY unit is possible.	○	○
Backlight	Pressing the button lights up a backlight. The light automatically turns off after a certain period of time. (The brightness settings can be selected from Bright, Dark, and Light off.)	○	○
Error information	Displays the current error status with the address. *The address may not be displayed depending on the error status.	—	○
Allows/disallows local operation	By setting a centralized controller, the following local operations are prohibited: ON/OFF; operation mode; preset temperature; *The CENTRAL icon appears while the local operations are prohibited.	×	○
Operation lock	Locks all buttons.	○	○
Temperature range restriction	The preset temperature range can be restricted for each operation mode (COOL/HEAT/AUTO).	○	○
Room temperature detection	The temperature sensor is built-in on the remote controller.	—	—
Various settings	The following settings can be made by setting the dip switches. • Remote controller Main/Sub setting • Temperature display unit setting (Celsius/Fahrenheit) • Cooling/heating display in AUTO mode • Indoor temperature display	—	—

- Control: ON/OFF, room temperature, vane, fan speed, and operation mode
- The only wiring required is cross-over wiring based on two-wire signal lines.
- Room temperature sensors are built-in.
- Set temperature range limit
- Can operate all types of indoor units
- * : Since this controller has limited functions, it should always be used in conjunction with standard controller or centralized controller.
- Backlit LCD
- Flat back

■ System example

*1 AUTO mode is settable only when those functions are available on the indoor unit.

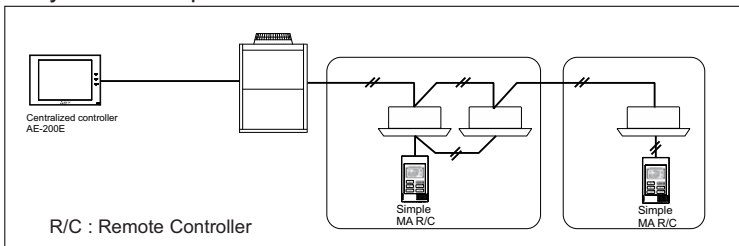

■ External dimension

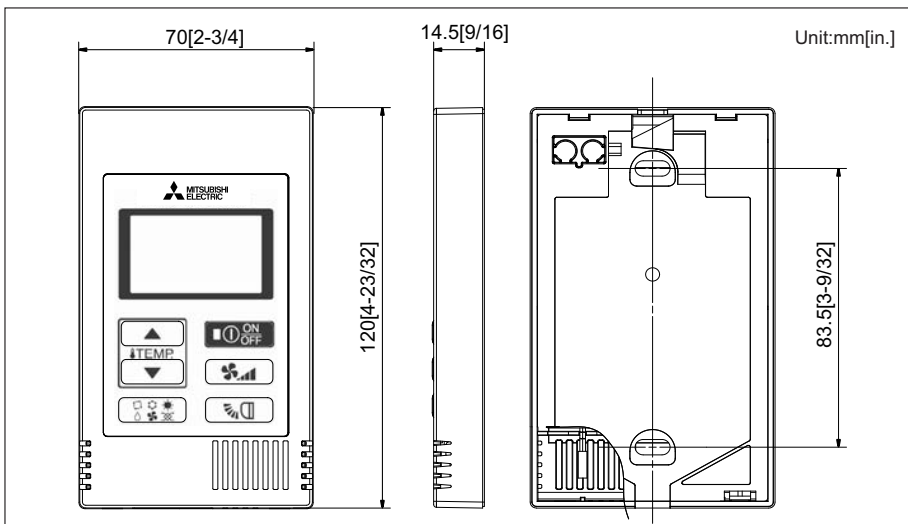

2-4. Wireless remote controller[PAR-FL32MA/PAR-FA32MA/PAR-SA9FA/PAR-SL94B-E]

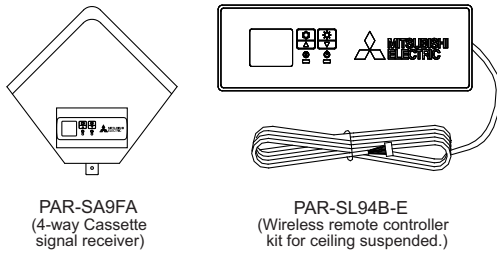
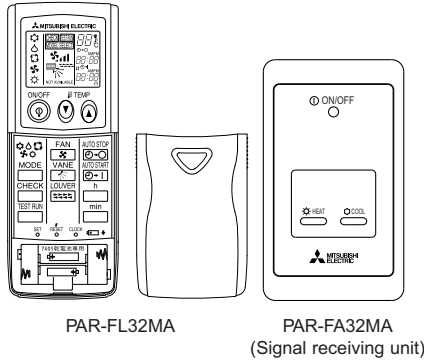

- It can operate in a group system without requiring address settings.
- When operating, it displays LED lamps. When errors occur, the error code can be shown by the LED flash count.
- *: If an indoor unit with different functionality is operating inside the same group, please note there may be cases when functionality is partially disabled for batch control.
- *: Wireless remote controllers can only be used for a single refrigerant system.
- *: If you use a system controller to centrally control a group, you will need cross-wiring between indoor units when using a wireless remote controller. Also ensure there is no difference between the group setting of the main system controller and the cross wiring across indoor units when wiring and setting cross wires.

External dimension

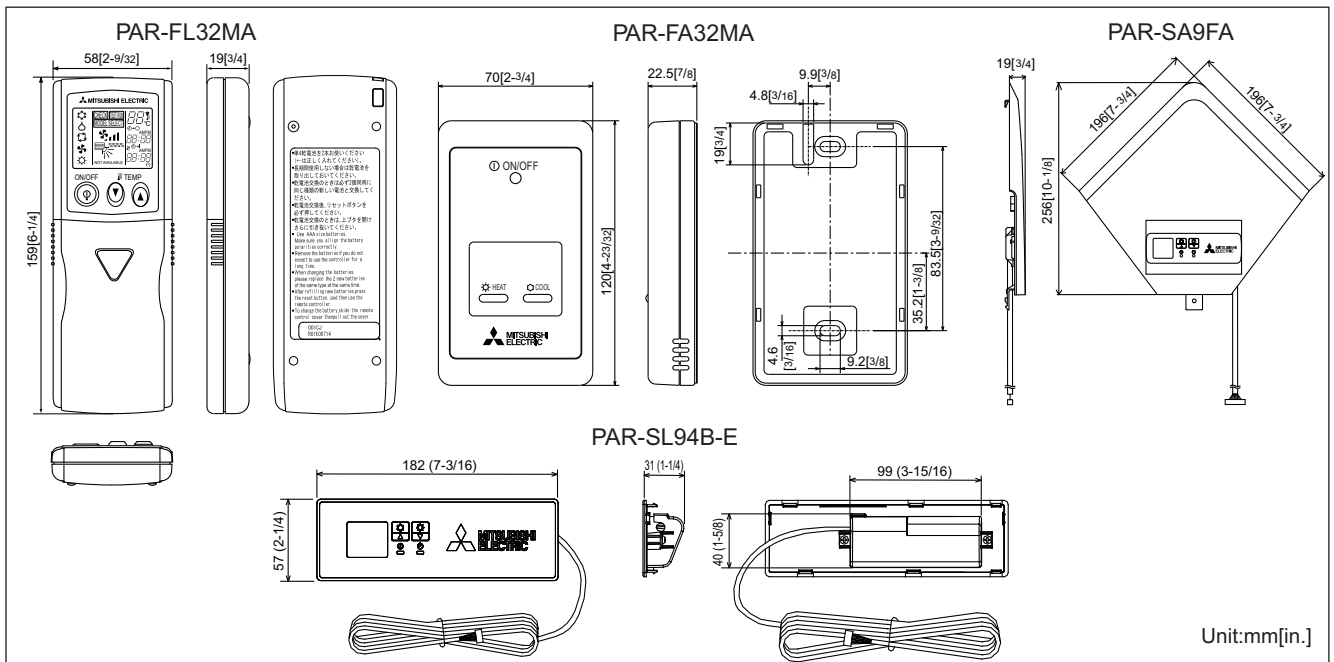

Functions

□:Each unit ○:Each group ●:Each block
△:Each floor ⊙:Collective X:Not available

Item	Description	Operations	Display
ON/OFF	ON and OFF operation for a single group	○	○
Operation mode switching	Switches between Cool / Dry / Fan / Heat / Auto.* Operation modes vary depending on the air conditioner unit. *Auto only supported for the City Multi R2 and WR2 series.	○	○
Temperature setting	Sets the temperature for a single group Range of temperature setting Cool/Dry : 19°C - 30°C (14°C - 30°C) / 67°F - 87°F (57°F - 87°F) Heat : 17°C - 28°C (17°C - 28°C) / 63°F - 83°F (63°F - 83°F) Auto : 19°C - 28°C (17°C - 28°C) / 67°F - 83°F (63°F - 83°F) () For PEFY/PFFY by setting DipSW 7-1 to ON and limits to N16H fan speed only. * Set to PAR-FL32MA according to its Installation Manual 4 "Model setting".	○	○
Fan speed setting	Models with 4 air flow speed settings: Hi/Mid-1/Mid-2/Low Models with 3 air flow speed settings: Hi/Mid/Low Models with 2 air flow speed settings: Hi/Low Auto setting varies depending on the model.	*	*
Air flow direction setting	Air flow direction angles (4-angle, Swing) Auto Louver ON/OFF. Air flow direction settings vary depending on the model.	*	*
Timer operation	One ON/OFF setting can be set for one day.	○	○
Permit / Prohibit local operation	Individually prohibit operation of each local remote control function (ON/OFF, Change operation mode, Set temperature, Reset filter). *:1: If operation is performed when the local remote controller inactivation command is received from the main system controller, a buzzer will ring and an LED will flash.	X	*1 ○
Indoor unit intake temperature	Measures the intake temperature of the indoor unit when the indoor unit is operating.	X	X
Error	When an error occurs on the air conditioner unit, the operation lamp on the signal receiving unit will flash.	X	○
Test run	This operates air conditioner units in test run mode.	○	○
Ventilation equipment	Up to 16 indoor units can be connected to an interlocked system that has one LOSSNAY.	X	X

* Some models will have different display for the air flow direction and fan speed. Set the air flow direction and fan speed when performing initial setting.

System example

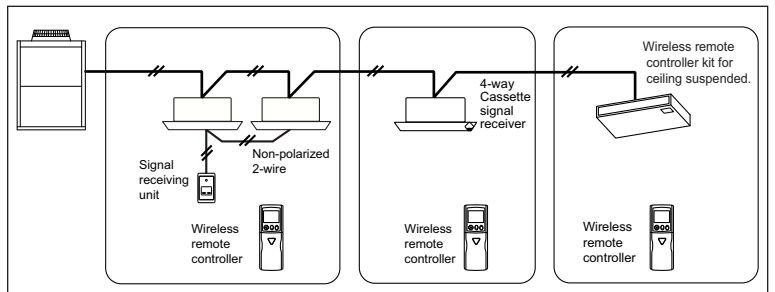

2-5. LOSSNAY remote controller for LGH-RVX-E [PZ-61DR-E]



■ Functions

Function (Communicating mode)	PZ-61DR-E
Fan speed selection	4 fan speeds
Ventilation mode selection	Energy recovery/Bypass/Auto
Night-purge (time)	Any time selectable
Night-purge (fan speed)	Selectable from 4 fan speeds
Dip-switch setting and function setting from RC	Yes
Bypass temp. free setting	Yes
Heater-On temp. free setting	Yes
Fan power up after installation	Yes
0 - 10VDC external input	Yes
ON/OFF timer	Yes
Auto-Off timer	Yes
Weekly timer	Yes
Operation restrictions (ON/OFF, Ventilation mode, fan speed)	Yes
Operation restrictions (Fan speed skip setting)	Yes
Screen contrast adjustment	Yes
Language selection	Yes (8 languages)
Initializing remote controller	Yes
Filter cleaning sign	Yes
Lossnay core cleaning sign	Yes
Error indication	Yes
Error history	Yes
OA/RA/SA temp. display	Yes

- Stand-alone LOSSNAY operation is possible by commands from a centralized controller or LOSSNAY remote controller. (AE-200E is a centralized controller that supports LOSSNAY operation.)
- The LOSSNAY remote controller is capable of changing the air flow and vent modes.
- All the wiring is cross-wiring that uses non-polar two wire system signal cables.
 - * It is possible to use a LOSSNAY remote controller for LOSSNAY unit that is interlocked with other indoor units.
 - * It is not possible to connect to LGH-RX5-E.

■ System example

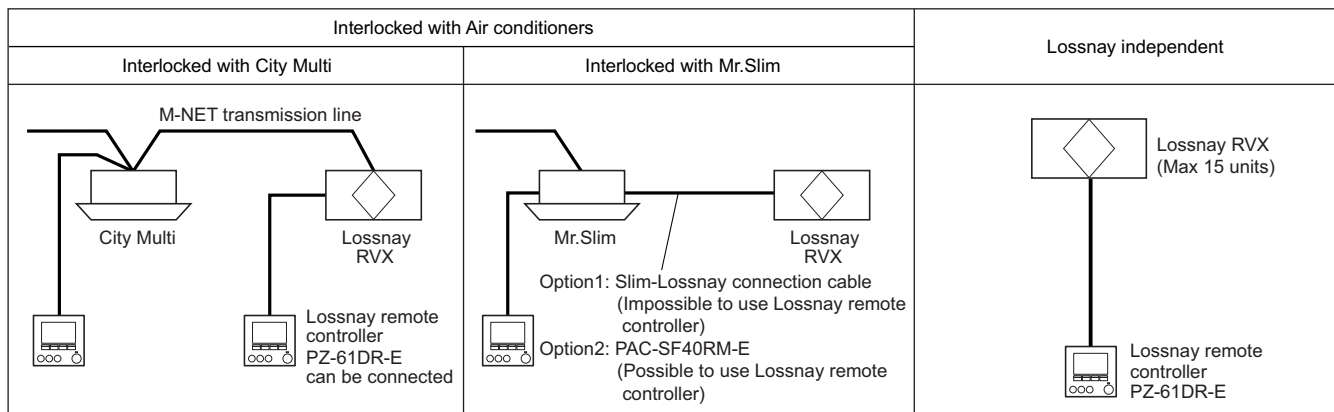

■ External dimension

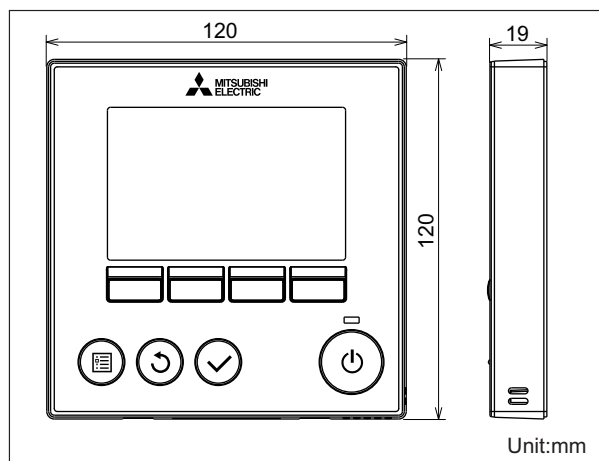

2-6. LOSSNAY remote controller for LGH-RVX-E [PZ-43SMF-E]



- Stand-alone LOSSNAY operation is possible by commands from a centralized controller or LOSSNAY remote controller. (AE-200E is a centralized controller that supports LOSSNAY operation.)
- The LOSSNAY remote controller is capable of changing the air flow and vent modes.
- All the wiring is cross-wiring that uses non-polar two wire system signal cables.

* It is possible to use a LOSSNAY remote controller for LOSSNAY unit that is interlocked with other indoor units.

■ Functions

Operation	Relevant button	Relevant display items	Sequence
Starting the Lossnay unit			Press the "ON/OFF" button and check that the operation lamp turns on.
Setting the Ventilation mode			Press the "Ventilation mode" button: Each time it is pressed, the corresponding display will change in accordance with the sequence [HEAT EX.] (non-automatic) -> [BY-PASS] (non-automatic) -> [AUTO]. If [AUTO] is selected, the display will change to indicate the current mode after three seconds have passed.
Selecting the fan speed			Press the "Fan Speed" button to select either Low or High fan speed.
Stopping the Lossnay unit			Press the "ON/OFF" button. (and check the operation lamp turns off.)
OFF timer			Press the "TIMER" button during operation. 0:30 (Initial) Increasing 0:30 by pressing it once. Available setting time: 0:30 - 24:00 * Keep pressing the button for fast-forwarding. Release the button for cancelling the fast-forwarding. Timer setting will be cancelled by pressing "ON/OFF" button.
ON timer			Press the "TIMER" button during non-operation. 5:30 (Initial) Increasing 0:30 by pressing it once. Available setting time: 0:30 - 24:00 * Keep pressing the button for fast-forwarding. Release the button for cancelling the fast-forwarding. Timer setting will be cancelled by pressing "ON/OFF" button.

■ System example

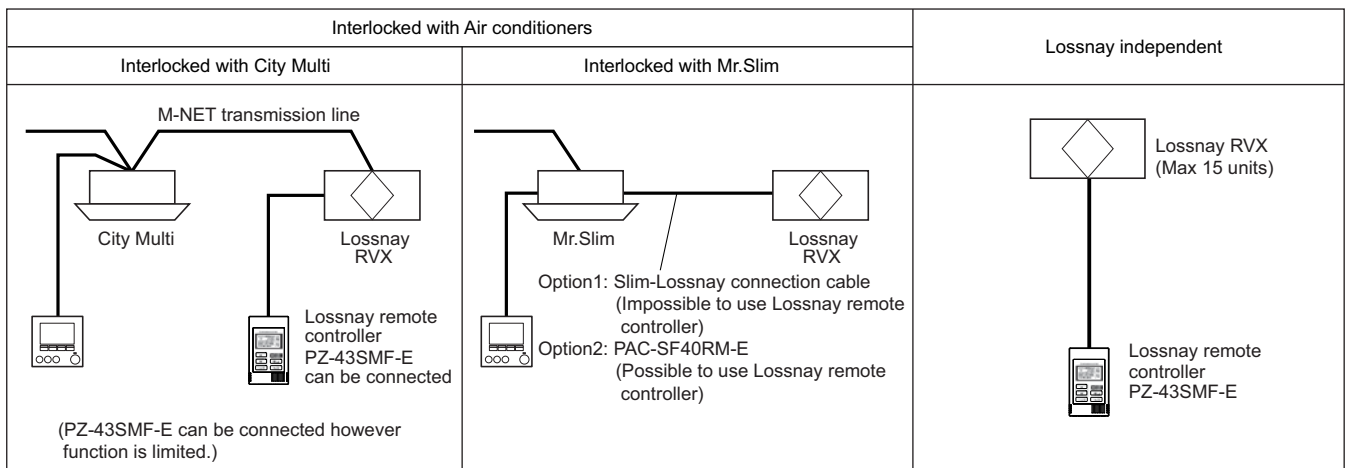

■ External dimension

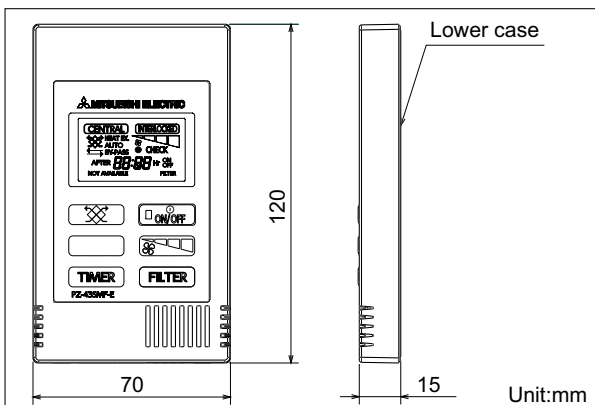

3-1. ON/OFF remote controller [PAC-YT40ANRA]

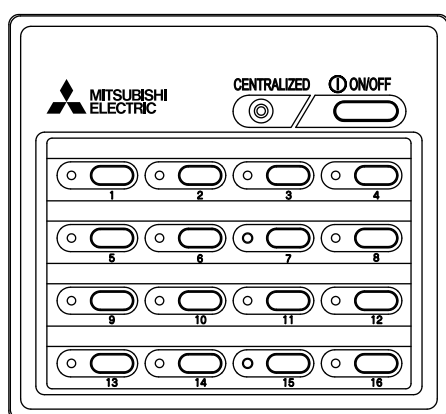

- 16 groups/50 units can be controlled.
 - Up to 16 groups/50 units can be operated with one ON/OFF remote controller.
 - A general-purpose interface is available for control, so general devices can also be turned ON and OFF.
- Just press a switch to start.
 - All of the units can be started and stopped by pressing the main switch, and each unit in the group can be started and stopped with individual switches.
- LED flashing during failure.
 - If any error should occur in the air conditioner, its details can be confirmed easily with the flashing LED. The LED also indicates whether each group is running or stopped.
- Interlock operation with external system possible.
 - It can be flexibly interlocked with a card reader, fire alarm system or building management system, etc., using the incorporated external input/output function.
- Flexible group setting.
 - The groups can be easily configured, so the group pattern can be freely set according to the layout.
 - The ON/OFF remote controller can be connected at the indoor/outdoor transmission line without the power supply unit.

NOTE

Dual set point function is available depending on the version of the controller. For the availability of the function, please contact your local distributor.

■ Functions

□: Each unit ○: Each group ●: Each block
 △: Each floor ◎: Group or collective X: Not available

Item	Description	Operations	Display
ON/OFF	ON and OFF operation for the air conditioner units	◎	◎
Operation mode switching	Not available	X	X
Temperature setting	Not available	X	X
Fan speed setting	Not available	X	X
Air flow direction setting	Not available	X	X
Manual operation prohibit/permit (ON/OFF, operation mode, setting temperature, filter reset)	Compatible only with external input.	X	X
Specific mode operation prohibit (Cooling prohibit, heating prohibit, cooling/heating prohibit)	Not available	X	X
Room temperature display	Not available	—	X
Error display	LED flashes during failure. (The error code can be confirmed by removing the cover.)	—	△
Schedule operation	Not available	X	X
Ventilation operation (independent)	Group operation of only LOSSNAY units possible. ※ Only ON/OFF of group.	○	○
Ventilation operation (interlocked)	The LOSSNAY will run in interlock with the operation of indoor unit. ※ The fan rate and mode cannot be changed. The LED will turn ON only during operation after interlocking.	△	△
External input (Timer connection, emergency stop input, etc.)	The following can be input with the level signals or pulse signals. Level signal: "Emergency stop input" or "Collective ON/OFF" Pulse signal: "Collective ON/OFF" or "Local remote controller prohibit/permit" One input can be selected from those above.	◎*1	—
External output (Error output, operation output)	"ON/OFF" and "error/normal" are output with the level signal. ※ The optional output cable is required.	—	◎*1

*1 Not applicable to groups

■ System example

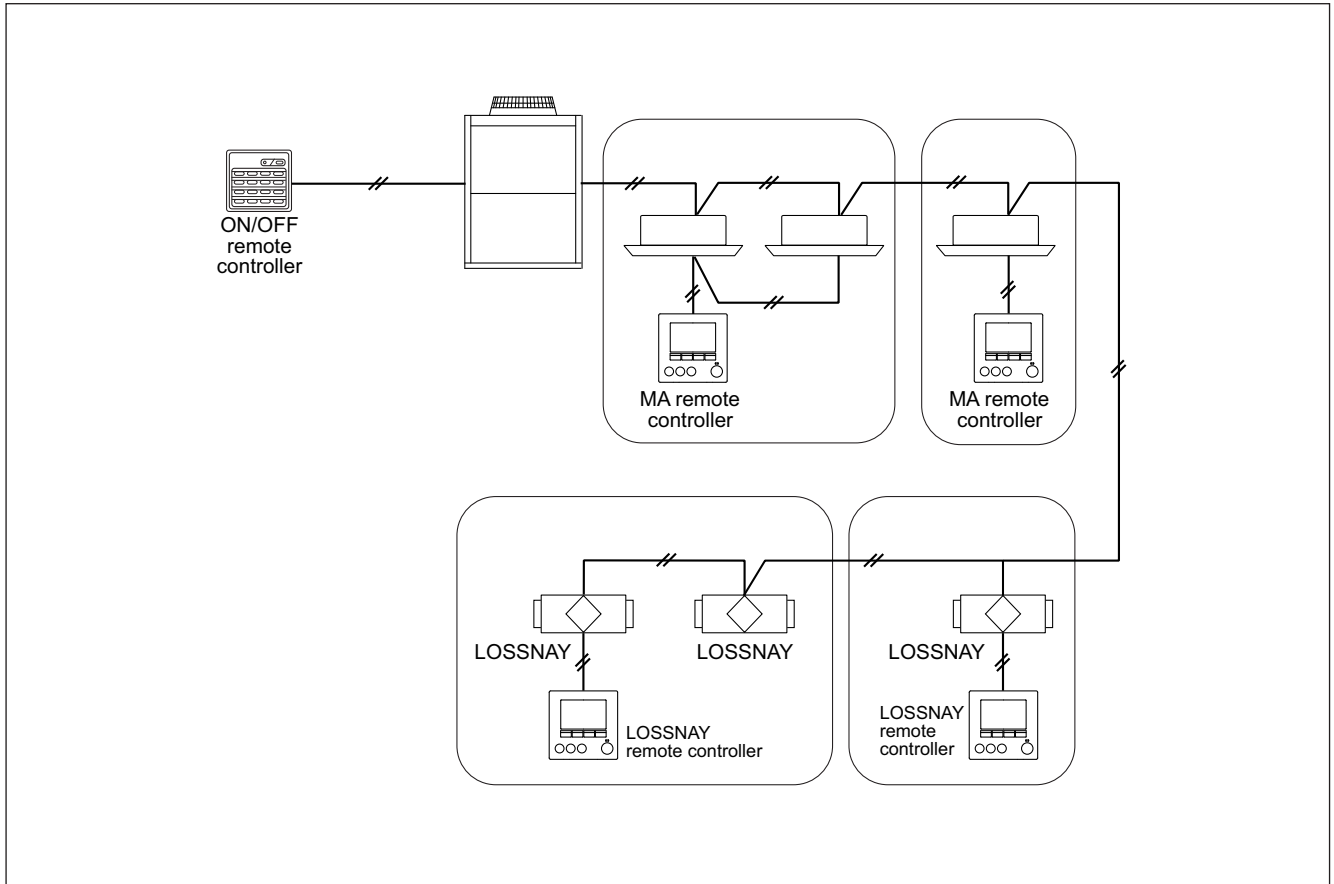

■ External dimension

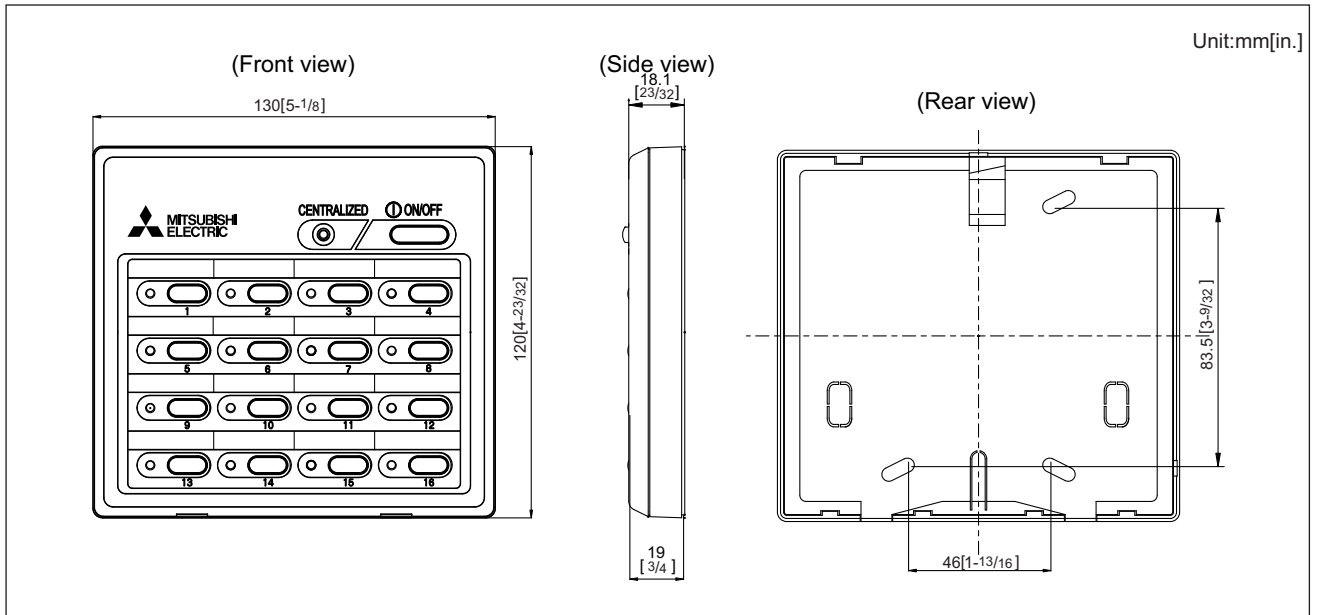

3-2. Advanced touch level signals controller [AT-50B]



Dual Set Point

■ Functions

□:Each unit ○:Each group ●:Each block ✓:Available
 △:Each floor ◎:Group or collective ✕:Not available

Item	Description	Operations	Display
ON/OFF	ON and OFF operation for the air conditioner units. The Batch Operation ON/OFF button will light up when one or more air conditioning units are operated.	◎	◎
Operation mode switching	Switches between Cool/Dry/Auto/Fan/Heat. Operation modes vary depending on the air conditioner unit. Auto mode is for CITY MULTI R2 and WR2 series only.	◎	◎
Temperature setting	The temperature can be set within the following range. Cool/Dry: 19°C - 35°C/67°F - 95°F Heat: 4.5°C - 28°C/40°F - 83°F Auto (single set point): 19°C - 28°C/67°F - 83°F Auto (dual set points) [Cool] Same as the set temp. range for Cool mode. [Heat] Same as the set temp. range for Heat mode. * Set temperature range varies depending on the model.	◎	◎
Fan speed setting	Models with 5 air flow speed settings: Hi/Mid-1/Mid-2/Low, Auto Models with 4 air flow speed settings: Hi/Mid-1/Mid-2/Low Models with 3 air flow speed settings: Hi/Mid/Low Models with 2 air flow speed settings: Hi/Low * Fan speed setting (including Auto) varies depending on the model.	◎	○
Air flow direction setting	Air flow direction angles 4-angle or 5-angle, Swing, Auto Louver ON/OFF * Air flow direction settings vary depending on the model.	◎	○
Permit/Prohibit	The ON/OFF, operation mode, setting temperature, fan speed, air direction, filter sign reset operations, and timer using the local remote controllers can be prohibited. Only ON/OFF and filter reset can be prohibited for the LOSSNAY group. * The settable items vary depending on the models.	◎	◎
Operation lock	The operation lock can be set to the input operation of AT-50B. Each button can be set. (Function Button 1, Function Button2, Collective ON/OFF, Touch Panel) Each function can be set. (Operation mode, Setting temperature, Fan speed, Menu button) The password for the lock release can be set.	◎	◎
Error display	When an error is currently occurring on an air conditioner unit, the afflicted unit and the error code are displayed. * When an error occurs, the "ON/OFF" LED flashes. The operation monitor screen show abnormal icon over the unit. The error monitor screen shows the abnormal unit address and error code. The error log monitor screen shows the time and date, the abnormal unit address, error code and source of detection.	✕	□◎
Schedule operation	Weekly schedule setting up to 12 pattern is available. In one pattern, up to 16 setting of "ON/OFF", "Operation mode", "Set Temperature", "Fan speed", "Air flow direction" and "Permit / Prohibit local operation" can be scheduled. Two types of weekly schedule(Summer/Winter) can be set. Today's schedule setting up to 5 pattern is available. * Time setting unit: 5 minute /unit	○	○
Night setback setting	This function helps keep the indoor temperature in the temperature range while the units are stopped and during the time this function is effective.	◎	◎
Ventilation (independent)	Switches the mode "Bypass/Heat recovery/Auto" for LOSSNAY groups.	◎	◎
Ventilation (interlocked)	The LOSSNAY will run in interlock with the operation of indoor unit. The mode cannot be changed. The LED will turn ON during operation after interlocking.	◎	◎
Temperature-set limitation	Batch-setting to temperature range limit at cooling, heating, and auto mode. This function cannot be used with the MA remote controller. (Depends on the indoor unit model.)	◎	◎
Specific mode operation prohibit (Cooling prohibit, heating prohibit, cooling/heating prohibit)	When set as the main controller, operation of the following modes with the local remote controllers can be prohibited. When cooling is prohibited: Cooling, dry, automatic can not be chosen. When heating is prohibited: Heating, automatic can not be chosen. When cooling/heating is prohibited: Cooling, dry, heating, automatic can not be chosen.	◎	◎
System changeover	Operation mode can be switched to an optimal mode depending on indoor temperature setting and target temperature of each group or a representative indoor unit. * When this function is used, the system changeover function of the outdoor unit cannot be used.	●	-

- AT-50B features a 5 inch color LCD touch panel. The settings for air conditioning units can be changed by touching the corresponding icons on the display. On the panel of AT-50B are 3 buttons; ON/OFF, F1 and F2 enabling simple and quick operation.
- One AT-50B can control up to 50 groups/units of air conditioners.

Item	Description	Operations	Display
External input (Emergency stop input, etc.)	The following input with level signals or pulse signals are available. Level signal: "Emergency stop input" or "Collective ON/OFF" Pulse signal: "Collective ON/OFF" or "Local remote controller prohibit/permit" One input can be selected from those above. * An external input/output adapter (PAC-YT51HAA (sold separately)) is required. Relays and DC power supply or other devices must be prepared at the site.	◎	◎
External output (Error output, operation output)	"ON/OFF" and "error/normal" are output with the level signal. * An external input/output adapter (PAC-YT51HAA (sold separately)) is required. Relays and DC power supply or other devices must be prepared at the site.	◎	◎
Checking the Gas Amount	Use this function to check for refrigerant leak from the outdoor unit. * When this function is used, the gas amount checking function of the outdoor unit cannot be used. This function is for CITY MULTI R2 and Y(PUMY is excluded.) series only.	□	□
Main system controller /Sub system controller	AT-50B can be set to Sub System controller. When connecting multiple system controllers, designate the system controller with many functions as the "Main", and set the system controllers with few functions as the "Sub".	✓	-
Function Buttons (F1 Button, F2 Button)	The F1 button and the F2 button can be set as a run button of the following collective operation. (Setback/Schedule/Operation Mode/Temperature Correction/Remote Controller Prohibition)	◎	◎

■ External dimension

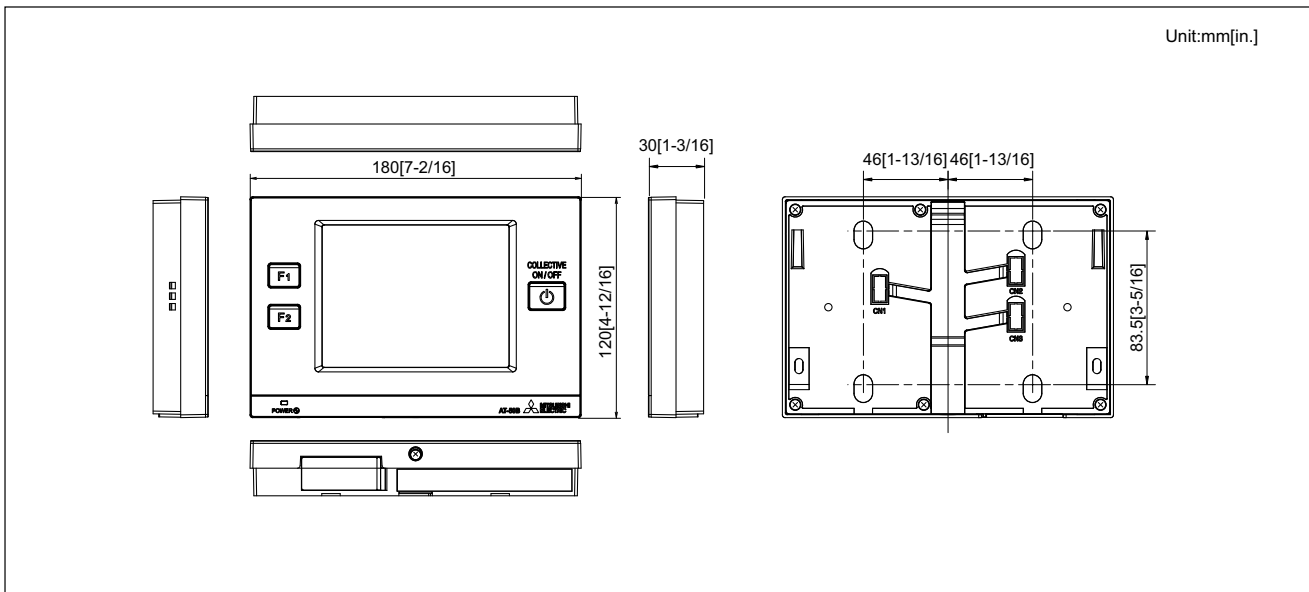

■ System example

(1) Connection with CITY MULTI units

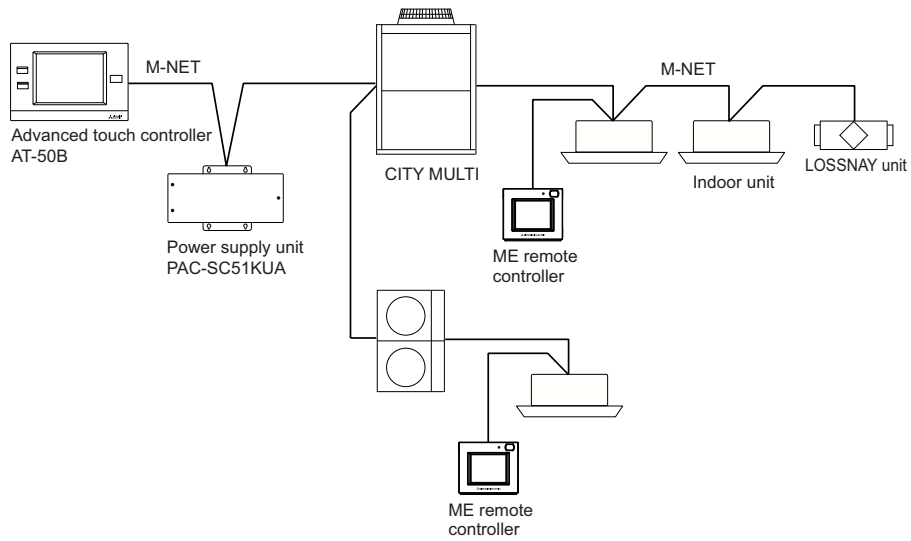

(2) Connection with CITY MULTI and Mr.SLIM units

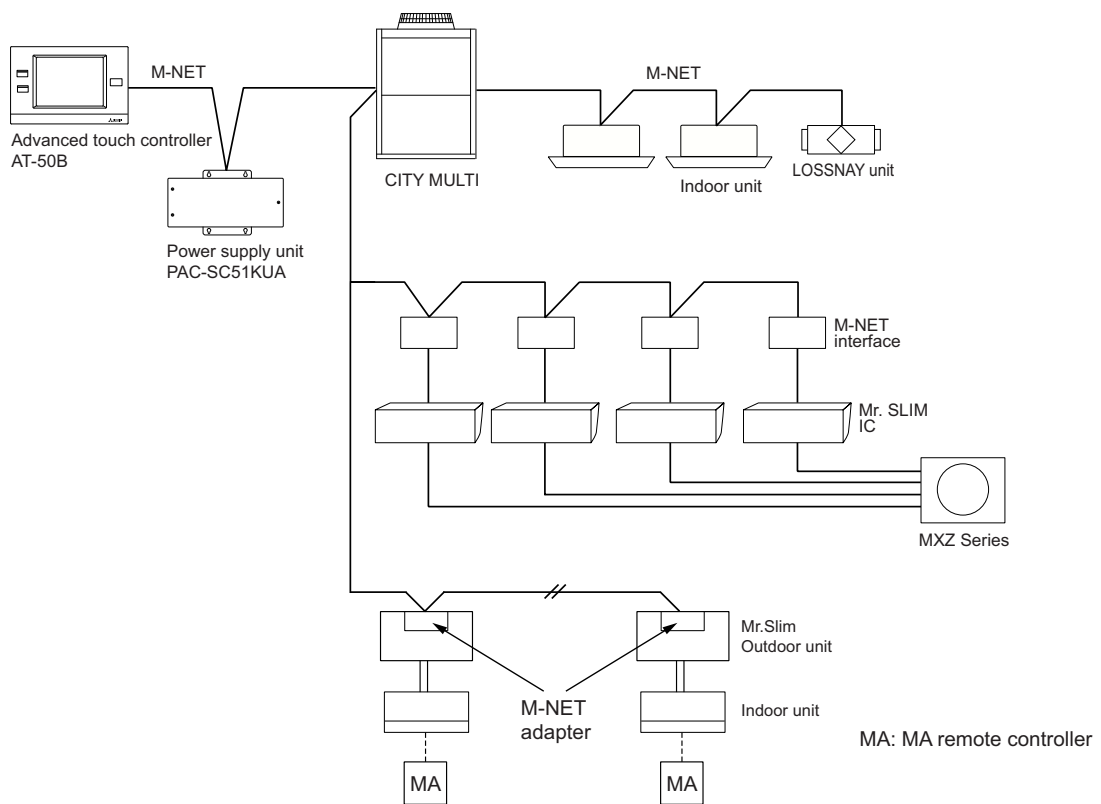

1. Power supply to AT-50B

AT-50B needs DC power supply of M-NET (24~32VDC) for centralized control transmission use, operation.

(1). Power supply of M-NET from power supply unit PAC-SC51KUA.

Power supply unit PAC-SC51KUA is recommended for AT-50B. See the diagram below ; for details, please refer to the installation manual of Power supply unit PAC-SC51KUA

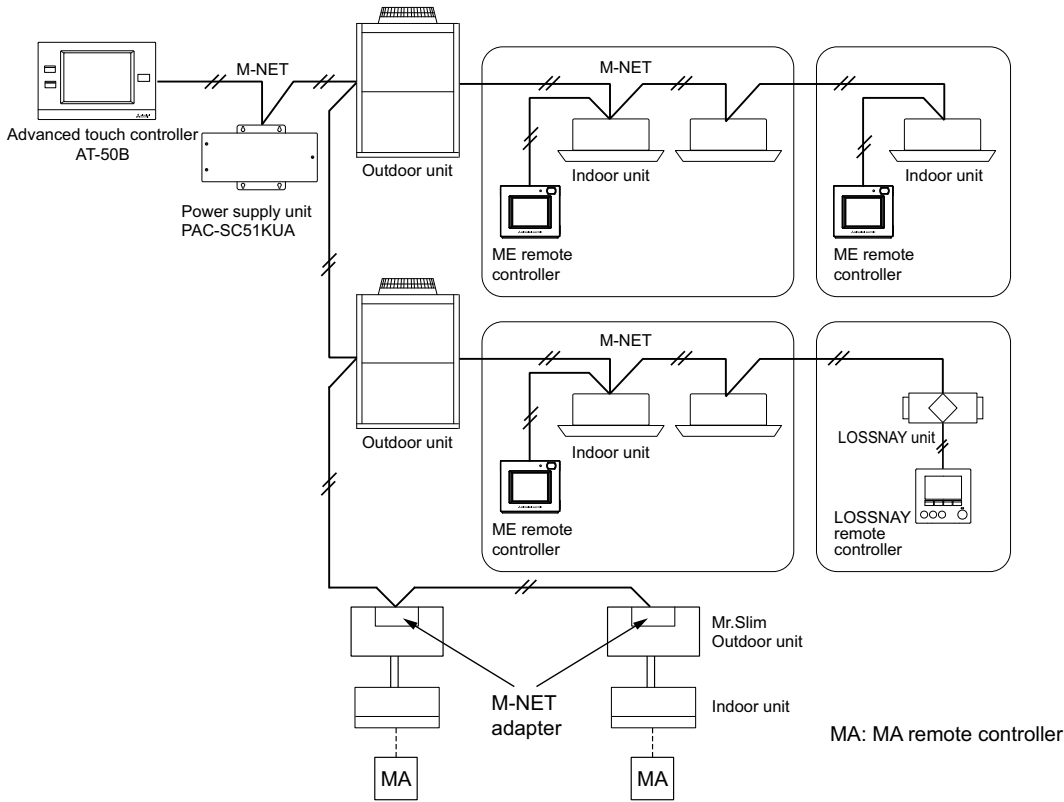

Fig. 1 Basic structure of AT-50B and PAC-SC51KUA

(2). Power supply of M-NET from outdoor unit connector TB7.

As shown on Fig. 2, AT-50B receives power supply of M-NET from R410A outdoor unit connector TB7.

In case one of the outdoor units should change its power supply, switch CN41 to CN40.

*NOTE: This method applies to R410A CITY MULTI outdoor unit except PUMY (S series)

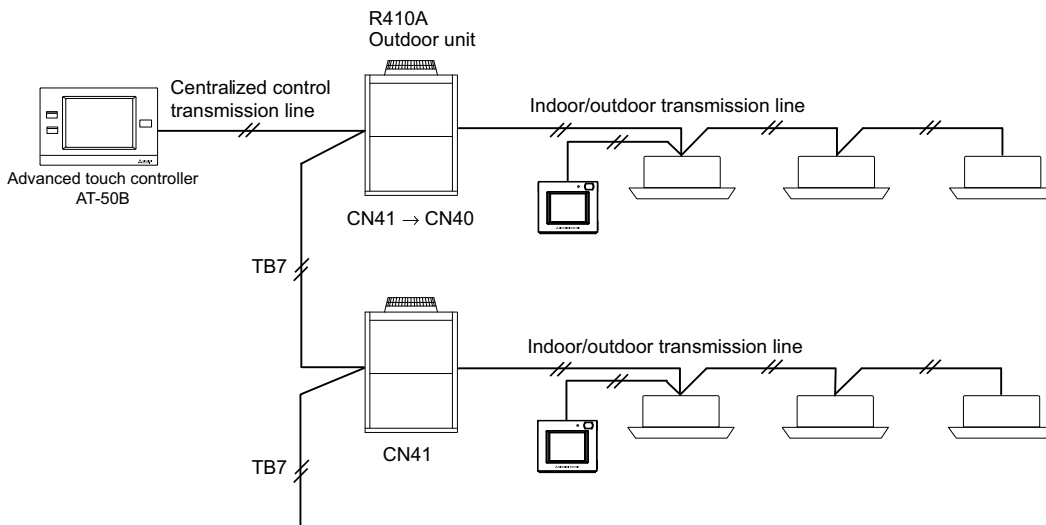

Fig. 2 AT-50B, TB7 scheme

- (3) Power supply of M-NET from outdoor unit connector TB3.
 AT-50B can also receive power supply from R410A/R407C/R22 outdoor unit connector TB3. However, if the outdoor unit shuts down, AT-50B will also automatically shut down. Therefore, this scheme is not recommended for air conditioning system consisting of multiple outdoor units.

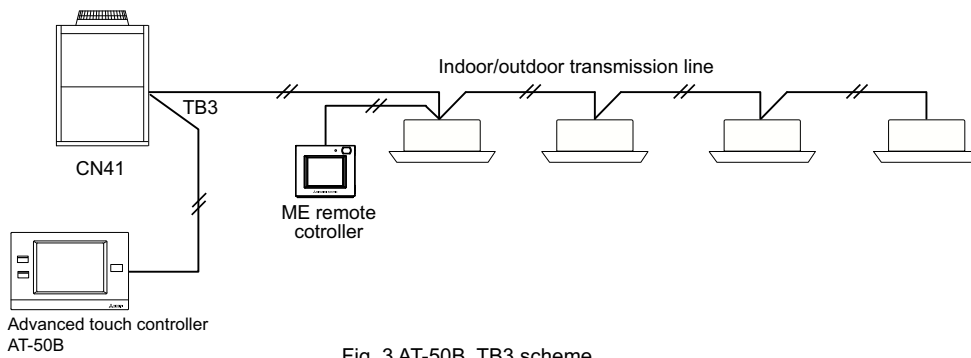
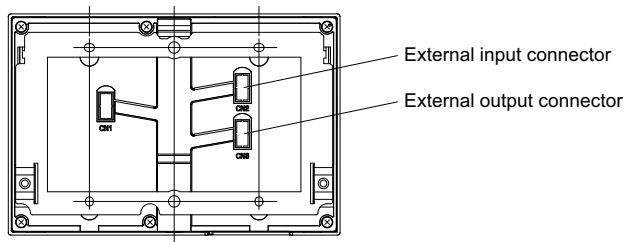

Fig. 3 AT-50B, TB3 scheme.

2. External input/output usage



(1). External signal input function

※ External signal input requires the external I/O adapter (Model: PAC-YT51HAA) sold separately.

1). External input

External no-voltage contact signal can be used to send signals indicating the following status of all air conditioning units that are controlled : Emergency stop/Normal, ON/OFF, and local remote controller operation Prohibit/Permit.

The above settings can be made using the external input setting on the Initial Setting screen accessed from the Service Menu screen.

No	External signal input function	Remarks
1	Do not use external input signal (factory setting)	
2	Execute emergency stop/normal with level signal	The local remote controller ON/OFF operations, and the controller ON/OFF operation and prohibit/enable change operations will be prohibited during emergency stop.
3	Perform ON/OFF with level signal	The local remote controller ON/OFF operations, and the controller ON/OFF operations and prohibit/enable change operations will be prohibited.
4	Perform ON/OFF, prohibit/enable with pulse signals.	Set the pulse width while the contact is ON to 0.2 to 1 sec.

2). Level signal and pulse signal

(A) Level signal

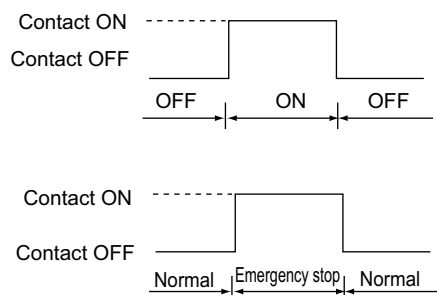

(B) Pulse signal (Example) for ON/OFF

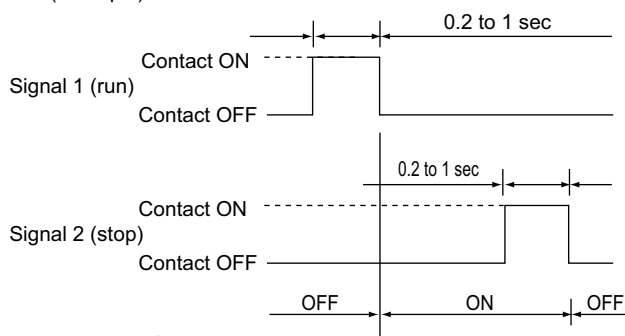

※ The prohibit/enable input is the same.

3). External input specifications

CN2	Lead wire	Emergency stop/normal level signal	ON/OFF, level signal	ON/OFF, prohibit/enable pulse signal
No.1	Green	Built-in power supply for external input (DC5V)		
No.2	Yellow	Emergency stop/normal input	ON/OFF input	ON input
No.3	Orange	Not used	Not used	OFF input
No.4	Red	Not used	Not used	Local remote controller operation prohibit input
No.5	Brown	Not used	Not used	Local remote controller operation enable input

(A) For level signal

- ① When the emergency stop/normal signal is selected, the status will change from normal to emergency stop when the external input signal contact changes from OFF to ON, and will change from emergency stop to normal when the contact changes from ON to OFF. Emergency stop signal will bring the air conditioners to stop, and canceling the emergency stop will not automatically reset these units. To go back to the previous operation status, they must be manually turned back on.
- ② When the ON/OFF signal is selected, the status will change from OFF to ON when the external input signal contact changes from OFF to ON, and will change from ON to OFF when the contact changes from ON to OFF.

(B) For pulse signal

- ① Even if the ON signal is input during ON, the status will remain ON.
- ② If local remote controller operation is prohibited, ON/OFF, operation mode, set temperature, filter sign reset, fan speed, and air direction settings will be prohibited, and also timer (schedule) settings from the local remote controllers will be deactivated. Depending on the models of the connected air conditioning units and remote controllers, operation of some of the items above may not be disabled.
- ③ Set the pulse width (contact ON time) to 0.2 to 1 sec.

4). Recommended circuit example

(A) For level signal

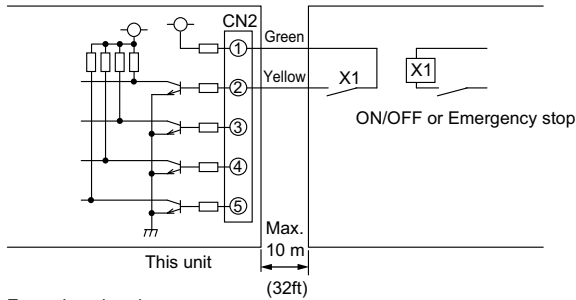

(B) For pulse signal

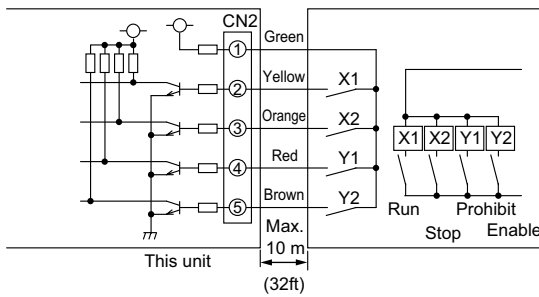

- ① The relays and extension cables, etc. must be prepared separately at the site.
- ② Use a no-voltage contact and minute load relay (minimum application load 5VDC-1mA).
- ③ The length of the connection cable extension should not exceed 10 m (32 ft). (Use a cable of 0.3 mm² (22 AWG) or thicker.)
- ④ Cut of the cable not being used close the connector and properly insulate the cut off ends with tape or the like.

(2). External signal output function

※ External signal output requires the external I/o adapter (Model: PAC-YT51HAA) sold separately.

1). External output

When one or more air conditioners are running, the "ON" signal will be output and if a malfunction occurs in one or more air conditioners, the "Malfunction" signal will be shown.

2). External output specifications

CN 3	Lead wire	Details of each terminal
No.1	Brown	ON/OFF
No.2	Red	Malfunction/normal
No.3	Orange	Common (External ground)
No.4	Yellow	

① "ON" signal and " Malfunction" signal will both be output.

3). Recommended circuit example

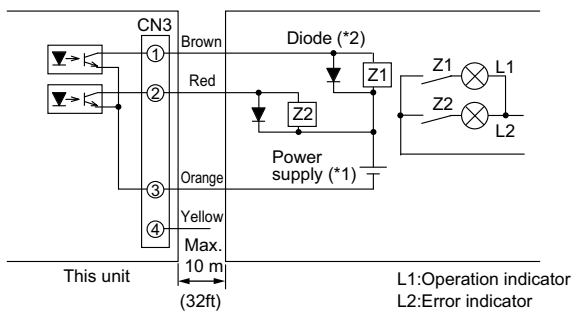

Use Z1 and Z2 relays having the following specifications.
 Operation coil
 Rated voltage :12VDC, 24VDC
 Power Consumption : 0.9W or less
 (*1)Prepare a power supply separately according to the relay being used. (12VDC or 24VDC)
 (*2)Always insert a diode on both ends of the relay coil.

- ① Each element will turn on while ON operation or a malfunction occurs.
- ② The connection cable can be extended up to 10m (32ft).
- ③ The relays, lamps, diodes and extension cables, etc. must be prepared separately at the site.

3. Screens of AT-50B



GRID (S)



GRID (L)



LIST



GROUP

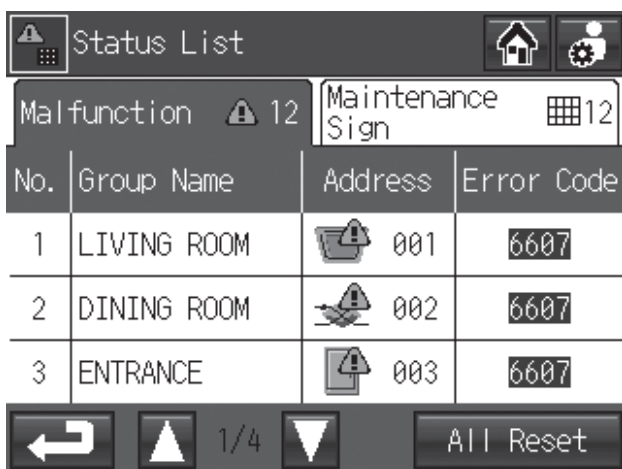

Status List

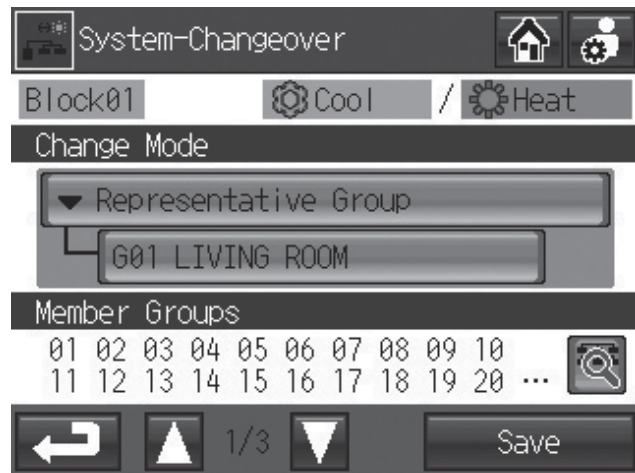

System-Changeover

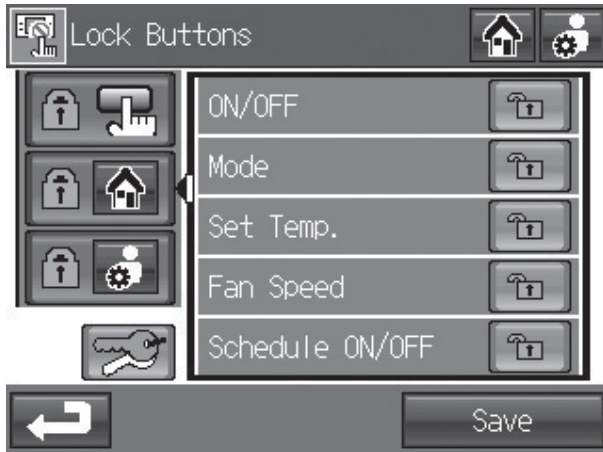

Operation Lock

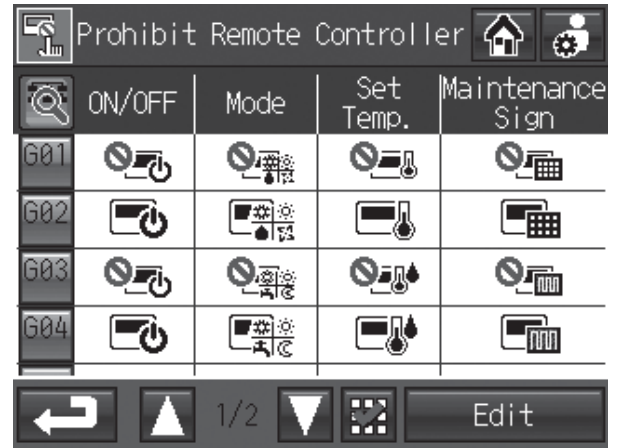

Prohibit Remote Controller

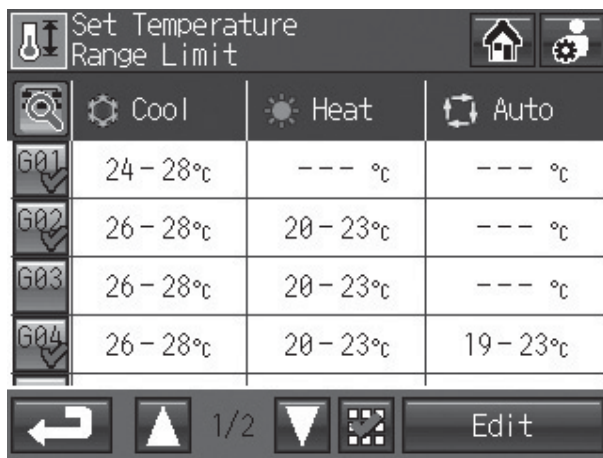

Set Temperature Range Limit

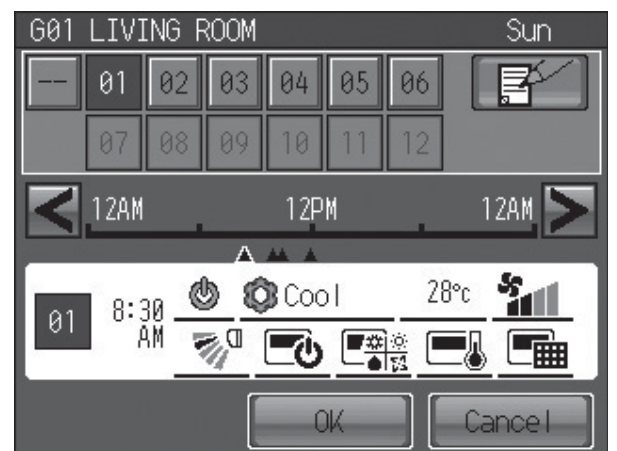

Set Schedule



Display Format

3-3. Centralized controller [AE-200E/AE-50E]

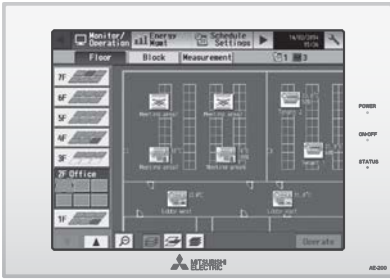

Dual Set Point

Functions

□:Each unit ○:Each group ●:Each block
 △:Each floor ◎:Collective ×:Not available

Item	Description	Operations	Display
ON/OFF	ON and OFF operation for the air conditioner units	○◎△●	○◎
Operation mode switching	Switches between Cool/Dry/Auto/Fan/Heat. (Group of LOSSNAY unit, automatic ventilation/vent-heat interchange/normal ventilation) Operation modes vary depending on the air conditioner unit. Auto mode is the City Multi R2 and WR2 series only.	○◎△●	○
Temperature setting	Range of temperature setting Cool/Dry : 19°C - 30°C (14°C - 30°C) / 67°F - 87°F (57°F - 87°F) Heat : 17°C - 28°C (17°C - 28°C) / 63°F - 83°F (63°F - 83°F) Auto : 19°C - 28°C (17°C - 28°C) / 67°F - 83°F (63°F - 83°F) ※ Range of temperature settings vary depending on model.	○◎△●	○
Sliding Temperature setting	This function shifts the preset temperature by the preset increment to reduce the temperature difference between the indoor and outdoor air temperatures during cooling operation. The maximum shifting temperature (±1°C, ±2°C, ±3°C, ±4°C) can be set for each group.	○	○
Night setback setting	This function helps keep the indoor temperature in the temperature range while the units are stopped and during the time this function is effective.	○	○
Fan speed setting	Models with 5 air flow speed settings: Hi/Mid-1/Mid-2/Low, Auto Models with 4 air flow speed settings: Hi/Mid/Low, Auto Models with 2 air flow speed settings: Hi/Low Fan speed setting (including Auto) varies depending on the model.	○◎△●	○
Air flow direction setting	Air flow direction angles, 4-angle or 5-angle Swing, Auto *1: Louver cannot be set. *Air flow direction settings vary depending on the model.	¹ ○◎△●	○
Schedule operation	Annual/Weekly (5 types)/Today schedule can be set for each group of air conditioning units. Optimized start setting is also available. *2: The system follows either the current day, annual schedule, or weekly, which are in the descending order of overriding priority. Twenty-four events can be scheduled per day, including ON/OFF, Mode, Temperature Setting, Vane Direction, Fan Speed, and Operation Prohibition. Five types of weekly schedule(Summer/Winter/etc.) can be set. Settable items depend on the functions that a given air conditioning unit supports.	² ○◎△●	○
Permit/Prohibit local operation	Individually prohibit operation of each local remote control function (ON/OFF, Change operation mode, Set temperature, Reset filter). Air Direction, Fan speed, Timer *3: The settable items vary depending on the models.	○◎△●	○ ³
Indoor unit intake temperature	Measures the intake temperature of the indoor unit. *8: Displays the ambient temperature of either the return air temperature sensor on the indoor unit or the temperature sensor on the remote controller, whichever is selected on the indoor temperature display mode selection.	×	○ ⁸
Error	When an error is currently occurring on an air conditioner unit, the afflicted unit and the error code are displayed. *4: When an error occurs, the "ON/OFF" LED flashes. The operation monitor screen shows the abnormal unit by flashing it. The error monitor screen shows the abnormal unit address, error code and source of detection. The error log monitor screen shows the time and date, the abnormal unit address, error code and source of detection.	×	□◎ ⁴
Test run	This operates air conditioner units in test run mode.	○◎△●	○
Ventilation equipment	The interlocked system settings can be performed by the master system controller. When setting the interlocked system, you can use the ventilation switch to switch the free plan LOSSNAY settings between "Hi", "Low" and "Stop". When setting a group of only free plan LOSSNAY units, you can switch between "Normal ventilation", "Interchange ventilation" and "Automatic ventilation". *5 When setting ventilation interlock with Mr.Slim units, the air conditioning and interlocked ventilation icon will display ON even when the interlocked LOSSNAY is operating by itself. (This will occur when used with the following M-NET adapter: PAC-SF48/50/60/70/80/81MA-E)	○◎△●	○ ⁵
External input/output	By using accessory cables you can set and monitor the following. Input: By level signal: "Batch ON/OFF", "Batch emergency stop" By pulse signal: "Batch ON/OFF", "Enable/disable local remote controller" Output: "ON/OFF", "Error/Normal" *6: Requires an external I/O cable (PAC-YG10HA; sold separately) and a commercially available external power supply.	◎ ⁶	◎ ⁶
Temp range limit settings	Sets the temperature range for the local remote controllers. *7: The item and range that can be operated or monitored depend on the function of the indoor unit.	○ ⁷	○
AHC status	Displays the status of input and output ports of each Advanced HVAC CONTROLLER (AHC).	×	□
Free Contact status	Displays the input/output status of the free contacts on the indoor units.	×	□
Measurement	Displays the temperature, humidity, and the reading of the watt-hour meter.	×	□
Outdoor Unit Status Monitor	Monitor the current outdoor unit status Data: Frequency (Compressor), high/low pressure (outdoor unit)	×	□
Energy Use Status	On the Energy Use Status screen, the energy-control-related status, such as electric energy consumption, operation time, and outdoor temperature, can be displayed in a graph. Operators can check the detailed status of given indoor units by specifying the date to display the data per group, block, or unit address.	×	□○●
Filter sign reset/ Filter sign	Filter sign can be reset for each group or block of indoor units. Filter sign indicates that the filter on the units in a given group is due for cleaning.	□○●	□○●
Interlock setting	Operation of indoor groups or general equipment can be interlocked by the change of state (ON/OFF, mode, error of indoor groups and general equipment). (EB-50GU will execute interlocking control depending on the interlocked setting.)	○	○
Data back-up (PC) or USB memory	The initial setting data, operation data (charge parameter, power consumption data) can be stored in the PC.	◎	-

NOTE: Depending on the versions of AE-200E, some of the functions may not be available. The external input/output terminal on AE-200E becomes unavailable when AE-200E is connected to AE-50E. Use the terminals on AE-50E in that case.



Java™ is a registered trademark of Oracle and/or its affiliates.

External dimension

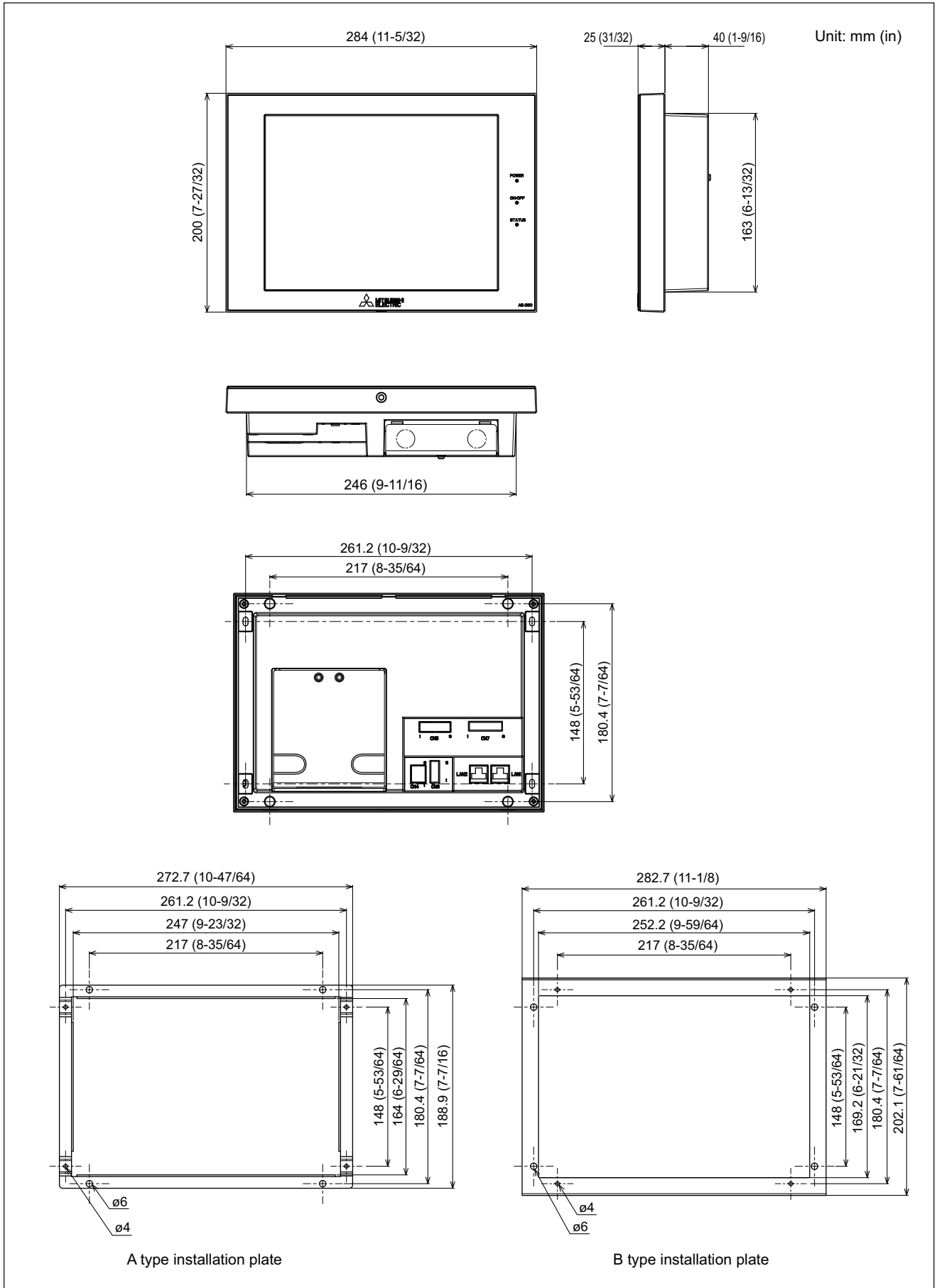

1. Power supply to AE-200E

AE-200E needs AC power (100-240VAC) and M-NET; the former is for centralized control transmission use and the latter is for AE-200E's operating and LAN function use.

Except when the sub system controller is used, the power supply unit PAC-SC51KUA or the power supply from the outdoor unit to M-NET is not necessary. For more details, please refer to the Installation Manual of AE-200E/AE-50E.

(1). The basic scheme is as follows.

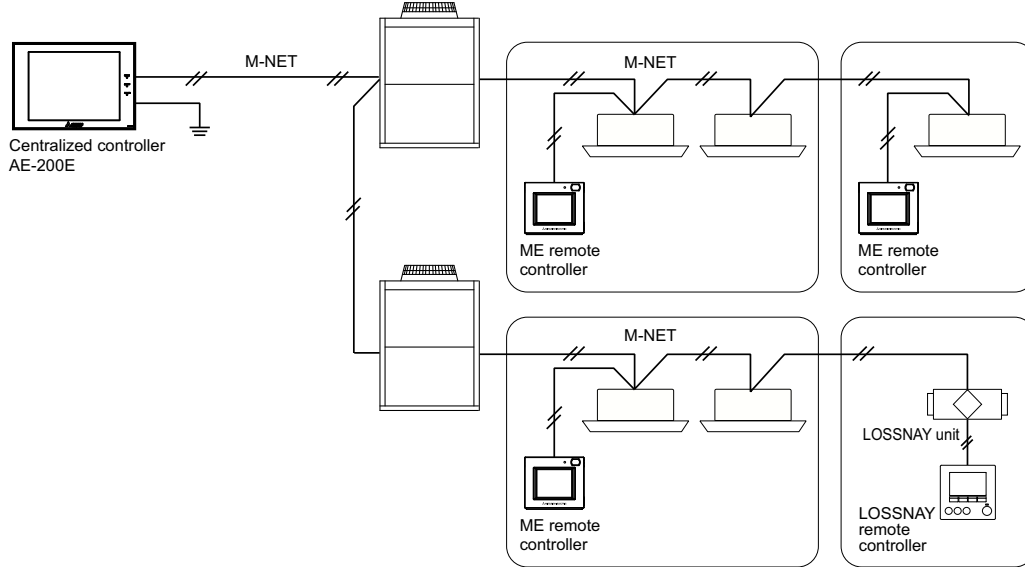

Fig.1 AE-200E basic scheme.

2. M-NET power supply

AE-200E/AE-50E has a built-in function to supply power to the M-NET transmission line.

The amount of power that an AE-200E or an AE-50E can supply is equivalent to the power required by an MN converter (CMS-MNG-E) that is used for maintenance.

Note	<ul style="list-style-type: none"> • Supplying power from the outdoor unit or the power supply unit, it is necessary to disconnect the M-NET power jumper CN21. (At factory setting, CN21 is connected.) • When connecting both AE-200E/AE-50E and the system controller (Advanced touch controller, ON/OFF remote controller, etc.) to the same M-NET system, it is necessary to connect the power supply unit (PAC-SC51KUA), and disconnect the M-NET power jumper CN21 on AE-200E/AE-50E. • When connecting both AE-200E/AE-50E and BAC-HD150 (BM ADAPTER) to the same M-NET system, certain restrictions apply. Consult your dealer for details.
-------------	--

3. External input/output usage

* To use the external signal input, an external I/O adapter (PAC-YG10HA-E; sold separately) and an external power supply are required.

NOTE: When using the AE-200E connected with the AE-50E, use external input/output function of each AE-200E/AE-50E.

[External signal input function]

Using external contact signals (12 or 24 VDC), the following collective operations for all connected air conditioning units can be controlled: Emergency stop, ON/OFF operation, and Prohibit/Permit local remote controller operation.

(1) External signal input function setting

Setting mode	Description
[Demand (Level signal)/Not in use] (Factory setting)	Select this mode when inputting a demand level using a level signal, or when not using an external signal input function. A demand signal of four different levels will be input.
[Emergency Stop (Level signal)]	Using a level signal, all the air conditioning units connected to the AE-200E or AE-50E will be stopped collectively in an emergency. During an emergency stop, the ON/OFF operation from the local remote controllers will be prohibited, and the ON/OFF operation and Prohibit/Permit settings on the AE-200E or AE-50E will be prohibited. A demand signal of three different levels will be input.
[ON/OFF (Level signal)]	Using a level signal, all the air conditioning units connected to the AE-200E or AE-50E will be run or stopped collectively. The ON/OFF operation from the local remote controllers will be prohibited, and the ON/OFF operation and Prohibit/Permit settings on the AE-200E or AE-50E will be prohibited. Scheduled operations will not be performed.
[ON/OFF/Prohibit/Permit (Pulse signal)]	Using a pulse signal, all the air conditioning units connected to the AE-200E or AE-50E will be run or stopped collectively, or the operation from the local remote controllers will be prohibited or permitted collectively.

* General equipment connected via a DIDO controller (PAC-YG66DCA) cannot be collectively run or stopped by using the external signal input function unless [Emergency Stop (Level signal)] is selected and relevant switches on the DIDO controller are set.

* The external input function cannot be used on HWHP (CAHV) units.

(2) External signal input specifications

CN5	Lead wire from PAC-YG10HA-E	Demand (Level signal)	Emergency Stop (Level signal)	ON/OFF (Level signal)	ON/OFF/Prohibit/Permit (Pulse signal)
No. 5	Orange	Demand level 1	Emergency stop signal, Normal operation signal	ON signal, OFF signal	ON signal
No. 6	Yellow	Demand level 2	Demand level 2	–	OFF signal
No. 7	Blue	Demand level 3	Demand level 3	–	Prohibit signal
No. 8	Gray	Demand level 4	Demand level 4	–	Permit signal
No. 9	Red	External power supply (+12 or +24 VDC)			

(3) Level signal and pulse signal

(A) Level signal

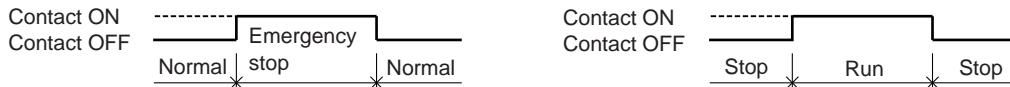

How the demand level is determined

Demand level signal specification: When higher levels' contacts turn on, lower levels' contacts also stay on.

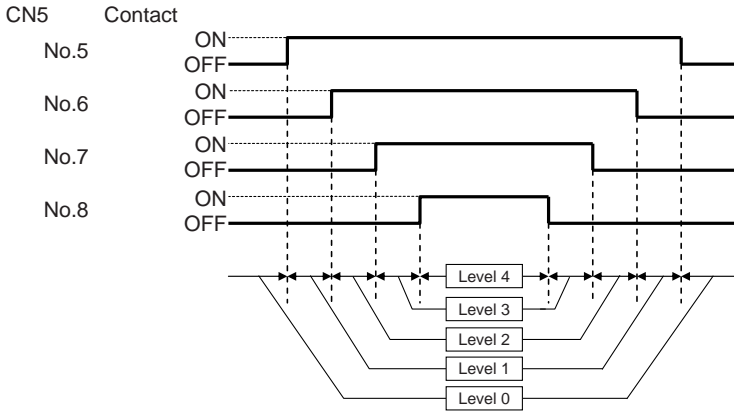

Demand level signal specification: Only the current levels' contacts turn on.

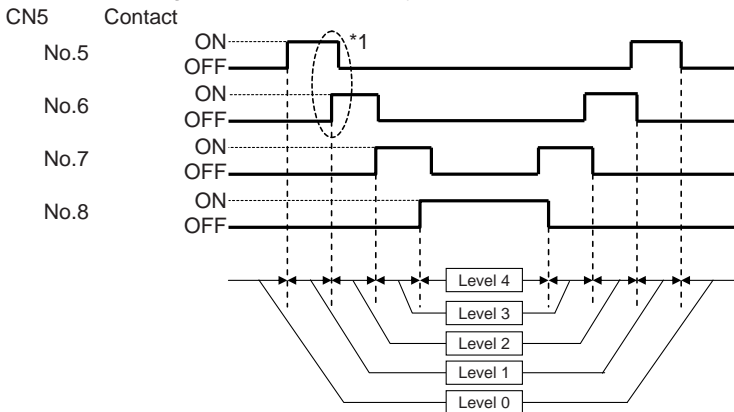

*1 The specification must be followed in the following order: ① When the level changes, the contact of the level after the change turns on.; ② The contact of the level before the change turns off.

1. If [Emergency stop (Level signal)] is selected, the air conditioning units in normal operation will stop when the contact turns on. Even when the contact turns off, these units will remain stopped. They must be started up manually after the emergency stop is reset.
2. If [ON/OFF (Level signal)] is selected, the air conditioning units that are stopped will start operation when the contact turns on. Conversely, the units that are in operation will stop when the contact turns off.
3. Demand control is performed when the demand level contact turns on. If two different demand levels' contacts turn on at the same time, the demand control will be performed with the higher level demand. (Even if the demand control is not performed due to unexpected problems, Mitsubishi Electric will not be responsible for exceeding the maximum power demand.)

(B) Pulse signal

(Example) ON/OFF

(Example) Prohibit/Permit

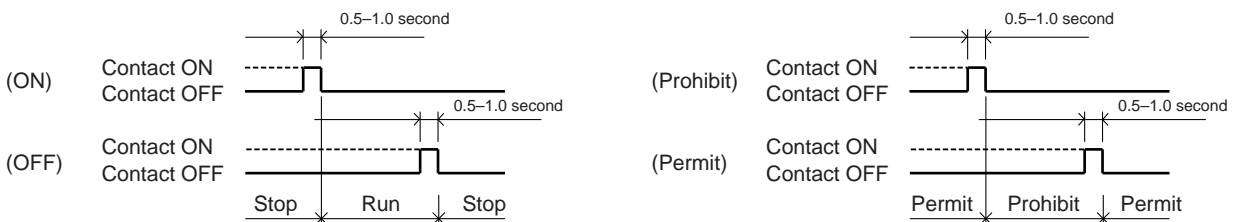

1. If the input pulse signal is the same as the current operation status of the air conditioning units, no status change will occur. (For example, if an ON signal is input while the air conditioning units are in operation, the units will continue their operation.)
2. If the operation from the local remote controller is prohibited, ON/OFF status, operation mode, or temperature setting cannot be changed and filter sign cannot be reset from the local remote controller.
3. The pulse width (contact ON) should be between 0.5 and 1.0 second.

(4) Recommended circuit

(A) Level signal

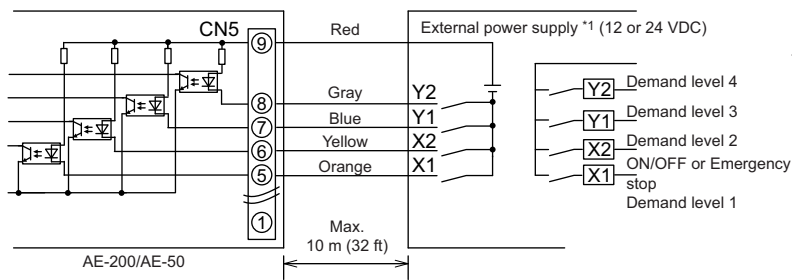

Use relays X1, X2, Y1, and Y2 that meet the following specifications.

Contact rating

Rated voltage: 12 VDC or above

Rated current: 0.1 A or above

Minimum applied load: DC 1 mA

(B) Pulse signal

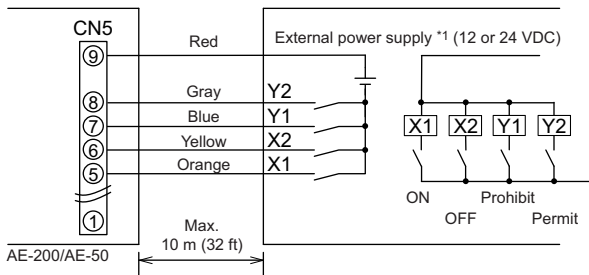

*1 Select an external power supply suitable for the relays used. (12 or 24 VDC)

Connect the external power supply in the correct polarity to input and output the signals.

Connect ⑤–⑧ (see the figure at left) to the negative side.

Important

- Be sure to use an external power supply (12 or 24 VDC) to avoid malfunctions.
- Connect the external power supply in the correct polarity to avoid malfunctions.

Note

- The relays, external power supply, and extension cables are not supplied.
- The total length of the lead wire and extension cable should not exceed 10 m (32 ft). (Use an extension cable of 0.3 mm² or thicker.)
- Cut the excess cable near the connector, and insulate the end of the unused cable with tape.

[External signal output function]

An ON signal is output when one or more units are in operation, and an Error signal is output when one or more units are in error.

(1) External signal output specifications

CN5	Lead wire from PAC-YG10HA-E	Signal
No. 1	Green	Common ground for external output (Ground for the external power supply)
No. 2	Black	ON signal*, OFF signal
No. 3	Brown	Error signal, Normal signal

* The operation status of general equipment (via a DIDO controller (PAC-YG66DCA)) will not be output.

* The ON signal will be output even during an error.

(2) Recommended circuit

Relay-driven circuit

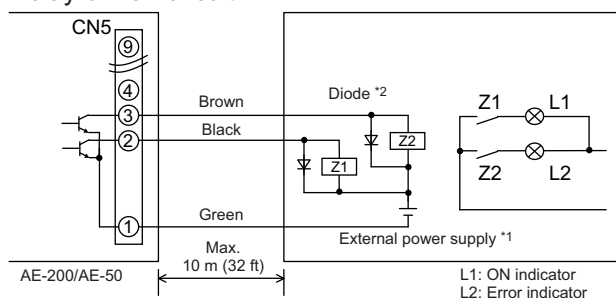

Use relays Z1 and Z2 that meet the following specifications.

Operation coil

Rated voltage: 12 or 24 VDC

Power consumption: Max. 0.9 W

*1 Select an external power supply suitable for the relays used. (12 or 24 VDC)

Connect the external power supply in the correct polarity to input and output the signals.

Connect ① (shown in the figure at left) to the negative side.

*2 Use a diode at both ends of the relay coils.

Important

- Be sure to use an external power supply (12 or 24 VDC) to avoid malfunctions.
- Connect the external power supply in the correct polarity to avoid malfunctions.
- Do not connect the external power supply without relays being connected to the controller (no load).

Note

- The relays, lamps, external power supply, diodes, and extension cables are not supplied.
- The total length of the lead wire and extension cable should not exceed 10 m (32 ft). (Use an extension cable of 0.3 mm² or thicker.)
- Each element will turn on during operation and when an error occurs.

Note

* When connecting the external input/output cables to connector CN5 on the controller, punch out the knockout hole.

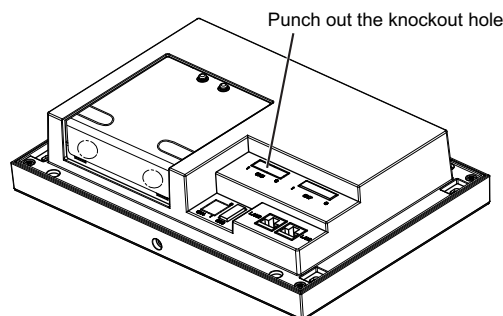

4. Connecting the LAN cable

Connect the LAN cable to the LAN1 port on the AE-200E/AE-50E. (The LAN2 port is unused.)

- The LAN cable is not supplied. Use a category 5 or above straight LAN cable.
- Use a switching HUB.
- The maximum distance between the switching HUB and AE-200E/AE-50E is 100 m (328 ft).
- The recommended number of connected devices such as gateway, router, layer 3 switch, or HUB between the AE-200E and AE-50E is four or less.

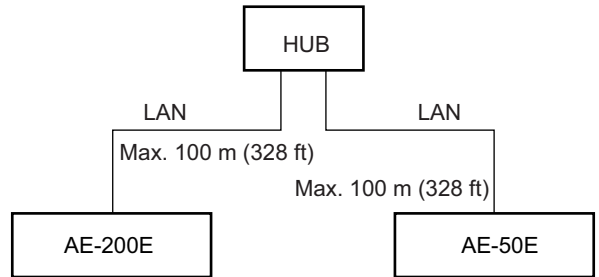
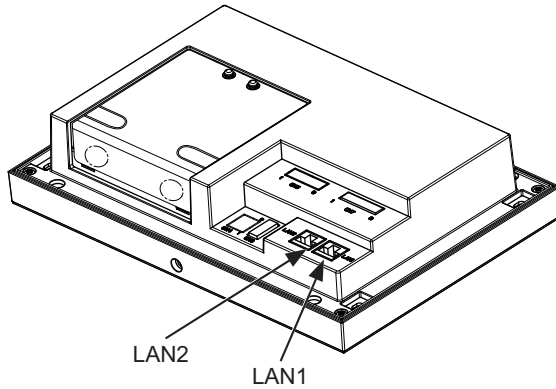

Note

- LAN must be installed before the unit installation. Route the LAN cable to the AE-200E/AE-50E in the same way as the M-NET transmission cables.
- When connecting the AE-200E/AE-50E to an existing LAN, consult the system administrator to decide the IP address. Change the IP address setting before connecting the LAN cable to the LAN1 port.
- To prevent unauthorized access, always use a security device such as a VPN router when connecting the AE-200E/AE-50E to the Internet.

5. Browser screens of AE-200E/AE-50E

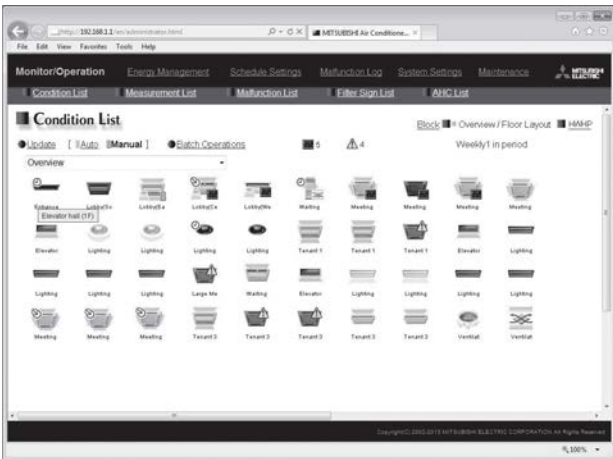

Condition List (Overview)

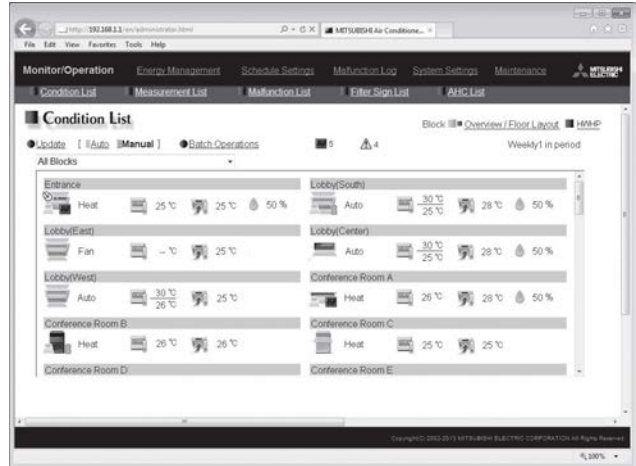

Condition List (Block)



Condition List (Overview/Floor Layout)

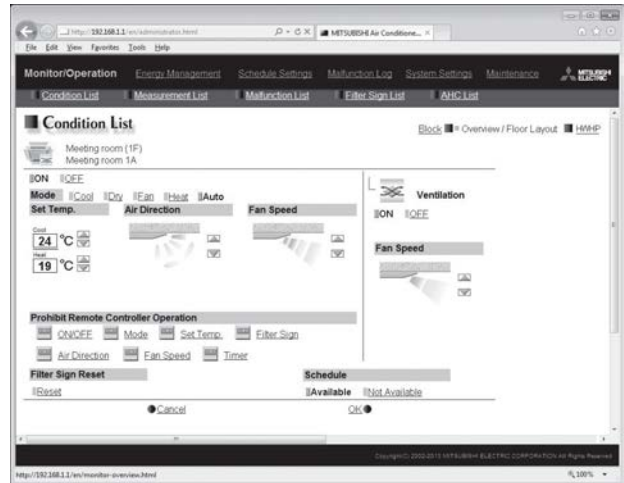

Operation

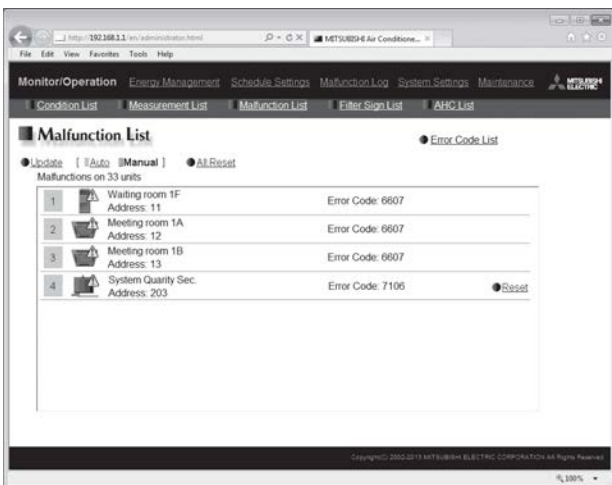

Malfunction List

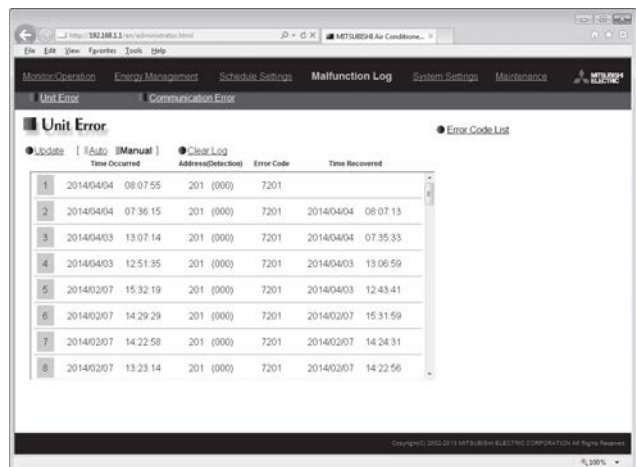

Malfunction Log

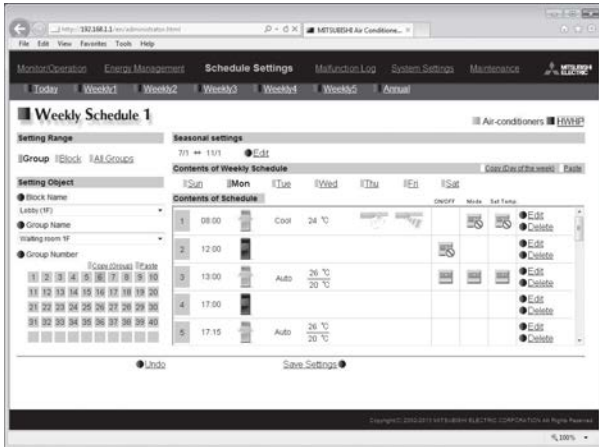

Weekly Schedule 1

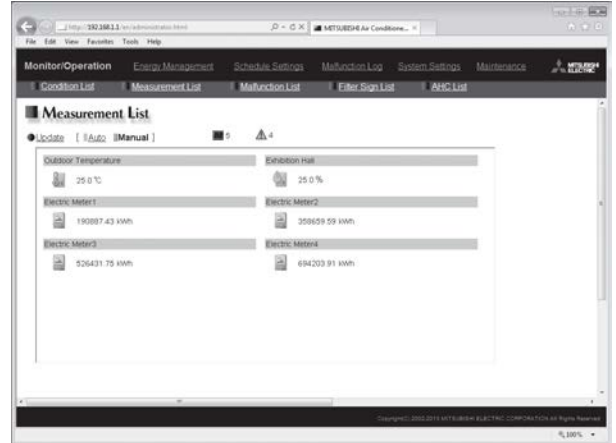

Measurement status monitor (temperature sensor/humidity sensor /measurement meter)

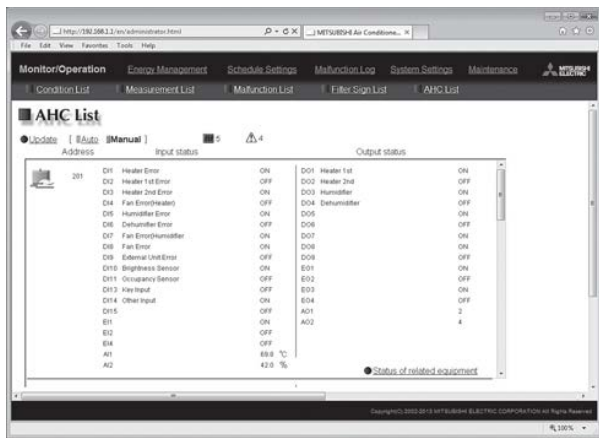

Advanced HVAC CONTROLLER Status monitor

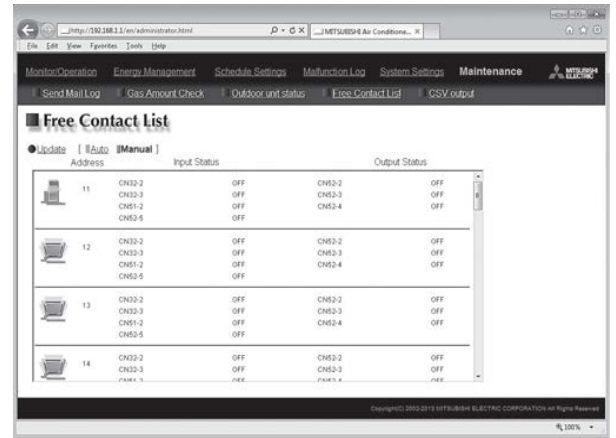

Free Contact Status monitor



Energy Management monitor (Energy use status)

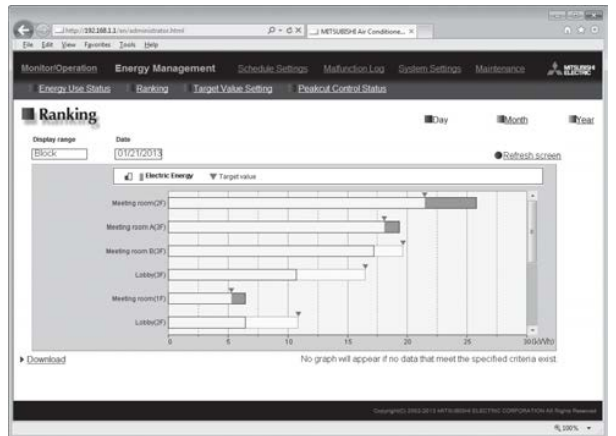

Energy Management monitor (Ranking)

6. Liquid crystal displays of AE-200E/AE-50E

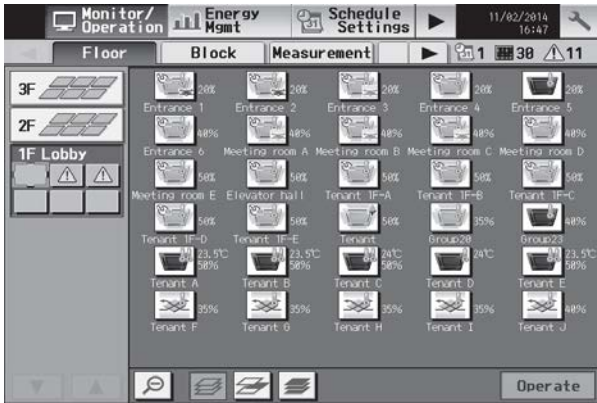

Floor screen

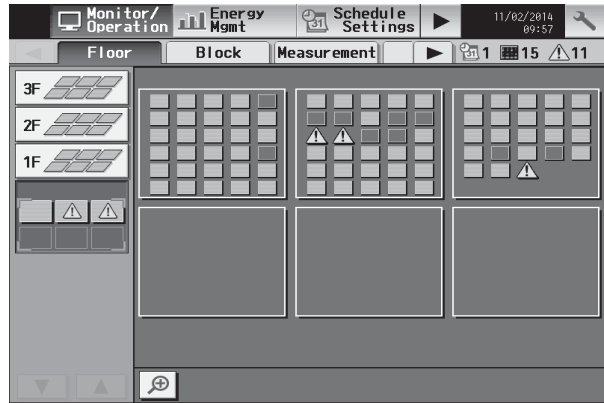

Floor screen (Zoom-out display)

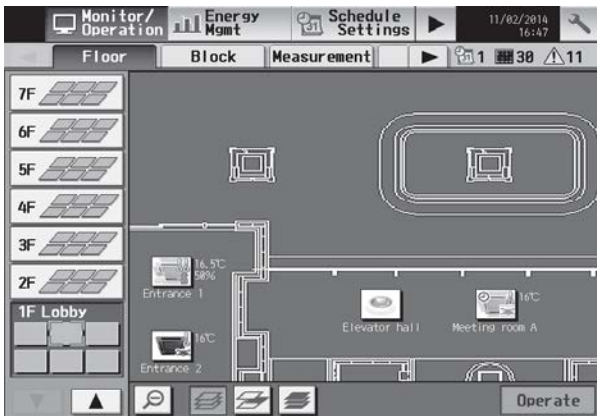

Floor layout screen

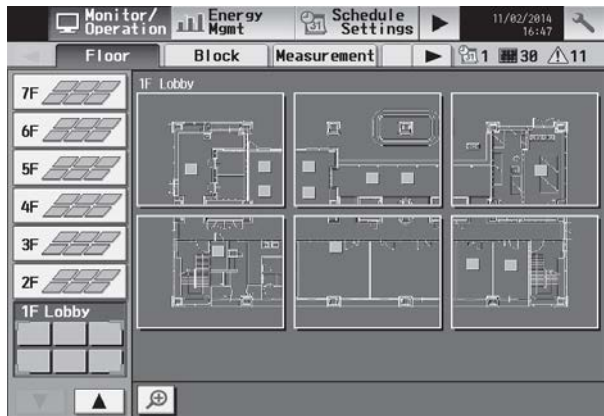

Floor layout screen (Zoom-out display)



Weekly schedule setting screen

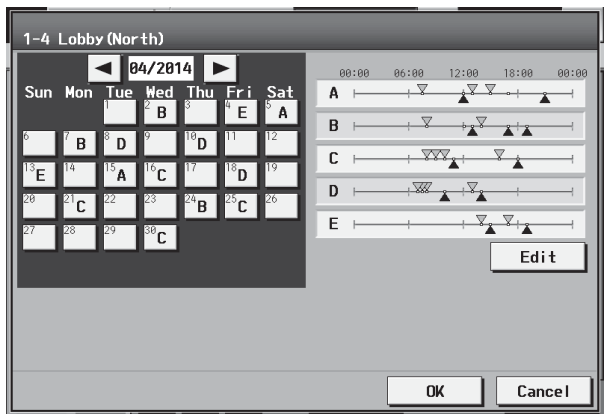

Annual schedule setting screen



Block display screen

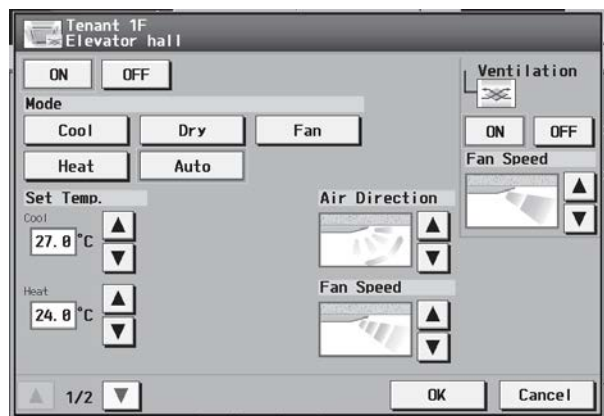

Operation screen

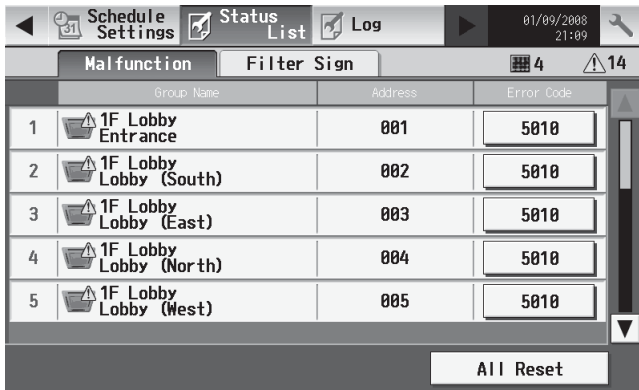

Error status screen

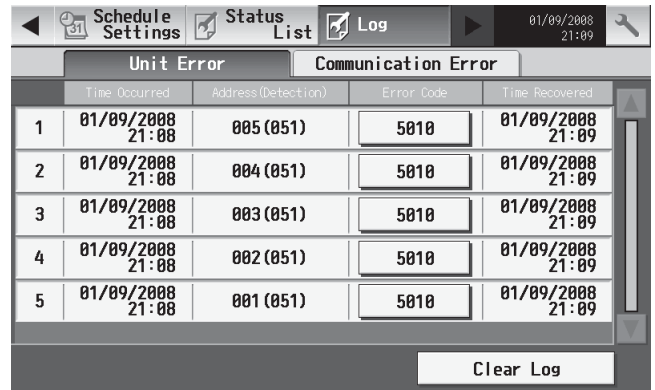

Error history display screen

7. Option

Model	Description
PAC-YG84UTB	Electrical box for AE-200E wall-embed installations
PAC-YG10HA-E	External input/output adapter for AE-200E/AG-150A/GB-50ADA-J/PAC-YG50ECA
PAC-YG86TK	Mounting kit for AE-200E/AE-50E installations inside the control panel

3-4. Centralized controller [AG-150A]



■ Functions

□:Each unit ○:Each group ●:Each block
 △:Each floor ◎:Collective ×:Not available

Item	Description	Operations	Display
ON/OFF	ON and OFF operation for the air conditioner units	○◎△●	○◎
Operation mode switching	Switches between Cool / Dry / Auto / Fan / Heat. (Group of LOSSNAY unit : automatic ventilation/ vent - heat interchange/ normal ventilation) Operation modes vary depending on the air conditioner unit. Auto mode is the City Multi R2 and WR2 series only.	○◎△●	○
Temperature setting	Range of temperature setting Cool/Dry : 19°C - 30°C (14°C - 30°C) / 67°F - 87°F (57°F - 87°F) Heat : 17°C - 28°C (17°C - 28°C) / 63°F - 83°F (63°F - 83°F) Auto : 19°C - 28°C (17°C - 28°C) / 67°F - 83°F (63°F - 83°F) ※ Range of temperature settings vary depending on model.	○◎△●	○
Sliding Temperature setting	This function shifts the preset temperature by the preset increment to reduce the temperature difference between the indoor and outdoor air temperatures during cooling operation. The maximum shifting temperature (+1°C, +2°C, +3°C, +4°C) can be set for each group.	○	○
Night setback setting	This function helps keep the indoor temperature in the temperature range while the units are stopped and during the time this function is effective.	○	○
Fan speed setting	Models with 5 air flow speed settings: Hi/Mid-1/Mid-2/Low, Auto Models with 4 air flow speed settings: Hi/Mid/Low, Auto Models with 2 air flow speed settings: Hi/Low Fan speed setting (including Auto) varies depending on the model.	○◎△●	○
Air flow direction setting	Air flow direction angles, 4-angle or 5-angle Swing, Auto ※1: Louver cannot be set. ※Air flow direction settings vary depending on the model.	※1 ○◎△●	○
Schedule operation	Weekly schedule can be set for each group of air conditioning units. Optimal startup setting is also available. ※2 By registering a license for AG-150A, weekly (5 types), annual, and current day scheduling function become available. The system follows either the current day, annual schedule, or weekly, which are in the descending order of overriding priority. Twenty-four events can be scheduled per day, including ON/OFF, Mode, Temperature Setting, Operation Prohibition, Vane Direction, and Fan Speed. Five types of weekly schedule (Summer/Winter) can be set. Settable items depend on the functions that a given air conditioning unit supports.	※2 ○◎△●	○
Permit / Prohibit local operation	Individually prohibit operation of each local remote control function (ON/OFF, Change operation mode, Set temperature, Reset filter). ※3: When the local remote controller inactivation command is received from the master system controller, "Disabled" appears in inverted display on the operation setting screen.	○◎△●	※3 ○
Indoor unit intake temperature	Measures the intake temperature of the indoor unit only when the indoor unit is operating.	×	○
Error	When an error is currently occurring on an air conditioner unit, the afflicted unit and the error code are displayed. ※4: When an error occurs, the "ON/OFF" LED flashes. The operation monitor screen shows the abnormal unit by flashing it. The error monitor screen shows the abnormal unit address, error code and source of detection. The error log monitor screen shows the time and date, the abnormal unit address, error code and source of detection.	×	※4 □◎
Test run	This operates air conditioner units in test run mode.	○◎△●	○
Ventilation equipment	The interlocked system settings can be performed by the master system controller. When setting the interlocked system, you can use the ventilation switch to switch the free plan LOSSNAY settings between "HI", "Low" and "Stop". When setting a group of only free plan LOSSNAY units, you can switch between "Normal ventilation", "Interchange ventilation" and "Automatic ventilation". ※5 When setting ventilation interlock with Mr.Slim units, the air conditioning and interlocked ventilation icon will display ON even when the interlocked LOSSNAY is operating by itself. (This will occur when used with the following M-NET adapter: PAC-SF48/50/60/70/80/81MA-E)	○◎△●	※5 ○
External input/output	By using accessory cables you can set and monitor the following. Input: By level signal: "Batch ON/OFF", "Batch emergency stop" By pulse signal: "Batch ON/OFF", "Enable/disable local remote controller" Output: "ON/OFF", "Error/Normal" ※6: Requires an external I/O cable (PAC-YG10HA; sold separately) and a commercially available external power supply.	◎※6	◎※6

NOTE: Depending on the versions of AG-150A, some of the functions may not be available. The external input/output terminal on AG-150A becomes unavailable when AG-150A is connected to PAC-YG50ECA. Use the terminals on PAC-YG50ECA in that case.

- A. The centralized controller of AG-150A combines Web function (optional), which enable the air conditioner system management on a PC browser screen. *1 The management even carried out at a long distance place via public telephone line or internet.
 *1 Microsoft® Internet Explorer® Ver. 6 or later by Microsoft Corporation is needed. (As of December 2012, operation with Internet Explorer® Ver.6~9 are tested) (Note: You must have operating system which complies with "Oracle® Java™ Plug-in". When using Internet Explorer® (64 bit), use Java™ Plug-in (64bit.) Microsoft®, Internet Explorer® is a registered trade mark of Microsoft Corporation US in the USA and other countries. Oracle® and Java™ are trademarks or registered trademarks of Oracle Corporation in the United States and/or other countries.
 Note: Connect AG-150A to a private network. Use a security device such as a VPN router when connecting the AG-150A to the Internet to prevent unauthorized access.
- B. Together with integrated centralized control software TG-2000A, and/or PI, DIDO controller, many optional functions like "Charging", "Peak-cut", "Energy saving", "General equipment management", "Scheduling" etc, can be carried out. Details, please refer to sections of TG-2000A and/or PI, DIDO controller, PLC software. *AG-150A connected with PAC-YG50ECA cannot be connected to the PLC (PAC-YG21CDA).
- C. One AG-150A can control maximum 50 units (including LOSSNAY). Up to 150 units (including LOSSNAY) can be controlled from one AG-150A connected with three expansion controllers. The integrated centralized control software TG-2000A can manage maximum 2000 units (including LOSSNAY). For details, refer to TG-2000A page.
- D. Taking advantage of AG-150A's Web functions, alarming E-mail containing address and error code can be sent to appointed E-mail address upon any fault happen at the air conditioner system. This could release standby personnel and save operation cost.
- E. AG-150A features a 9"-wide color LCD touch panel. The settings for air conditioning units can be changed by touching the corresponding icons on the display.
- F. The interlock-control option enables interlocked operations of air conditioning unit groups and the general equipment groups, based on the changes of status in the ON/OFF, Mode, or Error signals.(Can be set from the Web browser only)

■ External dimension

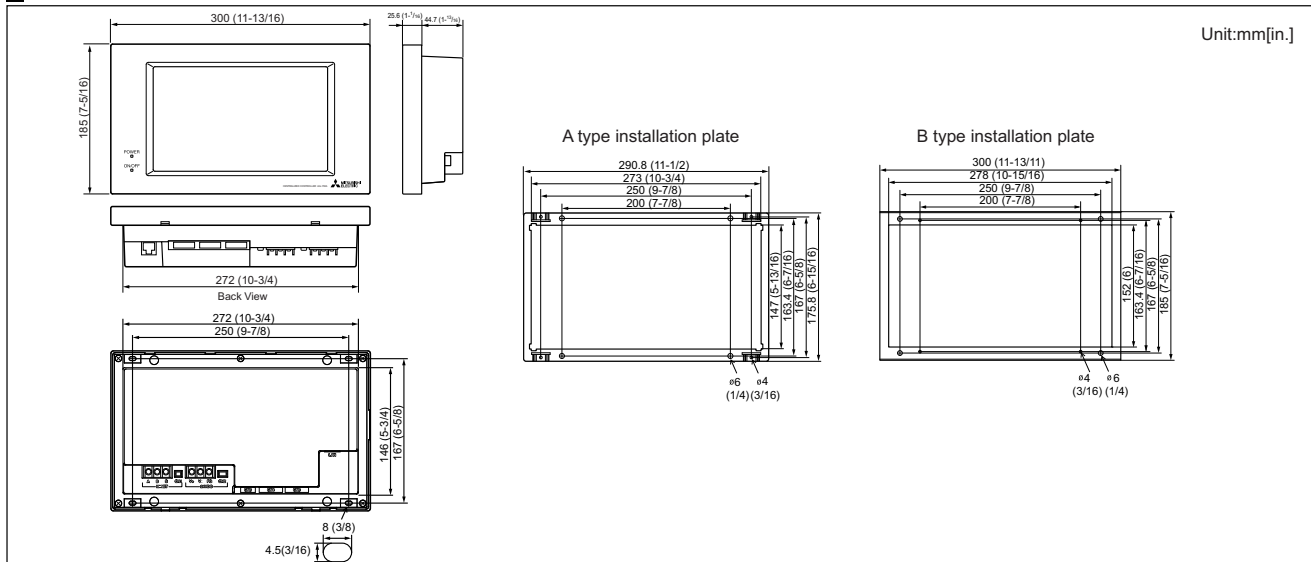

1. Power supply to AG-150A

AG-150A needs DC power supply of 24V and M-NET (24~32V); the former is for centralized control transmission use and the latter is for AG-150A's operating and LAN function use.

- (1). Power supply unit PAC-SC51KUA is the recommended power supplier for AG-150A. The basic scheme is as follows. For details, please refer to Power supply unit PAC-SC51KUA.

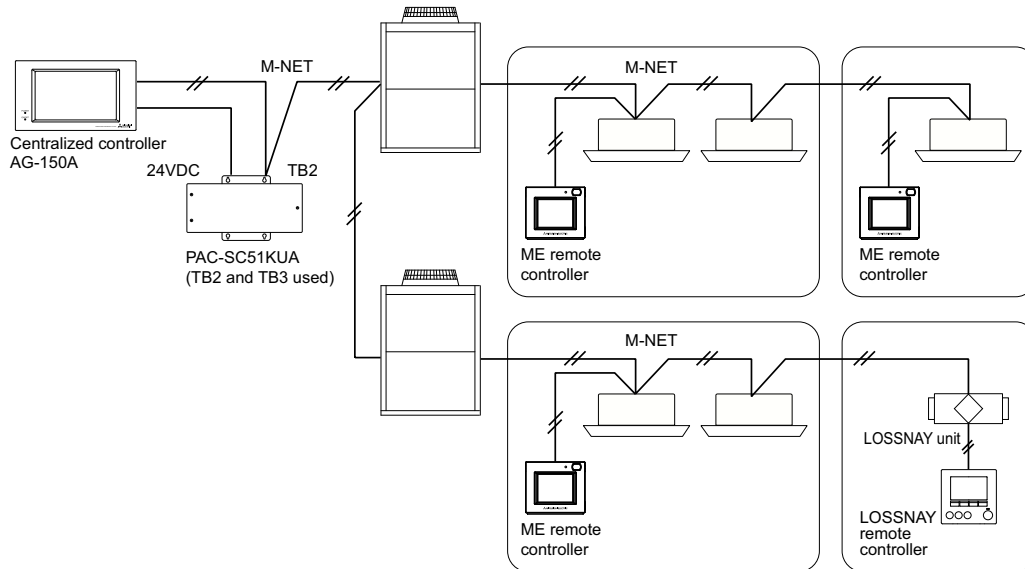

Fig. 1 AG-150A and PAC-SC51KUA basic scheme.

NOTE: For information about AG-150A connected with the expansion controller, refer to the following section(s):
3-8. Expansion Controller [PAC-YG50ECA]

2. External input/output usage

NOTE : When using the AG-150A connected with the expansion controller, use external input/output function of the expansion controller.

(1). External signal input function

※To use the external signal input, an external I/O adapter (PAC-YG10HA; sold separately) and an external power supply are required.

1). External input

Emergency stop/normal, ON/OFF and prohibit/permit of local remote controller operation can be controlled for all air conditioners being controlled by using a voltage (12VDC or 24VDC) contact signal from an external source. (Select with the function select setting.)

No	Function name	External signal input function	Remarks
1	Not in use	Do not use external input signal (factory setting)	_____
2	Emergency stop (Level signal)	Execute emergency stop/normal with level signal	The local remote controller ON/OFF operations, and the controller ON/OFF operation and prohibit/permit change operations will be prohibited during emergency stop. Timer operation will also be prohibited.
3	ON/OFF (Level signal)	Perform ON/OFF with level signal	The local remote controller ON/OFF operations, and the controller ON/OFF operations and prohibit/permit change operations will be prohibited. Timer operation will also be prohibited.
4	ON/OFF prohibit/permit (Pulse signal)	Perform ON/OFF, prohibit/permit with pulse signals.	Set the pulse width while the contact is ON to 0.5 to 1 sec.

* DIDO controller (PAC-YG66DCA) cannot be collectively run or stopped by using the external input function. But when [Emergency stop (Level signal)] is selected, DIDO controller (PAC-YG66DCA) can be collectively stopped by setting the appropriate switches on the DIDO controller.

2). Level signal and pulse signal (12VDC or 24VDC)

(A) Level signal

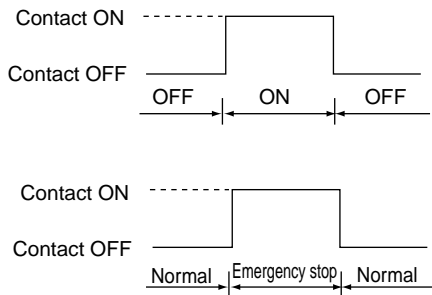

(B) Pulse signal

(Example) for ON/OFF

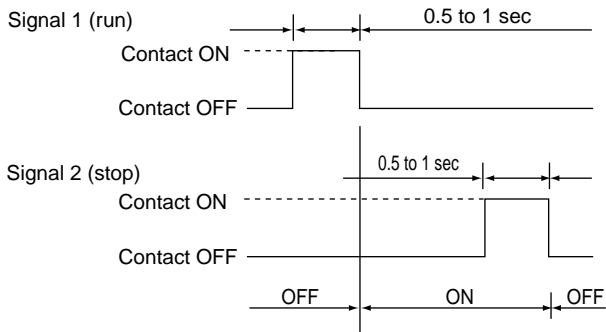

*The prohibit/permit input is the same.

3). External input specifications

CN5	Lead wire	Emergency stop/normal level signal	ON/OFF, level signal	ON/OFF, prohibit/enable pulse signal
No.5	Orange	Emergency stop/normal input	ON/OFF input	ON input
No.6	Yellow	Not used	Not used	OFF input
No.7	Blue	Not used	Not used	Local remote controller operation prohibit input
No.8	Gray	Not used	Not used	Local remote controller operation enable input
No.9	Red	External DC source "+ 12VDC" or "+ 24VDC"		

(A) For level signal

- ① When the emergency stop/normal signal is selected, the status will change from normal to emergency stop when the external input signal contact changes from OFF to ON, and will change from emergency stop to normal when the contact changes from ON to OFF. Air conditioning units that came to an emergency stop will remain stopped after the emergency stop is cancelled. Manually start up each unit to restore the previous operation.
- ② When the ON/OFF signal is selected, the status will change from OFF to ON when the external input signal contact changes from OFF to ON, and will change from ON to OFF when the contact changes from ON to OFF.

(B) For pulse signal

- ① Even if the ON signal is input during ON, the status will remain ON.
- ② If the local remote controller is prohibited, the ON/OFF operation mode and temperature setting operations by the local remote controller will be prohibited.
- ③ Set the pulse width (contact ON time) to 0.5 to 1 sec.

4). Recommended circuit example

(A) For level signal

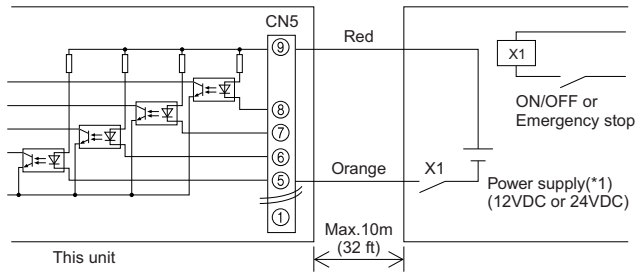

(B) For pulse signal

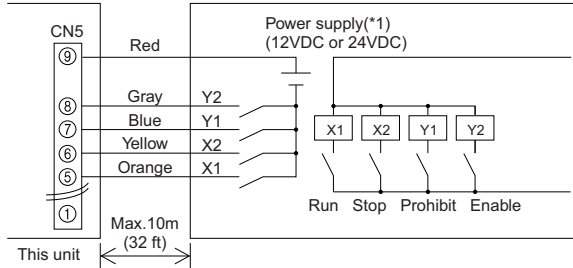

Use relays X1, X2, Y1, and Y2 that meet the following specifications.

- Contact rating
- Rated voltage $\geq 12\text{VDC}$
- Rated current $\geq 0.1\text{A}$
- Minimum applicable load $\leq 1\text{mA at DC}$

- ① The contact relay, DC power source, extension cable, etc., must be prepared separately at the site.
- ② The connection cable can be extended up to 10m (32 ft). (Use a 0.3mm² (AWG 22) or larger wire.)
- ③ Strip the extra cable near the connector, and securely insulate the exposed section with tape, etc.

(2). External signal output function

* To use the external signal input, an external I/O adapter (PAC-YG10HA; sold separately) and an external power supply are required.

1). External output

When one or more air conditioners are running, the " ON " signal will be output and if a malfunction occurs in one or more air conditioners, the " Malfunction " signal will be output.

2). External output specifications

CN5	Lead wire	Details of each terminal
No.1	Green	Common (External ground)
No.2	Black	ON/OFF*
No.3	Brown	Malfunction/normal

① The " ON " signal is output even while the " Malfunction " signal is being output.

- * The operation status of DIDO controller is not output.
- * Operation signal is output during an error.

3). Recommended circuit example

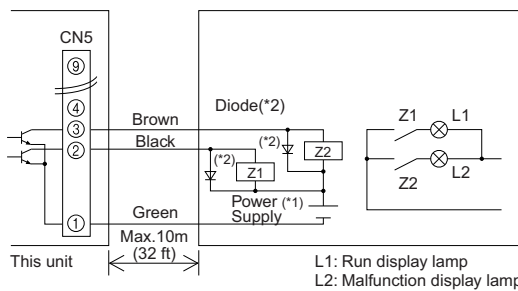

Use Z1 and Z2 relays that meet the following specifications.

- Operation coil
- Rated voltage : 12VDC, 24VDC
- Power Consumption: 0.9W or less
- (*1) Prepare a power supply separately according to the relay being used. (12VDC or 24VDC)
- (*2) Always insert a diode on both ends of the relay coil.

- ① Each element will turn on while ON operation or a malfunction occurs.
- ② The connection cable can be extended up to 10m (32 ft).
- ③ The relays, lamps, diodes and extension cables, etc, must be prepared separately at the site.

NOTE

* When connecting the external input/output cables to connector CN5 on the controller, punch out the knockout hole.

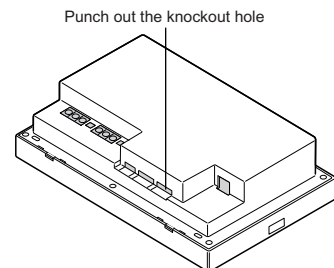

3. LAN connection function

When using the LAN connection function, connect the LAN cable to the LAN connector of this device.

- *Procure the LAN cable at the site, and use 100 BASE-TX Straight cable.
- *For a description of the IP address setting method, refer to Instruction Book.
- *LAN is 100 BASE-TX Specification.

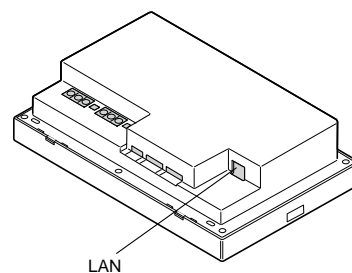

NOTE

- * Perform the LAN wiring before installation, and wire up to the body by the same method as wiring the M-NET transmission line.
 - * When a LAN is already connected, decide the IP address by consultation with the system administrator and connect to the LAN body after changing the IP address.
 - * Connect AG-150A to a private network.
- Use a security device such as a VPN router when connecting the AG-150A to the Internet to prevent unauthorized access.**
(If no security devices are installed, the operation settings may be changed by an unauthorized person without the knowledge of the user.)

4. Browser screens of AG-150A

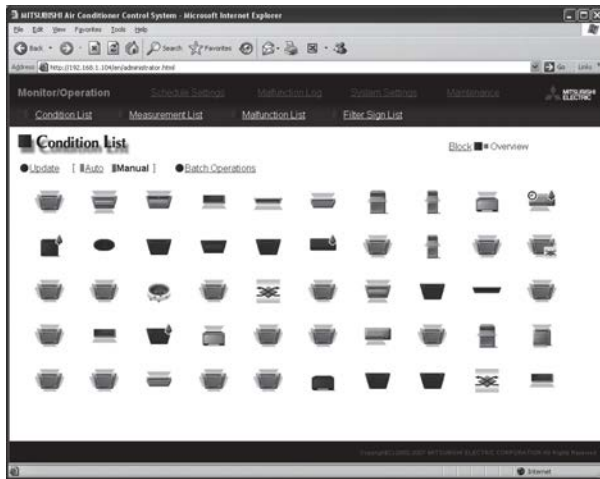

Condition List (Overview)

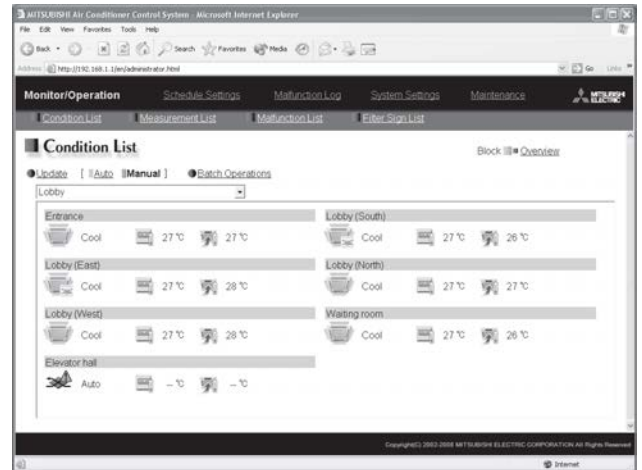

Condition List (Block)

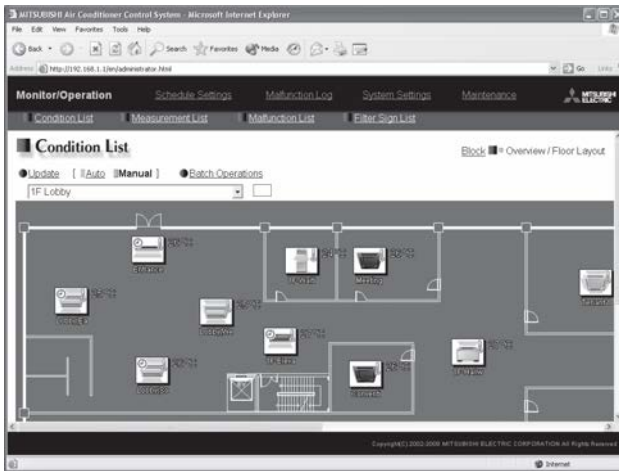

Condition List (Overview/Floor Layout)

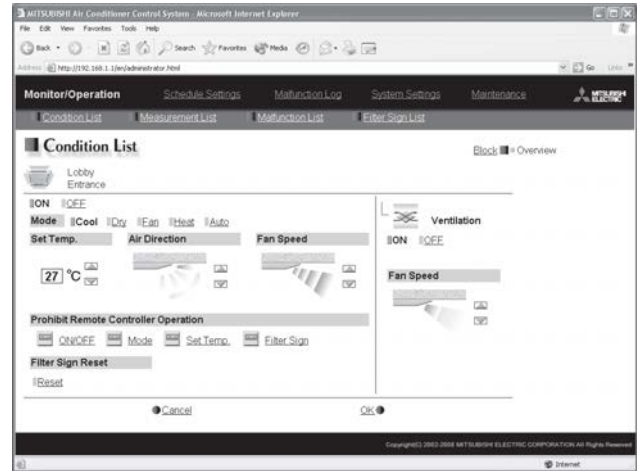

Operation

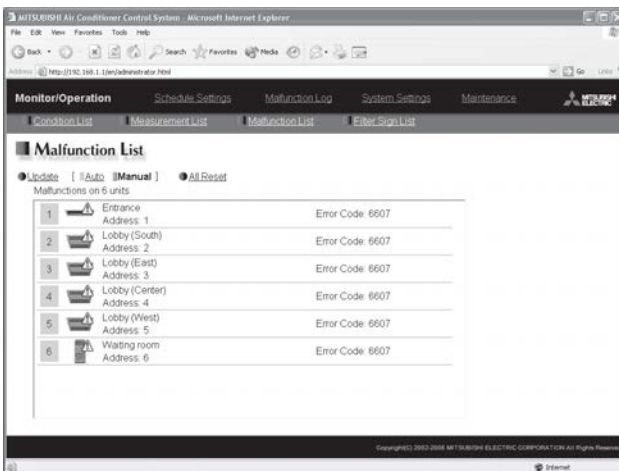

Malfunction List

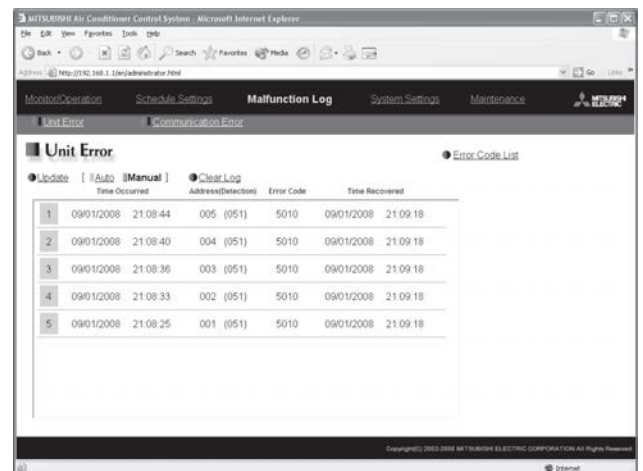

Malfunction Log

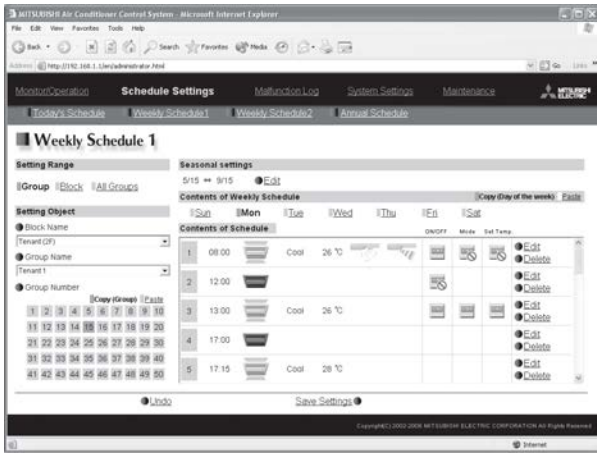

Weekly 1 Schedule

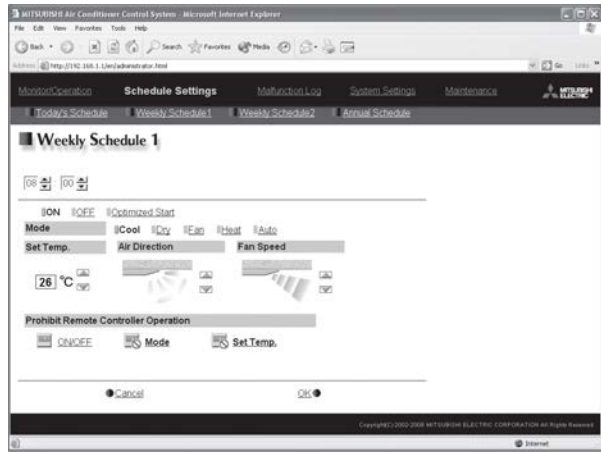

Weekly 1 Schedule (Setting screen)

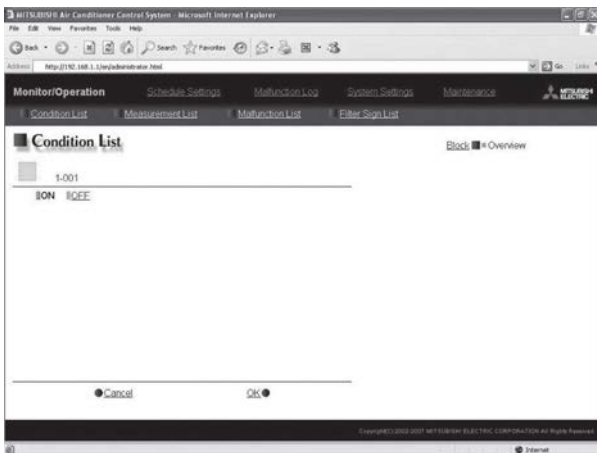

Operation (DIDO Controller)

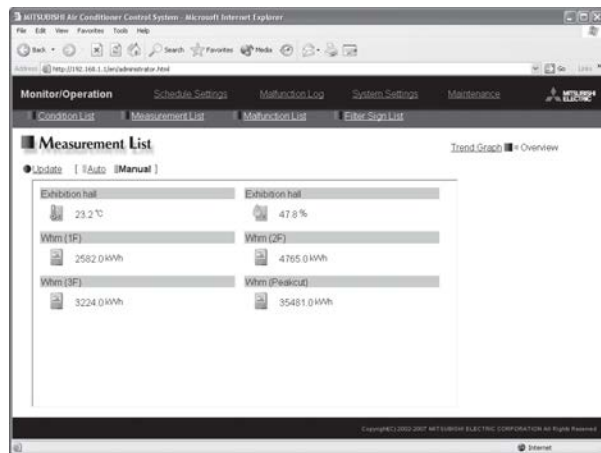

Measurement status monitor (temperature sensor/humidity sensor/measurement meter)

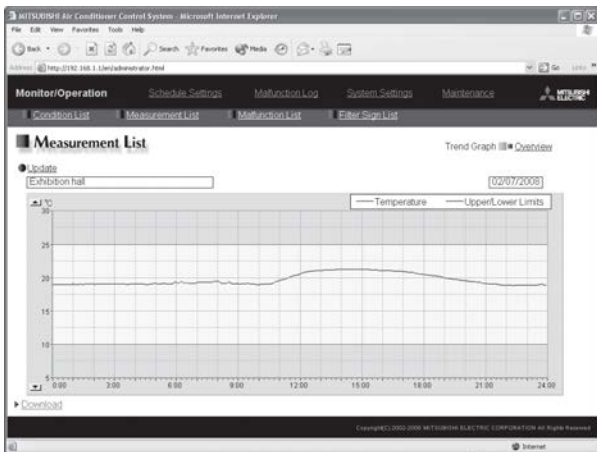

Trend Graph (temperature/humidity)

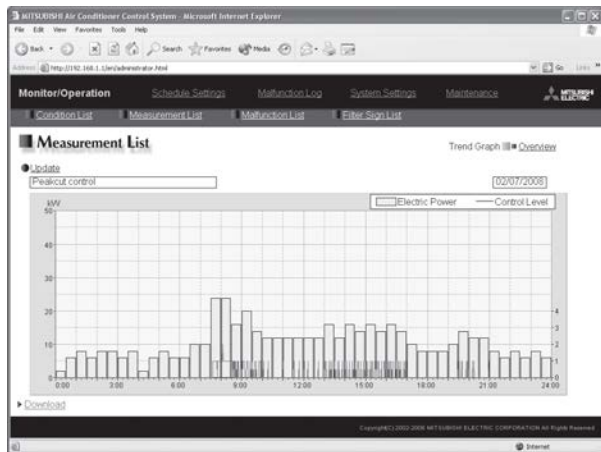

Trend Graph (Peak cut control)

5. Liquid crystal displays of AG-150A

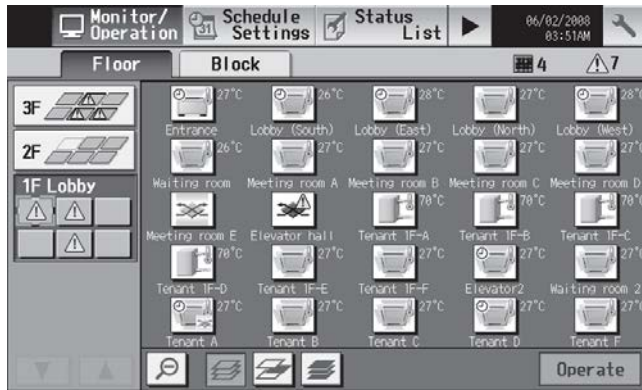

Floor screen

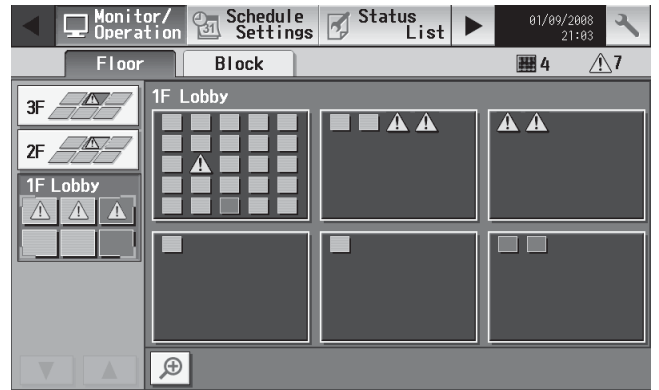

Floor screen (Zoom-out display)

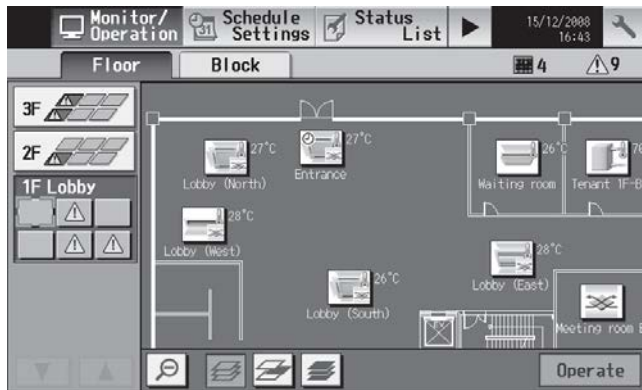

Floor layout screen

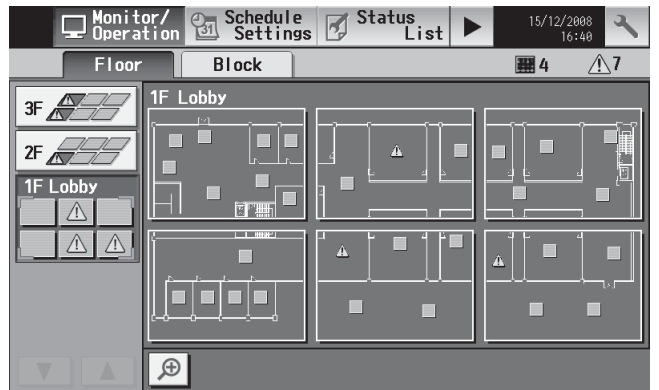

Floor layout screen (Zoom-out display)

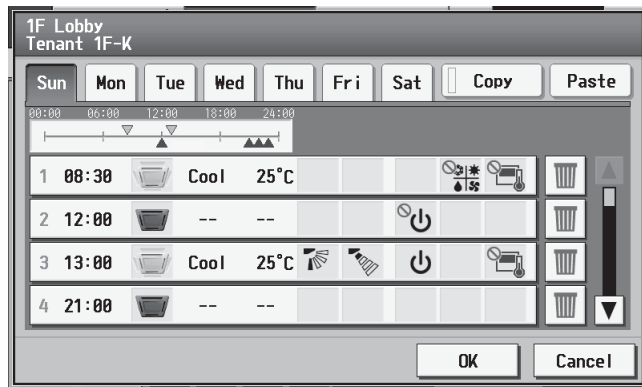

Weekly schedule setting screen

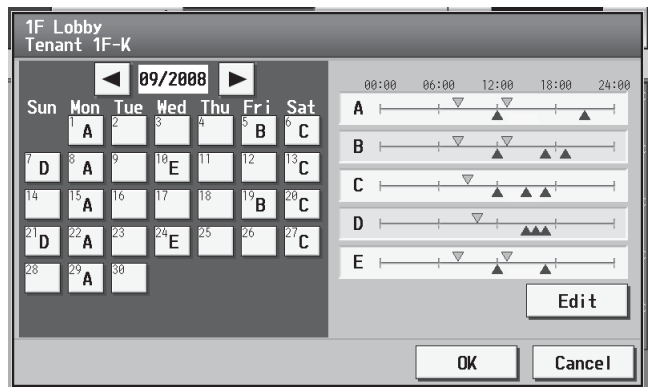

Annual schedule setting screen

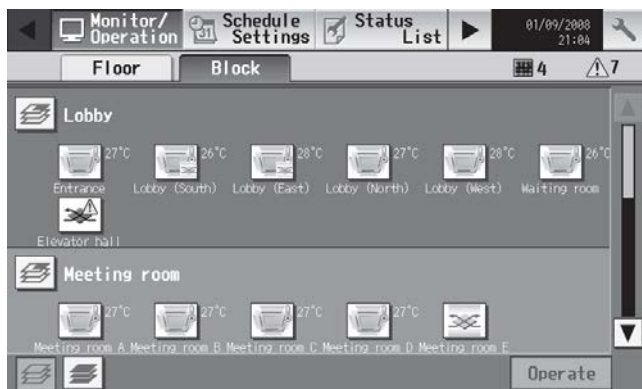

Block display screen

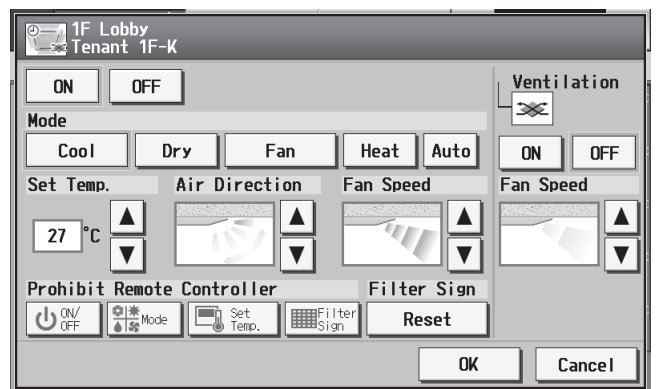

Operation screen

The screenshot shows the 'Malfunction' screen. At the top, there are navigation buttons: 'Schedule Settings', 'Status List', and 'Log'. The date and time are '01/09/2008 21:09'. Below the navigation is a 'Filter Sign' section with a '4' and a warning icon '14'. The main table lists malfunctions with columns for Group Name, Address, and Error Code. At the bottom, there is an 'All Reset' button.

	Group Name	Address	Error Code
1	1F Lobby Entrance	001	5010
2	1F Lobby Lobby (South)	002	5010
3	1F Lobby Lobby (East)	003	5010
4	1F Lobby Lobby (North)	004	5010
5	1F Lobby Lobby (West)	005	5010

Error status screen

The screenshot shows the 'Error history display screen'. At the top, there are navigation buttons: 'Schedule Settings', 'Status List', and 'Log'. The date and time are '01/09/2008 21:09'. Below the navigation is a 'Unit Error' and 'Communication Error' section. The main table lists error events with columns for Time Occurred, Address (Detection), Error Code, and Time Recovered. At the bottom, there is a 'Clear Log' button.

	Time Occurred	Address (Detection)	Error Code	Time Recovered
1	01/09/2008 21:08	005 (051)	5010	01/09/2008 21:09
2	01/09/2008 21:08	004 (051)	5010	01/09/2008 21:09
3	01/09/2008 21:08	003 (051)	5010	01/09/2008 21:09
4	01/09/2008 21:08	002 (051)	5010	01/09/2008 21:09
5	01/09/2008 21:08	001 (051)	5010	01/09/2008 21:09

Error history display screen

6. Option

Model	Description
PAC-YG81TB	Mounting attachment B type for AG-150A wall-mount installations
PAC-YG83UTB	Electric box for AG-150A wall-embed installations
PAC-YG85KTB	Mounting attachment A type for AG-150A/PAC-SC51KUA wall-mount installations
PAC-YG71CBL	Black surface cover for AG-150A
PAC-YG10HA-E	External input/output adapter for AE-200E/AE-50E/AG-150A/GB-50ADA-J/PAC-YG50ECA

3-5. Centralized controller [EB-50GU-J]

*EB-50GU-J is indicated as EB-50GU.



Dual Set Point

■ Functions

□:Each unit ○:Each group ●:Each block
 △:Each floor ◎:Collective ×:Not available

- A. The use of EB-50GU combined with AHC will allow the use of external signal, making it possible to use integrated control of air conditioning systems including third-party HVAC products.
- B. The centralized controller of EB-50GU combines Web function, which enable the air conditioner system management on a PC browser screen. *1. The management can even be carried out remotely.
 Microsoft® Internet Explorer 8.0
 Microsoft® Internet Explorer 9.0
 * Java™ execution environment is required. (Oracle® Java™ Plug-in Ver. 1.7.0_11)
 * Install Oracle® Java™ Plug-in that is appropriate for your operating system. When using a 64-bit Internet Explorer, install a 64-bit Java™ Plug-in.
 * The version of the Oracle® Java™ Plug-in can be verified by clicking [Java™] in the Control Panel.
 Note: Connect EB-50GU to a private network. Use a security device such as a VPN router when connecting the EB-50GU to Internet to prevent unauthorized access.
- C. One EB-50GU can control a maximum of 50 Indoor units (including LOSSNAY). The integrated centralized control software TG-2000A (*2) can manages maximum of 40 EB-50GU's and maximum of 2000 units (including LOSSNAY).
 *2 TG-2000A Ver.6.40 or later is required to control EB-50GU.
- D. Taking advantage of EB-50GU's Web functions, alarm E-mail containing address and error code can be sent to appointed E-mail address upon any fault occurring at the air conditioner system. This could release standby personnel and save operation costs.
- E. Together with integrated centralized control software TG-2000A, and/or other controllers (DIDO, AI, PI controller), many optional functions like "Charging", "Peak-cut", "Energy saving" etc, can be carried out.

Item	Description	Operations	Display
ON/OFF	Run and stop operation for the air conditioner units	○ ● ◎	○ ◎
Operation mode switching	The switch operation for the operation mode setting can be performed as a collective, per group, or per block. (Available modes depend on the model of indoor units or outdoor unit.) [Selectable operation mode for the indoor unit] COOL/DRY/FAN/AUTO/HEAT [Selectable operation mode for the independent ventilation] HEAT RECOVERY/BY-PASS/AUTO [Selectable operation mode for AIR TO WATER(PWFY)] HEATING/HEATING ECO/HOT WATER/ANTI-FREEZE/COOLING.	○ ● ◎	○
Fan speed setting	Models with 5 air flow speed settings: Hi/Mid-1/Mid-2/Low, Auto Models with 4 air flow speed settings: Hi/Mid/Low, Auto Models with 2 air flow speed settings: Hi/Low *Fan speed settings vary depending on the model.	○ ● ◎	○
Air flow direction setting	Air flow direction angles, 4-angle or 5-angle, Swing, Auto *1: Louver cannot be set. *Air flow direction settings vary depending on the model.	*1 ○ ● ◎	○
Ventilation equipment	The interlocked system settings can be performed by the master system controller. When setting the interlocked system, you can use the ventilation switch to switch the free plan LOSSNAY settings between "Hi", "Low" and "Stop". When setting a group of only free plan LOSSNAY units, you can switch between "Normal ventilation", "Interchange ventilation" and "Automatic ventilation".	○	○
Temperature setting	The temperature can be set within the following range. Cool/Drying: 19°C - 35°C/67°F - 95°F Heat: 4.5°C - 28°C/40°F - 83°F Auto (single set point): /19°C - 28°C/67°F - 83°F Auto (dual set points) [Cool]Same as the set temp. range for Cool mode. [Heat]Same as the set temp. range for Heat mode. *The settable temperature ranges and items vary depending on the indoor and outdoor unit models.	○ ● ◎	○
Temp range limit settings	Sets the temperature range for the local remote controllers. *2: The item and range that can be operated or monitored depend on the function of the indoor unit.	*2 ○	○
External Temperature Interlock	This function shifts the preset temperature by the preset increment to reduce the temperature difference between the indoor and outdoor air temperatures during cooling or heating operation. The maximum shifting temperature(±1°C, ±2°C, ±3°C, ±4°C) can be set for each group.	○	○
Schedule operation	Annual/Weekly (5 types)/Today schedule can be set for each group of air conditioning units. Optimized start setting is also available. *3: The system follows either the current day, annual schedule, or weekly, which are in the descending order of overriding priority. Twenty-four events can be scheduled per day, including ON/OFF Mode, Temperature Setting, Vane Direction, Fan Speed, and Operation Prohibition. Five types of weekly schedule(Summer/Winter/etc.) can be set. Settable items depend on the functions that a given air conditioning unit supports.	*3 ○ ● ◎	○
Night setback setting	The function keeps the indoor temperature in a set temperature range once the unit off and during the time this function is effective.	○	○
Permit / Prohibit local operation	Individually prohibit operation of each local remote control function (ON/OFF, Change operation mode, Set temperature, Reset filter sign, Air Direction, Fan speed, Timer). *4: The settable items vary depending on the models.	○ ● ◎	*4 ○
Indoor unit intake temperature	Measures the intake temperature of the indoor unit. *7: Displays the ambient temperature of either the return air temperature sensor on the indoor unit or the temperature sensor on the remote controller, whichever is selected on the indoor temperature display mode selection.	×	*7 ○
AHC status	Displays the status of input and output ports of each Advanced HVAC CONTROLLER (AHC).	×	□
Free Contact status	Displays the input/output status of the free contacts on the indoor units.	×	□
Measurement	Displays the temperature, humidity, and the reading of the watt-hour meter.	×	□
Outdoor Unit Status Monitor	Monitor the current outdoor unit status Data: Frequency (Compressor), high/low pressure (outdoor unit)	×	□
Energy Use Status	On the Energy Use Status screen, the energy-control-related status, such as electric energy consumption, operation time, and outdoor temperature, can be displayed in a graph. Operators can check the detailed status of given indoor units by specifying the date to display the data per group, block, or unit address.	×	□ ○ ●
Error	When an error is currently occurring on an air conditioner unit, the afflicted unit and the error code are displayed. *5: The operation monitor screen shows the abnormal unit by flashing it. The error monitor screen shows the abnormal unit address, error code and source of detection. The error log monitor screen shows the time and date, the abnormal unit address, error code and source of detection.	×	*5 □
Filter sign reset/ Filter sign	Filter sign can be reset for each group or block of indoor units. Filter sign indicates that the filter on the units in a given group is due for cleaning.	□ ○ ●	□ ○ ●
Interlock setting	Operation of indoor groups or general equipment can be interlocked by the change of state (ON/OFF, mode, error of indoor groups and general equipment). (EB-50GU will execute interlocking control depending on the interlocked setting.)	○	○
Test run	This operates air conditioner units in test run mode.	○ ○ △ ●	○
External input/output	By using accessory cables you can set the following. Input: By level signal: "Batch run/stop", "Batch emergency stop" By pulse signal: "Batch run/stop", "Enable/disable local remote controller" *6: Requires the external I/O cable (PAC-YG10HA) sold separately and external power supply. By using accessory cables you can monitor the following. Output: "Run/stop", "Error/Normal" *6: Requires the external I/O cable (PAC-YG10HA) sold separately and external power supply.	*6 ◎	×
M-NET	The "M-NET" LED lights, when M-NET power supply is turned ON. The LED blinks during M-NET communication.	×	◎ (LED)
Collective ON/OFF	All units can operate / stop with the switch. (For test run)	◎	—
Data back-up (PC)	The initial setting data, operation data (charge parameter, power consumption data) can be stored in the PC.	◎	—

Note: EB-50GU can control up to 50 units. EB-50GU is not connectable with PAC-YG50ECA. Available functions vary depending on the models of connected indoor units, outdoor units, and remote controllers.



Java™ is a registered trademark of Oracle and/or its affiliates.

External dimension

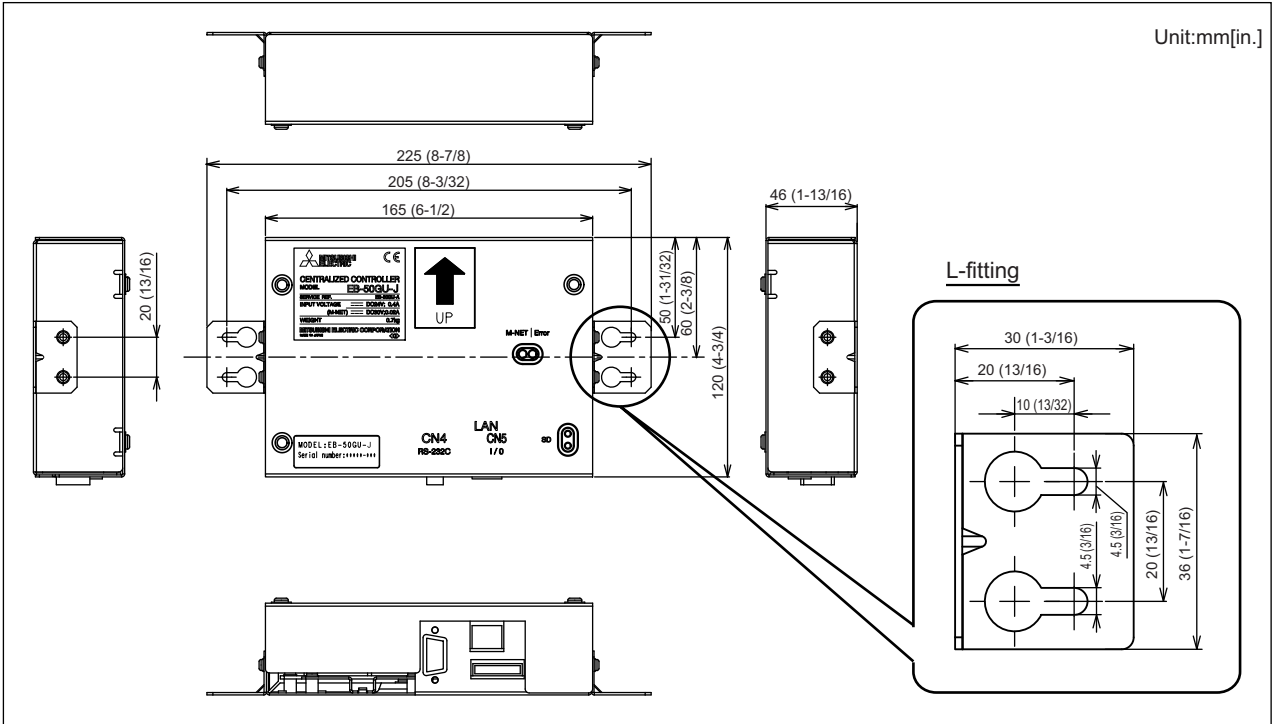

1. Power supply to EB-50GU

EB-50GU needs DC power supply of 24V and M-NET (24~32V); the former is for EB-50GU's operating and LAN function use and the latter is for centralized control transmission use.

- (1) Power supply unit PAC-SC51KUA is required for EB-50GU. The basic scheme is as follows. For details, please refer to Power supply unit PAC-SC51KUA.

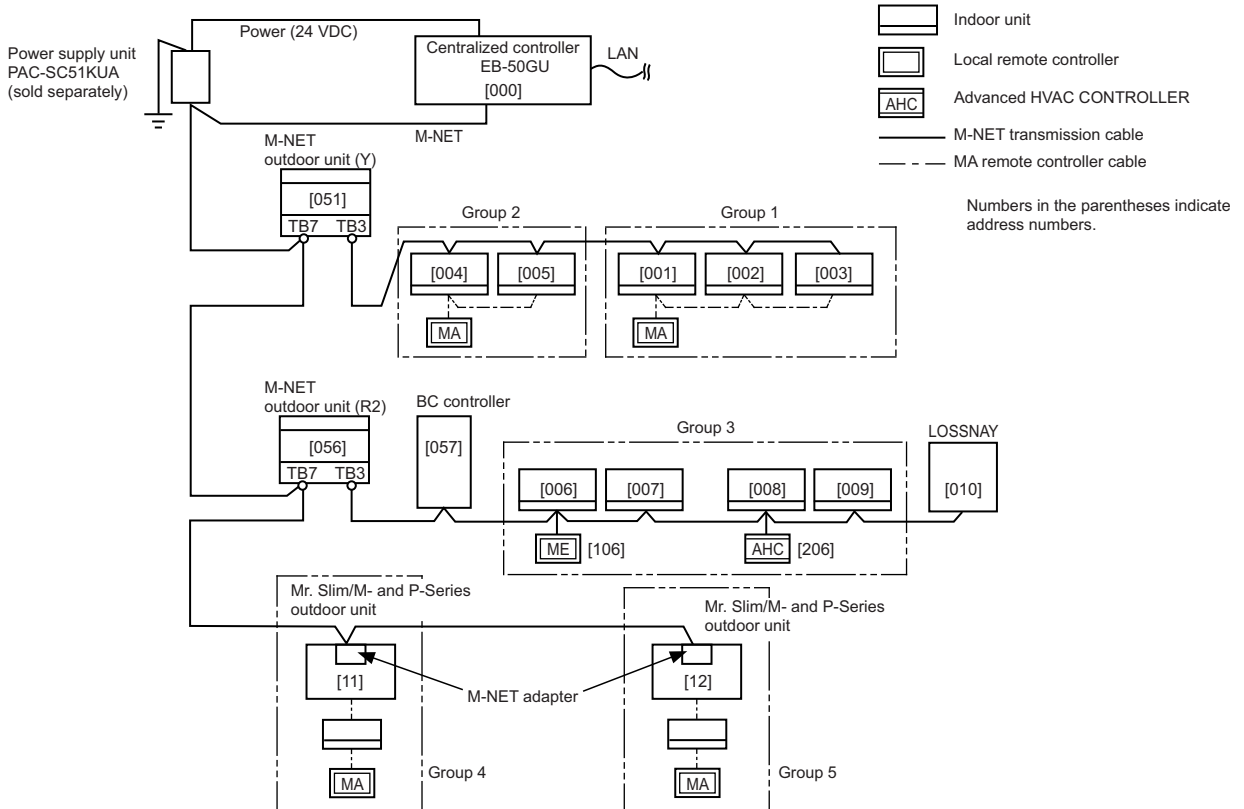

2. M-NET system setting example

(1) Setting example for connecting multiple M-NET system controllers

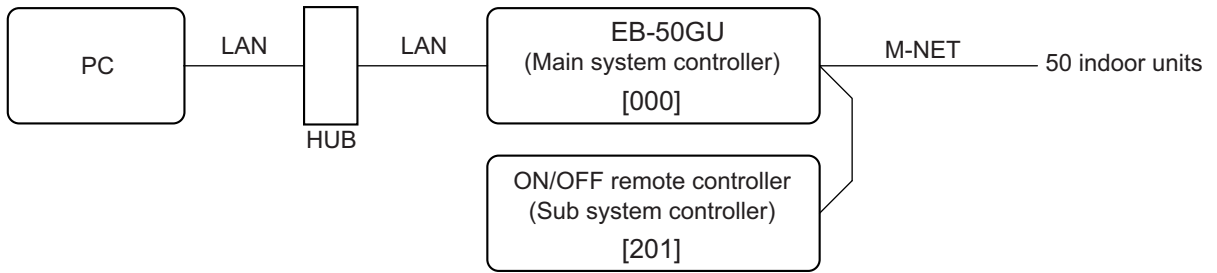

- Make the initial settings such as group settings and interlock settings on the Web browser. Refer to the Instruction Book (Web Browser for Initial Settings) for details.
- Designate a system controller within the system as the only controller from which operation prohibit setting can be made.

(2) Setting example for controlling Mr. Slim units (M-series/P-series models)

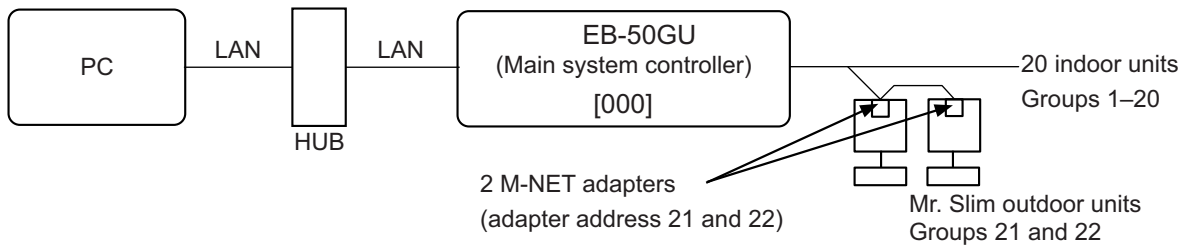

- An M-NET adapter (sold separately) is required to connect the Mr. Slim model of units to the M-NET.

3. External input/output

To use external input/output, a separately-sold external input/output adapter (PAC-YG10HA) and external power supply (12 or 24 VDC) are required.

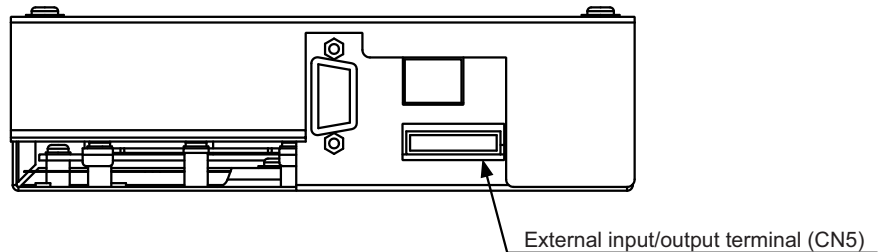

[External signal input function]

Using external contact signals (12 or 24 VDC), the following collective operations for all connected air conditioning units can be controlled: Emergency stop, ON/OFF operation, and Prohibit/Permit local remote controller operation.

(1) External signal input function setting

Setting mode	Description
Not in use (Factory setting)	External input signal will not be used.
Emergency Stop (Level signal)	Using a level signal, all the air conditioning units connected to the EB-50GU will be stopped collectively in emergency. During an emergency stop, the ON/OFF operation from the local remote controllers will be prohibited, and the ON/OFF operation and Prohibit/Permit settings on the EB-50GU will be prohibited. Scheduled operations will not be performed.
ON/OFF (Level signal)	Using a level signal, all the air conditioning units connected to the EB-50GU will be run or stopped collectively. The ON/OFF operation from the local remote controllers will be prohibited, and the ON/OFF operation and Prohibit/Permit settings on the EB-50GU will be prohibited. Scheduled operations will not be performed.
ON/OFF/Prohibit/Permit (Pulse signal)	Using a pulse signal, all the air conditioning units connected to the EB-50GU will be run or stopped collectively, or the operation from the local remote controllers will be prohibited or permitted collectively.

* General equipments connected via DIDO controller (PAC-YG66DCA) cannot be collectively run or stopped by using the external signal input function unless [Emergency Stop (Level signal)] is selected and relevant switches on the DIDO controller are set.

(2) External signal input specifications

CN5	Lead wire from PAC-YG10HA	Emergency Stop (Level signal)	ON/OFF (Level signal)	ON/OFF/Prohibit/Permit (Pulse signal)
No. 5	Orange	Emergency stop signal, Normal operation signal	ON signal, OFF signal	ON signal
No. 6	Yellow	—	—	OFF signal
No. 7	Blue	—	—	Prohibit signal
No. 8	Gray	—	—	Permit signal
No. 9	Red	External power supply (+12 or +24 VDC)		

(3) Level signal and pulse signal

(A) Level signal

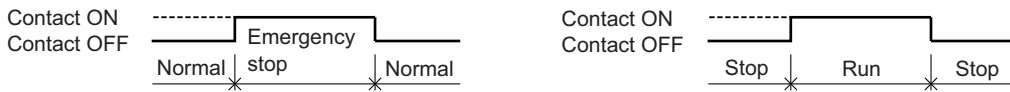

- 1) If "Emergency stop (Level signal)" is selected, the air conditioning units in normal operation will stop when the contact turns on. Even when the contact turns off, these units will remain stopped. They must be started up manually after the emergency stop is reset.
- 2) If "ON/OFF (Level signal)" is selected, the air conditioning units that are stopped will start operation when the contact turns on. Conversely, the units that are in operation will stop when the contact turns off.

(B) Pulse signal

(Example) ON/OFF

(Example) Prohibit/Permit

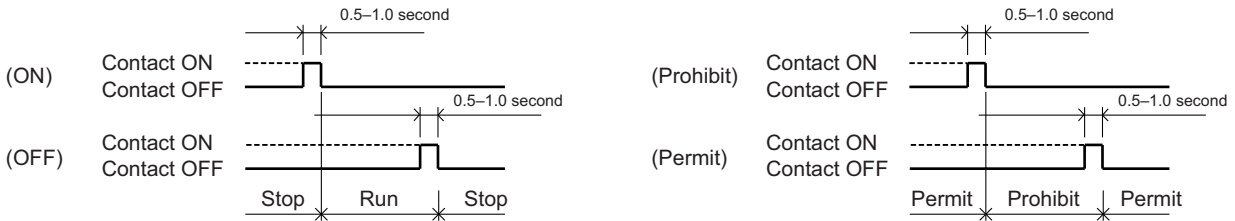

- 1) If input pulse signal is the same as the current operation status of the air conditioning units, no status change will occur. (For example, if an ON signal is input while the air conditioning units are in operation, the units will continue their operation.)
- 2) If the operation from the local remote controller is prohibited, ON/OFF status, operation mode, or temperature setting cannot be changed and filter sign cannot be reset from the local remote controller.
- 3) The pulse width (contact ON) should be between 0.5 and 1.0 second.

(4) Recommended circuit

(A) Level signal

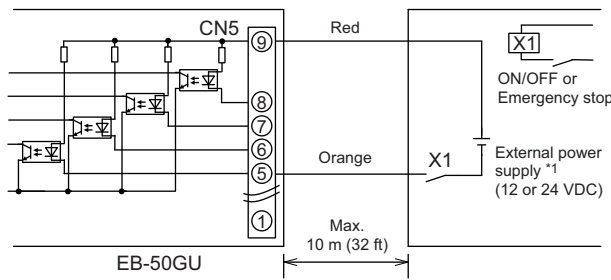

Use relays X1, X2, Y1, and Y2 that meet the following specifications.

Contact rating
 Rated voltage: 12 VDC or above
 Rated current: 0.1 A or above
 Minimum applied load: DC 1 mA

*1 Select an external power supply suitable for the relays used. (12 or 24 VDC)
 Connect the external power supply in the correct polarity to input and output the signals.
 Connect ⑤ – ⑧ (see the figure at left) to the negative side.

(B) Pulse signal

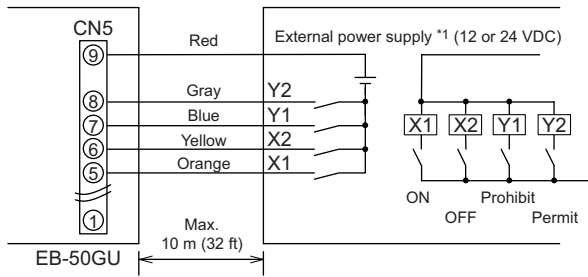

Important

- Be sure to use an external power supply (12 or 24 VDC) to avoid malfunctions.
- Connect the external power supply in the correct polarity to avoid malfunctions.

Note

- The relays, external power supply, and extension cables are field supplied.
- The total length of the lead wire and extension cable should not exceed 10 m (32 ft). (Use an extension cable of 0.3 mm² or thicker.)
- Cut the excess cable near the connector, and insulate the end of unused cable with tape.

[External signal output function]

An ON signal is output when one or more units are in operation, and Error signal is output when one or more units are in error.

(1) External signal output specifications

CN5	Lead wire from PAC-YG10HA	Signal
No. 1	Green	Common ground for external output (Ground for external power supply)
No. 2	Black	ON signal*, OFF signal
No. 3	Brown	Error signal, Normal signal

* The operation status of general equipments (via DIDO controller (PAC-YG66DCA)) will not be output.
 * The ON signal will be output even during an error.

(2) Recommended circuit

Relay-driven circuit

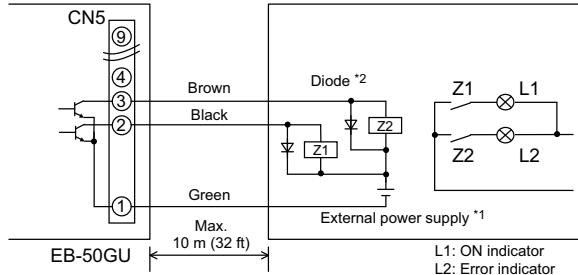

Use relays Z1 and Z2 that meet the following specifications.

Operation coil
 Rated voltage: 12 or 24 VDC
 Power consumption: Max. 0.9 W

*1 Select an external power supply suitable for the relays used. (12 or 24 VDC)
 Connect the external power supply in the correct polarity to input and output the signals.
 Connect ① (shown in the figure at left) to the negative side.
 *2 Use a diode at both ends of the relay coils.

Important

- Be sure to use an external power supply (12 or 24VDC) to avoid malfunctions.
- Connect the external power supply in the correct polarity to avoid malfunctions.
- Do not connect the external power supply without relays being connected to the controller (no load).

Note

- The relays, lamps, external power supply, diodes, and extension cables are field supplied.
- The total length of the lead wire and extension cable should not exceed 10 m (32 ft). (Use an extension cable of 0.3 mm² or thicker.)
- Each element will turn on during operation and when an error occurs.

4. Connecting LAN cable

Connect the LAN cable to the LAN port on the EB-50GU.

- The LAN cable is field supplied. Use a category 5 or above straight LAN cable.
- Use a switching HUB.
- The maximum distance between the switching HUB and EB-50GU is 100 m (328 ft).

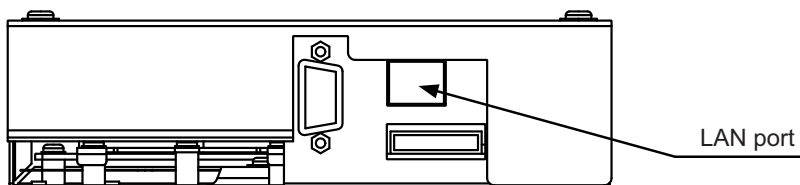

Note

- LAN must be installed before the unit installation. Route the LAN cable to the EB-50GU in the same way as the M-NET transmission cables.
- Leave enough space around the LAN port on the EB-50GU to allow for the connection of the cables. Refer to Installation and Instructions Manual.
- When connecting the EB-50GU to an existing LAN, consult the system administrator to decide the IP address. The IP address can be changed with the dipswitch or from the Web browser.
- To prevent unauthorized access, always use a security device such as a VPN router when connecting the EB-50GU to the Internet.

5. Browser screens of EB-50GU

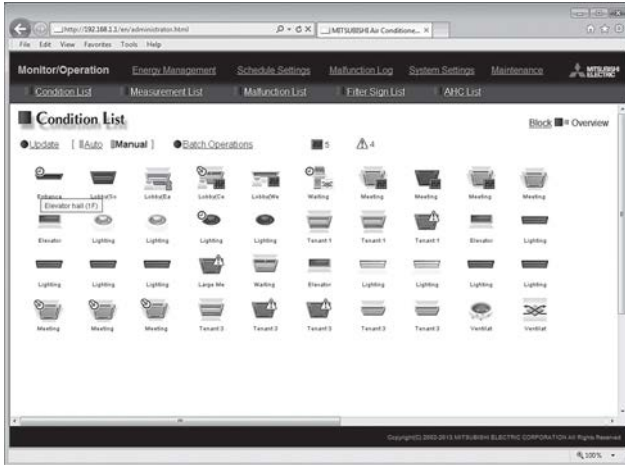

Condition List (Overview)

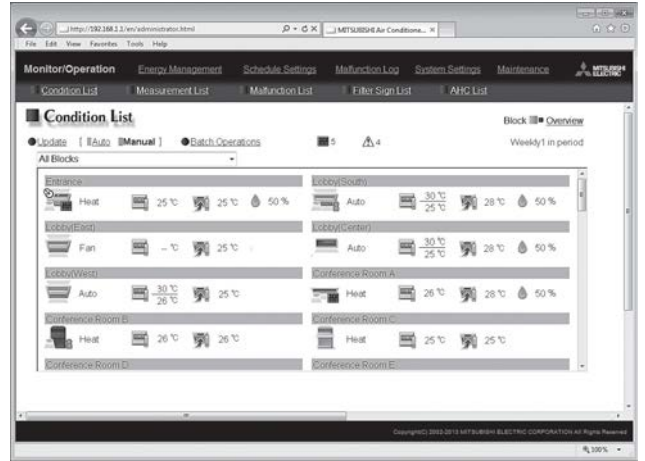

Condition List (Block)

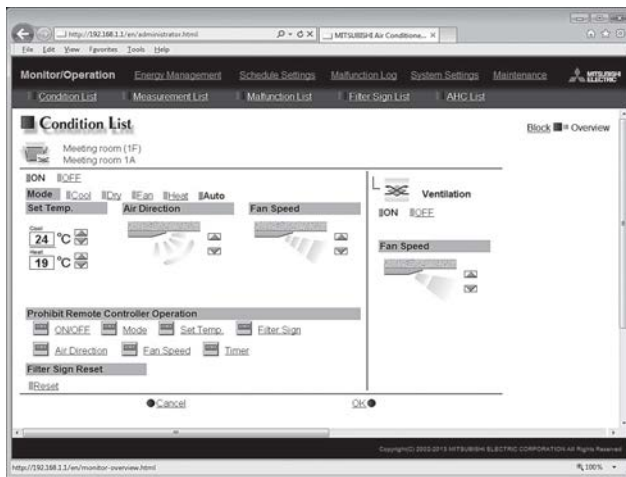

Operation

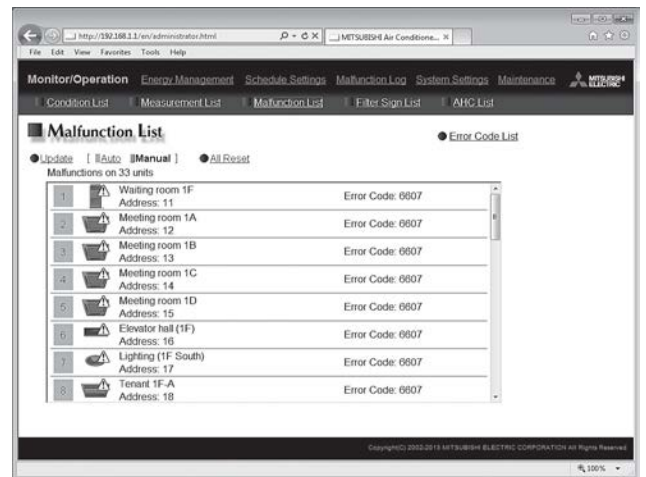

Malfunction List

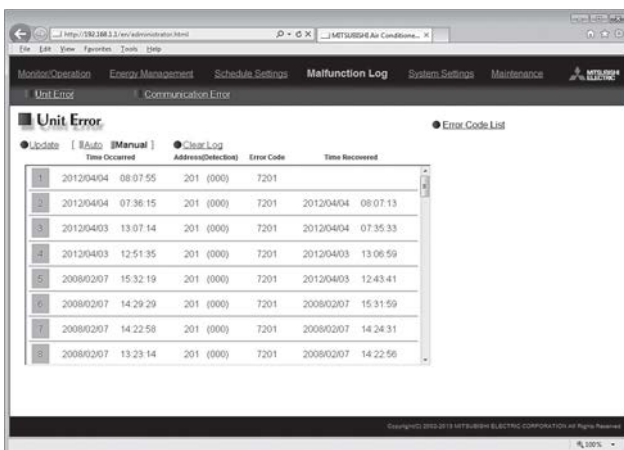

Malfunction Log

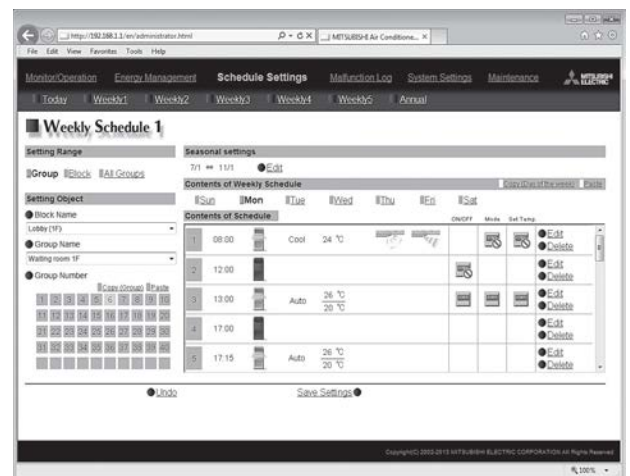

Weekly 1 Schedule



Operation (DIDO Controller)

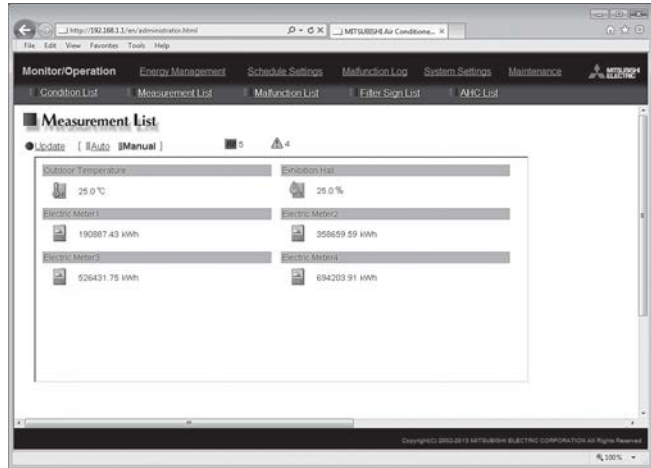

Measurement status monitor (temperature sensor/humidity sensor /measurement meter)

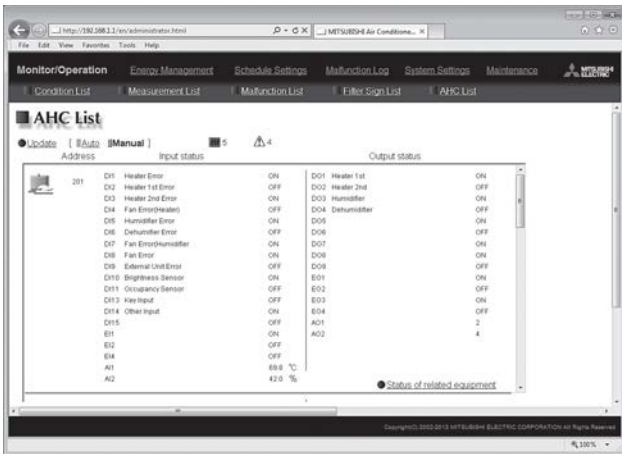

Advanced HVAC CONTROLLER Status monitor

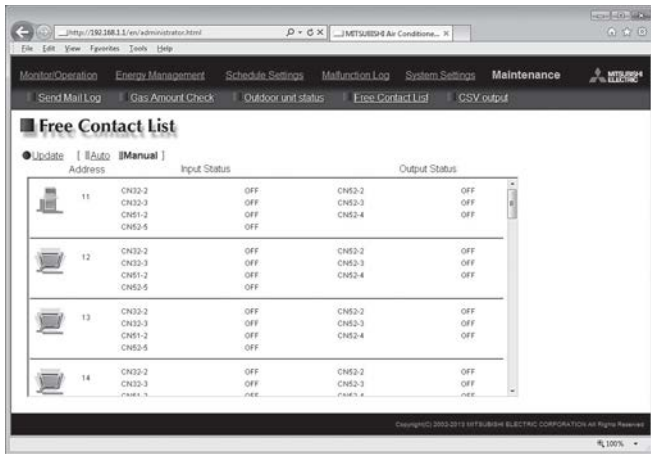

Free Contact Status monitor

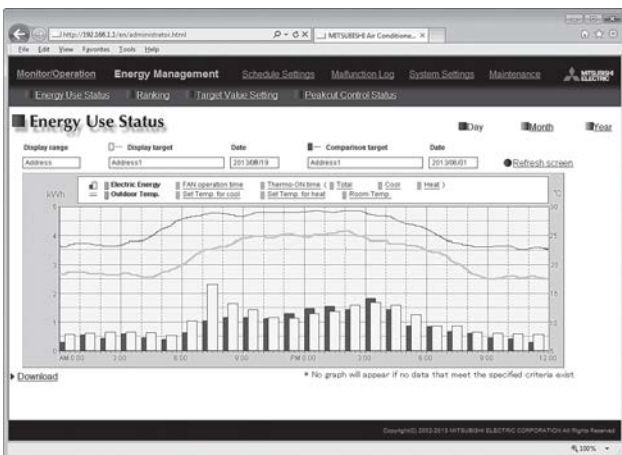

Energy Management monitor (Energy use status)

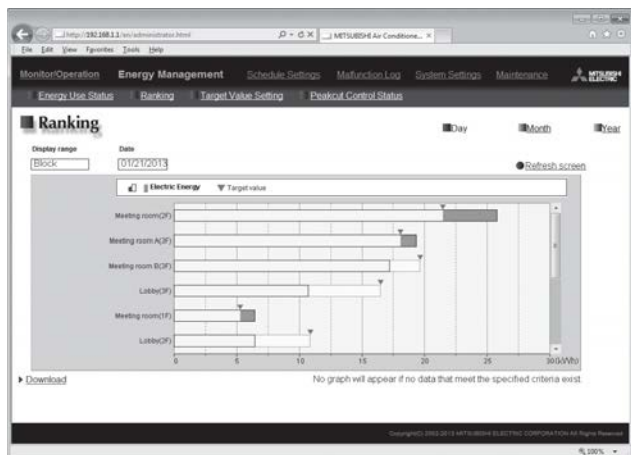

Energy Management monitor (Ranking)

3-6. Centralized controller [GB-50ADA-J]

*GB-50ADA-J is indicated as GB-50ADA.



■ Functions

□ :Each unit ○ :Each group ● :Each block
 △ :Each floor ◎ :Collective × :Not available

- A. The central controller of GB-50ADA combines Web function, which enable the air conditioner system management on a PC browser screen. *1. The management can even be carried out at a long distance place via public telephone line or internet.
 - *1 Microsoft® Internet Explorer® Ver. 6 or later by Microsoft Corporation is recommended. (As of December 2012, operation with Internet Explorer® Ver.6~9 are tested) (Note: You must have operating system which complies with "Oracle® Java™ Plug-in". When using Internet Explorer® (64 bit), use Java™ Plug-in (64bit).)
 - Microsoft®, Internet Explorer® is a registered trade mark of Microsoft Corporation US in the USA and other countries. Oracle® and Java™ are trademarks or registered trademarks of Oracle Corporation in the United States and/or other countries.
- Note: Connect GB-50ADA to a private network. Use a security device such as a VPN router when connecting the GB-50ADA to Internet to prevent unauthorized access.
- B. One GB-50ADA can control maximum 50 Indoor units(including LOSSNAY). The integrated centralized control software TG-2000A (*2) can manage maximum 40 GB-50ADAs and maximum of 2000 units (including LOSSNAY).
 - *2 TG-2000A Ver.6.30 or later is required to control GB-50ADA.
- C. GB-50ADA has a built-in function to supply power to the M-NET transmission line. (power supply coefficient: 6)
- D. Taking advantage of GB-50ADA's Web functions, alarming E-mail containing address and error code can be sent to appointed E-mail address upon any fault happen at the air conditioner system. This could release standby personnel and save operation cost.
- E. Together with integrated centralized control software TG-2000A, and/or other controller (DIDO, AI, PI controller), many optional functions like "Charging", "Peak-cut", "Energy saving" etc, can be carried out.
- F. The interlock-control option enables interlocked operations of air conditioning unit groups and the general equipment groups, based on the changes of status in the ON/OFF, Mode, or Error signals.

Item	Description	Operations	Display
ON/OFF	Run and stop operation for the air conditioner units	○ ● ◎	○ ◎
Operation mode switching	Switches between Cool / Dry / Auto / Fan / Heat. (Group of LOSSNAY unit: automatic ventilation/ vent - heat interchange/ normal ventilation) Operation modes vary depending on the air conditioner unit. Auto mode is only for City Multi R2 and WR2 series.	○ ● ◎	○
Fan speed setting	Models with 5 air flow speed settings: Hi/Mid-1/Mid-2/Low, Auto Models with 4 air flow speed settings: Hi/Mid/Low, Auto Models with 2 air flow speed settings: Hi/Low *Fan speed settings vary depending on the model.	○ ● ◎	○
Air flow direction setting	Air flow direction angles, 4-angle or 5-angle Swing, Auto *1: Louver cannot be set. *Air flow direction settings vary depending on the model.	*1 ○ ● ◎	○
Ventilation equipment	The interlocked system settings can be performed by the master system controller. When setting the interlocked system, you can use the ventilation switch to switch the free plan LOSSNAY settings between "Hi", "Low" and "Stop". When setting a group of only free plan LOSSNAY units, you can switch between "Normal ventilation", "Interchange ventilation" and "Automatic ventilation".	○	○
Temperature setting	Range of temperature setting Cool/Dry : 19°C - 30°C (14°C - 30°C) / 67°F - 87°F (57°F - 87°F) Heat : 17°C - 28°C (17°C - 28°C) / 63°F - 83°F (63°F - 83°F) Auto : 19°C - 28°C (17°C - 28°C) / 67°F - 83°F (63°F - 83°F) () in case of using middle-temperature on PEFY, PEFY-VML/MR/VMS /VMH-by setting DipSW7-1 to ON. Yet, PEFY-P-VMH-E-F is excluded. * Range of temperature settings vary depending on model.	○ ● ◎	○
Sliding temperature setting	This function shifts the preset temperature by the preset increment to reduce the temperature difference between the indoor and outdoor air temperatures during cooling operation. The maximum shifting temperature(+1°C,+2°C,+3°C,+4°C)	○	○
Schedule operation	Annual/Weekly (5 types)today schedule can be set for each group of air conditioning units. Optimized startup setting is also available. *2: The system follows either the current day, annual schedule, or weekly, which are in the descending order of overriding priority. Twenty-four events can be scheduled per day, including ON/OFF, Mode, Temperature Setting, Operation Prohibition, Vane Direction, and Fan Speed. Five types of weekly schedule(Summer/Winter) can be set. Settable items depend on the functions that a given air conditioning unit supports.	*2 ○ ● ◎	○
Night setback setting	The function keeps the indoor temperature in a set temperature range once the unit stops and during the time this function is effective.	○	○
Permit / Prohibit local operation	Individually prohibit operation of each local remote control function (Start/Stop, Change operation mode, Set temperature, Reset filter). *3: When the local remote controller inactivation command is received from the master system controller, "Disabled" appears in inverted display on the operation setting screen.	○ ● ◎	*3 ○
Indoor unit intake temperature	Measures the intake temperature of the indoor unit only when the indoor unit is operating.	×	○
Error	When an error is currently occurring on an air conditioner unit, the afflicted unit and the error code are displayed. *4: The operation monitor screen shows the abnormal unit by flashing it. The error monitor screen shows the abnormal unit address, error code and source of detection. The error log monitor screen shows the time and date, the abnormal unit address, error code and source of detection.	×	*4 □
Interlock setting	Operation of indoor groups or general equipment can be interlocked by the change of state (ON/OFF, mode, error of indoor groups and general equipment). (GB-50ADA will execute interlocking control depending on the interlocked setting.)	○	○
Test run	This operates air conditioner units in test run mode.	○ ◎ △ ●	○
External input/output	By using accessory cables you can set the following. Input: By level signal: "Batch start/stop", "Batch emergency stop" By pulse signal: "Batch start/stop", "Enable/disable local remote controller" *5: Requires the external I/O cable (PAC-YG10HA) sold separately and external power supply. By using accessory cables you can monitor the following. Output: "Start/stop", "Error/Normal" *5: Requires the external I/O cable (PAC-YG10HA) sold separately and external power supply.	*5 ◎	×
M-NET	The "M-NET" LED lights, when M-NET power supply is turned ON. The LED blinks during M-NET communication.	×	◎ (LED)
Collective ON/OFF	All units can operate / stop with a DIP switch. (For test run)	◎	◎ (7 SEG)
Data back-up (USB memory)	The initial setting data, operation data (charge parameter, power consumption data (*6)) can be stored to a USB memory. Initial setting data can be read from USB memory. *6: GB-50ADA Ver.2.45 or later	◎	—

Note: GB-50ADA can control up to 50 units. GB-50ADA is not connectable with PAC-YG50ECA. License registration is necessary to perform each function on GB-50ADA.

■ External dimension

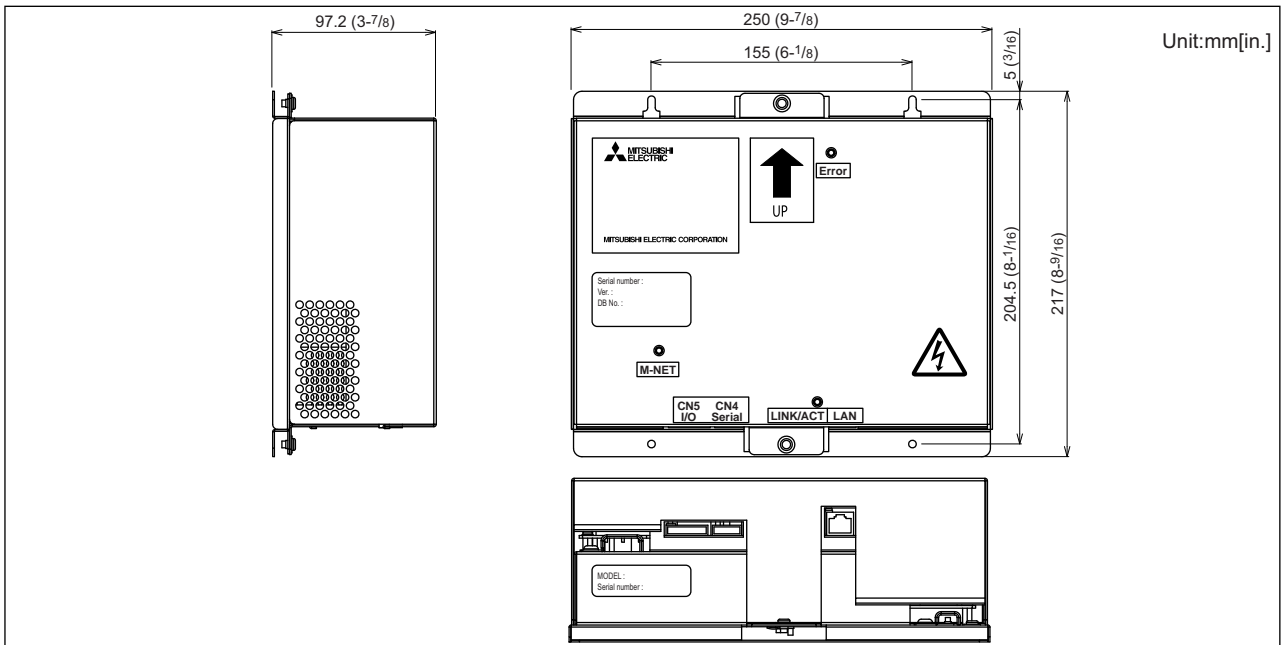

1. M-NET power supply

GB-50ADA has a built-in function to supply power to the M-NET transmission line. (power supply coefficient: 6)
 When power is supplied from GB-50ADA, the types of system controllers listed in the table below are connectable.

	System controller		M-NET remote controller
	Advanced touch controller	ON/OFF remote controller	Smart ME Controller
Power consumption coefficient	4	1	0.5
Connectable units	1 unit	6 units	12 units

Note

- AG-150A and GB-50ADA cannot be used in the same M-NET system.
- Supplying power from the Outdoor unit or the power supply unit, it is necessary to replace power supply switch connector CN40 with CN41.(Factory default is CN40.)
- **When connecting both GB-50ADA and BAC-HD150 (BM ADAPTER) to the same M-NET system, certain restrictions apply. Consult your dealer for details.**

2. System configuration

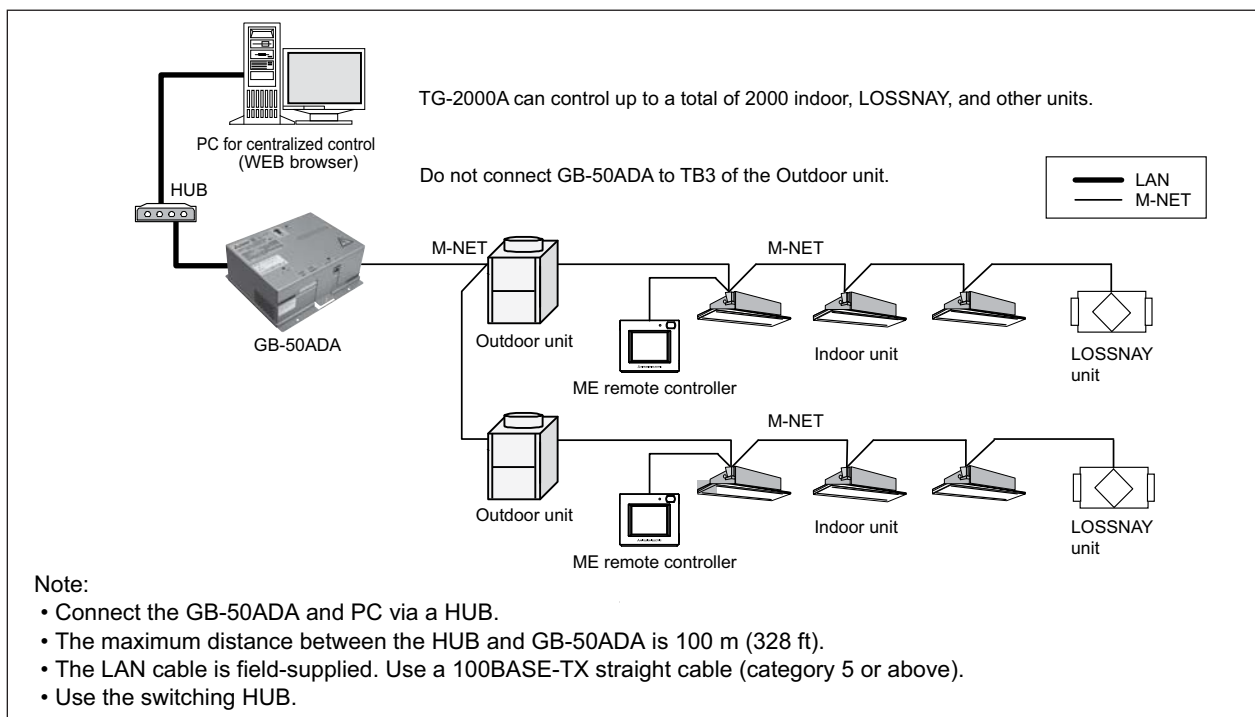

3. External input/output usage

(1). External signal input function

* To use the external signal input, a separately-sold external input/output adapter (PAC-YG10HA) and external power supply are required.

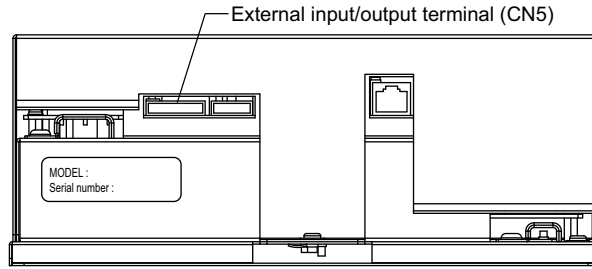

1). External input signal function setting (to be set from the web browser for Initial settings)

External contact signal (12VDC or 24VDC) can be used to send signals indicating the following status of all air conditioning units that are controlled by the controller: Emergency stop/Normal, Run/Stop, and local remote controller operation Prohibit/Permit.

No.	External input signal function	Notes
1	External input signal will not be used. (factory setting)	—
2	Emergency stop/Normal (level signal)	During the emergency stop, the Run/Stop mode cannot be changed from the local remote controller, and the Run/Stop mode and Prohibit/Permit settings cannot be changed from the GB-50ADA. Timer setting will be ignored.
3	Run/Stop (level signal)	The Run/Stop mode cannot be changed from the local remote controller, and the Run/Stop mode and Prohibit/Permit settings cannot be changed from the GB-50ADA. Timer setting will be ignored.
4	Run/Stop, Prohibit/Permit (pulse signal)	The pulse width (contact ON) should be between 0.5 and 1 second.

* DIDO controller (PAC-YG66DCA) cannot be collectively run or stopped by using the external input function. But when [Emergency stop (Level signal)] is selected, DIDO controller (PAC-YG66DCA) can be collectively stopped by setting the appropriate switches on the DIDO controller.

2). Level signals and pulse signals

(A) Level signals

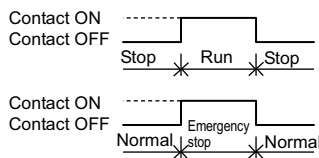

(B) Pulse signal

(Example) Run/Stop

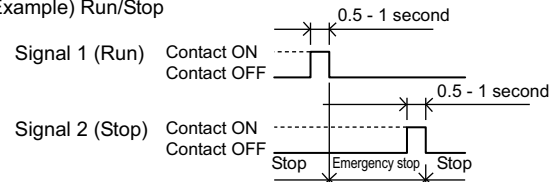

* Same with the Prohibit/Permit signal input.

3). External input specifications

CN5	Lead wire (PAC-YG10HA)	Emergency stop/Normal (level signal)	Run/Stop (level signal)	Run/Stop, Prohibit/Permit (pulse signal)
No. 5	Orange	Emergency stop/Normal signal input	Run/Stop signal input	Operation signal input
No. 6	Yellow	Not used	Not used	Stop signal input
No. 7	Blue	Not used	Not used	Local remote controller operation prohibit signal input
No. 8	Gray	Not used	Not used	Local remote controller operation permit signal input
No. 9	Red	External power supply 12VDC or 24VDC		

(A) Level signals

- ① If "Emergency stop/Normal operation signal" is selected, the unit will come to an emergency stop when the contact turns on, and the unit will resume normal operation when the contact turns off. When emergency stop is reset, all units will remain stopped, including the ones that were operating before the emergency stop signal input was received. To return to the previous operation status, these units need to be manually restarted.
- ② If "Run/Stop signal input" is selected, the unit will go into operation when external input signal contact turns ON, and the unit will stop when the contact signal turns OFF.

(B) Pulse signals

- ① If pulse signals to operate the units are received while the units are in operation, the units will continue their operation (same with the Stop, Prohibit, and Permit signals).
- ② When operation from the local remote controllers is prohibited, Run/Stop mode, operation mode, temperature setting, and filter reset settings cannot be changed from the local remote controller.
- ③ The pulse width (contact ON) should be between 0.5 and 1 second.

4). Recommended circuit

(A) Level signals

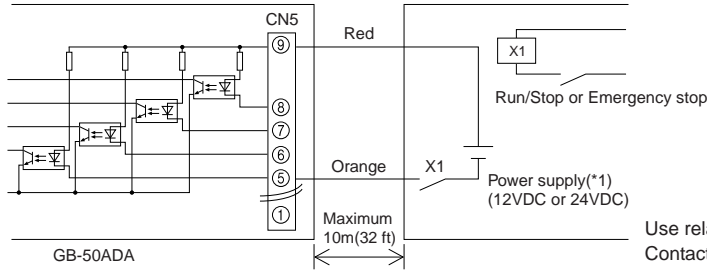

Use relays that meet the following specifications for X1, X2, Y1, and Y2.
 Contact rating
 Rated voltage: 12VDC or above
 Rated current: 0.1 A or above
 Minimum applied load: DC 1 mA or below
 (*1) Use a power supply suitable for the type of relays used.
 (12VDC or 24VDC)

(B) Pulse signals

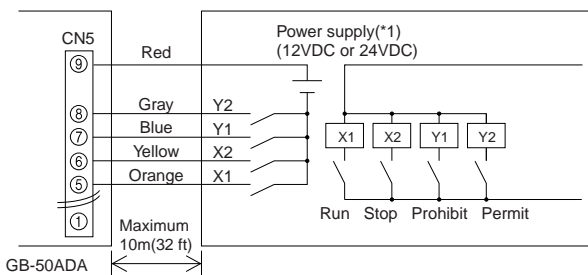

- ① Relays, DC power supplies, and extension cables are field supplied.
- ② The maximum length of extension cable is 10 m (32 ft). (Use a cable with a diameter of at least 0.3 mm².)
- ③ Cut the excess cable near the connector, and insulate the exposed cable end with tape.

(2). External signal output function

* A separately sold external input/output adapter (PAC-YG10HA) and external power supply are required to use the external signal output.

1). External output

Operation signal is output when one or more units are in operation, and error signal is output when one or more units are in error.

2). External output specification

CN5	Lead wire (PAC-YG10HA)	Terminal type
No. 1	Green	Common GND for external output (external DC, power supply GND)
No. 2	Black	Run/Stop*
No. 3	Brown	Error/Normal

* The operation status of DIDO controller is not output.
 * Operation signal is output during an error.

3). Recommended circuit

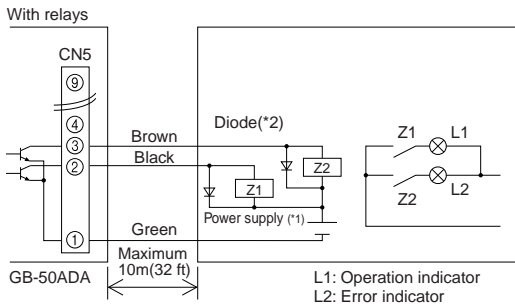

Use relays that meet the following specifications for Z1 and Z2.
 Operation coil
 Rated voltage: 12VDC or 24VDC
 Power consumption: 0.9 W or less
 (*1) Use a power supply suitable for the type of relays used.
 (12VDC or 24VDC)
 (*2) Use a diode at both ends of the relay coils.

- ① Each element turns on during operation and error.
- ② The maximum length of extension cable is 10 m (32 ft).
- ③ Relays, lamps, diodes, and extension cables are field supplied.

4. LAN connection function

Connect the LAN cable to the LAN connector of this device.

- * Procure the LAN cable at the site, and use an enhanced category 5 UTP cable.
- * For a description of the IP address setting method, refer to Installation Manual.
- * LAN is 100 BASE-TX Specification.
- * The maximum wiring length from HUB to GB-50ADA is 100m [328ft].
- * GB-50ADA is connected to the monitoring PC via HUB.

NOTE

- * Perform the LAN wiring before installation, and wire up to the body by the same method as wiring the M-NET transmission line.
 - * When a LAN is already connected, decide the IP address by consultation with the system administrator and connect to the LAN body after changing the IP address.
 - * Space for the connector and wiring is required. Refer to Installation Manual.
 - * Connect GB-50ADA to a private network.
- Use a security device such as a VPN router when connecting the GB-50ADA to the Internet to prevent unauthorized access.**
(If no security devices are installed, the operation settings may be changed by an unauthorized person without the knowledge of the user.)

5. Browser screens of GB-50ADA

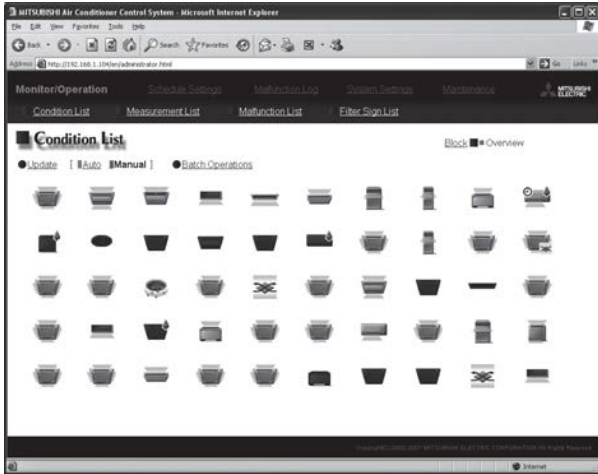

Condition List (Overview)

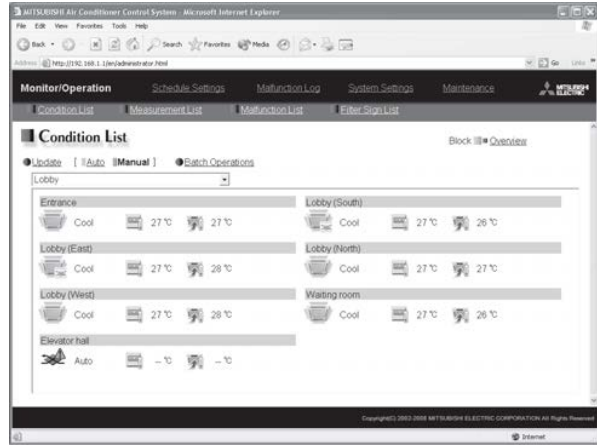

Condition List (Block)

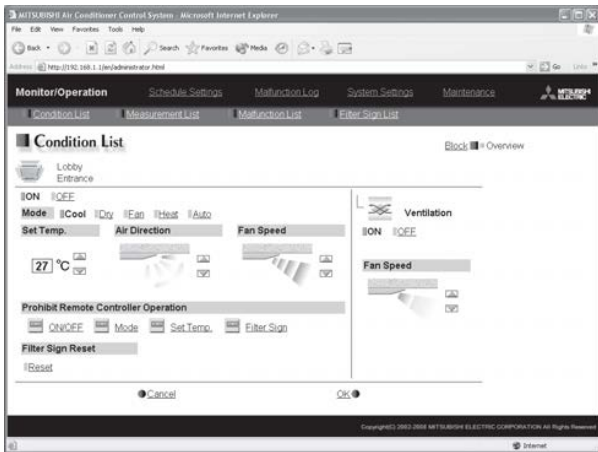

Operation

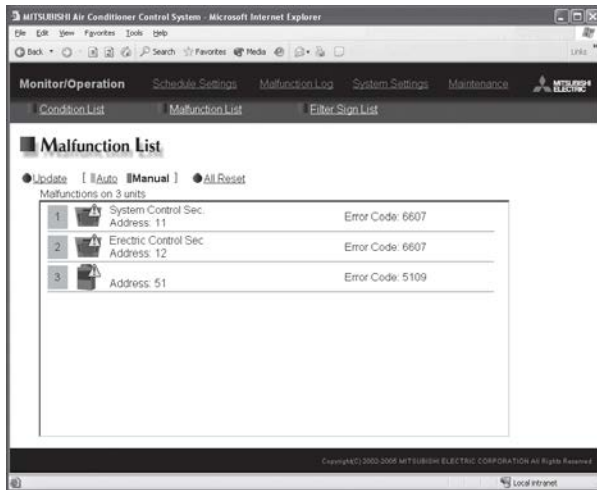

Malfunction List

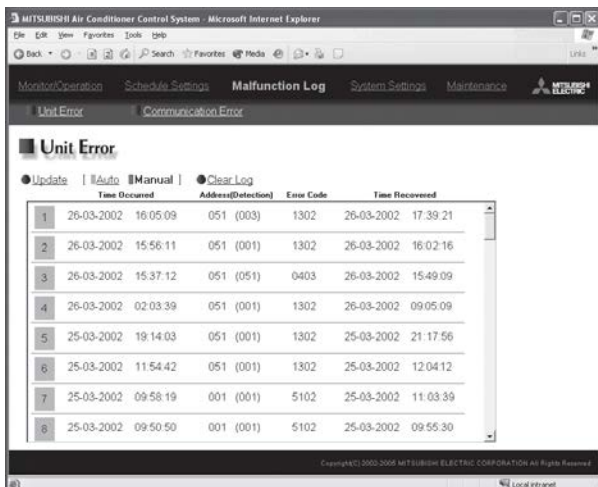

Malfunction Log

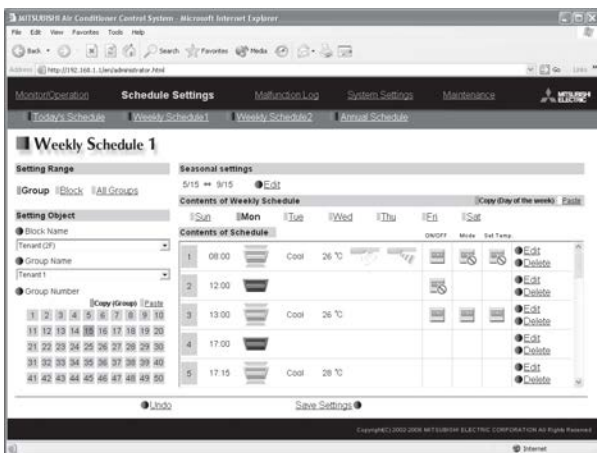

Weekly Schedule

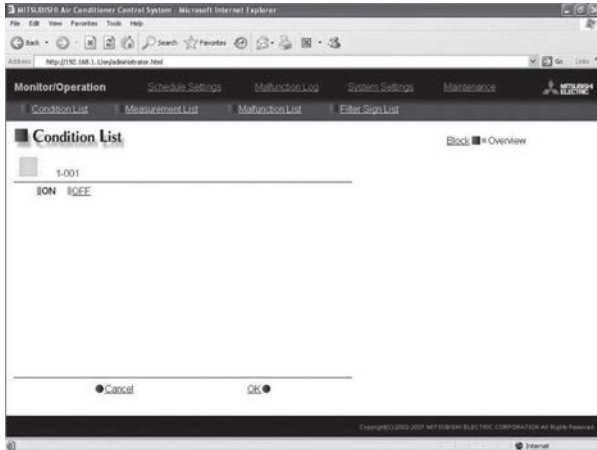

Operation (DIDO Controller)

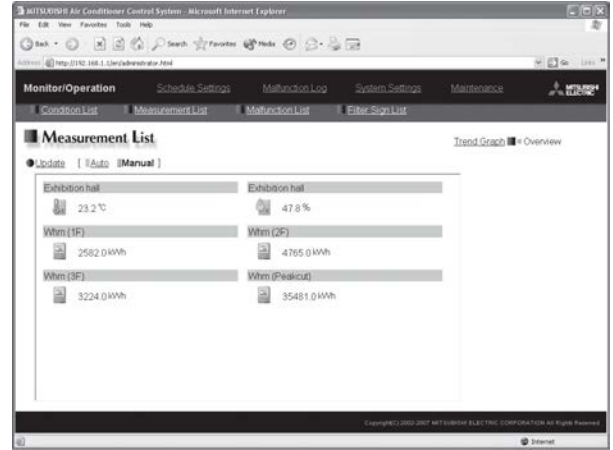

Measurement status monitor (temperature sensor/humidity sensor /measurement meter)

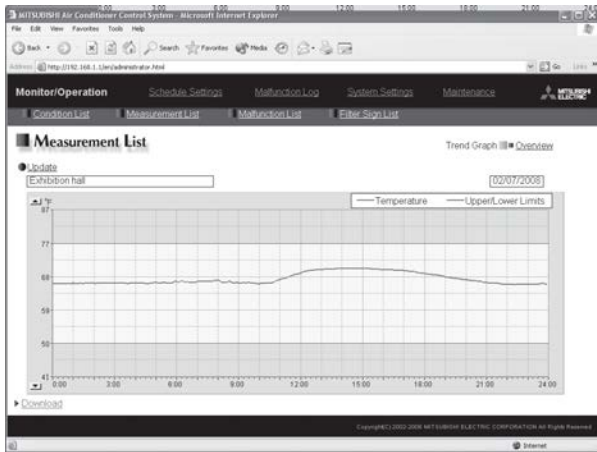

Trend Graph (temperature/humidity)

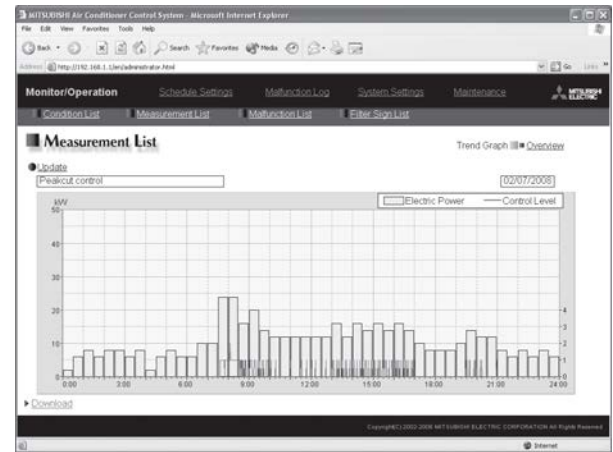

Trend Graph (Peak cut control)

3-7. Power supply unit [PAC-SC51KUA]

PAC-SC51KUA supplies DC power of M-NET (23-32V) and 24V at TB2 and TB3 respectively; the former is for centralized transmission use and the latter is for AG-150A operation and LAN function use.

1. When using PAC-SC51KUA as the power supplier for system controller, the capacity for system controller is considered as follows.

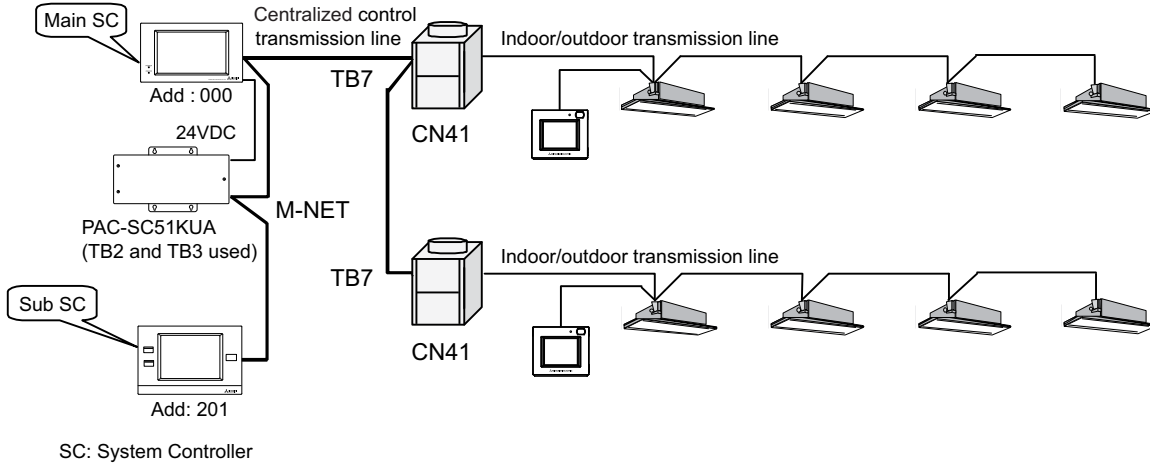

Fig. 1 Equivalent power consumption of controllers

In this case, pay attention to leave the power supply switch connector on CN41 of the Outdoor unit as the factory setting before shipment.

Taking the power consumption of the control board of Indoor unit as 1, the power consumption of various controllers is rated at Table 1.

Table 1 Equivalent power consumption of controllers

Centralized controller		System controller		M-NET remote controller
AG-150A	AE-200E AE-50E	Advanced touch controller (AT-50B)	ON/OFF remote controller (PAC-YT40ANRA)	Smart ME Controller (PAR-U02MEDA)
0.5	0	4	1	0.5

PAC-SC51KUA is capable to supply equivalent power up to 5, therefore the maximum connectable number of system controller is as follows.

Table 2 Max. connectable quianity of controller when using PAC-SC51KUA

Centralized controller*1	System controller		M-NET remote controller
AG-150A	Advanced touch controller (AT-50B)	ON/OFF remote controller (PAC-YT40ANRA)	Smart ME Controller (PAR-U02MEDA)
1unit	1unit	5 units	10 units

*1: According to the system restrictions, PAC-SC51KUA can be connected to only one centralized controller.

As the air conditioner control system may combine all kinds of system controllers, the total power consumption of system controllers need to count with Table 2.

For example, the controller system contains 1 AG-150A and 2 ON/OFF remote controllers (PAC-YT40ANRA) connected at centralized control communication line.

Then the total power consumption is

$$1 \times 0.5 + 2 \times 1 = 2.5 < 5.$$

One PAC-SC51KUA is therefore enough. The total power consumption should not exceed 5.



● When applying Charge and/or Peak-cut function on AG-150A, Power Supply Unit (PAC-SC51KUA) is recommended to use. AG-150A is possible to receive power from one of the Outdoor units, but there is a risk that the failure of power supply from the Outdoor unit will cause AG-150A's functioningdown on the whole system.

■ External dimension

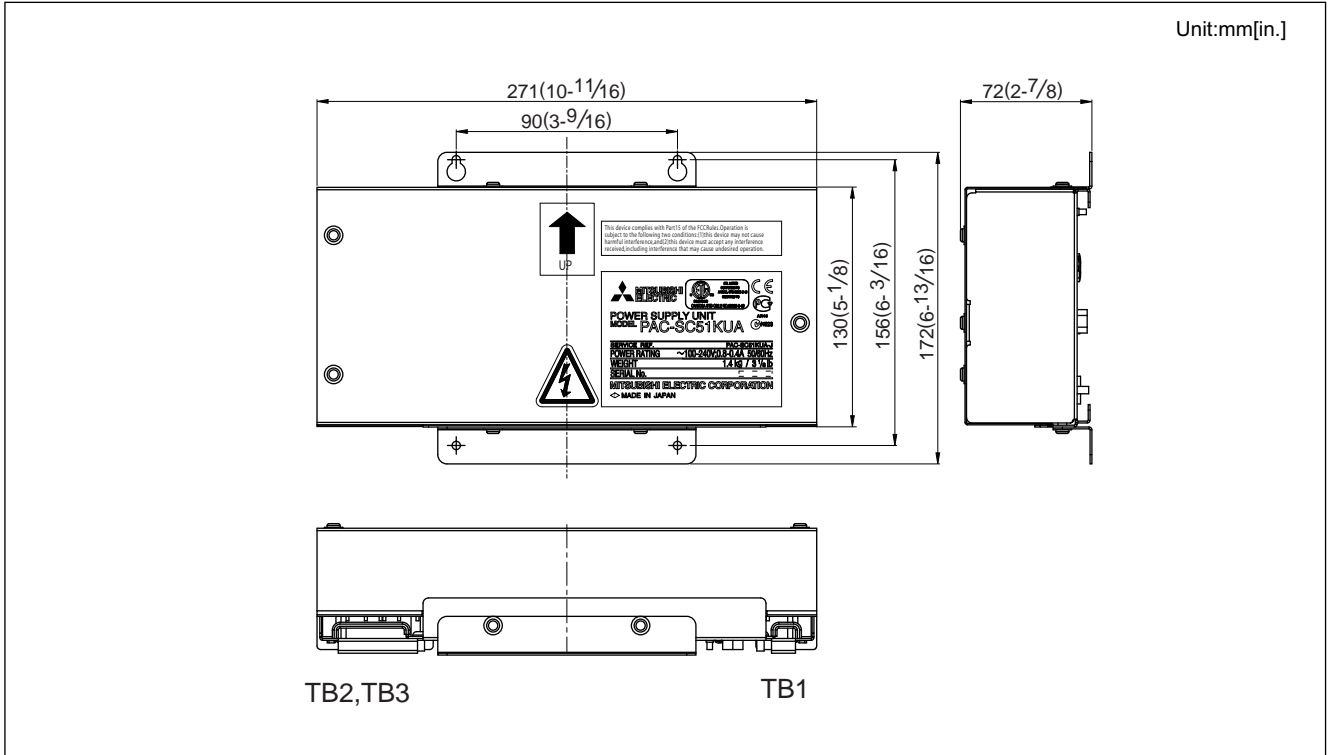

3-8. Expansion Controller [PAC-YG50ECA]

- PAC-YG50ECA can enhance units that AG-150A can control up to 150 by connecting 3 Expansion Controller (PAC-YG50ECA).
- PAC-YG50ECA has a built-in function to supply power to the M-NET transmission line. (power supply coefficient:6)

1.Specifications

Items		Specifications	
Power source	Rated input	100-240VAC ±10%0.4-0.3A50/60Hz	
	Fuse	250VAC 3.15A Time-delay Type (IEC127-2.S.S.5)	
Interface	Rated output of the power supply to M-NET transmission lines	22-30VDC	
	External input/output	12VDC or 24VDC (requires an external power supply)	
	LAN	100BASE-TX/10BASE-T	
Ambient conditions	Temperature	Operating temperature range	-10~55°C [14~131°F]
		Storage temperature range	-20~60°C [-4~140°F]
	Humidity	30~90%RH (Non-condensing)	
Dimensions		217 (H) × 250 (W) × 97.2 (D) mm [8-9/16(H) × 9-7/8(W) × 3-7/8(D)in.]	
Weight		2.6kg [5-3/4lbs.]	
Installation conditions		Inside the metal control board (indoor)	

2.External dimensions

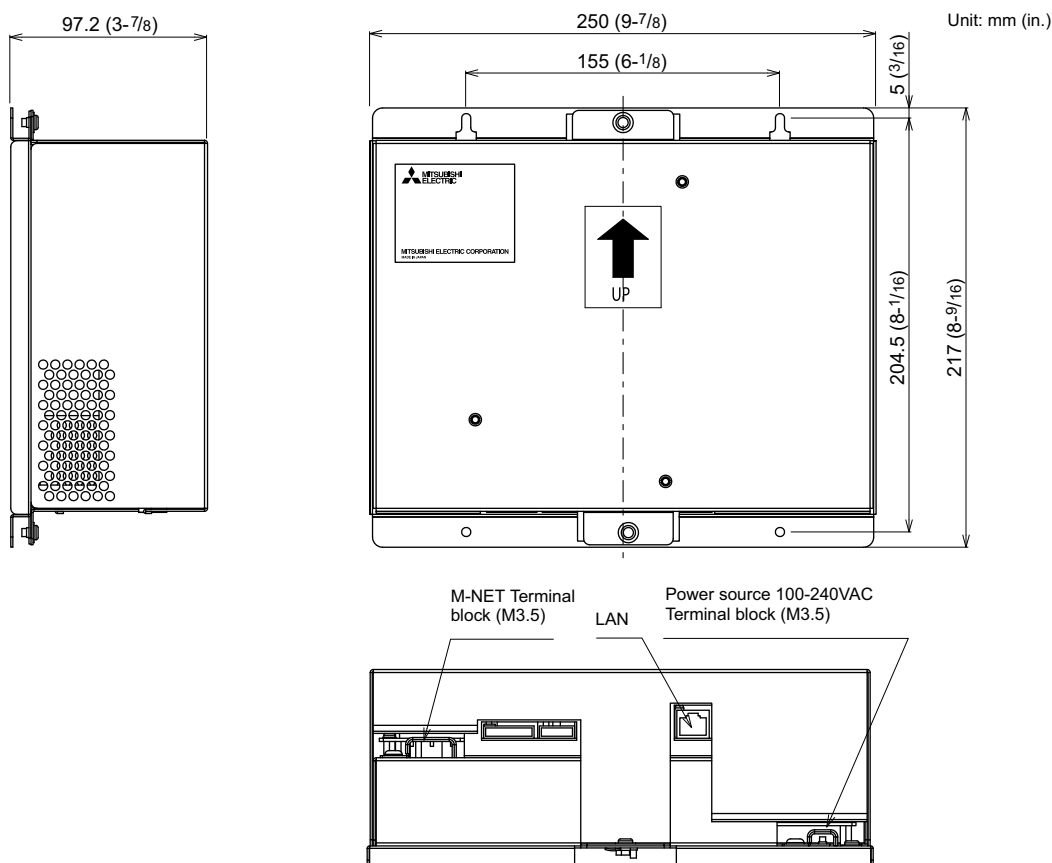

3.M-NET power supply

PAC-YG50ECA has a built-in function to supply power to the M-NET transmission line. (power supply coefficient:6)
 When power is supplied from PAC-YG50ECA , the types of system controllers listed in the table below are connectable.

	System controller		M-NET remote controller
	Advanced touch controller	ON/OFF remote controller	Smart ME Controller
Power consumption coefficient	4	1	0.5
Connectable units	1 unit	6 units	12 units

Note:

- When connecting both GB-50ADA-J and BAC-HD150 (BM ADAPTER) to the same M-NET system, certain restrictions apply. Consult your dealer for details.
- Supplying power from the Outdoor unit or the power supply unit, it is necessary to replace power supply switch connector CN40 with CN41. (Factory default is CN40.)

4.Functions

Item	Description	Operations	Display
Error	When an error is currently occurring on an air conditioner unit, the afflicted unit and the error code are displayed. When an error occurs, the "Error" LED turns ON.	×	○
External input/output	By using accessory cables you can set the following. Input: By level signal: "Batch start/stop", "Batch emergency stop" By pulse signal: "Batch start/stop", "Enable/disable local remote controller"	○*1*2	×
	By using accessory cables you can monitor the following. Output: "Start/stop"*3, "Error/Normal"	×	○*1
M-NET	The "M-NET" LED lights, when M-NET power supply is turned ON. The LED blinks while M-NET communicating.	×	○

[Symbol ○:enable ×:disable]

- *1: Requires an external I/O cable (Model: PAC-YG10HA; sold separately) and an external power supply.
- *2: DIDO controller (PAC-YG66DCA) cannot be "Batch start/stop" and "Batch emergency stop" by using the external input function. But when "Batch emergency stop" is selected, DIDO controller (PAC-YG66DCA) can be collectively stopped by setting the appropriate switch on the DIDO controller.
- *3: The operation status of DIDO controller is not output.
Operation signal is output during an error.

5. System configuration

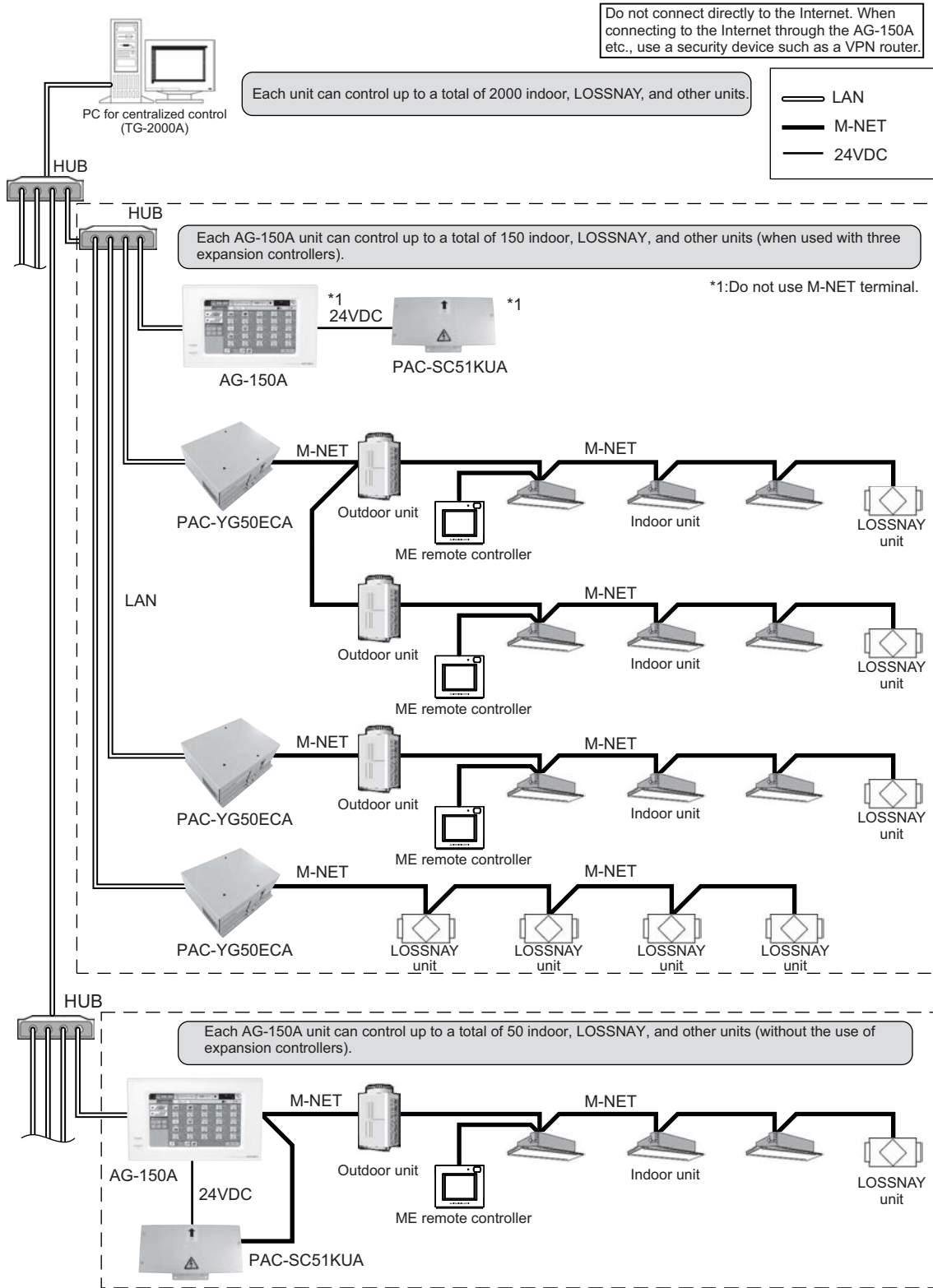

- Note
- Connect the LAN cable to the LAN connector on the PAC-YG50ECA.
 - Connect the PAC-YG50ECA and AG-150A via a HUB.
 - The maximum distance between the HUB and PAC-YG50ECA is 100 m (328 ft).
 - The LAN cable is field-supplied. Use a category 5 or better straight cable.
 - Use a switching HUB.
 - It is recommended that the number of devices to be connected between AG-150A and PAC-YG50ECA does not exceed four. (Round-trip transmission delay time must not exceed four seconds. If the transmission delay time is set too long, a communication error may occur.)

3-9. Integrated centralized control software [TG-2000A]

1. Example of Basic System Configuration.

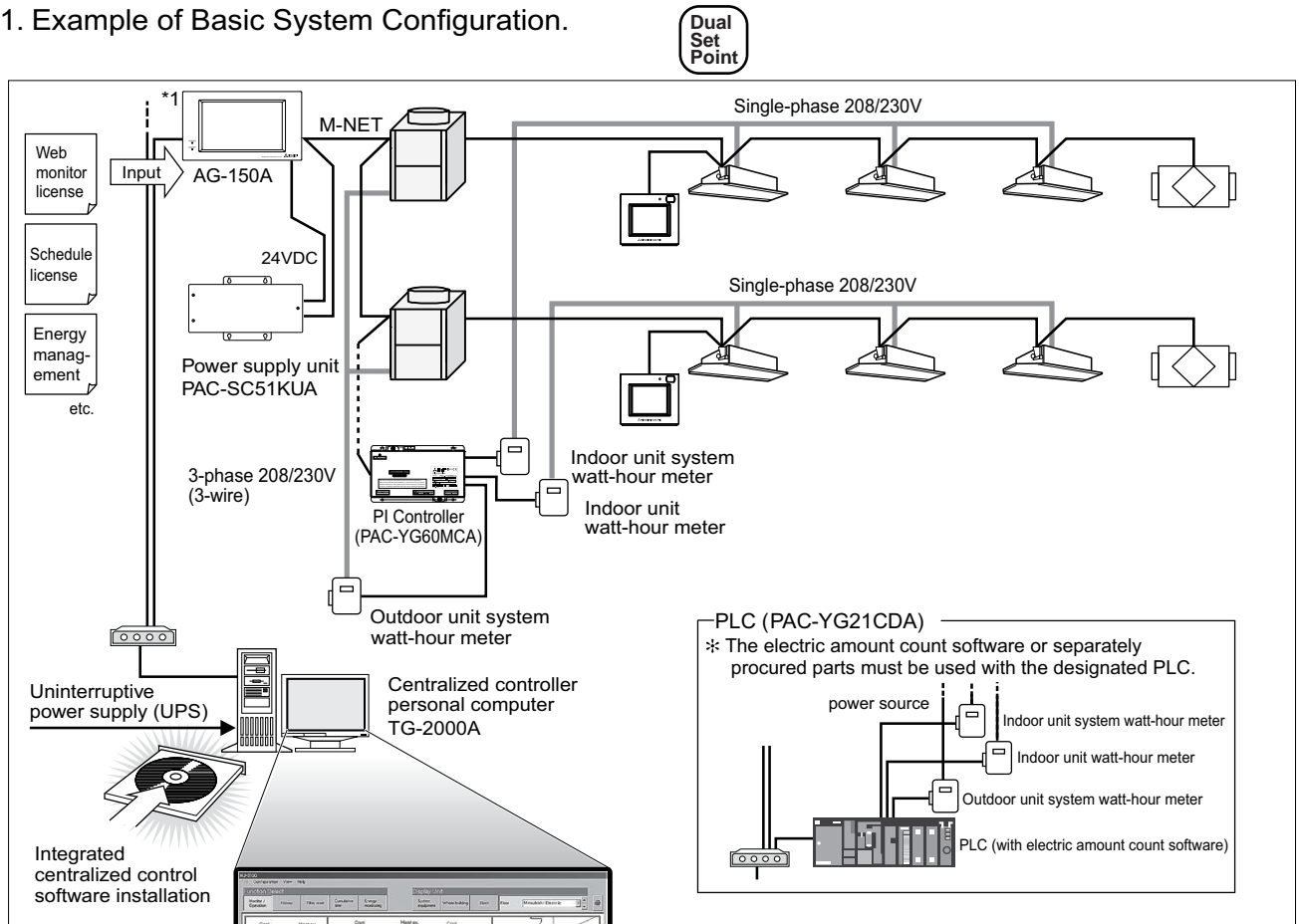

*1 GB-50ADA-J can be used.
(GB-50ADA-J does not require PAC-SC51KUA.)

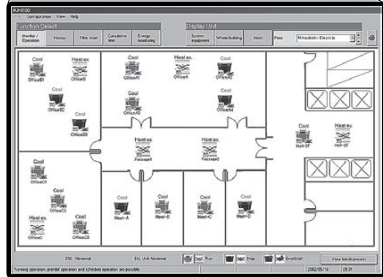

The TG-2000A can realize the following functions using the AG-150A, GB-50ADA-J, or EB-50GU-J option (license).

- * Operation/monitor
- * Annual/weekly schedule
- * Charge
- * Energy saving
- * Peak cut

Note : Depending on the versions of TG-2000A, AG-150A, GB-50ADA-J, and EB-50GU-J, some of the functions may not be available for use.

■ Main features of TG-2000A

- ① Up to 2000 units (40 AG-150A*3, GB-50ADA-J, or EB-50GU-J*4 units) can be operated and monitored simultaneously.
- ② The air-conditioner layout can be displayed on the screen, making control and operation easier.
- ③ The annual and weekly schedules can be set. 5 schedules, such as the summer master and winter master, can be saved in the weekly schedule.
- ④ Air-conditioning charges can be calculated based on the multiple air-conditioner usage results. The power apportionment percentage data and apportioned power rate can be calculated for each indoor unit using the power apportionment function, and can be output as a CSV format file. * Power apportionment charging is not possible with the old model, A control or K control.
Charging without WHM*1 : The user manually inputs the power rate to calculate the air-conditioning charges. (Using a tool)
PI controller + pulse WHM charging*1 : The pulse output WHM value is automatically tabulated by the PI controller (PAC-YG60MCA) to calculate the air conditioning charges.
PLC + pulse WHM charging*1 : The pulse output WHM value is automatically tabulated by the PLC to calculate the air-conditioning charges.
- ⑤ Energy saving operation is possible using the "ON/OFF", "set temperature change", "fan operation changeover" and "performance save operation (60% to 90%)" functions.
Energy saving operation matching the amount of power in use is possible by using the PI controller or PLC's electric amount count software.
- ⑥ Night Set-Back function operation is possible with schedule settings.*2
- ⑦ General equipment can be operated and monitored.
- ⑧ General equipment can be schedule-controlled when using PAC-YG21CDA with PLC or DIDO Controller (PAC-YG66DCA). (For details of PLC refer to Installation Manual of PAC-YG21CDA.)

*1: Only one of these functions can be used.

*2: With Night Set-Back function, the CITY MULTI system can run at heating mode with target temperature set to 12°C / 54°F under schedule control. (It depends on the outdoor unit model. Not applicable on PUMY.) This function can protect the room from dropping down to extremely low temperature at mid-night.

*3: AG-150A controls 50 units. When AG-150A is connected with PAC-YG50ECA, units are counted based on the number of connected PAC-YG50ECA.

*4: EB-50GU-J is compatible with TG-2000A Ver.6.40A or later.

Note: AG-150A is compatible with TG-2000A Ver.5.5* or later. GB-50ADA-J is compatible with TG-2000A Ver. 6.3* or later.

AG-150A connected with PAC-YG50ECA is compatible with TG-2000A Ver.6.1* or later.

Depending on the versions of TG-2000A and AG-150A/GB-50ADA-J/EB-50GU-J, some of the functions may not be available for use. Each system allows the connection of only one TG-2000A.

AE-200E/AE-50E is compatible with TG-2000A Ver. 6.50 or later.

2. List of TG-2000A functions

(1). The data for each AG-150A/GB-50ADA-J/EB-50GU-J can be grouped and used to control the operation of up to 2000 units in floor or block units, etc., from the personal computer screen. By using a PI Controller/PLC or a watt-hour meter, the power rate can be apportioned, energy saving control can be executed, and other general equipment can be controlled.

List of integral software functions

Item	Details	AG-150A/GB-50ADA-J/EB-50GU-J license			
		Web monitor	Schedule	Energy management	PLC for general equipment
ON/OFF	The units can be turned ON and OFF for all floors or in block, floor or group units.	V			
	The general equipment can be turned ON and OFF. (*: A PLC and the general equipment control PLC software required.)	V			
Operation modes	The operation mode can be switched between COOL, DRY, FAN, AUTO and HEAT for all floors or in block, floor or group units.	V			
Temperature setting	The temperature can be set within the following range. Cool/Dry: 19°C - 35°C/67°F - 95°F Heat: 4.5°C - 28°C/40°F - 83°F Auto (single set point): 19°C - 28°C/67°F - 83°F Auto (dual set points) [Cool]Same as the set temp. range for Cool mode. [Heat]Same as the set temp. range for Heat mode. *The settable temperature ranges and items vary depending on the indoor and outdoor unit models.	V			
Fan speed	The fan speed can be set to four stages for all floors or in block, floor or group units.	V			
Air direction	The air direction can be set in four vertical directions or to swing for all floors or in block, floor or group units.(The selectable air direction differs according to the model.)	V			
Interlocked unit ON/OFF (LOSSNAY)	If there is an interlocked unit (LOSSNAY, the unit can be turned ON (strong/weak) or OFF for all floors or in block, floor or group units. (Note that the ventilation mode cannot be selected for interlocked units.)	V			
Local operation prohibit	The items for which operation with the local remote controller are to be prohibited can be selected for all floors or in block, floor or group units. (The items that can be prohibited are ON/OFF, operation mode, set temperature and filter sign reset.)	V			
Annual / weekly schedule	The annual/weekly (season:weekly x 5) schedule function can be used by registering the license. Five settings, such as seasonal settings for summer and winter, can be saved.	V	V		
Power rate apportionment charging (power rate manual input)	By registering the AG-150A/GB-50ADA-J/EB-50GU-J unit license number, the power rate apportionment percentage data for each indoor unit can be output in CSV format. The power rate for each tenant can be easily calculated by having each user input the power rate manually.	V		V	
Power rate apportionment charging	By using the PI controller (PAC-YG60MCA) and a pulse output watt-hour meter, the air-conditioning charges can be calculated based on the amount each tenant's air-conditioner has operated. Up to five charging rates can be applied per day.	V		V	
	By using a PLC (with electric amount count software) and a watt-hour meter with pulse transmitter, the air-conditioning charges can be calculated based on the amount each tenant's air-conditioner has operated. Up to five charging rates can be applied per day.				
History	The error history and up to 10000 items for operation history can be saved. Each history file can be output as a daily report or monthly report in CSV format. The maximum number of error history data that can be saved depends on the type of errors and the number of connected AG-150A/GB-50ADA-J/EB-50GU-J units. The operation history consists only of the operations carried out with the TG-2000A, and is limited to some limited operation items.	V			
Operation time monitor	The cumulative operation time of each indoor unit can be viewed or output as a CSV format file. (This function is valid only when the charging function license is registered.)	V		V	
Filter sign display mask	Automatic display of the filter sign can be disabled. (System batch.) In this case, the filter sign state is confirmed with manual operations.	V			
Energy saving control	Energy saving operation is possible using the "ON/OFF", "set temperature change", "fan operation changeover" and "performance save operation" functions.	V		V	
Energy saving (peak cut)	Energy saving operation matching the amount of power in use is possible. (PLC (with electric amount count software) and watt-hour meter with pulse transmitter are required.)	V		V	
Night Set-Back function *:1	Heating from 12°C / 54°F and higher can be set using the schedule function.	V			
	This function helps keep the indoor temperature in the temperature range while the units are stopped and during the time this function is effective.	V			
Set temperature limit	Sets the temperature range for the local remote controllers. * The item and range that can be operated or monitored depend on the function of the indoor unit.	V			
Control other general equipment	The ON/OFF status of the connected general equipment and the error status can be changed or monitored from the DIDO(PAC-YG66DCA).	V			
	It is possible to control other general equipment on ON/OFF operation / monitoring / Alarm / scheduling, if TG-2000A combines PLC installed with PLC software PAC-YG21CDA.	V			
	Setting inter-lock with CITY MULTI indoor units is possible using PLC(PAC-YG21CDA). (Table setting tool for input/output definition is needed.)	V			V

*:1 : With Night Set-Back function, the CITY MULTI system (PUMY models excluded) can run at heating mode with target temperature set to 12°C /54 °F under schedule control. (It depends on the outdoor unit model.)
This function can protect the room from dropping down to extremely low temperature at midnight.

Note : Depending on the versions of TG-2000A and AG-150A/GB-50ADA-J/EB-50GU-J, some of the functions may not be available for use.

3. Screens of TG-2000A

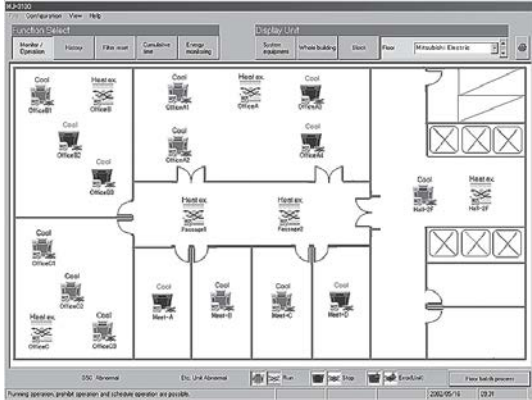

Floor screen

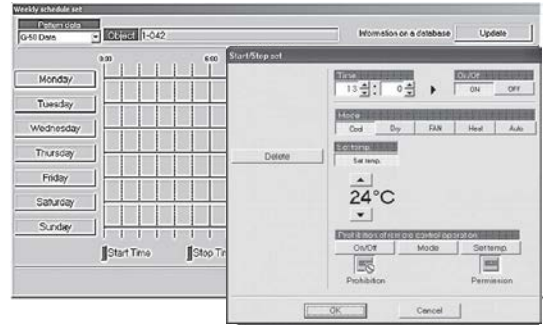

Weekly schedule screen

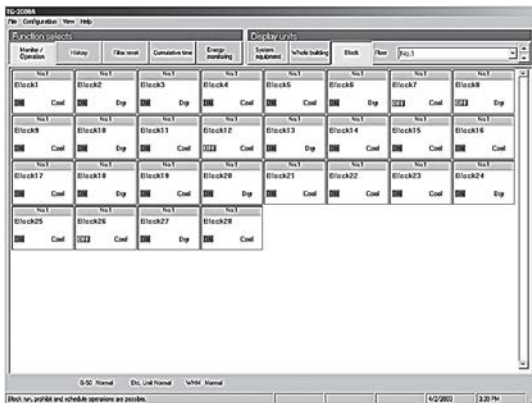

Block screen

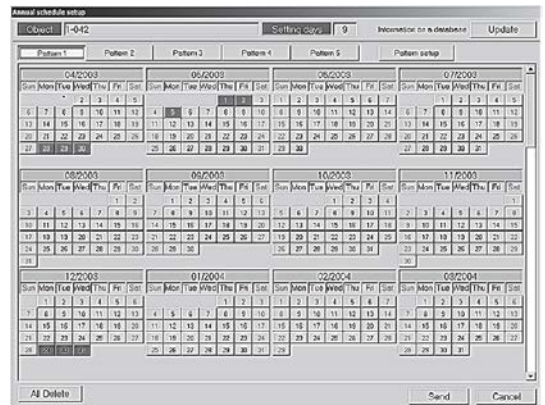

Annual schedule screen

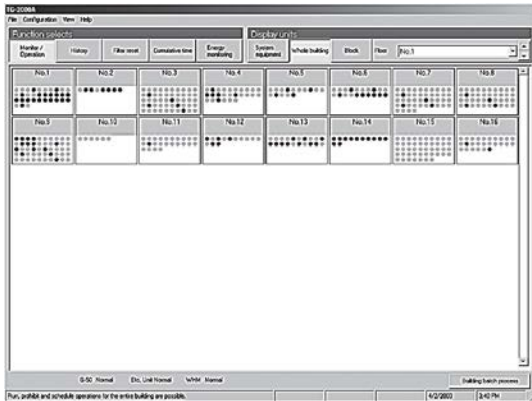

All floor screen

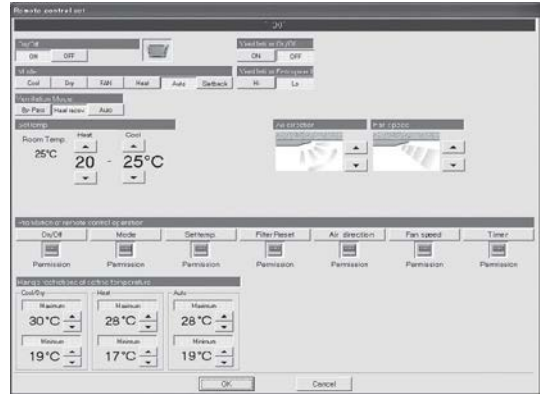

Operation setting screen

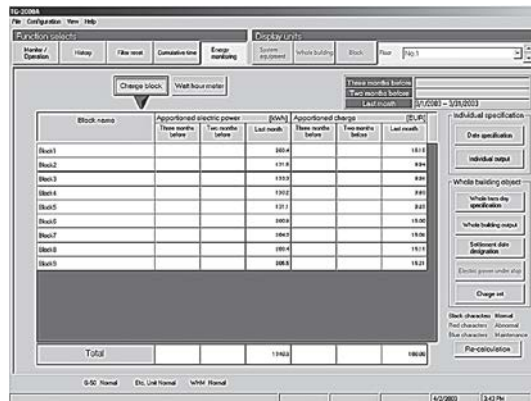

Air-conditioning charge screen

4. Requirements (system recommendations)

	Usage	System Requirements
TG-2000A	To use TG-2000A for AE-200E, AE-50E, EB-50GU-J, AG-150A, GB-50ADA-J and G-50A	OS: Windows® 8.1Pro, Windows® 7, Windows Vista® Refer to the table below for details.

We recommend the following software and hardware when using this application (TG-2000A).

Item	Requirement		Recommended
PC	PC/AT compatible machine (Business model is recommended)		Operation confirmed using HP and Dell computers.
CPU	Core™ 2 Duo 1.66GHz or faster		Core™ i3 1.6GHz or faster
Memory	In the case of Windows® 8.1/7 (64bit): 2GB or more		4GB or more
	In the case of Windows® 7/Vista® (32bit): 1GB or more		2GB or more
OS	Windows® 8.1 Pro (64bit)		English version only Only compatible with "Pro" and "64 bit" versions of Windows® 8.1. Not compatible with Windows® 8
	Windows® 7 Professional (64/32bit) Service Pack 1 (*1)		English version only
	Windows Vista® Business (32bit) Service Pack 2 (*1)		English version only
HDD	Standard	6GB or more (2GB or more of C drive free space necessary)	40GB or more of C drive free space necessary when using the trend function. The drive used for automatic output must have the following free space according to the number of groups. 200groups = 2GB, 500 groups = 5GB, 1000groups = 10GB, 2000 groups = 20GB
	Wide area	20GB or more (Free space)	Standard: max. 200MB/site
Storage device	CD-ROM drive/DVD-ROM drive (*2)		Devices other than those shown at the left may also be installed.
Resolution	1024 × 768 or higher, 65536 colors or more		
Serial port	1 port or more		Required when using RS-485 communication WHM (Not necessary when using PLC)
LAN	1 port (100BASE-TX/10BASE-T)		(*3)
Modem	56K modem or TA		Required when using a modem in wide area mode.
USB	2 port or more		For the data backup.
Other	Computer must be dedicated for this use (TG-2000A).		Must be used for 24-hour constant operation

*1: It is necessary to correspond to each Service Pack. TG-2000A is not normally set up at the uncorrespondence. Please apply Service Pack of the correspondence.

*2: To set up "NET Framework 3.5" using the Windows® 8.1 setup disk (DVD), a DVD-ROM drive is required.

*3: Purchase the option, or use the equipment recommended for the computer when purchasing the computer.

5. Compatible Units

The TG-2000A has two main functions: centralized control of air conditioners and cost accounting. However, not all functions are available with all air conditioners.

Table: Compatible units and function list (○ : supported, △ : Certain restrictions apply, × : Not supported)

Model	Function	Control/ Maintenance	Charging (Billing) without WHM	Charging (Billing) with WHM	Energy Saving /Peak Cut
Y series		○		○ *1	○
HP series		○		○ *1	○
R2 series		○		○ *1	○
WR2 series		○		○ *1	○
WY series		○		○ *1	○
Multi S series		○		○ *1	○*6
Indoor unit		○		○ *2	○
LOSSNAY		○		○ *3	△*7
OA processing unit		○		○ *1	△*8
Air To Water Booster unit		○	×	△*12	△*13
Air To Water HEX unit		○	×	△*12	△*13
"A" control type *4	○ (Adapter required)			○ *1,5	△*9
"K" control type *4	○ (Converter required)			○ *1,5	△*10
Room Air Conditioner	○ (Adapter required)		×	×	△*11

*1 : Can be calculated for each charging block. May not be available with some older models.

*2 : Indoor unit models before Free Plan models do not support a charge apportioning billing method based on the "capacity save". The existence of even a single unit of those types in the system requires that the method of charge apportioning billing be set to either "Thermo on time" or "Fan operation time".

*3 : LOSSNAY groups to which the remote controller is connected support the charging system.

*4 : Not all of the A-control and K-control units support these functions. The calculation of the charge for the auxiliary heater may not be handled by these units.

*5 : For A-control and K-control units, use the apportioned charging methods that are listed in "Thermo on time" or "Fan operation time" section. Otherwise, install a watt-hour meter for each unit.

*6 : Outdoor unit capacity control function is not available.

*7 : Only the function to stop the units is available.

*8 : When the attribute is IC (indoor unit): Same type of energy-save control unit as with the Freeplan Indoor unit is possible.

When the attribute is FU (LOSSNAY with a heater/humidifier): no direct energy-save control is possible.

*9 : Inverter models support the outdoor unit capacity save control function.

*10 : Outdoor unit Thermo-OFF control function is not supported. Only the fan speeds control function is available.

*11 : Only the temperature control function or the function to stop the units is available.

*12 : For the charge apportioning of Air To Water Booster unit and Air To Water HEX unit, connect the unit to individual watt-hour meter.

Although only the heating capacity is listed in the specification of Air To Water Booster unit, the "cooling" value is used for the Capacity and Power input of indoor unit parameter for Energy-Monitoring Set Up.

The setting is already made with the cooling value for the models registered in Set-up of model name.

For Air To Water Booster unit and Air To Water HEX unit, the charging function supports only the primary refrigerant system of those units.

(Each unit obtains the reading of its watt-hour meter.)

*13 : Capable of Thermo-OFF control (fan operation control) and bringing the units to stop only.

*14 : Connect a WHM to each Room Air Conditioner unit to monitor the electricity consumption of each unit.

3-10. Electric amount count software [PAC-YG11CDA]

MITSUBISHI ELECTRIC offers a charging function for its air conditioner system. Detailed output of every indoor for electricity consumption of air-conditioning is available. The electricity consumption of the air-conditioner is counted based on the refrigerant consumption of every indoor unit, which allows for precise proportion of electricity consumption.

■ System example

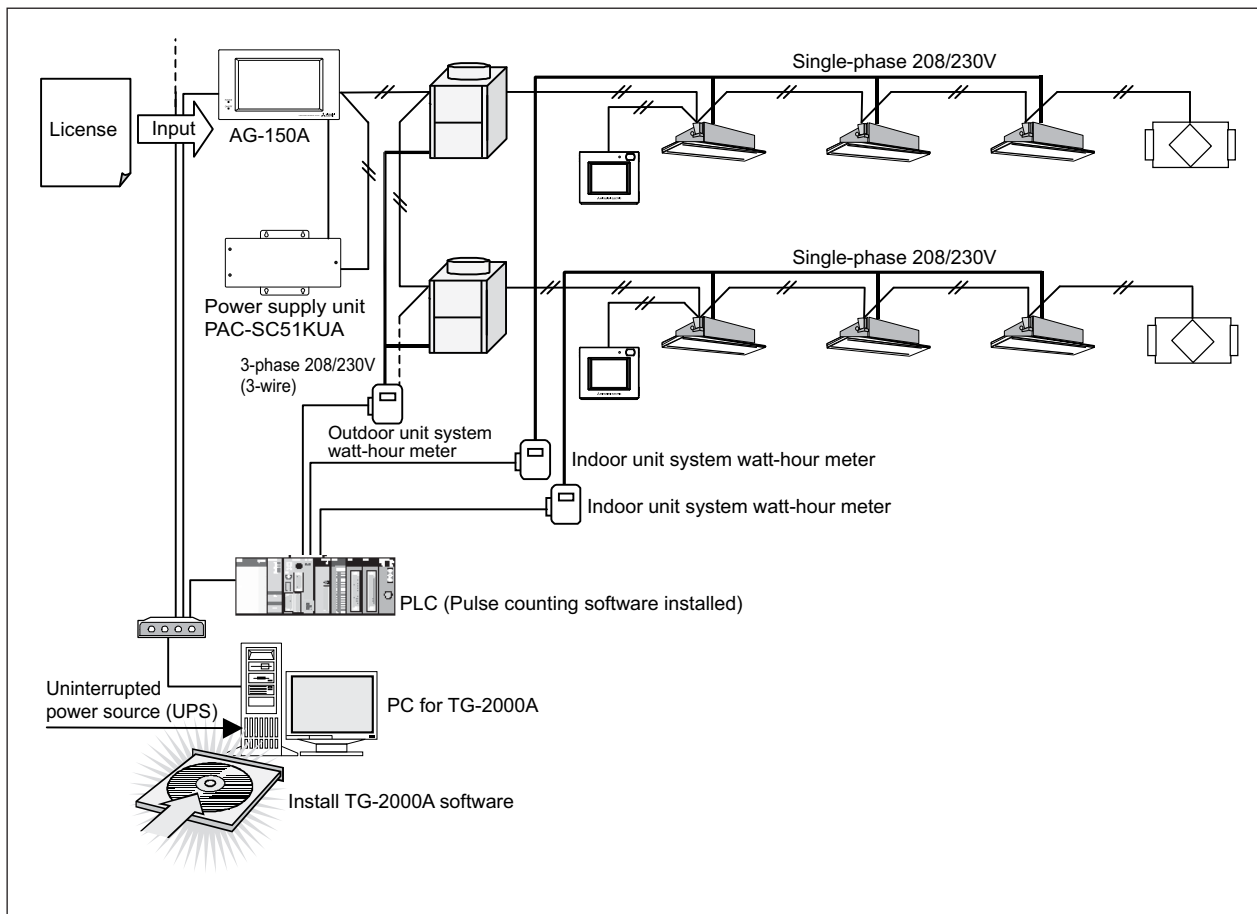

■ Necessary parts for the system

Name (Model name)	Manufacturer	Remarks
PC for central control	PC/AT convertible unit	Confirmed operation of DELL, HP. For details, refer to AG-150A Technical Manual.
TG-2000A	MITSUBISHI ELECTRIC	The use of the latest version of TG-2000A and AG-150A/ GB-50ADA-J/EB-50GU-J/AE-200E/AE-50E is recommended.
Energy management license pack	MITSUBISHI ELECTRIC	Requires for each AG-150A/GB-50ADA-J/EB-50GU-J/AE-200E/AE-50E.
Web monitor license	MITSUBISHI ELECTRIC	Requires for each AG-150A/GB-50ADA-J/EB-50GU-J/AE-200E/AE-50E.
PLC	MITSUBISHI ELECTRIC	PLC for pulse counting connects maximum 5 sets. For details, refer to Installation Manual of PAC-YG11CDA.
PAC-YG11CDA	MITSUBISHI ELECTRIC	For details, refer to AE-200E Technical Manual.
Watt-hour meter with pulse oscillator	MITSUBISHI ELECTRIC	For the specification of the watt-hour meter, refer to AE-200E Technical Manual.
Uninterrupted power source (UPS)		Field supplied.

3-11. PLC software for general equipment [PAC-YG21CDA]

MITSUBISHI ELECTRIC's Air Conditioner control system can combine control of general equipment like lighting, air conditioners from other manufacturers, etc.

Functions on general equipment :On/Off operation, alarm, monitoring, scheduling.

■ System example

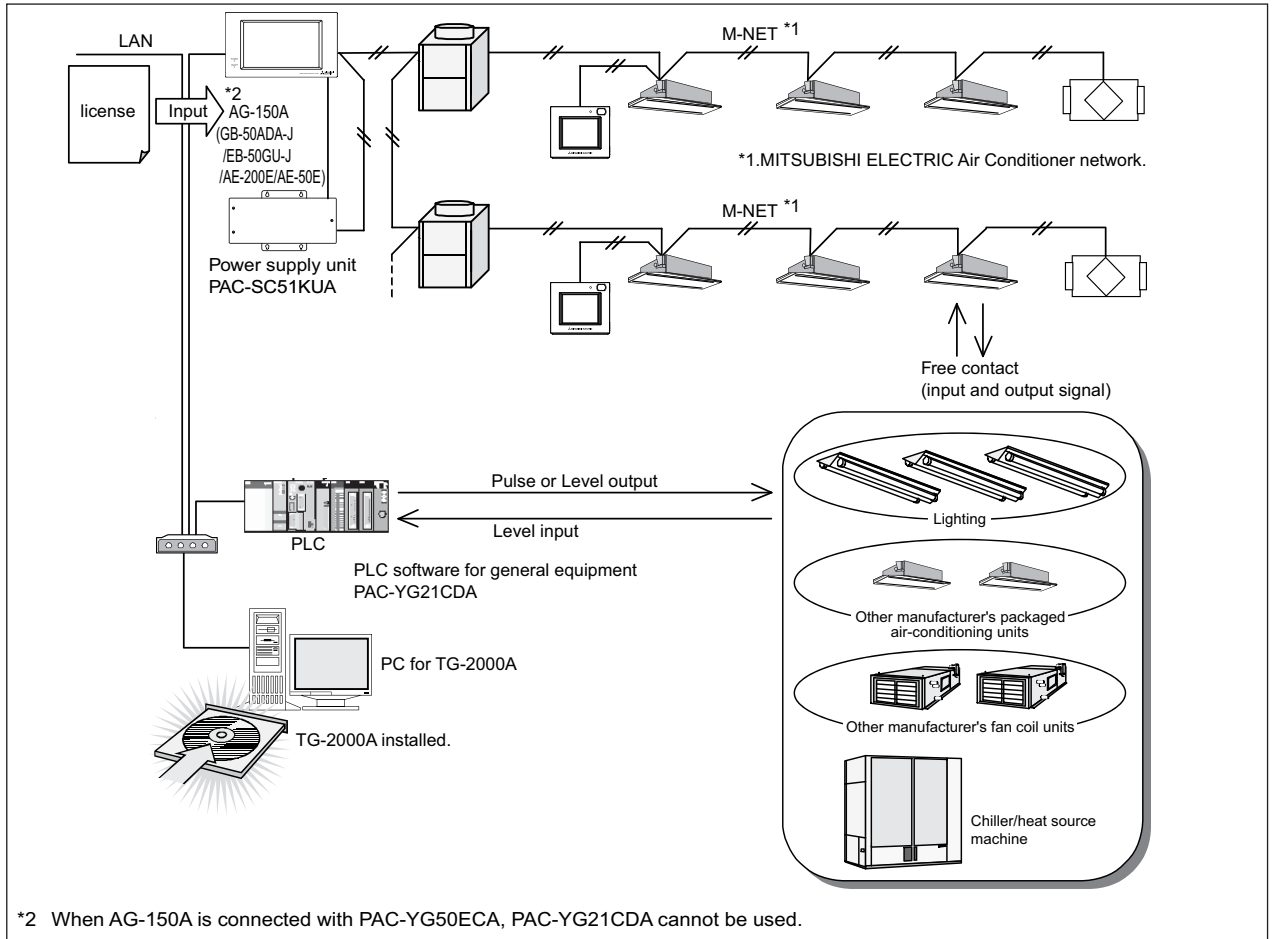

■ Necessary parts for the system

Materials (model names)	Manufacturer	Remarks
PC for central control	PC/AT compatible	Confirmed operation of DELL, HP. For details, refer to AG-150A Technical Manual.
TG-2000A	MITSUBISHI ELECTRIC	The use of the latest version of TG-2000A and AG-150A /GB-50ADA-J/EB-50GU-J/AE-200E/AE-50E is recommended.
Web monitor license	MITSUBISHI ELECTRIC	Requires for each AG-150A/GB-50ADA-J/EB-50GU-J/AE-200E/AE-50E.
PLC for general equipments license	MITSUBISHI ELECTRIC	Table-setting of input/output is necessary.
PLC	MITSUBISHI ELECTRIC	Make sure DI board and DO board are mounted.
PAC-YG21CDA	MITSUBISHI ELECTRIC	For details, refer to AE-200E Technical Manual.

3-12. BACnet® interface [BAC-HD150]

CITY MULTI can easily combine into a Building Management System (BMS) via the BACnet® and M-NET adapter BAC-HD150. BACnet® is an opened transmission protocol widely used at BMS, and related equipment control. CITY MULTI is therefore compatible with large-scaled BMS management via BACnet®. BAC-HD150 can control up to 50 units/groups (including LOSSNAY). Up to 150 units/groups (including LOSSNAY) can be controlled from one BAC-HD150 with three expansion controllers PAC-YG50ECA. (50 units/PAC-YG50ECA) When the dual set point function is used, no expansion controllers can be connected, and only up to 50 units/groups can be controlled from each BAC-HD150.

■ Specifications

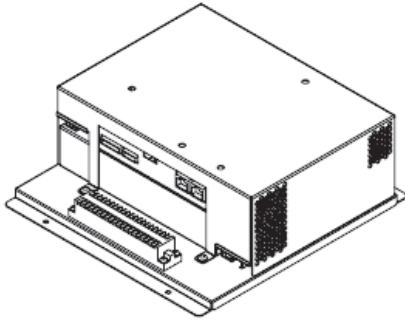

Items		Specifications	
Power source	Rated input	100-240 VAC ±10 % 0.4-0.3 A 50/60 Hz	
	Fuse	250 VAC 3.15 A Time-delay type (IEC127-2 S.S.5)	
Interface	Rated output of the power supply to M-NET transmission lines	22-30 VDC	
	LAN 1 (for BACnet®) LAN 2 (for Expansion Controller)	10Base-T or 100Base-TX	
Ambient conditions	Temperature	Operating temperature range	-10 ~ 55°C (14 ~ 131°F)
		Storage temperature range	-20 ~ 60°C (-4 ~ 140°F)
	Humidity	30 ~ 90 %RH (Non-condensing)	
Dimensions		266 (H) × 250 (W) × 97.2 (D) mm (10-1/2 (H) × 9-7/8 (W) × 3-7/8 (D) in.)	
Weight		2.8 kg (6-3/16 lbs.)	
Installation conditions		Inside the metal control panel (indoor)	

■ Functions

Communication items at BM Adapter

Operation	State Monitoring
On/Off	On/Off
Mode	Mode
Fan Speed	Fan Speed
Air Direction	Air Direction
Set Temp.	Set Temp.
Set Temp. (Cool)*	Set Temp. (Cool)*
Set Temp. (Heat)*	Set Temp. (Heat)*
Set Temp. (Auto)*	Set Temp. (Auto)*
Set Setback Temp. (Higher)*	Set Setback Temp. (Higher)*
Set Setback Temp. (Lower)*	Set Setback Temp. (Lower)*
Filter Sign reset	Filter sign
Prohibit local On/Off	Indoor temperature
Prohibit local Mode	Prohibit local On/Off
Prohibit local Filter sign reset	Prohibit local Mode
Prohibit local Set Temp.	Prohibit local Filter sign reset
Forced Off	Prohibit local Set Temp.
	Alarm signal
	Error code
	Communication state

* When the dual set point is used.

■ External Dimensions

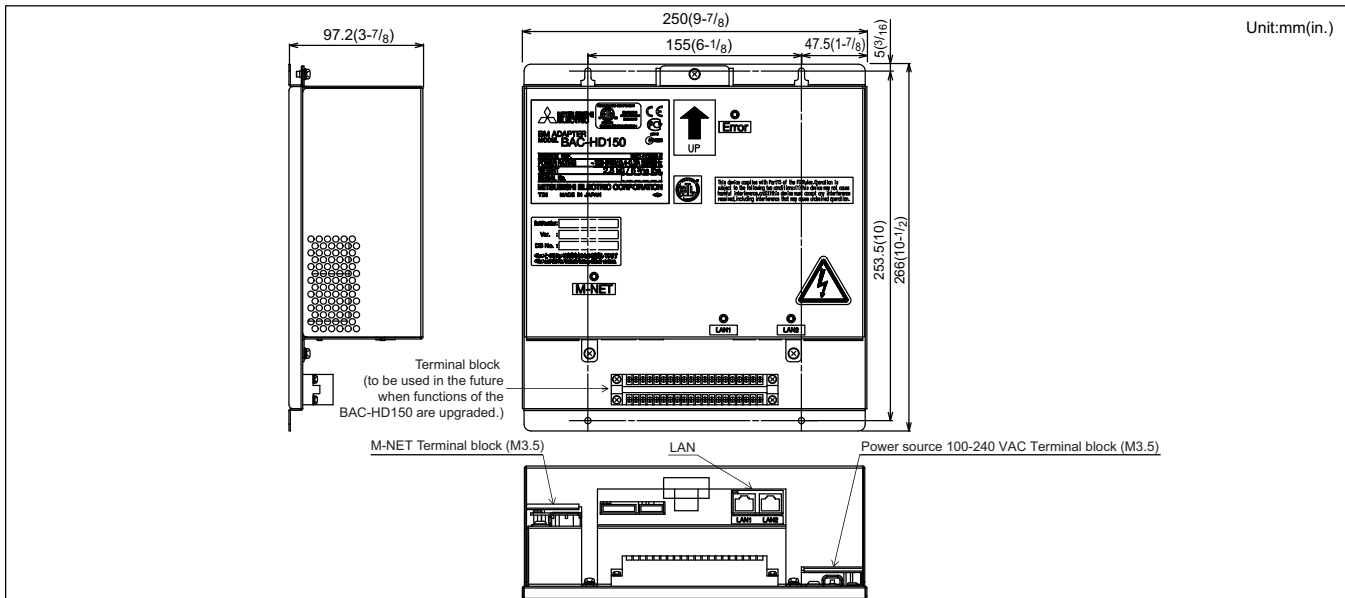

■ System example (Connection of 50 units / groups)

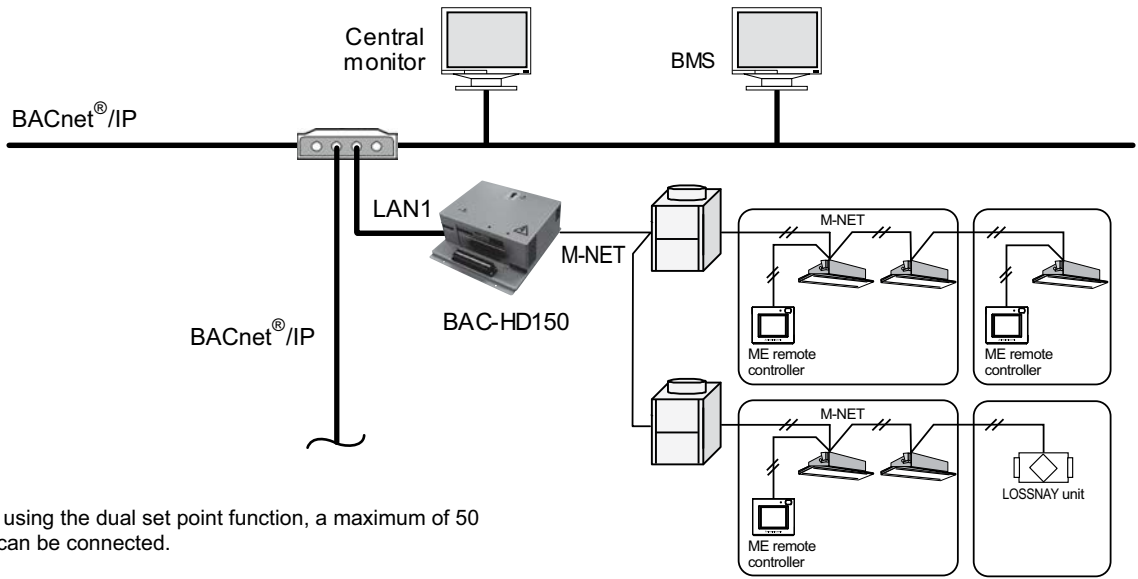

* When using the dual set point function, a maximum of 50 units can be connected.

■ System example (Connection of 150 units / groups with PAC-YG50ECA)

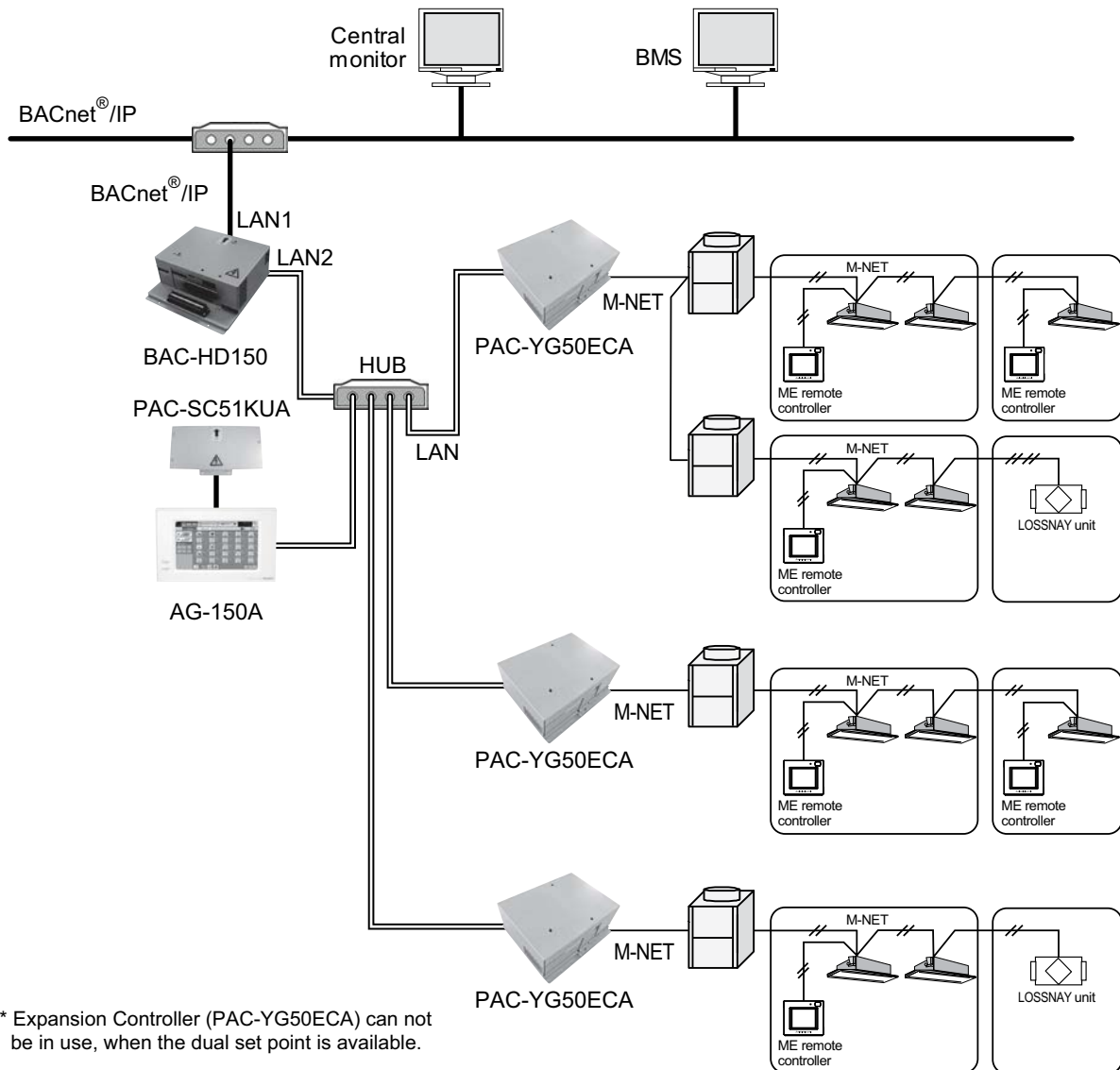

* Expansion Controller (PAC-YG50ECA) can not be in use, when the dual set point is available.

3-13. PLC software for demand input [PAC-YG41CDA]

MITSUBISHI ELECTRIC's CITY MULTI has its intelligent way to carry out peak-cut control while maximizing the air conditioning effect.

System example

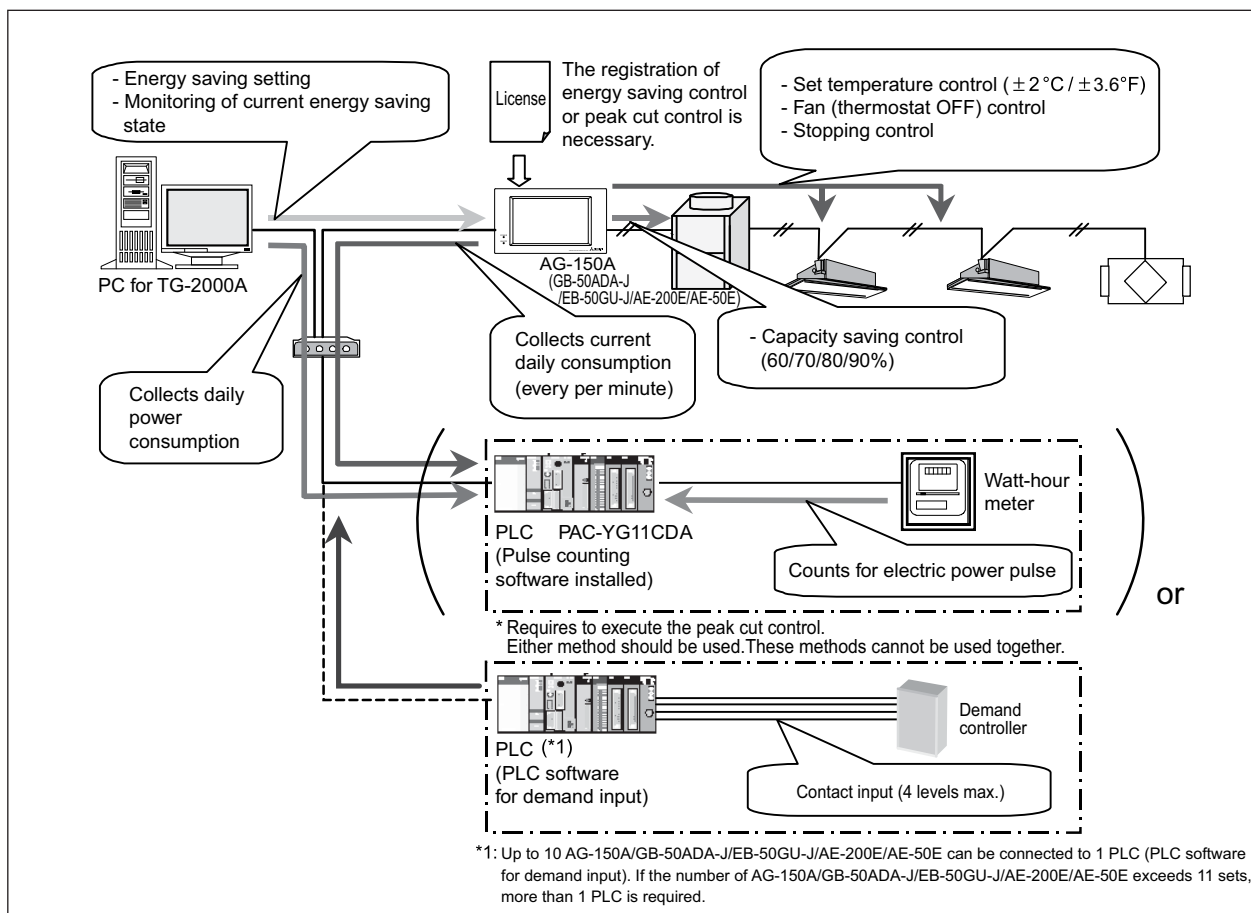

Necessary parts for the system

Name (Model name)	Manufacturer	Remarks
PC for central control	PC/AT convertible unit	Confirmed operation of DELL, HP. For details, refer to AE-200E Technical Manual.
TG-2000A	MITSUBISHI ELECTRIC	The latest version is recommended.
AG-150A/GB-50ADA-J/EB-50GU-J/AE-200E/AE-50E	MITSUBISHI ELECTRIC	The latest version is recommended.
Energy management license pack	MITSUBISHI ELECTRIC	Requires for each AG-150A/GB-50ADA-J/EB-50GU-J/AE-200E/AE-50E.
Web monitor license	MITSUBISHI ELECTRIC	Requires for each AG-150A/GB-50ADA-J/EB-50GU-J/AE-200E/AE-50E.

Applying the energy saving setting from the integrated centralized control software TG-2000A or Initial setting Web allows conducting the energy saving control by the indoor/outdoor units or peak-cut control by using PLC.

Item		Content
Energy saving control	Indoor unit control	The TG-2000A or Initial setting Web sets the following energy saving items and energy saving time to AG-150A/GB-50ADA-J/EB-50GU-J/AE-200E/AE-50E per operation block. AG-150A/GB-50ADA-J/EB-50GU-J/AE-200E/AE-50E conducts energy saving operation to the indoor units with the set detail. ① Temperature control ($\pm 2^{\circ}\text{C} / \pm 36^{\circ}\text{F}$) ② Fan control (Thermostat ON) ③ Stopping control For the block with temperature difference between set and inlet temperature exceeding the set, the energy saving control set at level 0 is not applied.
	Outdoor unit control ²	The TG-2000A or Initial setting Web sets the following energy saving items and energy saving time to AG-150A/GB-50ADA-J/EB-50GU-J/AE-200E/AE-50E per outdoor unit and the set AG-150A/GB-50ADA-J/EB-50GU-J/AE-200E/AE-50E conducts the energy saving operation for the outdoor unit.
Peak cut control	Power consumption monitoring method ³	Connecting the watt-hour meter (PLC(PAC-YG11CDA)) or PAC-YG60MCA allows conducting energy saving operation meeting the power consumption. The control object and detail are same as that of the energy saving rotated control. One set of the watt-hour meter can be set for each AG-150A/GB-50ADA-J/EB-50GU-J/AE-200E/AE-50E.
	Demand controller method ³ (PAC-YG41CDA)	Energy-saving control that is appropriate to the current demand level is performed by receiving the demand level contact signal from the demand controller using the PLC. An installation of demand input PLC software is necessary to use the PLC. Control targets and control content of this method are the same as those of the energy-saving control. Each PLC unit can control up to ten AG-150A/GB-50ADA-J/EB-50GU-J/AE-200E/AE-50E units to be on the energy-saving control.
Monitoring of energy saving control status/history ¹	Control status	During the energy saving control, the energy saving mark is displayed on the air conditioner group icon of Web, TG-2000A.
	Daily report	Daily power consumption and control level can be monitored by the web, TG-2000A. AG-150A/GB-50ADA-J/EB-50GU-J/AE-200E/AE-50E can hold the data for 3 days max. including that of today, yesterday and the day before yesterday.
	Monthly report	Monthly power consumption can be monitored by the TG-2000A (for 62 days max.). The TG-2000A monitors from PLC for display and storing.

1; Daily Report and Monthly Report are functions that are enabled only when registering the "Energy-saving peak cut control license."TG-2000A must always be kept in operation to gather data on energy-saving control status and the operation history. The auto-output CSV files in the Daily Report and Monthly Report can be saved for two years in the appropriate folders.

"Power consumption and control level" report is available only when "Power consumption monitoring method" is used.

When other methods are used, only reports on the control level will be available.

2; For Mr. Slim units, apply Outdoor Unit Control function only to Inverter type units.

3; For further detail, please refer to Technical Manual of AG-150A/GB-50ADA-J/EB-50GU-J/AE-200E/AE-50E and TG-2000A.

3-14. LONWORKS® interface [LMAP04-E]

CITY MULTI can easily combine into a Building Management System (BMS) via the LONWORKS® and M-NET adapter LMAP04-E. LONWORKS® is an opened transmission protocol widely used at BMS, and related equipment control. CITY MULTI is therefore compatible with large-scaled BMS management via LONWORKS®.

One LMAP04-E serves up to 50 indoor units. (CITY MULTI, Mr.Slim, and LOSSNAY.)

■ System example

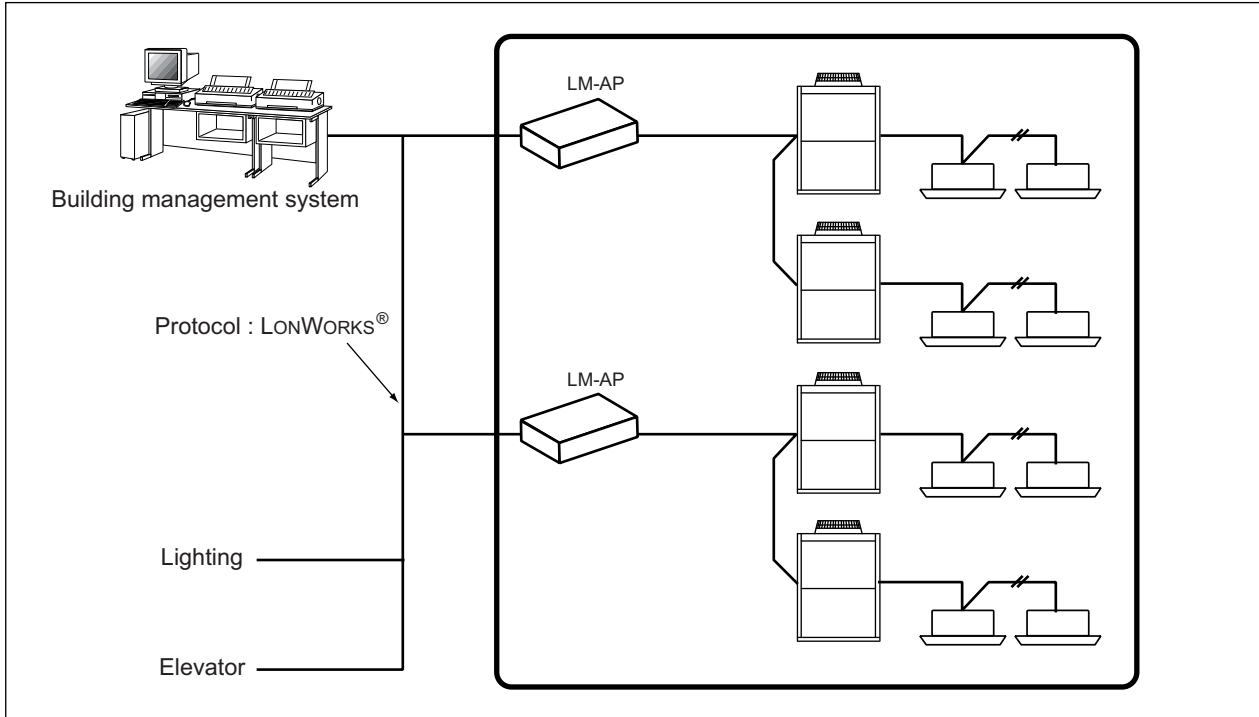

Communication items at LONWORKS® and M-NET Adapter LMAP04-E

Operation	On/Off Mode Set point from network (Set temp.) Fan speed Prohibit local On/Off Prohibit local Mode Prohibit local Set temp. Collective Local Prohibit Forced Thermostat OFF Filter Sign Reset Time Stamp Limit Temperature Setting Range Simplified Locking Batch Off	State Monitoring	Emergency On/Off Collective On/Off Mode Set point from network (Set temp.) Fan speed Prohibit local On/Off Prohibit local Mode Prohibit local Set temp. Collective Local Prohibit Forced Thermostat OFF Run Time for Filter
	Set point from network (cool) Set point from network (heat) Set point from network (auto)		Indoor temperature Defrost Group Number Alarm signal Collective Alarm for Indoor Unit Collective Alarm for LM ADAPTER Error Code Error Address Thermo On/Off state_1 (*1) Thermo On/Off state_2 (*1) Model Code (*1) Set point from network (cool) Set point from network (heat) Set point from network (auto)

Note

*1: This product does not have a charge function.
 The charge (apportioning) function must be prepared separately in the master system.

■ Environment specification

Item	Description	
Connected Equipment	MITSUBISHI ELECTRIC Multiple split-type air conditioners Split-type air conditioners Heat recovery ventilators CITY MULTI Mr.Slim LOSSNAY (*For details of the connectable models, please contact the dealer.)	
Number of Units	LM-AP can control 50 indoor units (including LOSSNAY)	
Neuron CHIP	TMPN3150/FT3150-P20 (10MHz)	
Network Transceiver	FTT-10A/FT-X1 (Free Topology 78kbps)	
Performance	Average communication capacity	2.5 inputs/second
	Peak communication capacity	50 inputs/second (for one second)

- * The proper communication is not obtainable when communication intervals exceed its performance, assure sufficient intervals.
- * ACK Service is recommended for the network service.
- * Detailed specifications for the LONWORKS® network can be found in "FTT-10A Free Topology Transceiver User's Guide" or "FT3120/FT3150 Smart Transceiver Data Book" by Echelon Corporation.

<LMAP04-E Network Variables>

Please obtain the Network Variables Specification for details from your dealer.

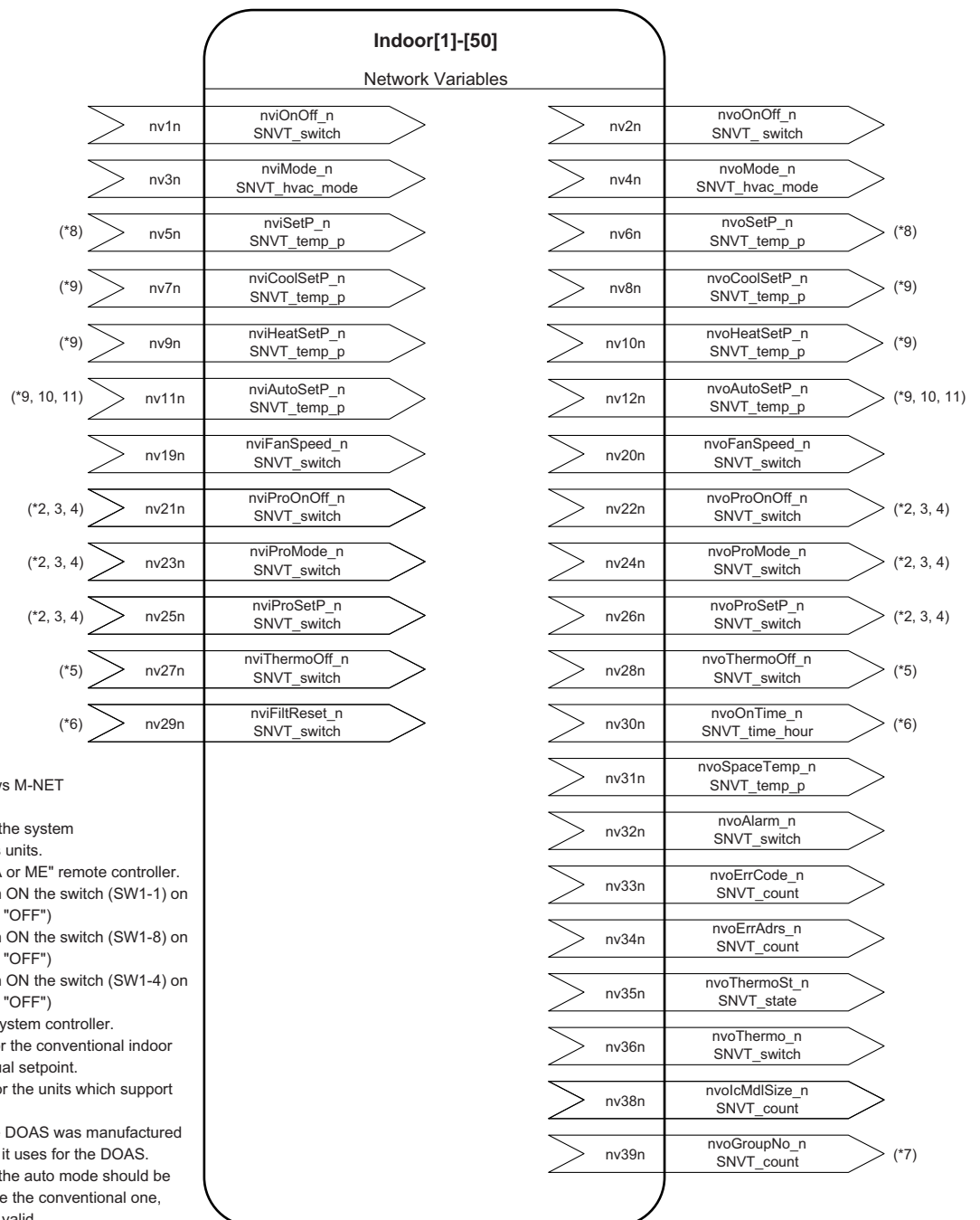

Notes

- *1: "n" of the network variable shows M-NET address of indoor units.
- *2: It may be unable to be used by the system configuration of air-conditioners units.
- *3: It is possible to use with an "MA or ME" remote controller.
- *4: For the use of this function, turn ON the switch (SW1-1) on LM ADAPTER. (Factory setting "OFF")
- *5: For the use of this function, turn ON the switch (SW1-8) on LM ADAPTER. (Factory setting "OFF")
- *6: For the use of this function, turn ON the switch (SW1-4) on LM ADAPTER. (Factory setting "OFF")
- *7: It is possible to use with other system controller.
- *8: This function is available only for the conventional indoor units which don't support the dual setpoint.
- *9: These functions are available for the units which support the dual setpoint.
- *10: This function is available for the DOAS was manufactured in October, 2012 or later, when it uses for the DOAS.
- *11: This function is available when the auto mode should be controlled by single set point like the conventional one, even when the dual set point is valid.

External dimension

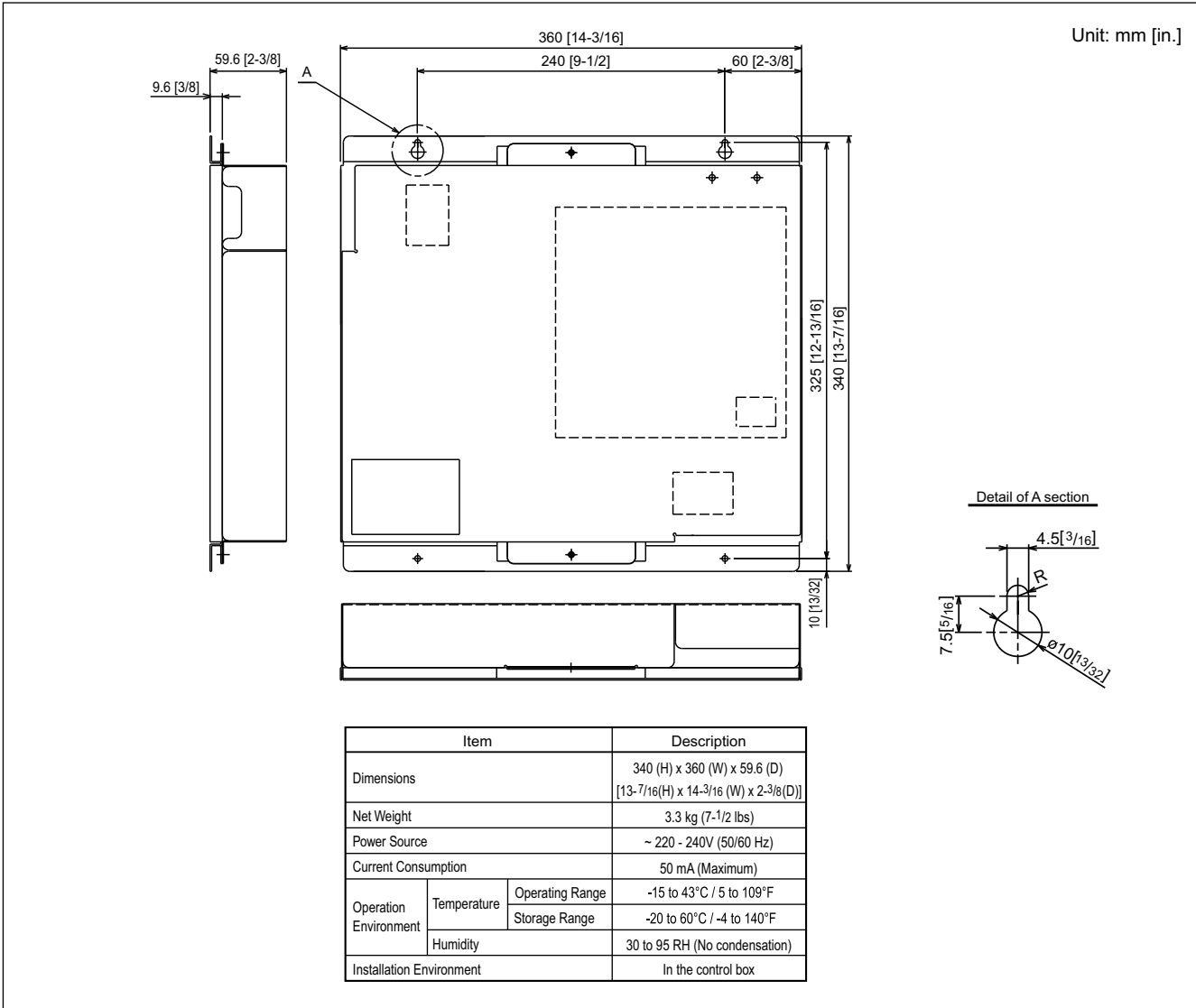

3-15. Transmission booster [PAC-SF46EPA]

The Outdoor unit supplies transmission power 30VDC for the indoor-outdoor transmission line at its connector TB3 and TB7. The power is consumed by the Indoor unit, ME remote controller, and System controllers. When the total quantity of Indoor units, and ME remote controller, and System controllers is over 40, or when transmission power supply is not enough, the transmission booster PAC-SF46EPA should be designed into the air-conditioner system to ensure the system communication. Indoor units sized P200 and 250 are counted as 2 units.

1. Designing PAC-SF46EPA into an air-conditioner system.

Taking the power consumption of Indoor unit sized P15-P140 as 1, the equivalent power consumption or supply of others are listed at Table 1 and Table 2.

Table 1 The equivalent power consumption

Indoor, OA unit	Indoor unit	BC controller	PWFY			MARC. LOSSNAY	ME Remote Contr.		System Contr.			ON/OFF Contr.	MN Converter	Outdoor unit
Sized P15-P140 GUF-50, 100	Sized P200, P250	CMB	P100VM -E-BU	P100VM -E1-AU P100VM -E2-AU	P200VM -E1-AU P200VM -E2-AU	PAR-31MAA(E) PAC-YT52CRA PAR-FA32MA LGH-RVX-E PZ-61DR-E PZ-43SMF-E	PAC-YG60MCA PAC-YG66DCA PAC-YG63MCA	PAR-U02MEDA PAC-IF01AHC	AE-200E AE-50E	AG-150A EB-50GU-J	AT-50B	PAC -YT40ANRA	CMS-MNG-E	TB7 power consumption
1	7	2	6	1	5	0	1/4	1/2	0	1/2	4	1	2	0

*RC : Remote Controller

Table 2 The equivalent power supply

Transmission Booster	Power supply unit	Expansion controller	BM ADAPTER	System Controller		Outdoor unit	Outdoor unit
PAC-SF46EPA	PAC-SC51KUA	PAC-YG50ECA	BAC-HD150	AE-200E/AE-50E	GB-50ADA-J	Connector TB3 and TB7 total *	Connector TB7 only
25	5	6	6	0 ^{*1}	6	32	6

*If PAC-SC51KUA is used to supply power at TB7 side, no power supply need from Outdoor unit at TB7, Connector TB3 itself will therefore have 32. Not applicable to the PUMY model.

*1 AE-200E/AE-50E has a built-in function to supply power to the M-NET transmission line. The amount of power that an AE-200E or an AE-50E can supply is equivalent to the power required by an MN converter (CMS-MNG-E) that is used for maintenance.

Transmission booster PAC-SF46EPA has equivalent transmission power 25.

With the equivalent power consumption values in Table 1 and Table 2, PAC-SF46EPA can be designed into the airconditioner system to ensure proper system communication according to A, B, C.

- (A) Firstly, count from TB3 at TB3 side the total quantity of Indoor units, OA processing units and ME remote controller, and System controllers. If the total quantity reaches 40, a PAC-SF46EPA should be set. In this case, Indoor units sized P200 and 250 are counted as 2 indoor units, but MA remote controller(s), PZ-61DR-E, and PZ-43SMF-E are NOT counted.
- (B) Secondly, count from TB7 side to TB3 side the total transmission power consumption. If the total power consumption reaches 32, a PAC-SF46EPA should be set. Yet, if a PAC-SC51KUA or another controller with a built-in power supply, such as PAC-YG50ECA, is used to supply power at TB7 side, count from TB3 side only.
- (C) Thirdly, count from TB7 at TB7 side the total transmission power consumption, If the total power consumption reaches 6, a PAC-SF46EPA should be set.

External dimension

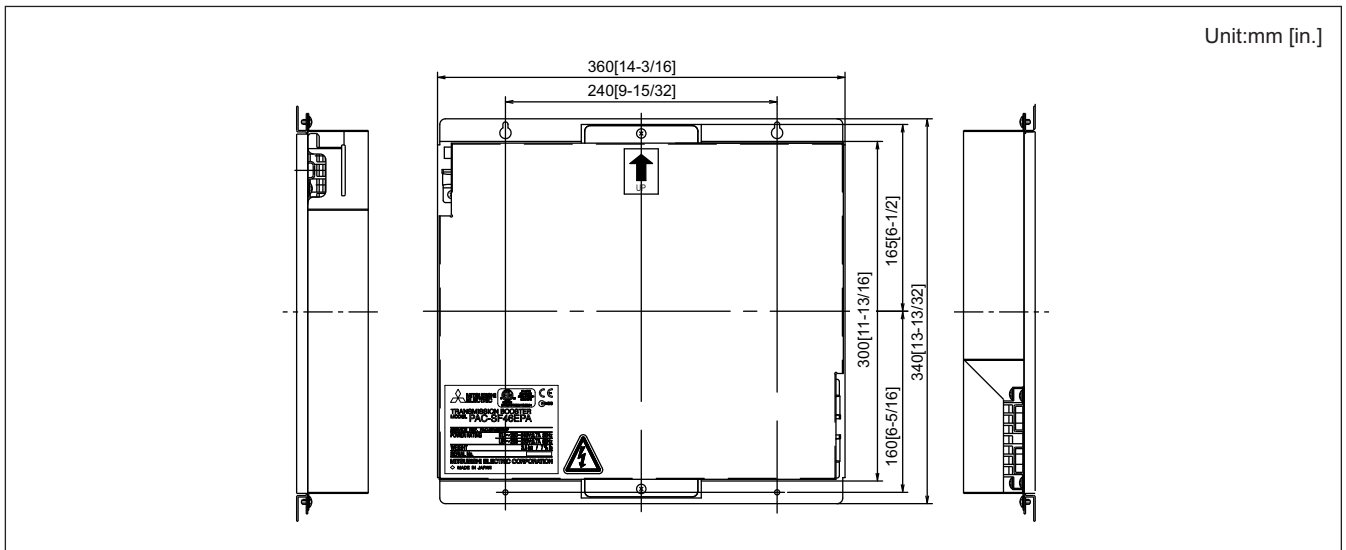

3-16. AHC ADAPTER [PAC-IF01AHC-J]

Advanced HVAC CONTROLLER (hereafter referred to as AHC) comprises of MITSUBISHI ELECTRIC's AHC ADAPTER (PAC-IF01AHC-J) and α2 SIMPLE APPLICATION CONTROLLER* (hereafter referred to as ALPHA2).

* α2 SIMPLE APPLICATION CONTROLLER is one of the Programming Logic Controllers that are manufactured by MITSUBISHI ELECTRIC CORPORATION.

AHC allows for the connection of MITSUBISHI ELECTRIC's air conditioning network system (hereafter referred to as M-NET) to other systems, which was not possible with the use of ALPHA2 alone. AHC provides the following functions.

- 1) Controls external devices using the sensor data of the air conditioning units connected to M-NET.
- 2) Interlocks the operation of air conditioning units and external devices that are connected to ALPHA2.
- 3) Controls air conditioning units that are connected to M-NET.
- 4) Allows for the combined use of the items 1)-3) above.
- 5) Monitors the input/output status of ALPHA2 via a remote controller or a centralized controller.

Compatible controllers [As of April 2013 (North America); June 2013 (outside North America)]

- Remote Controller: PAR-U01MEDU, PAR-U02MEDA
- Centralized Controller: EB-50GU-A, EB-50GU-J

* Refer to the manual that came with ALPHA2 for information about ALPHA2.

* The use of AHC ADAPTER requires either a remote controller or a centralized controller.

External Dimensions

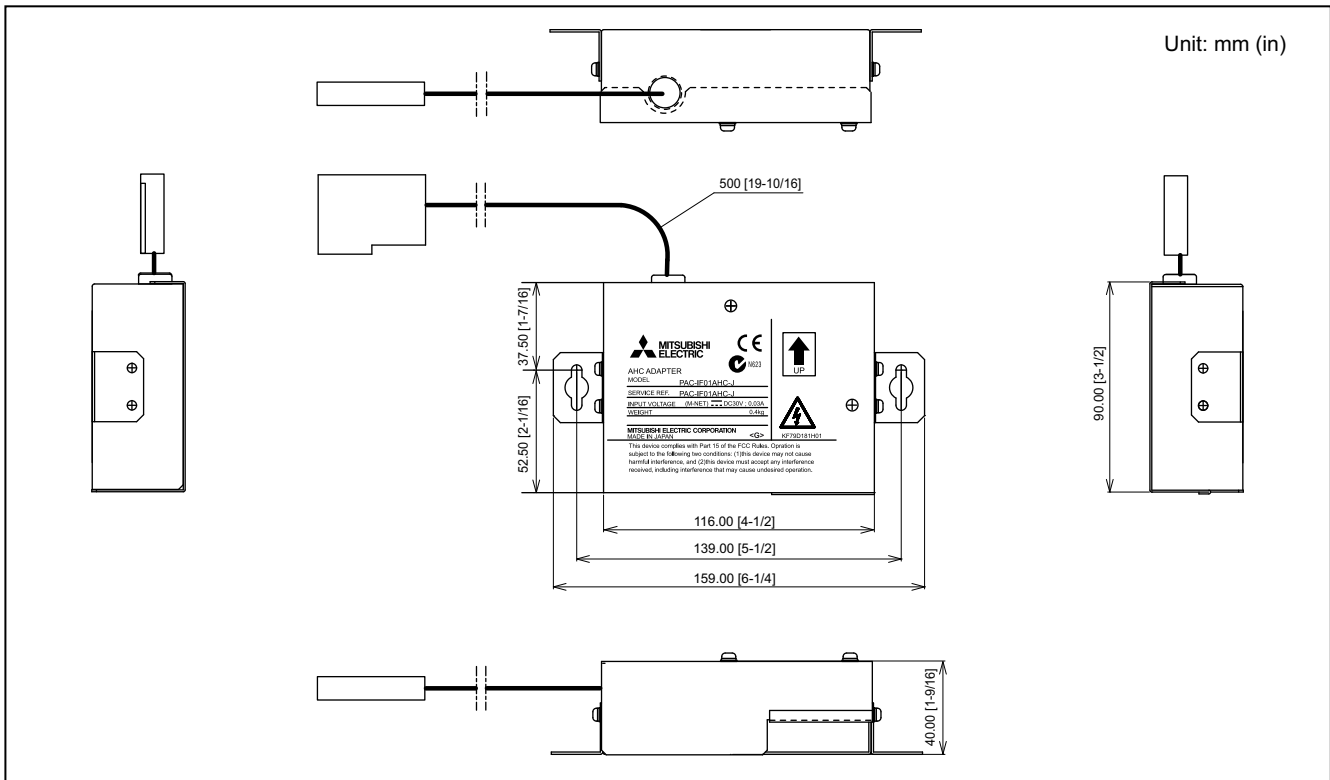

Usage Restrictions

- This manual contains explanations and figures to help the user to properly install, program, and operate AHC.
- All the examples and figures contained in this manual are there for the sole purpose of clarification. It is not guaranteed that AHC will properly work in the types of applications used as examples or are shown in figures. MITSUBISHI ELECTRIC shall not be held responsible for any damage or loss that may result from the use of AHC in the manners shown in the examples and figures contained in this manual.
- Thoroughly read the technical manual, and check the surrounding for safety before changing the settings of AHC in operation (e.g., changing programs or parameters, forcing signal output, or changing the operation status).



1. Specifications

(1) Device specifications

Item		Specifications	
Power supply	M-NET	17–32 VDC	
Interface	M-NET transmission terminal	Exclusively for connection to M-NET	
	Connector for ALPHA2	Exclusively for connection to ALPHA2	
Ambient conditions	Temperature	Operating temperature range	-10°C – +55°C [+14°F – +131°F]
		Storage temperature range	-20°C – +60°C [-4°F – +140°F]
	Humidity		30%–90% RH (Non-condensing)
Dimensions (W × H × D)		116 × 90 × 40 mm [4-9/16 × 3-1/2 × 1-9/16 in.]	
Weight		0.4 kg [0.9lbs]	
Installation conditions		Inside the metal control box * To be used in a business office or similar environment	

1) System configuration

The figure below only shows the transmission cable connections. Power cables are omitted.

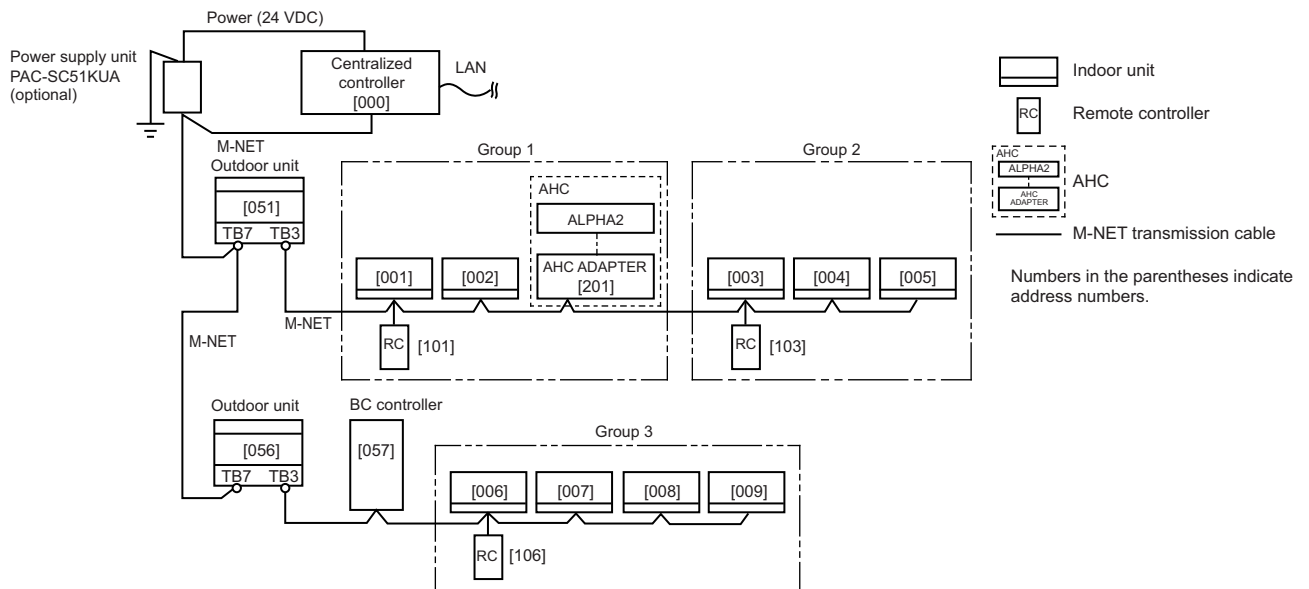

* AHC ADAPTER requires either an outdoor unit or a power supply device as a power source.

2) Functions

AHC comprises of an ALPHA2 and an AHC ADAPTER. The use of AHC ADAPTER requires the use of ALPHA2.

The following ALPHA2 are compatible with AHC. Other types of ALPHA2 do not support AHC.

- AL2-14MR-A
- AL2-14MR-D
- AL2-24MR-A
- AL2-24MR-D

Compatible controllers [As of April 2013 (North America); June 2013 (outside North America)]

- Remote Controller: PAR-U01MEDU, PAR-U02MEDA
- Centralized Controller: EB-50GU-A, EB-50GU-J

AHC enables the connection of M-NET with other systems, which was not possible with the use of ALPHA2 alone. AHC supports the functions listed in Table 1.

Table 1 AHC function list

AHC function	Example	Supplemental Inf.
1) Controls external devices using the sensor data of the air conditioning units connected to M-NET.	<ul style="list-style-type: none"> External heaters are controlled, using the temperature sensors on air conditioning units or on remote controllers. 	By using the sensor on the air conditioning unit connected to the M-NET, no other external sensors will be required.*1
2) Interlocks the operation of air conditioning units and external devices that are connected to ALPHA2.	<ul style="list-style-type: none"> The operation of external heaters is interlocked with the operation of air conditioning units in heating operation. The operation of external humidifiers is interlocked with up to 16 air conditioning units. Humidifiers will go into operation whenever at least one air conditioning unit is in operation. 	Operation status data of a maximum of 2 groups of units can be simultaneously collected. Each group can contain a maximum of 16 units. Error status of a maximum of 50 units can be simultaneously collected.
3) Controls air conditioning units that are connected to M-NET.	<ul style="list-style-type: none"> The ON/OFF operation of air conditioning units is interlocked with the insertion/removal of a card into or out of a card reader. 	A maximum of 2 groups of units can be simultaneously controlled. Each group can contain a maximum of 16 units.
4) Allows for the combined use of the items 1)-3) above.	<ul style="list-style-type: none"> Drying operation of air conditioning units is controlled, using the built-in humidity sensor on the remote controller. 	
5) Monitors the input/output status of ALPHA2 via a remote controller or a centralized controller.		

*1 The sensor on the air conditioning unit connected to the M-NET will collect data at 70-second intervals. If a real time control at intervals shorter than 70 seconds is required, connect a sensor to the Analog Input on ALPHA2.

Note: For detailed information about the functions supported by AHC, refer to the technical manual that came with the AHC.

(2) Field-supplied items

The following items are required to install AHC ADAPTER.

* Two types of installation options (A and B in the table below) are available for AHC ADAPTER. Select the one that is best suited for a given environment.

Field-supplied items	Specifications
A Unit fixing screw (required when using L-fittings)	M4 x 2 pcs.
B DIN rail and fixing screw (required when using DIN rails)	DIN rail width: 35 mm (1-13/32 in) Applicable type (IEC 60715/DIN 60715): TH35-7.5Fe, TH35-7.5Al
Functional ground wire	* Use a wire with an appropriate diameter so that the wire can be fixed with the cable strap below the terminal block. A diameter of 10 mm is recommended.
Sleeved ring terminal	M3.5 ring terminal (for M-NET transmission cables (A, B, S)) M4 ring terminal (for functional ground wire)
Transmission cable	<ul style="list-style-type: none"> CVVS Min. 1.25 mm² (Min. AWG 16) * CPEVS: PE*1 insulated PVC*1 jacketed shielded communication cable * CVVS: PVC*1 insulated PVC*1 jacketed shielded control cable * Use cables with an appropriate diameter so that the cables can be fixed with the cable strap below the terminal block. A diameter of 10 mm is recommended.

*1 PE: Polyethylene; PVC: Polyvinyl chloride

[Parts to be Purchased Separately]

Name	Model	Application	Remark
Power supply unit	PAC-SC51KUA	Power supply to the M-NET transmission line	This is not required when power is to be supplied from an outdoor unit.

[ALPHA2 components]

Name	Model	Power source specification	Optional module (Note 1)	Number of ports				Remark
				Digital Input (DI)	Analog Input (AI)(Note 2)	Digital Output (DO)	Analog Output (AO)(Note 2)	
ALPHA2	AL2-14MR-D	Requires a separate 24 VDC power source.	-	8	(8)*	6	-	
			AL2-4EX	12	(8)*	6	-	
			AL2-4EYT or AL2-4EYR	8	(8)*	10	-	
			AL2-2DA	8	(8)*	6	2	
	AL2-24MR-D	Requires a separate 24 VDC power source.	-	15	(8)*	9	-	
			AL2-4EX	19	(8)*	9	-	
			AL2-4EYT or AL2-4EYR	15	(8)*	13	-	
			AL2-2DA	15	(8)*	9	2	
	AL2-14MR-A	Requires a separate 100-240 VAC power source.	-	8	-	6	-	
			AL2-4EX-A2	12	-	6	-	
			AL2-4EYR	8	-	10	-	
	AL2-24MR-A	Requires a separate 100-240 VAC power source.	-	15	-	9	-	
AL2-4EX-A2			19	-	9	-		
AL2-4EYR			15	-	13	-		

* The AI ports for the DC type are shared by DI, with a maximum number of 8 AI ports.

* AI and AO cannot be used with the AC type ALPHA2.

(Note 1) I/O Extension Module /Analog Expansion Module
I/O Extension module

- EI: Digital input extension module of ALPHA2. 4 digital input ports can be added.
Type name: AL2-4EX-A2 (AC type) and AL2-4EX (DC type)
- EO: Digital output extension module of ALPHA2. 4 digital output ports can be added.
Type name: AL2-4EYR (AC type) and AL2-4EYT (DC type)

Analog Expansion module

- AO: Analog output extension module of ALPHA2. 2 analog output ports can be used.
Type name: AL2-2DA (DC type)

Only one of the above EI, EO, and AO can be used.

(Note 2) Analog signals that can be used for AI and AO of the DC type ALPHA2

- Analog Input (AI): 0-10V, PT100(*), thermocouple(*)
- (*) To use a PT100 or thermocouple, a temperature sensor module is required separately.
Type name: AL2-2PT-ADP(Pt100 sensor), AL2-2TC-ADP(Thermocouple)
(Converts the Pt100/thermocouple to 0-10V)
- Analog Output (AO): 0-10V, 4-20mA

For details, refer to the ALPHA2 manuals (Installation Manual and Hardware Manual).

[Commercially available parts]

Name	Application	Remark
External 24 VDC power source	Supplies power to the ALPHA2 and/or Extension module.	Check to see if an external 24 VDC power source is required for a specific ALPHA2 and an Extension module.
Sensor	Measures temperature and humidity, etc.	Some sensors require additional parts.

For details, refer to the ALPHA2 manuals (Installation Manual and Hardware Manual).

2. Wiring Instructions

Connecting the Power and M-NET Transmission Cable.

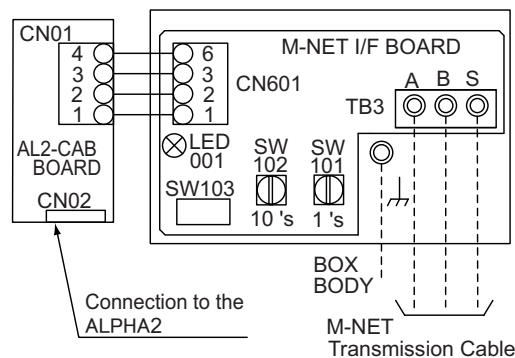

3. Combination and Application Example of the Input Information and Equipment Items

Interlocking with the external Ventilator Using the Start and Stop Information of Multiple Air Conditioners

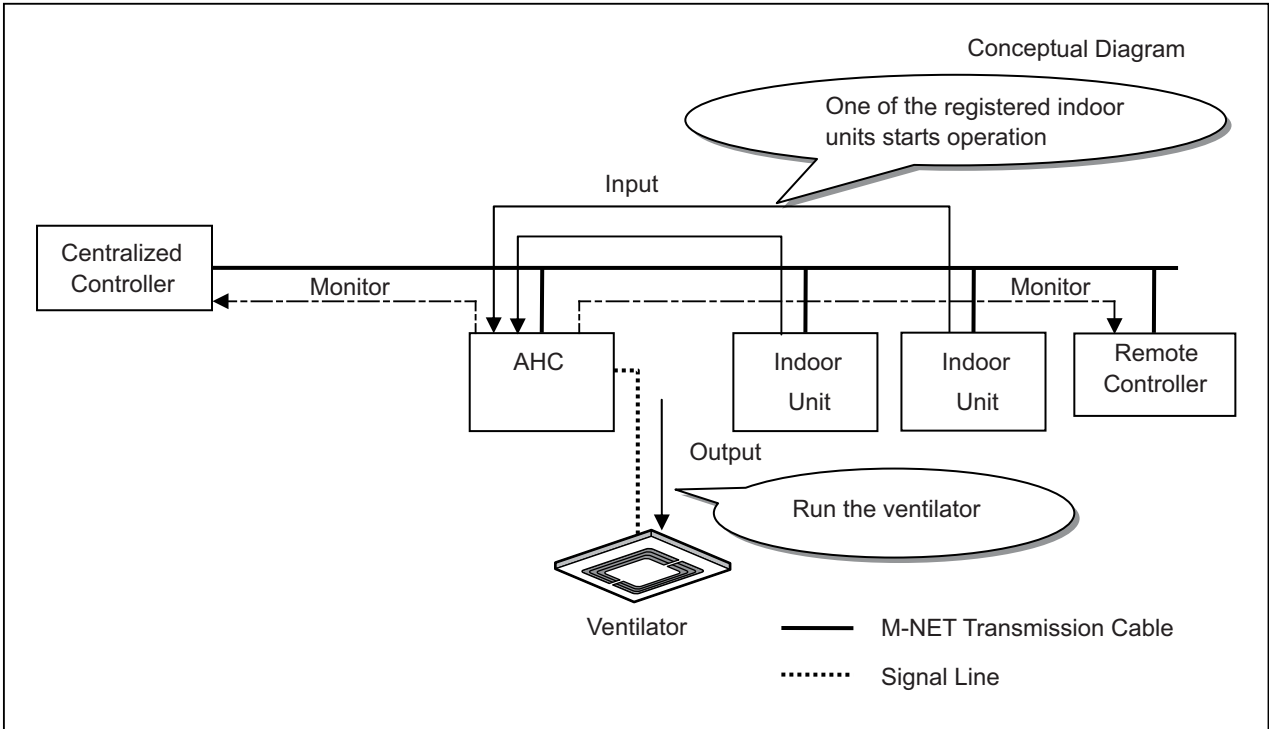

Interlocking the Heater, Humidifier, and Fan

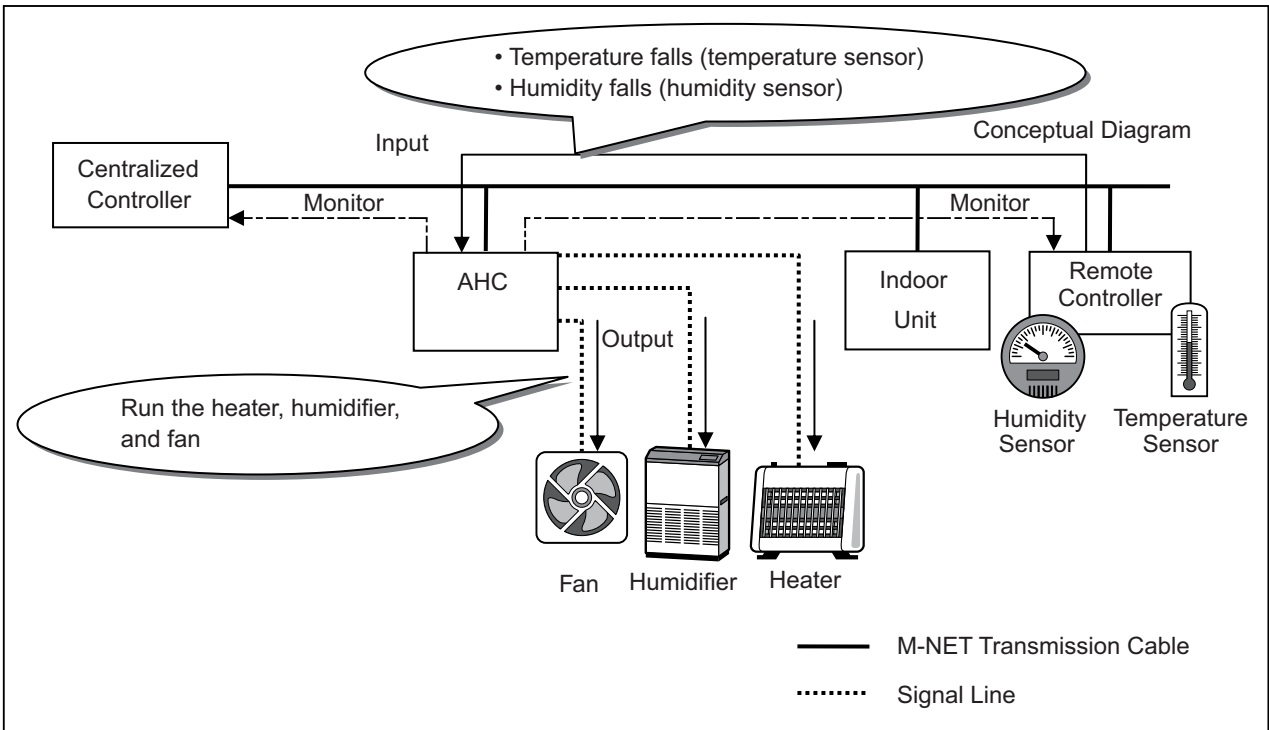

3-17. PI controller [PAC-YG60MCA]

The PI controller counts pulses from a power meter, gas meter, water meter, and calorimeter. Combining the use of the AG-150A/GB-50ADA-J/EB-50GU-J/AE-200E/AE-50E and TG-2000A allows for calculating the charges for each unit and performing peak-cut (e.g., demand control) operation. The meters can be monitored from AG-150A/GB-50ADA-J/EB-50GU-J/AE-200E/AE-50E web browser. They can be monitored on AG-150A/AE-200E/AE-50E LCD.

External Dimensions

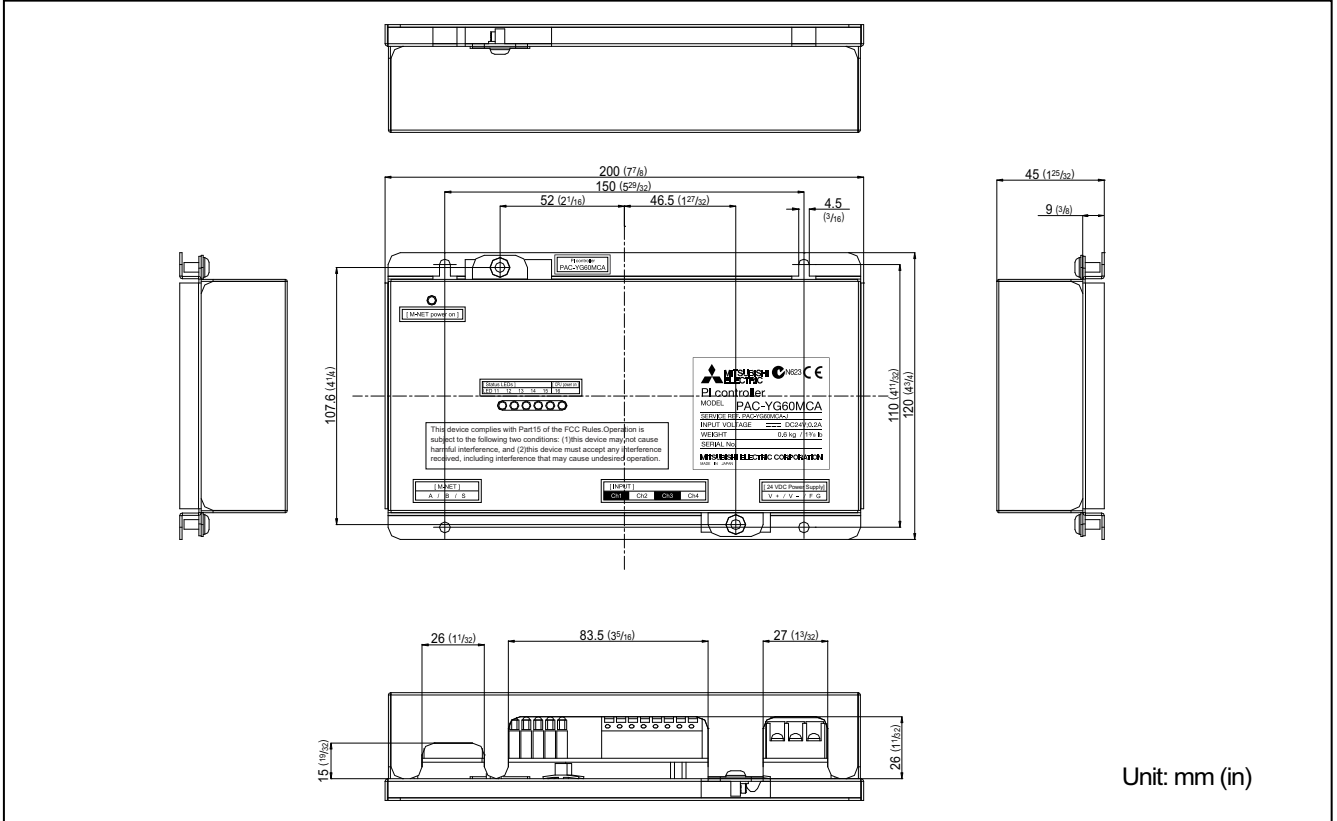

Usage Restrictions

- Mitsubishi Electric does not take financial responsibility for damages caused by issues beyond our control or special circumstances (predicable or unpredictable); and secondary or accidental damages, and damages to other objects. We also do not take financial responsibility for opportunities lost as a result of device failure, or electrical power failure at the end-user site.



CAUTION

Mitsubishi Electric does not take financial responsibility caused by end-users' requests including, but not limited to, device testing, startup, readjustment, and replacement.

- Because the PI controller only counts pulses, accuracy and performance of pulse conversion depend on the meter.

Mitsubishi Electric does not take financial responsibility for damages caused by issues beyond our control or special circumstances (predicable or unpredictable); and secondary or accidental damages and damages to other object.

- Depending on each country's laws and regulations, etc., there may be cases these measured charges cannot be used for certificate of transaction.

1. Specifications

(1). Device Specifications

Item	Rating and Specification		
Power Supply	24 VDC \pm 10%: 5 W		Screw terminal block (M3)(*3)
Interface	M-NET communication	17 to 30 VDC (*1)	Screw terminal block (M3)(*3)
	Non-voltage a-contact input	Number of contacts: 4 Pulse signal: a-contact Pulse width: 100 ms to 300 ms (Idle period until next pulse: 100 ms or more) <div style="text-align: center;"> </div> Rated voltage: 24 VDC Rated current: 1 mA or less (*2)	Screwless terminal block
Environment Conditions	Temperature	Operating temperature range	0 to 40°C [32°F to 104°F]
		Storage temperature range	-20 to 60°C [-4°F to 140°F]
	Humidity	30 to 90%RH (no condensation)	
Dimensions	200 (W) \times 120 (H) \times 45 (D) mm / 77/8 (W) \times 43/4 (H) \times 125/32 (D) in		
Weight	0.6 kg / 13/8 lbs		
Time Backup During Power Failure	In the event of power failure or shut-off, the internal capacitor will continue to track time for approximately one week. (The internal capacitor takes about 24 hours to fully charge; a replacement battery is not necessary.)		
Installation Environment	Inside the metal control board (indoors) * Use this product in a hotel, a business office environment or similar environment.		

*1: Supply electric power from a power unit for the transmission line or an outdoor unit. Furthermore, the power consumption factor of the M-NET circuitry of this device is "1/4".

*2: Supply electric power from the main unit to the contacts of the meters.

*3: M3 is the size of the screw on the terminal block (ISO metric screw thread). The number indicates the screw diameter (mm).

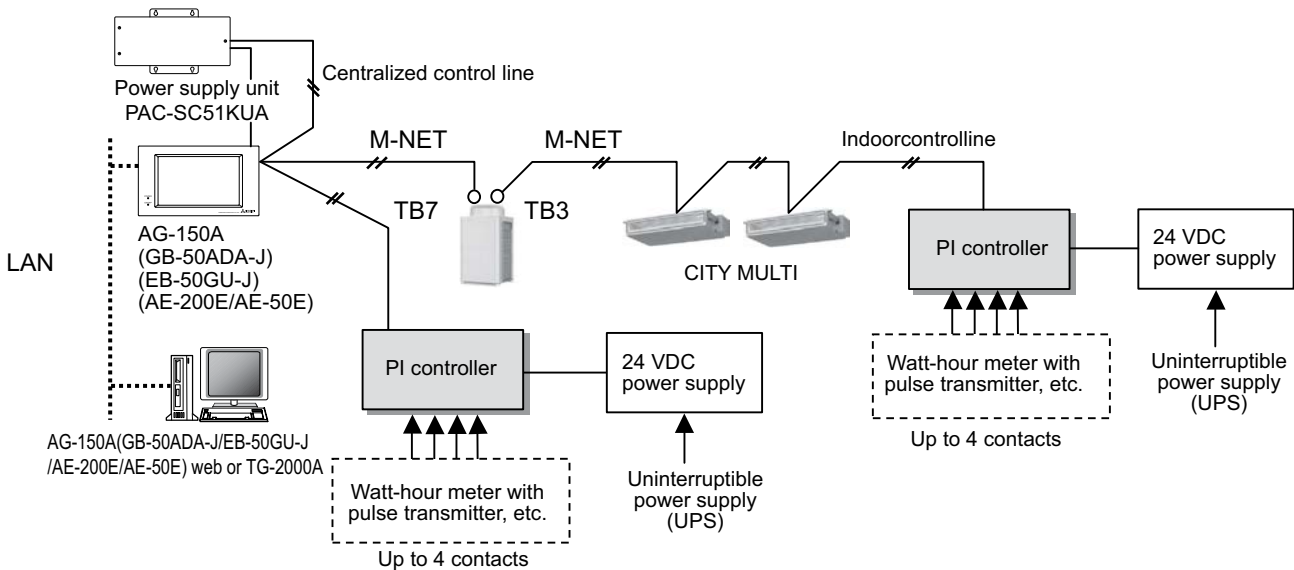

*This figure omits the power supply line and only shows the transmission line.

<Restrictions>

Maximum of 15 units (total of 60 channels) per AG-150A/GB-50ADA-J Ver. 2.45 or later and EB-50GU-J/AE-200E/AE-50E

Maximum of 5 units (total of 20 channels) per AG-150A (Expansion controller)/GB-50ADA-J/EB-50GU-J Ver. 2.45 or earlier

However, the number of units that can be connected to one AG-150A/GB-50ADA-J/EB-50GU-J/AE-200E/AE-50E is up to 50 including this device, indoor units, LOSSNAY units, etc.

NOTE

- For the shield ground of the M-NET centralized control line for central control, use single-point grounding at the power unit for the transmission line.
However, when supplying electric power to the M-NET centralized control line from the R410A series outdoor unit^{*1} without using a power supply unit for the transmission line, use single-point grounding at the TB7 of that outdoor unit. *1 : Except PUMY model.
Furthermore, when connecting this device to the M-NET indoor control line, use grounding at the TB3 for each outdoor unit system.
- Connecting an Uninterruptible power supply (UPS) to the 24 VDC power supply is recommended in order to prevent the loss of pulse data in the event of a power failure.
If a UPS cannot be connected, try to make the AC power supply to the 24 VDC power supply as much same as the AC power supply line to the meters.
- This device does not support level meters. To use a level meter, incorporate a Converter circuit externally and convert to pulse input.
- If the M-NET transmission line of this device is connected to an M-NET indoor control line and the outdoor unit is down because, for example, the power supply is interrupted for servicing or there is a failure, the PI controller cannot be controlled from the system controller.

(2). Parts Purchased Separately

Prepare the following parts to install this device.

Required Part	Specification
Unit fixing screws	M4 screw × 4 (* M4: ISO metric screw thread)
Power supply for this device	Power source: 24 VDC 0.2 A (Minimum loading), SELV circuit, power line with grounding terminal Ripple noise: Lower than 200 mVp-p Compatible specification Authorized or CE marked products Subject to regulations: - IEC60950 (or EN60950) - CISPR22/24 (or EN55022/24) - IEC61000-3-2/3-3 (or EN61000-3-2/3-3)
Power line	Use a sheathed vinyl cord or cable. At least 0.75 mm ² (AWG18)
M-NET transmission line	Type of the cable: Sheathed vinyl cords or cable which comply with the following specifications or equivalent. • CPEV ϕ 1.2 mm to ϕ 1.6 mm • CVVS 1.25 mm ² to 2 mm ² (AWG16 to 14) * CPEV: PE insulated PVC jacketed shielded communication cable * CVVS: PVC insulated PVC jacketed shielded control cable PE: Polyethylene PVC: Polyvinyl chloride Power needs to be supplied to the M-NET circuitry of this device. Use an outdoor unit or a separately purchased power supply unit for the transmission line.
Signal lines	Shows the size of the electric wire (copper wire) that is adapted to the terminal block of this device. Electric wire size..... (1) Solid wire: ϕ 0.65 mm (AWG21) - ϕ 1.2 mm (AWG16) (2) Stranded wire: 0.75 mm ² (AWG18) - 1.25 mm ² (AWG16) Single strand: At least ϕ 0.18 mm

[Parts to be Purchased Separately]

Name	Model	Application	Remark
Power supply unit	PAC-SC51KUA	Power supply to the M-NET transmission line	This is not required when power is to be supplied from an outdoor unit.

[Commercially available parts]

Part	Use	Remark
External 24 VDC power source	Supplies power to the PI controller.	Refer to "Power supply for this device" in "Required Part" above for the capacity of the power supply.

[Recommended Pulse Specifications]

Prepare a measuring instrument that measures the type of pulse signals indicated in table below.

Type	Specification
Output pulse relay method	Semiconductor relay method
Output pulse width	100 ~ 300 ms (100 ms and above) Choose an instrument that outputs non-voltage a-contact point pulse per each pulse output.
Pulse unit	Watt-hour meter: 0.1 kWh/pulse, 1 kWh/pulse recommended Water meter: m ³ /pulse Gas meter: m ³ /pulse Calorimeter: MJ/pulse * Except for the watt-hour meter, select instruments that take measurements in the appropriate pulse unit.

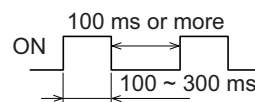

2. Wiring Instructions

(1). Connecting the Power and M-NET Transmission Lines

Tightening torque for terminal screws: 1 N·m

Connect the M-NET transmission line of this device to a power supply unit (PAC-SC51KUA) for the transmission line or an outdoor unit (either a centralized control line or indoor control line can be connected).

* Only the M-NET circuitry of this device receives the power from the M-NET transmission line. The power consumption factor is "1/4".

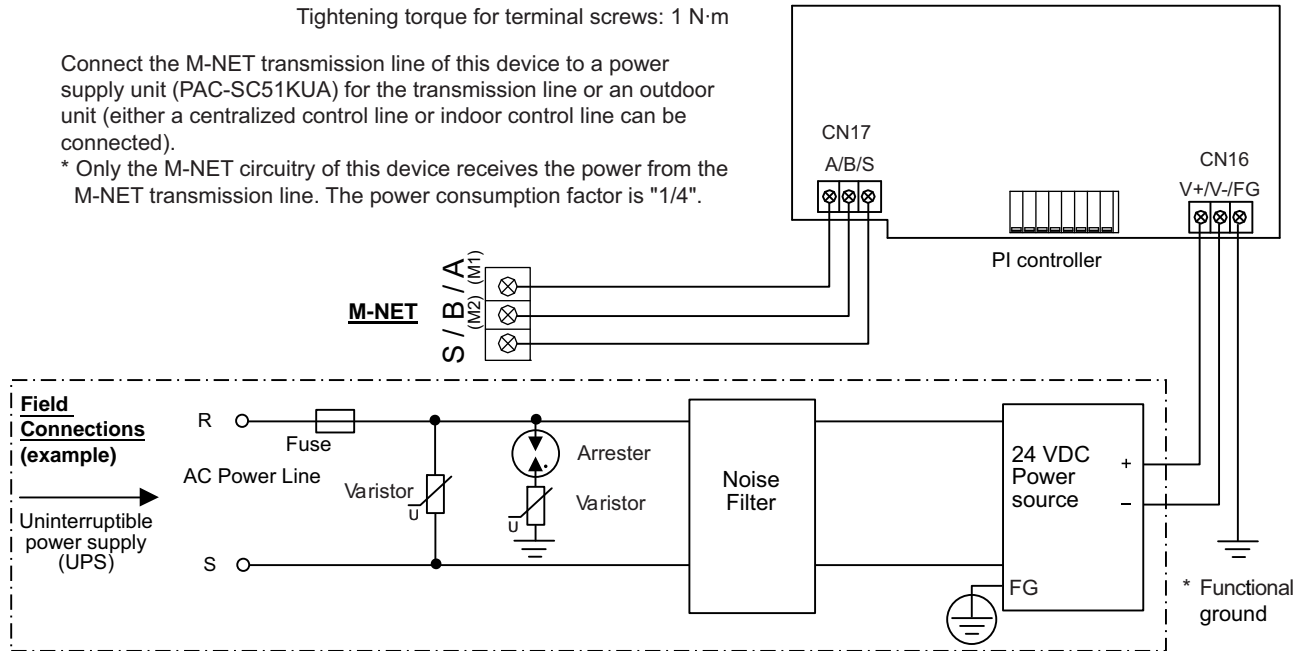

CAUTION

- Use a power line and M-NET transmission line that satisfy the specifications described in "1-(2). Parts Purchased Separately".
- Attach a circuit comprising the following components to the supply primary side of the 24 VDC power supply. (1) Varistor, (2) Arrester, (3) Noise filter, (4) Fuse
- It is important to pay attention to the polarity when connecting to the 24 VDC power supply terminal block. Connecting the positive and negative in the reverse order will cause a failure.
- Fix the power line and M-NET transmission line in place on the outside to ensure that the terminal block is not affected by any external force.
Not securely connecting and fixing the wires in place may cause heat generation and fire.
- Make sure that the copper wiring is not short-circuiting the plates (cover, lower case) or neighboring wires.
Cover the shielded line of the M-NET transmission line with materials such as vinyl tape and prevent short-circuiting with the plates.

(2). Connecting the Signal Lines

- Separately procure items such as terminal blocks and cables locally.
- The maximum wire length is 100 m (328 ft).
However, since the use of long wires makes the device susceptible to noise, using wires shorter than 10 m (32.8 ft) is recommended.

1) Pulse input (non-voltage a-contact)

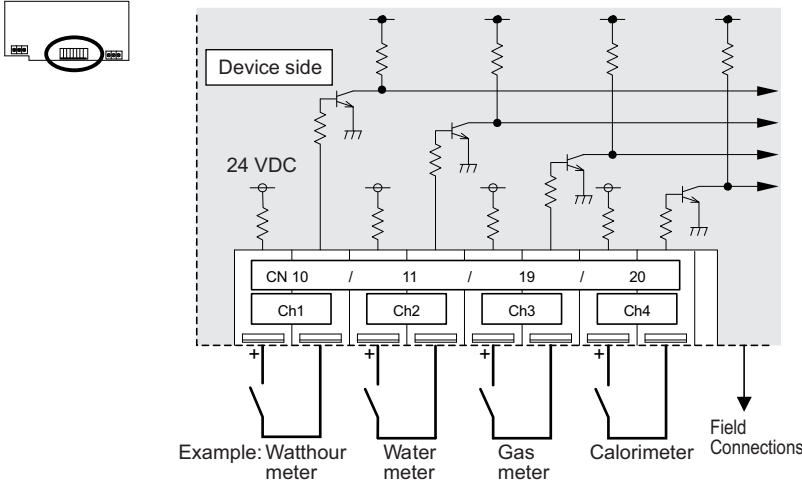

NOTE

- The pulse unit (weight) can be added to each of the inputs of channels 1 to 4.
- Be sure to set the pulse unit (weight) settings from a system controller (AG-150A/GB-50ADA-J/EB-50GU-J or TG-2000A).
If the pulse unit (weight) value has not been set as required, the charge function and peak cut control will not work normally because correct measurement of usage amounts will not be made.
- This device does not support level meters.
To use a level meter, incorporate a Converter circuit externally and convert to pulse input.

CAUTION

- The polarity of the input terminals is important, so be sure to match the polarity when using contacts that have polarity.
- Select a contact with a minimum applicable load of 1 mA or less.
- Supply 24 VDC 1 mA from the positive terminal to the contacts of the meters.
- The pulse unit of the watt-hour meter being used should be 1 kWh/pulse or less. Note that the apportioning error will increase if a watt-hour meter with large pulse unit is used.
- The input signal line should not come into contact with or be installed alongside the M-NET transmission line and power supply line. Care must also be taken to avoid wiring loops.
- Strip 12 ± 1 mm ($15/32 \pm 1/32$ in) of the wire coating and insert firmly into the terminal.
- Make sure that the copper wiring is not short-circuiting the plates (cover, lower case) or neighboring wires.
- Perform wiring so that the terminal block is not strained.
If strained, use a wire guide or junction terminal to alleviate the stress on the terminal block.

3. System Operation Test

Various settings related to the charge operation need to be configured from the TG-2000A prior to starting the charge function operation. Furthermore, in such a case, be sure to perform a charge test run according to the instruction manual for TG-2000A.

Do not turn the power OFF after starting operation. The power rate will not be counted while the power interruption. Forcible pulse input must never be carried out after startup.

3-18. DIDO controller [PAC-YG66DCA]

The DIDO controller is used in combination with a AG-150A/GB-50ADA-J/EB-50GU-J/AE-200E/AE-50E to operate general-purpose equipment, as well as to monitor operating and error status. It is equipped with two sets of standard terminals (Channels 1 and 2), and four sets of expansion connectors for the input/output terminals. Expansion cable is optional.

Other devices can only be controlled from AG-150A/GB-50ADA-J/EB-50GU-J/AE-200E/AE-50E Web browser and TG-2000A. Operation can be monitored or performed from the AG-150A/AE-200E/AE-50E LCD.

In addition, this device includes a function that interlocks M-NET devices such as indoor units, general equipment, etc.

External Dimensions

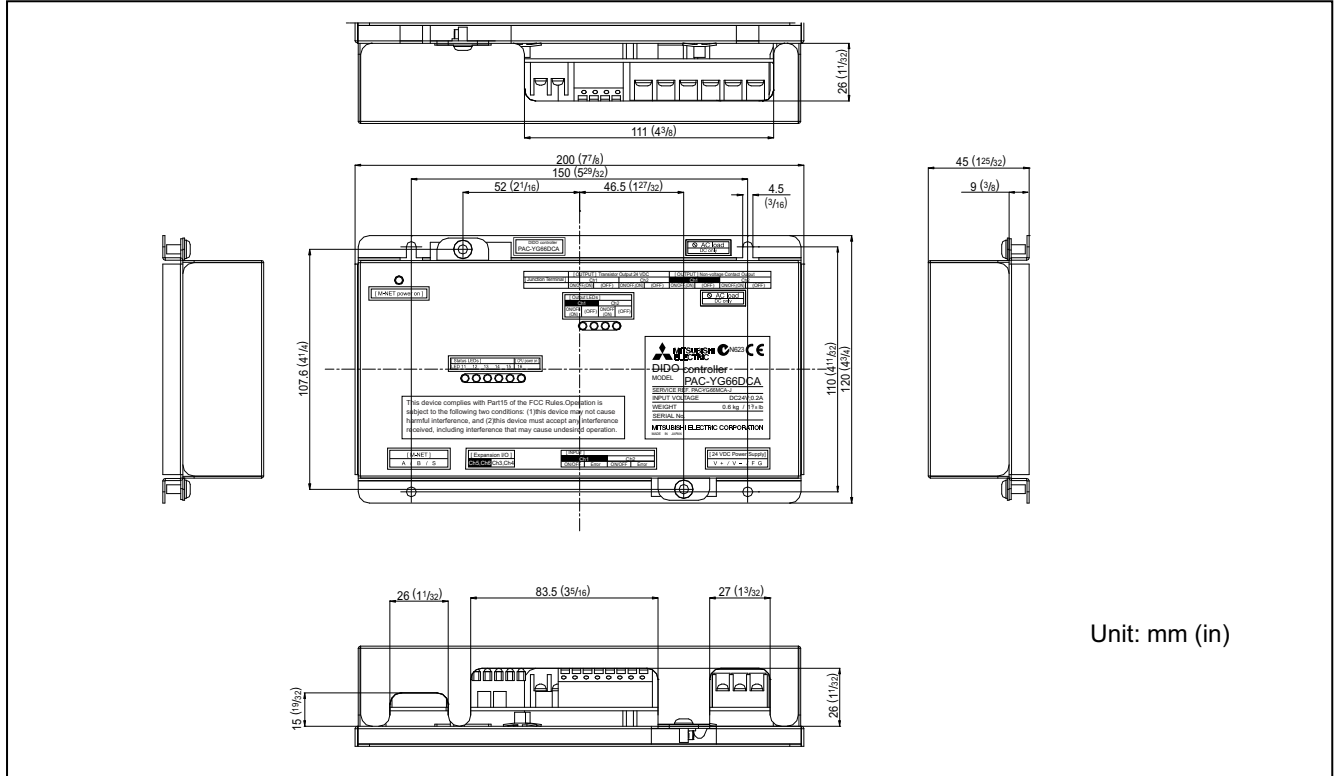

Unit: mm (in)

CAUTION

Usage Restrictions

- Mitsubishi Electric does not take financial responsibility for damages caused by issues beyond our control or special circumstances (predicable or unpredictable); and secondary or accidental damages, and damages to other objects. We also do not take financial responsibility for opportunities lost as a result of device failure, or electrical power failure at the end-user site.
- Mitsubishi Electric does not take financial responsibility caused by end-users' requests including, but not limited to, device testing, startup, readjustment, and replacement.
- Do not use this device in disaster prevention, security, or "critical to life" applications.
- It is recommended to provide an external switch for general-purpose equipment in case of a failure of the DIDO controller or a peripheral part.

1. Specifications

(1). Device Specifications

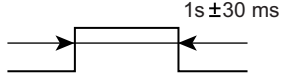
Item	Rating and Specification					
Power Supply	24 VDC \pm 10%: 5 W (*1)				Screw terminal block (M3) (*8)	
Interface	M-NET communication		17 to 30 VDC (*2)		Screw terminal block (M3) (*8)	
	Standard	Output (*3)	ON/OFF, (ON) (*4)	Non-voltage Relay contact (2)	Applied load MAX: 24 VDC, 5 W MIN: 5 VDC, 2 mW * AC loads cannot be connected.	Screw terminal block (M3.5) (*8)
				Transistor (2)	24 VDC 40 mA or less (*5)	Screwless terminal block
			(OFF) (*4)	Non-voltage Relay contact (2)	Applied load MAX: 24 VDC, 5 W MIN: 5 VDC, 2 mW * AC loads cannot be connected.	Screw terminal block (M3.5) (*8)
				Transistor (2)	24 VDC 40 mA or less (*5)	Screwless terminal block
	Input	ON/OFF	Non-voltage a contact (2 each)	24 VDC 1 mA or less (*6)	Screwless terminal block	
		Error/Normal				
	Expansion	Output	ON/OFF, (ON) (*4)	Transistor (4 each)	24 VDC 40 mA or less (*5)	9 pin connector
			(OFF) (*4)			
	Input	ON/OFF	24 VDC input (4 each)	24 VDC 1 mA or less (*7)	9 pin connector	
Error/Normal						
Output Pulse Width		1s \pm 30 ms				
Interlock Function	Interlock M-NET devices and output contacts according to status of input contacts. (*8)					
Environment Conditions	Temperature	Operating temperature range	0 to 40°C [32°F to 104°F]			
		Storage temperature range	-20 to 60°C [-4°F to 140°F]			
	Humidity	30 to 90%RH (no condensation)				
Dimensions	200 (W) × 120 (H) × 45 (D) mm / 7 7/8 (W) × 4 3/4 (H) × 1 25/32 (D) in					
Weight	0.6 kg / 1 3/8 lbs					
Time Backup During Power Failure	In the event of power failure or shut-off, the internal capacitor will continue to track time for approximately one week. (The internal capacitor takes about 24 hours to fully charge; a replacement battery is not necessary.)					
Installation Environment	Inside the metal control board (indoors) * Use this product in a hotel, a business office environment or similar environment.					

*1: For details, refer to "1-(2). Parts Purchased Separately".

*2: Supply electric power from a power unit for the transmission line or an outdoor unit.

Furthermore, the power consumption factor of the M-NET circuitry of this device is "1/4".

*3: Non-voltage Relay contact or transistor is available for output. Only one can be used at a time.

*4: () is in the case of a pulse.

*5: The output is open collector type. Power must be supplied from an external power source to the output circuit of this device.

*6: Power is supplied from this device to the external contacts.

*7: Power must be supplied from an external power source.

*8: M3 and M3.5 are sizes of the screw on the terminal block (ISO metric screw thread).

The number indicates the screw diameter (mm).

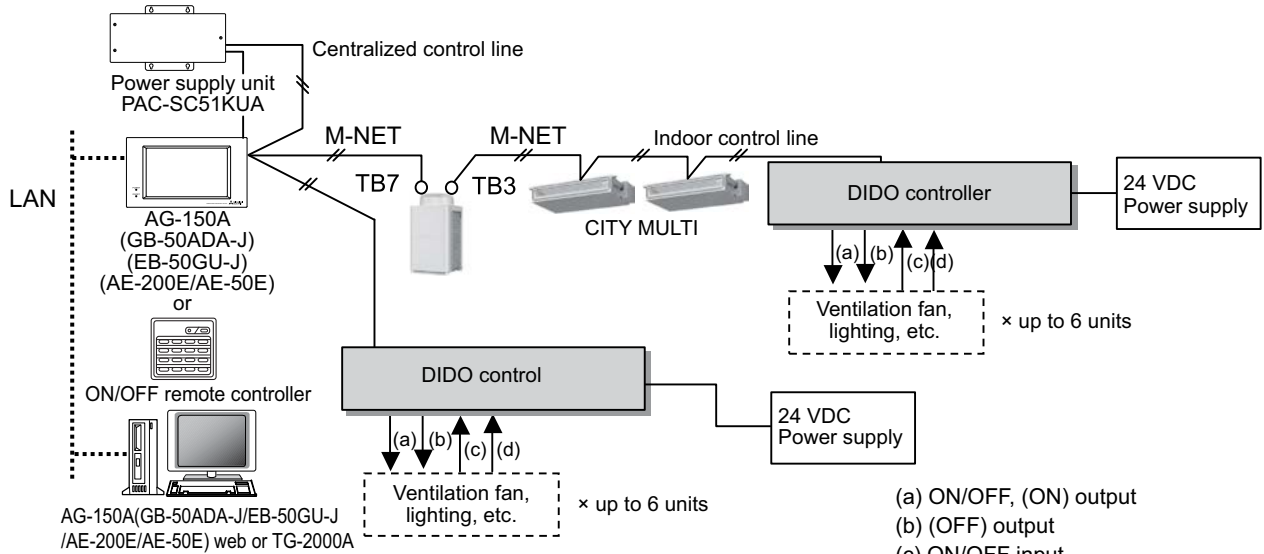

*This figure omits the power supply line and only shows the transmission line.

- (a) ON/OFF, (ON) output
- (b) (OFF) output
- (c) ON/OFF input
- (d) Error/Normal input
- Standard: Terminal block (for 2 units)
- Expansion: Connectors (for 4 units)
- Total: 6 units

<Restrictions>

Maximum of 50 units (50 channels) per AG-150A/GB-50ADA-J/EB-50GU-J/AE-200E/AE-50E
 However, the number of units that can be connected to a AG-150A/GB-50ADA-J/EB-50GU-J/AE-200E/AE-50E is up to 50 including the number of contacts used on this device, an indoor unit, LOSSNAY unit, etc.
 Up to 6 contacts can be connected to the DIDO controller (1 M-NET address). One contact connected to this device is calculated as the equivalent of one indoor unit connected to AG-150A/GB-50ADA-J/EB-50GU-J/AE-200E/AE-50E.
 For example, 5 contacts connected to the DIDO controller are calculated as the equivalent of 5 indoor units connected to AG-150A/GB-50ADA-J/EB-50GU-J/AE-200E/AE-50E.

NOTE

- For the shield ground of the M-NET centralized control line, use single-point grounding at the power unit for the transmission line.
 However, when supplying electric power to the M-NET centralized control line from the R410A series outdoor unit*1 without using a power supply unit for the transmission line, use single-point grounding at the TB7 of that outdoor unit. *1: Except PUMY model.
 Furthermore, when connecting this device to the M-NET indoor control line, use grounding at the TB3 for each outdoor unit system.
- If the M-NET transmission line of this device is connected to the M-NET indoor control line and the outdoor unit is down because, for example, the power supply is interrupted for servicing or there is a failure, the DIDO controller cannot be controlled from the system controller.
- Controlling the ON/OFF remote controller is only possible with channel 1 of a standard terminal block.
- DIDO controller can only be monitored or performed from AG-150A LCD, AG-150A/GB-50ADA-J/EB-50GU-J /AE-200E/AE-50E Web browser and TG-2000A.
- When AG-150A/GB-50ADA-J/EB-50GU-J/AE-200E/AE-50E is connected, monitoring control can only be performed from AG-150A/GB-50ADA-J/EB-50GU-J/AE-200E/AE-50E Web or TG-2000A. Monitoring control cannot be performed from the ON/OFF remote controller.

(2). Parts Purchased Separately

Prepare the following parts to install this device.

Required Part	Specification
Unit fixing screws	M4 screw × 4 (*M4: ISO metric screw thread)
Power supply for this device	<p>Commercially available power source: 24 VDC±10% 0.2 A (Minimum loading), SELV circuit, power line with grounding terminal</p> <p>Ripple noise: Lower than 200 mVp-p</p> <p>Compatible specification</p> <p>Authorized or CE marked products</p> <p>Subject to regulations: - IEC60950 (or EN60950)</p> <p>- CISPR22/24 (or EN55022/24)</p> <p>- IEC61000-3-2/3-3 (or EN61000-3-2/3-3)</p> <p>When using transistor output (including extension output) for the 24 VDC output of this device, increase the capacity to match the number used.</p> <ul style="list-style-type: none"> • 1 set used: 0.3 ADC (Minimum) • 2 sets used: 0.4 ADC (Minimum) • 3 sets used: 0.5 ADC (Minimum) • 4 sets used: 0.6 ADC (Minimum) • 5 sets used: 0.7 ADC (Minimum) • 6 sets used: 0.8 ADC (Minimum) <p>* The increase of the power supply capacity is 0.1 ADC for every set.</p>
Power line	Use a sheathed vinyl cord or cable. At least 0.75 mm ² (AWG18)
M-NET transmission line	<p>Type of the cable: Sheathed vinyl cords or cable which comply with the following specifications or equivalent.</p> <ul style="list-style-type: none"> • CPEV \varnothing1.2 mm to \varnothing1.6 mm • CVVS 1.25 mm² to 2 mm² (AWG 16 to 14) <p>* CPEV: PE insulated PVC jacketed shielded communication cable</p> <p>* CVVS: PVC insulated PVC jacketed shielded control cable</p> <p>PE: Polyethylene PVC: Polyvinyl chloride</p> <p>Power needs to be supplied to the M-NET circuitry of this device. Use an outdoor unit or a separately purchased power supply unit for the transmission line.</p>
Signal lines	<p>Use electric wire of an appropriate size for the terminal block of this device.</p> <p>Electric wire size … (1) Solid wire: \varnothing0.65 mm (AWG21) - \varnothing1.2 mm (AWG16)</p> <p>(2) Stranded wire: 0.75 mm² (AWG18) - 1.25 mm² (AWG16)</p> <p>Single strand: At least \varnothing0.18 mm</p> <p>To use an expansion input/output, use a separately purchased external input/output adapter.</p>

[Parts to be Purchased Separately]

Name	Model	Application	Remark
Power supply unit	PAC-SC51KUA	Power supply to the M-NET transmission line	This is not required when power is to be supplied from an outdoor unit.
External I/O adapter	PAC-YG10HA	Connection adapter for using an expansion input/output	This is required when an expansion input/output is used.

[Commercially available parts]

Name	Application	Remark
External 24 VDC power source	Supplies power when to use the DIDO controller or transistor output.	Refer to "Power supply for this device" in "Required Part" above for the power supply capacity.
Relay device	Requires commercially available relay device depending on the electric specifications with an external device.	

2. Wiring Instructions

(1). Connecting the Power and M-NET Transmission Lines

Tightening torque for terminal screws: 1 N·m

Connect the M-NET transmission line of this device to a power supply unit (PAC-SC51KUA) for the M-NET transmission line or an outdoor unit (either a centralized control line or indoor control line can be connected).

* Only the M-NET circuitry of this device receives the power from the M-NET transmission line. The power consumption factor is "1/4".

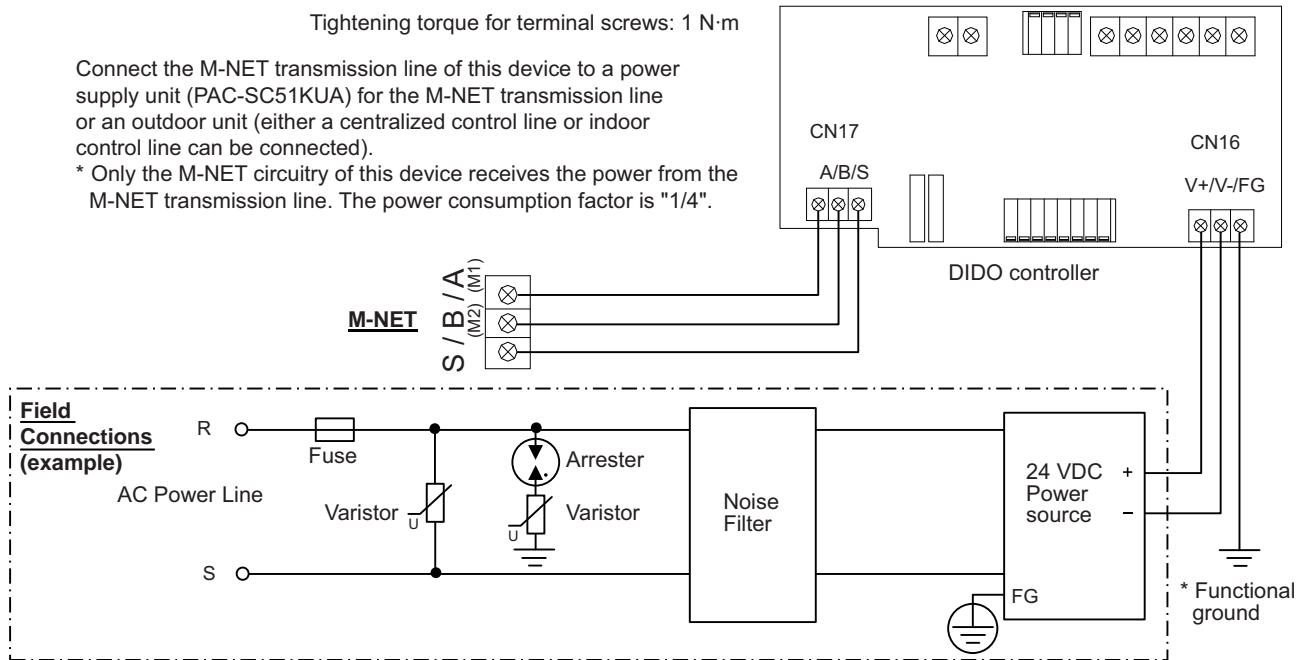

CAUTION

- Use a power line and M-NET transmission line that satisfy the specifications described in "1-(2). Parts Purchased Separately".
- Attach a circuit comprising the following components to the supply primary side of the 24 VDC power supply. (1) Varistor, (2) Arrester, (3) Noise filter, (4) Fuse
- It is important to pay attention to the polarity when connecting to the 24 VDC power supply terminal block. Connecting the positive and negative in the reverse order will cause a failure.
- Fix the power line and M-NET transmission line in place on the outside to ensure that the terminal block is not affected by any external force. Not securely connecting and fixing the wires in place may cause heat generation and fire.
- Make sure that the copper wiring is not short-circuiting the plates (cover, lower case) or neighboring wires. Cover the shielded line of the M-NET transmission line with materials such as vinyl tape and prevent short-circuiting with the plates.

(2). Connecting the Signal Lines

- Separately procure the relay, power supply for the relay, terminal block, and cable locally.
- The maximum wire length is 100 m (328 ft). However, since the use of long wires makes the device susceptible to noise, using wires shorter than 10 m (32.8 ft) is recommended.
- Connect another relay within 10 m (32.8 ft) from DIDO controller to extend the input line.

1) Standard Terminals (Channels 1 and 2)

(1-1) Input

(a) Non-voltage a-contact Inputs

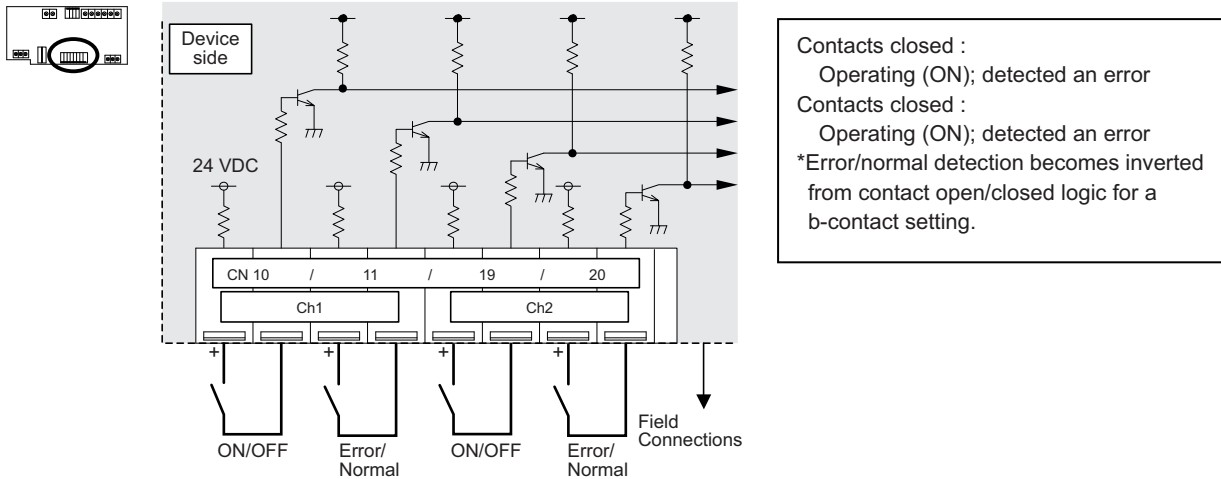

NOTE

- Connect the operate/stop (ON/OFF) inputs so that closing the contact operates (ON) the device and opening the contact stops (OFF) the device.
- The error/normal inputs of channels 1 and 2 can be switched between a-contact and b-contact.

CAUTION

- The polarity of the input terminals is important, so be sure to match the polarity when using contacts that have polarity.
- Select a contact with a minimum applicable load of 1 mADC or less.
- Supply 24 VDC 1 mA from the positive terminal to the external contacts.
- Do not install alongside or in contact with other wires.
- Strip 12 ± 1 mm ($15/32 \pm 1/32$ in) of the wire coating and insert firmly into the terminal.
- Make sure that the copper wiring is not short-circuiting the plates (cover, lower case) or neighboring wires.
- Perform wiring so that the terminal block is not strained.
If strained, use a wire guide or junction terminal to alleviate the stress on the terminal block.

(1-2) Output

Non-voltage Relay contact or transistor is available for output. Only one can be used at a time.

(a) Non-voltage Relay Contact Outputs

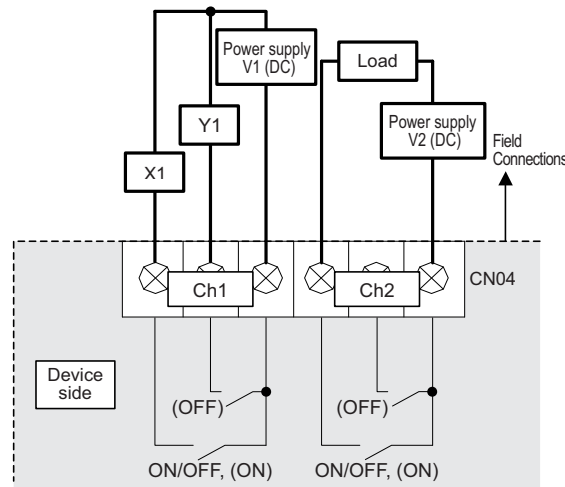
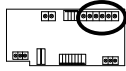

Operate (ON) output :
 Contacts closed
 Stop (OFF) output :
 Contacts open
 *Upon pulse output, the (ON), (OFF) contacts close according to the output content. ((ON) and (OFF) refer to the junctions in the diagram.)

() is in the case of a pulse.

Tightening torque for terminal screws: 1 N·m

CAUTION

- To use X1 and Y1 relay, obtain one that satisfies the following specifications.
 Operating coil
 [Applied load]
 MAX: 24 VDC, 5 W (Built-in diode)
 MIN: 5 VDC, 2 mW (Built-in diode)
 *1 AC loads cannot be connected.
 *2 Provide a power supply (V1, V2) that matches the load and relay to be used.
- To drive a direct load, use ones within the following.
 [Applied load]
 MAX: 24 VDC, 5 W
 MIN: 5 VDC, 2 mW
 * AC loads cannot be connected.
- Make sure that the copper wiring is not short-circuiting the plates (cover, lower case) or neighboring wires.
- Perform wiring so that the terminal block is not strained.
 If strained, use a wire guide or junction terminal to alleviate the stress on the terminal block.
- Do not connect the wires directly from the top of the control panel to the terminal block.
 Moisture may enter this device along the wiring and cause electric shock or fire.

(b) Transistor Outputs (Open Collector)

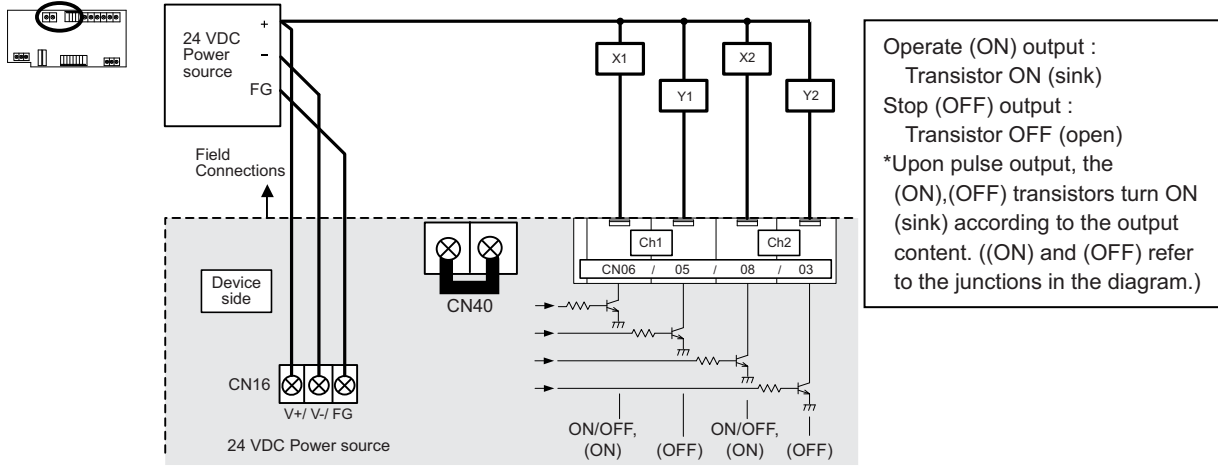

Tightening torque for terminal screws: 1 N·m

() is in the case of a pulse.

NOTE

The junction terminal block CN40 (for 24 VDC) is provided.
Use them as relay terminals if necessary.

CAUTION

- When X1, X2, Y1 and Y2 relays are used, select ones that satisfy the following specifications.
 - Operating coil
 - Rated voltage: 24 VDC (Built-in diode)
 - Power consumption: 0.9 W or less
 - (*1) Be sure to use the ones with the voltages rated above.
Exceeding the rated voltage may affect the ON/OFF of other outputs.
 - (*2) When using a separate power supply for this device, connect GND of the power supply to V- of CN16 of the terminal block of this device.
 - (*3) Use a relay with a withstanding voltage of at least 2000 VAC between the coil and contact.
Otherwise, there is the likelihood of an electric shock or fire.
- Strip 12 ± 1 mm ($15/32 \pm 1/32$ in) of the wire coating and insert firmly into the terminal.
- Make sure that the copper wiring is not short-circuiting the plates (cover, lower case) or neighboring wires.
- Perform wiring so that the terminal block is not strained.
If strained, use a wire guide or junction terminal to alleviate the stress on the terminal block.
- Do not connect the wires directly from the top of the control panel to the terminal block.
Moisture may enter this device along the wiring and cause electric shock or fire.

2) Expansion Connectors (Channels 3 to 6)

(2-1) Expansion Inputs/Outputs

Purchase an optional external input/output adapter (model: PAC-YG10HA) when using expansion inputs/outputs. PAC-YG66DCA has two expansion connectors, and up to two external input/output devices can be connected to each connector. An optional external input/output adapter is required for each connector used.

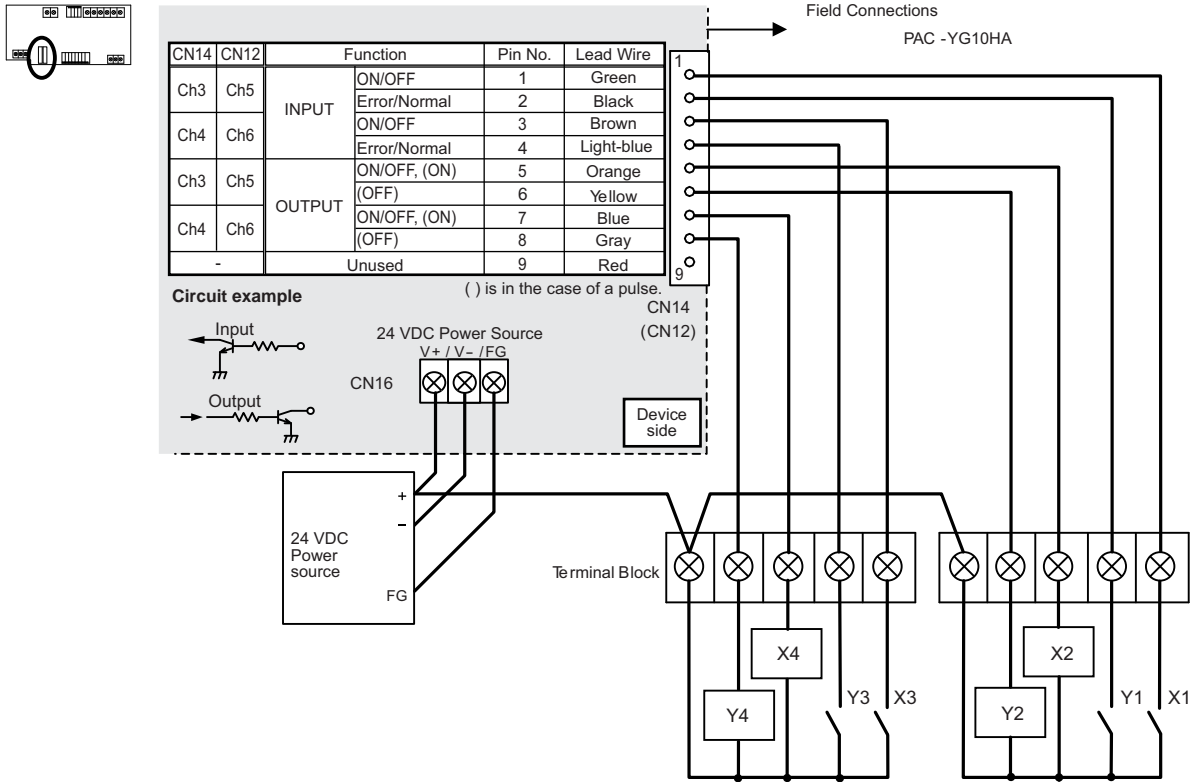

[Input]
 Contacts closed (24 VDC applied): Operating (ON); detected an error
 Contacts open : Stopped (OFF); detected as normal
 * Error/normal detection becomes inverted from contact open/closed logic for a b-contact setting.

[Output]
 Operate (ON) output : Transistor ON (sink)
 Stop (OFF) output : Transistor OFF(open)
 * Upon pulse output, the (ON), (OFF) transistors turn ON (sink) according to the output content. ((ON) and (OFF) refer to the junctions in the diagram.)

CAUTION

- When using X1, X2, X3, X4, Y1, Y2, Y3 and Y4 relays, select ones that satisfy the following specifications.
 - Operating coil Rated voltage: 24 VDC (Built-in diode)
 - Power consumption: 0.9 W or less
 - (*1) Be sure to use the ones with the voltages rated above. Exceeding the rated voltage may affect the ON/OFF of other outputs.
 - (*2) When using a separate power supply for this device, connect GND of the power supply to V- of CN16 of the terminal block of this device.
 - (*3) Use a relay with a withstanding voltage of at least 2000 VAC between the coil and contact. Otherwise, there is the likelihood of an electric shock or fire.
- Select a contact with a minimum applicable load of 1 mADC or less for the input contact.
- Do not install alongside or in contact with other wires.

3. Interlock control

The DIDO controller (PAC-YG66DCA) has an interlock control function, which enables operation or set temperature change on the M-NET devices such as indoor units and also enables signal output to the contacts on the DIDO controller. Interlock control covers the units connected to the DIDO controller with M-NET system. AG-150A/GB-50ADA-J/EB-50GU-J/AE-200E/AE-50E must be connected to use the function. Ask your dealer for interlock control setting. The setting requires special tool support.

⚠ CAUTION

Before using the interlock control, you must agree to the following.

1. This feature must not be used for disaster prevention or security purpose.
(Not designed to be used in situations that are life-threatening)
2. No functions must be added that allow the malfunctioning unit to run by defeating the safety features, such as an external ON/OFF switch or a short-circuit.
3. Those settings for the function that are not supported by the interlocked units must not be made. All the settings must be made within the specified range.
(Failure to observe these precautions may result in malfunctions and failures.)
4. Perform a test run for interlock control, and confirm the correct settings and normal operation.
5. The system must be configured in the way that integrates the operation of the interlocked fire and emergency control systems.

Item	Content	Remarks
Number of events	24 events	1 event interlock with 1 unit
Determinant condition for interlock control	At input contact change	<ul style="list-style-type: none"> • Operation input ON/OFF • Error input Error/Normal
Interlock control contents (to be output)	1 action for 1 condition <ul style="list-style-type: none"> • ON/OFF operation of indoor units • Operation mode change of indoor units • Temperature setting of indoor units (*1) • Contact output to DIDO controller (*2) 	Interlock control covers the units connected to DIDO controllers with M-NET system. (*1) Temperature setting range: 19-28°C (Standard setting) (*2) DIDO controller itself or other DIDO controllers in the same M-NET system.
Other	Interlock control prohibition function is enabled at emergency stop from AG-150A/GB-50ADA-J/EB-50GU-J/AE-200E/AE-50E	

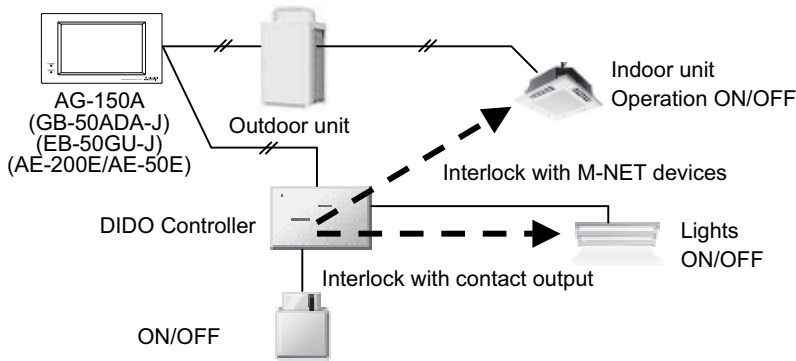

Interlock control of DIDO controller (example)

Note: Do not use Interlock control function on both AG-150A/GB-50ADA-J/EB-50GU-J/AE-200E/AE-50E and DIDO controller at the same time.

3-19. AI controller [PAC-YG63MCA]

The AI controller measures temperature and humidity; it also has an alarm capability if the measurement data exceeds defined setpoints. Historical measurement data can be displayed via only the AG-150A/GB-50ADA-J/EB-50GU-J/AE-200E/AE-50E Web browser and TG-2000A.

Temperature and humidity can be displayed on the AG-150A/AE-200E/AE-50E LCD.

Furthermore, an alarm can be output if measurement data exceeds a preset upper or lower limit.

The AI controller also features a function that interlocks M-NET devices for indoor units, etc.

External Dimensions

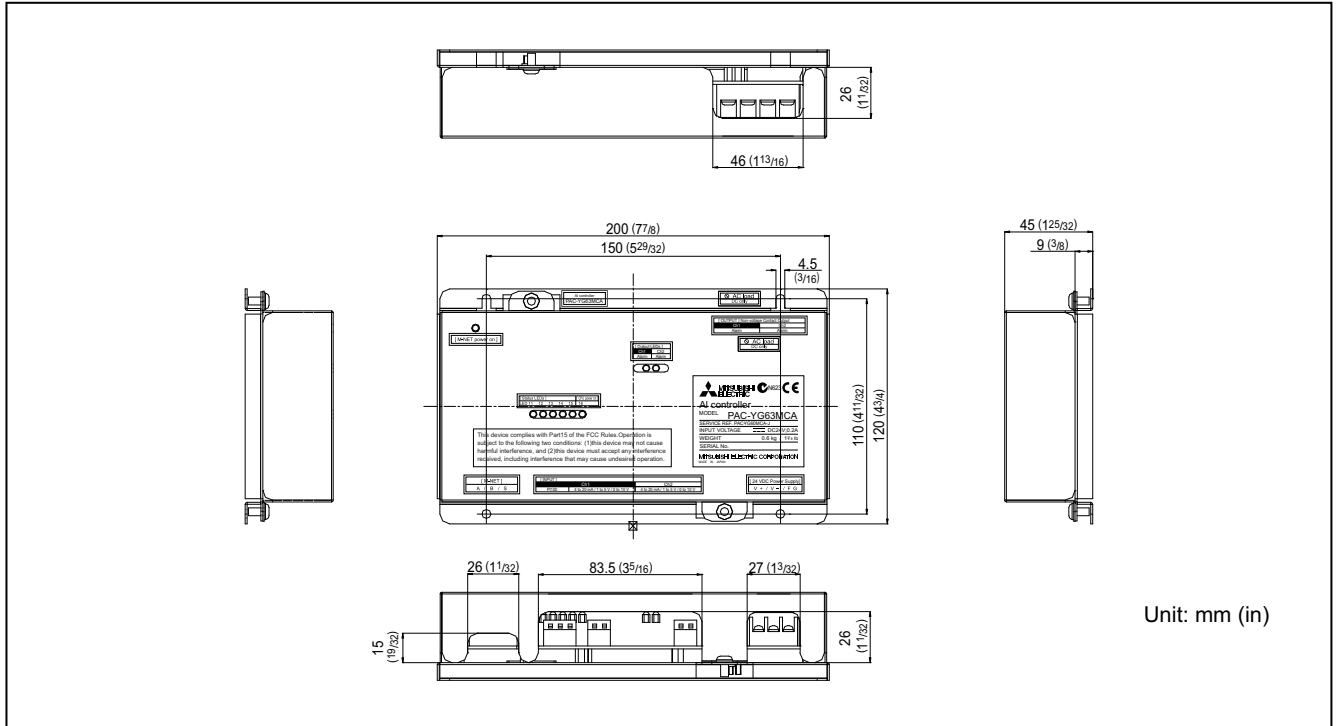

Usage Restrictions



- Mitsubishi Electric does not take financial responsibility for damages caused by issues beyond our control or special circumstances (predicable or unpredictable); and secondary or accidental damages, and damages to other objects. We also do not take financial responsibility for opportunities lost as a result of device failure, or electrical power failure at the end-user site.
- Mitsubishi Electric does not take financial responsibility caused by end-users' requests including, but not limited to, device testing, startup, readjustment and replacement.
- Do not use this device in disaster prevention security or "critical to life" applications.

1. Specifications

(1). Device Specifications

Item	Description							
Power Supply	24 VDC ± 10%: 5 W					Screw terminal block (M3) (*5)		
Interface	M-NET communication		17 to 30 VDC (*1)			Screw terminal block (M3) (*5)		
	Input (*2)	Ch	Sensor	Measurement target	Measurement range	Measurement error	External connection method	
			Ch1	Pt100 (3-wire system)	Temperature	-30 to 60°C [-22 to 140°F]	± 0.3%FS ± 0.1°C (0.18°F) (*3) [at 25°C(77°F)]	Screwless terminal block (3 poles)
		Analog		4 to 20 mADC	Temperature/humidity	(Set by system controller)	± 0.5%FS ± 0.1°C (0.18°F) (*3) ± 0.5%FS ± 0.1%RH [at 25°C(77°F)]	Screwless terminal block (2 poles)
				1 to 5 VDC				
		0 to 10 VDC						
Ch2	Analog	4 to 20 mADC	Temperature/humidity	(Set by system controller)	± 0.5%FS ± 0.1°C (0.18°F) (*3) ± 0.5%FS ± 0.1%RH [at 25°C(77°F)]	Screwless terminal block (2 poles)		
		1 to 5 VDC						
0 to 10 VDC								
Output	Upper/lower limit alarm interlock output (non-voltage contact)		Applied load MAX: 24 VDC, 5 W MIN: 5 VDC, 2 mW * AC loads cannot be connected.			Screw terminal block (M3.5) (*5)		
Interlock Function	Interlock M-NET devices according to measurement data values. (*4)							
Environment Conditions	Temperature		Operating temperature range	0 to 40°C [32°F to 104°F]				
			Storage temperature range	-20 to 60°C [-4°F to 140°F]				
	Humidity		30 to 90%RH (no condensation)					
Dimensions	200 (W) × 120 (H) × 45 (D) mm / 77/8 (W) × 43/4 (H) × 125/32 (D) in							
Weight	0.6 kg / 13/8 lb							
Time Backup During Power Failure	In the event of power failure or shut-off, the internal capacitor will continue to track time for approximately one week. (The internal capacitor takes about 24 hours to fully charge; a replacement battery is not necessary.)							
Installation Environment	Inside the metal control board (indoors) * Use this product in a hotel, a business office environment or similar environment.							

*1: Supply electric power from a power supply unit for the transmission line or an outdoor unit. Furthermore, the power consumption factor of the M-NET circuitry of this unit is "1/4".

*2: Configure the dip switch settings for the analog input method to use.

*3: The measurement error for the system includes the measurement error for this unit, sensor, and wiring.

a%FS (full scale) = a% × [(measurement range's upper limit value) - [lower limit value]]

*4: Settings for the interlock function are performed from the Maintenance Tool. For details, refer to the operation manual for the Maintenance Tool.

*5: M3 and M3.5 are sizes of the screw on the terminal block (ISO metric screw thread). The number indicates the screw diameter (mm).

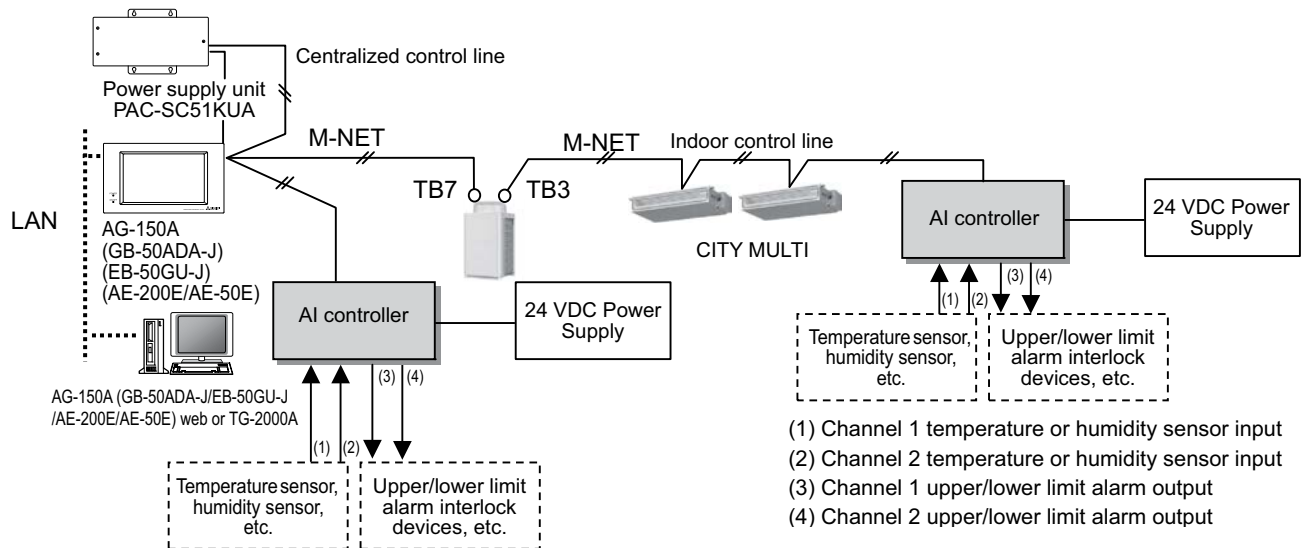

* This figure omits the power supply line and only shows the transmission line.

<Restrictions>

Maximum of 50 units per AG-150A/GB-50ADA-J/EB-50GU-J/AE-200E/AE-50E

However, the number of units that can be connected to a AG-150A/GB-50ADA-J/EB-50GU-J/AE-200E/AE-50E is up to 50 including this device, an indoor unit, LOSSNAY unit, etc.

NOTE

- For the shield ground of the M-NET centralized control line, use single-point grounding at the power unit for the transmission line.
However, when supplying electric power to the M-NET centralized control line from the R410A series outdoor unit*1 without using a power supply unit for the transmission line, use single-point grounding at the TB7 of that outdoor unit. *1 : Except PUMY model.
Furthermore, when connecting the M-NET transmission line of this device to the M-NET indoor control line, use grounding at the TB3 for each outdoor unit system.
- If the M-NET transmission line of this device is connected to an M-NET indoor control line and the outdoor unit is down because, for example, the power supply is interrupted for servicing or there is a failure, the AI controller cannot be set and monitored from the system controller.
- The sensor connected to the AI controller can only be monitored from AG-150A/GB-50ADA-J/EB-50GU-J /AE-200E/AE-50E Web browser and TG-2000A.
The sensor can be monitored from the AG-150A/AE-200E/AE-50E LCD.

(2). Parts Purchased Separately

Prepare the following parts to install this device.

Required Part	Specification
Unit fixing screws	M4 screw × 4 (* M4: ISO metric screw thread)
Power supply for this device	Commercially available power source: 24 VDC ± 10% 0.2 A (Minimum loading), SELV circuit, power line with grounding terminal Ripple noise: Lower than 200 mVp-p Compatible specification Authorized or CE marked products. Subject to regulations: - IEC60950 (or EN60950) - CISPR22/24 (or EN55022/24) - IEC61000-3-2/3-3 (or EN61000-3-2/3-3)
Power supply for sensors	A separate power supply for sensors may be required. In the case of 24 VDC voltage, the capacity of the power supply for this unit can be increased so that the power supply can be shared.
Power line	Use a sheathed vinyl cord or cable. At least 0.75 mm ² (AWG18)
M-NET transmission line	Type of the cable: Sheathed vinyl cords or cable which comply with the following specifications or equivalent. • CPEV ø 1.2 mm to ø 1.6 mm • CVVS 1.25 mm ² to 2 mm ² (AWG 16 to 14) * CPEV: PE insulated PVC jacketed shielded communication cable * CVVS: PVC insulated PVC jacketed shielded control cable PE: Polyethylene PVC: Polyvinyl chloride Power needs to be supplied to the M-NET circuitry of this device. Use an outdoor unit or a separately purchased power supply unit for the transmission line.
Signal lines (Sensor input lines)	Shows the size of the electric wire (copper wire) that is adapted to the terminal block of this device. Refer to the usage and cautionary items of the sensor when performing settings. However, use a line with shielded line. Electric wire size … (1)Solid wire: ø 0.65 mm (AWG21) - ø 1.2 mm (AWG16) (2)Stranded wire: 0.75 mm ² (AWG18) - 1.25 mm ² (AWG16) Single strand: At least ø 0.18 mm

[Parts to be Purchased Separately]

Name	Model	Application	Remark
Power supply unit	PAC-SC51KUA	Power supply to the M-NET transmission line	This is not required when power is to be supplied from an outdoor unit.

[Commercially available parts]

Part	Use	Remark
External 24 VDC power source	Supplies power to the AI controller.	Refer to "Power supply for this device" and "Power supply for sensors" in "Required Part" above for the capacity of the power supply.
Sensor	Measures temperature and humidity.	Temperature sensor (PAC-SE41TS-E) cannot be connected.

2. Wiring Instructions

(1). Connecting the Power and M-NET Transmission Lines

Tightening torque for terminal screws: 1 N·m

Connect the M-NET transmission line of this device to a power supply unit (PAC-SC51KUA) for the M-NET transmission line or an outdoor unit (either a centralized control line or indoor control line can be connected).

* Only the M-NET circuitry of this device receives the power from the M-NET transmission line. The power consumption factor is "1/4".

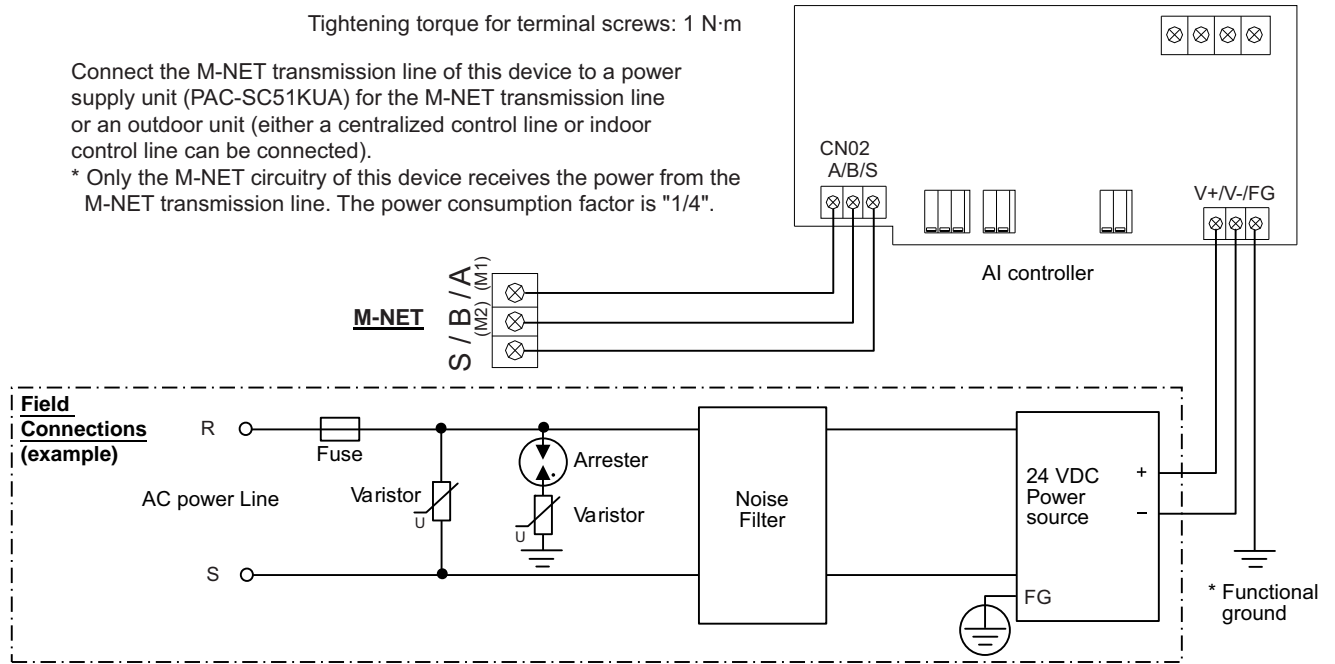

CAUTION

- Use a power line and M-NET transmission line that satisfy the specifications described in "1-(2). Parts Purchased Separately".
- Attach a circuit comprising the following components to the supply primary side of the 24 VDC power supply. (1) Varistor, (2) Arrester, (3) Noise filter, (4) Fuse
- It is important to pay attention to the polarity when connecting to the 24 VDC power supply terminal block. Connecting the positive and negative in the reverse order will cause a failure.
- Fix the power line and M-NET transmission line in place on the outside to ensure that the terminal block is not affected by any external force. Not securely connecting and fixing the wires in place may cause heat generation and fire.
- Make sure that the copper wiring is not short-circuiting the plates (cover, lower case) or neighboring wires. Cover the shielded line of the M-NET transmission line with materials such as vinyl tape and prevent short-circuiting with the plates.

NOTE

- If the M-NET transmission line of this device is connected to an M-NET indoor control line and the outdoor unit is down because, for example, the power supply is interrupted for servicing or there is a failure, the AI controller cannot be set and monitored from the system controller.
- Be sure to ground this device, PAC-SC51KUA and 24 VDC Power source. Measurement accuracy may be affected if devices are not grounded.

(2). Connecting the Sensors

- For channel 1, select one of the following four types: Pt100 detection, 4 to 20 mADC, 1 to 5 VDC, or 0 to 10 VDC analog input.
- For channel 2, select one of the following three types: 4 to 20 mADC, 1 to 5 VDC, or 0 to 10 VDC analog input.
- The wire length depends on the specifications of the sensor. However, since the use of long wires makes the device susceptible to noise, using wires shorter than 12 m (39.4 ft) is recommended. Use a shielded line for the sensor line and connect to the FG terminal on this unit or the FG terminal on the control panel.

1) Channel 1 Pt100 Input

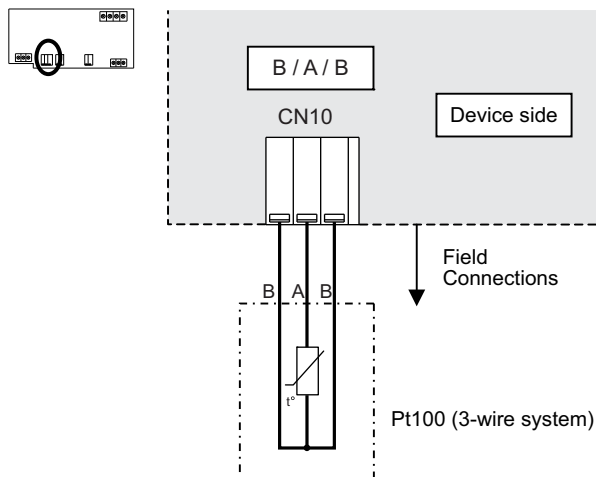

 **CAUTION**

- Use a 3-wire system for Pt100.
- A/B polarity is important for Pt100.
Be sure to match the polarity when using Pt100.
- Do not install the sensor input line parallel to or near the M-NET transmission line or power line.
Also avoid loop wiring.
Furthermore, confirm the precautions for the sensor.
- Strip 12 ± 1 mm ($15/32 \pm 1/32$ in) of the wire coating and insert firmly into the terminal.
- Make sure that the copper wiring is not short-circuiting the plates (cover, lower case) or neighboring wires.
- Perform wiring so that the terminal block is not strained.
If strained, use a wire guide or junction terminal to alleviate the stress on the terminal block.

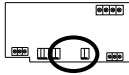
2) Channel 1 (Channel 2) Analog Input (4 to 20 mADC, 1 to 5 VDC, 0 to 10 VDC)

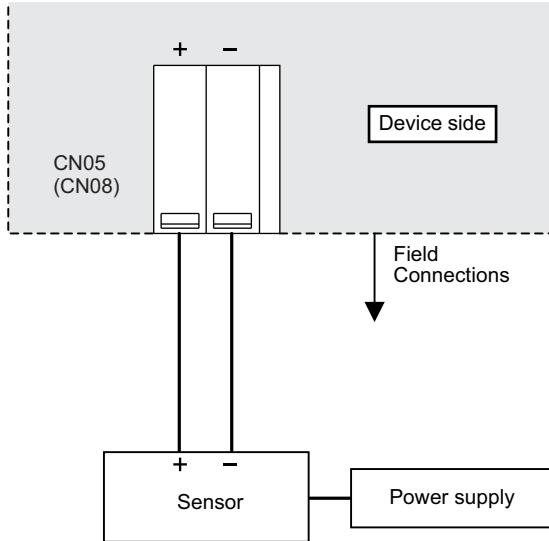

(a) When 1 to 5 VDC, 0 to 10 VDC, or 4 to 20 mADC (type for which power is supplied to the sensor) is connected



(b) When 4 to 20 mADC (type for which power is supplied to the signal line) is connected

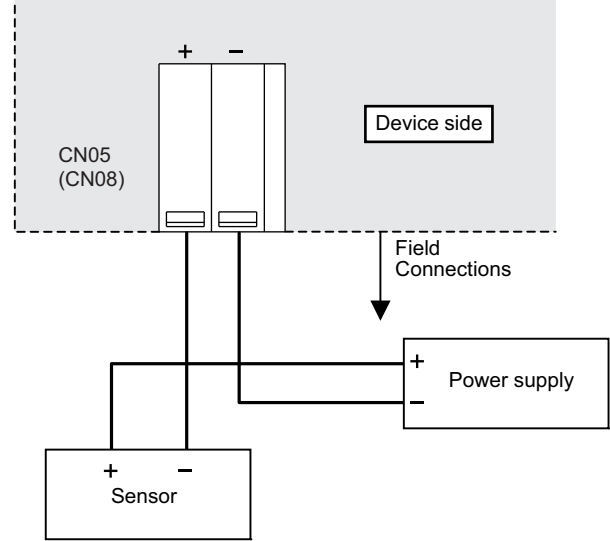

CAUTION

- Select a power supply that is suitable for the sensor to be used.
 - Do not install the sensor input line parallel to or near the M-NET transmission line or power line. Also avoid loop wiring.
 - Furthermore, confirm the precautions for the sensor.
 - Strip 12 ± 1 mm ($15/32 \pm 1/32$ in) of the wire coating and insert firmly into the terminal.
 - Make sure that the copper wiring is not short-circuiting the plates (cover, lower case) or neighboring wires.
 - Perform wiring so that the terminal block is not strained.
- If strained, use a wire guide or junction terminal to alleviate the stress on the terminal block.

(3). Connecting Alarm Setpoint Outputs (Non-voltage Contacts)

The maximum wire length is 100 m. However, since the use of long wires makes the device susceptible to noise, using wires no more than 10 m long is recommended.

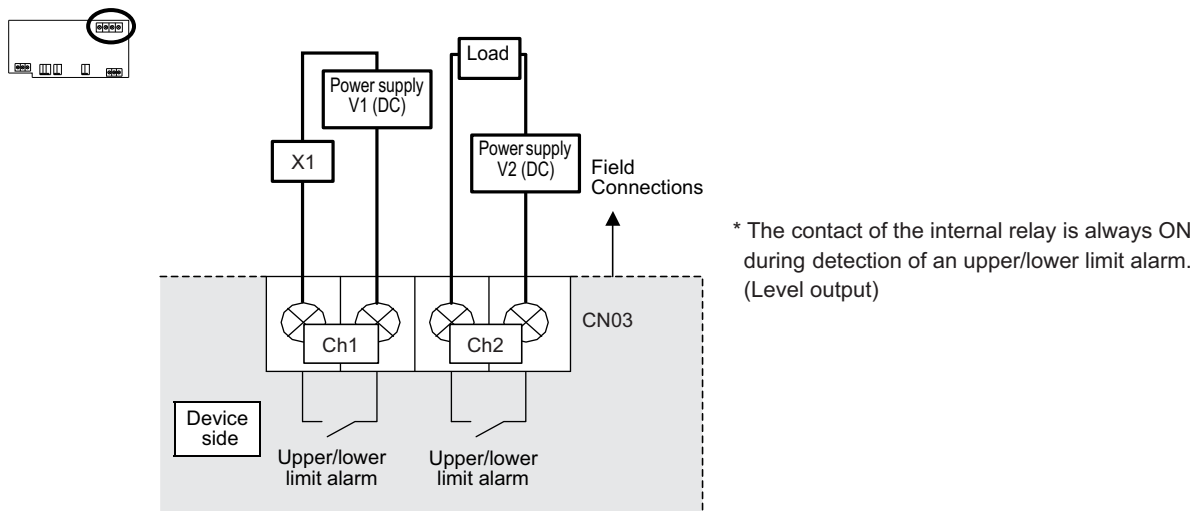

Tightening torque for terminal screws: 1 N·m.

CAUTION

- To use X1 relay, obtain one that satisfies the following specifications.
 - Operating coil
 - [Applied load]
 - MAX: 24 VDC, 5 W (Built-in diode)
 - MIN: 5 VDC, 2 mW (Built-in diode)
 - *1 AC loads cannot be connected.
 - *2 Provide a power supply (V1, V2) that matches the load and relay to be used.
- To drive a direct load, use ones within the following.
 - [Applied load]
 - MAX: 24 VDC, 5 W
 - MIN: 5 VDC, 2 mW
 - * AC loads cannot be connected.
- Make sure that the copper wiring is not short-circuiting the plates (cover, lower case) or neighboring wires.
- Perform wiring so that the terminal block is not strained.
 - If strained, use a wire guide or junction terminal to alleviate the stress on the terminal block.
- Do not connect the wires directly from the top of the control panel to the terminal block.
 - Moisture may enter this device along the wiring and cause electric shock or fire.

3. Interlock control

AI controller (PAC-YG63MCA) has an interlock control function, which enables operation or set temperature change on the M-NET devices such as indoor units.

Interlock control covers the units connected to the AI controller with M-NET system. AG-150A/GB-50ADA-J/EB-50GU-J/AE-200E/AE-50E must be connected to use the function.

Ask your dealer for interlock control setting. The setting requires special tool support.

CAUTION Before using the interlock control, you must agree to the following.

1. This feature must not be used for disaster prevention or security purpose.
(Not designed to be used in situations that are life-threatening)
2. No functions must be added that allow the malfunctioning unit to run by defeating the safety features, such as an external ON/OFF switch or a short-circuit.
3. Those settings for the function that are not supported by the interlocked units must not be made. All the settings must be made within the specified range.
(Failure to observe these precautions may result in malfunctions and failures.)
4. Perform a test run for interlock control, and confirm the correct settings and normal operation.
5. The system must be configured in the way that integrates the operation of the interlocked fire and emergency control systems.

Item	Content	Remarks
Number of events	24 events	1 event interlock with 1 unit
Determinant condition for interlock control	Measurement value Measurement interval is 1 to 7200 seconds.	<ul style="list-style-type: none"> • Exceeding measurement value in setting range • Exceeding upper/lower limit alarm detection value and cancellation value
Interlock control contents (to be output)	1 action for 1 condition <ul style="list-style-type: none"> • ON/OFF operation of indoor units • Operation mode change of indoor units • Temperature setting of indoor units (*1) • Contact output to DIDO controller 	Interlock control covers the units connected to AI controllers with M-NET system. (*1) Temperature setting range: 19-28°C (Standard setting)
Other	Interlock control prohibition function is enabled at emergency stop from AG-150A /GB-50ADA-J/EB-50GU-J/AE-200E/AE-50E	

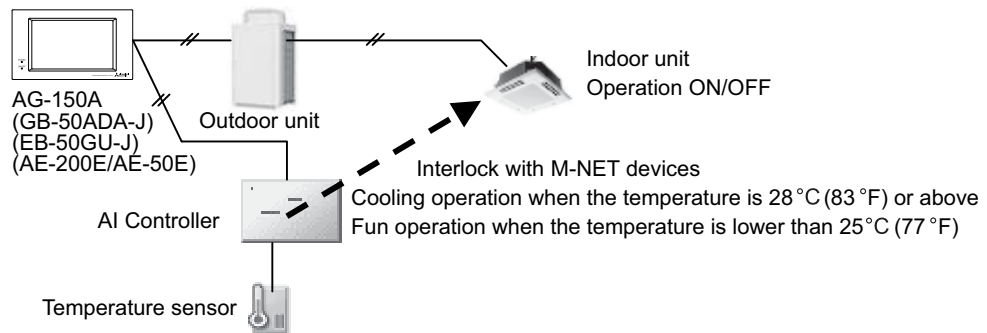

Interlock control of AI controller (example)

4-1. Y, R2 series

CITY MULTI system can be monitored or controlled with signal to/from the outside as every control board of Indoor unit or Outdoor unit has input/output signal connectors. Independent control to the individual Indoor or Outdoor can be carried out by using these connectors. Yet, for large-scale control, MELANS would be much easier. When using input/output connectors, a dedicated adapter (optional part) and a relay circuit needed to be prepared by the site. Following are some typical example. (Y series)

Table 4-1-1. Control can be achieved by using Outdoor input/output connectors.

Function	Usage	Using connector		Signal	Option
		PUHY	PURY		
Demand	Prohibiting cooling/heating operation (thermo OFF) by an external input to the outdoor unit. * It can be used as the demand control for each refrigerant system.	CN3D	CN3D	Input (level-signal)	Adapter for external input (PAC-SC36NA-E)
Low noise mode	Performs a low noise operation of the outdoor unit by an external input to the outdoor unit. * It can be used as the low noise operation device for each refrigerant system.				
Snow sensor signal input	Forces the outdoor unit to perform a fan operation by receiving signals from the snow sensor. *4	CN3S	CN3S		
Auto-changeover	Cooling/heating operation can be changed by an external input to the outdoor unit.	CN3N	-		
Energy-saving mode	The operation mode of the unit can be changed from normal cooling operation (performance priority) to energy-saving cooling mode by an external signal input.	CN3K	CN3K		
Operation status of the compressor	How to extract signals from the outdoor unit. * It can be used as an operation status display device.	CN51	CN51	Output (level-signal)	Adapter for external output (PAC-SC37SA-E)
Error status	* It can be used for an interlock operation with external devices.				

- *1 For details, refer to 1) through 4) shown below.
- *2 Low noise mode is valid when Dip SW6-8 on the outdoor unit is set to OFF. When DIP SW6-8 is set to ON, 4 levels of on-DEMAND are possible, using different configurations of low noise mode input and DEMAND input settings.
When 2 or more outdoor units exist in one refrigerant circuit system, 8 levels of on-DEMAND are possible. When 3 outdoor units exist in one refrigerant circuit system, 12 levels of on-DEMAND are possible.
- *3 Low noise mode can be switched from ability main to low noise main with Dip SW6-7 on the outdoor unit. Dip SW6-7 OFF: ability main (ability main mode : The sound pressure level is reduced by limiting the maximum fan frequency under the following condition. Cooling mode : outdoor temp. (TH7) ≤ 30°C Heating mode : outdoor temp. (TH7) ≥ 3°C), ON: low noise main.
- *4 When multiple outdoor units exist in one refrigerant circuit system, settings on every outdoor unit (signal input) are required.
- *5 For detailed drawing, refer to "4-2. Outdoor unit input/output connector".

1) Table 4-1-2. SW6-8: OFF (Compressor ON/OFF, Low noise mode)

CN3D 1-3P	2-level of on-Demand *6
Open	100%(No Demand)
Short-circuit	0%
<hr/>	
CN3D 1-2P	Low noise mode *7
Open	OFF
Short-circuit	ON

- *6 When SW6-8 on the outdoor unit in one refrigerant circuit system is set to ON (4 levels or 8 levels or 12 levels of on- DEMAND), this function cannot be used.
- *7 This function and the 4 levels or 8 levels on-DEMAND function can be used together. Input the order to CN3D 1-2P on the outdoor unit whose SW6-8 is set to OFF.

2) When SW6-8 on one outdoor unit in one refrigerant circuit system is set to ON (4 levels of on-DEMAND) (*8)

	CN3D 1-2P	
CN3D 1-3P	Open	Short-circuit
Open	100% (No DEMAND)	75%
Short-circuit	0%	50%

Note the following steps to be taken when using STEP DEMAND.

Example: When switching from 100% to 50%

Steps in DEMAND level setting	<WRONG>	100%	→	10%	→	50%
	<CORRECT>	100%	→	75%	→	50%

If the demand settings are switched in the wrong order listed as the wrong example above, the unit may go into thermo OFF mode.

The percentage of the DEMAND listed in the table above is an approximate value based on the compressor volume and does not necessarily correspond with the capacity.

This function and the Low noise mode function cannot be used together.

3) When SW6-8 on the two outdoor units in one refrigerant circuit system is set to ON (8 levels of on-DEMAND) (*8,*9)

8 levels of on-DEMAND		No.2 CN3D					
		1-2P	Open		Short-circuit		
No.1 CN3D	1-2P	1-3P	Open	Short-circuit	Open	Short-circuit	
	Open	Open	100% (No DEMAND)	50%	88%	75%	
		Short-circuit	50%	0%	38%	25%	
	Short-circuit	Open	88%	38%	75%	63%	
		Short-circuit	75%	25%	63%	50%	

4) When SW6-8 on the all outdoor units in one refrigerant circuit system is set to ON (12 levels of on-DEMAND) (*9)

12 levels of on-DEMAND		No.2 CN3D								
		1-2P	Open				Short-circuit			
		1-3P	Open		Short-circuit		Open		Short-circuit	
No.1 CN3D	No.3 CN3D	1-2P	Open	Short-circuit	Open	Short-circuit	Open	Short-circuit	Open	Short-circuit
		Open	100%	67%	92%	84%	67%	34%	59%	50%
		Short-circuit	67%	34%	59%	50%	34%	0%	25%	17%
		Open	92%	59%	84%	75%	59%	25%	50%	42%
		Short-circuit	84%	50%	75%	67%	50%	17%	42%	34%
12 levels of on-DEMAND		No.3 CN3D								
		1-2P	Open				Short-circuit			
		1-3P	Open		Short-circuit		Open		Short-circuit	
No.1 CN3D	No.3 CN3D	1-2P	Open	Short-circuit	Open	Short-circuit	Open	Short-circuit	Open	Short-circuit
		Open	92%	59%	84%	75%	84%	50%	75%	67%
		Short-circuit	59%	25%	50%	42%	50%	17%	42%	34%
		Open	84%	50%	75%	67%	75%	42%	67%	59%
		Short-circuit	75%	42%	67%	59%	67%	34%	59%	50%

- *8 Input the order to CN3D on the outdoor unit whose SW6-8 is set to ON.
- *9 CN3D of No. 1, 2, 3 can be selected arbitrary with the outdoor unit whose SW6-8 is set to ON.

Table 4-1-3. Control can be achieved by using Indoor input/output connectors.

Function	Usage	Using connector	Signal
Remote/Local switching *1 ON/OFF *2*3	Indoor group can be controlled ON/OFF by an ON/OFF switching or contact input to the connector of the head Indoor in an Indoor group. It can be interlocked with timer, door, window, or other equipment to "Force stopping"	CN32	Input (level-signal)
ON/OFF *2*3	Indoor group can be controlled ON/OFF by an external pulse signal input to the connector of the head Indoor in an Indoor group.	CN51	Input (pulse-signal)
Demand	Indoor group can be controlled ON/OFF by an ON/OFF switching or contact input to the connector of every Indoor in an Indoor group.	CN52	Input (pulse-signal)
Monitoring ON/OFF state	Signal output from a head Indoor unit, presenting its Indoor group.	CN51	Output
Monitoring heating state	It can be used for monitoring or interlock with other equipment purpose and so on.	CN52	
Monitoring cooling/drying state		CN52	
Monitoring Error state	Signal output from every Indoor unit, for monitoring Error or Thermo-off (fan) state.	CN51	Output
Monitoring Thermo-OFF(fan) state	It can be used for monitoring or interlock with other equipment purpose and so on.	CN52	

*1. When switching to Remote, control at Local remote controller will NOT be effective, but the "CENTRALLY CONTROLLED" is displayed.

*2. MA or ME remote controller is needed for this function.

*3. If using ON/OFF input function, Automatic-address-start-up can not be performed to start-up the system at commissioning.

*4. If CITY MULTI use AG-150A/GB-50ADA-J/EB-50GU-J and PLC software to control the Indoor unit via its external input/output connectors, Dip Switch 1-9 and Dip Switch 1-10 should be set to ON.

In this case, the input/output connectors act as normal connectors, functions mentioned at Table 4-1-3. are no more available.
Details are available at the PLC software Instruction Manual.

Table 4-1-4. ON/OFF control to each Indoor unit (group) by using Dip Switch 9 and 10 (SW1-9, SW1-10) of the Indoor unit.

Function	Operation on Indoor units	Setting Dip Switch *1*4	
		1-9	1-10
Auto ON	All indoor units will turn ON and automatically resume to its previous mode after 5 minutes from power recovery.	OFF	ON
Auto recovery	Indoor unit recovers to its previous state (ON/OFF, mode) after 5 minutes from power recovery.	ON	OFF
All OFF	Forced stopping regardless of Indoor units' state.	OFF	OFF

*1. The Dip Switch setting should be carried out on every Indoor unit in the group.

*2. Outdoor unit's power supply should NOT be cut. Otherwise, power supply to case heater of the compressor would be cut too, which may cause damage to the compressor.

*3. Above method can not be applied to the power ON/OFF of the drain pump and humidifier equipment.

*4. If CITY MULTI use AG-150A/GB-50ADA-J/EB-50GU-J and PLC software to control the Indoor unit via its external input/output connectors, Dip Switch 1-9 and Dip Switch 1-10 should be set to ON.

In this case, the input/output connectors act as normal connectors, functions mentioned at Table 4-1-4. are no more available.

■ System example

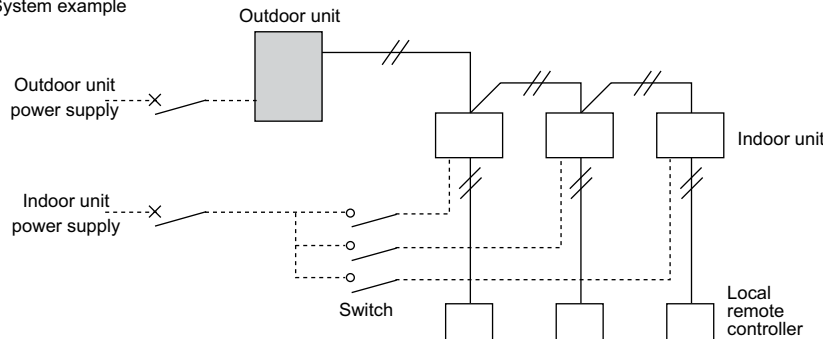

Restart of the CITY MULTI needs to be careful. When no power supply to the outdoor unit, no power supply to the compressor case heater too. The compressor needed to be warmed up before running. When using above functions, power supply to the outdoor unit should be ensured.

Table 4-1-5. How to use Remote/Local switching connector CN32

State	Local remote controller display and operation	CN32-SW-1 for Local/Remote control switching	CN32-SW-2 for Remote "ON/OFF" operation
Local remote controller control	Operation is permitted	OFF	OFF
Remote STOP	"CENTRALLY CONTROLLED" flashing, "ON/OFF" at local remote controller is not possible.	ON	OFF
Remote START	"CENTRALLY CONTROLLED" flashing, "ON/OFF" at local remote controller is not possible.	ON	ON

* For details refer to CN32 in section "4-3. Indoor unit "-E" type input/output connector".

Table 4-1-6. Limitations to combining system controls

	Description	Control combining distant/local	Pulse ON/OFF	Power ON/OFF	Automatic recover
1	Control combining distant/local	CN32	-	X*1	X*1
2	Pulse ON/OFF	CN51	-	O	O
3	HA ON/OFF(JEMA)	CN51		O	O
4	Power ON/OFF	-		-	X
5	Automatic recover	-			-

*1. Pulse ON/OFF, power ON/OFF and automatic recover can only be used when the remote/local setting CN32 is set to local.
Therefore, always avoid this function when combining control.

4-2. Outdoor unit input/output connector

Caution:	1.Wiring should be covered by insulation tube with supplementary insulation. 2.Use relays or switches with IEC or equivalent standard. 3.The electric strength between accessible parts and control circuit should have 2750V or more.
-----------------	--

4-2-1. Output

- State (CN51)

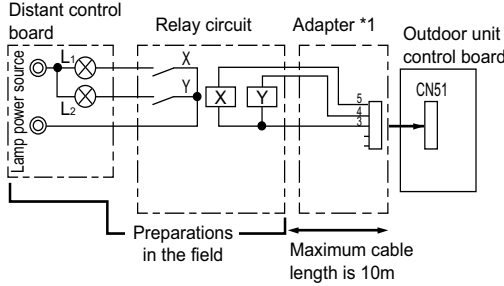

L1 : Outdoor unit error display lamp
 L2 : Compressor operation lamp (compressor running state)
 X, Y : Relay (coil =<0.9W : 12VDC)
 *1. Optional part : PAC-SC37SA-E or field supply.

4-2-2. Input

Y, R2 series

- (1) Step demand and Low noise mode (CN3D)

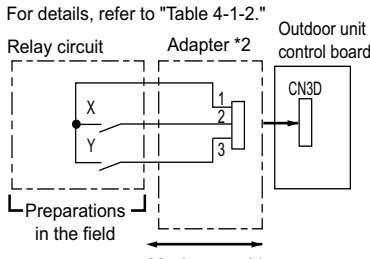

For details, refer to "Table 4-1-2."
 X : Low noise mode or demand
 Y : Demand
 X,Y : Relay Contact rating voltage $\geq 15VDC$
 Contact rating current $\geq 0.1A$
 Minimum applicable load $\leq 1mA$ at DC
 *2. Optional part : PAC-SC36NA-E or field supply.

- (2) Low noise mode (CN3D + DipSW4-4 OFF)

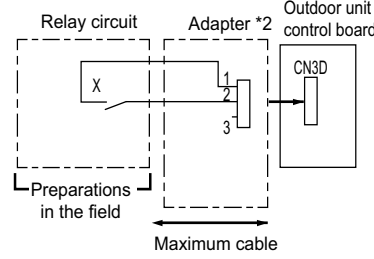

X : Relay Contact rating voltage $\geq 15VDC$
 Contact rating current $\geq 0.1A$
 Minimum applicable load $\leq 1mA$ at DC
 *2. Optional part : PAC-SC36NA-E or field supply.
 Low noise mode : The sound pressure level is reduced by controlling the maximum fan frequency and compressor frequency.
 -Note-
 The sound pressure level can not be reduced, when neither the fan frequency nor the compressor frequency are maximum.

- (3) Autochangeover (CN3N) (R2 excluded)

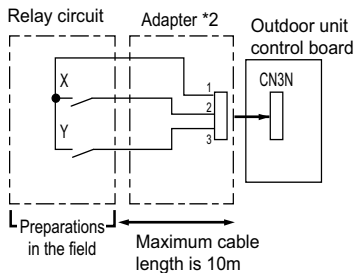

X : Cooling / Heating
 Y : Validity / Invalidity of X
 X,Y : Relay Contact rating voltage $\geq 15VDC$
 Contact rating current $\geq 0.1A$
 Minimum applicable load $\leq 1mA$ at DC
 *2. Optional part : PAC-SC36NA-E or field supply.

		X	
		OFF	ON
Y	OFF	Normal	
	ON	Cooling	Heating

- (4) Snow sensor (CN3S)

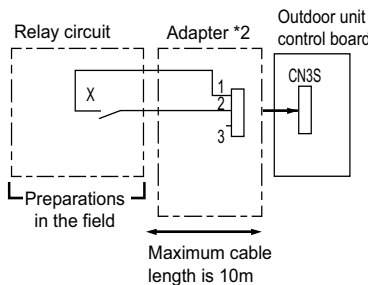

X : Relay Contact rating voltage $\geq 15VDC$
 Contact rating current $\geq 0.1A$
 Minimum applicable load $\leq 1mA$ at DC
 *2. Optional part : PAC-SC36NA-E or field supply.
 Snow sensor : The outdoor fan runs when X is closed in stop mode or thermostat mode.

- (5) Energy-saving mode (CN3K)

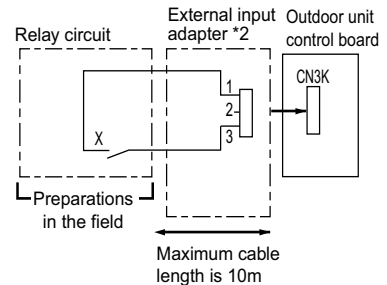

X : Energy-saving mode command
 X : Relay Contact rating voltage $\geq DC15V$
 Contact rating current $\geq 0.1A$
 Minimum applicable load $\leq 1mA$ at DC
 *2. Optional part : PAC-SC36NA-E or field supply.

4-3. Indoor unit "-E" type input/output connector

 Caution:	1. Wiring should be covered by insulation tube with supplementary insulation.
	2. Use relays or switches with IEC or equivalent standard.
	3. The electric strength between accessible parts and control circuit should have 2750V or more.

● ON/OFF (Pulse) input specification

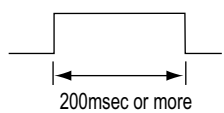
Item	Description
Input signal	Pulse sign (a connect)
Standard of pulse	 200msec or more

● Input

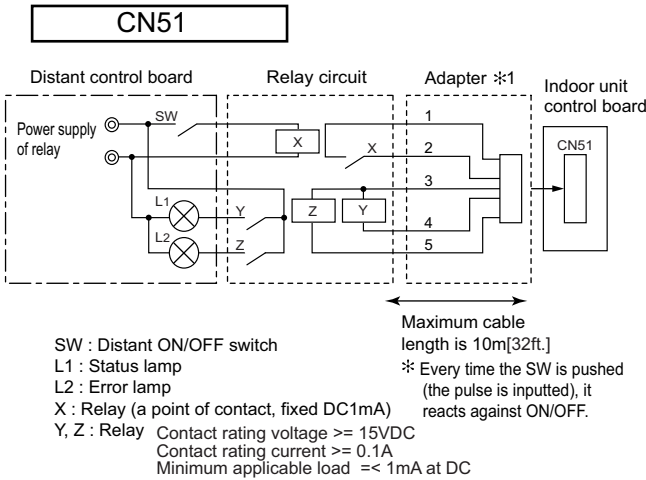

● Output

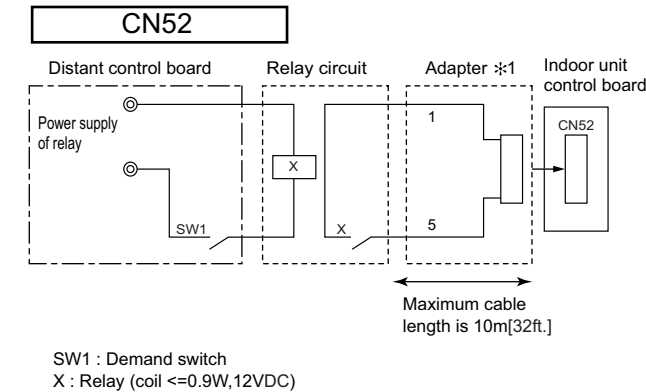
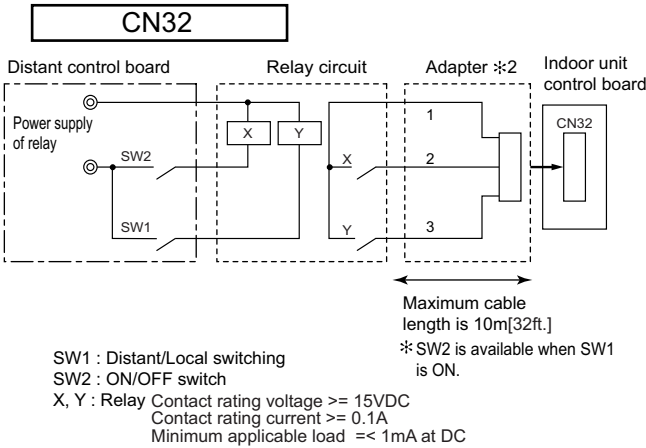
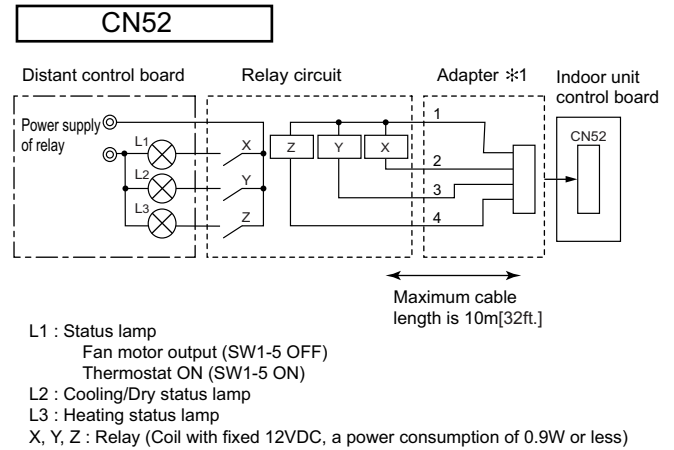

SW1	Indoor unit
ON	Forced thermo-OFF
OFF	Normal running

* 1. Optional part : PAC-SA88HA-E or field supply
 * 2. Optional part : PAC-SE55RA-E or field supply

CITY MULTI

4. SYSTEM DESIGN

SYSTEM DESIGN Y SERIES..... 4 - 3

SYSTEM DESIGN R2 SERIES..... 4 - 65

CITY MULTI

SYSTEM DESIGN Y SERIES

1. Electrical work.....	4 - 4
1-1.General cautions	4 - 4
1-2.Power supply for Indoor unit and Outdoor unit	4 - 5
1-3.Power cable specifications	4 - 11
1-4.Power supply examples.....	4 - 13
2. M-NET control.....	4 - 19
2-1.Transmission cable length limitation.....	4 - 19
2-2.Transmission cable specifications	4 - 20
2-3.System configuration restrictions.....	4 - 21
2-4.Address setting.....	4 - 24
3. Piping Design.....	4 - 37
3-1.R410A Piping material	4 - 37
3-2.Piping Design	4 - 38
3-3.Refrigerant charging calculation	4 - 44
4. Outdoor Installation.....	4 - 48
4-1.Requirement on installation site	4 - 48
4-2.Spacing.....	4 - 49
4-3.Piping direction	4 - 51
4-4.Weather countermeasure	4 - 57
4-5.Caution on selecting outdoor units	4 - 59
5. Installation information.....	4 - 60
5-1.General precautions	4 - 60
5-2.Precautions for Indoor unit	4 - 61
5-3.Precautions for Fresh air intake type indoor unit	4 - 62
5-4.Precautions for Outdoor unit/Heat source unit	4 - 62
5-5.Precautions for Control-related items	4 - 63
6. Caution for refrigerant leakage	4 - 64
6-1.Refrigerant property.....	4 - 64
6-2.Confirm the Critical concentration and take countermeasure.....	4 - 64

1-1. General cautions

- ① Follow ordinance of your governmental organization for technical standard related to electrical equipment, wiring regulations, and guidance of each electric power company.
- ② Wiring for control (hereinafter referred to as transmission cable) shall be (50mm[1-5/8in.] or more) apart from power source wiring so that it is not influenced by electric noise from power source wiring. (Do not insert transmission cable and power source wire in the same conduit.)
- ③ Be sure to provide designated grounding work to outdoor unit.
- ④ Give some allowance to wiring for electrical part box of indoor and outdoor units, because the box is sometimes removed at the time of service work.
- ⑤ Never connect 380~415V(220~240V) power source to terminal block of transmission cable. If connected, electrical parts will be damaged.
- ⑥ Use 2-core shield cable for transmission cable. If transmission cables of different systems are wired with the same multiple-core cable, the resultant poor transmitting and receiving will cause erroneous operations.
- ⑦ When extending the transmission line, make sure to extend the shield cable as well.

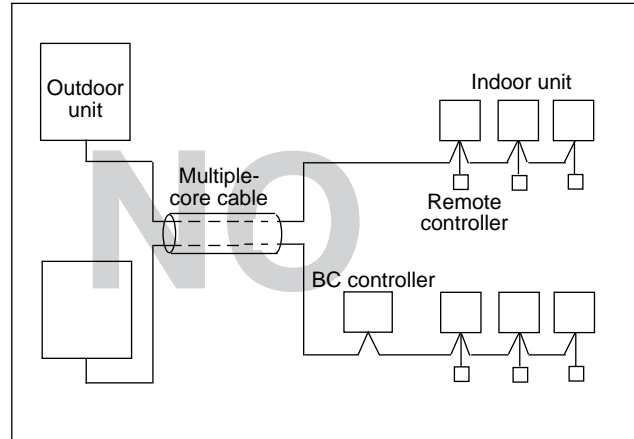
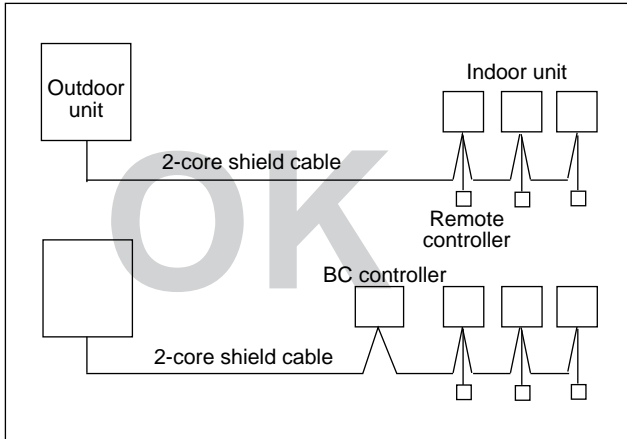

1-2. Power supply for Indoor unit and Outdoor unit

1-2-1. Electrical characteristics of Indoor unit

Symbols: MCA (Max.Circuit Amps =1.25xFLA), FLA (Full Load Amps)
IFM (Indoor Fan Motor), Output (Fan motor rated output)

PMFY-P-VBM-E	Power supply			IFM	
	Volts / Hz	Range +-10%	MCA(A)	Output (kW)	FLA(A)
PMFY-P20VBM-E	220-240V / 50Hz 220V / 60Hz	Max.: 264V Min.: 198V	0.25	0.028	0.20
PMFY-P25VBM-E			0.26	0.028	0.21
PMFY-P32VBM-E			0.26	0.028	0.21
PMFY-P40VBM-E			0.33	0.028	0.26

PLFY-P-VCM-E2	Power supply			IFM	
	Volts / Hz	Range +-10%	MCA(A)	Output (kW)	FLA(A)
PLFY-P15VCM-E2	220-240V / 50Hz	Max.: 264V Min.: 198V	0.24	0.008	0.19
PLFY-P20VCM-E2			0.29	0.011	0.23
PLFY-P25VCM-E2			0.29	0.015	0.23
PLFY-P32VCM-E2			0.35	0.020	0.28
PLFY-P40VCM-E2			0.35	0.020	0.28

PLFY-P-VBM-E	Power supply			IFM	
	Volts / Hz	Range +-10%	MCA(A)	Output (kW)	FLA(A)
PLFY-P20VBM-E	220-240V / 50Hz 220V / 60Hz	Max.: 264V Min.: 198V	0.33	0.050	0.26
PLFY-P25VBM-E			0.33	0.050	0.26
PLFY-P32VBM-E			0.34	0.050	0.27
PLFY-P40VBM-E			0.36	0.050	0.29
PLFY-P50VBM-E			0.36	0.050	0.29
PLFY-P63VBM-E			0.45	0.050	0.36
PLFY-P80VBM-E			0.64	0.050	0.51
PLFY-P100VBM-E			1.25	0.120	1.00
PLFY-P125VBM-E			1.34	0.120	1.07

PLFY-P-VLMD-E	Power supply			IFM	
	Volts / Hz	Range +-10%	MCA(A) (50 / 60Hz)	Output (kW)	FLA(A) (50 / 60Hz)
PLFY-P20VLMD-E	220-240V / 50Hz 220-230V / 60Hz	Max.: 264V Min.: 198V	0.45 / 0.46	0.015	0.36 / 0.37
PLFY-P25VLMD-E			0.45 / 0.46	0.015	0.36 / 0.37
PLFY-P32VLMD-E			0.45 / 0.46	0.015	0.36 / 0.37
PLFY-P40VLMD-E			0.50 / 0.53	0.015	0.40 / 0.42
PLFY-P50VLMD-E			0.51 / 0.54	0.020	0.41 / 0.43
PLFY-P63VLMD-E			0.61 / 0.64	0.020	0.49 / 0.51
PLFY-P80VLMD-E			0.90 / 0.93	0.020	0.72 / 0.74
PLFY-P100VLMD-E			0.94 / 1.10	0.030	0.75 / 0.88
PLFY-P125VLMD-E			1.69 / 1.69	0.078x2	1.35 / 1.35

PEFY-P-VMR-E-L/R	Power supply			IFM	
	Volts / Hz	Range +-10%	MCA(A) (50 / 60Hz)	Output (kW)	FLA(A) (50 / 60Hz)
PEFY-P20VMR-E-L/R	220-240V / 50Hz 220-230V / 60Hz	Max.: 264V Min.: 198V	0.37 / 0.37	0.018	0.29 / 0.29
PEFY-P25VMR-E-L/R			0.37 / 0.37	0.018	0.29 / 0.29
PEFY-P32VMR-E-L/R			0.43 / 0.48	0.023	0.34 / 0.38

PEFY-P-VMS1-E	Power supply			IFM	
	Volts / Hz	Range +-10%	MCA(A) (50 / 60Hz)	Output (kW)	FLA(A) (50 / 60Hz)
PEFY-P15VMS1-E	220-240V / 50Hz 220-240V / 60Hz	Max.: 264V Min.: 198V	0.63 / 0.63	0.096	0.50 / 0.50
PEFY-P20VMS1-E			0.70 / 0.70	0.096	0.56 / 0.56
PEFY-P25VMS1-E			0.75 / 0.75	0.096	0.60 / 0.60
PEFY-P32VMS1-E			0.75 / 0.75	0.096	0.60 / 0.60
PEFY-P40VMS1-E			0.83 / 0.82	0.096	0.66 / 0.65
PEFY-P50VMS1-E			1.02 / 1.00	0.096	0.81 / 0.80
PEFY-P63VMS1-E			1.08 / 1.07	0.096	0.86 / 0.85

1. Electrical work

YKB/YLM

S.D. Y

Symbols: MCA (Max.Circuit Amps =1.25xFLA), FLA (Full Load Amps)
IFM (Indoor Fan Motor), Output (Fan motor rated output)

PEFY-P-VMS1L-E	Power supply			IFM	
	Volts / Hz	Range +-10%	MCA(A) (50 / 60Hz)	Output (kW)	FLA(A) (50 / 60Hz)
PEFY-P15VMS1L-E	220-240V / 50Hz 220-240V / 60Hz	Max.: 264V Min.: 198V	0.46 / 0.46	0.096	0.37 / 0.37
PEFY-P20VMS1L-E			0.54 / 0.54	0.096	0.43 / 0.43
PEFY-P25VMS1L-E			0.59 / 0.59	0.096	0.47 / 0.47
PEFY-P32VMS1L-E			0.59 / 0.59	0.096	0.47 / 0.47
PEFY-P40VMS1L-E			0.68 / 0.68	0.096	0.54 / 0.54
PEFY-P50VMS1L-E			0.84 / 0.84	0.096	0.67 / 0.67
PEFY-P63VMS1L-E			0.91 / 0.91	0.096	0.73 / 0.73

PEFY-P-VMH(S)-E	Power supply			IFM	
	Volts / Hz	Range +-10%	MCA(A) (50 / 60Hz)	Output (kW)	FLA(A) (50 / 60Hz)
PEFY-P40VMH-E	220-240V / 50Hz 220-240V / 60Hz	Max.: 264V Min.: 198V	1.21 / 1.61	0.08	0.97 / 1.29
PEFY-P50VMH-E			1.21 / 1.61	0.08	0.97 / 1.29
PEFY-P63VMH-E			1.49 / 1.95	0.12	1.19 / 1.56
PEFY-P71VMH-E			1.58 / 2.18	0.14	1.26 / 1.74
PEFY-P80VMH-E			1.85 / 2.40	0.18	1.48 / 1.92
PEFY-P100VMH-E			3.03 / 3.93	0.26	2.42 / 3.14
PEFY-P125VMH-E			3.03 / 3.93	0.26	2.42 / 3.14
PEFY-P140VMH-E			3.10 / 3.98	0.26	2.48 / 3.18
PEFY-P200VMH-E	380-415V / 50Hz	Max.: 456V	2.03 / 2.33	0.76	1.62 / 1.86
PEFY-P250VMH-E	380-415V / 60Hz	Min.: 342V	2.50 / 2.88	1.08	2.00 / 2.30
PEFY-P200VMHS-E	220-240V / 50Hz	Max.: 264V	7.00	0.87	5.60
PEFY-P250VMHS-E	220-240V / 60Hz	Min.: 198V	7.50	0.87	6.00

PEFY-P-VMA-E PEFY-P-VMA3-E	Power supply			IFM	
	Volts / Hz	Range +-10%	MCA(A)	Output (kW)	FLA(A)
PEFY-P20VMA-E	220-240V / 50Hz 220-240V / 60Hz	Max.: 264V Min.: 198V	1.03	0.085	0.82
PEFY-P25VMA-E			1.03	0.085	0.82
PEFY-P32VMA-E			1.18	0.085	0.95
PEFY-P40VMA-E			1.43	0.085	1.14
PEFY-P50VMA-E			1.54	0.085	1.23
PEFY-P63VMA-E			2.22	0.121	1.78
PEFY-P71VMA-E			2.46	0.121	1.97
PEFY-P80VMA-E			2.47	0.121	1.98
PEFY-P100VMA-E			3.30	0.244	2.64
PEFY-P125VMA-E			3.39	0.244	2.71
PEFY-P140VMA-E			3.29	0.244	2.63
PEFY-P20VMA3-E			1.74	0.085	1.39

PEFY-P-VMAL-E	Power supply			IFM	
	Volts / Hz	Range +-10%	MCA(A)	Output (kW)	FLA(A)
PEFY-P20VMAL-E	220-240V / 50Hz 220-240V / 60Hz	Max.: 264V Min.: 198V	0.92	0.085	0.74
PEFY-P25VMAL-E			0.92	0.085	0.74
PEFY-P32VMAL-E			1.07	0.085	0.86
PEFY-P40VMAL-E			1.32	0.085	1.06
PEFY-P50VMAL-E			1.40	0.085	1.12
PEFY-P63VMAL-E			2.08	0.121	1.67
PEFY-P71VMAL-E			2.32	0.121	1.86
PEFY-P80VMAL-E			2.36	0.121	1.89
PEFY-P100VMAL-E			3.19	0.244	2.55
PEFY-P125VMAL-E			3.27	0.244	2.62
PEFY-P140VMAL-E			3.17	0.244	2.53

Symbols: MCA (Max.Circuit Amps =1.25xFLA), FLA (Full Load Amps)
IFM (Indoor Fan Motor), Output (Fan motor rated output)

S.D.Y

PEFY-P-VMH-E-F	Power supply			IFM	
	Volts / Hz	Range +-10%	MCA(A) (50 / 60Hz)	Output (kW)	FLA(A) (50 / 60Hz)
PEFY-P80VMH-E-F	220-240V / 50Hz	Max.: 264V	0.92 / 1.15	0.09	0.73 / 0.92
PEFY-P140VMH-E-F	208-230V / 60Hz	Min.: 187V	1.58 / 1.84	0.14	1.26 / 1.47
PEFY-P200VMH-E-F	380-415V / 50Hz	Max.: 456V	0.73 / 0.93	0.20	0.58 / 0.74
PEFY-P250VMH-E-F	380-415V / 60Hz	Min.: 342V	0.85 / 1.08	0.23	0.68 / 0.86

PKFY-P-VBM-E	Power supply			IFM	
	Volts / Hz	Range +-10%	MCA(A)	Output (kW)	FLA(A)
PKFY-P15VBM-E	220-240V / 50Hz 220V / 60Hz	Max.: 264V Min.: 198V	0.25	0.017	0.20
PKFY-P20VBM-E			0.25	0.017	0.20
PKFY-P25VBM-E			0.25	0.017	0.20

PKFY-P-VHM-E	Power supply			IFM	
	Volts / Hz	Range +-10%	MCA(A)	Output (kW)	FLA(A)
PKFY-P32VHM-E	220-240V / 50Hz 220V / 60Hz	Max.: 264V Min.: 198V	0.38	0.030	0.30
PKFY-P40VHM-E			0.38	0.030	0.30
PKFY-P50VHM-E			0.38	0.030	0.30

PKFY-P-VKM-E	Power supply			IFM	
	Volts / Hz	Range +-10%	MCA(A)	Output (kW)	FLA(A)
PKFY-P63VKM-E	220-240V / 50Hz	Max.: 264V	0.36	0.056	0.29
PKFY-P100VKM-E	220V / 60Hz	Min.: 198V	0.63	0.056	0.50

PCFY-P-VKM-E	Power supply			IFM	
	Volts / Hz	Range +-10%	MCA(A)	Output (kW)	FLA(A)
PCFY-P40VKM-E	220-240V / 50Hz 220V / 60Hz	Max.: 264V Min.: 198V	0.35	0.090	0.28
PCFY-P63VKM-E			0.41	0.095	0.33
PCFY-P100VKM-E			0.81	0.160	0.65
PCFY-P125VKM-E			0.95	0.160	0.76

PFFY-P-VKM-E2	Power supply			IFM	
	Volts / Hz	Range +-10%	MCA(A)	Output (kW)	FLA(A)
PFFY-P20VKM-E2	220-240V / 50Hz	Max.: 264V Min.: 198V	0.25	0.03x2	0.20
PFFY-P25VKM-E2			0.25	0.03x2	0.20
PFFY-P32VKM-E2			0.25	0.03x2	0.20
PFFY-P40VKM-E2			0.30	0.03x2	0.24

PFFY-P-VLEM-E	Power supply			IFM	
	Volts / Hz	Range +-10%	MCA(A) (50 / 60Hz)	Output (kW)	FLA(A) (50 / 60Hz)
PFFY-P20VLEM-E	220-240V / 50Hz 208-230V / 60Hz	Max.: 264V Min.: 187V	0.24 / 0.31	0.015	0.19 / 0.25
PFFY-P25VLEM-E			0.24 / 0.31	0.015	0.19 / 0.25
PFFY-P32VLEM-E			0.36 / 0.38	0.018	0.29 / 0.30
PFFY-P40VLEM-E			0.40 / 0.41	0.030	0.32 / 0.33
PFFY-P50VLEM-E			0.50 / 0.51	0.035	0.40 / 0.41
PFFY-P63VLEM-E			0.58 / 0.59	0.050	0.46 / 0.47

Symbols: MCA (Max.Circuit Amps =1.25xFLA), FLA (Full Load Amps)
IFM (Indoor Fan Motor), Output (Fan motor rated output)

PFFY-P-VLRM-E	Power supply			IFM	
	Volts / Hz	Range +-10%	MCA(A) (50 / 60Hz)	Output (kW)	FLA(A) (50 / 60Hz)
PFFY-P20VLRM-E	220-240V / 50Hz 208-230V / 60Hz	Max.: 264V Min.: 187V	0.24 / 0.31	0.015	0.19 / 0.25
PFFY-P25VLRM-E			0.24 / 0.31	0.015	0.19 / 0.25
PFFY-P32VLRM-E			0.36 / 0.38	0.018	0.29 / 0.30
PFFY-P40VLRM-E			0.40 / 0.41	0.030	0.32 / 0.33
PFFY-P50VLRM-E			0.50 / 0.51	0.035	0.40 / 0.41
PFFY-P63VLRM-E			0.58 / 0.59	0.050	0.46 / 0.47

PFFY-P-VLRMM-E	Power supply			IFM	
	Volts / Hz	Range +-10%	MCA(A) (50 / 60Hz)	Output (kW)	FLA(A) (50 / 60Hz)
PFFY-P20VLRMM-E	220-240V / 50Hz 220-240V / 60Hz	Max.: 264V Min.: 198V	0.59 / 0.58	0.096	0.47 / 0.46
PFFY-P25VLRMM-E			0.59 / 0.58	0.096	0.47 / 0.46
PFFY-P32VLRMM-E			0.69 / 0.69	0.096	0.55 / 0.55
PFFY-P40VLRMM-E			0.78 / 0.76	0.096	0.62 / 0.61
PFFY-P50VLRMM-E			0.80 / 0.79	0.096	0.64 / 0.63
PFFY-P63VLRMM-E			0.93 / 0.93	0.096	0.74 / 0.74

GUF-RDH4	Power supply			IFM	
	Volts / Hz	Range +-10%	MCA(A)	Output (kW)	FLA(A)
GUF-50RD4	220-240V / 50Hz	Max.: 264V Min.: 198V	1.62	0.305	1.29
GUF-50RDH4			1.58	0.30	1.26
GUF-100RD4			3.18	0.58	2.54
GUF-100RDH4			2.98	0.56	2.38

1-2-2. Electrical characteristics of Outdoor unit

Symbols: MCA (Max Circuit Amps)

RLA (Rated Load Amps), SC (Starting Current)

S.D.Y

PUHY-P-YKB-A1	Unit Combination	Units			Power supply	Compressor		FAN	RLA(A)(50/60Hz)	
		Hz	Volts	Voltage range	MCA(A)	Output (kW)	SC(A)	Output (kW)	Cooling	Heating
PUHY-P200YKB-A1(-BS)	-	50/60	380 400 415	Max:456V Min:342V	16.1	5.5	8	0.92	8.7/8.3/8.0	9.8/9.3/8.9
PUHY-P250YKB-A1(-BS)	-				17.8	6.9	8	0.92	11.6/11.0/10.6	12.3/11.7/11.3
PUHY-P300YKB-A1(-BS)	-				22.1	8.1	8	0.92	14.4/13.7/13.2	15.3/14.5/14.0
PUHY-P350YKB-A1(-BS)	-				28.2	10.5	8	0.92	19.7/18.7/18.0	18.7/17.8/17.2
PUHY-P400YKB-A1(-BS)	-				32.7	10.8	8	0.92	22.8/21.7/20.9	21.1/20.0/19.3
PUHY-P450YKB-A1(-BS)	-				37.8	12.4	8	0.92	24.9/23.7/22.8	26.2/24.9/24.0
PUHY-P500YKB-A1(-BS)	-				44.4	13.3	8	0.92	31.0/29.4/28.4	31.2/29.7/28.6
PUHY-P400YSKB-A1(-BS)	PUHY-P200YKB-A1(-BS)				16.1	5.5	8	0.92	18.5/17.6/17.0	20.6/19.6/18.9
	PUHY-P200YKB-A1(-BS)				16.1	5.5	8	0.92		
PUHY-P450YSKB-A1(-BS)	PUHY-P200YKB-A1(-BS)				16.1	5.5	8	0.92	21.2/20.1/19.4	23.1/22.0/21.2
	PUHY-P250YKB-A1(-BS)				17.8	6.9	8	0.92		
PUHY-P500YSKB-A1(-BS)	PUHY-P250YKB-A1(-BS)				17.8	6.9	8	0.92	24.5/23.3/22.4	26.0/24.7/23.8
	PUHY-P250YKB-A1(-BS)				17.8	6.9	8	0.92		
PUHY-P550YSKB-A1(-BS)	PUHY-P250YKB-A1(-BS)				17.8	6.9	8	0.92	28.1/26.7/25.7	29.1/27.7/26.7
	PUHY-P300YKB-A1(-BS)				22.1	8.1	8	0.92		
PUHY-P600YSKB-A1(-BS)	PUHY-P250YKB-A1(-BS)				17.8	6.9	8	0.92	32.8/31.1/30.0	32.6/31.0/29.9
	PUHY-P350YKB-A1(-BS)				28.2	10.5	8	0.92		
PUHY-P650YSKB-A1(-BS)	PUHY-P300YKB-A1(-BS)				22.1	8.1	8	0.92	35.4/33.6/32.4	35.4/33.6/32.4
	PUHY-P350YKB-A1(-BS)				28.2	10.5	8	0.92		
PUHY-P700YSKB-A1(-BS)	PUHY-P350YKB-A1(-BS)				28.2	10.5	8	0.92	41.6/39.5/38.1	38.7/36.8/35.5
	PUHY-P350YKB-A1(-BS)				28.2	10.5	8	0.92		
PUHY-P750YSKB-A1(-BS)	PUHY-P350YKB-A1(-BS)				28.2	10.5	8	0.92	44.8/42.5/41.0	42.0/39.9/38.5
	PUHY-P400YKB-A1(-BS)				32.7	10.8	8	0.92		
PUHY-P800YSKB-A1(-BS)	PUHY-P350YKB-A1(-BS)				28.2	10.5	8	0.92	47.0/44.6/43.0	46.6/44.2/42.6
	PUHY-P450YKB-A1(-BS)				37.8	12.4	8	0.92+0.92		
PUHY-P850YSKB-A1(-BS)	PUHY-P400YKB-A1(-BS)				32.7	10.8	8	0.92	50.9/48.4/46.6	50.4/47.9/46.2
	PUHY-P450YKB-A1(-BS)				37.8	12.4	8	0.92+0.92		
PUHY-P900YSKB-A1(-BS)	PUHY-P450YKB-A1(-BS)				37.8	12.4	8	0.92+0.92	53.1/50.4/48.6	55.7/52.9/51.0
	PUHY-P450YKB-A1(-BS)				37.8	12.4	8	0.92+0.92		
PUHY-P950YSKB-A1(-BS)	PUHY-P250YKB-A1(-BS)				17.8	6.9	8	0.92	51.0/48.5/46.7	51.3/48.7/46.9
	PUHY-P300YKB-A1(-BS)				22.1	8.1	8	0.92		
PUHY-P1000YSKB-A1(-BS)	PUHY-P400YKB-A1(-BS)				32.7	10.8	8	0.92	54.1/51.4/49.6	55.2/52.4/50.5
	PUHY-P300YKB-A1(-BS)				22.1	8.1	8	0.92		
PUHY-P1050YSKB-A1(-BS)	PUHY-P300YKB-A1(-BS)				22.1	8.1	8	0.92	59.1/56.1/54.1	57.8/54.9/52.9
	PUHY-P350YKB-A1(-BS)				28.2	10.5	8	0.92		
PUHY-P1100YSKB-A1(-BS)	PUHY-P400YKB-A1(-BS)				32.7	10.8	8	0.92	65.1/61.9/59.6	61.7/58.6/56.5
	PUHY-P350YKB-A1(-BS)				28.2	10.5	8	0.92		
PUHY-P1150YSKB-A1(-BS)	PUHY-P350YKB-A1(-BS)				28.2	10.5	8	0.92	67.9/64.5/62.2	66.3/63.0/60.7
	PUHY-P450YKB-A1(-BS)				37.8	12.4	8	0.92+0.92		
PUHY-P1200YSKB-A1(-BS)	PUHY-P350YKB-A1(-BS)				28.2	10.5	8	0.92	74.4/70.7/68.1	68.8/65.3/63.0
	PUHY-P400YKB-A1(-BS)				32.7	10.8	8	0.92		
PUHY-P1250YSKB-A1(-BS)	PUHY-P450YKB-A1(-BS)				37.8	12.4	8	0.92+0.92	73.9/70.2/67.7	74.4/70.6/68.1
	PUHY-P450YKB-A1(-BS)				37.8	12.4	8	0.92+0.92		
PUHY-P1300YSKB-A1(-BS)	PUHY-P400YKB-A1(-BS)				32.7	10.8	8	0.92	80.6/76.6/73.8	77.7/73.8/71.1
	PUHY-P450YKB-A1(-BS)				37.8	12.4	8	0.92+0.92		
PUHY-P1350YSKB-A1(-BS)	PUHY-P450YKB-A1(-BS)	37.8	12.4	8	0.92+0.92	80.0/76.0/73.2	82.9/78.7/75.9			
	PUHY-P450YKB-A1(-BS)	37.8	12.4	8	0.92+0.92					

1. Electrical work

YKB/YLM

S.D. Y

Symbols: MCA (Max Circuit Amps)

RLA (Rated Load Amps), SC (Starting Current)

PUHY-EP-YLM	Unit Combination	Units			Power supply	Compressor		FAN	RLA(A)(50/60Hz)	
		Hz	Volts	Voltage range	MCA(A)	Output (kW)	SC(A)	Output (kW)	Cooling	Heating
PUHY-EP200YLM-A(-BS)	-	50/60	380 400 415	Max:456V Min:342V	16.1	5.6	8	0.92	8.7/8.3/8.0	9.6/9.1/8.8
PUHY-EP250YLM-A(-BS)	-				18.1	6.9	8	0.92	11.6/11.0/10.6	12.9/12.3/11.8
PUHY-EP300YLM-A(-BS)	-				21.6	8.1	8	0.92	14.4/13.7/13.2	15.4/14.6/14.1
PUHY-EP350YLM-A(-BS)	-				28.7	10.5	8	0.92	19.7/18.7/18.0	21.1/20.0/19.3
PUHY-EP400YLM-A(-BS)	-				32.1	10.9	8	0.92+0.92	20.6/19.6/18.9	22.1/21.0/20.3
PUHY-EP450YLM-A(-BS)	-				38.0	12.4	8	0.92+0.92	24.9/23.7/22.8	27.1/25.8/24.8
PUHY-EP500YLM-A(-BS)	-				46.5	13.4	8	0.92+0.92	31.6/30.0/28.9	33.2/31.5/30.4
PUHY-EP550YSLM-A(-BS)	PUHY-EP250YLM-A(-BS)				39.7	6.9	8	0.92	28.0/26.6/25.6	29.9/28.4/27.4
	PUHY-EP300YLM-A(-BS)					8.1	8	0.92		
PUHY-EP600YSLM-A(-BS)	PUHY-EP300YLM-A(-BS)				43.2	8.1	8	0.92	31.3/29.8/28.7	33.1/31.5/30.3
	PUHY-EP300YLM-A(-BS)					8.1	8	0.92		
PUHY-EP650YSLM-A(-BS)	PUHY-EP200YLM-A(-BS)				50.3	5.6	8	0.92	30.6/29.1/28.0	33.8/32.1/31.0
	PUHY-EP200YLM-A(-BS)					5.6	8	0.92		
	PUHY-EP250YLM-A(-BS)					6.9	8	0.92		
PUHY-EP700YSLM-A(-BS)	PUHY-EP200YLM-A(-BS)				53.8	5.6	8	0.92	34.0/32.3/31.1	36.5/34.7/33.4
	PUHY-EP200YLM-A(-BS)					5.6	8	0.92		
	PUHY-EP300YLM-A(-BS)					8.1	8	0.92		
PUHY-EP750YSLM-A(-BS)	PUHY-EP200YLM-A(-BS)				55.8	5.6	8	0.92	36.8/35.0/33.7	40.3/38.3/36.9
	PUHY-EP250YLM-A(-BS)					6.9	8	0.92		
	PUHY-EP300YLM-A(-BS)					8.1	8	0.92		
PUHY-EP800YSLM-A(-BS)	PUHY-EP200YLM-A(-BS)				59.3	5.6	8	0.92	39.5/37.5/36.2	42.5/40.3/38.9
	PUHY-EP300YLM-A(-BS)					8.1	8	0.92		
	PUHY-EP300YLM-A(-BS)					8.1	8	0.92		
PUHY-EP850YSLM-A(-BS)	PUHY-EP250YLM-A(-BS)				61.3	6.9	8	0.92	43.0/40.9/39.4	46.8/44.5/42.9
	PUHY-EP300YLM-A(-BS)					8.1	8	0.92		
	PUHY-EP300YLM-A(-BS)					8.1	8	0.92		
PUHY-EP900YSLM-A(-BS)	PUHY-EP300YLM-A(-BS)				64.8	8.1	8	0.92	45.9/43.6/42.0	49.0/46.5/44.8
	PUHY-EP300YLM-A(-BS)					8.1	8	0.92		
	PUHY-EP300YLM-A(-BS)					8.1	8	0.92		
PUHY-EP950YSLM-A(-BS)	PUHY-EP300YLM-A(-BS)				71.9	8.1	8	0.92	51.2/48.6/46.8	54.0/51.3/49.5
	PUHY-EP300YLM-A(-BS)	8.1	8	0.92						
	PUHY-EP350YLM-A(-BS)	10.5	8	0.92						
PUHY-EP1000YSLM-A(-BS)	PUHY-EP300YLM-A(-BS)	75.3	8.1	8	0.92	52.4/49.7/47.9	56.5/53.7/51.7			
	PUHY-EP300YLM-A(-BS)		8.1	8	0.92					
	PUHY-EP400YLM-A(-BS)		10.9	8	0.92+0.92					
PUHY-EP1050YSLM-A(-BS)	PUHY-EP300YLM-A(-BS)	82.4	8.1	8	0.92	58.0/55.1/53.1	62.2/59.1/56.9			
	PUHY-EP350YLM-A(-BS)		10.5	8	0.92					
	PUHY-EP400YLM-A(-BS)		10.9	8	0.92+0.92					
PUHY-EP1100YSLM-A(-BS)	PUHY-EP350YLM-A(-BS)	89.5	10.5	8	0.92	64.4/61.1/58.9	69.5/66.0/63.6			
	PUHY-EP350YLM-A(-BS)		10.5	8	0.92					
	PUHY-EP400YLM-A(-BS)		10.9	8	0.92+0.92					
PUHY-EP1150YSLM-A(-BS)	PUHY-EP350YLM-A(-BS)	95.4	10.5	8	0.92	70.1/66.6/64.1	75.0/71.3/68.7			
	PUHY-EP350YLM-A(-BS)		10.5	8	0.92					
	PUHY-EP450YLM-A(-BS)		12.4	8	0.92+0.92					
PUHY-EP1200YSLM-A(-BS)	PUHY-EP350YLM-A(-BS)	98.8	10.5	8	0.92	72.1/68.5/66.0	76.7/72.8/70.2			
	PUHY-EP400YLM-A(-BS)		10.9	8	0.92+0.92					
	PUHY-EP450YLM-A(-BS)		12.4	8	0.92+0.92					
PUHY-EP1250YSLM-A(-BS)	PUHY-EP350YLM-A(-BS)	104.7	10.5	8	0.92	77.4/73.6/70.9	83.3/79.1/76.2			
	PUHY-EP450YLM-A(-BS)		12.4	8	0.92+0.92					
	PUHY-EP450YLM-A(-BS)		12.4	8	0.92+0.92					
PUHY-EP1300YSLM-A(-BS)	PUHY-EP400YLM-A(-BS)	108.1	10.9	8	0.92+0.92	79.2/75.2/72.5	85.4/81.1/78.2			
	PUHY-EP450YLM-A(-BS)		12.4	8	0.92+0.92					
	PUHY-EP450YLM-A(-BS)		12.4	8	0.92+0.92					
PUHY-EP1350YSLM-A(-BS)	PUHY-EP450YLM-A(-BS)	114.0	12.4	8	0.92+0.92	84.4/80.1/77.2	91.7/87.1/84.0			
	PUHY-EP450YLM-A(-BS)		12.4	8	0.92+0.92					
	PUHY-EP450YLM-A(-BS)		12.4	8	0.92+0.92					

1-3. Power cable specifications

PUHY-P-YKB-A1

Thickness of wire for main power supply, capacities of the switch and system impedance

	Model	Minimum wire thickness (mm ²)			Ground-fault interrupter *1	Local switch (A)		Breaker for wiring (A) (Non-fuse breaker)	Max. Permissible System Impedance
		Main cable	Branch	Ground		Capacity	Fuse		
Outdoor unit	PUHY-P200YKB-A1	4.0	-	4.0	30A 100mA 0.1sec. or less	25	25	30	*2
	PUHY-P250YKB-A1	4.0	-	4.0	30A 100mA 0.1sec. or less	32	32	30	*2
	PUHY-P300YKB-A1	4.0	-	4.0	30A 100mA 0.1sec. or less	32	32	30	*2
	PUHY-P350YKB-A1	6.0	-	6.0	40A 100mA 0.1sec. or less	40	40	40	0.25Ω
	PUHY-P400YKB-A1	10.0	-	10.0	60A 100mA 0.1sec. or less	63	63	60	0.22Ω
	PUHY-P450YKB-A1	10.0	-	10.0	60A 100mA 0.1sec. or less	63	63	60	0.19Ω
Total operating current of the indoor unit	F0 = 16A or less *3	1.5	1.5	1.5	20A current sensitivity *4	16	16	20	(apply to IEC61000-3-3)
	F0 = 25A or less *3	2.5	2.5	2.5	30A current sensitivity *4	25	25	30	(apply to IEC61000-3-3)
	F0 = 32A or less *3	4.0	4.0	4.0	40A current sensitivity *4	32	32	40	(apply to IEC61000-3-3)

- *1 The Ground-fault interrupter should support Inverter circuit.
The Ground-fault interrupter should combine using of local switch or wiring breaker.
- *2 Meet technical requirements of IEC61000-3-3
- *3 Please take the larger of F1 or F2 as the value for F0.
F1 = Total operating maximum current of the indoor units x 1.2
F2 = {V1 x (Quantity of Type1)/C} + {V1 x (Quantity of Type2)/C} + {V1 x (Quantity of Type3)/C} + {V1 x (Quantity of Others)/C}

Indoor unit		V1	V2
Type1	PLFY-VBM, PMFY-VBM, PEFY-VMS, PCFY-VKM, PKFY-VHM, PKFY-VKM, PFFY-VKM, PFFY-VLRMM	18.6	2.4
Type2	PEFY-VMA	38	1.6
Type3	PEFY-VMHS	13.8	4.8
Others	Other indoor unit	0	0

C: Multiple of tripping current at tripping time 0.01s
Please pick up "C" from the tripping characteristic of the breaker.

<Example of "F2" calculation>

*Condition PEFY-VMS x 4 + PEFY-VMA x 1, C = 8 (refer to right sample chart)
F2 = 18.6 x 4/8 + 38 x 1/8
= 14.05
→ 16 A breaker (Tripping current = 8 x 16 A at 0.01s)

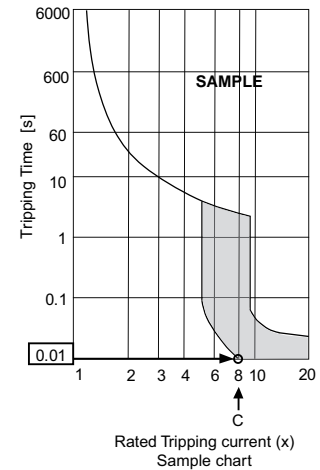

- *4 Current sensitivity is calculated using the following formula.
G1 = (V2 x Quantity of Type1) + (V2 x Quantity of Type2) + (V2 x Quantity of Type3) + (V2 x Quantity of Others) + (V3 x Wire length [km])

G1	Current sensitivity	Wire thickness	V3
30 or less	30 mA 0.1sec or less	1.5 mm ²	48
100 or less	100 mA 0.1sec or less	2.5 mm ²	56
		4.0 mm ²	66

- Use dedicated power supplies for the outdoor unit and indoor unit. Ensure OC and OS are wired individually.
- Bear in mind ambient conditions (ambient temperature, direct sunlight, rain water, etc.) when proceeding with the wiring and connections.
- The wire size is the minimum value for metal conduit wiring. If the voltage drops, use a wire that is one rank thicker in diameter. Make sure the power-supply voltage does not drop more than 10%. Make sure that the voltage imbalance between the phases is 2% or less.
- Specific wiring requirements should adhere to the wiring regulations of the region.
- Power supply cords of parts of appliances for outdoor use shall not be lighter than polychloroprene sheathed flexible cord (design 60245 IEC57). For example, use wiring such as YZW.
- A switch with at least 3 mm contact separation in each pole shall be provided by the Air conditioner installation.

⚠ WARNING

- Be sure to use specified wires for connections and ensure no external force is imparted to terminal connections. If connections are not fixed firmly, heating or fire may result.
- Be sure to use the appropriate type of overcurrent protection switch. Note that generated overcurrent may include some amount of direct current.

⚠ CAUTION

- The breakers for current leakage should support Inverter circuit. (e.g. Mitsubishi Electric's NV-S series or equivalent). If no earth leakage breaker is installed, it may cause an electric shock.
- Breakers for current leakage should combine using of switch.
- Do not use anything other than a breaker with the correct capacity. Using a breaker of too large capacity may cause malfunction or fire.
- If a large electric current flows due to malfunction or faulty wiring, earth-leakage breakers on the unit side and on the upstream side of the power supply system may both operate. Depending on the importance of the system, separate the power supply system or take protective coordination of breakers.

Note

- This device is intended for the connection to a power supply system with a maximum permissible system impedance shown in the above table at the interface point (power service box) of the user's supply.
- The user must ensure that this device is connected only to a power supply system which fulfils the requirement above. If necessary, the user can ask the public power supply company for the system impedance at the interface point.
- This equipment complies with IEC 61000-3-12 provided that the short-circuit power Ssc is greater than or equal to Ssc (*2) at the interface point between the user's supply and the public system. It is the responsibility of the installer or user of the equipment to ensure, by consultation with the distribution network operator if necessary, that the equipment is connected only to a supply with a short-circuit power Ssc greater than or equal to Ssc (*2).

Ssc(*2)

Model	PUHY-P200YKB-A1	PUHY-P250YKB-A1	PUHY-P300YKB-A1	PUHY-P350YKB-A1	PUHY-P400YKB-A1	PUHY-P450YKB-A1	PUHY-P500YKB-A1
Ssc (MVA)	1.39	1.54	1.91	2.43	2.82	3.26	3.83

PUHY-EP-YLM

Thickness of wire for main power supply, capacities of the switch and system impedance

	Model	Minimum wire thickness (mm ²)			Ground-fault interrupter *1	Local switch (A)		Breaker for wiring (A) (Non-fuse breaker)	Max. Permissible System Impedance
		Main cable	Branch	Ground		Capacity	Fuse		
Outdoor unit	PUHY-EP200YLM	4.0	-	4.0	30A 100mA 0.1sec. or less	25	25	30	*2
	PUHY-EP250YLM	4.0	-	4.0	30A 100mA 0.1sec. or less	32	32	30	*2
	PUHY-EP300YLM	4.0	-	4.0	30A 100mA 0.1sec. or less	32	32	30	*2
	PUHY-EP350YLM	6.0	-	6.0	40A 100mA 0.1sec. or less	40	40	40	0.25Ω
	PUHY-EP400YLM	10.0	-	10.0	60A 100mA 0.1sec. or less	63	63	60	0.22Ω
	PUHY-EP450YLM	10.0	-	10.0	60A 100mA 0.1sec. or less	63	63	60	0.19Ω
	PUHY-EP500YLM	10.0	-	10.0	60A 100mA 0.1sec. or less	63	63	60	0.15Ω
Total operating current of the indoor unit	F0 = 16A or less *3	1.5	1.5	1.5	20A current sensitivity *4	16	16	20	(apply to IEC61000-3-3)
	F0 = 25A or less *3	2.5	2.5	2.5	30A current sensitivity *4	25	25	30	(apply to IEC61000-3-3)
	F0 = 32A or less *3	4.0	4.0	4.0	40A current sensitivity *4	32	32	40	(apply to IEC61000-3-3)

*1 The Ground-fault interrupter should support Inverter circuit.

The Ground-fault interrupter should combine using of local switch or wiring breaker.

*2 Meet technical requirements of IEC61000-3-3

*3 Please take the larger of F1 or F2 as the value for F0.

F1 = Total operating maximum current of the indoor units × 1.2

F2 = {V1 × (Quantity of Type1)/C} + {V1 × (Quantity of Type2)/C} + {V1 × (Quantity of Type3)/C} + {V1 × (Quantity of Others)/C}

Indoor unit		V1	V2
Type1	PLFY-VBM, PMFY-VBM, PEFY-VMS, PCFY-VKM, PKFY-VHM, PKFY-VKM, PFFY-VKM, PFFY-VLRMM	18.6	2.4
Type2	PEFY-VMA	38	1.6
Type3	PEFY-VMHS	13.8	4.8
Others	Other indoor unit	0	0

C: Multiple of tripping current at tripping time 0.01s

Please pick up "C" from the tripping characteristic of the breaker.

<Example of "F2" calculation>

*Condition PEFY-VMS × 4 + PEFY-VMA × 1, C = 8 (refer to right sample chart)

F2 = 18.6 × 4/8 + 38 × 1/8

= 14.05

→16 A breaker (Tripping current = 8 × 16 A at 0.01s)

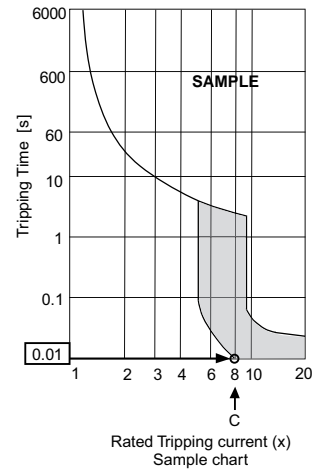

*4 Current sensitivity is calculated using the following formula.

G1 = (V2 × Quantity of Type1) + (V2 × Quantity of Type2) + (V2 × Quantity of Type3) + (V2 × Quantity of Others) + (V3 × Wire length [km])

G1	Current sensitivity	Wire thickness	V3
30 or less	30 mA 0.1sec or less	1.5 mm ²	48
100 or less	100 mA 0.1sec or less	2.5 mm ²	56
		4.0 mm ²	66

- Use dedicated power supplies for the outdoor unit and indoor unit. Ensure OC and OS are wired individually.
- Bear in mind ambient conditions (ambient temperature, direct sunlight, rain water, etc.) when proceeding with the wiring and connections.
- The wire size is the minimum value for metal conduit wiring. If the voltage drops, use a wire that is one rank thicker in diameter. Make sure the power-supply voltage does not drop more than 10%. Make sure that the voltage imbalance between the phases is 2% or less.
- Specific wiring requirements should adhere to the wiring regulations of the region.
- Power supply cords of parts of appliances for outdoor use shall not be lighter than polychloroprene sheathed flexible cord (design 60245 IEC57). For example, use wiring such as YZW.
- A switch with at least 3 mm contact separation in each pole shall be provided by the Air conditioner installation.

⚠ WARNING

- Be sure to use specified wires for connections and ensure no external force is imparted to terminal connections. If connections are not fixed firmly, heating or fire may result.
- Be sure to use the appropriate type of overcurrent protection switch. Note that generated overcurrent may include some amount of direct current.

⚠ CAUTION

- The breakers for current leakage should support Inverter circuit. (e.g. Mitsubishi Electric's NV-S series or equivalent). If no earth leakage breaker is installed, it may cause an electric shock.
- Breakers for current leakage should combine using of switch.
- Do not use anything other than a breaker with the correct capacity. Using a breaker of too large capacity may cause malfunction or fire.
- If a large electric current flows due to malfunction or faulty wiring, earth-leakage breakers on the unit side and on the upstream side of the power supply system may both operate. Depending on the importance of the system, separate the power supply system or take protective coordination of breakers.

Note

- This device is intended for the connection to a power supply system with a maximum permissible system impedance shown in the above table at the interface point (power service box) of the user's supply.
- The user must ensure that this device is connected only to a power supply system which fulfils the requirement above. If necessary, the user can ask the public power supply company for the system impedance at the interface point.
- This equipment complies with IEC 61000-3-12 provided that the short-circuit power Ssc is greater than or equal to Ssc (*2) at the interface point between the user's supply and the public system. It is the responsibility of the installer or user of the equipment to ensure, by consultation with the distribution network operator if necessary, that the equipment is connected only to a supply with a short-circuit power Ssc greater than or equal to Ssc (*2).

Ssc(*2)

Model	PUHY-EP200YLM	PUHY-EP250YLM	PUHY-EP300YLM	PUHY-EP350YLM	PUHY-EP400YLM	PUHY-EP450YLM	PUHY-EP500YLM
Ssc (MVA)	1.39	1.56	1.86	2.48	2.77	3.28	4.01

1-4. Power supply examples

The local standards and/or regulations is applicable at a higher priority.
 1-4-1. PUHY-P200, 250, 300, 350, 400, 450, 500YKB-A1

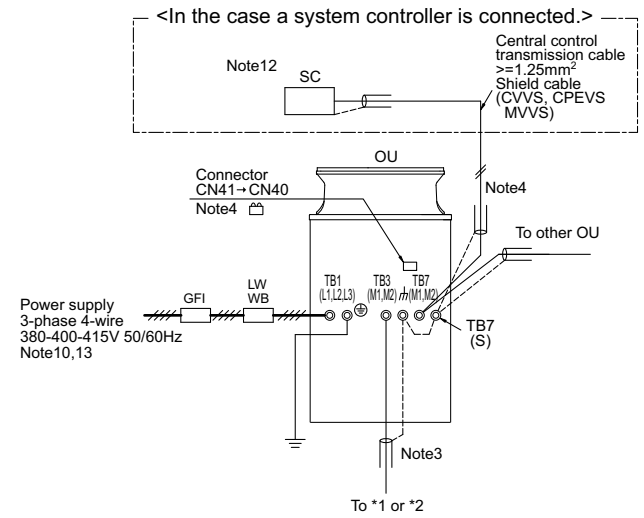

- Note:
- The transmission cable is not-polarity double-wire.
 - Symbol Ⓞ means a screw terminal for wiring.
 - The shield wire of transmission cable should be connected to the grounding terminal at Outdoor unit. All shield wire of M-Net transmission cable among Indoor units should be connected to the S terminal at Indoor unit or all shield wire should be connected together. The broken line at the scheme means shield wire.
 - When the Outdoor unit connected with system controller, power-supply to TB7 of the outdoor unit(s) is needed. The connector change from CN41 to CN40 at one of the outdoor units will enable the outdoor unit to supply power to TB7, or an extra power supplying unit PAC-SC51KUA should be used. The transmission cable (above 1.25mm², shielded, CVVS/CPEVS/MVVS) among Outdoor units and system controllers is called central control transmission cable. The shield wire of the central control transmission cable must be grounded at the Outdoor unit whose CN41 is changed to CN40. When the power supplying unit PAC-SC51KUA is used, connect the shield cable to the ground terminal on the PAC-SC51KUA.
 - MA R/C transmission cable (0.3-1.25mm²) must be less than 200m in length, while ME R/C transmission cable (0.3-1.25mm²) must be less than 10m in length. But transmission cable to the ME R/C can be extend using a M-NET cable ($\geq 1.25\text{mm}^2$) when the length is counted in the M-Net length. Both Compact MA and ME R/C transmission cables size 0.75-1.25mm² in thickness.
 - MA remote controller and ME remote controller should not be grouped together. When a PAR-31MAAE is connected to a group, no other MA remote controllers can be connected to the same group.
 - If using 1 or 2 (main/sub) MA remote controller to control more than 1 Indoor unit, use MA transmission cable to connect all the TB15 terminals of the Indoor units. It is called "Grouping".
 If using 1 or 2 (main/sub) ME remote controller control more than 1 indoor unit, set address to Indoor unit and ME remote controller. For the method, refer to 2-4. "Address setting".
 - Indoor board consumes power from TB3. The power balance should be considered according to System Design 2-3 "System configuration restrictions".
 - If Transmission booster is needed, be sure to connect the shield wires to the both sides to the booster.
 - The critical current for choosing power source equipment is approximate 1.4 times of total rated current of the Outdoor unit(s) or Indoor unit(s).
 - Numbers shown with () indicates a diameter of the compact remote controller.
 - When System controller (SC) is connected to the system, turn the SW5-1 on.
 - The phases of electricity power must be confirmed to be right used. Phase-reverse, or phase-missing could break the controllers.

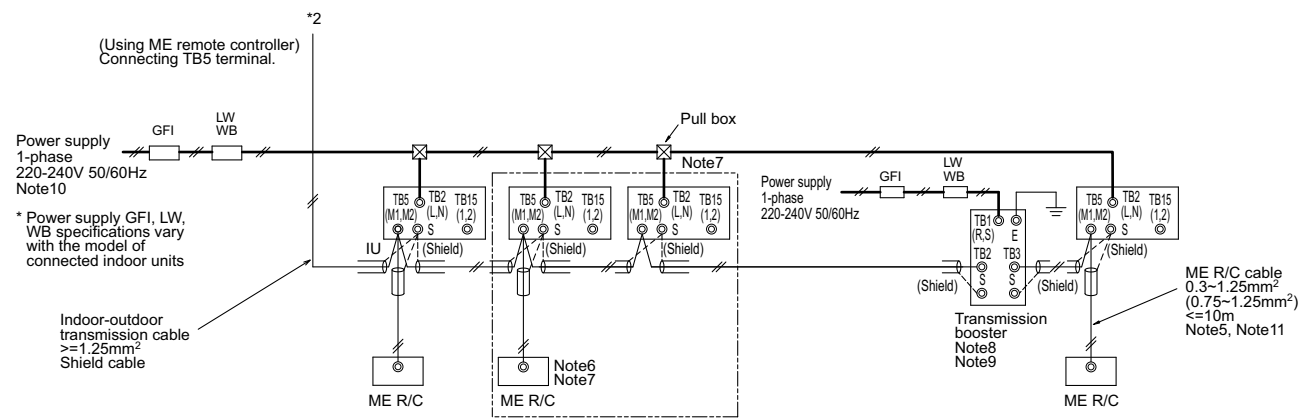
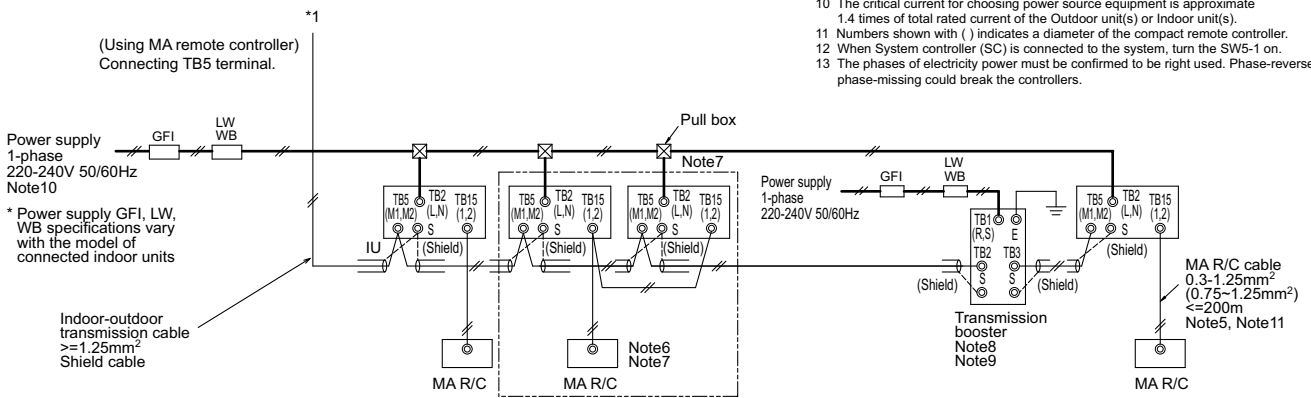

Symbol	Model	Ground-fault interrupter *1, *2, *4	Local switch		Wiring breaker*4 (NFB)	Minimum Wire thickness		
			BKC <A>	OCP*3, *4 <A>		Power wire <mm>	Earth wire <mm>	
GFI	Ground-fault interrupter	PUHY-P200YKB-A1	30A 100mA 0.1sec. or less	25	25	30	4	4
LW	Local switch	PUHY-P250YKB-A1	30A 100mA 0.1sec. or less	32	32	30	4	4
BKC	Breaker capacity	PUHY-P300YKB-A1	30A 100mA 0.1sec. or less	32	32	30	4	4
OCP	Over-current protector	PUHY-P350YKB-A1	40A 100mA 0.1sec. or less	40	40	40	6	6
WB	Wiring breaker	PUHY-P400YKB-A1	60A 100mA 0.1sec. or less	63	63	60	10	10
NFB	Non-fuse breaker	PUHY-P450YKB-A1	60A 100mA 0.1sec. or less	63	63	60	10	10
OU	Outdoor unit	PUHY-P500YKB-A1	60A 100mA 0.1sec. or less	63	63	60	10	10

*1 The Ground-fault interrupter should support Inverter circuit. (e.g. Mitsubishi Electric's NV-S series or equivalent).
 *2 Ground-fault interrupter should combine using of local switch or wiring breaker.
 *3 It shows data for B-type fuse of the breaker for current leakage.
 *4 If a large electric current flows due to malfunction or faulty wiring, earth-leakage breakers on the unit side and on the centralized controller side may both operate.
 Depending on the importance of the system, separate the power supply system or take protective coordination of breakers.

The local standards and/or regulations is applicable at a higher priority.
 1-4-2. PUHY-P400, 450, 500, 550, 600, 650, 700, 750, 800, 850, 900YSKB-A1

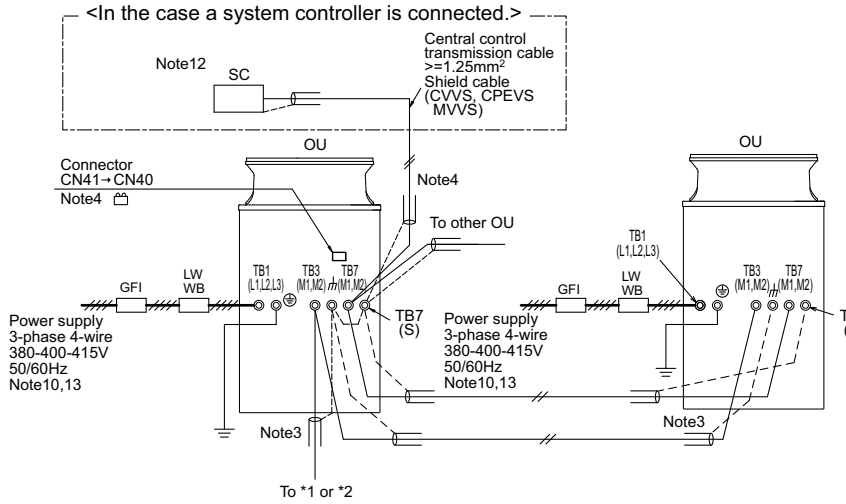

- Note:
- The transmission cable is not-polarity double-wire.
 - Symbol (S) means a screw terminal for wiring.
 - The shield wire of transmission cable should be connected to the grounding terminal at Outdoor unit. All shield wire of M-Net transmission cable among Indoor units should be connected to the S terminal at Indoor unit or all shield wire should be connected together. The broken line at the scheme means shield wire.
 - When the Outdoor unit connected with system controller, power-supply to TB7 of the outdoor unit(s) is needed. The connector change from CN41 to CN40 at one of the outdoor units will enable the outdoor unit to supply power to TB7, or an extra power supplying unit PAC-SC51KUA should be used. The transmission cable (above 1.25mm², shielded, CVVS/CPEVS/MVVS) among Outdoor units and system controllers is called central control transmission cable. The shield wire of the central control transmission cable must be grounded at the Outdoor unit whose CN41 is changed to CN40. When the power supplying unit PAC-SC51KUA is used, connect the shielded cable to the ground terminal on the PAC-SC51KUA.
 - MA R/C transmission cable (0.3-1.25mm²) must be less than 200m in length, while ME R/C transmission cable (0.3-1.25mm²) must be less than 10m in length. But transmission cable to the ME R/C can be extended using a M-NET cable (>=1.25mm²) when the length is counted in the M-Net length. Both Compact MA and ME R/C transmission cables size 0.75-1.25mm² in thickness.
 - MA remote controller and ME remote controller should not be grouped together. When a PAR-31MAAE is connected to a group, no other MA remote controllers can be connected to the same group.
 - If using 1 or 2 (main/sub) MA remote controller to control more than 1 Indoor unit, use MA transmission cable to connect all the TB15 terminals of the Indoor units. It is called "Grouping".
If using 1 or 2 (main/sub) ME remote controller control more than 1 indoor unit, set address to Indoor unit and ME remote controller. For the method, refer to 2-4. "Address setting".
 - Indoor board consumes power from TB3. The power balance should be considered according to System Design 2-3 "System configuration restrictions".
 - If Transmission booster is needed, be sure to connect the shield wires to the both sides to the booster.
 - The critical current for choosing power source equipment is approximate 1.4 times of total rated current of the Outdoor unit(s) or Indoor unit(s).
 - Numbers shown with () indicates a diameter of the compact remote controller.
 - When System controller (SC) is connected to the system, turn the SW5-1 on.
 - The phases of electricity power must be confirmed to be right used. Phase-reverse, or phase-missing could break the controllers.

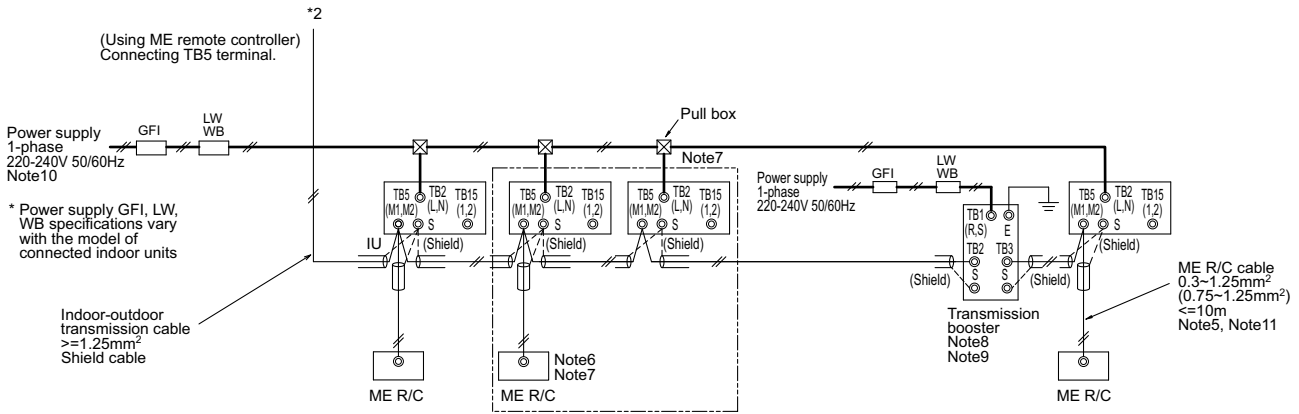
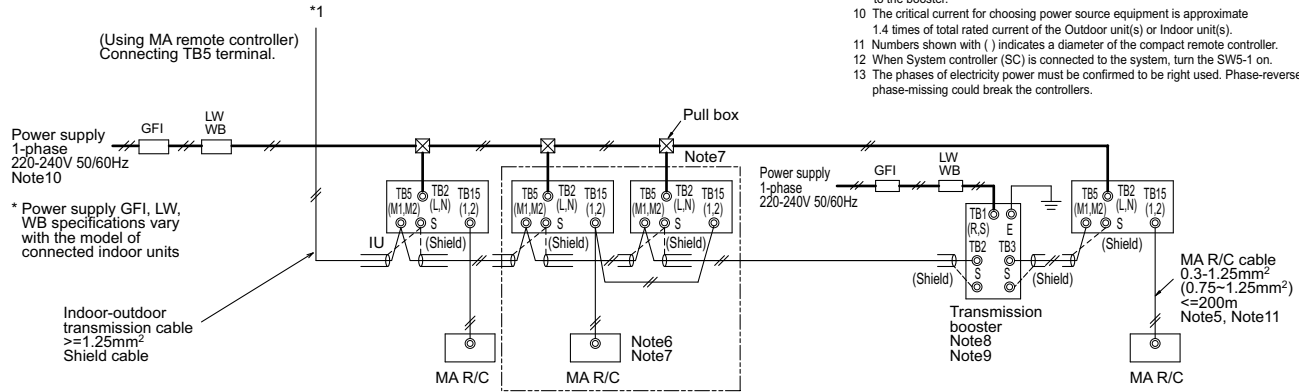

Symbol	Model	Ground-fault interrupter *1, *2, *4	Local switch			Wiring breaker*4 (NFB)		Minimum Wire thickness	
			BKC <A>	OCP*3, *4 <A>	(NFB) <A>	Power wire <mm ² >	Earth wire <mm ² >		
GFI	Ground-fault interrupter	PUHY-P200YKB-A1	30A 100mA 0.1sec. or less	25	25	30	4	4	
LW	Local switch	PUHY-P250YKB-A1	30A 100mA 0.1sec. or less	32	32	30	4	4	
BKC	Breaker capacity	PUHY-P300YKB-A1	30A 100mA 0.1sec. or less	32	32	30	4	4	
OCP	Over-current protector	PUHY-P350YKB-A1	40A 100mA 0.1sec. or less	40	40	40	6	6	
WB	Wiring breaker	PUHY-P400YKB-A1	60A 100mA 0.1sec. or less	63	63	60	10	10	
NFB	Non-fuse breaker	PUHY-P450YKB-A1	60A 100mA 0.1sec. or less	63	63	60	10	10	

*1 The Ground-fault interrupter should support Inverter circuit. (e.g. Mitsubishi Electric's NV-S series or equivalent).
 *2 Ground-fault interrupter should combine using of local switch or wiring breaker.
 *3 It shows data for B-type fuse of the breaker for current leakage.
 *4 If a large electric current flows due to malfunction or faulty wiring, earth-leakage breakers on the unit side and on the centralized controller side may both operate.
 Depending on the importance of the system, separate the power supply system or take protective coordination of breakers.

The local standards and/or regulations is applicable at a higher priority.
 1-4-3. PUHY-P950, 1000, 1050, 1100, 1150, 1200, 1250, 1300, 1350YSKB-A1

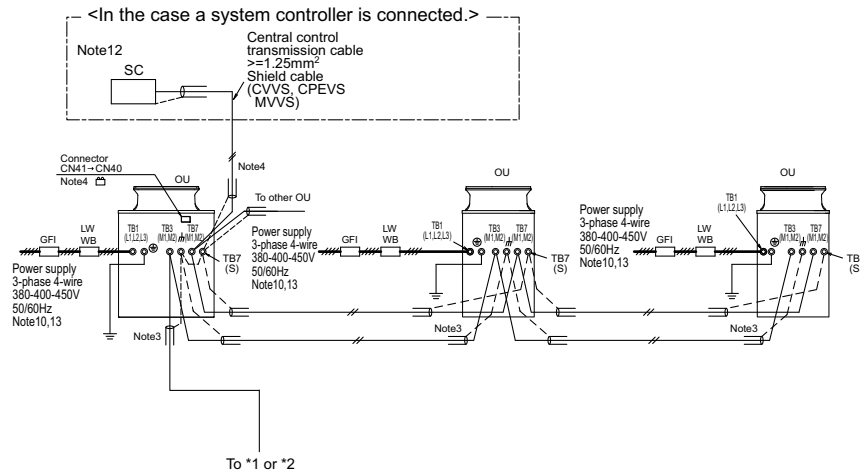

- Note:
- The transmission cable is not-polarity double-wire.
 - Symbol © means a screw terminal for wiring.
 - The shield wire of transmission cable should be connected to the grounding terminal at Outdoor unit. All shield wire of M-Net transmission cable among Indoor units should be connected to the S terminal at Indoor unit or all shield wire should be connected together. The broken line at the scheme means shield wire.
 - When the Outdoor unit connected with system controller, power-supply to TB7 of the outdoor unit(s) is needed. The connector change from CN41 to CN40 at one of the outdoor units will enable the outdoor unit to supply power to TB7, or an extra power supplying unit PAC-SC51KUA should be used. The transmission cable (above 1.25mm², shielded, C/VVS/CPEVS/MVVS) among Outdoor units and system controllers is called central control transmission cable. The shield wire of the central control transmission cable must be grounded at the Outdoor unit whose CN41 is changed to CN40. When the power supplying unit PAC-SC51KUA is used, connect the shielded cable to the ground terminal on the PAC-SC51KUA.
 - MA R/C transmission cable (0.3-1.25mm²) must be less than 200m in length, while ME R/C transmission cable (0.3-1.25mm²) must be less than 10m in length. But transmission cable to the ME R/C can be extend using a M-NET cable (>=1.25mm²) when the length is counted in the M-Net length. Both Compact MA and ME R/C transmission cables size 0.75-1.25mm² in thickness.
 - MA remote controller and ME remote controller should not be grouped together. When a PAR-31MAAE is connected to a group, no other MA remote controllers can be connected to the same group.
 - If using 1 or 2 (main/sub) MA remote controller to control more than 1 Indoor unit, use MA transmission cable to connect all the TB15 terminals of the Indoor units. It is called "Grouping". If using 1 or 2 (main/sub) ME remote controller control more than 1 indoor unit, set address to Indoor unit and ME remote controller. For the method, refer to 2-4. "Address setting".
 - Indoor board consumes power from TB3. The power balance should be considered according to System Design 2-3 "System configuration restrictions".
 - If Transmission booster is needed, be sure to connect the shield wires to the both sides to the booster.
 - The critical current for choosing power source equipment is approximate 1.4 times of total rated current of the Outdoor unit(s) or Indoor unit(s).
 - Numbers shown with () indicates a diameter of the compact remote controller.
 - When System controller (SC) is connected to the system, turn the SW5-1 on.
 - The phases of electricity power must be confirmed to be right used. Phase-reverse, or phase-missing could break the controllers.

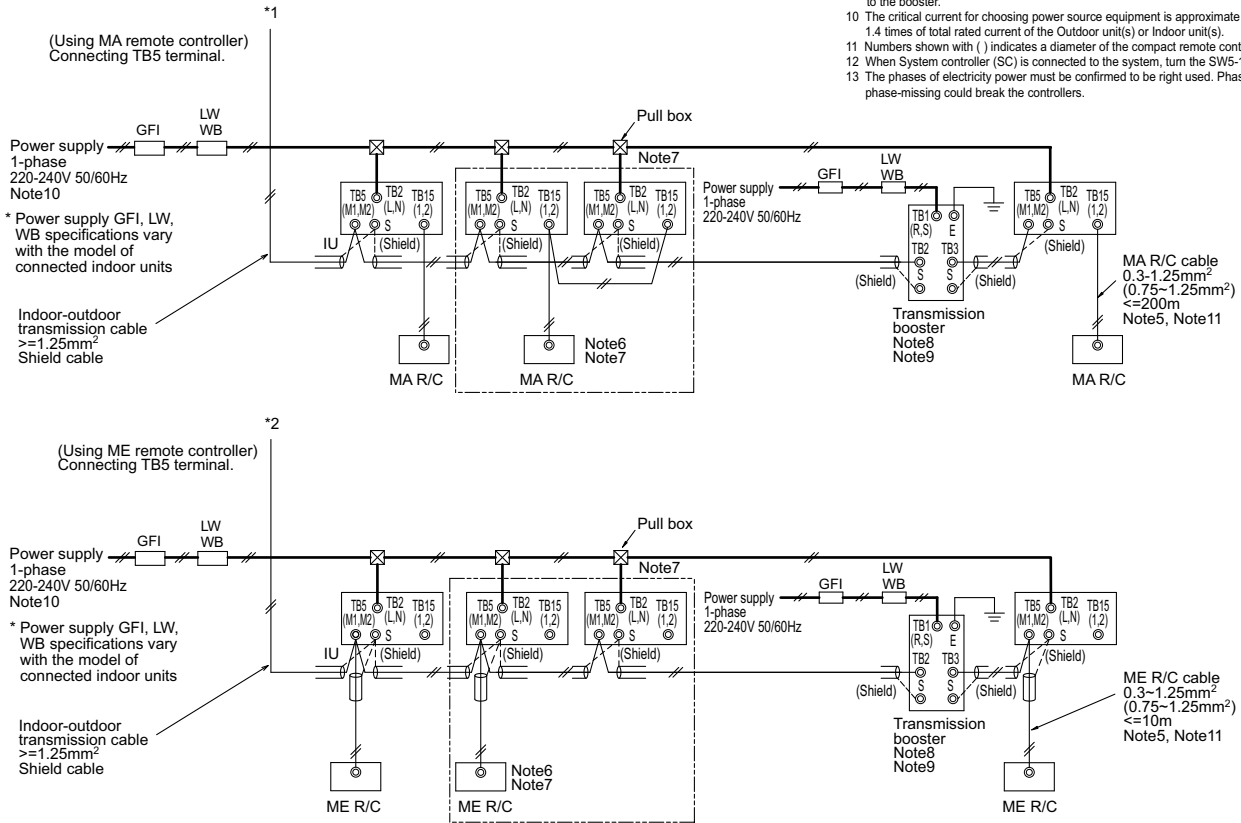

Symbol	Model	Ground-fault interrupter *1, *2, *4	Local switch			Wiring breaker*4 (NFB)	Minimum Wire thickness	
			BKC <A>	OCP*3, *4 <A>	(NFB) <A>		Power wire <mm²>	Earth wire <mm²>
GFI	Ground-fault interrupter	PUHY-P200YKB-A1	30A 100mA 0.1sec. or less	25	25	30	4	4
LW	Local switch	PUHY-P250YKB-A1	30A 100mA 0.1sec. or less	32	32	30	4	4
BKC	Breaker capacity	PUHY-P300YKB-A1	30A 100mA 0.1sec. or less	32	32	30	4	4
OCP	Over-current protector	PUHY-P350YKB-A1	40A 100mA 0.1sec. or less	40	40	40	6	6
WB	Wiring breaker	PUHY-P400YKB-A1	60A 100mA 0.1sec. or less	63	63	60	10	10
NFB	Non-fuse breaker	PUHY-P450YKB-A1	60A 100mA 0.1sec. or less	63	63	60	10	10

*1 The Ground-fault interrupter should support Inverter circuit. (e.g. Mitsubishi Electric's NV-S series or equivalent).
 *2 Ground-fault interrupter should combine using of local switch or wiring breaker.
 *3 It shows data for B-type fuse of the breaker for current leakage.
 *4 If a large electric current flows due to malfunction or faulty wiring, earth-leakage breakers on the unit side and on the centralized controller side may both operate.
 Depending on the importance of the system, separate the power supply system or take protective coordination of breakers.

The local standards and/or regulations is applicable at a higher priority.
 1-4-4. PUHY-EP200, 250, 300, 350, 400, 450, 500YLM-A

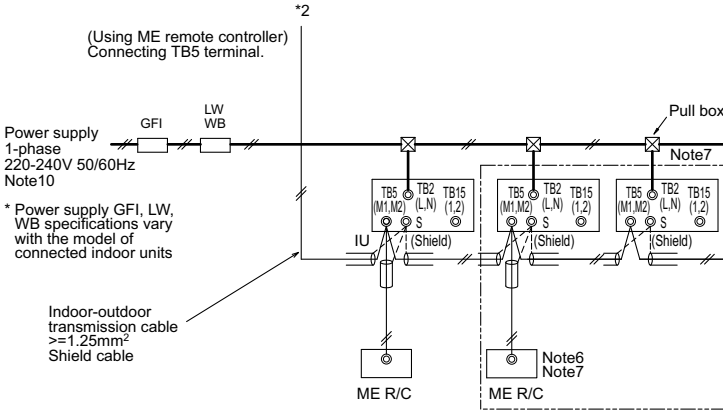
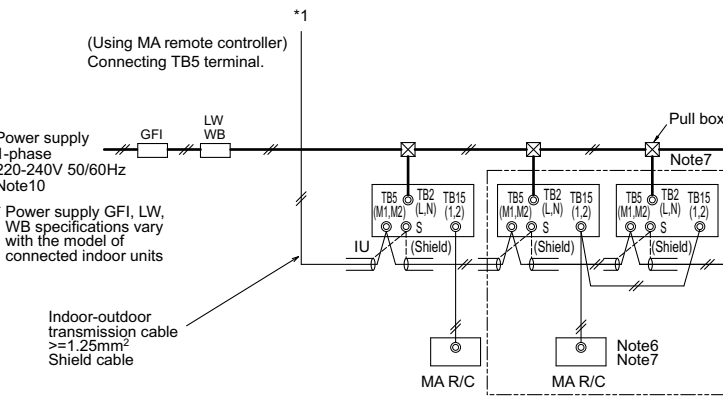
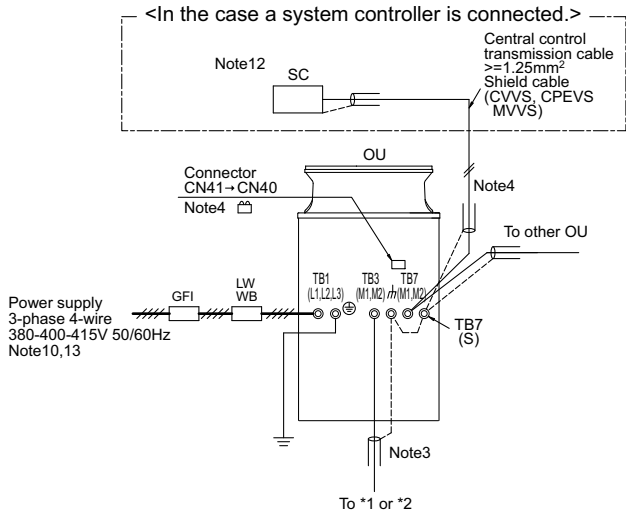

- Note:
- The transmission cable is not-polarity double-wire.
 - Symbol Ⓞ means a screw terminal for wiring.
 - The shield wire of transmission cable should be connected to the grounding terminal at Outdoor unit. All shield wire of M-Net transmission cable among Indoor units should be connected to the S terminal at Indoor unit or all shield wire should be connected together. The broken line at the scheme means shield wire.
 - When the Outdoor unit connected with system controller, power-supply to TB7 of the outdoor unit(s) is needed. The connector change from CN41 to CN40 at one of the outdoor units will enable the outdoor unit to supply power to TB7, or an extra power supplying unit PAC-SC51KUA should be used. The transmission cable (above 1.25mm², shielded, CVVS/CPEVS/MVVS) among Outdoor units and system controllers is called central control transmission cable. The shield wire of the central control transmission cable must be grounded at the Outdoor unit whose CN41 is changed to CN40. When the power supplying unit PAC-SC51KUA is used, connect the shielded cable to the ground terminal on the PAC-SC51KUA.
 - MA R/C transmission cable (0.3-1.25mm²) must be less than 200m in length, while ME R/C transmission cable (0.3-1.25mm²) must be less than 10m in length. But transmission cable to the ME R/C can be extend using a M-NET cable (>=1.25mm²) when the length is counted in the M-Net length. Both Compact MA and ME R/C transmission cables size 0.75-1.25mm² in thickness.
 - MA remote controller and ME remote controller should not be grouped together. When a PAR-31MAA is connected to a group, no other MA remote controllers can be connected to the same group.
 - If using 1 or 2 (main/sub) MA remote controller to control more than 1 Indoor unit, use MA transmission cable to connect all the TB15 terminals of the Indoor units. It is called "Grouping". If using 1 or 2 (main/sub) ME remote controller control more than 1 indoor unit, set address to Indoor unit and ME remote controller. For the method, refer to 2-4. "Address setting".
 - Indoor board consumes power from TB3. The power balance should be considered according to System Design 2-3 "System configuration restrictions".
 - If Transmission booster is needed, be sure to connect the shield wires to the both sides to the booster.
 - The critical current for choosing power source equipment is approximate 1.4 times of total rated current of the Outdoor unit(s) or Indoor unit(s).
 - Numbers shown with () indicates a diameter of the compact remote controller.
 - When System controller (SC) is connected to the system, turn the SW5-1 on.
 - The phases of electricity power must be confirmed to be right used. Phase-reverse, or phase-missing could break the controllers.

Symbol	Model	Ground-fault interrupter *1, *2, *4	Local switch			Wiring breaker*4		Minimum Wire thickness	
			BKC <A>	OCP*3, *4 <A>	(NFB) <A>	Power wire <mm²>	Earth wire <mm²>		
GFI	Ground-fault interrupter	PUHY-EP200YLM	30A 100mA 0.1sec. or less	25	25	30	4	4	
LW	Local switch	PUHY-EP250YLM	30A 100mA 0.1sec. or less	32	32	30	4	4	
BKC	Breaker capacity	PUHY-EP300YLM	30A 100mA 0.1sec. or less	32	32	30	4	4	
OCP	Over-current protector	PUHY-EP350YLM	40A 100mA 0.1sec. or less	40	40	40	6	6	
WB	Wiring breaker	PUHY-EP400YLM	60A 100mA 0.1sec. or less	63	63	60	10	10	
NFB	Non-fuse breaker	PUHY-EP450YLM	60A 100mA 0.1sec. or less	63	63	60	10	10	
OU	Outdoor unit	PUHY-EP500YLM	60A 100mA 0.1sec. or less	63	63	60	10	10	

*1 The Ground-fault interrupter should support Inverter circuit. (e.g. Mitsubishi Electric's NV-S series or equivalent).
 *2 Ground-fault interrupter should combine using of local switch or wiring breaker.
 *3 It shows data for B-type fuse of the breaker for current leakage.
 *4 If a large electric current flows due to malfunction or faulty wiring, earth-leakage breakers on the unit side and on the centralized controller side may both operate.
 Depending on the importance of the system, separate the power supply system or take protective coordination of breakers.

The local standards and/or regulations is applicable at a higher priority.
 1-4-5. PUHY-EP550, 600YSLM-A

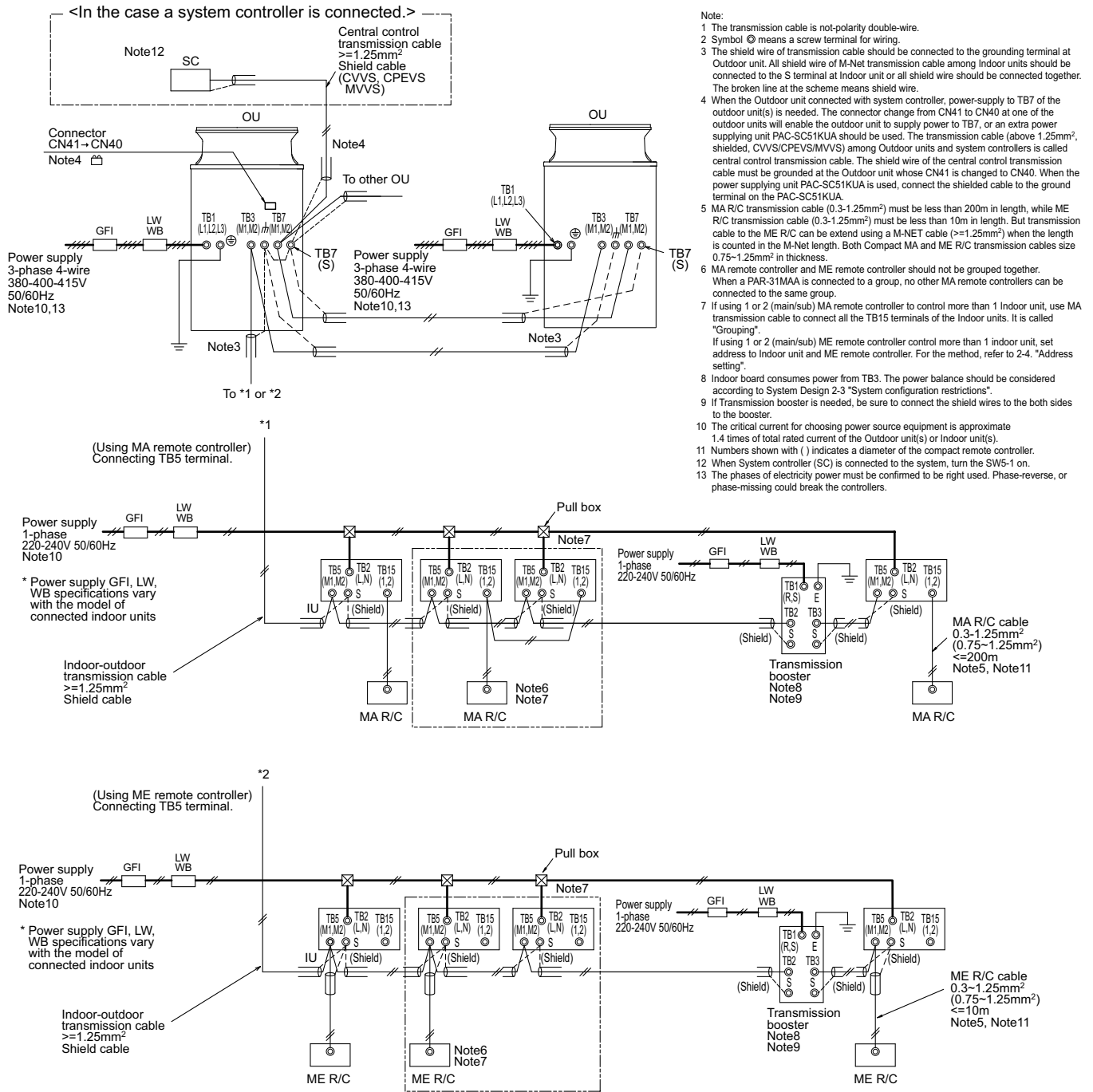

- Note:
- The transmission cable is not-polarity double-wire.
 - Symbol Ⓞ means a screw terminal for wiring.
 - The shield wire of transmission cable should be connected to the grounding terminal at Outdoor unit. All shield wire of M-Net transmission cable among Indoor units should be connected to the S terminal at Indoor unit or all shield wire should be connected together. The broken line at the scheme means shield wire.
 - When the Outdoor unit connected with system controller, power-supply to TB7 of the outdoor unit(s) is needed. The connector change from CN41 to CN40 at one of the outdoor units will enable the outdoor unit to supply power to TB7, or an extra power supplying unit PAC-SC51KUA should be used. The transmission cable (above 1.25mm², shielded, CVVS/CPEVS/MVVS) among Outdoor units and system controllers is called central control transmission cable. The shield wire of the central control transmission cable must be grounded at the Outdoor unit whose CN41 is changed to CN40. When the power supplying unit PAC-SC51KUA is used, connect the shielded cable to the ground terminal on the PAC-SC51KUA.
 - MA R/C transmission cable (0.3-1.25mm²) must be less than 200m in length, while ME R/C transmission cable (0.3-1.25mm²) must be less than 10m in length. But transmission cable to the ME R/C can be extend using a M-NET cable (>=1.25mm²) when the length is counted in the M-Net length. Both Compact MA and ME R/C transmission cables size 0.75-1.25mm² in thickness.
 - MA remote controller and ME remote controller should not be grouped together. When a PAR-31MAA is connected to a group, no other MA remote controllers can be connected to the same group.
 - If using 1 or 2 (main/sub) MA remote controller to control more than 1 Indoor unit, use MA transmission cable to connect all the TB15 terminals of the Indoor units. It is called "Grouping". If using 1 or 2 (main/sub) ME remote controller control more than 1 indoor unit, set address to Indoor unit and ME remote controller. For the method, refer to 2-4. "Address setting".
 - Indoor board consumes power from TB3. The power balance should be considered according to System Design 2-3 "System configuration restrictions".
 - If Transmission booster is needed, be sure to connect the shield wires to the both sides to the booster.
 - The critical current for choosing power source equipment is approximate 1.4 times of total rated current of the Outdoor unit(s) or Indoor unit(s).
 - Numbers shown with () indicates a diameter of the compact remote controller.
 - When System controller (SC) is connected to the system, turn the SW5-1 on.
 - The phases of electricity power must be confirmed to be right used. Phase-reverse, or phase-missing could break the controllers.

Symbol	Model	Ground-fault interrupter *1, *2, *4	Local switch			Wiring breaker*4 (NFB) <A>	Minimum Wire thickness	
			BKC <A>	OCP*3, *4 <A>	Power wire <mm ² >		Earth wire <mm ² >	
GFI	Ground-fault interrupter	PUHY-EP200YLM	30A 100mA 0.1sec. or less	25	25	30	4	4
LW	Local switch	PUHY-EP250YLM	30A 100mA 0.1sec. or less	32	32	30	4	4
BKC	Breaker capacity	PUHY-EP300YLM	30A 100mA 0.1sec. or less	32	32	30	4	4
OCP	Over-current protector	PUHY-EP350YLM	40A 100mA 0.1sec. or less	40	40	40	6	6
WB	Wiring breaker	PUHY-EP400YLM	60A 100mA 0.1sec. or less	63	63	60	10	10
NFB	Non-fuse breaker	PUHY-EP450YLM	60A 100mA 0.1sec. or less	63	63	60	10	10

*1 The Ground-fault interrupter should support Inverter circuit. (e.g. Mitsubishi Electric's NV-S series or equivalent).
 *2 Ground-fault interrupter should combine using of local switch or wiring breaker.
 *3 It shows data for B-type fuse of the breaker for current leakage.
 *4 If a large electric current flows due to malfunction or faulty wiring, earth-leakage breakers on the unit side and on the centralized controller side may both operate.
 Depending on the importance of the system, separate the power supply system or take protective coordination of breakers.

The local standards and/or regulations is applicable at a higher priority.
 1-4-6. PUHY-EP650, 700, 750, 800, 850, 900, 950,
 1000, 1050, 1100, 1150, 1200, 1250, 1300, 1350YSLM-A

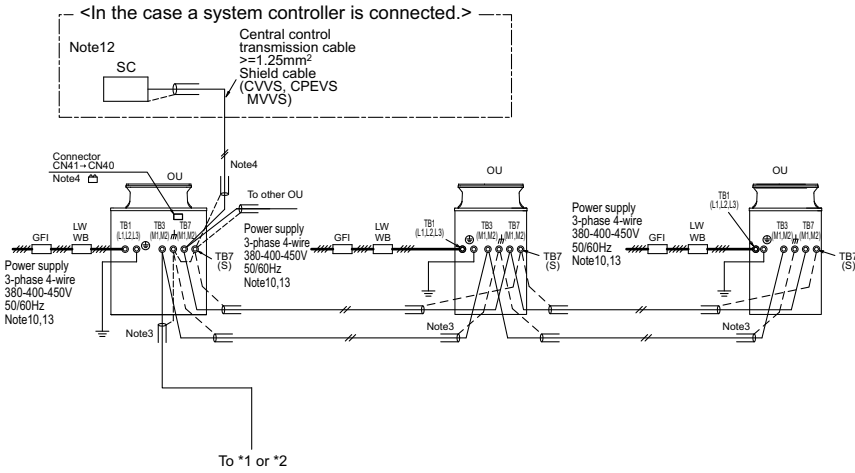

- Note:
- The transmission cable is not-polarity double-wire.
 - Symbol Ⓞ means a screw terminal for wiring.
 - The shield wire of transmission cable should be connected to the grounding terminal at Outdoor unit. All shield wire of M-Net transmission cable among Indoor units should be connected to the S terminal at Indoor unit or all shield wire should be connected together. The broken line at the scheme means shield wire.
 - When the Outdoor unit connected with system controller, power-supply to TB7 of the outdoor unit(s) is needed. The connector change from CN41 to CN40 at one of the outdoor units will enable the outdoor unit to supply power to TB7, or an extra power supplying unit PAC-SC51KUA should be used. The transmission cable (above 1.25mm², shielded, CVVS/CPEVS/MVVS) among Outdoor units and system controllers is called central control transmission cable. The shield wire of the central control transmission cable must be grounded at the Outdoor unit whose CN41 is changed to CN40. When the power supplying unit PAC-SC51KUA is used, connect the shielded cable to the ground terminal on the PAC-SC51KUA.
 - MA R/C transmission cable (0.3-1.25mm²) must be less than 10m in length. But transmission cable to the ME R/C can be extended using a M-NET cable (>=1.25mm²) when the length is counted in the M-Net length. Both Compact MA and ME R/C transmission cables size 0.75-1.25mm² in thickness.
 - MA remote controller and ME remote controller should not be grouped together. When a PAR-31MAA is connected to a group, no other MA remote controllers can be connected to the same group.
 - If using 1 or 2 (main/sub) MA remote controller to control more than 1 Indoor unit, use MA transmission cable to connect all the TB15 terminals of the Indoor units. It is called "Grouping". If using 1 or 2 (main/sub) ME remote controller control more than 1 indoor unit, set address to Indoor unit and ME remote controller. For the method, refer to 2-4. "Address setting".
 - Indoor board consumes power from TB3. The power balance should be considered according to System Design 2-3 "System configuration restrictions".
 - If Transmission booster is needed, be sure to connect the shield wires to the both sides to the booster.
 - The critical current for choosing power source equipment is approximate 1.4 times of total rated current of the Outdoor unit(s) or Indoor unit(s).
 - Numbers shown with () indicates a diameter of the compact remote controller.
 - When System controller (SC) is connected to the system, turn the SW5-1 on.
 - The phases of electricity power must be confirmed to be right used. Phase-reverse, or phase-missing could break the controllers.

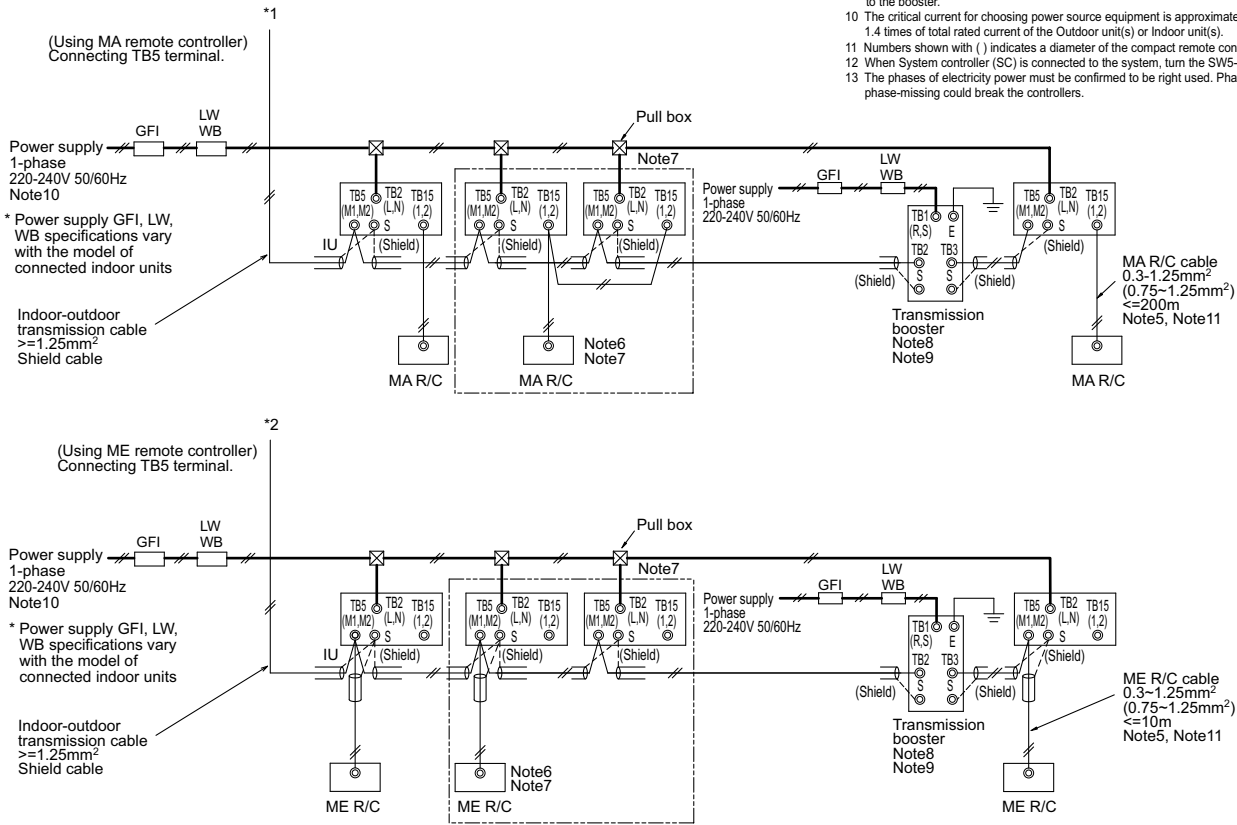

Symbol	Model	Ground-fault interrupter *1, *2, *4	Local switch		Wiring breaker*4 (NFB) <A>	Minimum Wire thickness		
			BKC <A>	OCP*3, *4 <A>		Power wire <mm²>	Earth wire <mm²>	
GFI	Ground-fault interrupter	PUHY-EP200YLM	30A 100mA 0.1sec. or less	25	25	30	4	4
LW	Local switch	PUHY-EP250YLM	30A 100mA 0.1sec. or less	32	32	30	4	4
BKC	Breaker capacity	PUHY-EP300YLM	30A 100mA 0.1sec. or less	32	32	30	4	4
OCP	Over-current protector	PUHY-EP350YLM	40A 100mA 0.1sec. or less	40	40	40	6	6
WB	Wiring breaker	PUHY-EP400YLM	60A 100mA 0.1sec. or less	63	63	60	10	10
NFB	Non-fuse breaker	PUHY-EP450YLM	60A 100mA 0.1sec. or less	63	63	60	10	10

*1 The Ground-fault interrupter should support Inverter circuit. (e.g. Mitsubishi Electric's NV-S series or equivalent).

*2 Ground-fault interrupter should combine using of local switch or wiring breaker.

*3 It shows data for B-type fuse of the breaker for current leakage.

*4 If a large electric current flows due to malfunction or faulty wiring, earth-leakage breakers on the unit side and on the centralized controller side may both operate.

Depending on the importance of the system, separate the power supply system or take protective coordination of breakers.

2-1. Transmission cable length limitation

2-1-1. Using MA Remote controller

Long transmission cable causes voltage down, therefore, the length limitation should be obeyed to secure proper transmission.

Max. length via Outdoor (M-NET cable)	$L1+L2+L3+L4, L1+L2+L6+L7, L3+L4+L6+L7$	$\leq 500m[1640ft.]$	1.25mm ² [AWG16] or thicker
Max. length to Outdoor (M-NET cable)	$L1+L8, L3+L4, L6, L2+L6+L8, L7$	$\leq 200m[656ft.]$	1.25mm ² [AWG16] or thicker
Max. length from MA to Indoor	$a1+a2, a1+a2+a3+a4$	$\leq 200m[656ft.]$	0.3-1.25 mm ² [AWG22-16]
24VDC to AG-150A	n	$\leq 50m[164ft.]$	0.75-2.0 mm ² [AWG18-14]

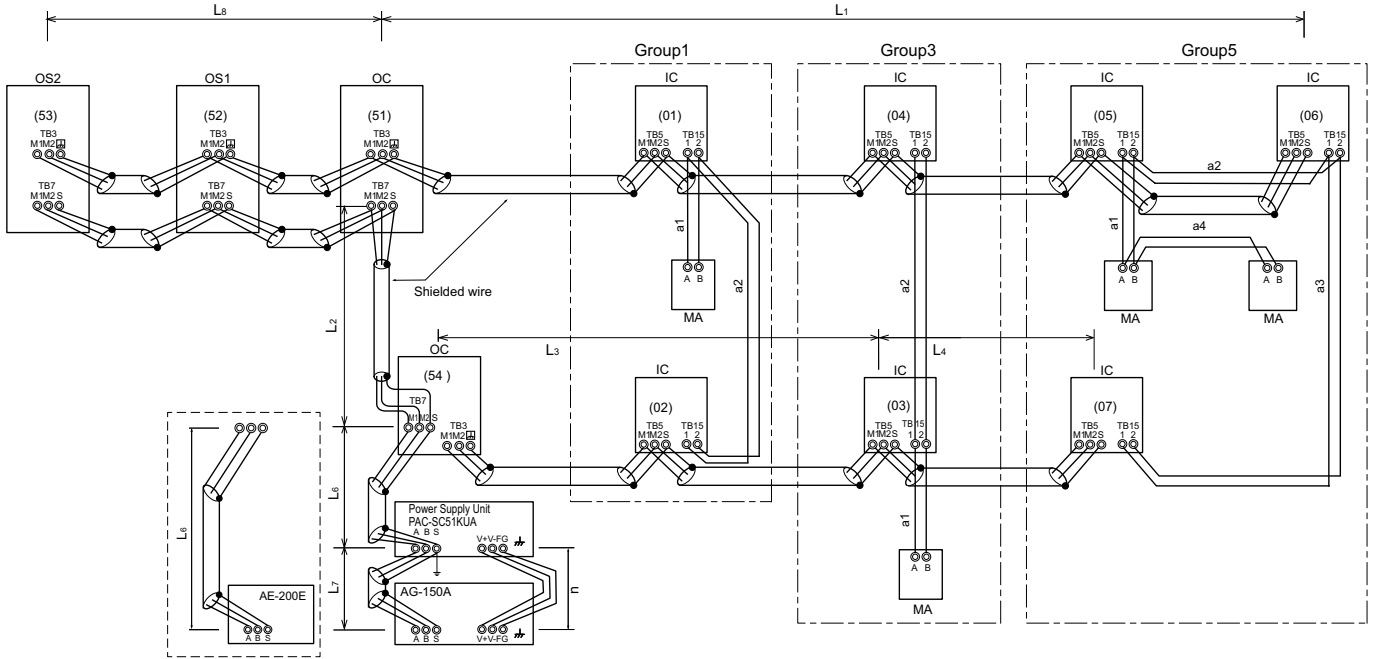

OC, OS1, OS2 : Outdoor unit controller; IC: Indoor unit controller; MA: MA remote controller

2-1-2. Using ME Remote controller

Long transmission cable causes voltage down, therefore, the length limitation should be obeyed to secure proper transmission.

Max. length via Outdoor (M-NET cable)	$L1+L2+L3+L4, L1+L2+L6+L7, L1+L2+L3+L5, L3+L4+L6+L7$	$\leq 500m[1640ft.]$	1.25mm ² [AWG16] or thicker
Max. length to Outdoor (M-NET cable)	$L1+L8, L3+L4, L6, L2+L6+L8, L7, L3+L5$	$\leq 200m[656ft.]$	1.25mm ² [AWG16] or thicker
Max. length from ME to Indoor	$e1, e2+e3, e4$	$\leq 10m[32ft.]*1$	0.3-1.25 mm ² [AWG22-16] *1
24VDC to AG-150A	n	$\leq 50m[164ft.]$	0.75-2.0 mm ² [AWG18-14]

*1. If the length from ME to Indoor exceed 10m, use 1.25 mm² [AWG16] shielded cable, but the total length should be counted into Max. length via Outdoor.

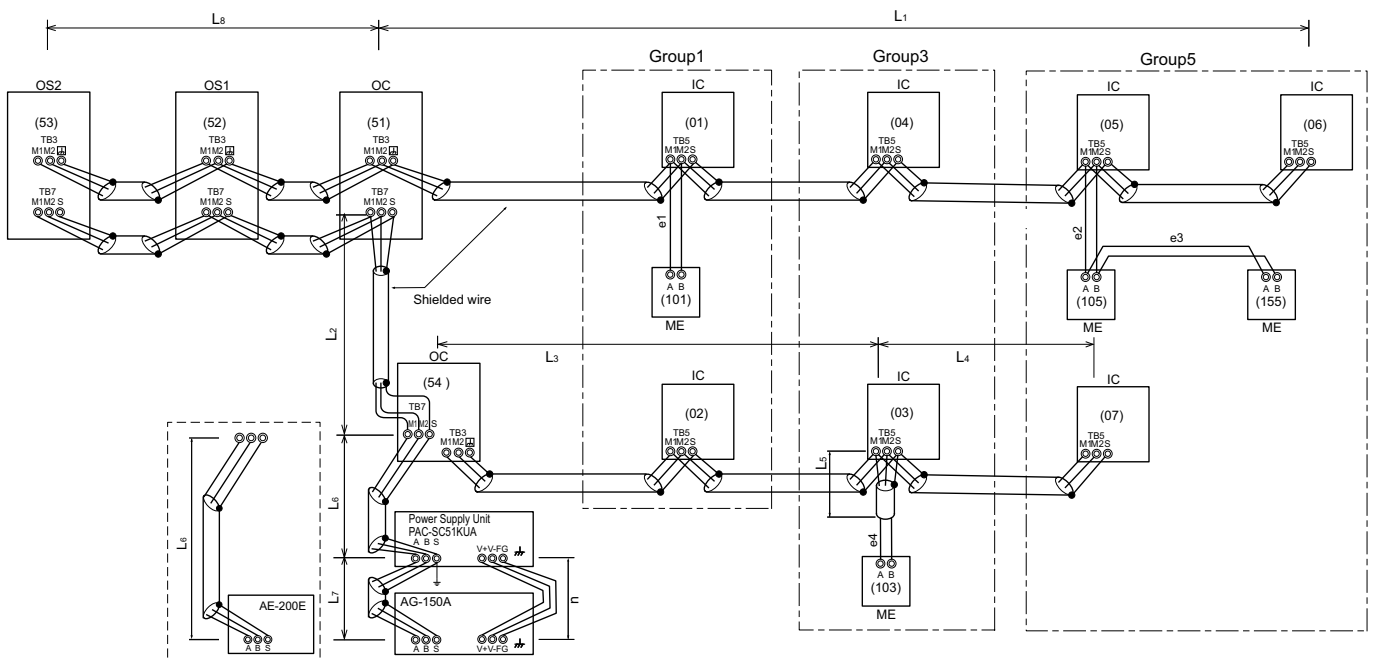

OC, OS1, OS2: Outdoor unit controller; IC: Indoor unit controller; ME: ME remote controller

2-2. Transmission cable specifications

	Transmission cables (Li)	M-NET remote controller cables	MA Remote controller cables
Type of cable	Shielding wire (2-core) CVVS, CPEVS or MVVS	Sheathed 2-core cable (unshielded) CVV	
Cable size	More than 1.25 mm ² [AWG16]	0.3 ~ 1.25 mm ² [AWG22~16] (0.75 ~ 1.25 mm ² [AWG18~16])*1	0.3 ~ 1.25 mm ² [AWG22 ~16] *2
Remarks	Max length: within 200 m	When 10 m [32ft] is exceeded, use cables with the same specification as transmission cables.	Max length: 200 m [656ft] *3

*1 Connected with PZ-52SF.

*2 To wire PAR-31MAA(E), Simple MA remote controller use a wire with a diameter of 0.3 mm² [AWG22]

*3 When a PAR-31MAA(E) and other MA remote controllers are connected in the same group, the maximum length of cable should be 100 m.

CVVS, MVVS: PVC insulated PVC jacketed shielded control cable
CPEVS: PE insulated PVC jacketed shielded communication cable
CVV: PV insulated PVC sheathed control cable

2-3. System configuration restrictions

2-3-1. Common restrictions for the CITYMULTI system

For each Outdoor unit, the maximum connectable quantity of Indoor unit is specified at its Specifications table.

- A) 1 Group of Indoor units can have 1-16 Indoor units;
*OA processing unit GUF-RD(H) is considered as Indoor unit.
- B) Maximum 2 remote controllers for 1 Group;
*MA/ME remote controllers cannot be present together in 1group.
*When a PAR-31MAA(E) is connected to a group, no other MA remote controllers can be connected to the same group.
- C) 1 LOSSNAY unit can interlock maximum 16 Indoor units; 1 Indoor unit can interlock only 1 LOSSNAY unit.
- D) Maximum 3 System controllers are connectable when connecting to TB3 of the Outdoor unit.
- E) Maximum 6 System controllers are connectable when connecting to TB7 of the Outdoor unit, if the transmission power is supplied by the Outdoor unit.
- F) 4 System controllers or more are connectable when connecting to TB7 of the Outdoor unit, if the transmission power is supplied by the power supply unit PAC-SC51KUA. Details refer to 2-3-3-C.
*System controller connected as described in D) and E) would have a risk that the failure of connected Outdoor unit would stop power supply to the System controller.

2-3-2. Ensuring proper communication power for M-NET

In order to ensure proper communication among Outdoor unit, Indoor unit, LOSSNAY, and OA processing unit GUF-RD(H), and Controllers, the transmission power situation for the M-NET should be observed. In some cases, Transmission booster should be used. Taking the power consumption of Indoor unit sized P15-P140 as 1, the equivalent power consumption or supply of others are listed at Table 2-3-1 and Table 2-3-2.

Table 2-3-1 The equivalent power consumption

Indoor, OA unit	Indoor unit	BC controller	PWFY			MARC. LOSSNAY	ME Remote Contr.		System Contr.			ON/OFF Contr.	MN Converter	Outdoor unit
Sized P15-P140 GUF-50, 100	Sized P200, P250	CMB	P100VM -E-BU	P100VM -E1-AU P100VM -E2-AU	P200VM -E1-AU P200VM -E2-AU	PAR-31MAA(E) PAC-YT52CRA PAR-FA32MA LGH-RVX-E PZ-61DR-E PZ-43SMF-E	PAC-YG60MCA PAC-YG66DCA PAC-YG63MCA	PAR-U02MEDA PAC-IF01AHC	AE-200E AE-50E	AG-150A EB-50GU-J	AT-50B	PAC -YT40ANRA	CMS-MNG-E	TB7 power consumption
1	7	2	6	1	5	0	1/4	1/2	0	1/2	4	1	2	0

*RC : Remote Controller

Table 2-3-2 The equivalent power supply

Transmission Booster	Power supply unit	Expansion controller	BM ADAPTER	System Controller		Outdoor unit	Outdoor unit
PAC-SF46EPA	PAC-SC51KUA	PAC-YG50ECA	BAC-HD150	AE-200E/AE-50E	GB-50ADA-J	Connector TB3 and TB7 total *	Connector TB7 only
25	5	6	6	0 ¹⁾	6	32	6

*If PAC-SC51KUA is used to supply power at TB7 side, no power supply need from Outdoor unit at TB7, Connector TB3 itself will therefore have 32. Not applicable to the PUMY model.

*1 AE-200E/AE-50E has a built-in function to supply power to the M-NET transmission line. The amount of power that an AE-200E or an AE-50E can supply is equivalent to the power required by an MN converter (CMS-MNG-E) that is used for maintenance.

With the equivalent power consumption values in Table 2-3-1 and Table 2-3-2, PAC-SF46EPA can be designed into the air-conditioner system to ensure proper system communication according to 2-3-2-A, B, C.

- 2-3-2-A) Firstly, count from TB3 at TB3 side the total quantity of Indoor units, OA processing units, ME remote controller, and System controllers. If the total quantity reaches 40, a PAC-SF46EPA should be set. In this case, Indoor units sized P200 and 250 are counted as 2 indoor units, but MA remote controller(s), PZ-61DR-E, and PZ-43SMF-E are NOT counted.
- 2-3-2-B) Secondly, count from TB7 side to TB3 side the total transmission power consumption. If the total power consumption reaches 32, a PAC-SF46EPA should be set. Yet, if a PAC-SC51KUA or another controller with a built-in power supply, such as PAC-YG50ECA, is used to supply power at TB7 side, count from TB3 side only.
- 2-3-2-C) Thirdly, count from TB7 at TB7 side the total transmission power consumption, If the total power consumption reaches 6, a PAC-SF46EPA should be set.

■ System example

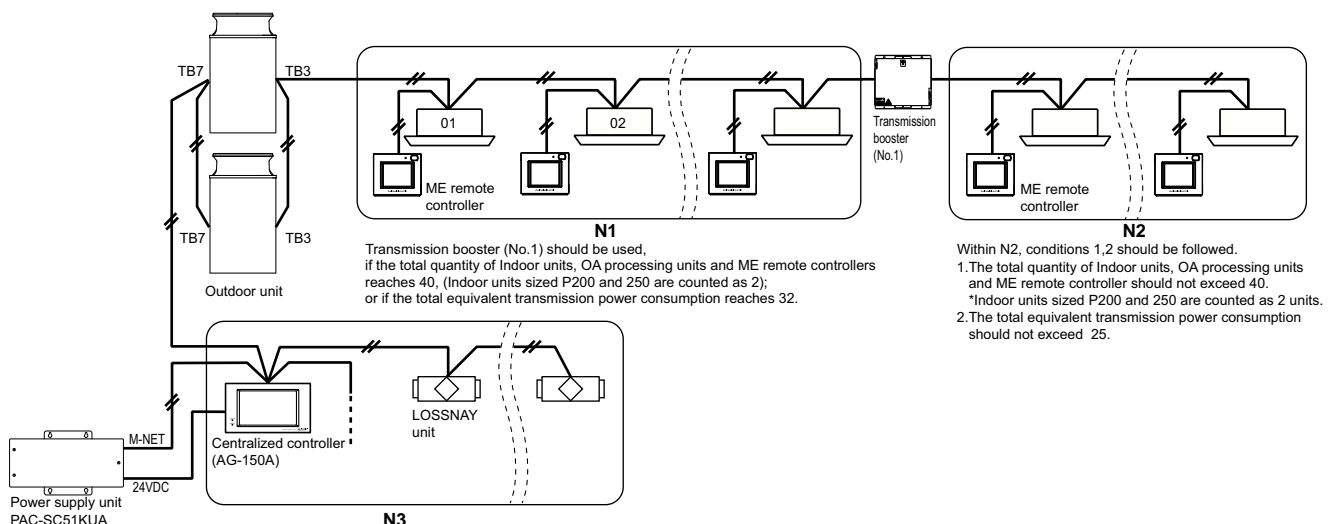

2-3-3. Ensuring proper power supply to System controller

The power to System controller (excluding AE-200E, AE-50E, BAC-HD150, LM-AP) is supplied via M-NET transmission line. M-NET transmission line at TB7 side is called Centralized control transmission line while one at TB3 side is called Indoor-Outdoor transmission line. There are 3 ways to supply power to the System controller .

- A) Connecting to TB3 of the Outdoor unit and receiving power from the Outdoor unit.
- B) Connecting to TB7 of the Outdoor unit and receiving power from the Outdoor unit.
- C) Connecting to TB7 of the Outdoor unit but receiving power from power supply unit PAC-SC51KUA.

* System controllers (AE-200E, AE-50E, BAC-HD150, LM-AP) have a built-in function to supply power to the M-NET transmission lines, so no power needs to be supplied to the M-NET transmission lines from the outdoor units or from PAC-SC51KUA.

2-3-3-A. When connecting to TB3 of the Outdoor unit and receiving power from the Outdoor unit.

Maximum 3 System controllers can be connected to TB3.
If there is more than 1 Outdoor unit, it is necessary to replace power supply switch connector CN41 with CN40 on one Outdoor unit.

Fig. 2-3-3-A

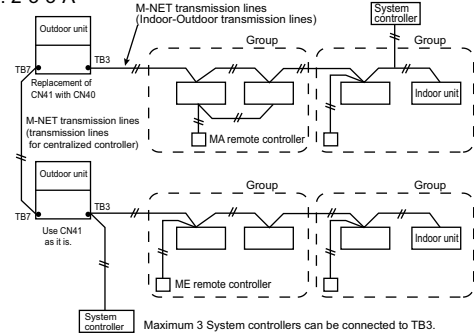

2-3-3-B. When connecting to TB7 of the Outdoor unit and receiving power from the Outdoor unit.

Maximum 6 System controllers can be connected to TB7 and receiving power from the Outdoor unit.
It is necessary to replace power supply switch connector CN41 with CN40 on one Outdoor unit.

Fig. 2-3-3-B

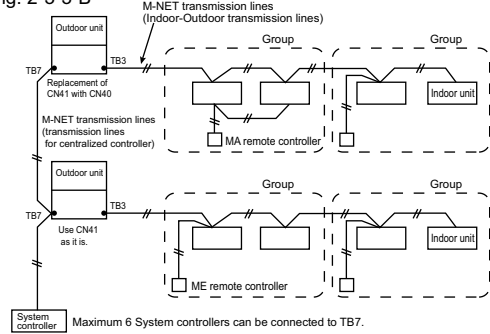

2-3-3-C. When connecting to TB7 of the Outdoor unit but receiving power from PAC-SC51KUA.

When using PAC-SC51KUA to supply transmission power, the power supply connector CN41 on the Outdoor units should be kept as it is. It is also a factory setting.
1 PAC-SC51KUA supports maximum 1 AG-150A unit due to the limited power 24VDC at its TB3.
However, 1 PAC-SC51KUA supplies transmission power at its TB2 equal to 5 Indoor units, which is referable at Table 2-3-2.
If PZ-52SF-E, System controller, ON/OFF controller connected to TB7 consume transmission power more than 5 (Indoor units), Transmission booster PAC-SF46EPA is needed. PAC-SF46EPA supplies transmission power equal to 25 Indoor units.

Fig. 2-3-3-C

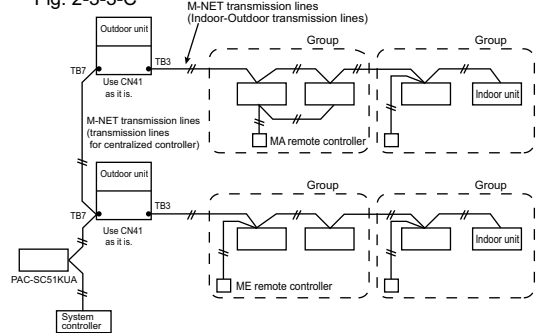

CAUTION

- AG-150A*1 is recommended to connect to TB7 because it performs back-up to a number of data. In an air conditioner system has more than 1 Outdoor units, AG-150A receiving transmission power through TB7 on one of the Outdoor units would have a risk that the connected Outdoor unit failure would stop power supply to AG-150A, and disrupt the whole system. When applying apportioned electric power function, AG-150A is necessary to be connected to TB7 and has its own power supply unit PAC-SC51KUA.*2
*1: AG-150A is an example model of system controllers.
*2: Power supply unit PAC-SC51KUA is for AG-150A.

- How to connect system controllers (AE-200E, AE-50E, BAC-HD150, LM-AP) to a given system
System controllers (AE-200E, AE-50E, BAC-HD150, LM-AP) have a built-in function to supply power to the M-NET transmission lines, so no power needs to be supplied to the M-NET transmission lines from the outdoor units or from PAC-SC51KUA.
Leave the power supply connector on the outdoor unit connected to CN41 as it is. Refer to 2-3-2 for information about the power-supply capacity of each system controller (AE-200E, AE-50E, BAC-HD150, LM-AP) to the low-level system controllers.

Fig. 2-3-3-D

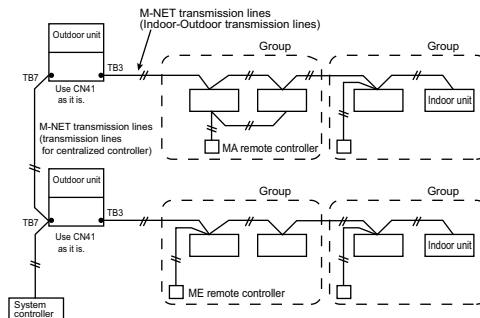

2-3-4. Power supply to LM-AP

1-phase 220-240VAC power supply is needed.

The power supply unit PAC-SC51KUA is not necessary when connecting only the LM-AP. Yet, make sure to change the power supply changeover connector CN41 to CN40 on the LM-AP.

2-3-5. Power supply to expansion controller

1-phase 100-240VAC power supply is needed.

The power supply unit PAC-SC51KUA is not necessary.

The expansion controller supplies power through TB3, which equals 6 indoor units. (refer to Table 2-3-2)

2-3-6. Power supply to BM ADAPTER

1-phase 100-240VAC power supply is needed.

The power supply unit PAC-SC51KUA is not necessary when only BM ADAPTER is connected.

Yet, make sure to move the power jumper from CN41 to CN40 on the BM ADAPTER.

2-3-7. Power supply to GB-50ADA-J

1-phase 100-240VAC power supply is needed.

The power supply unit PAC-SC51KUA is not necessary.

GB-50ADA-J supplies power through TB3, which equals 6 indoor units. (refer to Table 2-3-2)

2-3-8. Power supply to AE-200E/AE-50E

1-phase 100-240VAC power supply is needed.

The power supply unit PAC-SC51KUA is not necessary when connecting only the AE-200E/AE-50E.

2-4. Address setting

2-4-1. Switch operation

In order to constitute CITY MULTI in a complete system, switch operation for setting the unit address No. and connection No. is required.

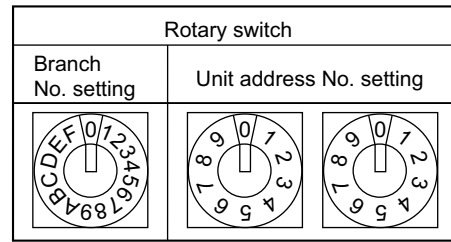

- ① Address No. of outdoor unit, indoor unit and remote controller.
The address No. is set at the address setting board.
In the case of R2 system, it is necessary to set the same No. at the branch No. switch of indoor unit as that of the BC controller connected. (When connecting two or more branches, use the lowest branch No.)

② Caution for switch operations

- Be sure to shut off power source before switch setting. If operated with power source on, switch can not operate properly.
- No units with identical unit address shall exist in one whole air conditioner system. If set erroneously, the system can not operate.

③ MA remote controller

- When connecting only one remote controller to one group, it is always the main remote controller.
When connecting two remote controllers to one group, set one remote controller as the main remote controller and the other as the sub remote controller.
- The factory setting is "Main".

PAR-31MAA(E)

The MA remote controller does not have the switches listed above.
Refer to the installation manual for the function setting.

















PAC-YT52CRA

Setting the dip switches

There are switches on the back of the top case. Remote controller Main/Sub and other function settings are performed using these switches. Ordinarily, only change the Main/Sub setting of SW1.
(The factory settings are ON for SW1, 2, and 3 and OFF for SW4.)

SW No.	SW contents Main	ON	OFF	Comment
1	Remote controller Main/Sub setting	Main	Sub	Set one of the two remote controllers at one group to "ON".
2	Temperature display units setting	Celsius	Fahrenheit	When the temperature is displayed in [Fahrenheit], set to "OFF".
3	Cooling/heating display in AUTO mode	Yes	No	When you do not want to display "Cooling" and "Heating" in the AUTO mode, set to "OFF".
4	Indoor temperature display	Yes	No	When you want to display the indoor temperature, set to "ON".

2-4-2. Rule of setting address

Unit	Address setting	Example	Note							
Indoor unit	01 ~ 50	 	Use the most recent address within the same group of indoor units. Make the indoor units address connected to the BC controller (Sub) larger than the indoor units address connected to the BC controller (Main). If applicable, set the sub BC controllers in an PURY system in the following order: (1) Indoor unit to be connected to the BC controller (Main) (2) Indoor unit to be connected to the BC controller (No.1 Sub) (3) Indoor unit to be connected to the BC controller (No.2 Sub) Set the address so that (1)<(2)<(3)							
Outdoor unit	51 ~ 99, 100 (Note1)	 	The smallest address of indoor unit in same refrigerant system + 50 Assign sequential address numbers to the outdoor units in one refrigerant circuit system. OC, OS1 and OS2 are automatically detected. (Note 2) * Please reset one of them to an address between 51 and 99 when two addresses overlap. * The address automatically becomes "100" if it is set as "01~ 50"							
BC controller (Main)	52 ~ 99, 100	 	The address of outdoor unit + 1 * Please reset one of them to an address between 51 and 99 when two addresses overlap. * The address automatically becomes "100" if it is set as "01~ 50"							
BC controller (Sub)	52 ~ 99, 100	 	Lowest address within the indoor units connected to the BC controller (Sub) plus 50.							
Local remote controller	ME Remote controller (Main)	101 ~ 150	1 Fixed  	The smallest address of indoor unit in the group + 100 *The place of "100" is fixed to "1"						
	ME Remote controller (Sub)	151 ~ 199, 200	1 Fixed  	The address of main remote controller + 50 *The address automatically becomes "200" if it is set as "00"						
System controller	ON/OFF remote controller	000, 201 ~ 250	  	The smallest group No. to be managed + 200 * The smallest group No. to be managed is changeable.						
	AE-200E/AE-50E AG-150A GB-50ADA-J AT-50B EB-50GU-J	000, 201 ~ 250	<table border="1" data-bbox="635 1379 876 1469"> <tr> <td>0,2</td> <td>0~5</td> <td>0~9</td> </tr> <tr> <td>100</td> <td>10</td> <td>1</td> </tr> </table>	0,2	0~5	0~9	100	10	1	
	0,2	0~5	0~9							
	100	10	1							
	PAC-YG50ECA	000, 201 ~ 250	<table border="1" data-bbox="635 1491 876 1581"> <tr> <td>0,2</td> <td>0~5</td> <td>0~9</td> </tr> <tr> <td>100</td> <td>10</td> <td>1</td> </tr> </table>	0,2	0~5	0~9	100	10	1	* Settings are made on the initial screen of AG-150A.
0,2	0~5	0~9								
100	10	1								
BAC-HD150	000, 201 ~ 250	<table border="1" data-bbox="635 1603 876 1693"> <tr> <td>0,2</td> <td>0~5</td> <td>0~9</td> </tr> <tr> <td>100</td> <td>10</td> <td>1</td> </tr> </table>	0,2	0~5	0~9	100	10	1	* Settings are made with setting tool of BM ADAPTER.	
0,2	0~5	0~9								
100	10	1								
LMAP04-E	201 ~ 250	2 Fixed  								

Note1: To set the address to "100", set it to "50"

Note2: Outdoor units OC, OS1 and OS2 in one refrigerant circuit system are automatically detected.

OC, OS1 and OS2 are ranked in descending order of capacity. If units are the same capacity, they are ranked in ascending order of their address.

2-4-3. System examples

Factory setting

Original switch setting of the outdoors, indoors, controllers, LM-AP and BM ADAPTER at shipment is as follows.

- Outdoor unit : Address: 00, CN41: ON (Jumper), DipSW5-1: OFF
- Indoor unit : Address: 00
- ME remote controller : Address: 101
- LM-AP : Address: 247, CN41: ON (Jumper), DipSW1-2: OFF
- BM ADAPTER : Address: 000, CN41: ON (Jumper)
- AE-200E/AE-50E : Address: 000, CN21: ON (Jumper)

Setting at the site

- DipSW5-1(Outdoor) : When the System Controller is used, all the Dip SW5-1 at the outdoor units should be set to "ON". * Dip SW5-1 remains OFF when only LM-AP is used.
- DipSW1-2(LM-AP) : When the LM-AP is used together with System Controller, DipSW1-2 at the LM-AP should be set to "ON".
- CN40/CN41 : Change jumper from CN41 to CN 40 at outdoor control board will activate central transmission power supply to TB7;
(Change jumper at only one outdoor unit when activating the transmission power supply without using a power supply unit.)
Change jumper from CN41 to CN 40 at LM-AP/BM ADAPTER will activate transmission power supply to LM-AP/BM ADAPTER itself;
Power supply unit is recommended to use for a system having more than 1 outdoor unit, because the central transmission power supply from TB7 of one of outdoor units is risking that the outdoor unit failure may let down the whole system controller system.
- CN21(AE-200E/AE-50E) : Activates the power supply to M-NET transmission line from AE-200E/AE-50E (CN21: ON (power supplied), OFF (power not supplied))

2-4-3-1. MA remote controller, Single-refrigerant-system, No System Controller

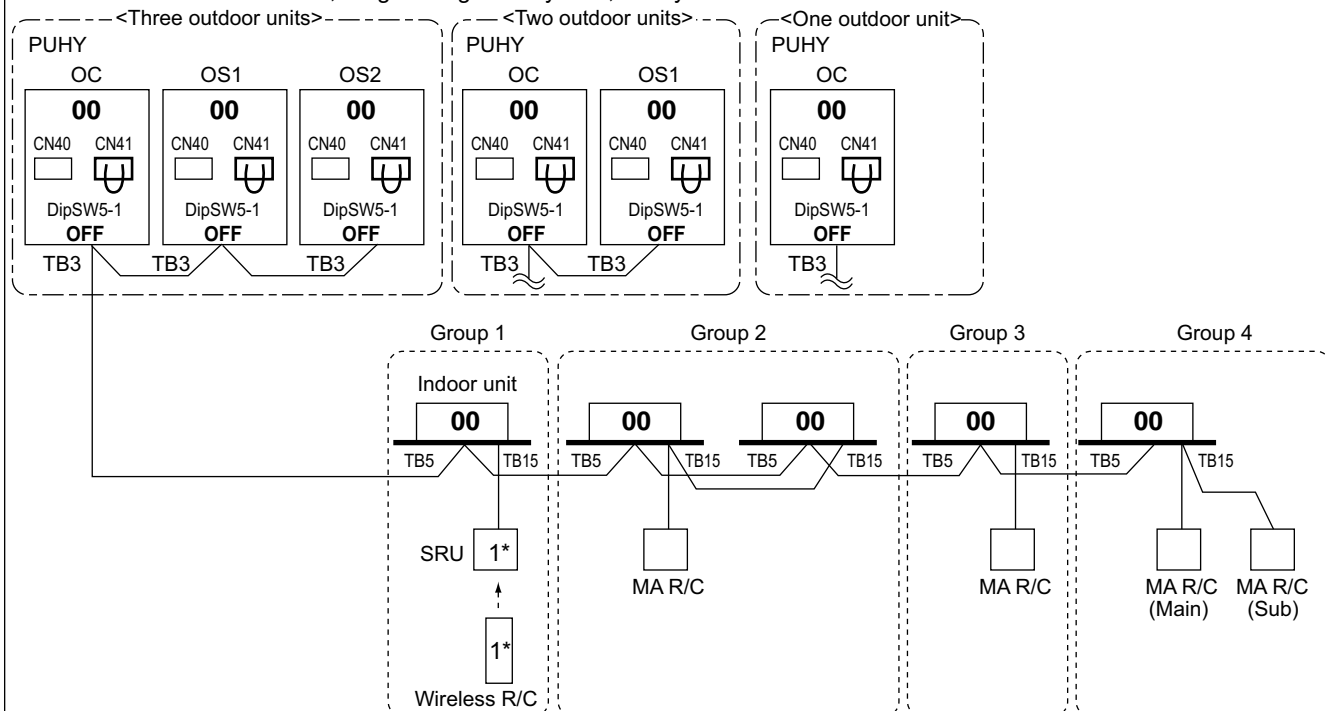

*1 For Wireless R/C and Signal receiver unit (SRU), channel 1, 2 and 3 are selectable and should be set to same channel.

NOTE:

1. Outdoor units OC, OS1 and OS2 in one refrigerant circuit system are automatically detected. OC, OS1 and OS2 are ranked in descending order of capacity. If units are the same capacity, they are ranked in ascending order of their address.
2. No address setting is needed.
3. For a system having more than 32 indoor unit (P15-P140), confirm the need of Booster at 2-3 "System configuration restrictions".
4. When a PAR-31MAA(E) is connected to a group, no other MA remote controllers can be connected to the same group.

2-4-3-2. MA remote controller, Single-refrigerant-system, System Controller

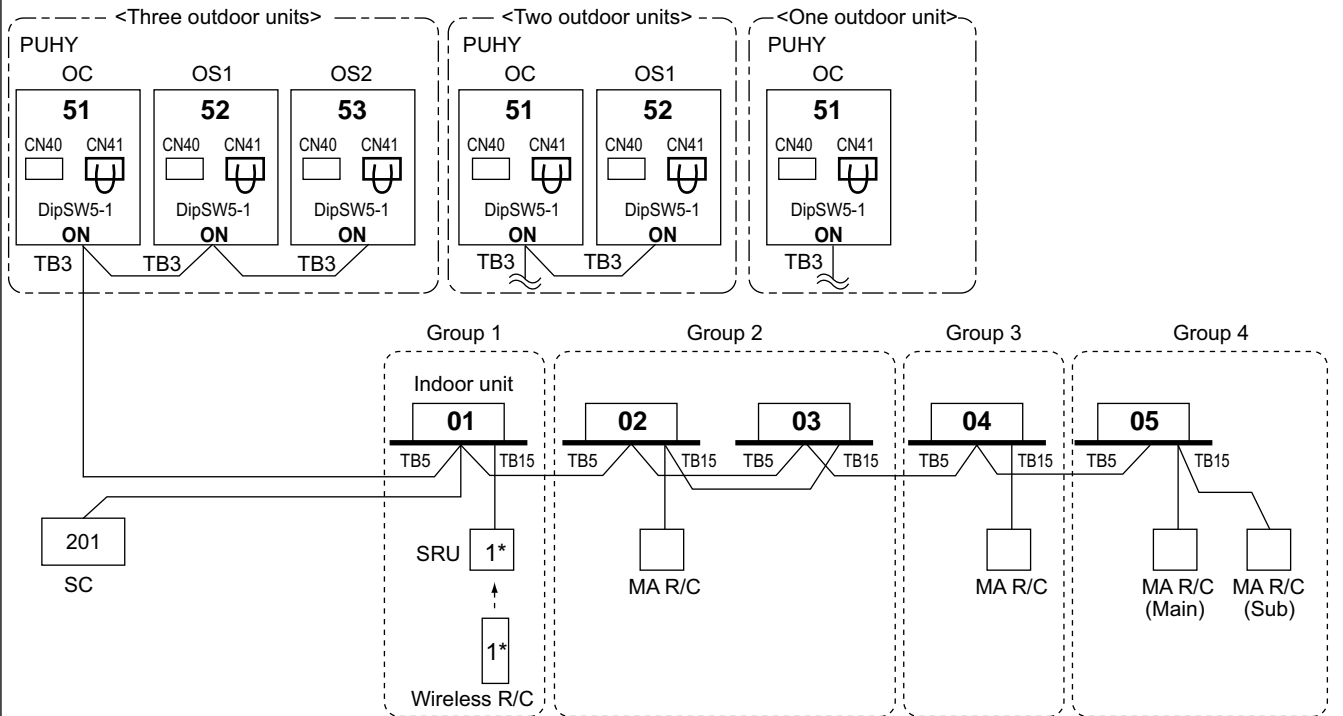

*1 For Wireless R/C and Signal receiver unit (SRU), channel 1, 2 and 3 are selectable and should be set to same channel.

*SC can be connected to TB3 side or TB7 side;

Should SC connected to TB7 side, change Jumper from CN41 to CN40 at the Outdoor unit module so as to supply power to the SC.

NOTE:

1. Outdoor units OC, OS1 and OS2 in one refrigerant circuit system are automatically detected.
OC, OS1 and OS2 are ranked in descending order of capacity. If units are the same capacity, they are ranked in ascending order of their address.
2. Address should be set to Indoor units and centralized controller.
3. For a system having more than 32 indoor unit (P15-P140), confirm the need of Booster at 2-3 "System configuration restrictions".
4. When a PAR-31MAA(E) is connected to a group, no other MA remote controllers can be connected to the same group.

2-4-3-3. MA remote controller, Multi-refrigerant-system, System Controller at TB7/TB3 side, Booster for long M-NET wiring

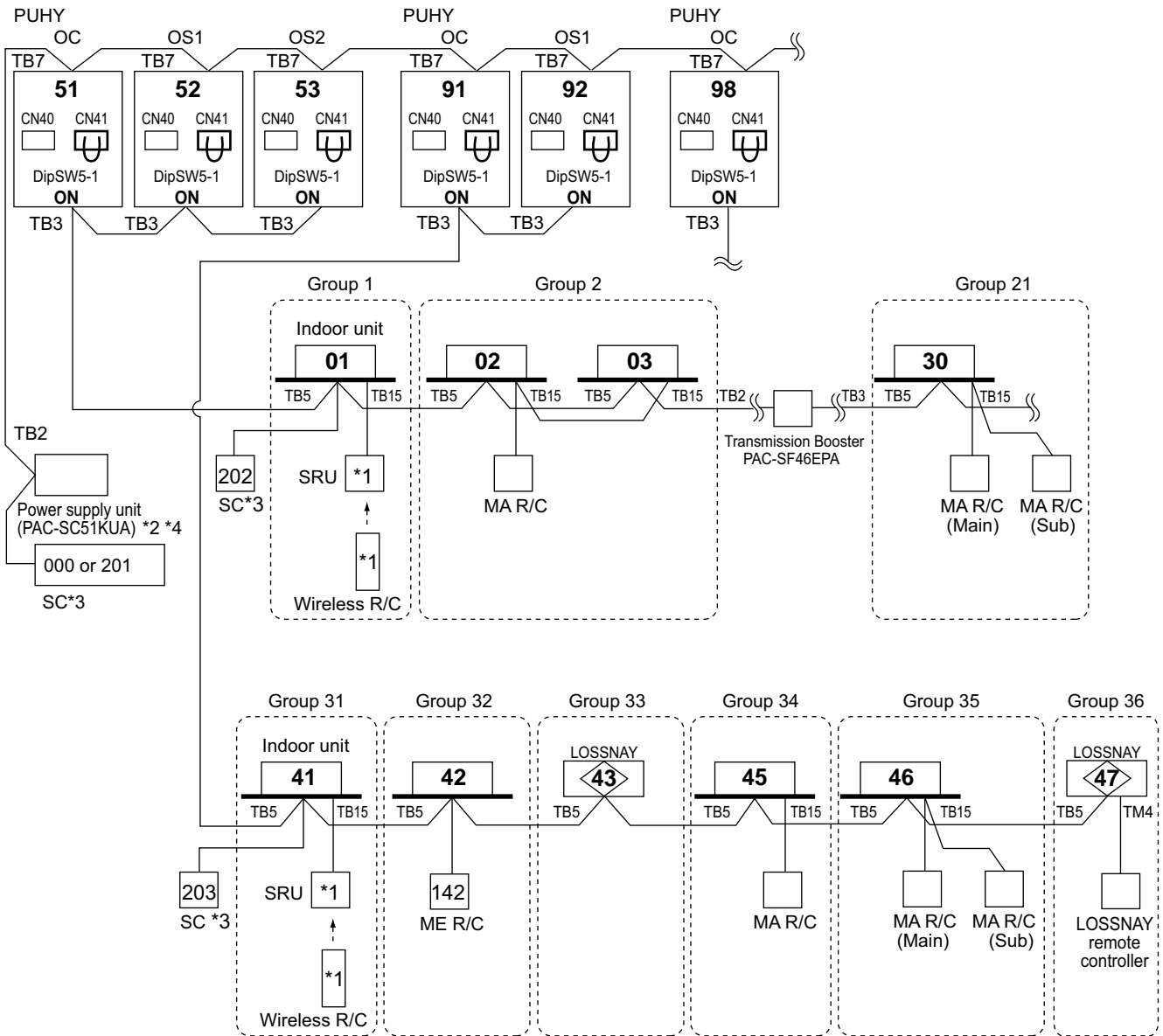

*1 For Wireless R/C and Signal receiver unit (SRU), channel 1, 2 and 3 are selectable and should be set to same channel.
 *2 System controller should connect to TB7 at Outdoor and use power supply unit together in Multi-Refrigerant-System.
 For AG-150A, 24V DC should be used with the PAC-SC51KUA. For AE-200E/AE-50E, the power supply unit PAC-SC51KUA is unused.
 *3 When multiple system controllers are connected in the system, set the controller with more functions than others as a "main" controller and others as "sub".
 AE-200E and GB-50ADA-J are for exclusive use as a "main" system controller and cannot be used as a "sub" system controller.
 Make the setting to only one of the system controllers for "prohibition of operation from local remote controller".
 *4 The power supply unit is not necessary for AE-200E, AE-50E, BAC-HD150, and LM-AP.

NOTE:

1. Outdoor units OC, OS1 and OS2 in one refrigerant circuit system are automatically detected.
 OC, OS1 and OS2 are ranked in descending order of capacity. If units are the same capacity, they are ranked in ascending order of their address.
2. Address should be set to Indoor units, LOSSNAY and system controller.
3. M-NET power is supplied by the Outdoor unit at TB3, while Indoor unit and ME remote controller consume the M-NET power for transmission use. The power balance is needed to consider for long M-NET wiring. Details refer to 2-3 "System configuration restrictions".
4. When a PAR-31MAA(E) is connected to a group, no other MA remote controllers can be connected to the same group.

2-4-3-4. ME remote controller, Single-refrigerant-system, No system controller

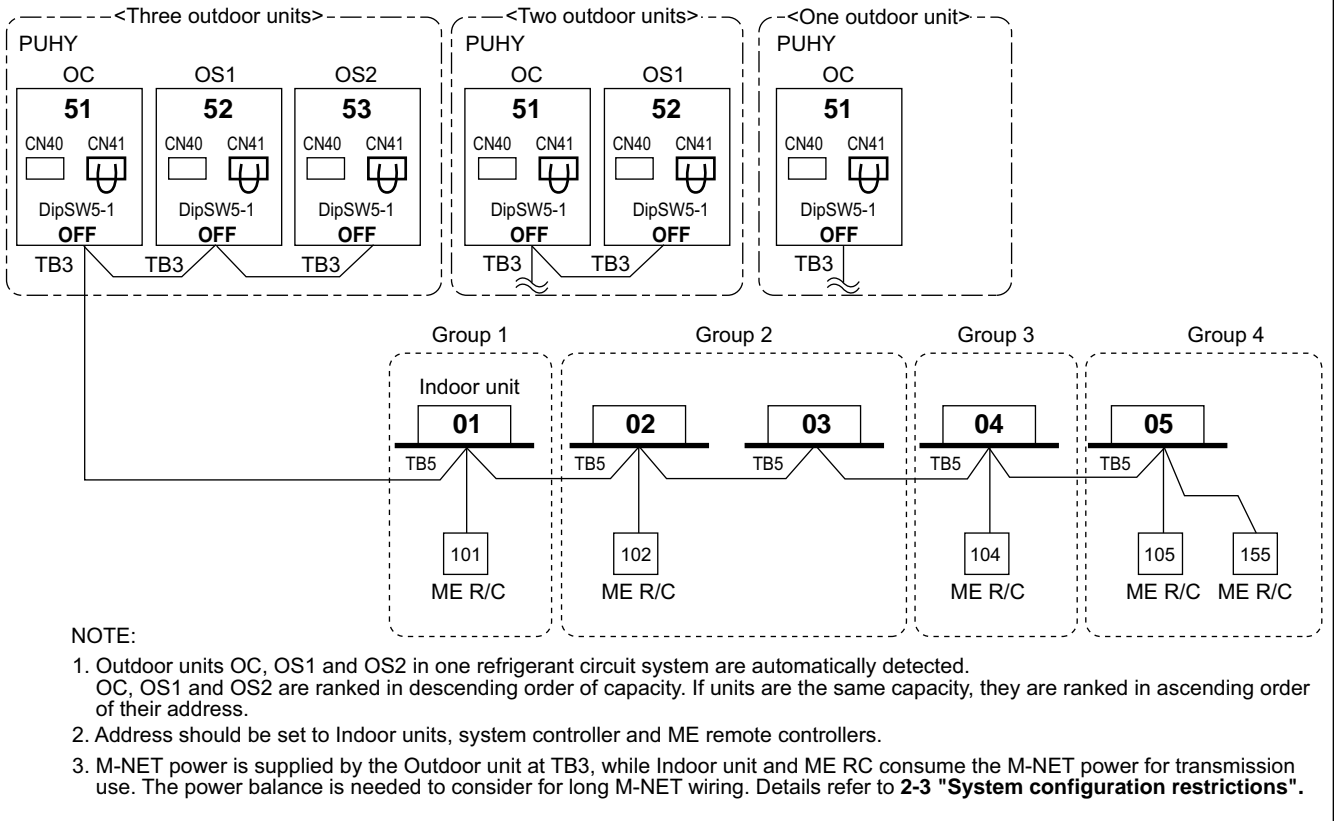

2-4-3-5. ME remote controller, Single-refrigerant-system, System controller, LOSSNAY

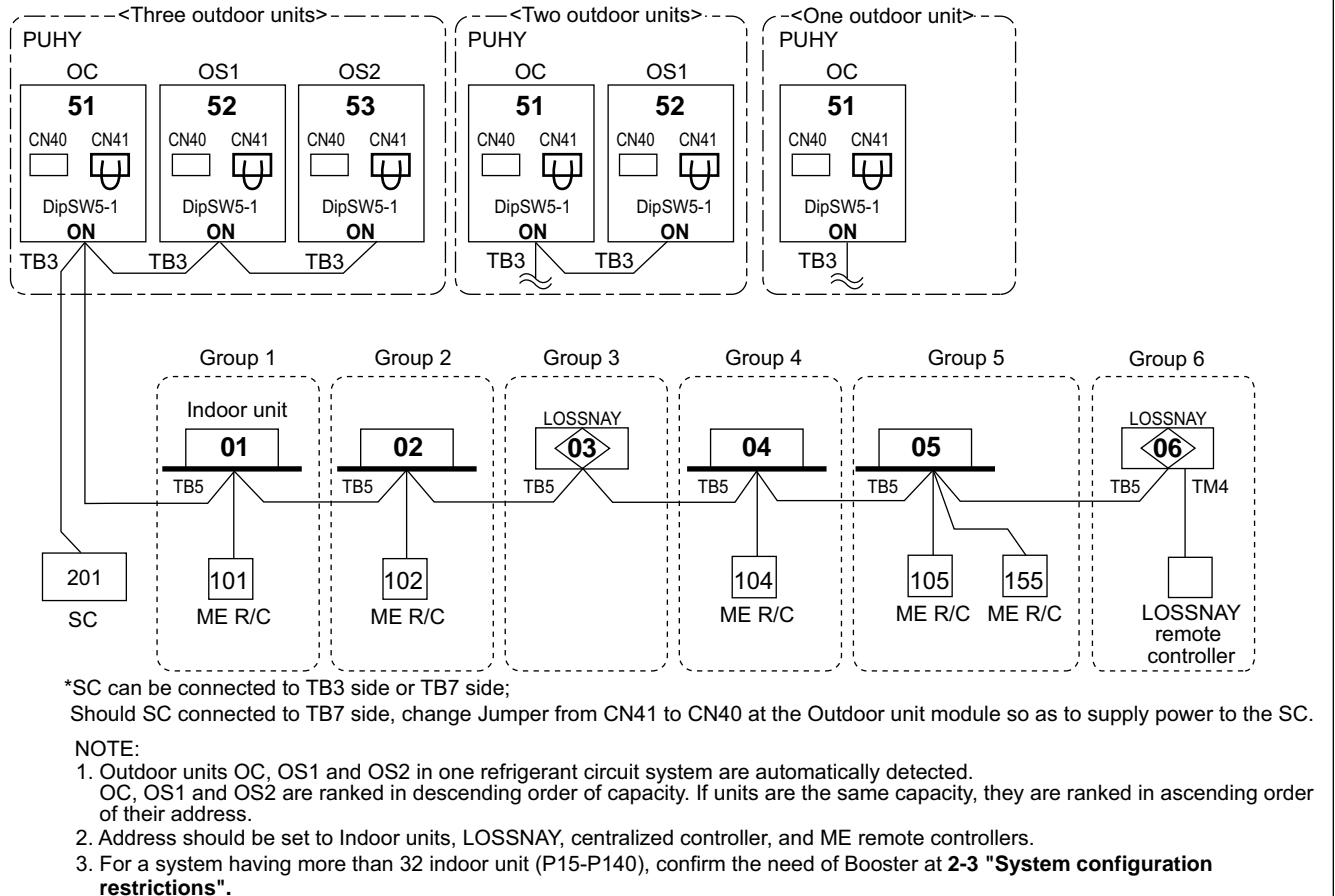

2-4-3-6. ME remote controller, Multi-refrigerant-system, System Controller at TB 7side, LOSSNAY, Booster for long M-NET wiring

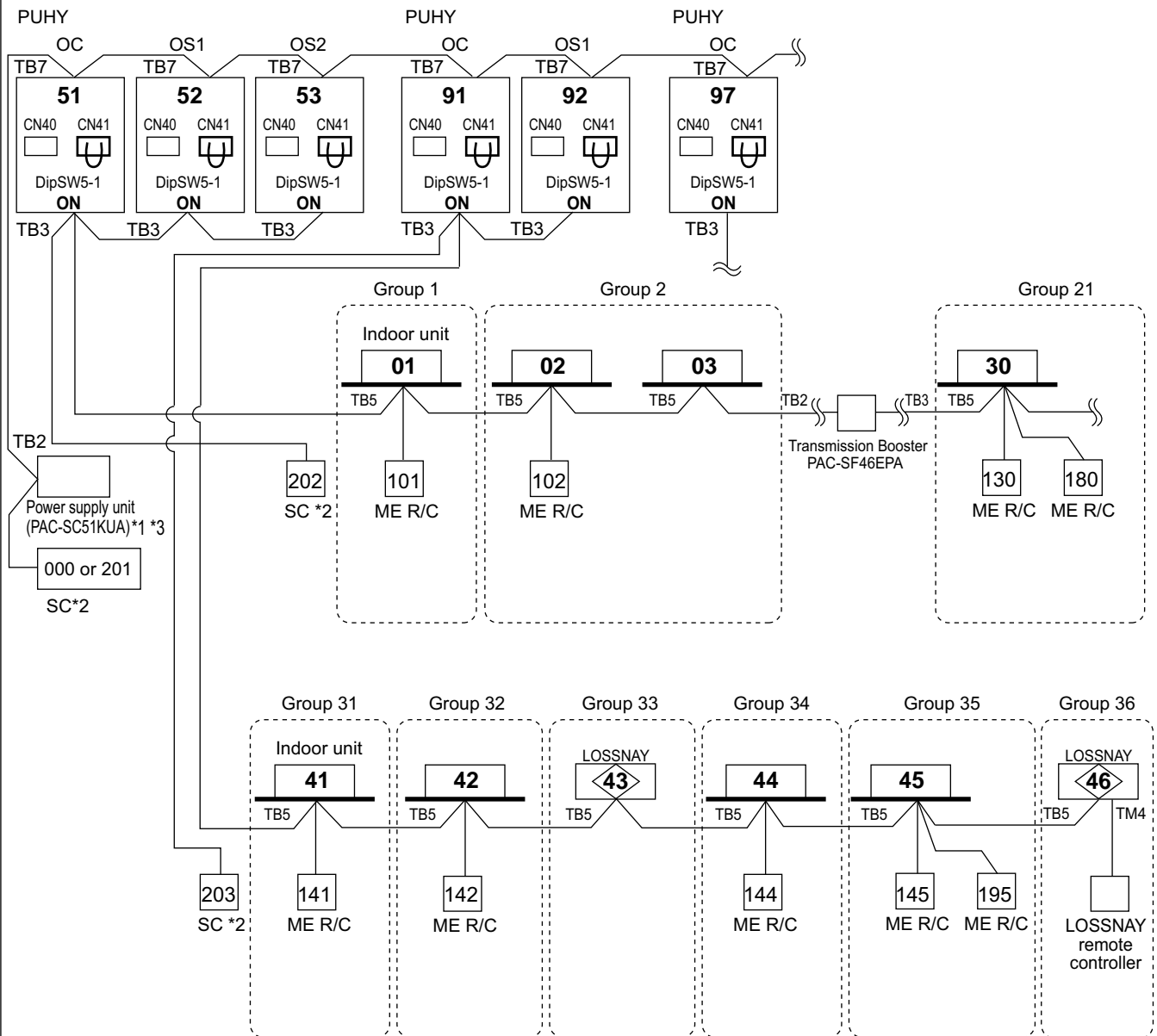

*1 System controller should connect to TB7 at Outdoor and use power supply unit together in Multi-Refrigerant-System.
For AG-150A, 24V DC should be used with the PAC-SC51KUA. For AE-200E/AE-50E, the power supply unit PAC-SC51KUA is unused.

*2 When multiple system controllers are connected in the system, set the controller with more functions than others as a "main" controller and others as "sub".
AE-200E/AE-50E, AG-150A and GB-50ADA-J are for exclusive use as a "main" system controller and cannot be used as a "sub" system controller. Make the setting to only one of the system controllers for "prohibition of operation from local remote controller".

*3 The power supply unit is not necessary for AE-200E, AE-50E, BAC-HD150, and LM-AP.

NOTE:

1. Outdoor units OC, OS1 and OS2 in one refrigerant circuit system are automatically detected.
OC, OS1 and OS2 are ranked in descending order of capacity. If units are the same capacity, they are ranked in ascending order of their address.
2. M-NET power is supplied by the Outdoor unit at TB3, while Indoor unit and ME remote controller consume the M-NET power for transmission use. The power balance is needed to consider for long M-NET wiring. Details refer to 2-3 "System configuration restrictions".

2-4-3-7. ME remote controller, Multi-refrigerant-system, No Power supply unit

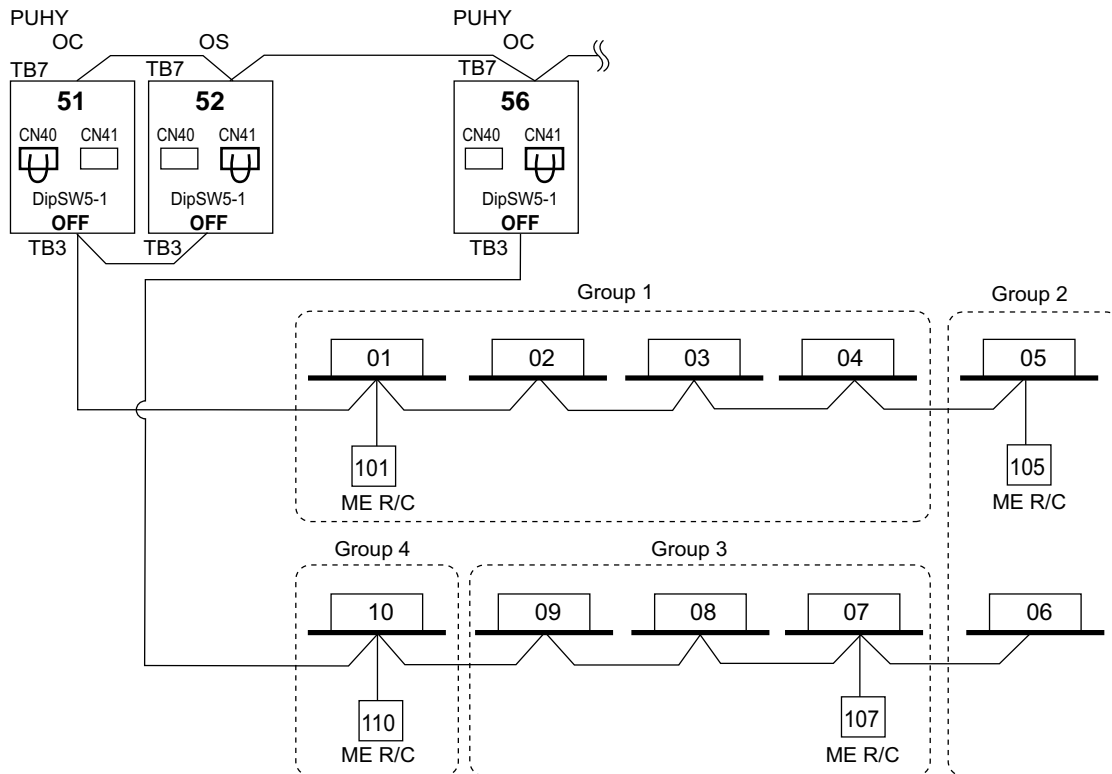

NOTE

- It is necessary to change the connector to CN40 on the outdoor unit control board (only one outdoor unit) when the group is set between other refrigerant systems.
- It is necessary to set on the remote controller by manual when group sets on the different refrigerant system. Please refer to remote controller installation manual.

2-4-3-8. ME remote controller, Multi-refrigerant-system, System Controller at TB7 side, No Power supply unit

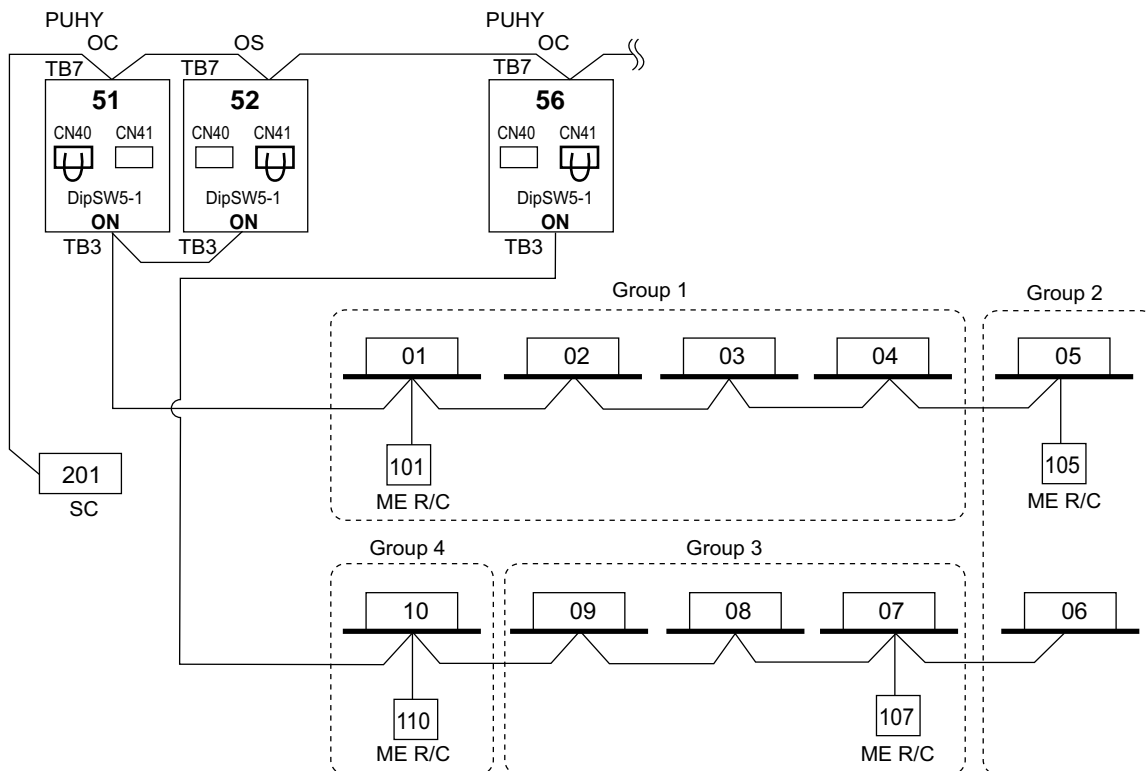

NOTE

- It is necessary to change the connector to CN40 on the outdoor unit control board (only one outdoor unit) when the group is set between other refrigerant systems.
- It is necessary to set on the remote controller by manual when group sets on the different refrigerant system. Please refer to remote controller installation manual.

2-4-3-9. TG-2000A(*1)+AE-200E,GB-50ADA-J
 AE-200E can control max. 50 indoor units;
 GB-50ADA-J can control max. 50 indoor units;
 TG-2000A can control max. 40 of AE-200E and GB-50ADA-J;*2
 TG-2000A can control max. 2000 indoor units.

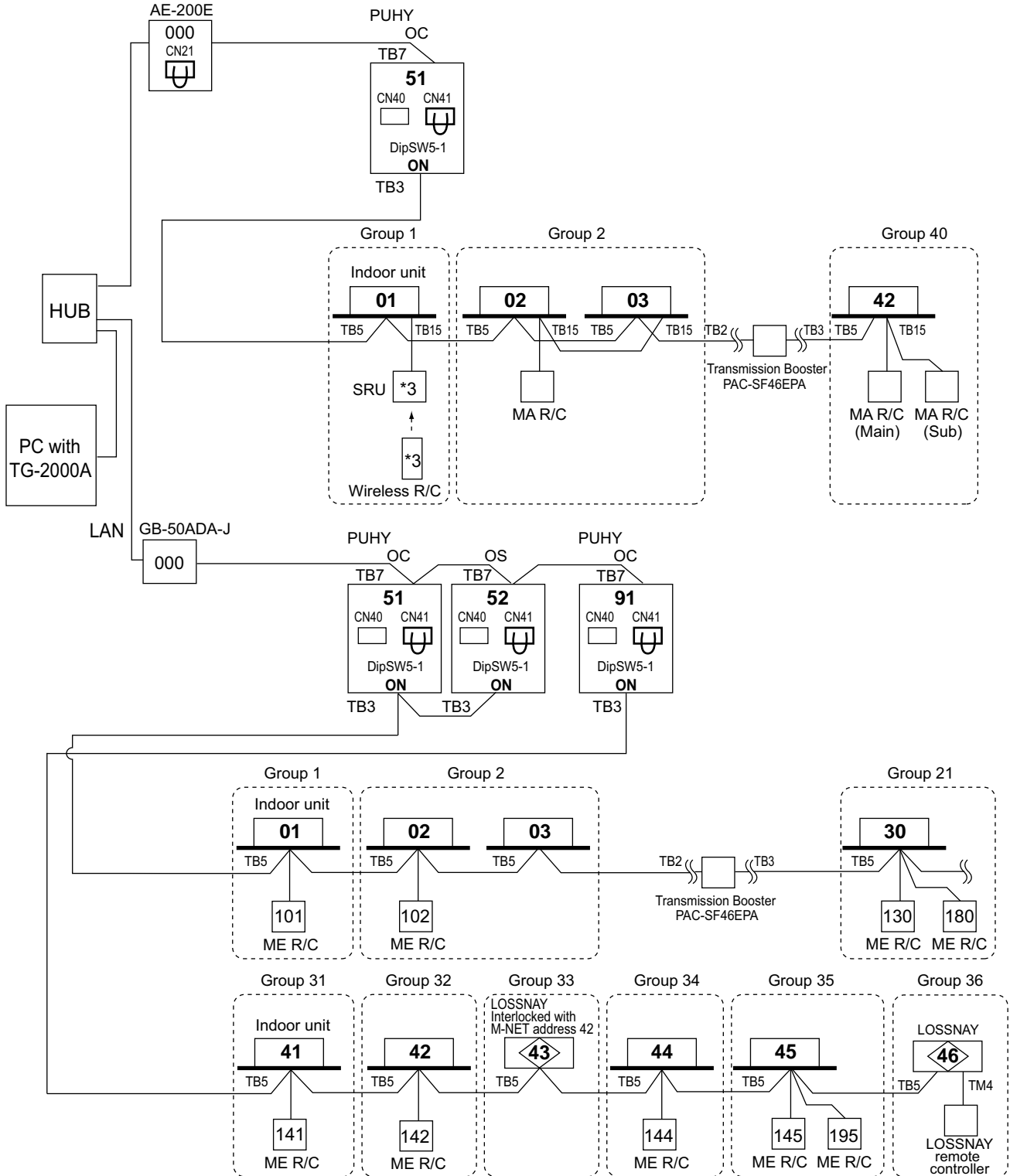

*1 TG-2000A (Ver.6.5 or later) supports AE-200E/AE-50E (Ver.7.10 or later).

TG-2000A (Ver. 6.3 or later) supports GB-50ADA-J.

*2 When AE-200E connected with AE-50E is connected, the number of AE-50E will be the maximum controllable number.

TG-2000A can control up to 40 AE-200E/AE-50E or AE-200E without AE-50E connection.

*3 For Wireless R/C and Signal receiver unit (SRU), channel 1, 2 and 3 are selectable and should be set to same channel.

*4 When a PAR-31MAA(E) is connected to a group, no other MA remote controllers can be connected to the same group.

2-4-3-10. AE-200E + AE-50E
 AE-200E can control max. 200 indoor units/via AE-50E.

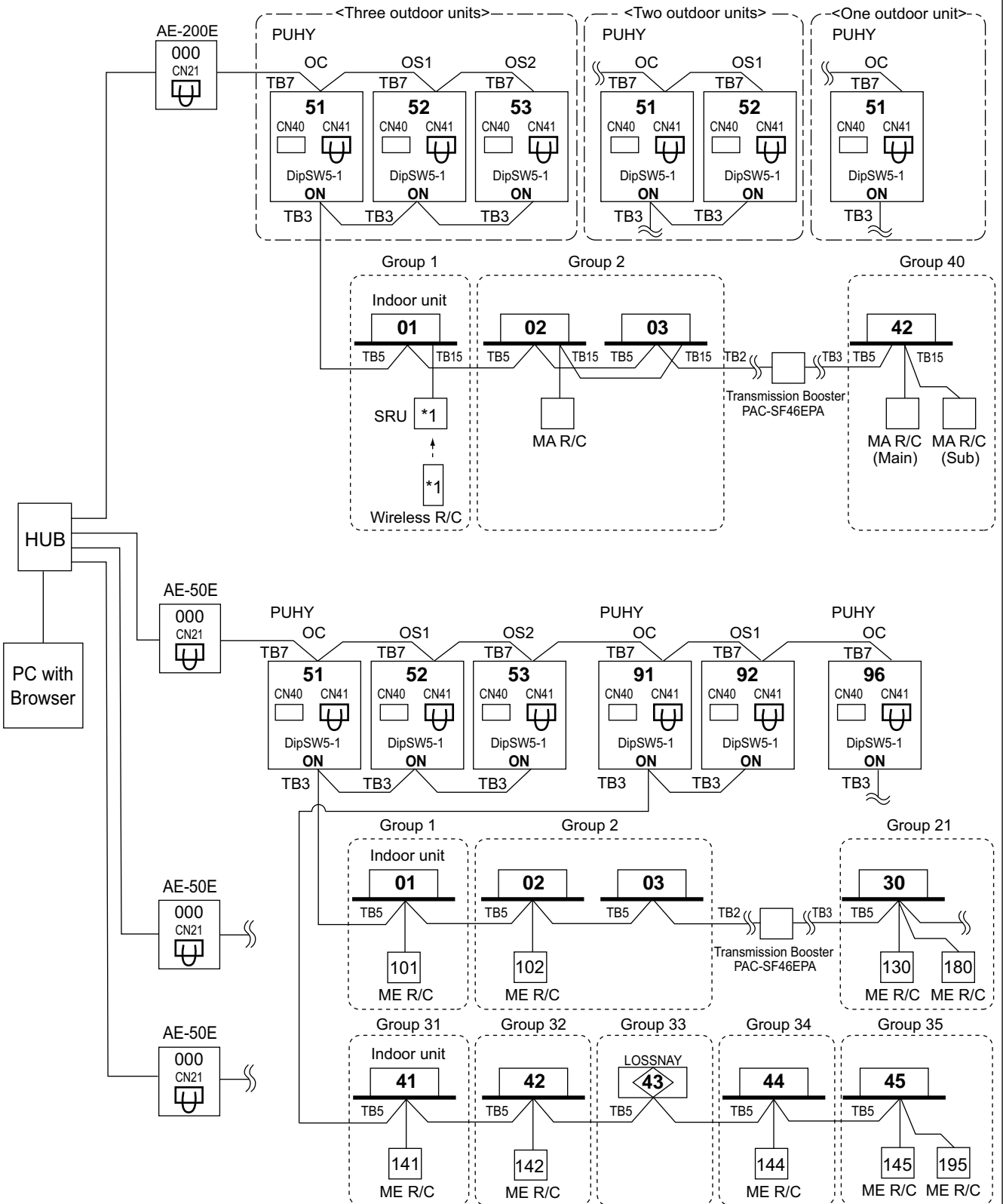

*1 For Wireless R/C and Signal receiver unit (SRU), channel 1, 2 and 3 are selectable and should be set to same channel.

*2 When a PAR-31MAA(E) is connected to a group, no other MA remote controllers can be connected to the same group.

2-4-3-11. LM-AP

LM-AP can transmit for max. 50 indoor units;

If system controller (SC) is used, DipSW1-2 at LM-AP and DipSW5-1 at Outdoor unit should set to "ON".

Change Jumper from CN41 to CN40 to activate power supply to LM-AP itself for those LM-AP connected without system controller (SC).

LM-AP can transmit for max. 50 indoor units in single-refrigerant-system or multi-refrigerant-system.

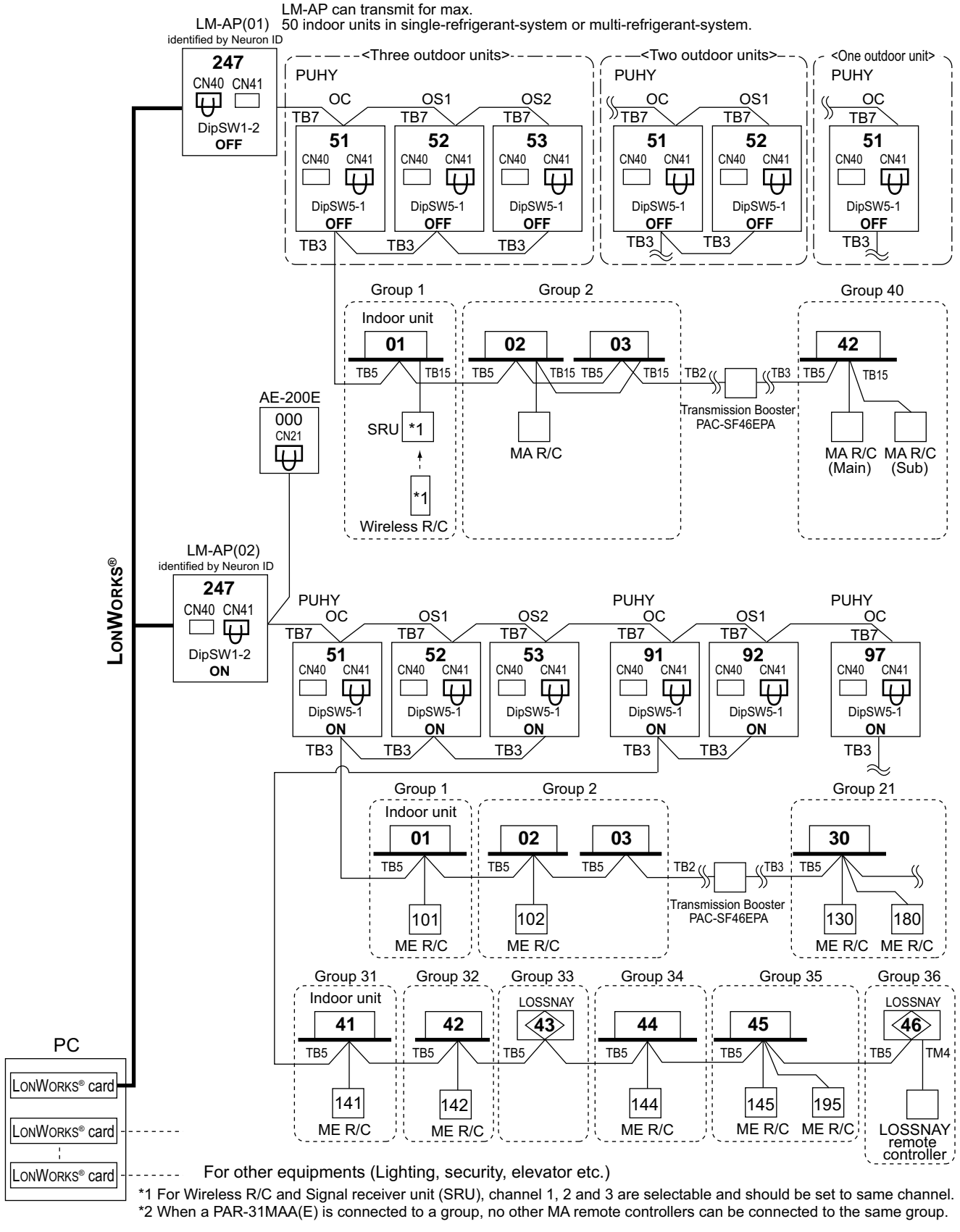

2-4-3-12. BM ADAPTER

BM ADAPTER can transmit for max. 50 indoor units;

Change Jumper from CN41 to CN40 to activate power supply to BM ADAPTER itself for those BM ADAPTER connected without the power supply unit.

BM ADAPTER can transmit for max. 50 indoor units in single-refrigerant-system or multi-refrigerant-system.

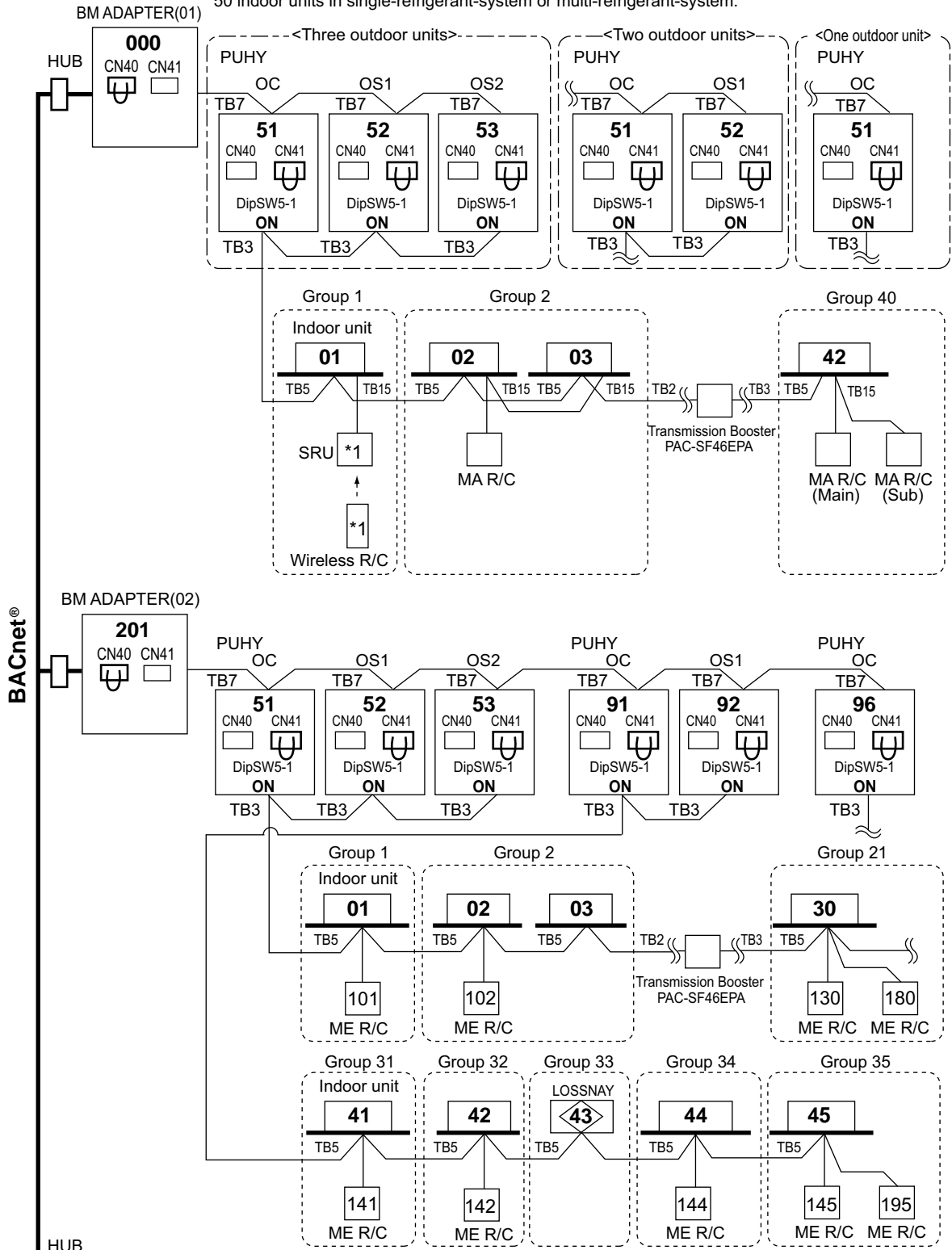

HUB For other equipments (Lighting, security, elevator etc.)

*1 For Wireless R/C and Signal receiver unit (SRU), channel 1, 2 and 3 are selectable and should be set to same channel.

*2 When a PAR-31MAA(E) is connected to a group, no other MA remote controllers can be connected to the same group.

2-4-3-13. BM ADAPTER+AE-200E/AE-50E

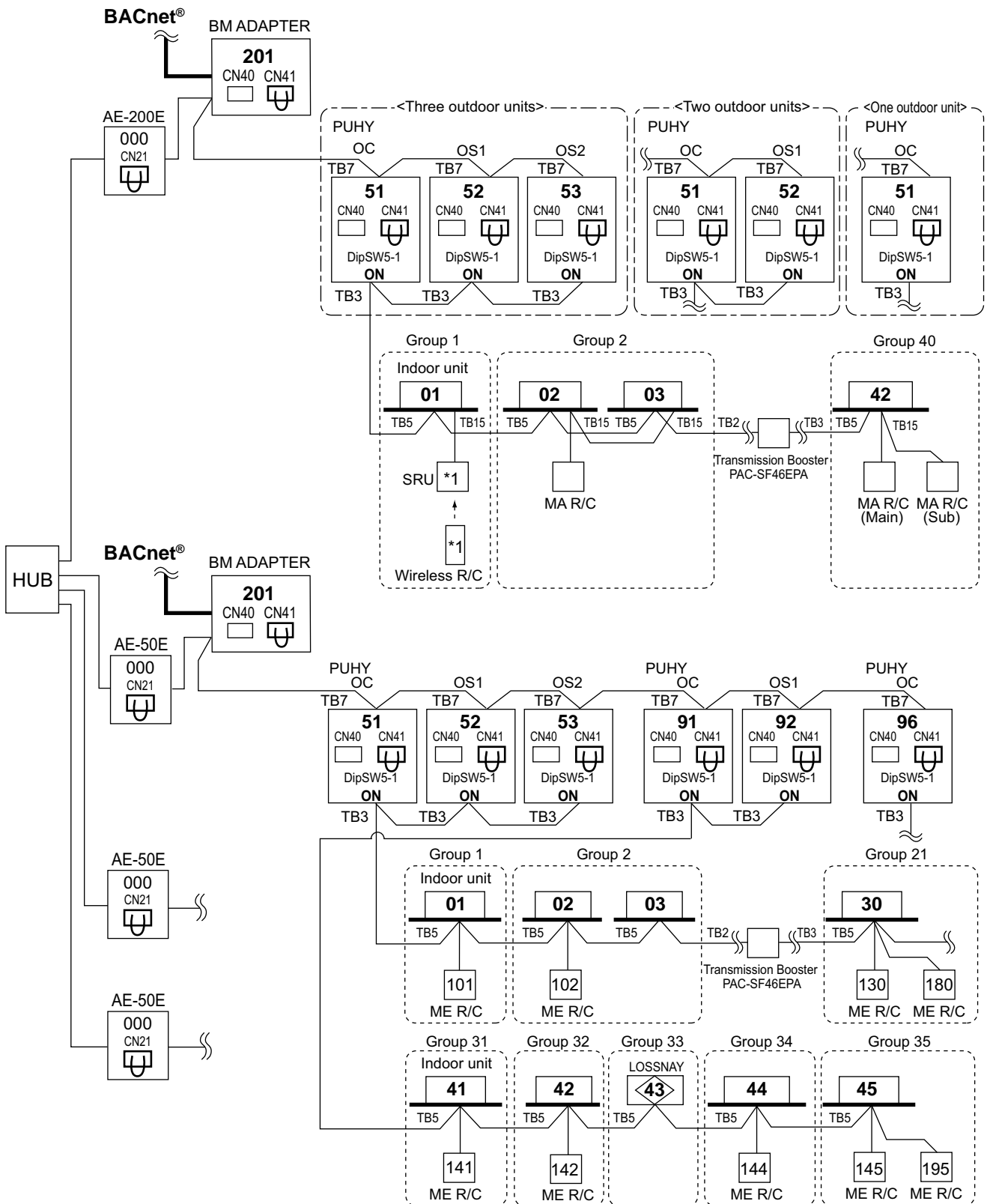

NOTE

• It is not necessary to connect the M-NET transmission line to the TB3 on BM ADAPTER. Leave the power jumper of BM ADAPTER connected to CN41.

*1 For Wireless R/C and Signal receiver unit (SRU), channel 1, 2 and 3 are selectable and should be set to same channel.

*2 Consult your dealer for restrictions when connecting both AE-200E/AE-50E and BM ADAPTER.

*3 When a PAR-31MAA(E) is connected to a group, no other MA remote controllers can be connected to the same group.

*4 In a system that uses AE-200E and/or AE-50E, each BM-ADAPTER must be connected to the M-NET line.

3-1. R410A Piping material

Refrigerant pipe for CITY MULTI shall be made of phosphorus deoxidized copper, and has two types.

A. Type-O : Soft copper pipe (annealed copper pipe), can be easily bent with human's hand.

B. Type-1/2H pipe : Hard copper pipe (Straight pipe), being stronger than Type-O pipe of the same radical thickness.

The maximum operation pressure of R410A air conditioner is 4.30 MPa [623psi]. The refrigerant piping should ensure the safety under the maximum operation pressure. MITSUBISHI ELECTRIC recommends pipe size as Table 3-1, or You shall follow the local industrial standard. Pipes of radical thickness 0.7mm or less shall not be used.

Table 3-1. Copper pipe size and radial thickness for R410A CITY MULTI.

Size (mm)	Size (inch)	Radial thickness (mm)	Radial thickness (mil)	Pipe type
ø6.35	ø1/4"	0.8	[32]	Type-O
ø9.52	ø3/8"	0.8	[32]	Type-O
ø12.7	ø1/2"	0.8	[32]	Type-O
ø15.88	ø5/8"	1.0	[40]	Type-O
ø19.05	ø3/4"	1.2	[48]	Type-O
ø19.05	ø3/4"	1.0	[40]	Type-1/2H or H
ø22.2	ø7/8"	1.0	[40]	Type-1/2H or H
ø25.4	ø1"	1.0	[40]	Type-1/2H or H
ø28.58	ø1-1/8"	1.0	[40]	Type-1/2H or H
ø31.75	ø1-1/4"	1.1	[44]	Type-1/2H or H
ø34.93	ø1-3/8"	1.2	[48]	Type-1/2H or H
ø41.28	ø1-5/8"	1.4	[56]	Type-1/2H or H

* For pipe sized ø19.05 (3/4") for R410A air conditioner, choice of pipe type is up to you.

* The figures in the radial thickness column are based on the Japanese standards and provided only as a reference. Use pipes that meet the local standards.

Flare

Due to the relative higher operation pressure of R410A compared to R22, the flare connection should follow dimensions mentioned below so as to achieve enough the air-tightness.

Flare pipe	Pipe size	A (For R410A) (mm[in.])	Flare nut	Pipe size	B (For R410A) (mm[in.])
	ø6.35 [1/4"]	9.1		ø6.35 [1/4"]	17.0
	ø9.52 [3/8"]	13.2		ø9.52 [3/8"]	22.0
	ø12.70 [1/2"]	16.6		ø12.70 [1/2"]	26.0
	ø15.88 [5/8"]	19.7		ø15.88 [5/8"]	29.0
	ø19.05 [3/4"]	24.0		ø19.05 [3/4"]	36.0

3-2. Piping Design

3-2-1. PUHY-P200-500YKB-A1 Piping

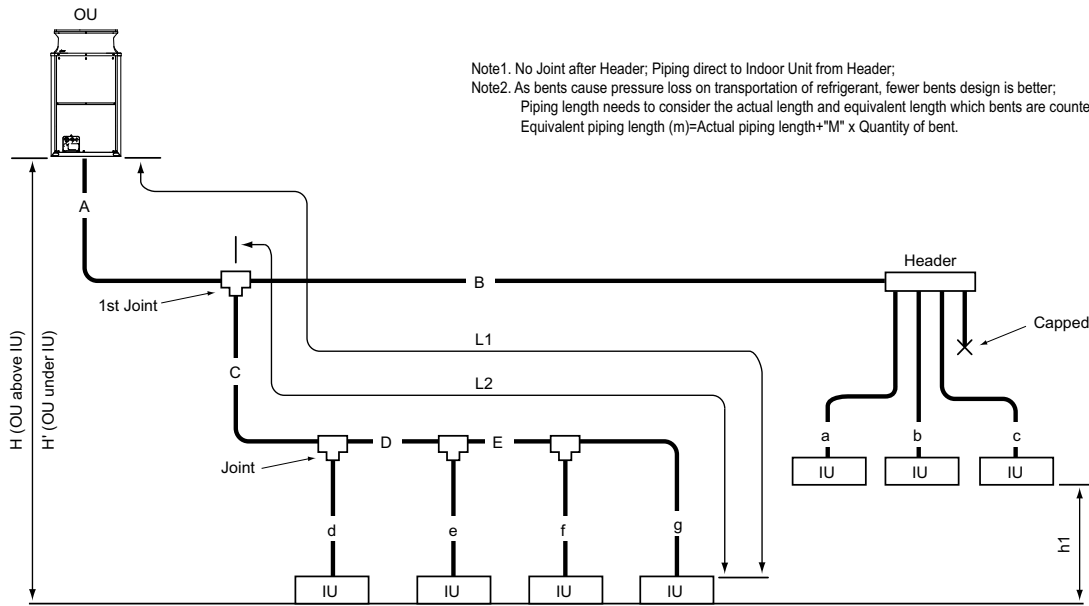

Fig. 3-2-1A Piping scheme

IU : Indoor unit , OU : Outdoor unit

Piping length		(m [ft.])		Bent equivalent length "M"	
Item	Piping in the figure	Max. length	Max. equivalent length	Outdoor unit model	M (m/bent [ft./bent])
Total piping length	A+B+C+D+E+a+b+c+d+e+f+g	1000 [3280"]	-	PUHY-P200YKB-A1	0.42 [1.38]
Farthest IU from OU (L1)	A+C+D+E+g / A+B+c	165 [541"]	190 [623"]	PUHY-P250YKB-A1	0.42 [1.38]
Farthest IU from first Joint (L2)	C+D+E+g / B+c	40 [131"] *3	40 [131"]	PUHY-P300YKB-A1	0.47 [1.54]
Height between OU and IU (OU above IU)	H	50 [164"] *1	-	PUHY-P350YKB-A1	0.47 [1.54]
Height between OU and IU (OU under IU)	H'	40 [131"] *2	-	PUHY-P400YKB-A1	0.50 [1.64]
Height between IU and IU	h1	15 [49"] *4	-	PUHY-P450YKB-A1	0.50 [1.64]
				PUHY-P500YKB-A1	0.50 [1.64]

OU: Outdoor Unit, IU: Indoor Unit

- *1 90m is available depending on the model and installation conditions. For more detailed information, contact your local distributor.
- *2 60m is available depending on the model and installation conditions. For more detailed information, contact your local distributor.
- *3 90m is available. When the piping length exceeds 40m, use one size larger liquid pipe starting with the section of piping where 40m is exceeded and all piping after that point. In the figure above, if the piping labeled "E" exceeds 40 meters (but does not exceed 90 meters), increase the size of the liquid piping labeled E, f, and g by one size.
- *4 30m is available. If the height difference between indoor units exceeds 15 meters (but does not exceed 30 meters), use one-size larger pipes for indoor unit liquid pipes. In the figure above, if "h1" exceeds 15 meters, increase the size of the liquid piping labeled C, D, E, d, e, f, and g by one size.

Piping "A" size selection rule		(mm [in.])	
Outdoor unit	Pipe(Liquid)	Pipe(Gas)	Joint
PUHY-P200YKB-A1	ø9.52 [3/8"]	ø22.20 [7/8"]	~ P200
PUHY-P250YKB-A1	ø9.52 [3/8"] *1	ø22.20 [7/8"]	P201 ~ P400
PUHY-P300YKB-A1	ø9.52 [3/8"] *2	ø22.20 [7/8"]	P401 ~ P650
PUHY-P350YKB-A1	ø12.70 [1/2"]	ø28.58 [1-1/8"]	P651 ~
PUHY-P400YKB-A1	ø12.70 [1/2"]	ø28.58 [1-1/8"]	
PUHY-P450YKB-A1	ø15.88 [5/8"]	ø28.58 [1-1/8"]	
PUHY-P500YKB-A1	ø15.88 [5/8"]	ø28.58 [1-1/8"]	

- *1. L1>=90m [295ft.], ø12.70mm [1/2in.]; L1<90m [295ft.], ø9.52mm [3/8in.]
- *2. L1>=40m [131ft.], ø12.70mm [1/2in.]; L1<40m [131ft.], ø9.52mm [3/8in.]

Selection criteria for joints	
Total down-stream Indoor capacity	Joint
~ P200	CMY-Y102SS-G2
P201 ~ P400	CMY-Y102LS-G2
P401 ~ P650	CMY-Y202S-G2
P651 ~	CMY-Y302S-G2

*Concerning detailed usage of Joint parts, refer to its Installation Manual.

See the table below for the first joint of the outdoor unit described below.

Outdoor unit model	Joint model
P450, P500	CMY-Y202S-G2

Piping "B", "C", "D", "E" size selection rule		(mm [in.])	
Total down-stream Indoor capacity	Pipe(Liquid)	Pipe(Gas)	Header selection rule
~ P140	ø9.52 [3/8"]	ø15.88 [5/8"]	4-branch Header
P141 ~ P200	ø9.52 [3/8"]	ø19.05 [3/4"]	8-branch Header
P201 ~ P300	ø9.52 [3/8"]	ø22.20 [7/8"]	10-branch Header
P301 ~ P400	ø12.70 [1/2"]	ø28.58 [1-1/8"]	CMY-Y104-G
P401 ~ P650	ø15.88 [5/8"]	ø28.58 [1-1/8"]	CMY-Y108-G
P651 ~ P800	ø19.05 [3/4"]	ø34.93 [1-3/8"]	CMY-Y1010-G
P801 ~	ø19.05 [3/4"]	ø41.28 [1-5/8"]	

Total down-stream Indoor capacity	4-branch Header	8-branch Header	10-branch Header
<=P200	<=P200	<=P400	<=P650

- * CMY-Y104-G can directly connect PUHY-P200YKB-A1, but can NOT directly connect PUHY-P250YKB-A1 or above;
- * CMY-Y108-G can directly connect PUHY-P200-450Y(S)KB-A1, but can NOT directly connect PUHY-P500Y(S)KB-A1 or above;
- * CMY-Y1010-G can directly connect PUHY-P200-600Y(S)KB-A1;
- * CMY-Y104-G can NOT connect P200,P250 Indoor, but CMY-Y108, Y1010-G can do;
- * Concerning detailed usage of Header parts, refer to its Installation Manual.

- Note3. Indoor capacity is described as its model size; For example, PEFY-P32VMA-E, its capacity is P32;
- Note4. Total down-stream Indoor capacity is the summary of the model size of Indoors downstream. For example, PEFY-P25VMA-E+PEFY-P32VMA-E: Total Indoor capacity=P25+P32=P57
- Note5. Piping sized determined by the Total down-stream indoor capacity is NOT necessary to be bigger than the up-stream one. i.e. A>=B; A>C>=D

Piping "a", "b", "c", "d", "e", "f", "g" size selection rule		(mm [in.])	
Indoor Unit size	Pipe(Liquid)	Pipe(Gas)	
P20,P25,P32,P40,P50,GUF-50RD(H)	ø6.35 [1/4"]	ø12.70 [1/2"]	
P63,P71,P80,P100,P125,P140,GUF-100RD(H)	ø9.52 [3/8"]	ø15.88 [5/8"]	
P200	ø9.52 [3/8"]	ø19.05 [3/4"]	
P250	ø9.52 [3/8"]	ø22.20 [7/8"]	

3-2-2. PUHY-P400-900YSKB-A1 Piping

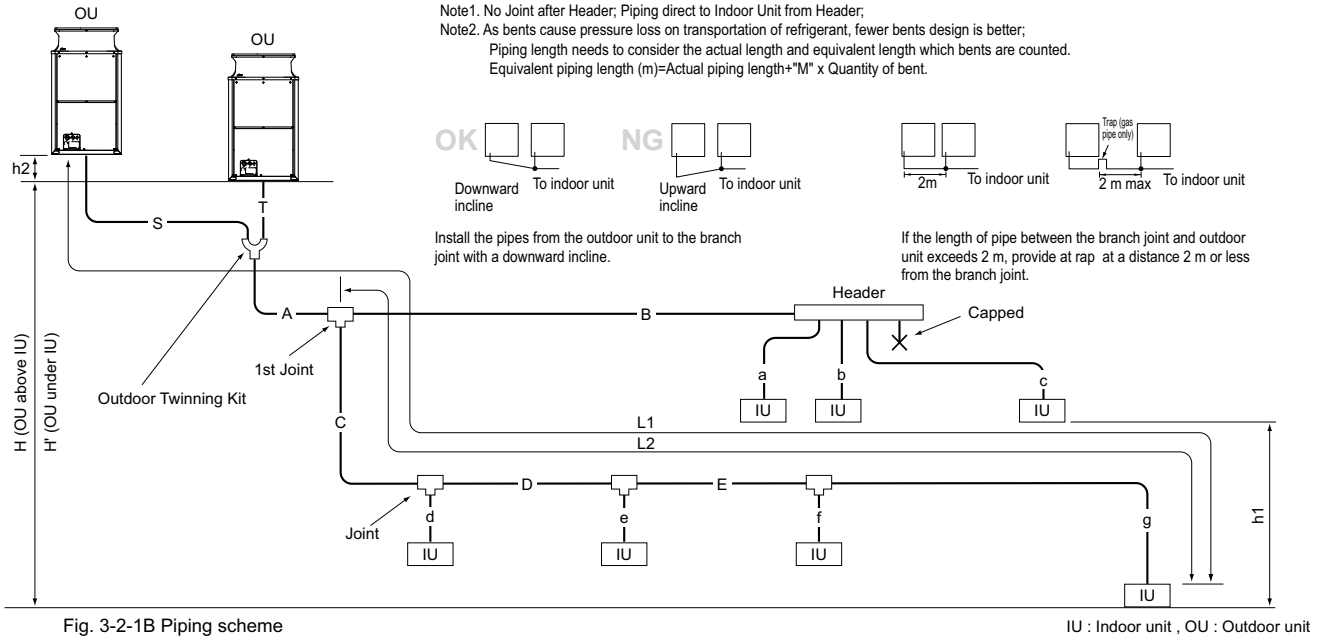

Fig. 3-2-1B Piping scheme

Piping length		(m [ft.])	Bent equivalent length "M"
Item	Piping in the figure	Max. length	Max. equivalent length
Total piping length	S+T+A+B+C+D+E+a+b+c+d+e+f+g	1000 [3280]	-
Distance between OU and OU	S+T	10 [32]	-
Height between OU and OU	h2	0.1 [0.3]	-
Farthest IU from OU (L1)	S(T)+A+C+D+E+g / S(T)+A+B+c	165 [541]	190 [623]
Farthest IU from the first Joint (L2)	C+D+E+g / B+c	40 [131]	*3 40 [131]
Height between OU and IU (OU above IU)	H	50 [164]	*1 -
Height between OU and IU (OU under IU)	H'	40 [131]	*2 -
Height between IU and IU	h1	15 [49]	*4 -

Outdoor unit model	M (m/bent [ft./bent])
PUHY-P400YSKB-A1	0.50 [1.64]
PUHY-P450YSKB-A1	0.50 [1.64]
PUHY-P500YSKB-A1	0.50 [1.64]
PUHY-P550YSKB-A1	0.50 [1.64]
PUHY-P600YSKB-A1	0.50 [1.64]
PUHY-P650YSKB-A1	0.50 [1.64]
PUHY-P700YSKB-A1	0.70 [2.29]
PUHY-P750YSKB-A1	0.70 [2.29]
PUHY-P800YSKB-A1	0.70 [2.29]
PUHY-P850YSKB-A1	0.80 [2.62]
PUHY-P900YSKB-A1	0.80 [2.62]

OU: Outdoor Unit, IU: Indoor Unit

*1 90m is available depending on the model and installation conditions. For more detailed information, contact your local distributor.

*2 60m is available depending on the model and installation conditions. For more detailed information, contact your local distributor.

*3 90m is available. When the piping length exceeds 40m, use one size larger liquid pipe starting with the section of piping where 40m is exceeded and all piping after that point.

In the figure above, if the piping labeled "E" exceeds 40 meters (but does not exceed 90 meters), increase the size of the liquid piping labeled E, f, and g by one size.

*4 30m is available. If the height difference between indoor units exceeds 15 meters (but does not exceed 30 meters), use one-size larger pipes for indoor unit liquid pipes.

In the figure above, if "h1" exceeds 15 meters, increase the size of the liquid piping labeled C, D, E, and g by one size.

Piping "A" size selection rule	(mm [in.])		
Outdoor unit	Twinning kit	Pipe(Liquid)	Pipe(Gas)
PUHY-P400YSKB-A1	CMY-Y100VBK3	ø12.7 [1/2"]	ø28.58 [1-1/8"]
PUHY-P450-650YSKB-A1	CMY-Y100VBK3	ø15.88 [5/8"]	ø28.58 [1-1/8"]
PUHY-P700-800YSKB-A1	CMY-Y200VBK2	ø19.05 [3/4"]	ø34.93 [1-3/8"]
PUHY-P850-900YSKB-A1	CMY-Y200VBK2	ø19.05 [3/4"]	ø41.28 [1-5/8"]

For Piping size "S", "T", please refer to specification of the Twinning kit CMY-Y100VBK3 at the Outdoor unit's external drawing.

Selection criteria for joints	Joint
Total down-stream Indoor capacity	Joint
~ P200	CMY-Y102SS-G2
P201 ~ P400	CMY-Y102LS-G2
P401 ~ P650	CMY-Y202S-G2
P651 ~	CMY-Y302S-G2

* Concerning detailed usage of Joint parts, refer to its Installation Manual.

*The total capacity of the units in the downstream of the branch joint on at least one of the piping lines that are connected to the branch joint should be 650 or below.

If the total capacity of the units in the downstream of the branch joints on both lines is 650 or above use two branch joints (CMY-Y302S-G2).

See the table below for the first joint of the outdoor unit described below.

Outdoor unit model	Joint model
P450 to P650	CMY-Y202S-G2
P700 to P900	CMY-Y302S-G2

Header selection rule	4-branch Header	8-branch Header	10-branch Header
	CMY-Y104-G	CMY-Y108-G	CMY-Y1010-G
Total down-stream Indoor capacity	<=P200	<=P400	<=P650

* CMY-Y104-G can directly connect PUHY-P200YKB-A1, but can NOT directly connect PUHY-P250YKB-A1 or above;

* CMY-Y108-G can directly connect PUHY-P200-450Y(S)KB-A1, but can NOT directly connect PUHY-P500Y(S)KB-A1 or above;

* CMY-Y1010-G can directly connect PUHY-P200-600Y(S)KB-A1;

* CMY-Y104-G can NOT connect P200, P250 Indoor, but CMY-Y108, Y1010-G can do;

* Concerning detailed usage of Header parts, refer to its Installation Manual.

Note3. Indoor capacity is described as its model size;

For example, PEFY-P32VMA-E, its capacity is P32;

Note4. Total down-stream Indoor capacity is the summary of the model size of Indoors downstream.

For example, PEFY-P25VMA-E+PEFY-P32VMA-E: Total Indoor capacity=P25+P32=P57

Note5. Piping sized determined by the Total down-stream indoor capacity is NOT necessary

to be bigger than the up-stream one.

i.e. A>=B; A>C>=D

Piping "B", "C", "D", "E" size selection rule	(mm [in.])	
Total down-stream Indoor capacity	Pipe(Liquid)	Pipe(Gas)
~ P140	ø9.52 [3/8"]	ø15.88 [5/8"]
P141 ~ P200	ø9.52 [3/8"]	ø19.05 [3/4"]
P201 ~ P300	ø9.52 [3/8"]	ø22.20 [7/8"]
P301 ~ P400	ø12.70 [1/2"]	ø28.58 [1-1/8"]
P401 ~ P650	ø15.88 [5/8"]	ø28.58 [1-1/8"]
P651 ~ P800	ø19.05 [3/4"]	ø34.93 [1-3/8"]
P801 ~	ø19.05 [3/4"]	ø41.28 [1-5/8"]

Piping "a", "b", "c", "d", "e", "f", "g" size selection rule	(mm [in.])	
Indoor Unit size	Pipe(Liquid)	Pipe(Gas)
P20, P25, P32, P40, P50, GUF-50RD(H)	ø6.35 [1/4"]	ø12.70 [1/2"]
P63, P71, P80, P100, P125, P140, GUF-100RD(H)	ø9.52 [3/8"]	ø15.88 [5/8"]
P200	ø9.52 [3/8"]	ø19.05 [3/4"]
P250	ø9.52 [3/8"]	ø22.20 [7/8"]

3-2-3. PUHY-P950-1350YSKB-A1 Piping

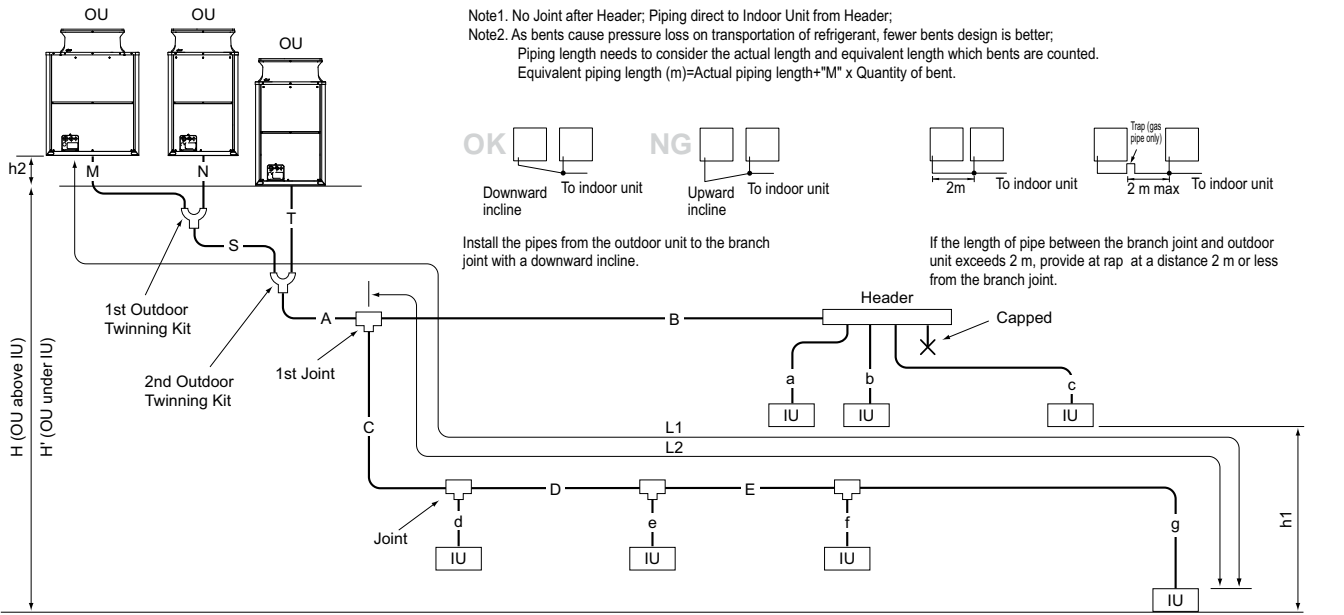

Fig. 3-2-1C Piping scheme

IU : Indoor unit , OU : Outdoor unit

Piping length		(m [ft.])		Bent equivalent length "M"	
Item	Piping in the figure	Max. length	Max. equivalent length	Outdoor unit model	M (m/bent [ft./bent])
Total piping length	S+T+M+N+A+B+C+D+E+a+b+c+d+e+f+g	1000[3280']	-	PUHY-P950YSKB-A1	0.80 [2.62]
Distance between OU and OU	M+N+S+T	10[32']	-	PUHY-P1000YSKB-A1	0.80 [2.62]
Height between OU and OU	h2	0.1[0.3']	-	PUHY-P1050YSKB-A1	0.80 [2.62]
Farthest IU from OU (L1)	M(N)+S+A+C+D+E+g / M(N)+S+A+B+c	165[541']	190[623']	PUHY-P1100YSKB-A1	0.80 [2.62]
Farthest IU from the first Joint (L2)	C+D+E+g / B+c	40[131'] *3	40[131']	PUHY-P1150YSKB-A1	0.80 [2.62]
Height between OU and IU (OU above IU)	H	50[164'] *1	-	PUHY-P1200YSKB-A1	0.80 [2.62]
Height between OU and IU (OU under IU)	H'	40[131'] *2	-	PUHY-P1250YSKB-A1	0.80 [2.62]
Height between IU and IU	h1	15[49'] *4	-	PUHY-P1300YSKB-A1	0.80 [2.62]
				PUHY-P1350YSKB-A1	0.80 [2.62]

OU: Outdoor Unit, IU: Indoor Unit

- *1 90m is available depending on the model and installation conditions. For more detailed information, contact your local distributor.
- *2 60m is available depending on the model and installation conditions. For more detailed information, contact your local distributor.
- *3 90m is available. When the piping length exceeds 40m, use one size larger liquid pipe starting with the section of piping where 40m is exceeded and all piping after that point. In the figure above, if the piping labeled "E" exceeds 40 meters (but does not exceed 90 meters), increase the size of the liquid piping labeled E, f, and g by one size.
- *4 30m is available. If the height difference between indoor units exceeds 15 meters (but does not exceed 30 meters), use one-size larger pipes for indoor unit liquid pipes. In the figure above, if "h1" exceeds 15 meters, increase the size of the liquid piping labeled C, D, E, and g by one size.

Piping "A" size selection rule (mm [in.])

Outdoor unit	Twinning kit	Pipe(Liquid)	Pipe(Gas)
PUHY-P950-1350YSKB-A1	CMY-Y300VBK3	ø19.05[3/4"]	ø41.28[1-5/8"]

For Piping size "M", "N", "S", "T", please refer to specification of the Twinning kit CMY-Y300VBK3 at the Outdoor unit's external drawing.

Selection criteria for joints

Total down-stream Indoor capacity	Joint
~ P200	CMY-Y102SS-G2
P201 ~ P400	CMY-Y102LS-G2
P401 ~ P650	CMY-Y202S-G2
P651 ~	CMY-Y302S-G2

*The total capacity of the units in the downstream of the branch joint on at least one of the piping lines that are connected to the branch joint should be 650 or below.
 If the total capacity of the units in the downstream of the branch joints on both lines is 650 or above use two branch joints (CMY-Y302S-G2).
 *Concerning detailed usage of Joint parts, refer to its Installation Manual.

See the table below for the first joint of the outdoor unit described below.

Outdoor unit model	Joint model
P950 to P1350	CMY-Y302S-G2

Header selection rule

	4-branch Header	8-branch Header	10-branch Header
	CMY-Y104-G	CMY-Y108-G	CMY-Y1010-G
Total down-stream Indoor capacity	<=P200	<=P400	<=P650

- * CMY-Y104-G can directly connect PUHY-P200YKB-A1, but can NOT directly connect PUHY-P250YKB-A1 or above;
- * CMY-Y108-G can directly connect PUHY-P200-450Y(S)KB-A1, but can NOT directly connect PUHY-P500Y(S)KB-A1 or above;
- * CMY-Y1010-G can directly connect, PUHY-P200-600Y(S)KB-A1;
- * CMY-Y104-G can NOT connect P200, P250 Indoor, but CMY-Y108, Y1010-G can do;
- * Concerning detailed usage of Header parts, refer to its Installation Manual.

Piping "B", "C", "D", "E" size selection rule (mm [in.])

Total down-stream Indoor capacity	Pipe(Liquid)	Pipe(Gas)
~ P140	ø9.52 [3/8"]	ø15.88 [5/8"]
P141 ~ P200	ø9.52 [3/8"]	ø19.05 [3/4"]
P201 ~ P300	ø9.52 [3/8"]	ø22.20 [7/8"]
P301 ~ P400	ø12.70 [1/2"]	ø28.58 [1-1/8"]
P401 ~ P650	ø15.88 [5/8"]	ø28.58 [1-1/8"]
P651 ~ P800	ø19.05 [3/4"]	ø34.93 [1-3/8"]
P801 ~	ø19.05 [3/4"]	ø41.28 [1-5/8"]

Piping "a", "b", "c", "d", "e", "f", "g" size selection rule (mm [in.])

Indoor Unit size	Pipe(Liquid)	Pipe(Gas)
P20, P25, P32, P40, P50, GUF-50RD(H)	ø6.35 [1/4"]	ø12.70 [1/2"]
P63, P71, P80, P100, P125, P140, GUF-100RD(H)	ø9.52 [3/8"]	ø15.88 [5/8"]
P200	ø9.52 [3/8"]	ø19.05 [3/4"]
P250	ø9.52 [3/8"]	ø22.20 [7/8"]

- Note3. Indoor capacity is described as its model size; For example, PEFY-P32VMA-E, its capacity is P32;
- Note4. Total down-stream Indoor capacity is the summary of the model size of Indoors downstream. For example, PEFY-P25VMA-E+PEFY-P32VMA-E: Total Indoor capacity=P25+P32=P57
- Note5. Piping sized determined by the Total down-stream indoor capacity is NOT necessary to be bigger than the up-stream one. i.e. A>=B; A>=C>=D

3-2-4. PUHY-EP200-500YLM-A Piping

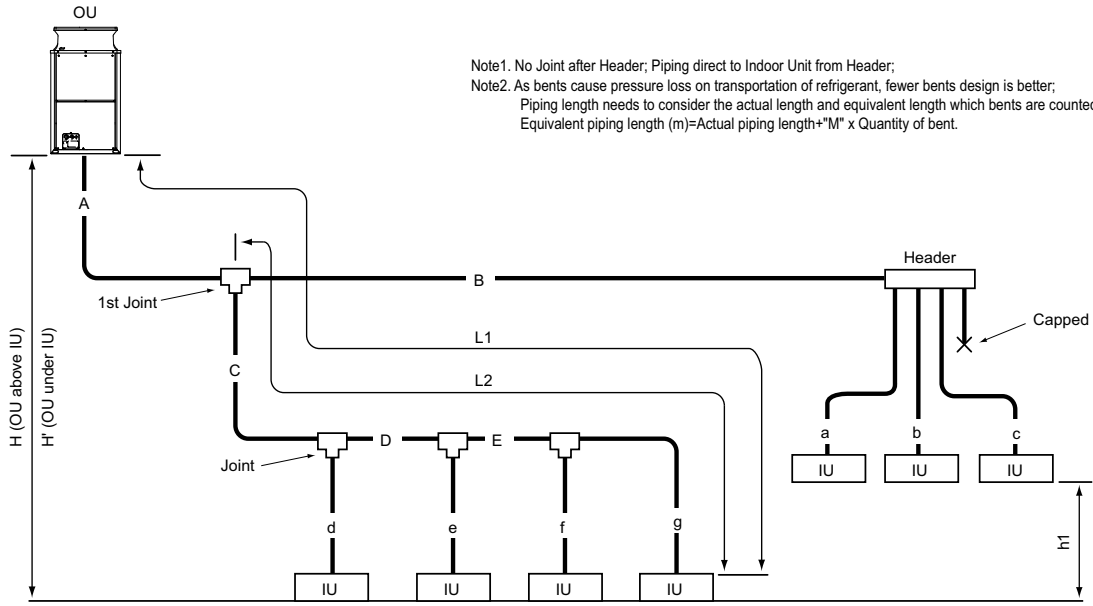

Note1. No Joint after Header; Piping direct to Indoor Unit from Header;
 Note2. As bents cause pressure loss on transportation of refrigerant, fewer bents design is better;
 Piping length needs to consider the actual length and equivalent length which bents are counted.
 Equivalent piping length (m)=Actual piping length+“M” x Quantity of bent.

Fig. 3-2-1A Piping scheme

IU : Indoor unit , OU : Outdoor unit

Piping length	Piping in the figure	(m [ft.])		Bent equivalent length "M"	
		Max. length	Max. equivalent length	Outdoor unit model	M (m/bent [ft./bent])
Total piping length	A+B+C+D+E+a+b+c+d+e+f+g	1000 [3280]	-	PUHY-EP200YLM-A	0.42 [1.38]
Farthest IU from OU (L1)	A+C+D+E+g / A+B+c	165 [541]	190 [623]	PUHY-EP250YLM-A	0.42 [1.38]
Farthest IU from first Joint (L2)	C+D+E+g / B+c	40 [131] *3	40 [131]	PUHY-EP300YLM-A	0.47 [1.54]
Height between OU and IU (OU above IU)	H	50 [164] *1	-	PUHY-EP350YLM-A	0.47 [1.54]
Height between OU and IU (OU under IU)	H'	40 [131] *2	-	PUHY-EP400YLM-A	0.50 [1.64]
Height between IU and IU	h1	15 [49] *4	-	PUHY-EP450YLM-A	0.50 [1.64]
				PUHY-EP500YLM-A	0.50 [1.64]

OU: Outdoor Unit, IU: Indoor Unit

- *1 90m is available depending on the model and installation conditions. For more detailed information, contact your local distributor.
- *2 60m is available depending on the model and installation conditions. For more detailed information, contact your local distributor.
- *3 90m is available. When the piping length exceeds 40m, use one size larger liquid pipe starting with the section of piping where 40m is exceeded and all piping after that point. In the figure above, if the piping labeled "E" exceeds 40 meters (but does not exceed 90 meters), increase the size of the liquid piping labeled E, f, and g by one size.
- *4 30m is available. If the height difference between indoor units exceeds 15 meters (but does not exceed 30 meters), use one-size larger pipes for indoor unit liquid pipes. In the figure above, if "h1" exceeds 15 meters, increase the size of the liquid piping labeled C, D, E, d, e, f, and g by one size.

Piping "A" size selection rule	(mm [in.])	
Outdoor unit	Pipe(Liquid)	Pipe(Gas)
PUHY-EP200YLM	ø9.52 [3/8"]	ø22.20 [7/8"]
PUHY-EP250YLM	ø9.52 [3/8"] *1	ø22.20 [7/8"]
PUHY-EP300YLM	ø9.52 [3/8"] *2	ø28.58 [1-1/8"]
PUHY-EP350YLM	ø12.70 [1/2"]	ø28.58 [1-1/8"]
PUHY-EP400YLM	ø12.70 [1/2"]	ø28.58 [1-1/8"]
PUHY-EP450YLM	ø15.88 [5/8"]	ø28.58 [1-1/8"]
PUHY-EP500YLM	ø15.88 [5/8"]	ø28.58 [1-1/8"]

*1. L1>=90m [295ft.], ø12.70mm [1/2in.]; L1<90m [295ft.], ø9.52mm [3/8in.]
 *2. L1>=40m [131ft.], ø12.70mm [1/2in.]; L1<40m [131ft.], ø9.52mm [3/8in.]

Selection criteria for joints	Joint
Total down-stream Indoor capacity ~ P200	CMY-Y102SS-G2
P201 ~ P400	CMY-Y102LS-G2
P401 ~ P650	CMY-Y202S-G2
P651 ~	CMY-Y302S-G2

*Concerning detailed usage of Joint parts, refer to its Installation Manual.

See the table below for the first joint of the outdoor unit described below.

Outdoor unit model	Joint model
EP450, EP500	CMY-Y202S-G2

Piping "B", "C", "D", "E" size selection rule	(mm [in.])	
Total down-stream Indoor capacity	Pipe(Liquid)	Pipe(Gas)
~ P140	ø9.52 [3/8"]	ø15.88 [5/8"]
P141 ~ P200	ø9.52 [3/8"]	ø19.05 [3/4"]
P201 ~ P300	ø9.52 [3/8"]	ø22.20 [7/8"]
P301 ~ P400	ø12.70 [1/2"]	ø28.58 [1-1/8"]
P401 ~ P650	ø15.88 [5/8"]	ø28.58 [1-1/8"]
P651 ~ P800	ø19.05 [3/4"]	ø34.93 [1-3/8"]
P801 ~	ø19.05 [3/4"]	ø41.28 [1-5/8"]

Header selection rule	4-branch Header	8-branch Header	10-branch Header
	CMY-Y104-G	CMY-Y108-G	CMY-Y1010-G
Total down-stream Indoor capacity	<=P200	<=P400	<=P650

- * CMY-Y104-G can directly connect PUHY-EP200YLM, but can NOT directly connect PUHY-EP250YLM or above;
- * CMY-Y108-G can directly connect PUHY-EP200-450YLM, but can NOT directly connect PUHY-EP500YLM or above;
- * CMY-Y1010-G can directly connect PUHY-EP200-600Y(S)L/M;
- * CMY-Y104-G can NOT connect P200,P250 Indoor, but CMY-Y108, Y1010-G can do;
- * Concerning detailed usage of Header parts, refer to its Installation Manual.

Piping "a", "b", "c", "d", "e", "f", "g" size selection rule	(mm [in.])	
Indoor Unit size	Pipe(Liquid)	Pipe(Gas)
P20, P25, P32, P40, P50, GUF-50RD(H)	ø6.35 [1/4"]	ø12.70 [1/2"]
P63, P71, P80, P100, P125, P140, GUF-100RD(H)	ø9.52 [3/8"]	ø15.88 [5/8"]
P200	ø9.52 [3/8"]	ø19.05 [3/4"]
P250	ø9.52 [3/8"]	ø22.20 [7/8"]

- Note3. Indoor capacity is described as its model size; For example, PEFY-P32VMA-E, its capacity is P32;
- Note4. Total down-stream Indoor capacity is the summary of the model size of Indoors downstream. For example, PEFY-P25VMA-E+PEFY-P32VMA-E: Total Indoor capacity=P25+P32=P57
- Note5. Piping sized determined by the Total down-stream indoor capacity is NOT necessary to be bigger than the up-stream one. i.e. A>=B; A>=C>=D

3-2-5. PUHY-EP550-600YSLM-A Piping

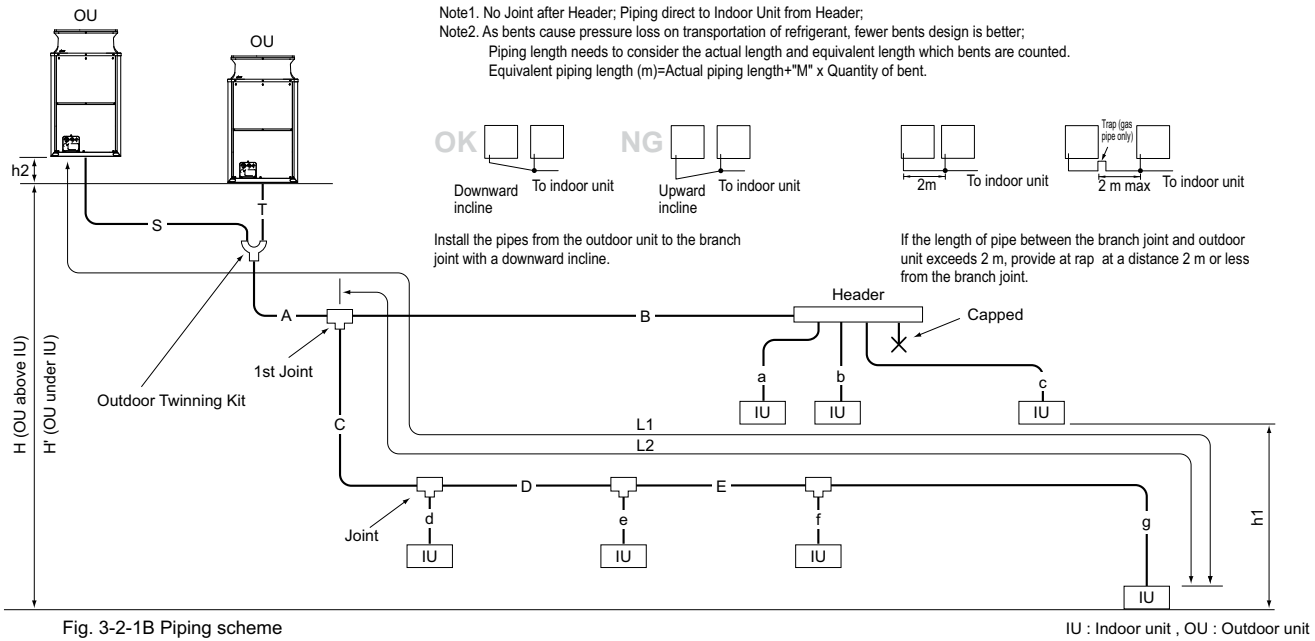

Piping length		(m [ft.])		Bent equivalent length "M"	
Item	Piping in the figure	Max. length	Max. equivalent length	Outdoor unit model	M (m/bent [ft./bent])
Total piping length	S+T+A+B+C+D+E+a+b+c+d+e+f+g	1000 [3280']	-	PUHY-EP550YSLM-A	0.50 [1.64]
Distance between OU and OU	S+T	10[32']	-	PUHY-EP600YSLM-A	0.50 [1.64]
Height between OU and OU	h2	0.1[0.3']	-		
Farthest IU from OU (L1)	S(T)+A+C+D+E+g / S(T)+A+B+c	165 [541']	190 [623']		
Farthest IU from the first Joint (L2)	C+D+E+g / B+c	40 [131'] *3	40 [131']		
Height between OU and IU (OU above IU)	H	50 [164'] *1	-		
Height between OU and IU (OU under IU)	H'	40 [131'] *2	-		
Height between IU and IU	h1	15 [49'] *4	-		

OU: Outdoor Unit, IU: Indoor Unit

- *1 90m is available depending on the model and installation conditions. For more detailed information, contact your local distributor.
- *2 60m is available depending on the model and installation conditions. For more detailed information, contact your local distributor.
- *3 90m is available. When the piping length exceeds 40m, use one size larger liquid pipe starting with the section of piping where 40m is exceeded and all piping after that point. In the figure above, if the piping labeled "E" exceeds 40 meters (but does not exceed 90 meters), increase the size of the liquid piping labeled E, f, and g by one size.
- *4 30m is available. If the height difference between indoor units exceeds 15 meters (but does not exceed 30 meters), use one-size larger pipes for indoor unit liquid pipes. In the figure above, if "h1" exceeds 15 meters, increase the size of the liquid piping labeled C, D, E, and g by one size.

Piping "A" size selection rule		(mm [in.])	
Outdoor unit	Twinning kit	Pipe(Liquid)	Pipe(Gas)
PUHY-EP550-600YSLM	CMY-Y100VBK3	ø15.88[5/8"]	ø28.58[1-1/8"]

For Piping size "S", "T", please refer to specification of the Twinning kit CMY-Y100VBK3 at the Outdoor unit's external drawing.

Selection criteria for joints	
Total down-stream Indoor capacity	Joint
~ P200	CMY-Y102SS-G2
P201 ~ P400	CMY-Y102LS-G2
P401 ~ P650	CMY-Y202S-G2
P651 ~	CMY-Y302S-G2

*Concerning detailed usage of Joint parts, refer to its Installation Manual.
 *The total capacity of the units in the downstream of the branch joint on at least one of the piping lines that are connected to the branch joint should be 650 or below.
 If the total capacity of the units in the downstream of the branch joints on both lines is 650 or above use two branch joints (CMY-Y302S-G2).

See the table below for the first joint of the outdoor unit described below.

Outdoor unit model	Joint model
EP550, EP600	CMY-Y202S-G2

Header selection rule	4-branch Header	8-branch Header	10-branch Header
	CMY-Y104-G	CMY-Y108-G	CMY-Y1010-G
Total down-stream Indoor capacity	<=P200	<=P400	<=P650

- * CMY-Y104-G can directly connect PUHY-EP200YLM, but can NOT directly connect PUHY-EP250YLM or above;
- * CMY-Y108-G can directly connect PUHY-EP200-450YLM, but can NOT directly connect PUHY-EP500YLM or above;
- * CMY-Y1010-G can directly connect PUHY-EP200-600Y(S)LM;
- * CMY-Y104-G can NOT connect P200, P250 Indoor, but CMY-Y108, Y1010-G can do;
- * Concerning detailed usage of Header parts, refer to its Installation Manual.

Piping "B", "C", "D", "E" size selection rule			(mm [in.])	
Total down-stream Indoor capacity	Pipe(Liquid)	Pipe(Gas)		
~ P140	ø9.52 [3/8"]	ø15.88 [5/8"]		
P141 ~ P200	ø9.52 [3/8"]	ø19.05 [3/4"]		
P201 ~ P300	ø9.52 [3/8"]	ø22.20 [7/8"]		
P301 ~ P400	ø12.70 [1/2"]	ø28.58 [1-1/8"]		
P401 ~ P650	ø15.88 [5/8"]	ø28.58 [1-1/8"]		
P651 ~ P800	ø19.05 [3/4"]	ø34.93 [1-3/8"]		
P801 ~	ø19.05 [3/4"]	ø41.28 [1-5/8"]		

Piping "a", "b", "c", "d", "e", "f", "g" size selection rule			(mm [in.])	
Indoor Unit size	Pipe(Liquid)	Pipe(Gas)		
P20, P25, P32, P40, P50, GUF-50RD(H)	ø6.35 [1/4"]	ø12.70 [1/2"]		
P63, P71, P80, P100, P125, P140, GUF-100RD(H)	ø9.52 [3/8"]	ø15.88 [5/8"]		
P200	ø9.52 [3/8"]	ø19.05 [3/4"]		
P250	ø9.52 [3/8"]	ø22.20 [7/8"]		

- Note3. Indoor capacity is described as its model size; For example, PEFY-P32VMA-E, its capacity is P32;
- Note4. Total down-stream Indoor capacity is the summary of the model size of Indoors downstream. For example, PEFY-P25VMA-E+PEFY-P32VMA-E: Total Indoor capacity=P25+P32=P57
- Note5. Piping sized determined by the Total down-stream indoor capacity is NOT necessary to be bigger than the up-stream one.
 i.e. A>=B; A>=C>=D

3-2-6. PUHY-EP650-1350YSLM-A Piping

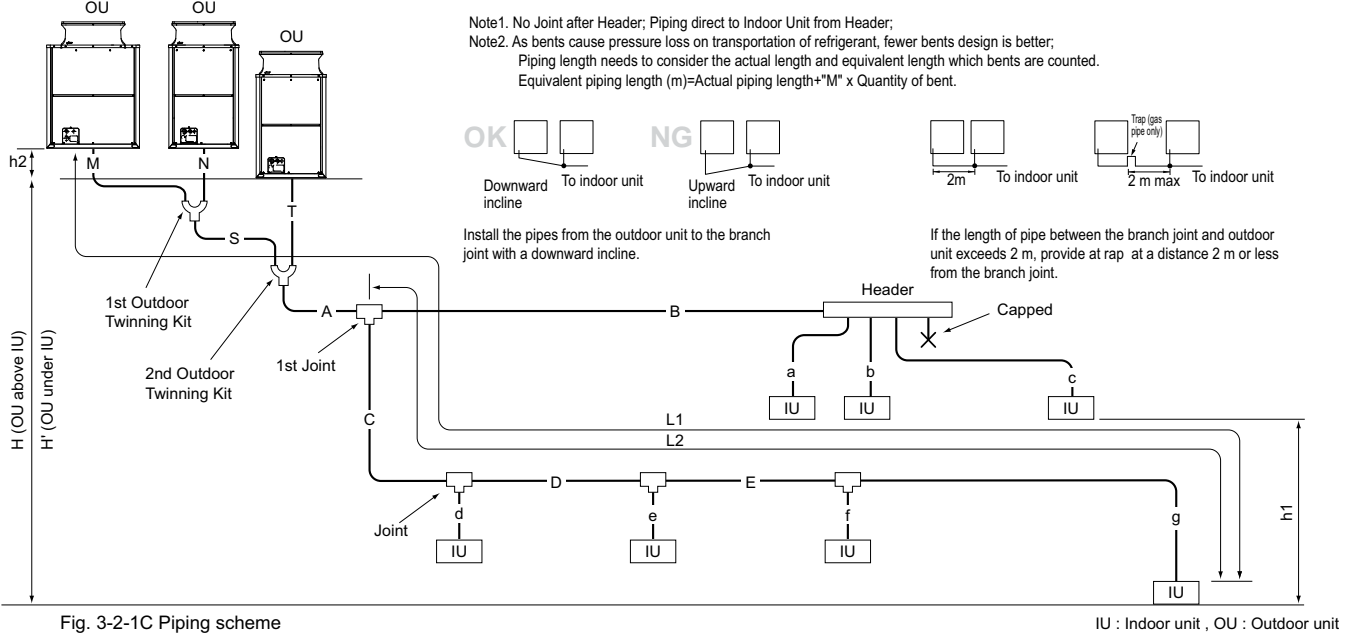

Fig. 3-2-1C Piping scheme

Piping length		(m [ft.])		Bent equivalent length "M"	
Item	Piping in the figure	Max. length	Max. equivalent length	Outdoor unit model	M (m/bent [ft./bent])
Total piping length	S+T+M+N+A+B+C+D+E+a+b+c+d+e+f+g	1000[3280']	-	PUHY-EP650YSLM-A	0.50 [1.64]
Distance between OU and OU	M+N+S+T	10[32']	-	PUHY-EP700YSLM-A	0.70 [2.29]
Height between OU and OU	h2	0.1[0.3']	-	PUHY-EP750YSLM-A	0.70 [2.29]
Farthest IU from OU (L1)	M(N)+S+A+C+D+E+g / M(N)+S+A+B+c	165[541']	190[623']	PUHY-EP800YSLM-A	0.70 [2.29]
Farthest IU from the first Joint (L2)	C+D+E+g / B+c	40[131'] *3	40[131']	PUHY-EP850YSLM-A	0.80 [2.62]
Height between OU and IU (OU above IU)	H	50[164'] *1	-	PUHY-EP900YSLM-A	0.80 [2.62]
Height between OU and IU (OU under IU)	H'	40[131'] *2	-	PUHY-EP950YSLM-A	0.80 [2.62]
Height between IU and IU	h1	15[49'] *4	-	PUHY-EP1000YSLM-A	0.80 [2.62]
				PUHY-EP1050YSLM-A	0.80 [2.62]
				PUHY-EP1100YSLM-A	0.80 [2.62]
				PUHY-EP1150YSLM-A	0.80 [2.62]
				PUHY-EP1200YSLM-A	0.80 [2.62]
				PUHY-EP1250YSLM-A	0.80 [2.62]
				PUHY-EP1300YSLM-A	0.80 [2.62]
				PUHY-EP1350YSLM-A	0.80 [2.62]

OU: Outdoor Unit, IU: Indoor Unit

- *1 90m is available depending on the model and installation conditions. For more detailed information, contact your local distributor.
- *2 60m is available depending on the model and installation conditions. For more detailed information, contact your local distributor.
- *3 90m is available. When the piping length exceeds 40m, use one size larger liquid pipe starting with the section of piping where 40m is exceeded and all piping after that point. In the figure above, if the piping labeled "E" exceeds 40 meters (but does not exceed 90 meters), increase the size of the liquid piping labeled E, f, and g by one size.
- *4 30m is available. If the height difference between indoor units exceeds 15 meters (but does not exceed 30 meters), use one-size larger pipes for indoor unit liquid pipes. In the figure above, if "h1" exceeds 15 meters, increase the size of the liquid piping labeled C, D, E, and g by one size.

Piping "A" size selection rule		(mm [in.])	
Outdoor unit	Twinning kit	Pipe(Liquid)	Pipe(Gas)
PUHY-EP650YSLM	CMY-Y300VBK3	ø15.88[5/8"]	ø28.58[1-1/8"]
PUHY-EP700-800YSLM	CMY-Y300VBK3	ø19.05[3/4"]	ø34.93[1-3/8"]
PUHY-EP850-1350YSLM	CMY-Y300VBK3	ø19.05[3/4"]	ø41.28[1-5/8"]

For Piping size "M", "N", "S", "T", please refer to specification of the Twinning kit CMY-Y300VBK3 at the Outdoor unit's external drawing.

Selection criteria for joints	
Total down-stream Indoor capacity	Joint
~ P200	CMY-Y102SS-G2
P201 ~ P400	CMY-Y102LS-G2
P401 ~ P650	CMY-Y202S-G2
P651 ~	CMY-Y302S-G2

*The total capacity of the units in the downstream of the branch joint on at least one of the piping lines that are connected to the branch joint should be 650 or below.
 If the total capacity of the units in the downstream of the branch joints on both lines is 650 or above use two branch joints (CMY-Y302S-G2).
 *Concerning detailed usage of Joint parts, refer to its Installation Manual.

See the table below for the first joint of the outdoor unit described below.

Outdoor unit model	Joint model
EP650	CMY-Y202S-G2
EP700 to EP1350	CMY-Y302S-G2

Piping "B", "C", "D", "E" size selection rule			(mm [in.])	
Total down-stream Indoor capacity	Pipe(Liquid)	Pipe(Gas)		
~ P140	ø9.52 [3/8"]	ø15.88 [5/8"]		
P141 ~ P200	ø9.52 [3/8"]	ø19.05 [3/4"]		
P201 ~ P300	ø9.52 [3/8"]	ø22.20 [7/8"]		
P301 ~ P400	ø12.70 [1/2"]	ø28.58 [1-1/8"]		
P401 ~ P650	ø15.88 [5/8"]	ø28.58 [1-1/8"]		
P651 ~ P800	ø19.05 [3/4"]	ø34.93 [1-3/8"]		
P801 ~	ø19.05 [3/4"]	ø41.28 [1-5/8"]		

Header selection rule			
	4-branch Header	8-branch Header	10-branch Header
	CMY-Y104-G	CMY-Y108-G	CMY-Y1010-G
Total down-stream Indoor capacity	<=P200	<=P400	<=P650

- * CMY-Y104-G can directly connect PUHY-EP200YLM, but can NOT directly connect PUHY-EP250YLM or above;
- * CMY-Y108-G can directly connect PUHY-EP200-500YLM, but can NOT directly connect PUHY-EP550YSLM or above;
- * CMY-Y1010-G can directly connect, PUHY-EP200-600Y(S)LM;
- * CMY-Y104-G can NOT connect P200, P250 Indoor, but CMY-Y108, Y1010-G can do;
- * Concerning detailed usage of Header parts, refer to its Installation Manual.

Piping "a", "b", "c", "d", "e", "f", "g" size selection rule			(mm [in.])	
Indoor Unit size	Pipe(Liquid)	Pipe(Gas)		
P20, P25, P32, P40, P50, GUF-50RD(H)	ø6.35 [1/4"]	ø12.70 [1/2"]		
P63, P71, P80, P100, P125, P140, GUF-100RD(H)	ø9.52 [3/8"]	ø15.88 [5/8"]		
P200	ø9.52 [3/8"]	ø19.05 [3/4"]		
P250	ø9.52 [3/8"]	ø22.20 [7/8"]		

- Note3. Indoor capacity is described as its model size;
 For example, PEFY-P32VMA-E, its capacity is P32;
- Note4. Total down-stream Indoor capacity is the summary of the model size of Indoors downstream.
 For example, PEFY-P25VMA-E+PEFY-P32VMA-E: Total Indoor capacity=P25+P32=P57
- Note5. Piping sized determined by the Total down-stream indoor capacity is NOT necessary to be bigger than the up-stream one.
 i.e. A>=B; A>=C>=D

3-3. Refrigerant charging calculation

PUHY-P-YKB-A1

At the time of shipping, the outdoor unit is charged with the refrigerant. As this charge does not include the amount needed for extended piping, additional charging for each refrigerant line will be required on site. In order that future servicing may be properly provided, always keep a record of the size and length of each refrigerant line and the amount of additional charge by writing it in the space provided on the outdoor unit.

(1) Calculation of additional refrigerant charge

- Calculate the amount of additional charge based on the length of the piping extension and the size of the refrigerant line.
- Use the table below as a guide to calculate the amount of additional charging and charge the system accordingly.
- If the calculation results in a fraction of less than 0.1kg, round up to the next 0.1kg. For example, if the result of the calculation was 12.33kg, round the result up to 12.4kg.
- * When connecting one or more PEFY-P20VMA3-E units, add 0.54 kg of refrigerant for each of these units.

<Additional Charge>

Units "m" and "kg"

<Formula>

- When the piping length from the outdoor unit to the farthest indoor unit is 30.5 m (100 ft) or shorter

$$\text{Amount of additional charge (kg)} = \begin{matrix} \text{ø19.05 total length} \\ \times 0.29 \text{ (kg/m)} \end{matrix} + \begin{matrix} \text{ø15.88 total length} \\ \times 0.2 \text{ (kg/m)} \end{matrix} + \begin{matrix} \text{ø12.7 total length} \\ \times 0.12 \text{ (kg/m)} \end{matrix} + \begin{matrix} \text{ø9.52 total length} \\ \times 0.06 \text{ (kg/m)} \end{matrix} + \begin{matrix} \text{ø6.35 total length} \\ \times 0.024 \text{ (kg/m)} \end{matrix}$$

Outdoor unit model	Amount (kg)	Total capacity of connected indoor units	Amount (kg)
P200	0	80 or below	2.0
P250	0	81 to 160	2.5
P300	0	161 to 330	3.0
P350	0	331 to 390	3.5
P400	0	391 to 480	4.5
P450	0	481 to 630	5.0
P500	0	631 to 710	6.0
		711 to 800	8.0
		801 to 890	9.0
		891 to 1070	10.0
		1071 to 1250	12.0
		1251 or above	14.0

- When the piping length from the outdoor unit to the farthest indoor unit is longer than 30.5 m (100 ft)

$$\text{Amount of additional charge (kg)} = \begin{matrix} \text{ø19.05 total length} \\ \times 0.26 \text{ (kg/m)} \end{matrix} + \begin{matrix} \text{ø15.88 total length} \\ \times 0.18 \text{ (kg/m)} \end{matrix} + \begin{matrix} \text{ø12.7 total length} \\ \times 0.11 \text{ (kg/m)} \end{matrix} + \begin{matrix} \text{ø9.52 total length} \\ \times 0.054 \text{ (kg/m)} \end{matrix} + \begin{matrix} \text{ø6.35 total length} \\ \times 0.021 \text{ (kg/m)} \end{matrix}$$

Outdoor unit model	Amount (kg)	Total capacity of connected indoor units	Amount (kg)
P200	0	80 or below	2.0
P250	0	81 to 160	2.5
P300	0	161 to 330	3.0
P350	0	331 to 390	3.5
P400	0	391 to 480	4.5
P450	0	481 to 630	5.0
P500	0	631 to 710	6.0
		711 to 800	8.0
		801 to 890	9.0
		891 to 1070	10.0
		1071 to 1250	12.0
		1251 or above	14.0

Example: PUHY-P350YKB-A1

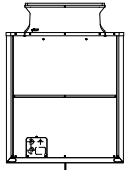

Indoor 1:	P125	A: ø12.7	40 m	a: ø9.52	10 m
2:	P100	B: ø9.52	10 m	b: ø9.52	5 m
3:	P40	C: ø9.52	15 m	c: ø6.35	10 m
4:	P32	D: ø9.52	10 m	d: ø9.52	10 m
5:	P63	e: ø12.7	10 m		

The total length of liquid pipe of each size is as follows:
 ø12.7: A + e = 40 + 10 = 50 m
 ø9.52: B + C + D + a + b + d = 10 + 15 + 10 + 10 + 5 + 10 = 60 m
 ø6.35: c = 10 = 10 m

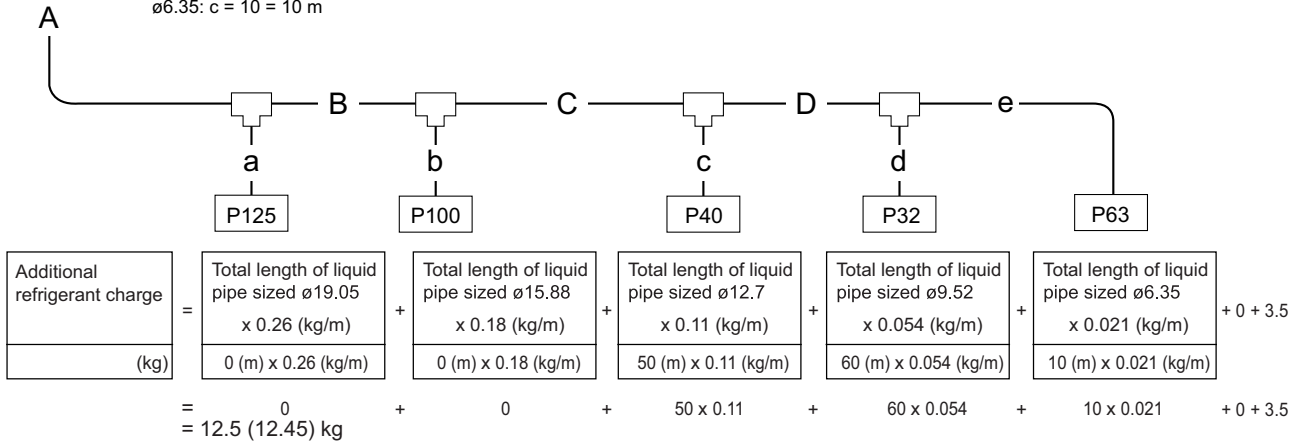

Amount of factory charged refrigerant

Outdoor unit model	Charged amount
P200	6.5kg
P250	8.0kg
P300	11.5kg
P350	
P400	
P450	11.8kg
P500	

Maximum refrigerant charge

There is a limit to the amount of refrigerant that can be charged into a unit. Regardless of the amount yielded by the formula above, observe the maximum refrigerant charge in the table below.

Total index of the outdoor units	P200YKB-A1	P250YKB-A1	P300YKB-A1	P350YKB-A1	P400YKB-A1	P450YKB-A1	P500YKB-A1	P400YSKB-A1	P450YSKB-A1	P500YSKB-A1	P550YSKB-A1
Maximum *1 refrigerant charge	22.3kg	29.7kg	32.7kg	33.6kg	37.2kg	45.0kg	45.9kg	45.0kg	45.9kg	47.0kg	51.3kg

Total index of the outdoor units	P600YSKB-A1	P650YSKB-A1	P700YSKB-A1	P750YSKB-A1	P800YSKB-A1	P850YSKB-A1	P900YSKB-A1	P950YSKB-A1	P1000YSKB-A1	P1050YSKB-A1	P1100YSKB-A1
Maximum *1 refrigerant charge	53.9kg	56.5kg	68.9kg	68.9kg	71.4kg	73.2kg	75.7kg	96.9kg	99.9kg	102.9kg	106.0kg

Total index of the outdoor units	P1150YSKB-A1	P1200YSKB-A1	P1250YSKB-A1	P1300YSKB-A1	P1350YSKB-A1
Maximum *1 refrigerant charge	109.0kg	112.0kg	112.0kg	112.0kg	112.0kg

*1 Maximum refrigerant charge: the amount of factory-charged refrigerant and the amount of refrigerant to be added on site

PUHY-EP-YLM-A

At the time of shipping, the outdoor unit is charged with the refrigerant. As this charge does not include the amount needed for extended piping, additional charging for each refrigerant line will be required on site. In order that future servicing may be properly provided, always keep a record of the size and length of each refrigerant line and the amount of additional charge by writing it in the space provided on the outdoor unit.

(1) Calculation of additional refrigerant charge

- Calculate the amount of additional charge based on the length of the piping extension and the size of the refrigerant line.
- Use the table below as a guide to calculate the amount of additional charging and charge the system accordingly.
- If the calculation results in a fraction of less than 0.1kg, round up to the next 0.1kg. For example, if the result of the calculation was 12.33kg, round the result up to 12.4kg.

<Additional Charge>

Units "m" and "kg"

<Formula>

- When the piping length from the outdoor unit to the farthest indoor unit is 30.5 m (100 ft) or shorter

$$\text{Amount of additional charge (kg)} = \begin{matrix} \text{ø19.05 total length} \\ \times 0.29 \text{ (kg/m)} \end{matrix} + \begin{matrix} \text{ø15.88 total length} \\ \times 0.2 \text{ (kg/m)} \end{matrix} + \begin{matrix} \text{ø12.7 total length} \\ \times 0.12 \text{ (kg/m)} \end{matrix} + \begin{matrix} \text{ø9.52 total length} \\ \times 0.06 \text{ (kg/m)} \end{matrix} + \begin{matrix} \text{ø6.35 total length} \\ \times 0.024 \text{ (kg/m)} \end{matrix}$$

Outdoor unit model	Amount (kg)	Total capacity of connected indoor units	Amount (kg)
EP200	0	80 or below	2.0
EP250	0	81 to 160	2.5
EP300	0	161 to 330	3.0
EP350	0	331 to 390	3.5
EP400	2.0	391 to 480	4.5
EP450	2.0	481 to 630	5.0
EP500	2.0	631 to 710	6.0
		711 to 800	8.0
		801 to 890	9.0
		891 to 1070	10.0
		1071 to 1250	12.0
		1251 or above	14.0

- When the piping length from the outdoor unit to the farthest indoor unit is longer than 30.5 m (100 ft)

$$\text{Amount of additional charge (kg)} = \begin{matrix} \text{ø19.05 total length} \\ \times 0.26 \text{ (kg/m)} \end{matrix} + \begin{matrix} \text{ø15.88 total length} \\ \times 0.18 \text{ (kg/m)} \end{matrix} + \begin{matrix} \text{ø12.7 total length} \\ \times 0.11 \text{ (kg/m)} \end{matrix} + \begin{matrix} \text{ø9.52 total length} \\ \times 0.054 \text{ (kg/m)} \end{matrix} + \begin{matrix} \text{ø6.35 total length} \\ \times 0.021 \text{ (kg/m)} \end{matrix}$$

Outdoor unit model	Amount (kg)	Total capacity of connected indoor units	Amount (kg)
EP200	0	80 or below	2.0
EP250	0	81 to 160	2.5
EP300	0	161 to 330	3.0
EP350	0	331 to 390	3.5
EP400	2.0	391 to 480	4.5
EP450	2.0	481 to 630	5.0
EP500	2.0	631 to 710	6.0
		711 to 800	8.0
		801 to 890	9.0
		891 to 1070	10.0
		1071 to 1250	12.0
		1251 or above	14.0

Example: PUHY-EP400YLM-A

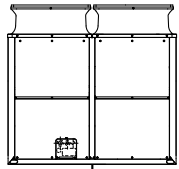

m [kg]					
Indoor	1: P125	A: ø12.7	40 m	a: ø9.52	10 m
	2: P100	B: ø9.52	10 m	b: ø9.52	5 m
	3: P40	C: ø9.52	15 m	c: ø6.35	10 m
	4: P32	D: ø9.52	10 m	d: ø9.52	10 m
	5: P63			e: ø12.7	10 m

The total length of liquid pipe of each size is as follows:
 ø12.7: A + e = 40 + 10 = 50 m
 ø9.52: B + C + D + a + b + d = 10 + 15 + 10 + 10 + 5 + 10 = 60 m
 ø6.35: c = 10 = 10 m

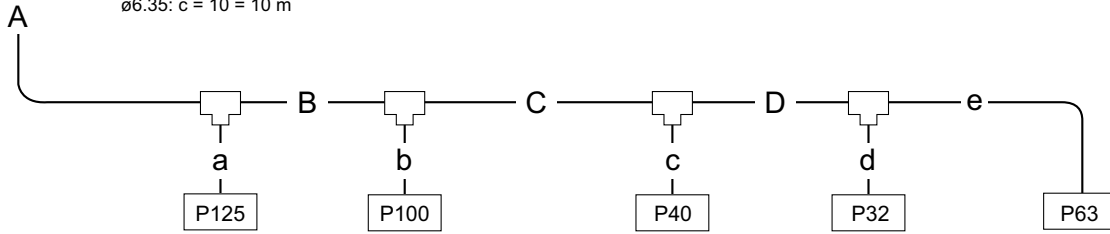

m [kg]	Additional refrigerant charge (kg)	Total length of liquid pipe sized ø19.05 x 0.26 (kg/m)	Total length of liquid pipe sized ø15.88 x 0.18 (kg/m)	Total length of liquid pipe sized ø12.7 x 0.11 (kg/m)	Total length of liquid pipe sized ø9.52 x 0.054 (kg/m)	Total length of liquid pipe sized ø6.35 x 0.021 (kg/m)	
		0 (m) x 0.26 (kg/m)	0 (m) x 0.18 (kg/m)	50 (m) x 0.11 (kg/m)	60 (m) x 0.054 (kg/m)	10 (m) x 0.021 (kg/m)	+ 2.0 + 3.5
		= 0	= 0	= 50 x 0.11	= 60 x 0.054	= 10 x 0.021	+ 2.0 + 3.5
							= 14.5 (14.45) kg

Amount of factory charged refrigerant

Outdoor unit model	Charged amount
EP200 EP250	7.5kg
EP300 EP350	10.3kg
EP400 EP450 EP500	11.8kg

Maximum refrigerant charge

There is a limit to the amount of refrigerant that can be charged into a unit. Regardless of the amount yielded by the formula above, observe the maximum refrigerant charge in the table below.

Total index of the outdoor units	EP200YLM	EP250YLM	EP300YLM	EP350YLM	EP400YLM	EP450YLM	EP500YLM	EP550YSLM	EP600YSLM	EP650YSLM	EP700YSLM	EP750YSLM
Maximum *1 refrigerant charge	22.3kg	29.7kg	32.7kg	33.6kg	37.2kg	45.0kg	45.9kg	51.3kg	53.9kg	56.5kg	68.9kg	68.9kg

Total index of the outdoor units	EP800YSLM	EP850YSLM	EP900YSLM	EP950YSLM	EP1000YSLM	EP1050YSLM	EP1100YSLM	EP1150YSLM	EP1200YSLM	EP1250YSLM	EP1300YSLM	EP1350YSLM
Maximum *1 refrigerant charge	71.4kg	73.2kg	75.7kg	75.7kg	80.7kg	80.7kg	80.7kg	80.7kg	83.8kg	83.8kg	87.0kg	87.0kg

*1 Maximum refrigerant charge: the amount of factory-charged refrigerant and the amount of refrigerant to be added on site

4-1. Requirement on installation site

1. No direct thermal radiation to the unit.
2. No possibility of annoying the neighbors by the sound of the unit.

Valves and refrigerant flow on the outdoor unit may generate noise.

3. Avoid the sites where strong winds blow.
4. With strength to bear the weight of the unit.
5. Drain flow from the unit is cared at heating mode.
6. Enough space for installation and service as shown at 4-2.
7. Avoid the sites where acidic solutions or chemical sprays (sulfur series) are used frequently.
8. The unit should be secure from combustible gas, oil, steam, chemical gas like acidic solution, sulfur gas and so on.

4-2. Spacing

In case of single installation

- Secure enough space around the unit as shown in the figure.
- If the wall height exceeds the height limit, widen the space labeled "L" and "W" by the amount that exceeds the limit (labeled h in the figure).

(1) Walls are lower than the height limit.

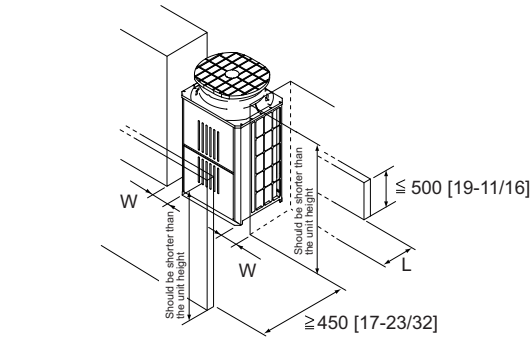

Condition	L	W
Minimum space behind the unit	≥ 100 [3-15/16]	≥ 50 [1-31/32]
Minimum space on both sides of the unit	≥ 300 [11-13/16]	≥ 15 [19/32]

(2) If the wall height (H) of the front, rear or side exceeds the wall height restriction

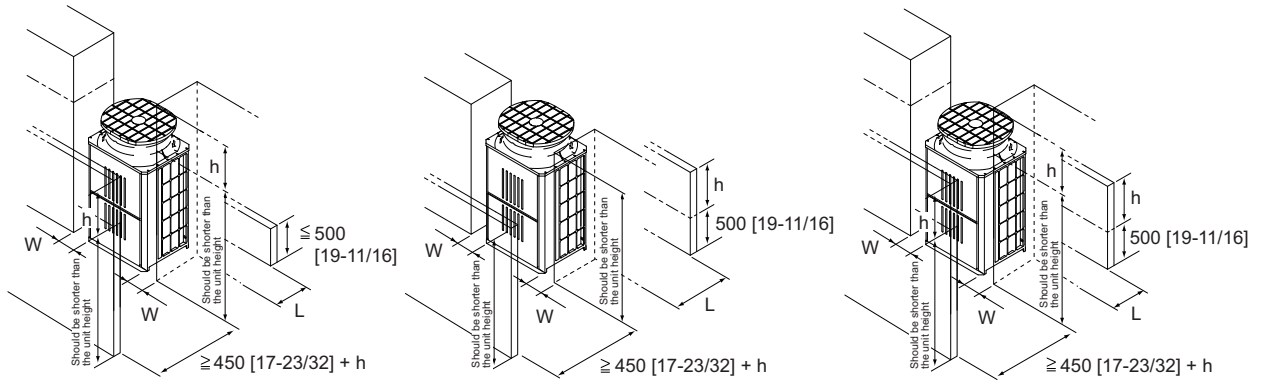

Condition	L	W
Minimum space behind the unit	≥ 100 [3-15/16] + h	≥ 50 [1-31/32] + h
Minimum space on both sides of the unit	≥ 300 [11-13/16] + h	≥ 15 [19/32] + h

(3) If there are obstacles at the upper part of the unit

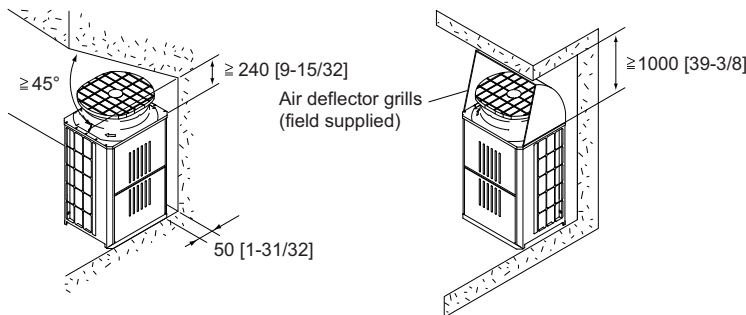

(Unit : mm [in.])

In case of collective installation and continuous installation

- When multiple units are installed adjacent to each other, secure enough space to allow for air circulation and passageways between groups of units as shown in the figures.
* Leave both sides of each group of units open.
- As with single installation, if the wall height exceeds the height limit, widen the space in the front and the back of a given group of units by the amount that exceeds the limit (labeled h in the figure).
- If there is a wall at both the front and the rear of the unit, install up to six units (three units: P450, 500, EP400, 450, 500) consecutively in the side direction and provide a space of 1000mm or more as inlet space/passage space for each six units (three units: P450, 500, EP400, 450, 500).

(1) Side-by-side installation

<The space on both sides of a given group of units is minimum.>

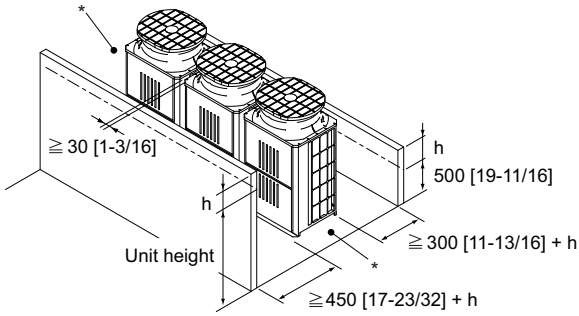

<The space on both sides of a given group of units is minimum.>

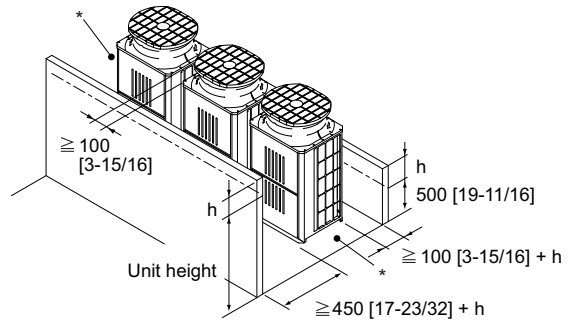

(2) Face-to-face installation

<There are walls in the front and the back of a given group of units.>

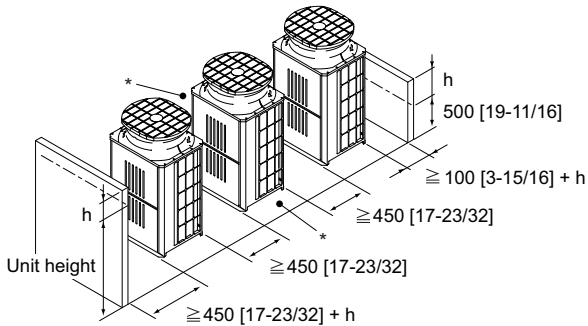

<There is a wall on one side.>

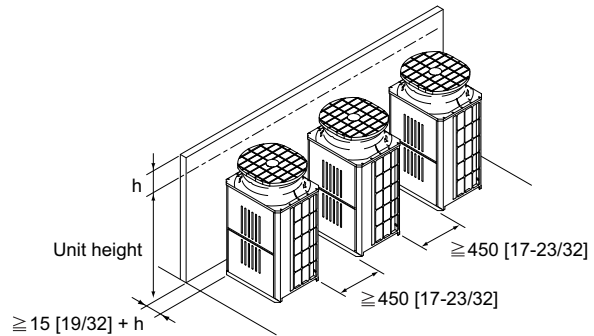

(3) Combination of face-to-face and side-by-side installations

<There are walls in the front and the back of a given group of units.>

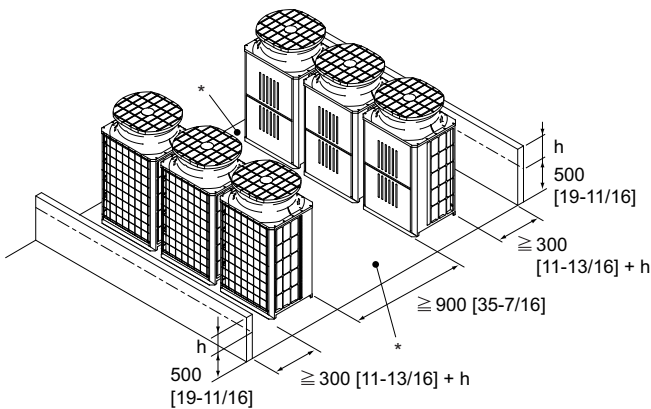

<There is a wall on one side and either the front or the back of a given group of unit.>

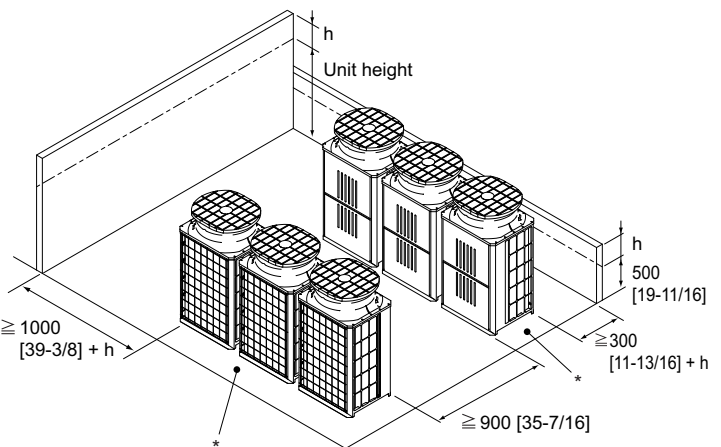

(Unit : mm [in.])

4-3. Piping direction

4-3-1. Lifting method

- When lifting the unit with ropes, run the ropes under the unit and use the lifting hole.
- Support the unit at four points with two ropes, and avoid giving mechanical shock.
- Suspension rope angle must be 40° or less, so as to avoid compressing fan guard.
- Use two ropes, each at least 8m [26 ft.] in length
- Use ropes strong enough to support the weight of the unit.
- Always suspend the unit from four corners. (It is dangerous to suspend a unit from two corners and must not be attempted.)
- Use protective pads to keep the ropes from scratching the panels on the unit.
- Use a 50mm [1-31/32 in.] or thicker cardboard or cloth as a protective pad on the top of the unit to prevent contact between the fan guard and slings.

① P200, 250
EP200, 250

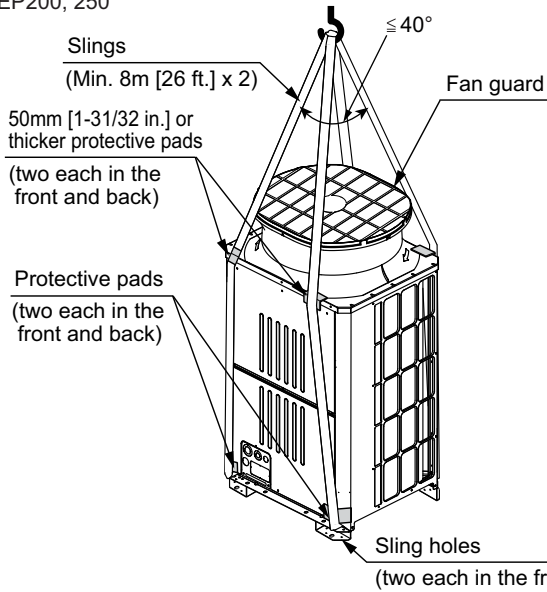

② P300, 350, 400
EP300, 350

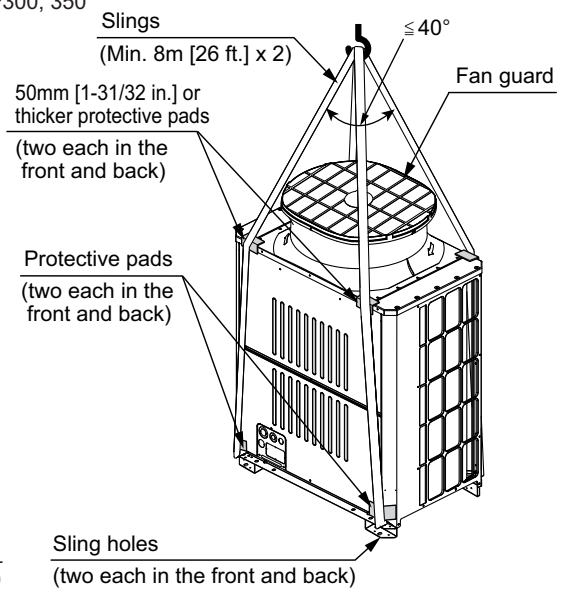

③ P450, 500
EP400, 450, 500

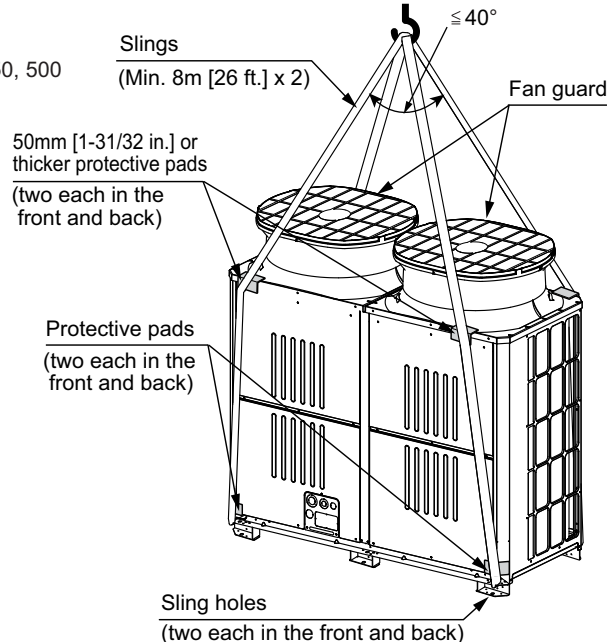

CAUTION

Exercise caution when transporting products.

- Products weighing more than 20 kg [45 LBS] should not be carried alone.
- Do not carry the product by the PPbands.
- To avoid the risk of injury, do not touch the heat exchanger fins.
- Plastic bags may pose a risk of choking hazard to children. Tear plastic bags into pieces before disposing of them.
- When lifting and transporting outdoor units with ropes, run the ropes through lifting hole at the unit base. Securely fix the unit so that the ropes will not slide off, and always lift the unit at four points to prevent the unit from falling.

4-3-2. Installation

- Secure the unit with anchor bolts as shown in the figure below so that the unit will not topple over with strong wind or during an earthquake.
- Install the unit on a durable base made of such materials as concrete or angle steel.
- Take appropriate anti-vibration measures (e.g., vibration damper pad, vibration isolation base) to keep vibrations and noise from being transmitted from the unit through walls and floors.
- When using a rubber cushion, install it so that the cushion covers the entire width of the unit leg.
- Install the unit in such a way that the corner of the angle bracket at the base of the unit shown in the figure below is securely supported.
- Install the anchor bolt in such a way that the top end of the anchor bolt do not stick out more than 30 mm [1-3/16 in.].
- This unit is not designed to be anchored with post-installation-type anchor bolts, although by adding fixing brackets anchoring with such type of anchor bolts becomes possible.

- (A) : M10 anchor bolt procured at the site.
- (B) : Corner is not seated.
- (C) : Fixing bracket for hole-in anchor bolt (3 locations to fix with screws).
- (D) : Detachable leg

<Without detachable leg>

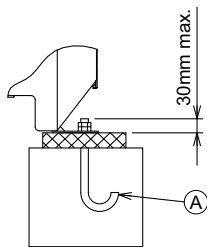

Install the unit in such a way that the corner of the angle bracket at the base of the unit shown in the figure is securely supported. The brackets may bend if they are not securely supported.

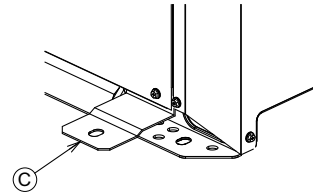
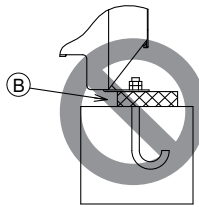

<With detachable leg>

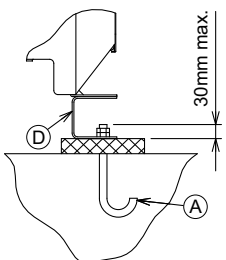

Install the unit in such a way that the corner of the angle bracket at the base of the unit shown in the figure is securely supported. The brackets may bend if they are not securely supported.

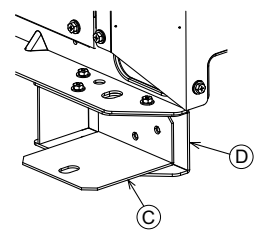
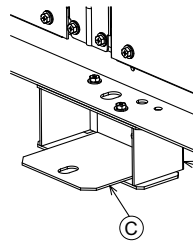
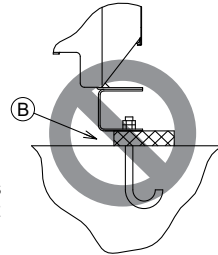

⚠ WARNING
 Properly install the unit on a surface that can withstand the weight of the unit. Unit installed on an unstable surface may fall and cause injury.

⚠ WARNING
 Take appropriate safety measures against strong winds and earthquakes to prevent the unit from falling.

Take into consideration the durability of the base, water drainage route (Drain water is discharged from outdoor units during operation.), piping route, and wiring route when performing foundation work.

4-3-3. Anchor bolt positions

<P200-400, EP200-350>

- Individual installation

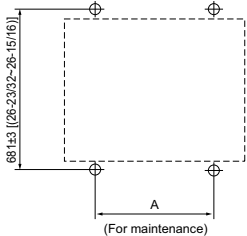

- Collective installation

(Unit : mm [in.])

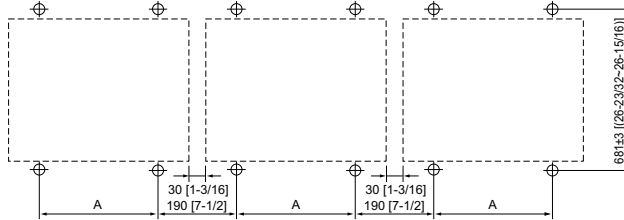

PUHY	P200, 250/EP200, 250
A	760±2 [29-15/16(29-27/32~30)]

PUHY	P300, 350, 400/EP300, 350
A	1060±2 [41-3/4(41-21/32~41-13/16)]

<P450-500, EP400-500>

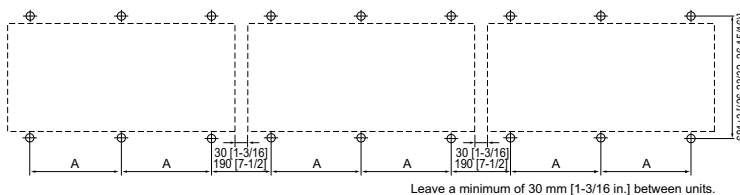
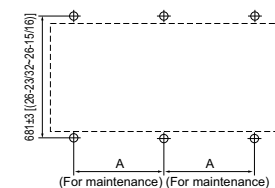

PUHY	P450, 500/EP400, 450, 500
A	795±2 [31-5/16(31-1/4~31-13/32)]

4-3-4. Installation

When the pipes and/or cables are routed at the bottom of the unit, make sure that the through hole at the base of the unit does not get blocked with the installation base.

When the pipes are routed at the bottom of the unit, the base should be at least 100 mm [3-15/16 in.] in height.

·P200, 250
EP200, 250

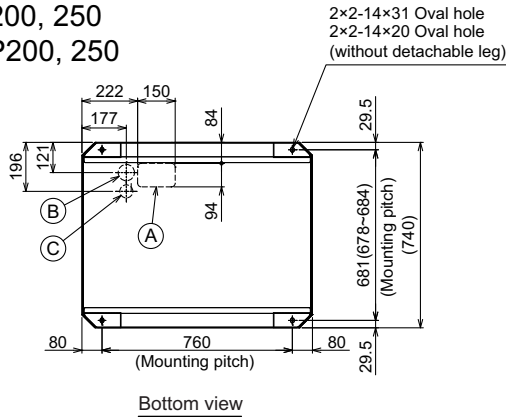

·P300, 350, 400
EP300, 350

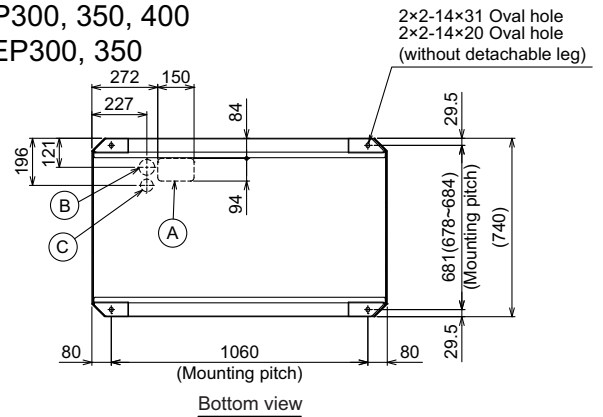

·P450, 500
EP400, 450, 500

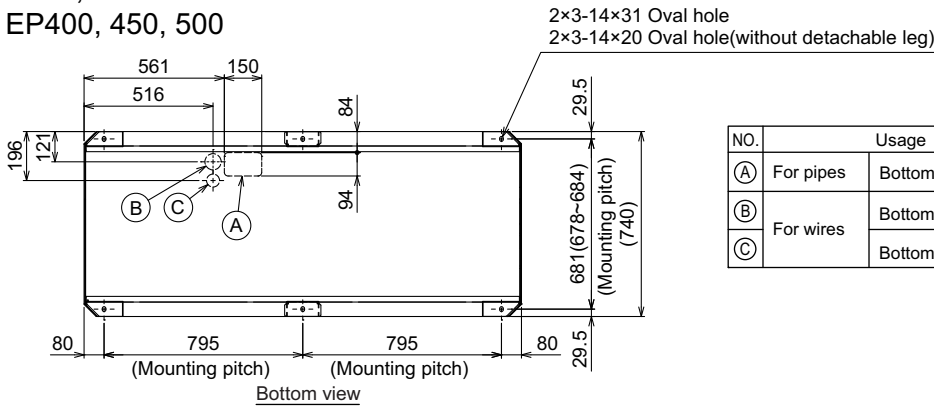

(Unit : mm [in.])

NO.	Usage	Specifications
(A)	For pipes Bottom through hole	150 × 94 Knockout hole (5-29/32) (3-23/32)
(B)	For wires Bottom through hole	Ø65 Knockout hole (2-9/16)
(C)		Ø52 Knockout hole (2-1/16)

Installation base parallel to the unit's front panel

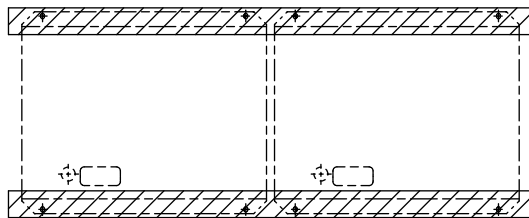

Installation base perpendicular to the unit's front panel

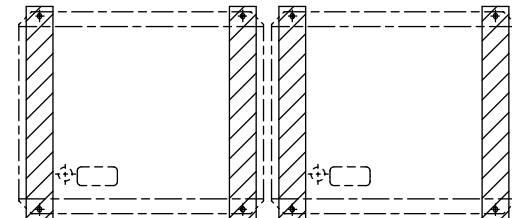

4-3-5. Refrigerant pipe routing

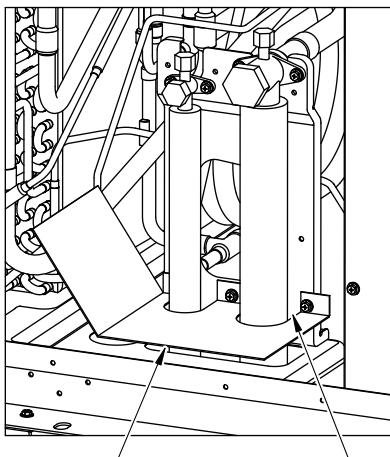

Example of closure materials (field supply) Fill the gap at the site

The gaps around the edges of through holes for pipes and wires on the unit allow water or mice to enter the unit and damage its parts. Close these gaps with filler plates.

This unit allows two types of pipe routing:

- Bottom piping
- Front piping

CAUTION

To prevent small animals, water and snow from entering the unit and damage its parts, close the gap around the edges of through holes for pipes and wires with filler plates.

4-3-6. Twinning on the outdoor unit side

- The tilt angle of the twinning pipe
The tilt angle of the twinning pipe must be within $\pm 15^\circ$ with the horizontal plane.
Tilting the twinning pipe more than specified will cause damage to the unit.
- The length of the straight part of the pipe before the branching
For the twinning kit, always use the accessory piping parts.
The length of the straight part of pipe connected in front of the twinning pipe must be 500 mm [19-11/16 in.] or longer.
(Connect the field piping so that the length of the straight part of pipe connected in front of the twinning pipe can be 500 mm [19-11/16 in.] or longer.)
If the length is less than 500 mm [19-11/16 in.], it will cause damage to the unit.

Note: See the following drawing for the fitting position of the twinning pipe.

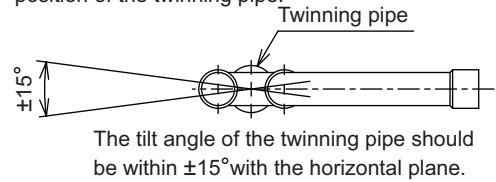

• Precautions for outdoor unit combinations

<A> Install the piping so that oil will not accumulate in the stopped outdoor unit.

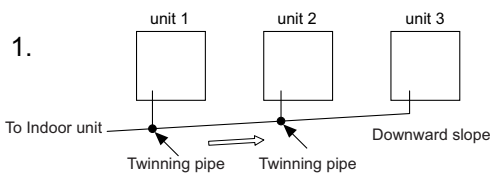

The NG example shows that oil accumulates because the units are installed on a reverse gradient while unit 1 is in operation, and unit 3 is stopped.

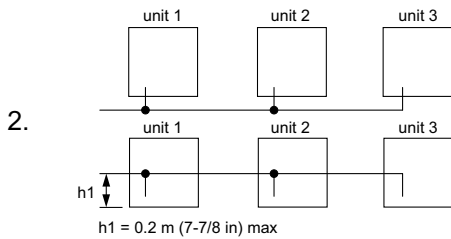
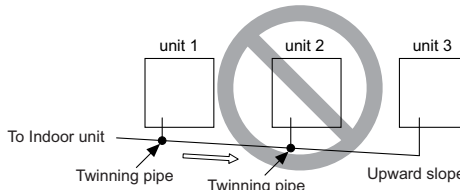

The NG example shows that oil accumulates into units 1 and 2 while unit 3 is in operation, and units 1 and 2 are stopped. Vertical pipe height (h) should be 0.2 m (7-7/8 in) or below.

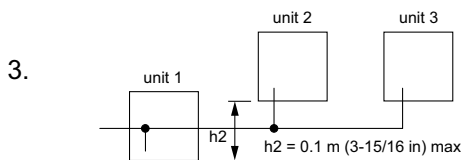
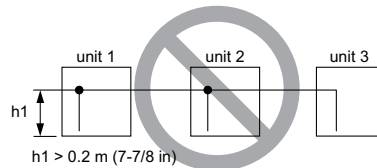

The NG example shows that oil accumulates into unit 1 while unit 3 is in operation, and unit 1 is stopped. Vertical pipe height (h) should be 0.2 m (7-7/8 in) or below.

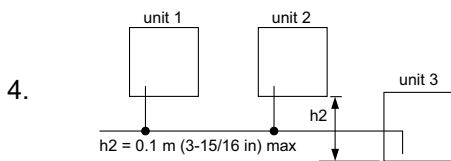
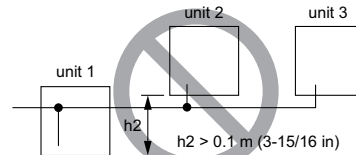

The NG example shows that oil accumulates into unit 3 while unit 1 is in operation, and unit 3 is stopped. Vertical pipe height (h) should be 0.2 m (7-7/8 in) or below.

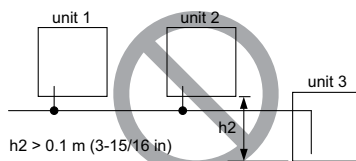

 When the piping on the outdoor unit side (from the twinning pipe) exceeds 2 m [6 ft], ensure a trap (gas pipe only) within 2 m [6 ft].

Make sure the height of the trap is 200 mm [7-7/8 in] or more.

If there is no trap, oil can accumulate inside the pipe, causing a shortage of oil and may damage the compressor.

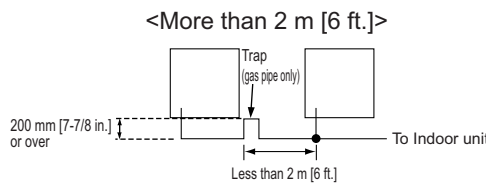
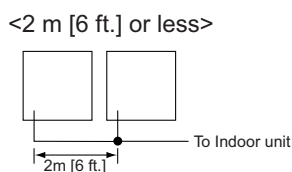

Caution:

- Do not install traps other than the ones between outdoor units described on a separate sheet to prevent oil backflow and compressor start-up failure.
- Do not install solenoid valves to prevent oil backflow and compressor start-up failure.
- Do not install a sight glass because it may show improper refrigerant flow.
If a sight glass is installed, inexperienced technicians that use the glass may overcharge the refrigerant.

<PUHY-P550YSKB-A1>
<PUHY-EP550YSLM-A>

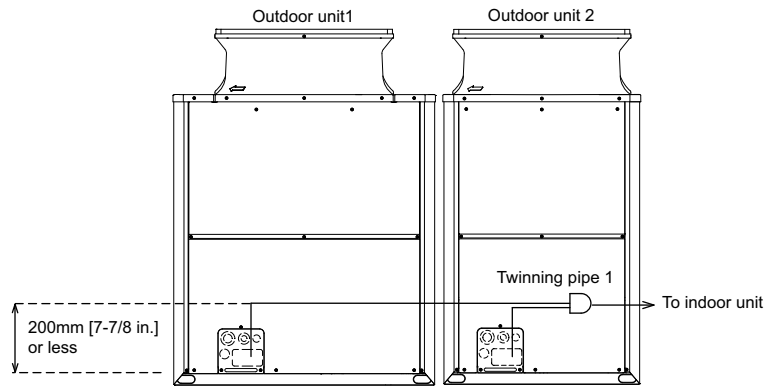

<PUHY-P950YSKB-A1>
<PUHY-EP800YSLM-A>

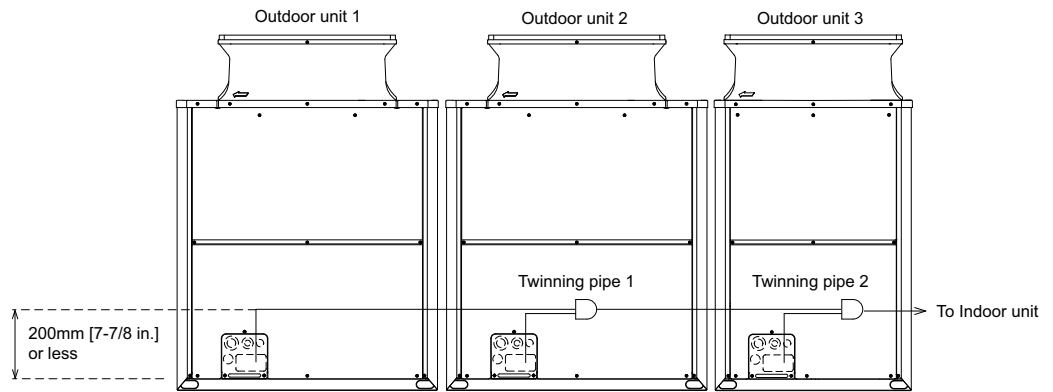

4-3-7. Twinning on the outdoor unit side

See the following drawing for connecting the pipes between the outdoor units.

<In case of 2units combination>

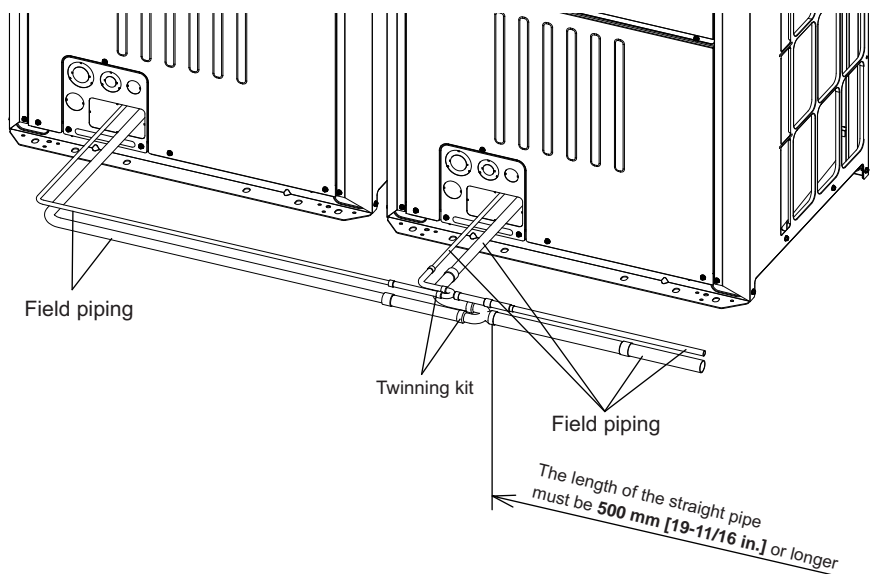

<In case of 3units combination>

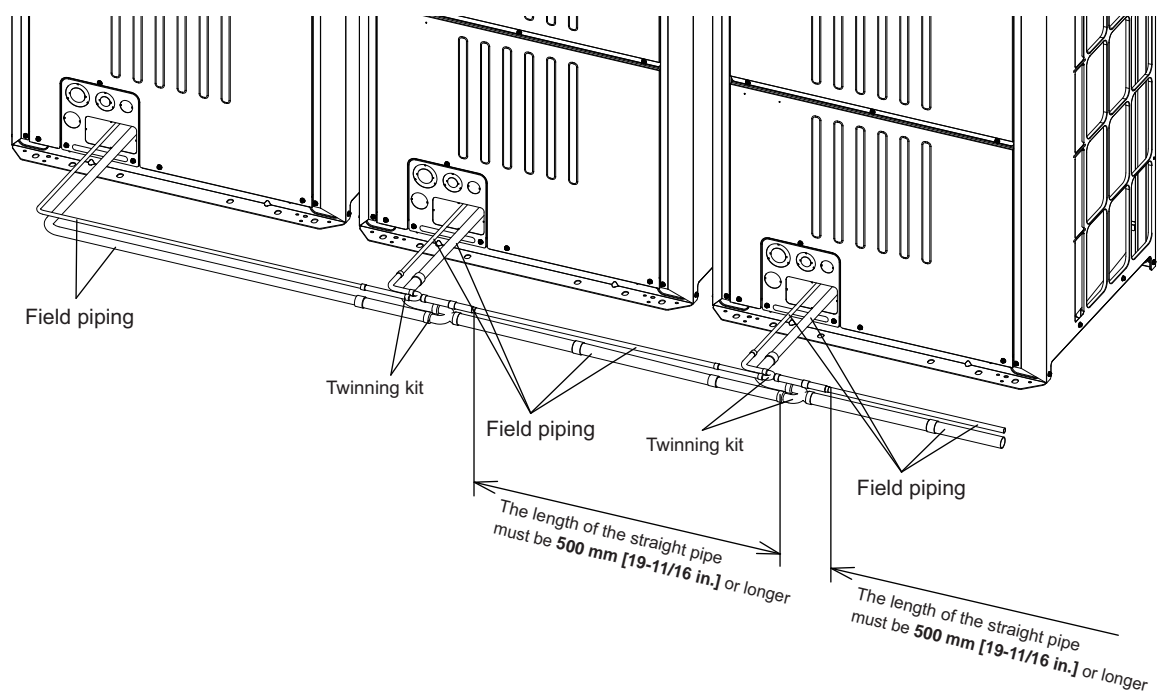

CAUTION

The length of the straight pipe must be 500mm[19-11/16 in.] or longer.
If not, it may cause improper operation.

4-4. Weather countermeasure

In cold and/or snowy areas, sufficient countermeasures to wind and snow damages should be taken for operating unit in normal and good condition in winter time. Surround the units with snow nets or fences to protect them from snow. Even in the other areas, full consideration is required for installation of unit in order to prevent abnormal operations caused by wind or snow. **When rain and snow directly fall on unit in the case of air-conditioning operations in 10 or less degrees centigrade outdoor air (50 or less degrees fahrenheit outdoor air), mount inlet and outlet ducts on unit for assuring stable operations.**

Countermeasure to snow and wind

Prevention the Outdoor unit from wind and snow damages in cold or snowy areas, snow hood shown below is recommended and helpful.

*Do not use a snow hood made of stainless steel, which may cause the unit to rust. If the use of a stainless snow hood is the only option, contact the sales office before installing it.

- Snow hood

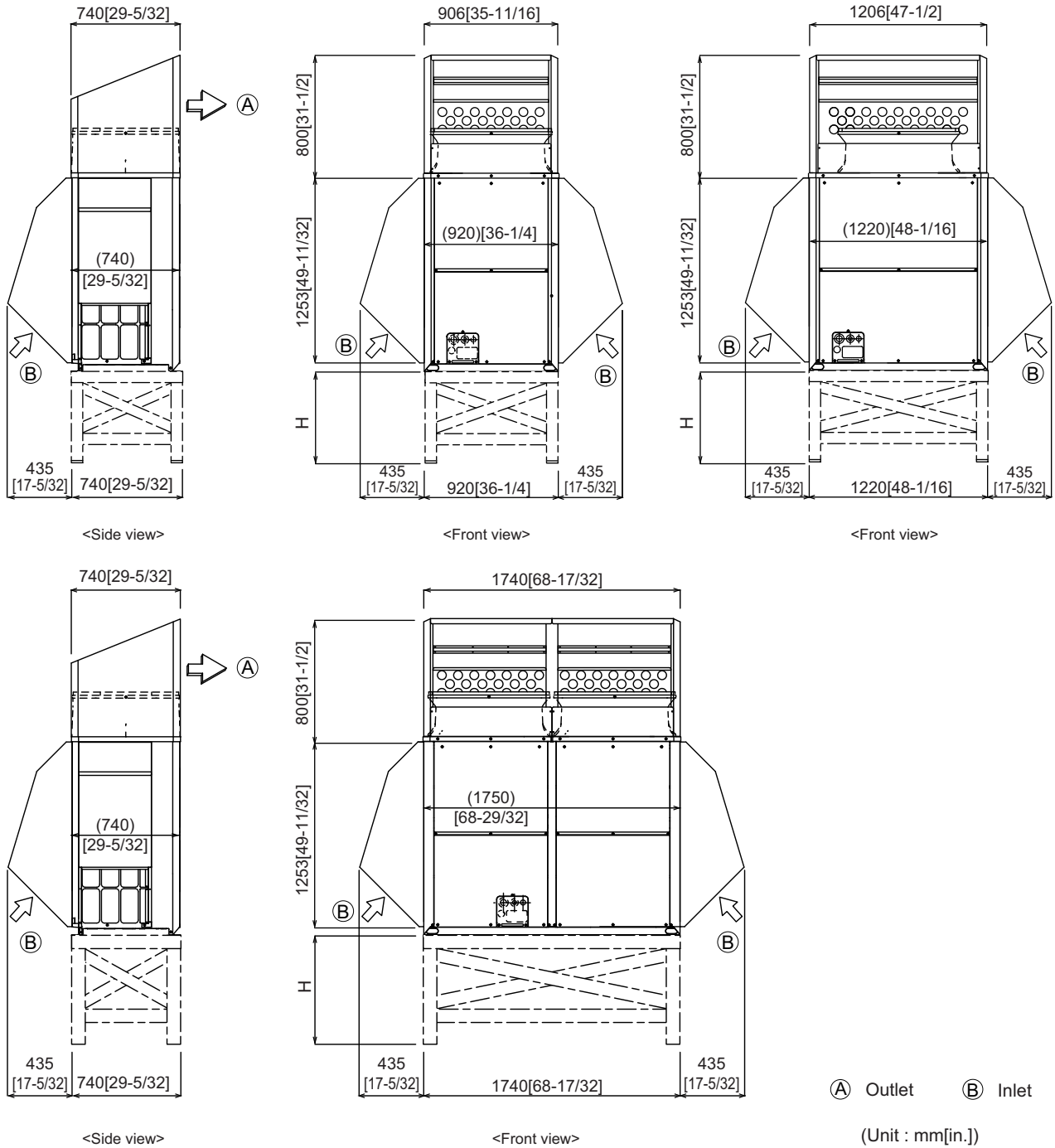

Note:

1. Height of frame base for snow damage prevention (H) shall be twice as high as expected snowfall. Width of frame base shall not exceed that of the unit. The frame base shall be made of angle steel, etc., and designed so that snow and wind slip through the structure. (If frame base is too wide, snow will be accumulated on it.)
2. Install unit so that wind will not directly lash against openings of inlet and outlet ducts.
3. Build frame base at customer referring to this figure.
 Material : Galvanized steel plate 1.2T [1/16 in. T]
 Painting : Overall painting with polyester powder
 Color : Munsell 5Y8/1 (same as that of unit)
4. To install units side by side, install a filler plate between the fan guard and the outlet-side snow food as shown in Figure A.
 (The filler plate provided accommodates the installation pitch of between 30-80 mm [1-3/16~3-5/32 in.])
5. When the unit is used in a cold region and the heating operation is continuously performed for a long time when the outside air temperature is below freezing, install a heater to the unit base or take other appropriate measures to prevent water from freezing on the base.

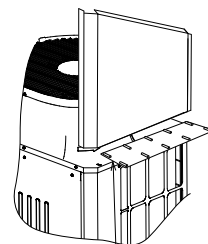
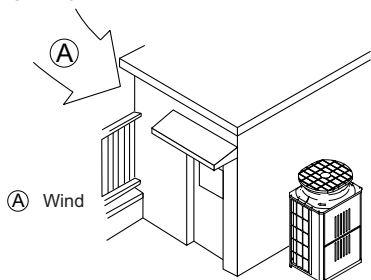

Figure A Filler plate

Countermeasure to wind

Referring to the figure shown below, take appropriate measures which will suit the actual situation of the place for installation. A unit installed alone is vulnerable to strong winds. Select the installation site carefully to minimize the effect of winds. To install a unit in a place where the wind always blows from the same direction, install the unit so that the outlet faces away from the direction of the wind.



Install the outdoor unit where seasonal winds do not blow directly against the unit, such as behind a building.

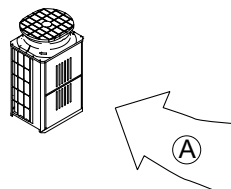

Install the outdoor unit to avoid having seasonal winds against the front of air outlet/inlet on the unit.

4-5. Caution on selecting outdoor units

Consult your dealer when the following issues on Y system are the key concern.

- **Warm air** may flow out from the indoor unit during heating Thermo-OFF.
- **Refrigerant flow sound** may occur in the rooms with low background noise such as hotel rooms, hospital rooms, bedrooms, or conference rooms.

To avoid the above issues on Y system, changing board settings on the indoor and outdoor units is required.

Ask AC&R Works for details.

5-1. General precautions

5-1-1. Usage

- The air-conditioning system described in this Data Book is designed for human comfort.
- This product is not designed for preservation of food, animals, plants, precision equipment, or art objects. To prevent quality loss, do not use the product for purposes other than what it is designed for.
- To reduce the risk of water leakage and electric shock, do not use the product for air-conditioning vehicles or vessels.

5-1-2. Installation environment

- Do not install any unit other than the dedicated unit in a place where the voltage changes a lot, large amounts of mineral oil (e.g., cutting oil) are present, cooking oil may splash, or a large quantity of steam can be generated such as a kitchen.
- Do not install the unit in acidic or alkaline environment.
- Installation should not be performed in the locations exposed to chlorine or other corrosive gases. Avoid near a sewer.
- To reduce the risk of fire, do not install the unit in a place where flammable gas may be leaked or inflammable material is present.
- This air conditioning unit has a built-in microcomputer. Take the noise effects into consideration when deciding the installation position. Especially in a place where antenna or electronic device are installed, it is recommended that the air conditioning unit be installed away from them.
- Install the unit on a solid foundation according to the local safety measures against typhoons, wind gusts, and earthquakes to prevent the unit from being damaged, toppling over, and falling.

5-1-3. Backup system

- In a place where air conditioner's malfunctions may exert crucial influence, it is recommended to have two or more systems of single outdoor units with multiple indoor units.

5-1-4. Unit characteristics

- Heat pump efficiency depends on outdoor temperature. In the heating mode, performance drops as the outside air temperature drops. In cold climates, performance can be poor. Warm air would continue to be trapped near the ceiling and the floor level would continue to stay cold. In this case, heat pumps require a supplemental heating system or air circulator. Before purchasing them, consult your local distributor for selecting the unit and system.
- When the outdoor temperature is low and the humidity is high, the heat exchanger on the outdoor unit side tends to collect frost, which reduces its heating performance. To remove the frost, Auto-defrost function will be activated and the heating mode will temporarily stop for 3-10 minutes. Heating mode will automatically resume upon completion of defrost process.
- Air conditioner with a heat pump requires time to warm up the whole room after the heating operation begins, because the system circulates warm air in order to warm up the whole room.
- The sound levels were obtained in an anechoic room. The sound levels during actual operation are usually higher than the simulated values due to ambient noise and echoes. Refer to the section on "SOUND LEVELS" for the measurement location.
- Depending on the operation conditions, the unit generates noise caused by valve actuation, refrigerant flow, and pressure changes even when operating normally. Please consider to avoid location where quietness is required. For BC controller, it is recommended to unit to be installed in places such as ceilings of corridor, restrooms and plant rooms.
- The total capacity of the connected indoor units can be greater than the capacity of the outdoor unit. However, when the connected indoor units operate simultaneously, each unit's capacity may become smaller than the rated capacity.
- When the unit is started up for the first time within 12 hours after power on or after power failure, it performs initial startup operation (capacity control operation) to prevent damage to the compressor. The initial startup operation requires 90 minutes maximum to complete, depending on the operation load.

5-1-5. Relevant equipment

- Use an earth leakage breaker (ELB) with medium sensitivity, and an activation speed of 0.1 second or less.
- Consult your local distributor or a qualified technician when installing an earth leakage breaker.
- If the unit is inverter type, select an earth leakage breaker for handling high harmonic waves and surges.
- Leakage current is generated not only through the air conditioning unit but also through the power wires. Therefore, the leakage current of the main power supply is greater than the total leakage current of each unit. Take into consideration the capacity of the earth leakage breaker or leakage alarm when installing one at the main power supply. To measure the leakage current simply on site, use a measurement tool equipped with a filter, and clamp all the four power wires together. The leakage current measured on the ground wire may not accurate because the leakage current from other systems may be included to the measurement value.
- Do not install a phase advancing capacitor on the unit connected to the same power system with an inverter type unit and its equipment.
- If a large current flows due to the product malfunctions or faulty wiring, both the earth leakage breaker on the product side and the upstream overcurrent breaker may trip almost at the same time. Separate the power system or coordinate all the breakers depending on the system's priority level.

5-1-6. Unit installation

- Your local distributor or a qualified technician must read the Installation Manual that is provided with each unit carefully before performing installation work.
- Consult your local distributor or a qualified technician when installing the unit. Improper installation by an unqualified person may result in water leakage, electric shock, or fire.
- Ensure there is enough space around each unit.

5-1-7. Optional accessories

- Only use accessories recommended by Mitsubishi Electric. Consult your local distributor or a qualified technician when installing them. Improper installation by an unqualified person may result in water leakage, electric leakage, system breakdown, or fire.
- Some optional accessories may not be compatible with the air conditioning unit to be used or may not be suitable for the installation conditions. Check the compatibility when considering any accessories.
- Note that some optional accessories may affect the air conditioner's external form, appearance, weight, operating sound, and other characteristics.

5-1-8. Operation/Maintenance

- Read the Instruction Book that is provided with each unit carefully prior to use.
- Maintenance or cleaning of each unit may be risky and require expertise. Read the Instruction Book to ensure safety. Consult your local distributor or a qualified technician when special expertise is required such as when the indoor unit needs to be cleaned.

5-2. Precautions for Indoor unit

5-2-1. Operating environment

- The refrigerant (R410A) used for air conditioner is non-toxic and nonflammable. However, if the refrigerant leaks, the oxygen level may drop to harmful levels. If the air conditioner is installed in a small room, measures must be taken to prevent the refrigerant concentration from exceeding the safety limit even if the refrigerant should leak.
- If the units operate in the cooling mode at the humidity above 80%, condensation may collect and drip from the indoor units.

5-2-2. Unit characteristics

- The return air temperature display on the remote controller may differ from the ones on the other thermometers.
- The clock on the remote controller may be displayed with a time lag of approximately one minute every month.
- The temperature using a built-in temperature sensor on the remote controller may differ from the actual room temperature due to the effect of the wall temperature.
- Use a built-in thermostat on the remote controller or a separately-sold thermostat when indoor units installed on or in the ceiling operate the automatic cooling/heating switchover.
- The room temperature may rise drastically due to Thermo OFF in the places where the air conditioning load is large such as computer rooms.
- Be sure to use a regular filter. If an irregular filter is installed, the unit may not operate properly, and the operation noise may increase.
- The room temperature may rise over the preset temperature in the environment where the heating air conditioning load is small.

5-2-3. Unit installation

- For simultaneous cooling/heating operation type air conditioners (R2, WR2 series), the G-type BC controller cannot be connected to the 16HP outdoor unit model or above, and the G- and GA-type BC controllers cannot be connected to the 28HP model or above. The GB- and HB-type BC controllers (sub) cannot be connected to the outdoor unit directly, and be sure to use them with GA- and HA-type BC controllers (main).
- The insulation for low pressure pipe between the BC controller and outdoor unit shall be at least 20 mm thick. If the unit is installed on the top floor or in a high-temperature, high-humidity environment, thicker insulation may be necessary.
- Do not have any branching points on the downstream of the refrigerant pipe header.
- When a field-supplied external thermistor is installed or when a device for the demand control is used, abnormal stop of the unit or damage of the electromagnetic contactor may occur. Consult your local distributor for details.
- When indoor units operate a fresh air intake, install a filter in the duct (field-supplied) to remove the dust from the air.
- The 4-way or 2-way Airflow Ceiling Cassette Type units that have an outside air inlet can be connected to the duct, but need a booster fan to be installed at site. Refer to the chapter "Indoor Unit" for the available range for fresh air intake volume.
- Operating fresh air intake on the indoor unit may increase the sound pressure level.

5-3. Precautions for Fresh air intake type indoor unit

5-3-1. Usage

- This unit mainly handles the outside air load, and is not designed to maintain the room temperature. Install other air conditioners for handling the air conditioning load in the room.

5-3-2. Unit characteristics

- This unit cannot perform the drying operation. The unit will continue the fan operation and blow fresh air (air that is not air-conditioned) when the Heating Thermo-OFF or Cooling Thermo-OFF mode is selected.
- The fan may stop tentatively when the unit is connected to the simultaneous cooling/heating operation type outdoor unit (R2, WR2 series) or during the defrost cycle.
- This unit switches the Thermo ON or OFF depending on the room temperature. The outside air is directly supplied into the room during Thermo OFF. Take caution of the cold supply air due to low outside air temperature and of condensation in the room due to high humidity of the outside air.
- Outside air temperature ranges for the operation must be as follows:
Cooling: 21°C D.B./15.5°C W.B. ~ 43°C D.B./35°C W.B.
Heating: -10°C D.B. ~ 20°C D.B.
The unit is forced to operate Thermo OFF (fan operation) when the outside air temperature is as follows.
Cooling: 21°C D.B. or below; Heating: 20°C D.B. or above
- Either a remote controller (sold separately) or a remote sensor (sold separately) must be installed to monitor the room temperature.
- If only this unit is used as an indoor unit, condensation may form at the supply air grill while the unit is operated in the cooling mode. This unit cannot operate dehumidifying.
- Use the unit in the way that the airflow rate will not exceed the 110% of the rated airflow.

5-4. Precautions for Outdoor unit/Heat source unit

5-4-1. Installation environment

- Outdoor unit with salt-resistant specification is recommended to use in a place where it is subject to salt air.
- Even when the unit with salt-resistant specification is used, it is not completely protected against corrosion. Be sure to follow the directions or precautions described in Instructions Book and Installation Manual for installation and maintenance. The salt-resistant specification is referred to the guidelines published by JRAIA (JRA9002).
- Install the unit in a place where the flow of discharge air is not obstructed. If not, the short-cycling of discharge air may occur.
- Provide proper drainage around the unit base, because the condensation may collect and drip from the outdoor units. Provide water-proof protection to the floor when installing the units on the rooftop.
- In a region where snowfall is expected, install the unit so that the outlet faces away from the direction of the wind, and install a snow guard to protect the unit from snow. Install the unit on a base approximately 50 cm higher than the expected snowfall. Close the openings for pipes and wiring, because the ingress of water and small animals may cause equipment damage. If SUS snow guard is used, refer to the Installation Manual that comes with the snow guard and take caution for the installation to avoid the risk of corrosion.
- When the unit is expected to operate continuously for a long period of time at outside air temperatures of below 0°C, take appropriate measures, such as the use of a unit base heater, to prevent icing on the unit base. (Not applicable to the PUMY series)
- Install the snow guard so that the outlet/inlet faces away from the direction of the wind.
- When the snow accumulates approximately 50 cm or more on the snow guard, remove the snow from the guard. Install a roof that is strong enough to withstand snow loads in a place where snow accumulates.
- Provide proper protection around the outdoor units in places such as schools to avoid the risk of injury.
- A cooling tower and heat source water circuit should be a closed circuit that water is not exposed to the atmosphere. When a tank is installed to ensure that the circuit has enough water, minimize the contact with outside air so that the oxygen from being dissolved in the water should be 1 mg/L or less.
- Install a strainer (50 mesh or more recommended) on the water pipe inlet on the heat source unit.
- Interlock the heat source unit and water circuit pump.
- Note the followings to prevent the freeze bursting of pipe when the heat source unit is installed in a place where the ambient temperature can be 0°C or below.
- Keep the water circulating to prevent it from freezing when the ambient temperature is 0°C or below.
- Before a long period of non use, be sure to purge the water out of the unit.
- Salt-resistant unit is resistant to salt corrosion, but not salt-proof.
Please note the following when installing and maintaining outdoor units in marine atmosphere.
 1. Install the salt-resistant unit out of direct exposure to sea breeze, and minimize the exposure to salt water mist.
 2. Avoid installing a sun shade over the outdoor unit, so that rain will wash away salt deposits off the unit.
 3. Install the unit horizontally to ensure proper water drainage from the base of the unit. Accumulation of water in the base of the outdoor unit will significantly accelerate corrosion.
 4. Periodically wash salt deposits off the unit, especially when the unit is installed in a coastal area.
 5. Repair all noticeable scratches after installation and during maintenance.
 6. Periodically check the unit, and apply anti-rust agent and replace corroded parts as necessary.

5-4-2. Circulating water

- ♦ Follow the guidelines published by JRAIA (JRA-GL02-1994) to check the water quality of the water in the heat source unit regularly.
- ♦ A cooling tower and heat source water circuit should be a closed circuit that water is not exposed to the atmosphere. When a tank is installed to ensure that the circuit has enough water, minimize the contact with outside air so that the oxygen from being dissolved in the water should be 1 mg/L or less.

5-4-3. Unit characteristics

- ♦ When the Thermo ON and OFF is frequently repeated on the indoor unit, the operation status of outdoor units may become unstable.

5-4-4. Relevant equipment

- ♦ Provide grounding in accordance with the local regulations.

5-5. Precautions for Control-related items**5-5-1. Product specification**

- ♦ To introduce the MELANS system, a consultation with us is required in advance. Especially to introduce the electricity charge apportioning function or energy-save function, further detailed consultation is required. Consult your local distributor for details.
- ♦ Billing calculation for AE-200E/AE-50E, AG-150A, GB-50ADA, TG-2000A, or the billing calculation unit is unique and based on our original method. (Backup operation is included.) It is not based on the metering method, and do not use it for official business purposes. It is not the method that the amount of electric power consumption (input) by air conditioner is calculated. Note that the electric power consumption by air conditioner is apportioned by using the ratio corresponding to the operation status (output) for each air conditioner (indoor unit) in this method.
- ♦ In the apportioned billing function for AE-200E/AE-50E, AG-150A and GB-50ADA, use separate watthour meters for A-control units, K-control units, and packaged air conditioner for City Multi air conditioners. It is recommended to use an individual watthour meter for the large-capacity indoor unit (with two or more addresses).
- ♦ When using the peak cut function on the AE-200E/AE-50E, AG-150A or GB-50ADA, note that the control is performed once every minute and it takes time to obtain the effect of the control. Take appropriate measures such as lowering the criterion value. Power consumption may exceed the limits if AE-200E/AE-50E, AG-150A or GB-50ADA malfunctions or stops. Provide a back-up remedy as necessary.
- ♦ The controllers cannot operate while the indoor unit is OFF. (No error)
Turn ON the power to the indoor unit when operating the controllers.
- ♦ When using the interlocked control function on the AE-200E/AE-50E, AG-150A, GB-50ADA, PAC-YG66DCA, or PAC-YG63MCA, do not use it for the control for the fire prevention or security. (This function should never be used in the way that would put people's lives at risk.) Provide any methods or circuit that allow ON/OFF operation using an external switch in case of failure.

5-5-2. Installation environment

- ♦ The surge protection for the transmission line may be required in areas where lightning strikes frequently occur.
- ♦ A receiver for a wireless remote controller may not work properly due to the effect of general lighting. Leave a space of at least 1 m between the general lighting and receiver.
- ♦ When the Auto-elevating panel is used and the operation is made by using a wired remote controller, install the wired remote controller to the place where all air conditioners controlled (at least the bottom part of them) can be seen from the wired remote controller. If not, the descending panel may cause damage or injury, and be sure to use a wireless remote controller designed for use with elevating panel (sold separately).
- ♦ Install the wired remote controller (switch box) to the place where the following conditions are met.
- ♦ Where installation surface is flat
- ♦ Where the remote controller can detect an accurate room temperature
The temperature sensors that detect a room temperature are installed both on the remote controller and indoor unit. When a room temperature is detected using the sensor on the remote controller, the main remote controller is used to detect a room temperature. In this case, follow the instructions below.
- ♦ Install the controller in a place where it is not subject to the heat source.
(If the remote controller faces direct sunlight or supply air flow direction, the remote controller cannot detect an accurate room temperature.)
- ♦ Install the controller in a place where an average room temperature can be detected.
- ♦ Install the controller in a place where no other wires are present around the temperature sensor.
(If other wires are present, the remote controller cannot detect an accurate room temperature.)
- ♦ To prevent unauthorized access, always use a security device such as a VPN router when connecting AE-200E/AE-50E, AG-150A, GB-50ADA, or TG-2000A to the Internet.

The installer and/or air conditioning system specialist shall secure safety against refrigerant leakage according to local regulations or standards. The following standard may be applicable if no local regulation or standard is available.

S.D. Y

6-1. Refrigerant property

R410A refrigerant is harmless and incombustible. The R410A is heavier than the indoor air in density. Leakage of the refrigerant in a room has possibility to lead to a hypoxia situation. Therefore, the Critical concentration specified below shall not be exceeded even if the leakage happens.

• Critical concentration

Critical concentration hereby is the refrigerant concentration in which no human body would be hurt if immediate measures can be taken when refrigerant leakage happens.

Critical concentration of R410A: 0.44kg/m³

(The weight of refrigeration gas per 1 m³ air conditioning space.);

* The Critical concentration is subject to ISO5149, EN378-1.

For the CITY MULTI system, the concentration of refrigerant leaked should not have a chance to exceed the Critical concentration in any situation.

6-2. Confirm the Critical concentration and take countermeasure

The maximum refrigerant leakage concentration (Rmax) is defined as the result of the possible maximum refrigerant weight (Wmax) leaked into a room divided by its room capacity (V). It is referable to Fig.6-1. The refrigerant of Outdoor unit here includes its original charge and additional charge at the site.

The additional charge is calculated according to "3-3. Refrigerant charging calculation" and shall not be over charged at the site.

Procedure 6-2-1~3 tells how to confirm maximum refrigerant leakage concentration (Rmax) and how to take countermeasures against a possible leakage.

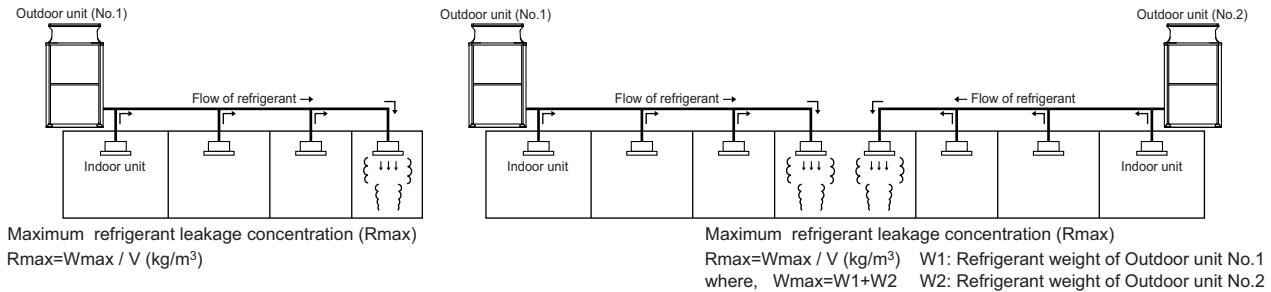

Fig. 6-1 The maximum refrigerant leakage concentration

6-2-1. Find the room capacity (V),

If a room having total opening area more than 0.15% of the floor area at a low position with another room/space, the two rooms/space are considered as one. The total space shall be added up.

6-2-2. Find the possible maximum leakage (Wmax) in the room. If a room has Indoor unit(s) from more than 1 Outdoor unit, add up the refrigerant of the Outdoor units.

6-2-3. Divide (Wmax) by (V) to get the maximum refrigerant leakage concentration (Rmax).

6-2-4. Find if there is any room in which the maximum refrigerant leakage concentration (Rmax) is over 0.44kg/m³.

If no, then the CITY MULTI is safe against refrigerant leakage.

If yes, following countermeasure is recommended to do at site.

Countermeasure 1: Let-out (making V bigger)

Design an opening of more than 0.15% of the floor area at a low position of the wall to let out the refrigerant whenever leaked.

e.g. make the upper and lower seams of door big enough.

Countermeasure 2: Smaller total charge (making Wmax smaller)

e.g. Avoid connecting more than 1 Outdoor unit to one room.

e.g. Using smaller model size but more Outdoor units.

e.g. Shorten the refrigerant piping as much as possible.

Countermeasure 3: Fresh air in from the ceiling (Ventilation)

As the density of the refrigerant is bigger than that of the air. Fresh air supply from the ceiling is better than air exhausting from the ceiling.

Fresh air supply solution refers to Fig.6-2~4.

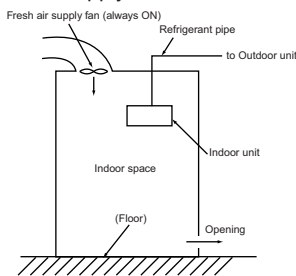

Fig.6-2. Fresh air supply always ON

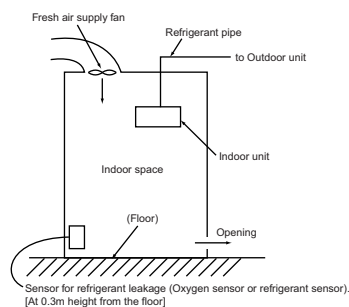

Fig.6-3. Fresh air supply upon sensor action

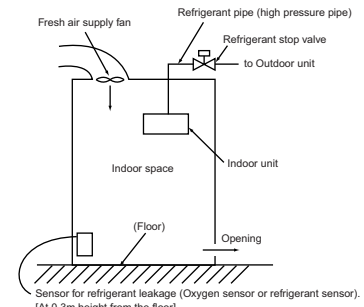

Fig.6-4. Fresh air supply and refrigerant shut-off upon sensor action

Note 1. Countermeasure 3 should be done in a proper way in which the fresh air supply shall be on whenever the leakage happens.

Note 2. In principle, MITSUBISHI ELECTRIC requires proper piping design, installation and air-tight testing after installation to avoid leakage happening.

In the area should earthquake happen, anti-vibration measures should be fully considered.

The piping should consider the extension due to the temperature variation.

CITY MULTI

SYSTEM DESIGN R2 SERIES

1. Electrical work.....	4 - 66
1-1.General cautions	4 - 66
1-2.Power supply for Indoor unit and Outdoor unit	4 - 67
1-3.Power cable specifications	4 - 73
1-4.Power supply examples.....	4 - 75
2. M-NET control.....	4 - 79
2-1.Transmission cable length limitation.....	4 - 79
2-2.Transmission cable specifications	4 - 80
2-3.System configuration restrictions.....	4 - 81
2-4.Address setting.....	4 - 84
3. Piping Design.....	4 - 96
3-1.R410A Piping material	4 - 96
3-2.Piping Design	4 - 97
3-3.Refrigerant charging calculation	4 - 105
4. Outdoor Installation.....	4 - 109
4-1.Requirement on installation site	4 - 109
4-2.Spacing.....	4 - 110
4-3.Piping direction	4 - 112
4-4.Weather countermeasure	4 - 117
5. Installation information.....	4 - 119
5-1.General precautions	4 - 119
5-2.Precautions for Indoor unit	4 - 120
5-3.Precautions for Fresh air intake type indoor unit	4 - 121
5-4.Precautions for Outdoor unit/Heat source unit	4 - 121
5-5.Precautions for Control-related items	4 - 122
6. Caution for refrigerant leakage	4 - 123
6-1.Refrigerant property.....	4 - 123
6-2.Confirm the Critical concentration and take countermeasure.....	4 - 123

1-1. General cautions

- ① Follow ordinance of your governmental organization for technical standard related to electrical equipment, wiring regulations, and guidance of each electric power company.
- ② Wiring for control (hereinafter referred to as transmission cable) shall be (50mm[1-5/8in.] or more) apart from power source wiring so that it is not influenced by electric noise from power source wiring. (Do not insert transmission cable and power source wire in the same conduit.)
- ③ Be sure to provide designated grounding work to outdoor unit.
- ④ Give some allowance to wiring for electrical part box of indoor and outdoor units, because the box is sometimes removed at the time of service work.
- ⑤ Never connect 380~415V(220~240V) power source to terminal block of transmission cable. If connected, electrical parts will be damaged.
- ⑥ Use 2-core shield cable for transmission cable. If transmission cables of different systems are wired with the same multiple-core cable, the resultant poor transmitting and receiving will cause erroneous operations.
- ⑦ When extending the transmission line, make sure to extend the shield cable as well.

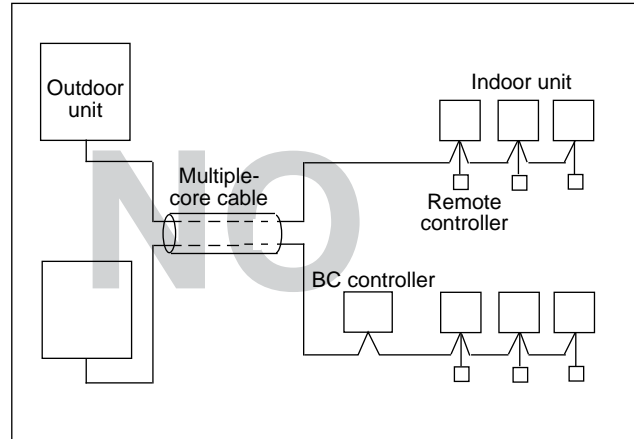
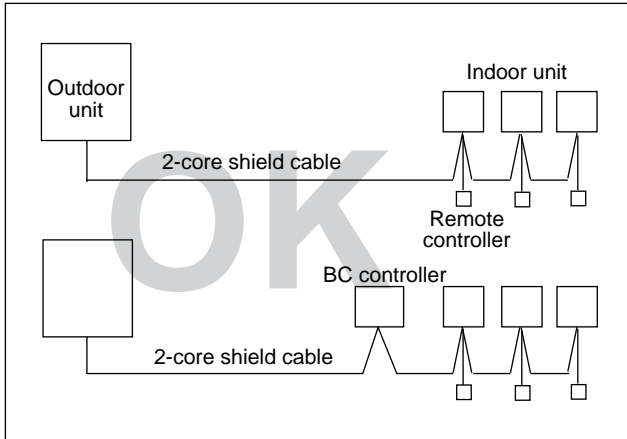

1-2. Power supply for Indoor unit and Outdoor unit

1-2-1. Electrical characteristics of Indoor unit

Symbols: MCA (Max.Circuit Amps =1.25xFLA), FLA (Full Load Amps)
IFM (Indoor Fan Motor), Output (Fan motor rated output)

PMFY-P-VBM-E	Power supply			IFM	
	Volts / Hz	Range +-10%	MCA(A)	Output (kW)	FLA(A)
PMFY-P20VBM-E	220-240V / 50Hz 220V / 60Hz	Max.: 264V Min.: 198V	0.25	0.028	0.20
PMFY-P25VBM-E			0.26	0.028	0.21
PMFY-P32VBM-E			0.26	0.028	0.21
PMFY-P40VBM-E			0.33	0.028	0.26

PLFY-P-VCM-E2	Power supply			IFM	
	Volts / Hz	Range +-10%	MCA(A)	Output (kW)	FLA(A)
PLFY-P15VCM-E2	220-240V / 50Hz	Max.: 264V Min.: 198V	0.24	0.008	0.19
PLFY-P20VCM-E2			0.29	0.011	0.23
PLFY-P25VCM-E2			0.29	0.015	0.23
PLFY-P32VCM-E2			0.35	0.020	0.28
PLFY-P40VCM-E2			0.35	0.020	0.28

PLFY-P-VBM-E	Power supply			IFM	
	Volts / Hz	Range +-10%	MCA(A)	Output (kW)	FLA(A)
PLFY-P20VBM-E	220-240V / 50Hz 220V / 60Hz	Max.: 264V Min.: 198V	0.33	0.050	0.26
PLFY-P25VBM-E			0.33	0.050	0.26
PLFY-P32VBM-E			0.34	0.050	0.27
PLFY-P40VBM-E			0.36	0.050	0.29
PLFY-P50VBM-E			0.36	0.050	0.29
PLFY-P63VBM-E			0.45	0.050	0.36
PLFY-P80VBM-E			0.64	0.050	0.51
PLFY-P100VBM-E			1.25	0.120	1.00
PLFY-P125VBM-E			1.34	0.120	1.07

PLFY-P-VLMD-E	Power supply			IFM	
	Volts / Hz	Range +-10%	MCA(A) (50 / 60Hz)	Output (kW)	FLA(A) (50 / 60Hz)
PLFY-P20VLMD-E	220-240V / 50Hz 220-230V / 60Hz	Max.: 264V Min.: 198V	0.45 / 0.46	0.015	0.36 / 0.37
PLFY-P25VLMD-E			0.45 / 0.46	0.015	0.36 / 0.37
PLFY-P32VLMD-E			0.45 / 0.46	0.015	0.36 / 0.37
PLFY-P40VLMD-E			0.50 / 0.53	0.015	0.40 / 0.42
PLFY-P50VLMD-E			0.51 / 0.54	0.020	0.41 / 0.43
PLFY-P63VLMD-E			0.61 / 0.64	0.020	0.49 / 0.51
PLFY-P80VLMD-E			0.90 / 0.93	0.020	0.72 / 0.74
PLFY-P100VLMD-E			0.94 / 1.10	0.030	0.75 / 0.88
PLFY-P125VLMD-E			1.69 / 1.69	0.078x2	1.35 / 1.35

PEFY-P-VMR-E-L/R	Power supply			IFM	
	Volts / Hz	Range +-10%	MCA(A) (50 / 60Hz)	Output (kW)	FLA(A) (50 / 60Hz)
PEFY-P20VMR-E-L/R	220-240V / 50Hz 220-230V / 60Hz	Max.: 264V Min.: 198V	0.37 / 0.37	0.018	0.29 / 0.29
PEFY-P25VMR-E-L/R			0.37 / 0.37	0.018	0.29 / 0.29
PEFY-P32VMR-E-L/R			0.43 / 0.48	0.023	0.34 / 0.38

PEFY-P-VMS1-E	Power supply			IFM	
	Volts / Hz	Range +-10%	MCA(A) (50 / 60Hz)	Output (kW)	FLA(A) (50 / 60Hz)
PEFY-P15VMS1-E	220-240V / 50Hz 220-240V / 60Hz	Max.: 264V Min.: 198V	0.63 / 0.63	0.096	0.50 / 0.50
PEFY-P20VMS1-E			0.70 / 0.70	0.096	0.56 / 0.56
PEFY-P25VMS1-E			0.75 / 0.75	0.096	0.60 / 0.60
PEFY-P32VMS1-E			0.75 / 0.75	0.096	0.60 / 0.60
PEFY-P40VMS1-E			0.83 / 0.82	0.096	0.66 / 0.65
PEFY-P50VMS1-E			1.02 / 1.00	0.096	0.81 / 0.80
PEFY-P63VMS1-E			1.08 / 1.07	0.096	0.86 / 0.85

1. Electrical work

YKB/YLM

Symbols: MCA (Max.Circuit Amps =1.25xFLA), FLA (Full Load Amps)
IFM (Indoor Fan Motor), Output (Fan motor rated output)

S.D. R2

PEFY-P-VMS1L-E	Power supply			IFM	
	Volts / Hz	Range +-10%	MCA(A) (50 / 60Hz)	Output (kW)	FLA(A) (50 / 60Hz)
PEFY-P15VMS1L-E	220-240V / 50Hz 220-240V / 60Hz	Max.: 264V Min.: 198V	0.46 / 0.46	0.096	0.37 / 0.37
PEFY-P20VMS1L-E			0.54 / 0.54	0.096	0.43 / 0.43
PEFY-P25VMS1L-E			0.59 / 0.59	0.096	0.47 / 0.47
PEFY-P32VMS1L-E			0.59 / 0.59	0.096	0.47 / 0.47
PEFY-P40VMS1L-E			0.68 / 0.68	0.096	0.54 / 0.54
PEFY-P50VMS1L-E			0.84 / 0.84	0.096	0.67 / 0.67
PEFY-P63VMS1L-E			0.91 / 0.91	0.096	0.73 / 0.73

PEFY-P-VMH(S)-E	Power supply			IFM	
	Volts / Hz	Range +-10%	MCA(A) (50 / 60Hz)	Output (kW)	FLA(A) (50 / 60Hz)
PEFY-P40VMH-E	220-240V / 50Hz 220-240V / 60Hz	Max.: 264V Min.: 198V	1.21 / 1.61	0.08	0.97 / 1.29
PEFY-P50VMH-E			1.21 / 1.61	0.08	0.97 / 1.29
PEFY-P63VMH-E			1.49 / 1.95	0.12	1.19 / 1.56
PEFY-P71VMH-E			1.58 / 2.18	0.14	1.26 / 1.74
PEFY-P80VMH-E			1.85 / 2.40	0.18	1.48 / 1.92
PEFY-P100VMH-E			3.03 / 3.93	0.26	2.42 / 3.14
PEFY-P125VMH-E			3.03 / 3.93	0.26	2.42 / 3.14
PEFY-P140VMH-E			3.10 / 3.98	0.26	2.48 / 3.18
PEFY-P200VMH-E	380-415V / 50Hz	Max.: 456V	2.03 / 2.33	0.76	1.62 / 1.86
PEFY-P250VMH-E	380-415V / 60Hz	Min.: 342V	2.50 / 2.88	1.08	2.00 / 2.30
PEFY-P200VMHS-E	220-240V / 50Hz	Max.: 264V	7.00	0.87	5.60
PEFY-P250VMHS-E	220-240V / 60Hz	Min.: 198V	7.50	0.87	6.00

PEFY-P-VMA-E PEFY-P-VMA3-E	Power supply			IFM	
	Volts / Hz	Range +-10%	MCA(A)	Output (kW)	FLA(A)
PEFY-P20VMA-E	220-240V / 50Hz 220-240V / 60Hz	Max.: 264V Min.: 198V	1.03	0.085	0.82
PEFY-P25VMA-E			1.03	0.085	0.82
PEFY-P32VMA-E			1.18	0.085	0.95
PEFY-P40VMA-E			1.43	0.085	1.14
PEFY-P50VMA-E			1.54	0.085	1.23
PEFY-P63VMA-E			2.22	0.121	1.78
PEFY-P71VMA-E			2.46	0.121	1.97
PEFY-P80VMA-E			2.47	0.121	1.98
PEFY-P100VMA-E			3.30	0.244	2.64
PEFY-P125VMA-E			3.39	0.244	2.71
PEFY-P140VMA-E			3.29	0.244	2.63
PEFY-P20VMA3-E			1.74	0.085	1.39

PEFY-P-VMAL-E	Power supply			IFM	
	Volts / Hz	Range +-10%	MCA(A)	Output (kW)	FLA(A)
PEFY-P20VMAL-E	220-240V / 50Hz 220-240V / 60Hz	Max.: 264V Min.: 198V	0.92	0.085	0.74
PEFY-P25VMAL-E			0.92	0.085	0.74
PEFY-P32VMAL-E			1.07	0.085	0.86
PEFY-P40VMAL-E			1.32	0.085	1.06
PEFY-P50VMAL-E			1.40	0.085	1.12
PEFY-P63VMAL-E			2.08	0.121	1.67
PEFY-P71VMAL-E			2.32	0.121	1.86
PEFY-P80VMAL-E			2.36	0.121	1.89
PEFY-P100VMAL-E			3.19	0.244	2.55
PEFY-P125VMAL-E			3.27	0.244	2.62
PEFY-P140VMAL-E			3.17	0.244	2.53

Symbols: MCA (Max.Circuit Amps =1.25xFLA), FLA (Full Load Amps)
IFM (Indoor Fan Motor), Output (Fan motor rated output)

PEFY-P-VMH-E-F	Power supply			IFM	
	Volts / Hz	Range +-10%	MCA(A) (50 / 60Hz)	Output (kW)	FLA(A) (50 / 60Hz)
PEFY-P80VMH-E-F	220-240V / 50Hz	Max.: 264V	0.92 / 1.15	0.09	0.73 / 0.92
PEFY-P140VMH-E-F	208-230V / 60Hz	Min.: 187V	1.58 / 1.84	0.14	1.26 / 1.47
PEFY-P200VMH-E-F	380-415V / 50Hz	Max.: 456V	0.73 / 0.93	0.20	0.58 / 0.74
PEFY-P250VMH-E-F	380-415V / 60Hz	Min.: 342V	0.85 / 1.08	0.23	0.68 / 0.86

PKFY-P-VBM-E	Power supply			IFM	
	Volts / Hz	Range +-10%	MCA(A)	Output (kW)	FLA(A)
PKFY-P15VBM-E	220-240V / 50Hz 220V / 60Hz	Max.: 264V Min.: 198V	0.25	0.017	0.20
PKFY-P20VBM-E			0.25	0.017	0.20
PKFY-P25VBM-E			0.25	0.017	0.20

PKFY-P-VHM-E	Power supply			IFM	
	Volts / Hz	Range +-10%	MCA(A)	Output (kW)	FLA(A)
PKFY-P32VHM-E	220-240V / 50Hz 220V / 60Hz	Max.: 264V Min.: 198V	0.38	0.030	0.30
PKFY-P40VHM-E			0.38	0.030	0.30
PKFY-P50VHM-E			0.38	0.030	0.30

PKFY-P-VKM-E	Power supply			IFM	
	Volts / Hz	Range +-10%	MCA(A)	Output (kW)	FLA(A)
PKFY-P63VKM-E	220-240V / 50Hz	Max.: 264V	0.36	0.056	0.29
PKFY-P100VKM-E	220V / 60Hz	Min.: 198V	0.63	0.056	0.50

PCFY-P-VKM-E	Power supply			IFM	
	Volts / Hz	Range +-10%	MCA(A)	Output (kW)	FLA(A)
PCFY-P40VKM-E	220-240V / 50Hz 220V / 60Hz	Max.: 264V Min.: 198V	0.35	0.090	0.28
PCFY-P63VKM-E			0.41	0.095	0.33
PCFY-P100VKM-E			0.81	0.160	0.65
PCFY-P125VKM-E			0.95	0.160	0.76

PFFY-P-VKM-E2	Power supply			IFM	
	Volts / Hz	Range +-10%	MCA(A)	Output (kW)	FLA(A)
PFFY-P20VKM-E2	220-240V / 50Hz	Max.: 264V Min.: 198V	0.25	0.03x2	0.20
PFFY-P25VKM-E2			0.25	0.03x2	0.20
PFFY-P32VKM-E2			0.25	0.03x2	0.20
PFFY-P40VKM-E2			0.30	0.03x2	0.24

PFFY-P-VLEM-E	Power supply			IFM	
	Volts / Hz	Range +-10%	MCA(A) (50 / 60Hz)	Output (kW)	FLA(A) (50 / 60Hz)
PFFY-P20VLEM-E	220-240V / 50Hz 208-230V / 60Hz	Max.: 264V Min.: 187V	0.24 / 0.31	0.015	0.19 / 0.25
PFFY-P25VLEM-E			0.24 / 0.31	0.015	0.19 / 0.25
PFFY-P32VLEM-E			0.36 / 0.38	0.018	0.29 / 0.30
PFFY-P40VLEM-E			0.40 / 0.41	0.030	0.32 / 0.33
PFFY-P50VLEM-E			0.50 / 0.51	0.035	0.40 / 0.41
PFFY-P63VLEM-E			0.58 / 0.59	0.050	0.46 / 0.47

Symbols: MCA (Max.Circuit Amps =1.25xFLA), FLA (Full Load Amps)
IFM (Indoor Fan Motor), Output (Fan motor rated output)

S.D. R2

PFFY-P-VLRM-E	Power supply			IFM	
	Volts / Hz	Range +-10%	MCA(A) (50 / 60Hz)	Output (kW)	FLA(A) (50 / 60Hz)
PFFY-P20VLRM-E	220-240V / 50Hz 208-230V / 60Hz	Max.: 264V Min.: 187V	0.24 / 0.31	0.015	0.19 / 0.25
PFFY-P25VLRM-E			0.24 / 0.31	0.015	0.19 / 0.25
PFFY-P32VLRM-E			0.36 / 0.38	0.018	0.29 / 0.30
PFFY-P40VLRM-E			0.40 / 0.41	0.030	0.32 / 0.33
PFFY-P50VLRM-E			0.50 / 0.51	0.035	0.40 / 0.41
PFFY-P63VLRM-E			0.58 / 0.59	0.050	0.46 / 0.47

PFFY-P-VLRMM-E	Power supply			IFM	
	Volts / Hz	Range +-10%	MCA(A) (50 / 60Hz)	Output (kW)	FLA(A) (50 / 60Hz)
PFFY-P20VLRMM-E	220-240V / 50Hz 220-240V / 60Hz	Max.: 264V Min.: 198V	0.59 / 0.58	0.096	0.47 / 0.46
PFFY-P25VLRMM-E			0.59 / 0.58	0.096	0.47 / 0.46
PFFY-P32VLRMM-E			0.69 / 0.69	0.096	0.55 / 0.55
PFFY-P40VLRMM-E			0.78 / 0.76	0.096	0.62 / 0.61
PFFY-P50VLRMM-E			0.80 / 0.79	0.096	0.64 / 0.63
PFFY-P63VLRMM-E			0.93 / 0.93	0.096	0.74 / 0.74

GUF-RDH4	Power supply			IFM	
	Volts / Hz	Range +-10%	MCA(A)	Output (kW)	FLA(A)
GUF-50RD4	220-240V / 50Hz	Max.: 264V Min.: 198V	1.62	0.305	1.29
GUF-50RDH4			1.58	0.30	1.26
GUF-100RD4			3.18	0.58	2.54
GUF-100RDH4			2.98	0.56	2.38

1-2-2. Electrical characteristics of Outdoor unit at cooling mode

Symbols: MCA (Max Circuit Amps)

RLA (Rated Load Amps) SC (Starting Current)

PURY-P-YLM-A1	Unit Combination	Units			Power supply MCA(A)	Compressor		FAN Output(kW)	RLA(A)(50/60Hz)																															
		Hz	Volts	Voltage range		Output (kW)	SC(A)		Cooling	Heating																														
PURY-P200YLM-A1(-BS)	-	50/60	380 400 415	Max:456V Min:342V	16.1	5.6	8	0.92	8.9/8.4/8.1	9.2/8.8/8.4																														
PURY-P250YLM-A1(-BS)	-				17.3	6.9	8	0.92	11.7/11.1/10.7	12.3/11.7/11.3																														
PURY-P300YLM-A1(-BS)	-				22.2	8.1	8	0.92	15.3/14.5/14.0	15.8/15.0/14.4																														
PURY-P350YLM-A1(-BS)	-				27.8	10.5	8	0.92	19.8/18.8/18.1	19.5/18.5/17.9																														
PURY-P400YLM-A1(-BS)	-				32.4	10.9	8	0.92	23.1/21.9/21.1	19.2/18.3/17.6																														
PURY-P450YLM-A1(-BS)	-				35.3	12.4	8	0.92	24.1/22.9/22.1	25.2/23.9/23.0																														
PURY-P500YLM-A1(-BS)	-				41.9	13.4	8	0.92	29.9/28.4/27.4	27.1/25.7/24.8																														
PURY-P400YSLM-A1(-BS)	PURY-P200YLM-A1(-BS)				50/60	380 400 415	Max:456V Min:342V	25.9	5.6	8	0.92	18.5/17.5/16.9	18.5/17.6/16.9																											
	PURY-P200YLM-A1(-BS)								5.6	8	0.92																													
PURY-P450YSLM-A1(-BS)	PURY-P250YLM-A1(-BS)							50/60	380 400 415	Max:456V Min:342V	29.9	6.9	8	0.92	21.1/20.0/19.3	21.3/20.2/19.5																								
	PURY-P200YLM-A1(-BS)											5.6	8	0.92																										
PURY-P500YSLM-A1(-BS)	PURY-P250YLM-A1(-BS)										50/60	380 400 415	Max:456V Min:342V	34.6	6.9	8	0.92	24.2/23.0/22.2	24.7/23.4/22.6																					
	PURY-P250YLM-A1(-BS)														6.9	8	0.92																							
PURY-P550YSLM-A1(-BS)	PURY-P300YLM-A1(-BS)													50/60	380 400 415	Max:456V Min:342V	39.9	8.1	8	0.92	28.5/27.0/26.1	28.0/26.6/25.6																		
	PURY-P250YLM-A1(-BS)																	6.9	8	0.92																				
PURY-P600YSLM-A1(-BS)	PURY-P300YLM-A1(-BS)																50/60	380 400 415	Max:456V Min:342V	45.7	8.1	8	0.92	32.6/30.9/29.8	32.2/30.6/29.5															
	PURY-P300YLM-A1(-BS)																				8.1	8	0.92																	
PURY-P650YSLM-A1(-BS)	PURY-P350YLM-A1(-BS)																			50/60	380 400 415	Max:456V Min:342V	50.3	10.5	8	0.92	35.9/34.1/32.8	34.9/33.1/31.9												
	PURY-P300YLM-A1(-BS)																							8.1	8	0.92														
PURY-P700YSLM-A1(-BS)	PURY-P350YLM-A1(-BS)																						50/60	380 400 415	Max:456V Min:342V	57.3	10.5	8	0.92	40.9/38.8/37.4	38.2/36.3/35.0									
	PURY-P350YLM-A1(-BS)																										10.5	8	0.92											
PURY-P750YSLM-A1(-BS)	PURY-P400YLM-A1(-BS)																									50/60	380 400 415	Max:456V Min:342V	61.9	10.9	8	0.92	44.2/42.0/40.5	38.8/36.9/35.5						
	PURY-P350YLM-A1(-BS)																													10.5	8	0.92								
PURY-P800YSLM-A1(-BS)	PURY-P400YLM-A1(-BS)																												50/60	380 400 415	Max:456V Min:342V	66.8	10.9	8	0.92	47.7/45.3/43.7	38.5/36.6/35.3			
	PURY-P400YLM-A1(-BS)	10.9	8	0.92																																				
PURY-P850YSLM-A1(-BS)	PURY-P450YLM-A1(-BS)	50/60	380 400 415	Max:456V Min:342V																												69.1	12.4	8	0.92	49.3/46.9/45.2	44.2/42.0/40.5			
	PURY-P400YLM-A1(-BS)																																10.9	8	0.92					
PURY-P900YSLM-A1(-BS)	PURY-P450YLM-A1(-BS)																															50/60	380 400 415	Max:456V Min:342V	71.2	12.4	8	0.92	50.2/47.7/46.0	50.8/48.3/46.5
	PURY-P450YLM-A1(-BS)																																			12.4	8	0.92		

S.D. R2

PURY-EP-YLM	Unit Combination	Units			Power supply MCA(A)	Compressor		FAN Output(kW)	RLA(A)(50/60Hz)																									
		Hz	Volts	Voltage range		Output (kW)	SC(A)		Cooling	Heating																								
PURY-EP200YLM-A(-BS)	-	50/60	380 400 415	Max:456V Min:342V	16.1	5.6	8	0.92	9.2/8.7/8.4	10.8/10.2/9.9																								
PURY-EP250YLM-A(-BS)	-				19.9	6.9	8	0.92	12.2/11.6/11.2	14.2/13.5/13.0																								
PURY-EP300YLM-A(-BS)	-				23.6	8.1	8	0.92	15.5/14.7/14.2	16.8/15.9/15.4																								
PURY-EP350YLM-A(-BS)	-				30.6	10.5	8	0.92	21.2/20.1/19.4	21.8/20.7/19.9																								
PURY-EP400YLM-A(-BS)	-				31.7	10.9	8	0.92	21.2/20.1/19.4	22.6/21.4/20.7																								
PURY-EP450YLM-A(-BS)	-				37.4	12.4	8	0.92	25.0/23.7/22.9	26.7/25.4/24.5																								
PURY-EP500YLM-A(-BS)	-				46.1	13.4	8	0.92	31.4/29.8/28.7	32.9/31.3/30.2																								
PURY-EP550YSLM-A(-BS)	PURY-EP300YLM-A(-BS)				50/60	380 400 415	Max:456V Min:342V	43.6	8.1	8	0.92	29.2/27.8/26.8	31.1/29.5/28.5																					
	PURY-EP250YLM-A(-BS)								6.9	8	0.92																							
PURY-EP600YSLM-A(-BS)	PURY-EP300YLM-A(-BS)							50/60	380 400 415	Max:456V Min:342V	48.1	8.1	8	0.92	32.9/31.3/30.2	34.3/32.6/31.4																		
	PURY-EP300YLM-A(-BS)											8.1	8	0.92																				
PURY-EP650YSLM-A(-BS)	PURY-EP350YLM-A(-BS)										50/60	380 400 415	Max:456V Min:342V	53.2	10.5	8	0.92	37.3/35.4/34.1	38.0/36.1/34.7															
	PURY-EP300YLM-A(-BS)														8.1	8	0.92																	
PURY-EP700YSLM-A(-BS)	PURY-EP350YLM-A(-BS)													50/60	380 400 415	Max:456V Min:342V	59.8	10.5	8	0.92	43.8/41.6/40.1	42.6/40.5/39.0												
	PURY-EP350YLM-A(-BS)																	10.5	8	0.92														
PURY-EP750YSLM-A(-BS)	PURY-EP400YLM-A(-BS)																50/60	380 400 415	Max:456V Min:342V	62.3	10.9	8	0.92	43.8/41.6/40.1	44.5/42.3/40.7									
	PURY-EP350YLM-A(-BS)																				10.5	8	0.92											
PURY-EP800YSLM-A(-BS)	PURY-EP400YLM-A(-BS)																			50/60	380 400 415	Max:456V Min:342V	63.3	10.9	8	0.92	43.7/41.5/40.0	45.2/42.9/41.4						
	PURY-EP400YLM-A(-BS)																							10.9	8	0.92								
PURY-EP850YSLM-A(-BS)	PURY-EP450YLM-A(-BS)																						50/60	380 400 415	Max:456V Min:342V	70.3	12.4	8	0.92	48.0/45.6/44.0	50.2/47.7/45.9			
	PURY-EP400YLM-A(-BS)																										10.9	8	0.92					
PURY-EP900YSLM-A(-BS)	PURY-EP450YLM-A(-BS)																									50/60	380 400 415	Max:456V Min:342V	75.6	12.4	8	0.92	52.2/49.6/47.8	54.0/51.3/49.4
	PURY-EP450YLM-A(-BS)																													12.4	8	0.92		

1-2-3. Electrical characteristics of BC controller

Symbols: MCA (Max. Circuit Amps), MFA (Max. Fuse Amps), RLA (Rated Load Amps)

BC controller	Power supply					RLA(A)	
	Hz	Volts	Range±10%	MCA(A)	MFA(A)		
CMB-P104V-G1	50/60	220	Max.: 264V Min.: 198V	0.45	15	0.31	
		230				0.34	
		240				0.36	
CMB-P105V-G1		220				0.55	0.38
		230					0.41
		240					0.44
CMB-P106V-G1		220				0.65	0.45
		230					0.48
		240					0.52
CMB-P108V-G1		220		0.85		0.58	
		230				0.63	
		240				0.68	
CMB-P1010V-G1		220		1.04		0.71	
		230				0.77	
		240				0.83	
CMB-P1013V-G1		220		1.34		0.92	
		230				1.00	
		240				1.07	
CMB-P1016V-G1	220	1.63	1.12				
	230		1.22				
	240		1.30				
CMB-P108V-GA1	220	0.85	0.58				
	230		0.63				
	240		0.68				
CMB-P1010V-GA1	220	1.04	0.71				
	230		0.77				
	240		0.83				
CMB-P1013V-GA1	220	1.34	0.92				
	230		1.00				
	240		1.07				
CMB-P1016V-GA1	220	1.63	1.12				
	230		1.22				
	240		1.30				
CMB-P1016V-HA1	220	1.63	1.12				
	230		1.22				
	240		1.30				
CMB-P104V-GB1	220	0.40	0.28				
	230		0.30				
	240		0.32				
CMB-P108V-GB1	220	0.79	0.55				
	230		0.59				
	240		0.63				
CMB-P1016V-HB1	220	1.58	1.08				
	230		1.17				
	240		1.26				

S.D. R2

1-3. Power cable specifications

PURY-P-YLM-A1

Thickness of wire for main power supply, capacities of the switch and system impedance

	Model	Minimum wire thickness (mm ²)			Ground-fault interrupter *1	Local switch (A)		Breaker for wiring (A) (Non-fuse breaker)	Max. Permissible System Impedance
		Main cable	Branch	Ground		Capacity	Fuse		
Outdoor unit	PURY-P200YLM-A1	4.0	-	4.0	30A 100mA 0.1sec. or less	25	25	30	*2
	PURY-P250YLM-A1	4.0	-	4.0	30A 100mA 0.1sec. or less	32	32	30	*2
	PURY-P300YLM-A1	4.0	-	4.0	30A 100mA 0.1sec. or less	32	32	30	*2
	PURY-P350YLM-A1	6.0	-	6.0	40A 100mA 0.1sec. or less	40	40	40	0.23Ω
	PURY-P400YLM-A1	10.0	-	10.0	60A 100mA 0.1sec. or less	63	63	60	0.20Ω
	PURY-P450YLM-A1	10.0	-	10.0	60A 100mA 0.1sec. or less	63	63	60	0.19Ω
Total operating current of the indoor unit	F0 = 20A or less *3	1.5	1.5	1.5	Current sensitivity *4	16	16	20	(apply to IEC61000-3-3)
	F0 = 30A or less *3	2.5	2.5	2.5	Current sensitivity *4	25	25	30	(apply to IEC61000-3-3)
	F0 = 40A or less *3	4.0	4.0	4.0	Current sensitivity *4	32	32	40	(apply to IEC61000-3-3)

*1 The Ground-fault interrupter should support Inverter circuit. The Ground-fault interrupter should combine using of local switch or wiring breaker.

*2 Meet technical requirements of IEC61000-3-3

*3 Please take the larger of F1 or F2 as the value for F0.

F1 = Total operating maximum current of the indoor units × 1.2

F2 = {V1 × (Quantity of Type1)/C} + {V1 × (Quantity of Type2)/C} + {V1 × (Quantity of Type3)/C} + {V1 × (Quantity of Others)/C}

Indoor unit		V1	V2
Type1	PLFY-VBM, PMFY-VBM, PEFY-VMS, PCFY-VKM, PKFY-VHM, PKFY-VKM, PFFY-VKM, PFFY-VLRMM	18.6	2.4
Type2	PEFY-VMA	38	1.6
Type3	PEFY-VMHS	13.8	4.8
Others	Other indoor unit	0	0

C: Multiple of tripping current at tripping time 0.01s

Please pick up "C" from the tripping characteristic of the breaker.

<Example of "F2" calculation>

*Condition PEFY-VMS × 4 + PEFY-VMA × 1, C = 8 (refer to right sample chart)

F2 = 18.6 × 4/8 + 38 × 1/8
= 14.05

→ 16 A breaker (Tripping current = 8 × 16 A at 0.01s)

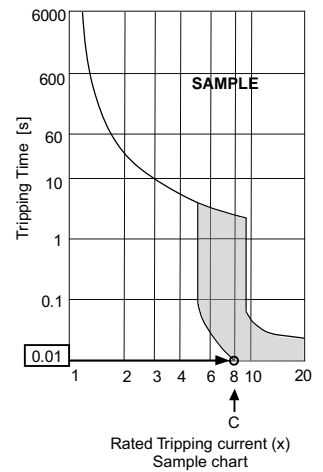

*4 Current sensitivity is calculated using the following formula.

G1 = (V2 × Quantity of Type1) + (V2 × Quantity of Type2) + (V2 × Quantity of Type3) + (V2 × Quantity of Others) + (V3 × Wire length [km])

G1	Current sensitivity	Wire thickness	V3
30 or less	30 mA 0.1sec or less	1.5 mm ²	48
100 or less	100 mA 0.1sec or less	2.5 mm ²	56
		4.0 mm ²	66

1. Use dedicated power supplies for the outdoor unit and indoor unit. Ensure OC and OS are wired individually.
2. Bear in mind ambient conditions (ambient temperature, direct sunlight, rain water, etc.) when proceeding with the wiring and connections.
3. The wire size is the minimum value for metal conduit wiring. If the voltage drops, use a wire that is one rank thicker in diameter. Make sure the power-supply voltage does not drop more than 10%. Make sure that the voltage imbalance between the phases is 2% or less.
4. Specific wiring requirements should adhere to the wiring regulations of the region.
5. Power supply cords of parts of appliances for outdoor use shall not be lighter than polychloroprene sheathed flexible cord (design 60245 IEC57). For example, use wiring such as YZW.
6. A switch with at least 3 mm contact separation in each pole shall be provided when the Air Conditioner is installed.

⚠ WARNING

- ◆ Be sure to use specified wires for connections and ensure no external force is imparted to terminal connections. If connections are not fixed firmly, heating or fire may result.
- ◆ Be sure to use the appropriate type of overcurrent protection switch. Note that generated overcurrent may include some amount of direct current.

⚠ CAUTION

- ◆ The breakers for current leakage should support Inverter circuit. (e.g. Mitsubishi Electric's NV-S series or equivalent). If no earth leakage breaker is installed, it may cause an electric shock.
- ◆ Breakers for current leakage should combine using of switch.
- ◆ Do not use anything other than a breaker with the correct capacity. Using a breaker of too large capacity may cause malfunction or fire.
- ◆ If a large electric current flows due to malfunction or faulty wiring, earth-leakage breakers on the unit side and on the upstream side of the power supply system may both operate. Depending on the importance of the system, separate the power supply system or take protective coordination of breakers.

Note

- ◆ This device is intended for the connection to a power supply system with a maximum permissible system impedance shown in the above table at the interface point (power service box) of the user's supply.
- ◆ The user must ensure that this device is connected only to a power supply system which fulfils the requirement above. If necessary, the user can ask the public power supply company for the system impedance at the interface point.
- ◆ This equipment complies with IEC 61000-3-12 provided that the short-circuit power Ssc is greater than or equal to Ssc (*2) at the interface point between the user's supply and the public system. It is the responsibility of the installer or user of the equipment to ensure, by consultation with the distribution network operator if necessary, that the equipment is connected only to a supply with a short-circuit power Ssc greater than or equal to Ssc (*2).

Ssc(*2)

Model	Ssc(MVA)
PURY-P200YLM-A1	1.39
PURY-P250YLM-A1	1.77
PURY-P300YLM-A1	2.19
PURY-P350YLM-A1	2.64
PURY-P400YLM-A1	2.98
PURY-P450YLM-A1	3.26
PURY-P500YLM-A1	3.98

PURY-EP-YLM

Thickness of wire for main power supply, capacities of the switch and system impedance

	Model	Minimum wire thickness (mm ²)			Ground-fault interrupter *1	Local switch (A)		Breaker for wiring (A) (Non-fuse breaker)	Max. Permissible System Impedance
		Main cable	Branch	Ground		Capacity	Fuse		
Outdoor unit	PURY-EP200YLM	4.0	-	4.0	30A 100mA 0.1sec. or less	25	25	30	*2
	PURY-EP250YLM	4.0	-	4.0	30A 100mA 0.1sec. or less	32	32	30	*2
	PURY-EP300YLM	4.0	-	4.0	30A 100mA 0.1sec. or less	32	32	30	*2
	PURY-EP350YLM	6.0	-	6.0	40A 100mA 0.1sec. or less	40	40	40	0.23Ω
	PURY-EP400YLM	10.0	-	10.0	60A 100mA 0.1sec. or less	63	63	60	0.20Ω
	PURY-EP450YLM	10.0	-	10.0	60A 100mA 0.1sec. or less	63	63	60	0.19Ω
	PURY-EP500YLM	10.0	-	10.0	60A 100mA 0.1sec. or less	63	63	60	0.15Ω
Total operating current of the indoor unit	F0 = 20A or less *3	1.5	1.5	1.5	Current sensitivity *4	16	16	20	(apply to IEC61000-3-3)
	F0 = 30A or less *3	2.5	2.5	2.5	Current sensitivity *4	25	25	30	(apply to IEC61000-3-3)
	F0 = 40A or less *3	4.0	4.0	4.0	Current sensitivity *4	32	32	40	(apply to IEC61000-3-3)

*1 The Ground-fault interrupter should support Inverter circuit. The Ground-fault interrupter should combine using of local switch or wiring breaker.

*2 Meet technical requirements of IEC61000-3-3

*3 Please take the larger of F1 or F2 as the value for F0.

F1 = Total operating maximum current of the indoor units × 1.2

F2 = {V1 × (Quantity of Type1)/C} + {V1 × (Quantity of Type2)/C} + {V1 × (Quantity of Type3)/C} + {V1 × (Quantity of Others)/C}

Indoor unit		V1	V2
Type1	PLFY-VBM, PMFY-VBM, PEFY-VMS, PCFY-VKM,	18.6	2.4
Type2	PEFY-VMA	38	1.6
Type3	PEFY-VMHS	13.8	4.8
Others	Other indoor unit	0	0

C: Multiple of tripping current at tripping time 0.01s

Please pick up "C" from the tripping characteristic of the breaker.

<Example of "F2" calculation>

*Condition PEFY-VMS × 4 + PEFY-VMA × 1, C = 8 (refer to right sample chart)

F2 = 18.6 × 4/8 + 38 × 1/8

= 14.05

→16 A breaker (Tripping current = 8 × 16 A at 0.01s)

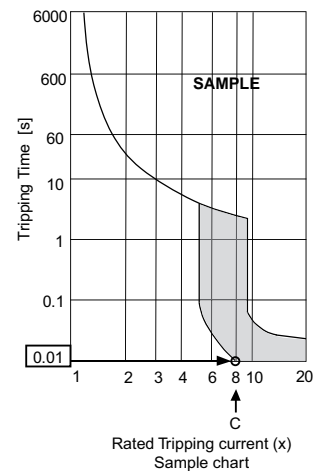

*4 Current sensitivity is calculated using the following formula.

G1 = (V2 × Quantity of Type1) + (V2 × Quantity of Type2) + (V2 × Quantity of Type3) + (V2 × Quantity of Others) + (V3 × Wire length [km])

G1	Current sensitivity
30 or less	30 mA 0.1sec or less
100 or less	100 mA 0.1sec or less

Wire thickness	V3
1.5 mm ²	48
2.5 mm ²	56
4.0 mm ²	66

- Use dedicated power supplies for the outdoor unit and indoor unit. Ensure OC and OS are wired individually.
- Bear in mind ambient conditions (ambient temperature, direct sunlight, rain water, etc.) when proceeding with the wiring and connections.
- The wire size is the minimum value for metal conduit wiring. If the voltage drops, use a wire that is one rank thicker in diameter. Make sure the power-supply voltage does not drop more than 10%. Make sure that the voltage imbalance between the phases is 2% or less.
- Specific wiring requirements should adhere to the wiring regulations of the region.
- Power supply cords of parts of appliances for outdoor use shall not be lighter than polychloroprene sheathed flexible cord (design 60245 IEC57). For example, use wiring such as YZW.
- A switch with at least 3 mm contact separation in each pole shall be provided when the Air Conditioner is installed.

⚠ WARNING

- Be sure to use specified wires for connections and ensure no external force is imparted to terminal connections. If connections are not fixed firmly, heating or fire may result.
- Be sure to use the appropriate type of overcurrent protection switch. Note that generated overcurrent may include some amount of direct current.

⚠ CAUTION

- The breakers for current leakage should support Inverter circuit. (e.g. Mitsubishi Electric's NV-S series or equivalent). If no earth leakage breaker is installed, it may cause an electric shock.
- Breakers for current leakage should combine using of switch.
- Do not use anything other than a breaker with the correct capacity. Using a breaker of too large capacity may cause malfunction or fire.
- If a large electric current flows due to malfunction or faulty wiring, earth-leakage breakers on the unit side and on the upstream side of the power supply system may both operate. Depending on the importance of the system, separate the power supply system or take protective coordination of breakers.

Note

- This device is intended for the connection to a power supply system with a maximum permissible system impedance shown in the above table at the interface point (power service box) of the user's supply.
- The user must ensure that this device is connected only to a power supply system which fulfils the requirement above. If necessary, the user can ask the public power supply company for the system impedance at the interface point.
- This equipment complies with IEC 61000-3-12 provided that the short-circuit power S_{sc} is greater than or equal to S_{sc} (*2) at the interface point between the user's supply and the public system. It is the responsibility of the installer or user of the equipment to ensure, by consultation with the distribution network operator if necessary, that the equipment is connected only to a supply with a short-circuit power S_{sc} greater than or equal to S_{sc} (*2).

S_{sc}(*2)

Model	S _{sc} (MVA)
PURY-EP200YLM	1.39
PURY-EP250YLM	1.77
PURY-EP300YLM	2.19
PURY-EP350YLM	2.64
PURY-EP400YLM	2.98
PURY-EP450YLM	3.26
PURY-EP500YLM	3.98

1-4. Power supply examples

The local standards and/or regulations is applicable at a higher priority.
 1-4-1. PURY-P200, 250, 300, 350, 400, 450, 500YLM-A1

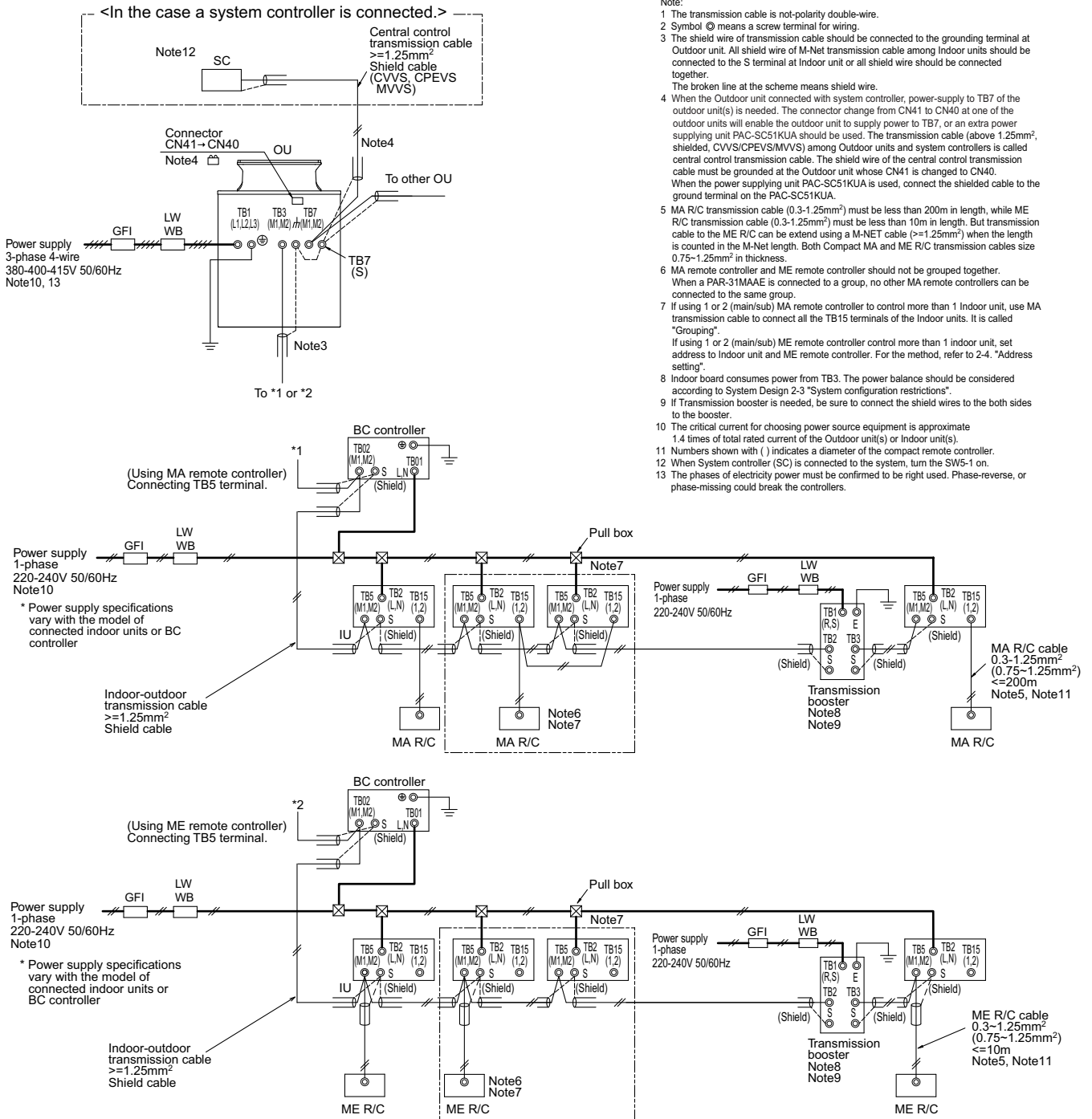

Symbol	Model	Ground-fault interrupter *1, *2, *4	Local switch		Wiring breaker *4	Minimum Wire thickness		
			BKC <A>	OCP*3, *4 <A>	(NFB) <A>	Power wire <mm ² >	Earth wire <mm ² >	
GFI	Ground-fault interrupter	PURY-P200YLM-A1	30A 100mA 0.1sec. or less	25	25	30	4	4
LW	Local switch	PURY-P250YLM-A1	30A 100mA 0.1sec. or less	32	32	30	4	4
BK	Breaker capacity	PURY-P300YLM-A1	30A 100mA 0.1sec. or less	32	32	30	4	4
OCP	Over-current protector	PURY-P350YLM-A1	40A 100mA 0.1sec. or less	40	40	40	6	6
WB	Wiring breaker	PURY-P400YLM-A1	60A 100mA 0.1sec. or less	63	63	60	10	10
NFB	Non-fuse breaker	PURY-P450YLM-A1	60A 100mA 0.1sec. or less	63	63	60	10	10
OU	Outdoor unit	PURY-P500YLM-A1	60A 100mA 0.1sec. or less	63	63	60	10	10

*1 The Ground-fault interrupter should support Inverter circuit. (e.g. Mitsubishi Electric's NV-S series or equivalent).
 *2 Ground-fault interrupter should combine using of local switch or wiring breaker.
 *3 It shows data for B-type fuse of the breaker for current leakage.
 *4 If a large electric current flows due to malfunction or faulty wiring, earth-leakage breakers on the unit side and on the centralized controller side may both operate.
 Depending on the importance of the system, separate the power supply system or take protective coordination of breakers.

The local standards and/or regulations is applicable at a higher priority.
 1-4-2. PURY-EP200, 250, 300, 350, 400, 450, 500YLM-A

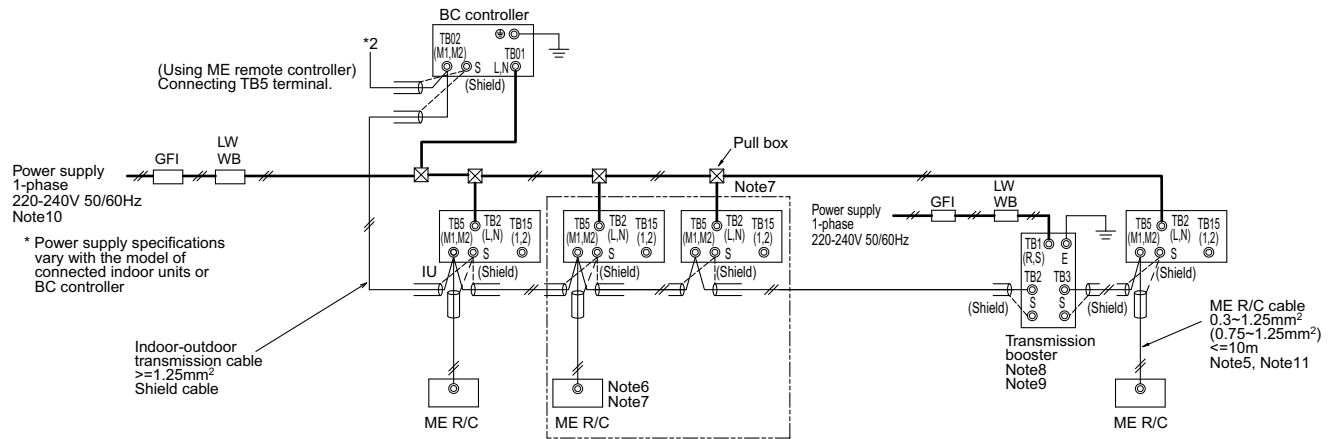
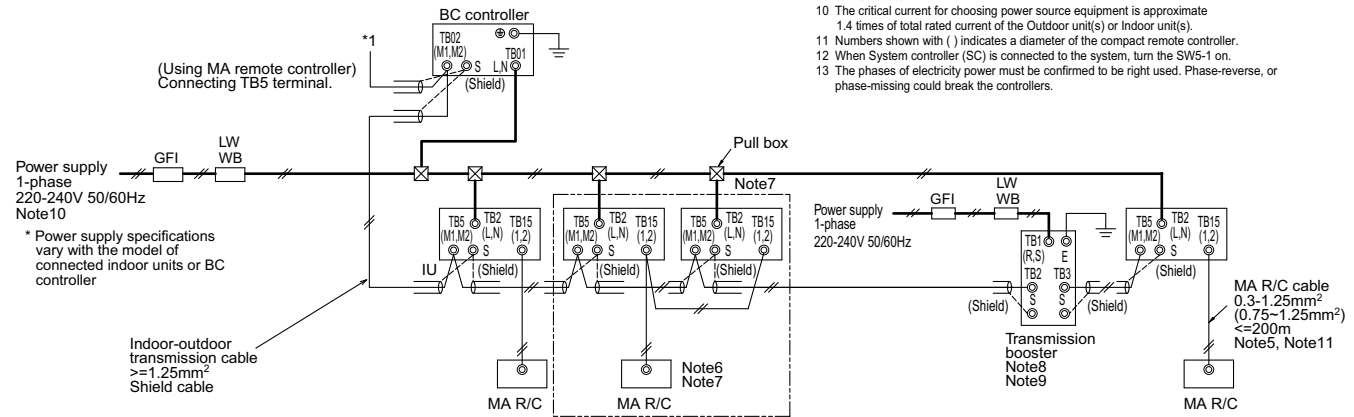
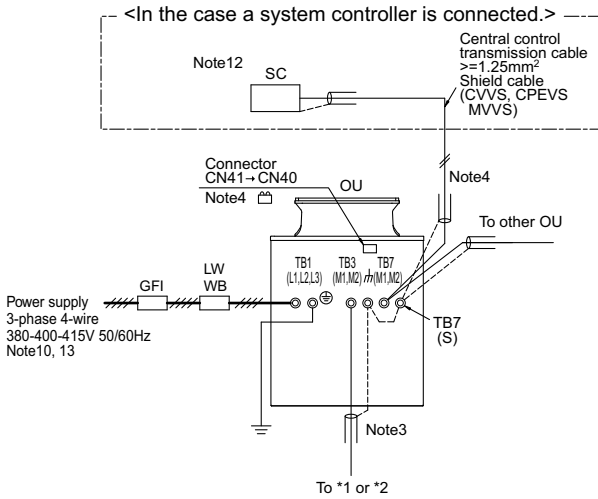

Symbol	Model	Ground-fault interrupter *1, *2, *4	Local switch		Wiring breaker *4 (NFB) <A>	Minimum Wire thickness			
			BKC <A>	OCP*3, *4 <A>		Power wire <mm²>	Earth wire <mm²>		
GFI	Ground-fault interrupter	PURY-EP200YLM	30A	100mA 0.1sec. or less	25	25	30	4	4
LW	Local switch	PURY-EP250YLM	30A	100mA 0.1sec. or less	32	32	30	4	4
BKC	Breaker capacity	PURY-EP300YLM	30A	100mA 0.1sec. or less	32	32	30	4	4
OCP	Over-current protector	PURY-EP350YLM	40A	100mA 0.1sec. or less	40	40	40	6	6
WB	Wiring breaker	PURY-EP400YLM	60A	100mA 0.1sec. or less	63	63	60	10	10
NFB	Non-fuse breaker	PURY-EP450YLM	60A	100mA 0.1sec. or less	63	63	60	10	10
OU	Outdoor unit	PURY-EP500YLM	60A	100mA 0.1sec. or less	63	63	60	10	10

*1 The Ground-fault interrupter should support Inverter circuit. (e.g. Mitsubishi Electric's NV-S series or equivalent).
 *2 Ground-fault interrupter should combine using of local switch or wiring breaker.
 *3 It shows data for B-type fuse of the breaker for current leakage.
 *4 If a large electric current flows due to malfunction or faulty wiring, earth-leakage breakers on the unit side and on the centralized controller side may both operate.
 Depending on the importance of the system, separate the power supply system or take protective coordination of breakers.

- Note:
- The transmission cable is not-polarity double-wire.
 - Symbol © means a screw terminal for wiring.
 - The shield wire of transmission cable should be connected to the grounding terminal at Outdoor unit. All shield wire of M-Net transmission cable among Indoor units should be connected to the S terminal at Indoor unit or all shield wire should be connected together.
The broken line at the scheme means shield wire.
 - When the Outdoor unit connected with system controller, power-supply to TB7 of the outdoor unit(s) is needed. The connector change from CN41 to CN40 at one of the outdoor units will enable the outdoor unit to supply power to TB7, or an extra power supplying unit PAC-SC51KUA should be used. The transmission cable (above 1.25mm², shielded, CVVS/CPEVS/MVVS) among Outdoor units and system controllers is called central control transmission cable. The shield wire of the central control transmission cable must be grounded at the Outdoor unit whose CN41 is changed to CN40. When the power supplying unit PAC-SC51KUA is used, connect the shielded cable to the ground terminal on the PAC-SC51KUA.
 - MA R/C transmission cable (0.3-1.25mm²) must be less than 200m in length, while ME R/C transmission cable (0.3-1.25mm²) must be less than 10m in length. But transmission cable to the ME R/C can be extend using a M-NET cable (>=1.25mm²) when the length is counted in the M-Net length. Both Compact MA and ME R/C transmission cables size 0.75-1.25mm² in thickness.
 - MA remote controller and ME remote controller should not be grouped together. When a PAR-31MAA is connected to a group, no other MA remote controllers can be connected to the same group.
 - If using 1 or 2 (main/sub) MA remote controller to control more than 1 Indoor unit, use MA transmission cable to connect all the TB15 terminals of the Indoor units. It is called "Grouping".
If using 1 or 2 (main/sub) ME remote controller control more than 1 indoor unit, set address to Indoor unit and ME remote controller. For the method, refer to 2-4. "Address setting".
 - Indoor board consumes power from TB3. The power balance should be considered according to System Design 2-3 "System configuration restrictions".
 - If transmission booster is needed, be sure to connect the shield wires to the both sides to the booster.
 - The critical current for choosing power source equipment is approximate 1.4 times of total rated current of the Outdoor unit(s) or Indoor unit(s).
 - Numbers shown with () indicates a diameter of the compact remote controller.
 - When System controller (SC) is connected to the system, turn the SW5-1 on.
 - The phases of electricity power must be confirmed to be right used. Phase-reverse, or phase-missing could break the controllers.

The local standards and/or regulations is applicable at a higher priority.

1-4-3. PURY-P400, 450, 500, 550, 600, 650, 700, 750, 800, 850, 900YSLM-A1

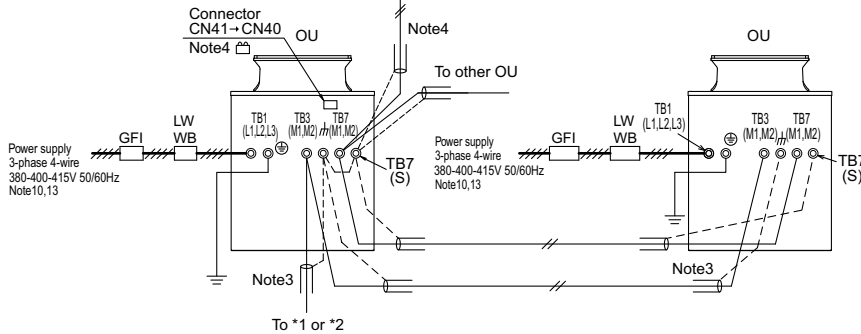
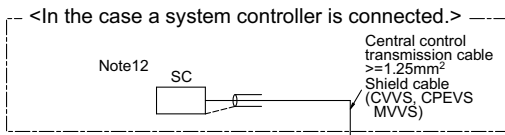

- Note:
- 1 The transmission cable is not-polarity double-wire.
 - 2 Symbol ⊕ means a screw terminal for wiring.
 - 3 The shield wire of transmission cable should be connected to the grounding terminal at Outdoor unit. All shield wire of M-Net transmission cable among Indoor units should be connected to the S terminal at Indoor unit or all shield wire should be connected together.
The broken line at the scheme means shield wire.
 - 4 When the Outdoor unit connected with system controller, power-supply to TB7 of the outdoor unit(s) is needed. The connector change from CN41 to CN40 at one of the outdoor units will enable the outdoor unit to supply power to TB7, or an extra power supplying unit PAC-SC51KUA should be used. The transmission cable (above 1.25mm², shielded, CVVS/CPEVS/MVVS) among Outdoor units and system controllers is called central control transmission cable. The shield wire of the central control transmission cable must be grounded at the Outdoor unit whose CN41 is changed to CN40.
When the power supplying unit PAC-SC51KUA is used, connect the shielded cable to the ground terminal on the PAC-SC51KUA.
 - 5 MA R/C transmission cable (0.3-1.25mm²) must be less than 200m in length, while ME R/C transmission cable (0.3-1.25mm²) must be less than 10m in length. But transmission cable to the ME R/C can be extend using a M-NET cable (≥1.25mm²) when the length is counted in the M-Net length. Both Compact MA and ME R/C transmission cables size 0.75-1.25mm² in thickness.
 - 6 MA remote controller and ME remote controller should not be grouped together. When a PAR-31MAAE is connected to a group, no other MA remote controllers can be connected to the same group.
 - 7 If using 1 or 2 (main/sub) MA remote controller to control more than 1 Indoor unit, use MA transmission cable to connect all the TB15 terminals of the Indoor units. It is called "Grouping".
If using 1 or 2 (main/sub) ME remote controller control more than 1 indoor unit, set address to Indoor unit and ME remote controller. For the method, refer to 2-4. "Address setting".
 - 8 Indoor board consumes power from TB3. The power balance should be considered according to System Design 2-3 "System configuration restrictions".
 - 9 If Transmission booster is needed, be sure to connect the shield wires to the both sides to the booster.
 - 10 The critical current for choosing power source equipment is approximate 1.4 times of total rated current of the Outdoor unit(s) or Indoor unit(s).
 - 11 Numbers shown with () indicates a diameter of the compact remote controller.
 - 12 When System controller (SC) is connected to the system, refer to 2-4. "Address setting".
 - 13 The phases of electricity power must be confirmed to be right used. Phase-reverse, or phase-missing could break the controllers.

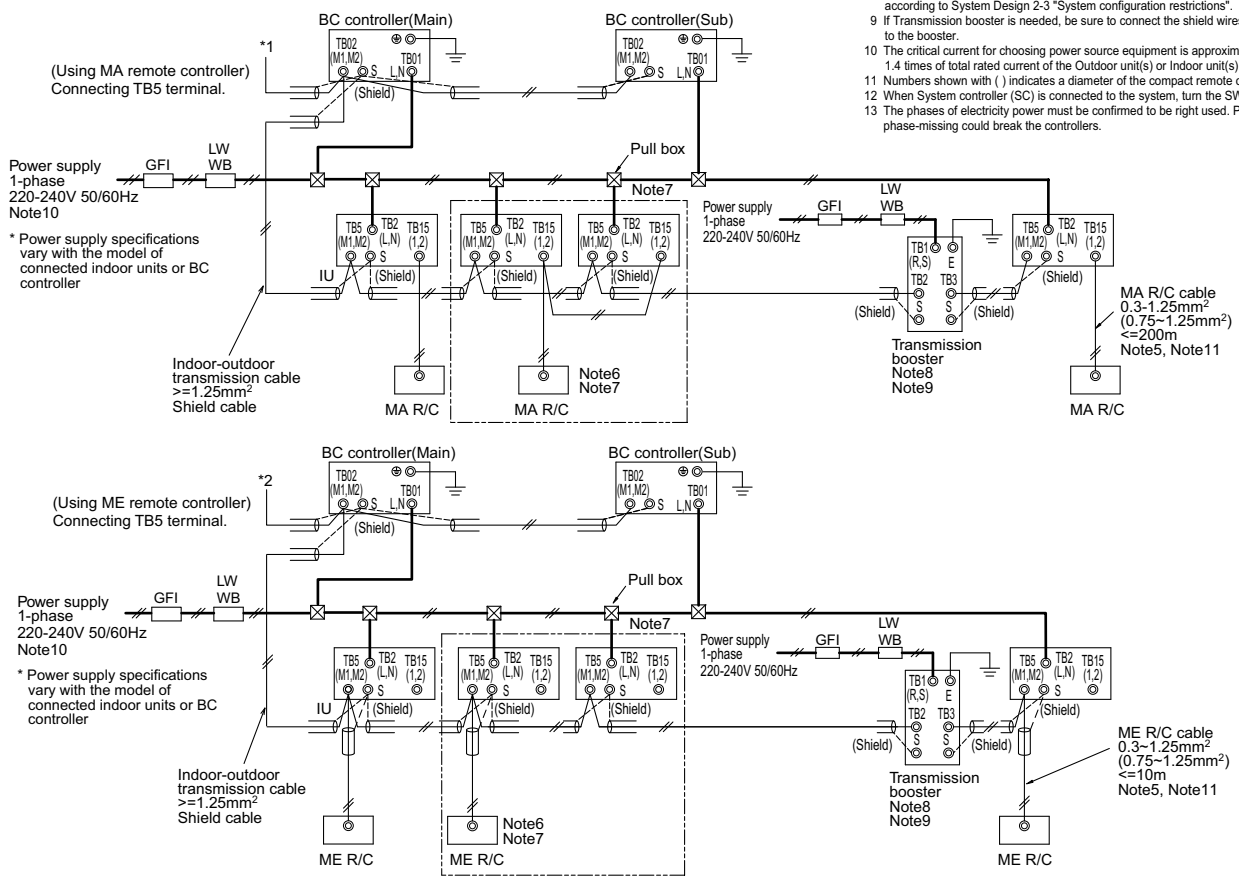

Symbol	Model	Ground-fault interrupter *1, *2, *4	Local switch		Wiring breaker *4 (NFB) <A>	Minimum Wire thickness		
			BKC <A>	OCF*3, *4 <A>		Power wire <mm²>	Earth wire <mm²>	
GFI	Ground-fault interrupter	PURY-P200YLM-A1	30A 100mA 0.1sec. or less	25	25	30	4	4
LW	Local switch	PURY-P250YLM-A1	30A 100mA 0.1sec. or less	32	32	30	4	4
BKC	Breaker capacity	PURY-P300YLM-A1	30A 100mA 0.1sec. or less	32	32	30	4	4
OCF	Over-current protector	PURY-P350YLM-A1	40A 100mA 0.1sec. or less	40	40	40	6	6
WB	Wiring breaker	PURY-P400YLM-A1	60A 100mA 0.1sec. or less	63	63	60	10	10
NFB	Non-fuse breaker	PURY-P450YLM-A1	60A 100mA 0.1sec. or less	63	63	60	10	10

- *1 The Ground-fault interrupter should support Inverter circuit. (e.g. Mitsubishi Electric's NV-S series or equivalent).
- *2 Ground-fault interrupter should combine using of local switch or wiring breaker.
- *3 It shows data for B-type fuse of the breaker for current leakage.
- *4 If a large electric current flows due to malfunction or faulty wiring, earth-leakage breakers on the unit side and on the centralized controller side may both operate.
Depending on the importance of the system, separate the power supply system or take protective coordination of breakers.

S.D.R.2

The local standards and/or regulations is applicable at a higher priority.
 1-4-4. PURY-EP550, 600, 650, 700, 750, 800, 850, 900YSLM-A

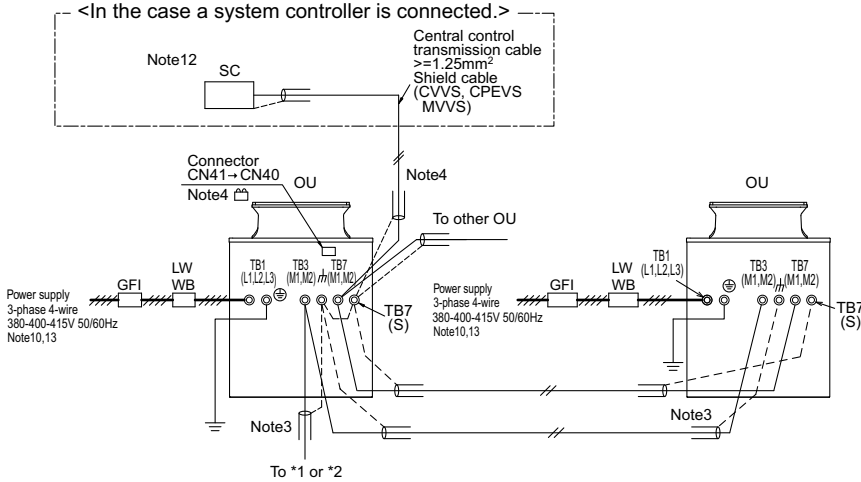

- Note:
- The transmission cable is not-polarity double-wire.
 - Symbol \odot means a screw terminal for wiring.
 - The shield wire of transmission cable should be connected to the grounding terminal at Outdoor unit. All shield wire of M-Net transmission cable among Indoor units should be connected to the S terminal at Indoor unit or all shield wire should be connected together. The broken line at the scheme means shield wire.
 - When the Outdoor unit connected with system controller, power-supply to TB7, or an extra power supplying unit PAC-SC51KUA should be used. The transmission cable (above 1.25mm², shielded, CVVS/CPEVS/MVVS) among Outdoor units and system controllers is called central control transmission cable. The shield wire of the central control transmission cable must be grounded at the Outdoor unit whose CN41 is changed to CN40. When the power supplying unit PAC-SC51KUA is used, connect the shielded cable to the ground terminal on the PAC-SC51KUA.
 - MA R/C transmission cable (0.3-1.25mm²) must be less than 200m in length, while ME R/C transmission cable (0.3-1.25mm²) must be less than 10m in length. But transmission cable to the ME R/C can be extend using a M-Net cable ($\geq 1.25\text{mm}^2$) when the length is counted in the M-Net length. Both Compact MA and ME R/C transmission cables size 0.75-1.25mm² in thickness.
 - MA remote controller and ME remote controller should not be grouped together. When a PAR-31MAA is connected to a group, no other MA remote controllers can be connected to the same group.
 - If using 1 or 2 (main/sub) MA remote controller to control more than 1 Indoor unit, use MA transmission cable to connect all the TB15 terminals of the Indoor units. It is called "Grouping". If using 1 or 2 (main/sub) ME remote controller control more than 1 indoor unit, set address to Indoor unit and ME remote controller. For the method, refer to 2-4. "Address setting".
 - Indoor board consumes power from TB3. The power balance should be considered according to System Design 2-3 "System configuration restrictions".
 - If Transmission booster is needed, be sure to connect the shield wires to the both sides to the booster.
 - The critical current for choosing power source equipment is approximate 1.4 times of total rated current of the Outdoor unit(s) or Indoor unit(s).
 - Numbers shown with () indicates a diameter of the compact remote controller.
 - When System controller (SC) is connected to the system, turn the SWS-1 on.
 - The phases of electricity power must be confirmed to be right used. Phase-reverse, or phase-missing could break the controllers.

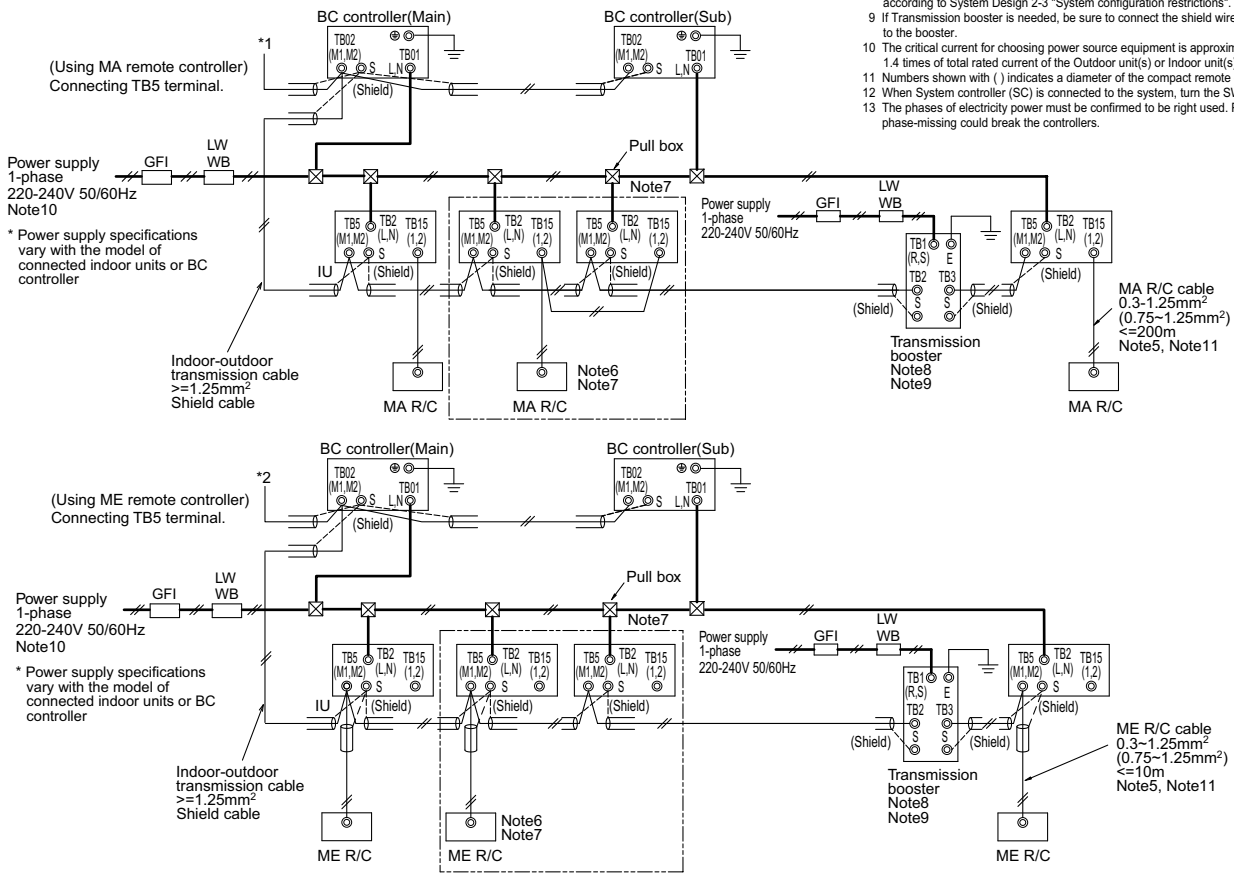

Symbol	Model	Ground-fault interrupter *1, *2, *4	Local switch		Wiring breaker *4	Minimum Wire thickness			
			BKC <A>	OC*3, *4 <A>	(NFB) <A>	Power wire <mm ² >	Earth wire <mm ² >		
GFI	Ground-fault interrupter	PURY-EP200YLM	30A	100mA 0.1sec. or less	25	25	30	4	4
LW	Local switch	PURY-EP250YLM	30A	100mA 0.1sec. or less	32	32	30	4	4
BKC	Breaker capacity	PURY-EP300YLM	30A	100mA 0.1sec. or less	32	32	30	4	4
OC*3	Over-current protector	PURY-EP350YLM	40A	100mA 0.1sec. or less	40	40	40	6	6
WB	Wiring breaker	PURY-EP400YLM	60A	100mA 0.1sec. or less	63	63	60	10	10
NFB	Non-fuse breaker	PURY-EP450YLM	60A	100mA 0.1sec. or less	63	63	60	10	10

*1 The Ground-fault interrupter should support Inverter circuit. (e.g. Mitsubishi Electric's NV-S series or equivalent).

*2 Ground-fault interrupter should combine using of local switch or wiring breaker.

*3 It shows data for B-type fuse of the breaker for current leakage.

*4 If a large electric current flows due to malfunction or faulty wiring, earth-leakage breakers on the unit side and on the centralized controller side may both operate.

Depending on the importance of the system, separate the power supply system or take protective coordination of breakers.

2-1. Transmission cable length limitation

2-1-1. Using MA Remote controller

Long transmission cable causes voltage down, therefore, the length limitation should be obeyed to secure proper transmission.

Max. length via Outdoor (M-NET cable)	$L1+L2+L3+L4, L1+L2+L6+L7, L3+L4+L6+L7$	$\leq 500\text{m}[1640\text{ft.}]$	1.25mm ² [AWG16] or thicker
Max. length to Outdoor (M-NET cable)	$L1+L8, L3+L4, L6, L2+L6+L8, L7$	$\leq 200\text{m}[656\text{ft.}]$	1.25mm ² [AWG16] or thicker
Max. length from MA to Indoor	$a1+a2, a1+a2+a3+a4$	$\leq 200\text{m}[656\text{ft.}]$	0.3-1.25 mm ² [AWG22-16]
24VDC to AG-150A	n	$\leq 50\text{m}[164\text{ft.}]$	0.75-2.0 mm ² [AWG18-14]

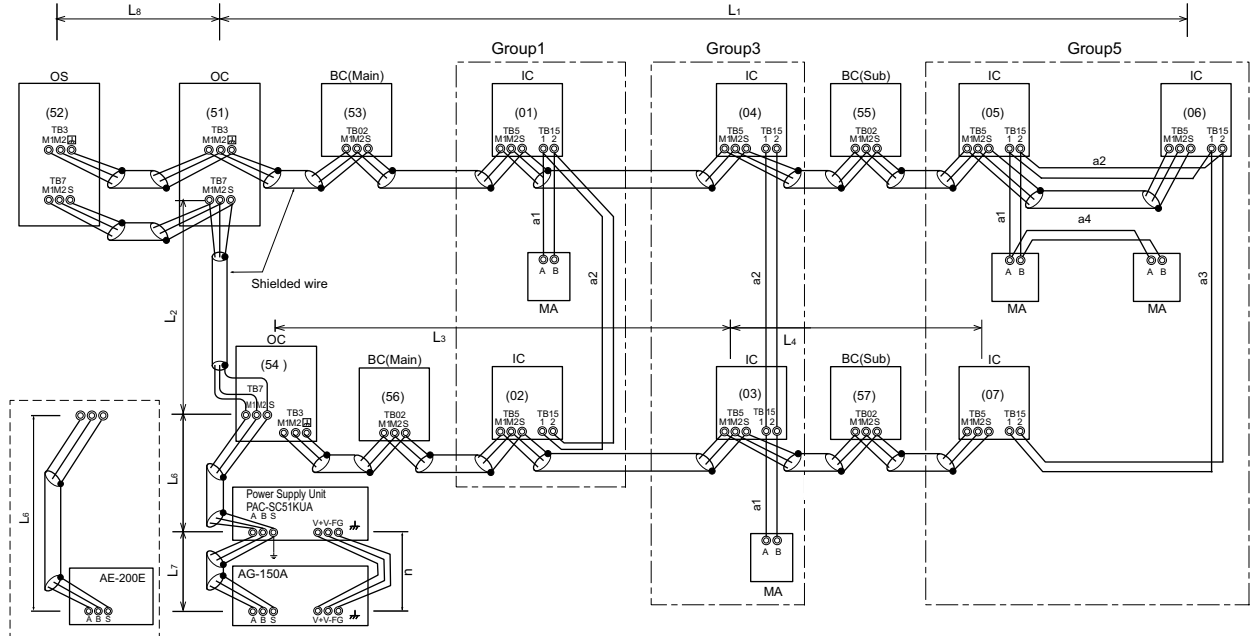

OC, OS: Outdoor unit controller; IC: Indoor unit controller; MA: MA remote controller

2-1-2. Using ME Remote controller

Long transmission cable causes voltage down, therefore, the length limitation should be obeyed to secure proper transmission.

Max. length via Outdoor (M-NET cable)	$L1+L2+L3+L4, L1+L2+L6+L7, L1+L2+L3+L5, L3+L4+L6+L7$	$\leq 500\text{m}[1640\text{ft.}]$	1.25mm ² [AWG16] or thicker
Max. length to Outdoor (M-NET cable)	$L1+L8, L3+L4, L6, L2+L6+L8, L7, L3+L5$	$\leq 200\text{m}[656\text{ft.}]$	1.25mm ² [AWG16] or thicker
Max. length from ME to Indoor	$e1, e2+e3, e4$	$\leq 10\text{m}[32\text{ft.}] * 1$	0.3-1.25 mm ² [AWG22-16] * 1
24VDC to AG-150A	n	$\leq 50\text{m}[164\text{ft.}]$	0.75-2.0 mm ² [AWG18-14]

*1. If the length from ME to Indoor exceed 10m, use 1.25 mm² [AWG16] shielded cable, but the total length should be counted into Max. length via Outdoor.

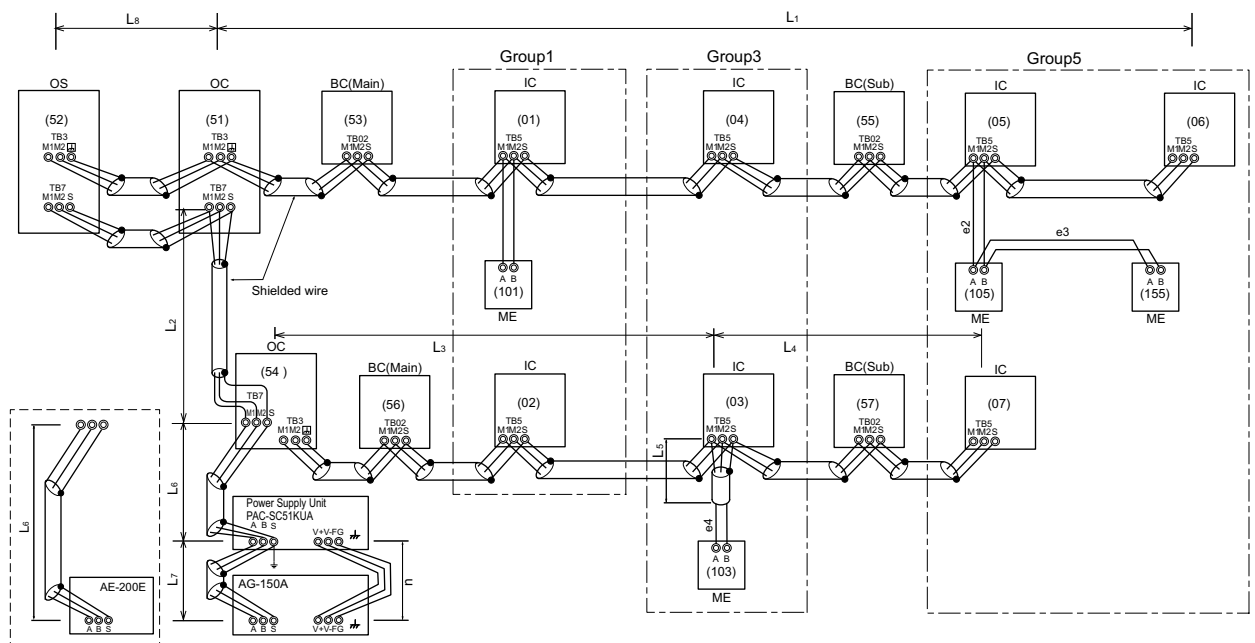

OC, OS: Outdoor unit controller; IC: Indoor unit controller; ME: ME remote controller

S.D.R2

2-2. Transmission cable specifications

	Transmission cables (Li)	M-NET remote controller cables	MA Remote controller cables
Type of cable	Shielding wire (2-core) CVVS, CPEVS or MVVS	Sheathed 2-core cable (unshielded) CVV	
Cable size	More than 1.25 mm ² [AWG16]	0.3 ~ 1.25 mm ² [AWG22~16] (0.75 ~ 1.25 mm ² [AWG18~16])*1	0.3 ~ 1.25 mm ² [AWG22 ~16] *2
Remarks	Max length: within 200 m	When 10 m [32ft] is exceeded, use cables with the same specification as transmission cables.	Max length: 200 m [656ft] *3

*1 Connected with PZ-52SF.

*2 To wire PAR-31MAA(E), Simple MA remote controller use a wire with a diameter of 0.3 mm² [AWG22]

*3 When a PAR-31MAA(E) and other MA remote controllers are connected in the same group, the maximum length of cable should be 100 m.

CVVS, MVVS: PVC insulated PVC jacketed shielded control cable
CPEVS: PE insulated PVC jacketed shielded communication cable
CVV: PV insulated PVC sheathed control cable

2-3. System configuration restrictions

2-3-1. Common restrictions for the CITYMULTI system

For each Outdoor unit, the maximum connectable quantity of Indoor unit is specified at its Specifications table.

- A) 1 Group of Indoor units can have 1-16 Indoor units;
*OA processing unit GUF-RD(H) is considered as Indoor unit.
- B) Maximum 2 remote controllers for 1 Group;
*MA/ME remote controllers cannot be present together in 1group.
*When a PAR-31MAA(E) is connected to a group, no other MA remote controllers can be connected to the same group.
- C) 1 LOSSNAY unit can interlock maximum 16 Indoor units; 1 Indoor unit can interlock only 1 LOSSNAY unit.
- D) Maximum 3 System controllers are connectable when connecting to TB3 of the Outdoor unit.
- E) Maximum 6 System controllers are connectable when connecting to TB7 of the Outdoor unit, if the transmission power is supplied by the Outdoor unit.
- F) 4 System controllers or more are connectable when connecting to TB7 of the Outdoor unit, if the transmission power is supplied by the power supply unit PAC-SC51KUA. Details refer to 2-3-3-C.
*System controller connected as described in D) and E) would have a risk that the failure of connected Outdoor unit would stop power supply to the System controller.

2-3-2. Ensuring proper communication power for M-NET

In order to ensure proper communication among Outdoor unit, Indoor unit, LOSSNAY, and OA processing unit GUF-RD(H), and Controllers, the transmission power situation for the M-NET should be observed. In some cases, Transmission booster should be used. Taking the power consumption of Indoor unit sized P15-P140 as 1, the equivalent power consumption or supply of others are listed at Table 2-3-1 and Table 2-3-2.

Table 2-3-1 The equivalent power consumption

Indoor, OA unit	Indoor unit	BC controller	PWFY			MARC. LOSSNAY	ME Remote Contr.		System Contr.			ON/OFF Contr.	MN Converter	Outdoor unit
Sized P15-P140 GUF-50, 100	Sized P200, P250	CMB	P100VM -E-BU	P100VM -E1-AU P100VM -E2-AU	P200VM -E1-AU P200VM -E2-AU	PAR-31MAA(E) PAC-YT52CRA PAR-FA32MA LGH-RVX-E PZ-61DR-E PZ-43SMF-E	PAC-YG60MCA PAC-YG66DCA PAC-YG63MCA	PAR-U02MEDA PAC-IF01AHC	AE-200E AE-50E	AG-150A EB-50GU-J	AT-50B	PAC -YT40ANRA	CMS-MNG-E	TB7 power consumption
1	7	2	6	1	5	0	1/4	1/2	0	1/2	4	1	2	0

*RC : Remote Controller

Table 2-3-2 The equivalent power supply

Transmission Booster	Power supply unit	Expansion controller	BM ADAPTER	System Controller		Outdoor unit	Outdoor unit
PAC-SF46EPA	PAC-SC51KUA	PAC-YG50ECA	BAC-HD150	AE-200E/AE-50E	GB-50ADA-J	Connector TB3 and TB7 total *	Connector TB7 only
25	5	6	6	0 ¹⁾	6	32	6

*If PAC-SC51KUA is used to supply power at TB7 side, no power supply need from Outdoor unit at TB7, Connector TB3 itself will therefore have 32. Not applicable to the PUMY model.

*1 AE-200E/AE-50E has a built-in function to supply power to the M-NET transmission line. The amount of power that an AE-200E or an AE-50E can supply is equivalent to the power required by an MN converter (CMS-MNG-E) that is used for maintenance.

With the equivalent power consumption values in Table 2-3-1 and Table 2-3-2, PAC-SF46EPA can be designed into the air-conditioner system to ensure proper system communication according to 2-3-2-A, B, C.

- 2-3-2-A) Firstly, count from TB3 at TB3 side the total quantity of Indoor units, OA processing units, ME remote controller, and System controllers. If the total quantity reaches 40, a PAC-SF46EPA should be set. In this case, Indoor units sized P200 and 250 are counted as 2 indoor units, but MA remote controller(s), PZ-61DR-E, and PZ-43SMF-E are NOT counted.
- 2-3-2-B) Secondly, count from TB7 side to TB3 side the total transmission power consumption. If the total power consumption reaches 32, a PAC-SF46EPA should be set. Yet, if a PAC-SC51KUA or another controller with a built-in power supply, such as PAC-YG50ECA, is used to supply power at TB7 side, count from TB3 side only.
- 2-3-2-C) Thirdly, count from TB7 at TB7 side the total transmission power consumption, If the total power consumption reaches 6, a PAC-SF46EPA should be set.

■ System example

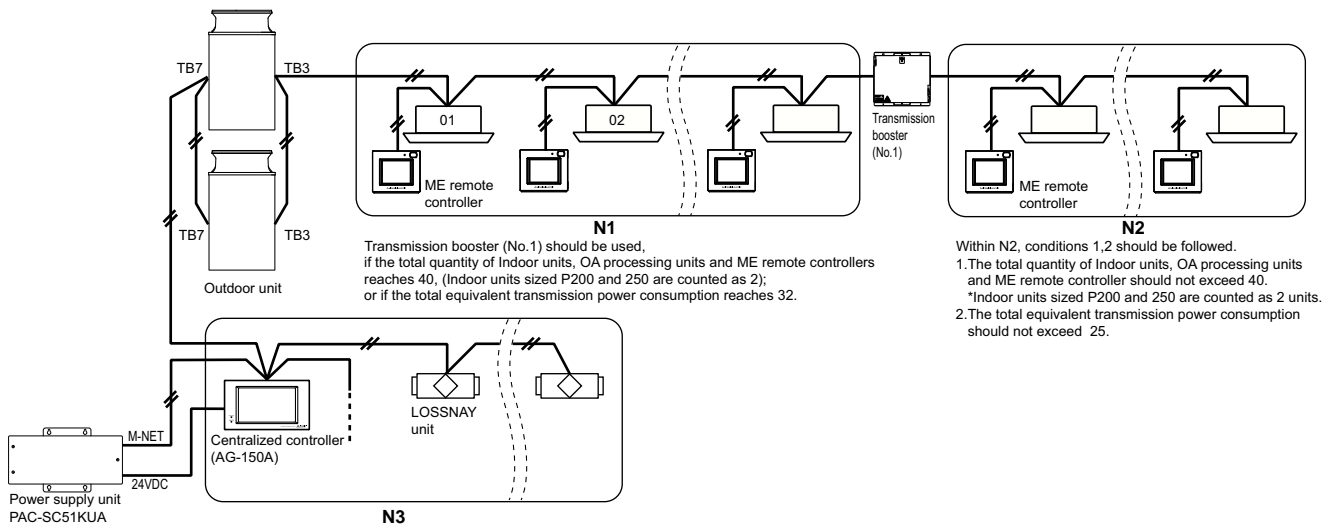

2-3-3. Ensuring proper power supply to System controller

The power to System controller (excluding AE-200E, AE-50E, BAC-HD150, LM-AP) is supplied via M-NET transmission line. M-NET transmission line at TB7 side is called Centralized control transmission line while one at TB3 side is called Indoor-Outdoor transmission line. There are 3 ways to supply power to the System controller .

- A) Connecting to TB3 of the Outdoor unit and receiving power from the Outdoor unit.
- B) Connecting to TB7 of the Outdoor unit and receiving power from the Outdoor unit.
- C) Connecting to TB7 of the Outdoor unit but receiving power from power supply unit PAC-SC51KUA.

* System controllers (AE-200E, AE-50E, BAC-HD150, LM-AP) have a built-in function to supply power to the M-NET transmission lines, so no power needs to be supplied to the M-NET transmission lines from the outdoor units or from PAC-SC51KUA.

2-3-3-A. When connecting to TB3 of the Outdoor unit and receiving power from the Outdoor unit.

Maximum 3 System controllers can be connected to TB3. If there is more than 1 Outdoor unit, it is necessary to replace power supply switch connector CN41 with CN40 on one Outdoor unit.

Fig. 2-3-3-A

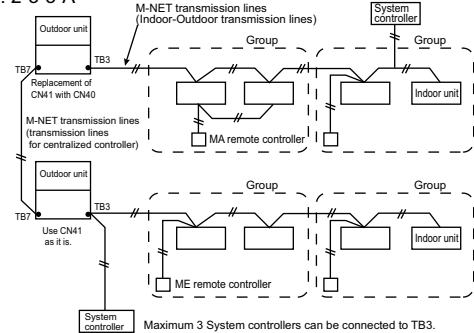

2-3-3-B. When connecting to TB7 of the Outdoor unit and receiving power from the Outdoor unit.

Maximum 6 System controllers can be connected to TB7 and receiving power from the Outdoor unit. It is necessary to replace power supply switch connector CN41 with CN40 on one Outdoor unit.

Fig. 2-3-3-B

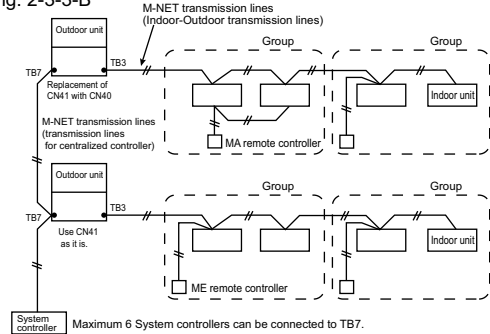

2-3-3-C. When connecting to TB7 of the Outdoor unit but receiving power from PAC-SC51KUA.

When using PAC-SC51KUA to supply transmission power, the power supply connector CN41 on the Outdoor units should be kept as it is. It is also a factory setting. 1 PAC-SC51KUA supports maximum 1 AG-150A unit due to the limited power 24VDC at its TB3. However, 1 PAC-SC51KUA supplies transmission power at its TB2 equal to 5 Indoor units, which is referable at Table 2-3-2. If PZ-52SF-E, System controller, ON/OFF controller connected to TB7 consume transmission power more than 5 (Indoor units), Transmission booster PAC-SF46EPA is needed. PAC-SF46EPA supplies transmission power equal to 25 Indoor units.

Fig. 2-3-3-C

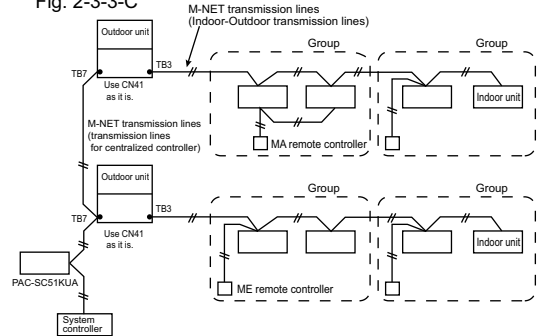

CAUTION

- AG-150A*1 is recommended to connect to TB7 because it performs back-up to a number of data. In an air conditioner system has more than 1 Outdoor units, AG-150A receiving transmission power through TB7 on one of the Outdoor units would have a risk that the connected Outdoor unit failure would stop power supply to AG-150A, and disrupt the whole system. When applying apportioned electric power function, AG-150A is necessary to be connected to TB7 and has its own power supply unit PAC-SC51KUA.*2
- *1: AG-150A is an example model of system controllers.
- *2: Power supply unit PAC-SC51KUA is for AG-150A.

- How to connect system controllers (AE-200E, AE-50E, BAC-HD150, LM-AP) to a given system
System controllers (AE-200E, AE-50E, BAC-HD150, LM-AP) have a built-in function to supply power to the M-NET transmission lines, so no power needs to be supplied to the M-NET transmission lines from the outdoor units or from PAC-SC51KUA. Leave the power supply connector on the outdoor unit connected to CN41 as it is. Refer to 2-3-2 for information about the power-supply capacity of each system controller (AE-200E, AE-50E, BAC-HD150, LM-AP) to the low-level system controllers.

Fig. 2-3-3-D

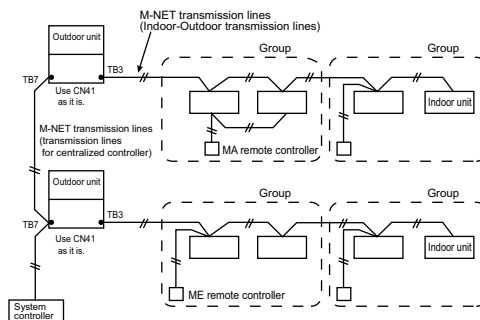

2-3-4. Power supply to LM-AP

1-phase 220-240VAC power supply is needed.

The power supply unit PAC-SC51KUA is not necessary when connecting only the LM-AP. Yet, make sure to change the power supply changeover connector CN41 to CN40 on the LM-AP.

2-3-5. Power supply to expansion controller

1-phase 100-240VAC power supply is needed.

The power supply unit PAC-SC51KUA is not necessary.

The expansion controller supplies power through TB3, which equals 6 indoor units. (refer to Table 2-3-2)

2-3-6. Power supply to BM ADAPTER

1-phase 100-240VAC power supply is needed.

The power supply unit PAC-SC51KUA is not necessary when only BM ADAPTER is connected.

Yet, make sure to move the power jumper from CN41 to CN40 on the BM ADAPTER.

2-3-7. Power supply to GB-50ADA-J

1-phase 100-240VAC power supply is needed.

The power supply unit PAC-SC51KUA is not necessary.

GB-50ADA-J supplies power through TB3, which equals 6 indoor units. (refer to Table 2-3-2)

2-3-8. Power supply to AE-200E/AE-50E

1-phase 100-240VAC power supply is needed.

The power supply unit PAC-SC51KUA is not necessary when connecting only the AE-200E/AE-50E.

2-4. Address setting

2-4-1. Switch operation

In order to constitute CITY MULTI in a complete system, switch operation for setting the unit address No. and connection No. is required.

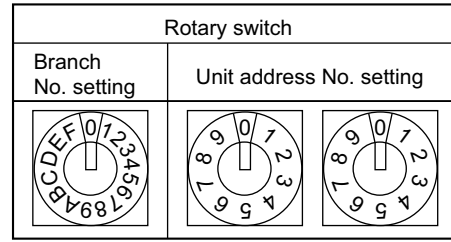

- ① Address No. of outdoor unit, indoor unit and remote controller. The address No. is set at the address setting board. In the case of R2 system, it is necessary to set the same No. at the branch No. switch of indoor unit as that of the BC controller connected. (When connecting two or more branches, use the lowest branch No.)

② Caution for switch operations

- Be sure to shut off power source before switch setting. If operated with power source on, switch can not operate properly.
- No units with identical unit address shall exist in one whole air conditioner system. If set erroneously, the system can not operate.

③ MA remote controller

- When connecting only one remote controller to one group, it is always the main remote controller. When connecting two remote controllers to one group, set one remote controller as the main remote controller and the other as the sub remote controller.
- The factory setting is "Main".

PAR-31MAA(E)

The MA remote controller does not have the switches listed above. Refer to the installation manual for the function setting.























PAC-YT52CRA

Setting the dip switches

There are switches on the back of the top case. Remote controller Main/Sub and other function settings are performed using these switches. Ordinarily, only change the Main/Sub setting of SW1. (The factory settings are ON for SW1, 2, and 3 and OFF for SW4.)

SW No.	SW contents Main	ON	OFF	Comment
1	Remote controller Main/Sub setting	Main	Sub	Set one of the two remote controllers at one group to "ON".
2	Temperature display units setting	Celsius	Fahrenheit	When the temperature is displayed in [Fahrenheit], set to "OFF".
3	Cooling/heating display in AUTO mode	Yes	No	When you do not want to display "Cooling" and "Heating" in the AUTO mode, set to "OFF".
4	Indoor temperature display	Yes	No	When you want to display the indoor temperature, set to "ON".

2-4-2. Rule of setting address

Unit	Address setting	Example	Note	
Indoor unit	01 ~ 50	 	Use the most recent address within the same group of indoor units. Make the indoor units address connected to the BC controller (Sub) larger than the indoor units address connected to the BC controller (Main). If applicable, set the sub BC controllers in an PURY system in the following order: (1) Indoor unit to be connected to the BC controller (Main) (2) Indoor unit to be connected to the BC controller (No.1 Sub) (3) Indoor unit to be connected to the BC controller (No.2 Sub) Set the address so that (1)<(2)<(3)	
Outdoor unit	51 ~ 99, 100 (Note1)	 	The smallest address of indoor unit in same refrigerant system + 50 Assign sequential address numbers to the outdoor units in one refrigerant circuit system. OC, OS1 and OS2 are automatically detected. (Note 2) * Please reset one of them to an address between 51 and 99 when two addresses overlap. * The address automatically becomes "100" if it is set as "01~ 50"	
BC controller (Main)	52 ~ 99, 100	 	The address of outdoor unit + 1 * Please reset one of them to an address between 51 and 99 when two addresses overlap. * The address automatically becomes "100" if it is set as "01~ 50"	
BC controller (Sub)	52 ~ 99, 100	 	Lowest address within the indoor units connected to the BC controller (Sub) plus 50.	
Local remote controller	ME Remote controller (Main)	101 ~ 150 1 Fixed	 	The smallest address of indoor unit in the group + 100 *The place of "100" is fixed to "1"
	ME Remote controller (Sub)	151 ~ 199, 200 1 Fixed	 	The address of main remote controller + 50 *The address automatically becomes "200" if it is set as "00"
System controller	ON/OFF remote controller	000, 201 ~ 250   	The smallest group No. to be managed + 200 * The smallest group No. to be managed is changeable.	
	AE-200E/AE-50E AG-150A GB-50ADA-J AT-50B EB-50GU-J	000, 201 ~ 250 0,2  0~5  0~9		
	PAC-YG50ECA	000, 201 ~ 250 0,2  0~5  0~9	* Settings are made on the initial screen of AG-150A.	
	BAC-HD150	000, 201 ~ 250 0,2  0~5  0~9	* Settings are made with setting tool of BM ADAPTER.	
	LMAP04-E	201 ~ 250 2 Fixed  		

Note1: To set the address to "100", set it to "50"

Note2: Outdoor units OC, OS1 and OS2 in one refrigerant circuit system are automatically detected.

OC, OS1 and OS2 are ranked in descending order of capacity. If units are the same capacity, they are ranked in ascending order of their address.

2-4-3. System examples

Factory setting

Original switch setting of the outdoors, indoors, controllers, LM-AP and BM ADAPTER at shipment is as follows.

- Outdoor unit : Address: 00, CN41: ON (Jumper), DipSW5-1: OFF
- Indoor unit : Address: 00
- BC controller : Address: 00
- ME remote controller : Address: 101
- LM-AP : Address: 247, CN41: ON (Jumper), DipSW1-2: OFF
- BM ADAPTER : Address: 000, CN41: ON (Jumper)
- AE-200E/AE-50E : Address: 000, CN21: ON (Jumper)

Setting at the site

- DipSW5-1(Outdoor) : When the System Controller is used, all the Dip SW5-1 at the outdoor units should be set to "ON". * Dip SW5-1 remains OFF when only LM-AP is used.
- DipSW4-6(BC controller) : Set DipSW 4-6 to ON at BC controller, in case of connected Indoor unit sized P100-P140 with 2 ports. It is also possible to connect Indoor unit sized P100-P140 with 1 port (set DipSW 4-6 to OFF).
- DipSW1-2(LM-AP) : When the LM-AP is used together with System Controller, DipSW1-2 at the LM-AP should be set to "ON".
- CN40/CN41 : Change jumper from CN41 to CN 40 at outdoor control board will activate central transmission power supply to TB7;
(Change jumper at only one outdoor unit when activating the transmission power supply without using a power supply unit.)
Change jumper from CN41 to CN 40 at LM-AP/BM ADAPTER will activate transmission power supply to LM-AP/BM ADAPTER itself;
Power supply unit is recommended to use for a system having more than 1 outdoor unit, because the central transmission power supply from TB7 of one of outdoor units is risking that the outdoor unit failure may let down the whole system controller system.
- CN21(AE-200E/AE-50E) : Activates the power supply to M-NET transmission line from AE-200E/AE-50E (CN21: ON (power supplied), OFF (power not supplied))

2-4-3-1. MA remote controller, Single-refrigerant-system, No System Controller

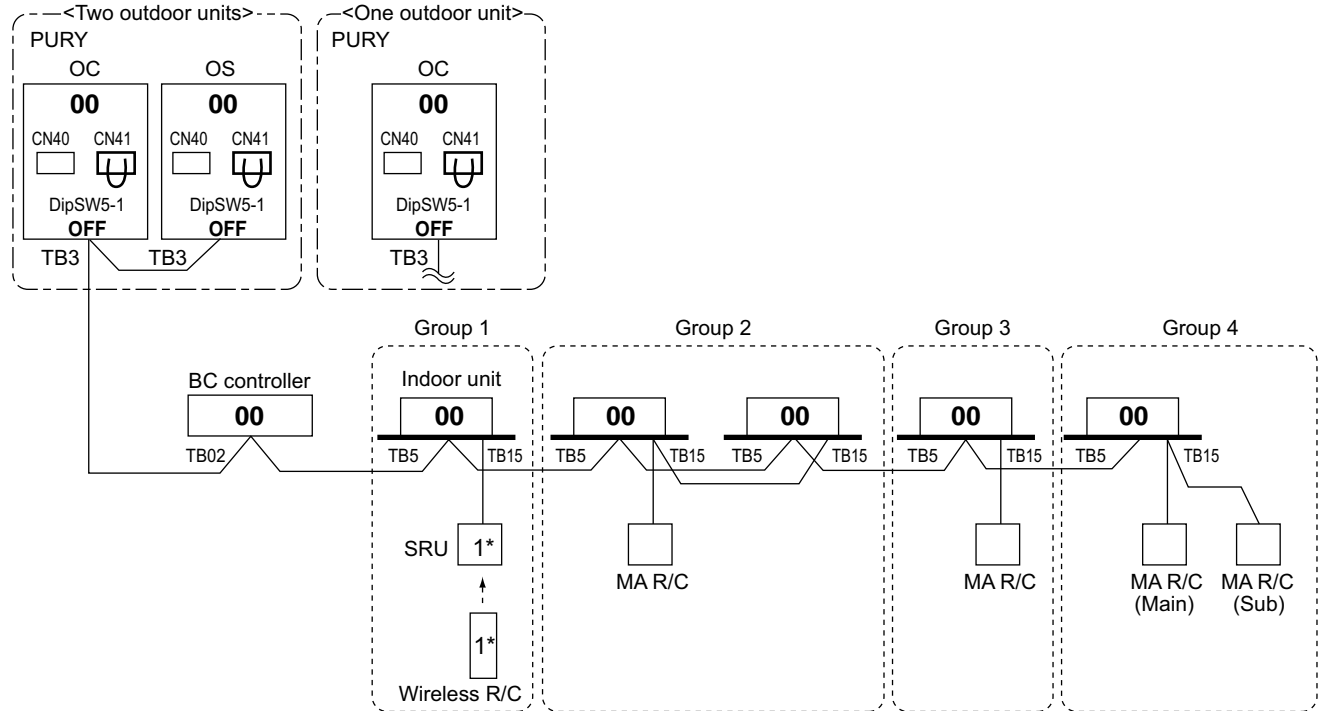

*1 For Wireless R/C and Signal receiver unit (SRU), channel 1, 2 and 3 are selectable and should be set to same channel.

NOTE:

1. Outdoor units OC and OS in one refrigerant circuit system are automatically detected. OC and OS are ranked in descending order of capacity. If units are the same capacity, they are ranked in ascending order of their address.
2. No address setting is needed.
3. For a system having more than 32 indoor unit (P15-P140), confirm the need of Booster at 2-3 "System configuration restrictions".
4. Indoor units should be set with a branch number.
5. Address setting is required if a sub BC controller is connected.
6. When a PAR-31MAA(E) is connected to a group, no other MA remote controllers can be connected to the same group.

2-4-3-2. MA remote controller, Single-refrigerant-system, System Controller

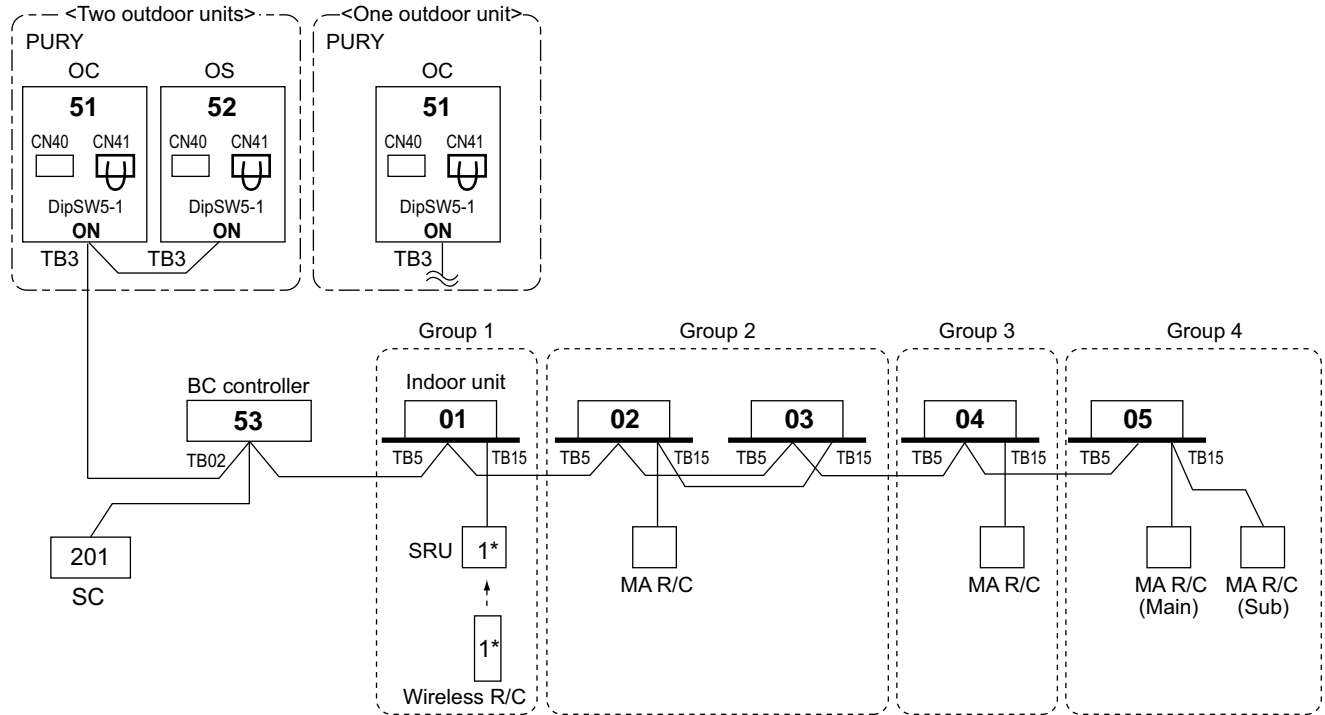

*1 For Wireless R/C and Signal receiver unit (SRU), channel 1, 2 and 3 are selectable and should be set to same channel.

*SC can be connected to TB3 side or TB7 side;

Should SC connected to TB7 side, change Jumper from CN41 to CN40 at the Outdoor unit module so as to supply power to the SC.

NOTE:

1. Outdoor units OC and OS in one refrigerant circuit system are automatically detected. OC and OS are ranked in descending order of capacity. If units are the same capacity, they are ranked in ascending order of their address.
2. Address should be set to Indoor units and centralized controller.
3. For a system having more than 32 indoor unit (P15-P140), confirm the need of Booster at 2-3 "System configuration restrictions".
4. Indoor units should be set with a branch number.
5. When a PAR-31MAA(E) is connected to a group, no other MA remote controllers can be connected to the same group.

2-4-3-3. MA remote controller, Multi-refrigerant-system, System Controller at TB7/TB3 side, Booster for long M-NET wiring

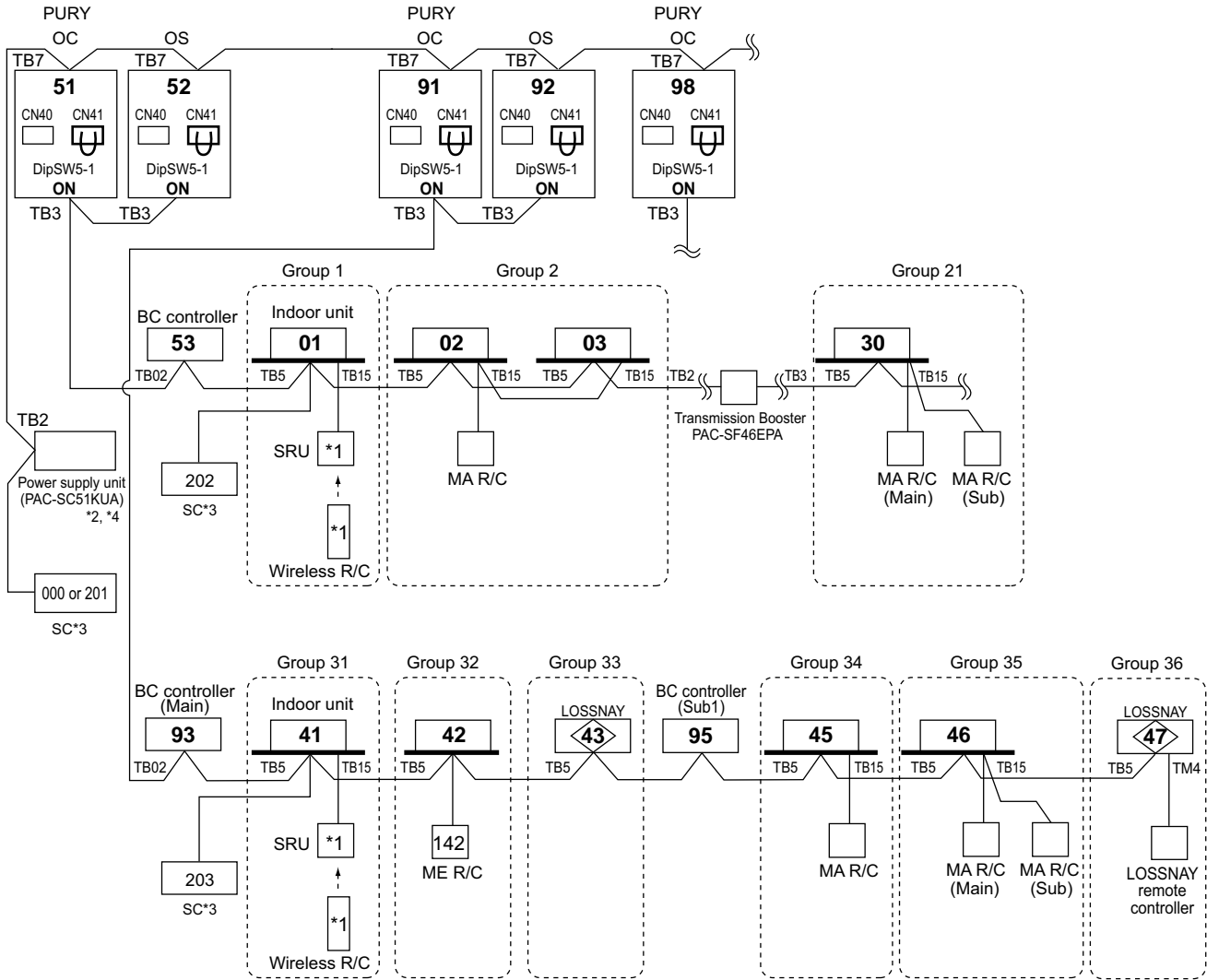

- *1 For Wireless R/C and Signal receiver unit (SRU), channel 1, 2 and 3 are selectable and should be set to same channel.
- *2 System controller should connect to TB7 at Outdoor and use power supply unit together in Multi-Refrigerant-System.
For AG-150A, 24VDC should be used with the PAC-SC51KUA. For AE-200E/AE-50E, the power supply unit PAC-SC51KUA is unused.
- *3 When multiple system controllers are connected in the system, set the controller with more functions than others as a "main" controller and others as "sub".
AE-200E and GB-50ADA-J are for exclusive use as a "main" system controller and cannot be used as a "sub" system controller.
Make the setting to only one of the system controllers for "prohibition of operation from local remote controller".
- *4 The power supply unit is not necessary for AE-200E, AE-50E, BAC-HD150, and LM-AP.

NOTE:

1. Outdoor units OC and OS in one refrigerant circuit system are automatically detected.
OC and OS are ranked in descending order of capacity. If units are the same capacity, they are ranked in ascending order of their address.
2. Address should be set to Indoor units, LOSSNAY and system controller.
3. M-NET power is supplied by the Outdoor unit at TB3, while Indoor unit and ME remote controller consume the M-NET power for transmission use. The power balance is needed to consider for long M-NET wiring. Details refer to 2-3 "System configuration restrictions".
4. Indoor units should be set with a branch number.
5. Assign an address to each of the sub BC controllers which equals the sum of the smallest address of the indoor units that are connected to each sub BC controller and 50.
6. When a PAR-31MAA(E) is connected to a group, no other MA remote controllers can be connected to the same group.

2-4-3-4. ME remote controller, Single-refrigerant-system, No system controller

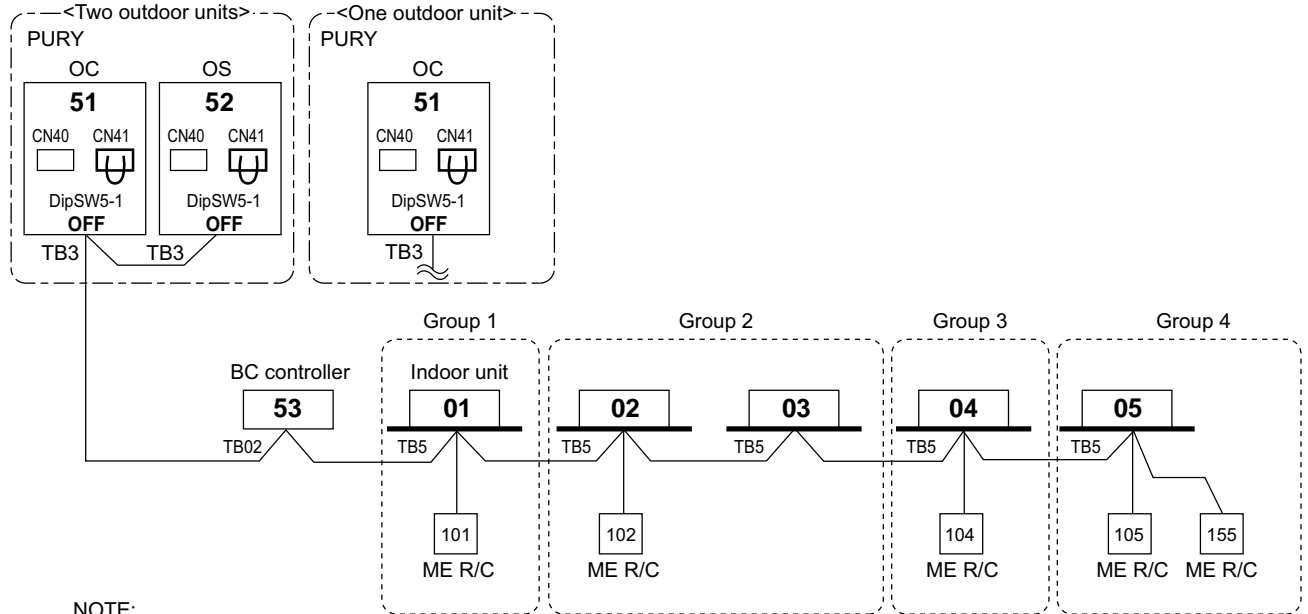

NOTE:

1. Outdoor units OC and OS in one refrigerant circuit system are automatically detected. OC and OS are ranked in descending order of capacity. If units are the same capacity, they are ranked in ascending order of their address.
2. Address should be set to Indoor units, system controller and ME remote controllers.
3. M-NET power is supplied by the Outdoor unit at TB3, while Indoor unit and ME RC consume the M-NET power for transmission use. The power balance is needed to consider for long M-NET wiring. Details refer to 2-3 "System configuration restrictions".
4. Indoor units should be set with a branch number.

2-4-3-5. ME remote controller, Single-refrigerant-system, System controller, LOSSNAY

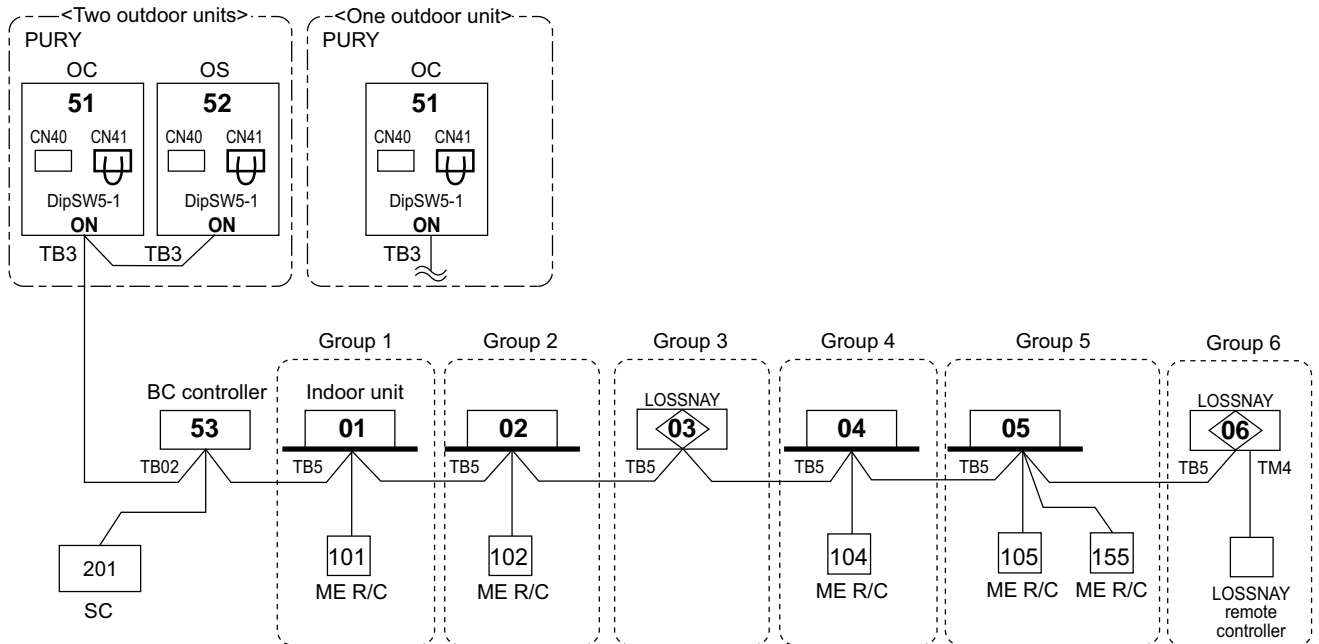

*SC can be connected to TB3 side or TB7 side;

Should SC connected to TB7 side, change Jumper from CN41 to CN40 at the Outdoor unit module so as to supply power to the SC.

NOTE:

1. Outdoor units OC and OS in one refrigerant circuit system are automatically detected. OC and OS are ranked in descending order of capacity. If units are the same capacity, they are ranked in ascending order of their address.
2. Address should be set to Indoor units, LOSSNAY, centralized controller, and ME remote controllers.
3. For a system having more than 32 indoor unit (P15-P140), confirm the need of Booster at 2-3 "System configuration restrictions".
4. Indoor units should be set with a branch number.

2-4-3-6. ME remote controller, Multi-refrigerant-system, System Controller at TB7 side, LOSSNAY, Booster for long M-NET wiring

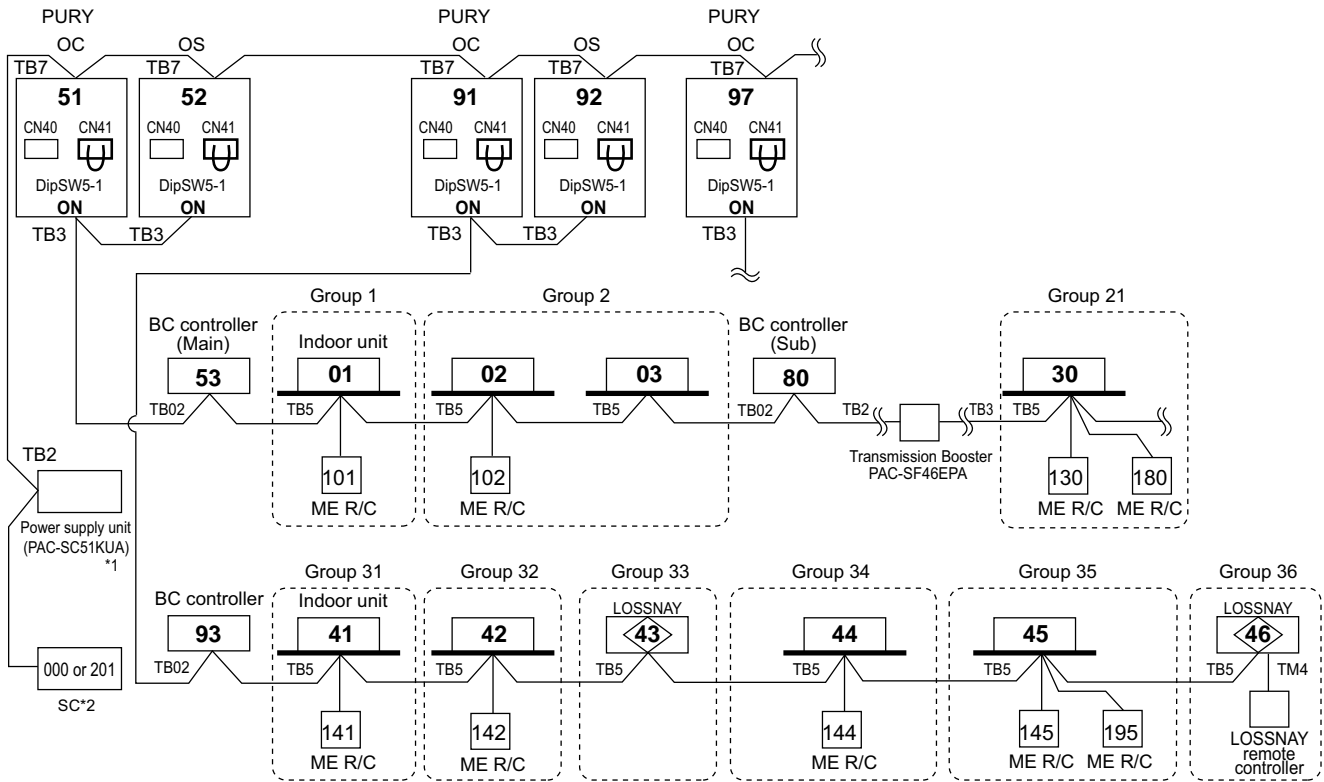

*1 System controller should connect to TB7 at Outdoor and use power supply unit together in Multi-Refrigerant-System.
For AG-150A, 24VDC should be used with the PAC-SC51KUA. For AE-200E/AE-50E, the power supply unit PAC-SC51KUA is unused.

*2 When multiple system controllers are connected in the system, set the controller with more functions than others as a "main" controller and others as "sub".
AE-200E and GB-50ADA-J are for exclusive use as a "main" system controller and cannot be used as a "sub" system controller.
Make the setting to only one of the system controllers for "prohibition of operation from local remote controller".

NOTE:

- Outdoor units OC and OS in one refrigerant circuit system are automatically detected.
OC and OS are ranked in descending order of capacity. If units are the same capacity, they are ranked in ascending order of their address.
- M-NET power is supplied by the Outdoor unit at TB3, while Indoor unit and ME RC consume the M-NET power for transmission use. The power balance is needed to consider for long M-NET wiring. Details refer to **2-3 "System configuration restrictions"**.
- Indoor units should be set with a branch number.
- Assign an address to each of the sub BC controllers which equals the sum of the smallest address of the indoor units that are connected to each sub BC controller and 50.
When the address assigned to sub BC controller overlaps those of any other units including outdoor units (OC/OS) or main BC controller, sub BC controller will be given priority to have the address.

2-4-3-7. Example : BC, BC sub

NOTE

- Indoor units should be set with a branch number.
- BC (main) address = O/U address + 1
- BC (sub) address = Lowest address within the indoor units connected to the BC controller (sub) + 50
- If applicable, set the sub BC controllers in an PURY system in the following order:
 - Indoor unit to be connected to the BC controller (Main)
 - Indoor unit to be connected to the BC controller (No.1 Sub)
 - Indoor unit to be connected to the BC controller (No.2 Sub)
 Set the address so that (1)<(2)<(3)

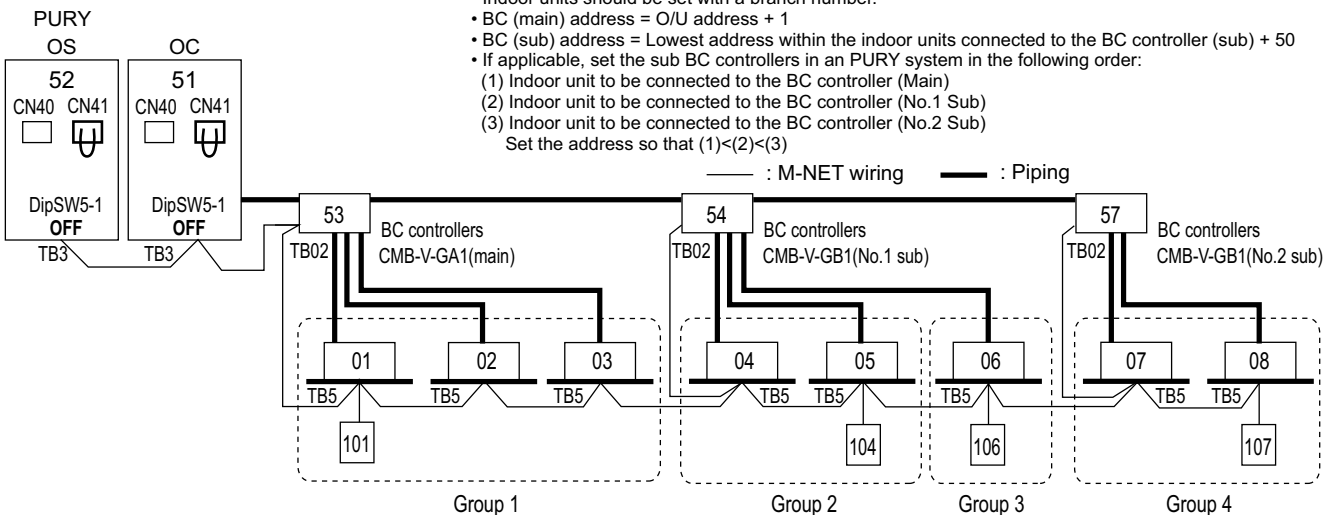

2-4-3-8. ME remote controller, Multi-refrigerant-system, No Power supply unit

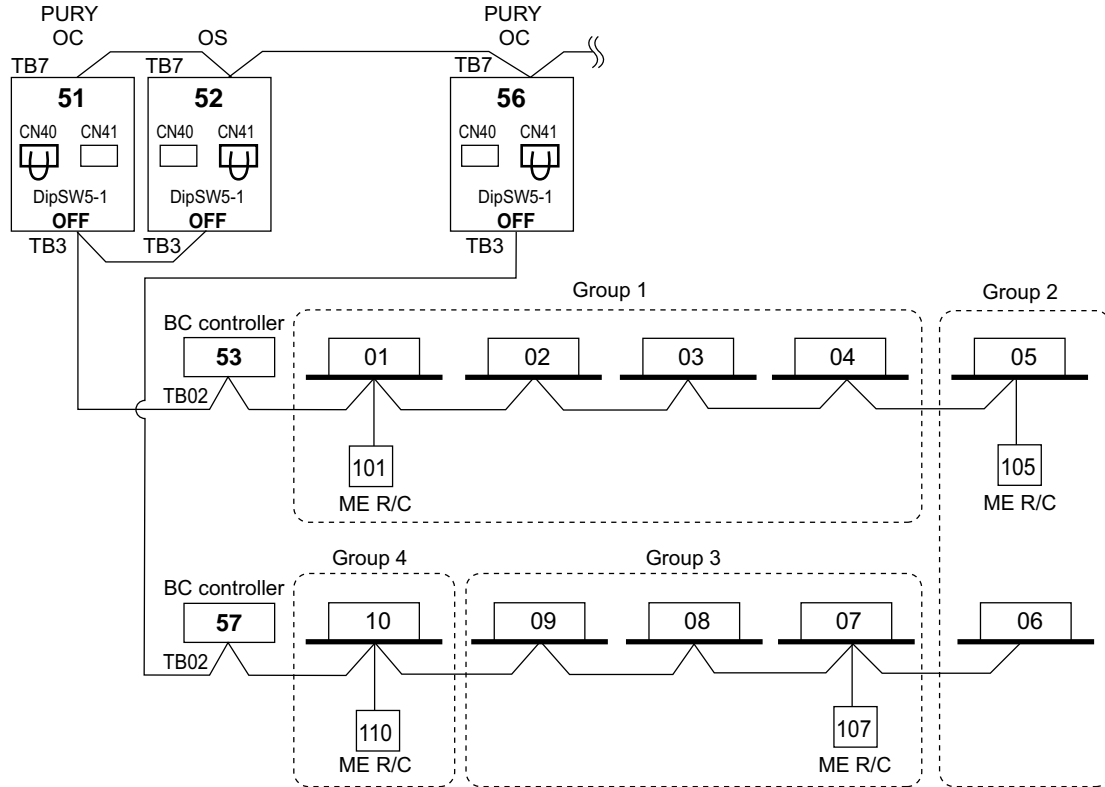

NOTE

- It is necessary to change the connector to CN40 on the outdoor unit control board (only one outdoor unit) when the group is set between other refrigerant systems.
- It is necessary to set on the remote controller by manual when group sets on the different refrigerant system. Please refer to remote controller installation manual.

2-4-3-9. ME remote controller, Multi-refrigerant-system, System Controller at TB7 side, No Power supply unit

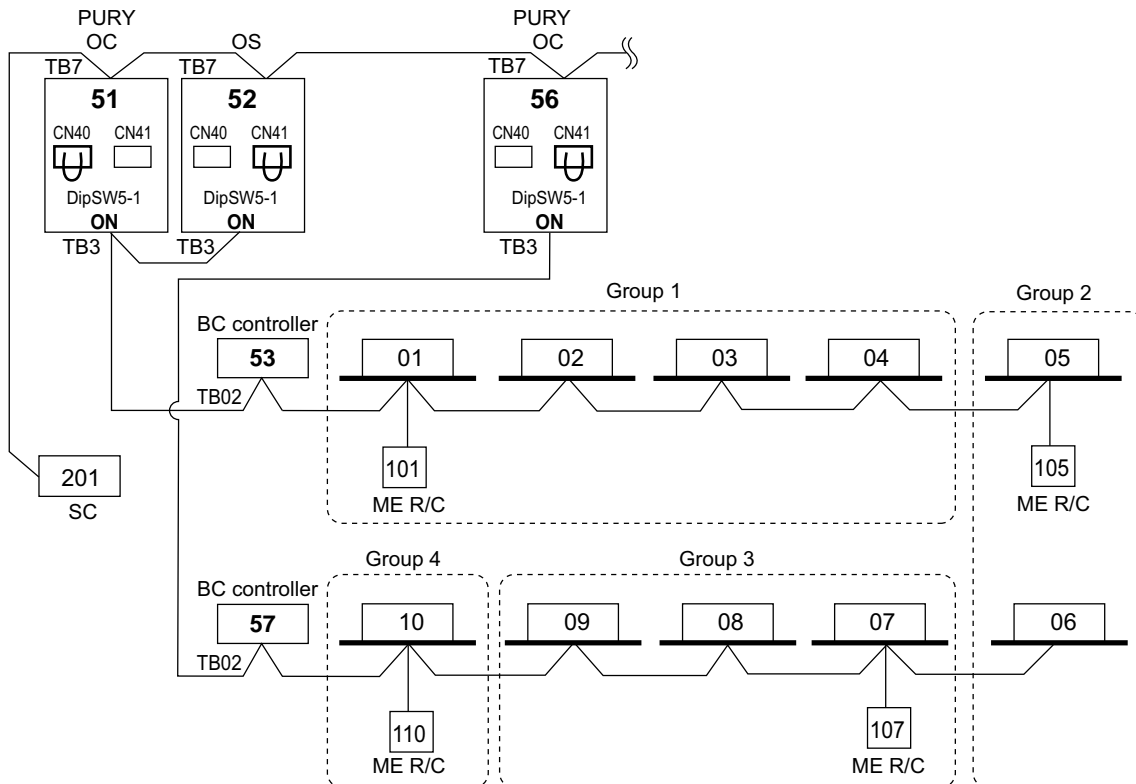

NOTE

- It is necessary to change the connector to CN40 on the outdoor unit control board (only one outdoor unit) when the group is set between other refrigerant systems.
- It is necessary to set on the remote controller by manual when group sets on the different refrigerant system. Please refer to remote controller installation manual.

2-4-3-10. TG-2000A(*1)+AE-200E,GB-50ADA-J
 AE-200E can control max. 50 indoor units;
 GB-50ADA-J can control max. 50 indoor units;
 TG-2000A can control max. 40 AE-200E and GB-50ADA-J;*2
 TG-2000A can control max. 2000 indoor units.

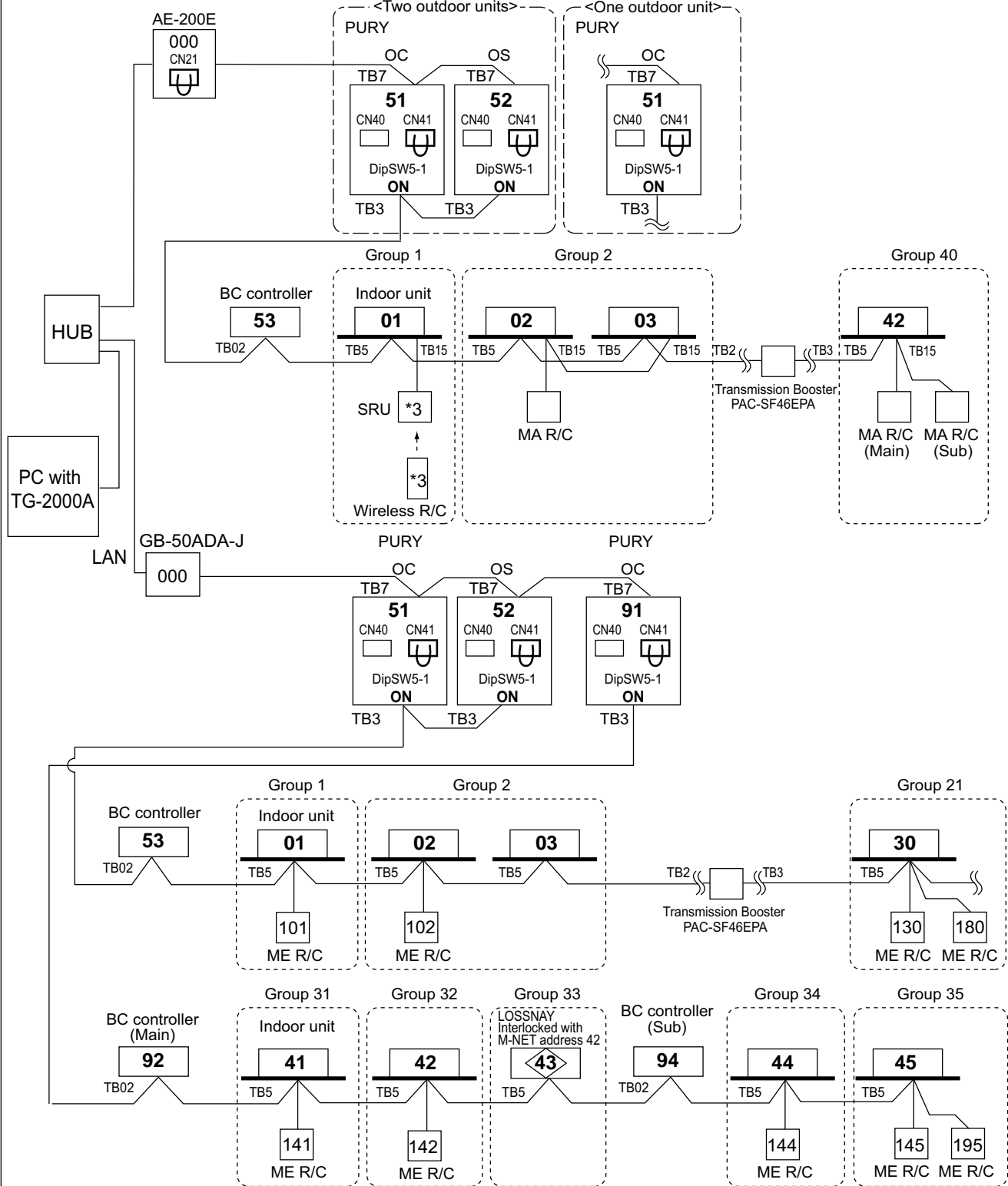

*1 TG-2000A (Ver.6.5 or later) supports AE-200E/AE-50E (Ver.7.10 or later).

TG-2000A (Ver. 6.3 or later) supports GB-50ADA-J.

*2 When AE-200E connected with AE-50E is connected, the number of AE-50E will be the maximum controllable number.

TG-2000A can control up to 40 AE-200E/AE-50E or AE-200E without AE-50E connection.

*3 For Wireless R/C and Signal receiver unit (SRU), channel 1, 2 and 3 are selectable and should be set to same channel.

*4 When a PAR-31MAA(E) is connected to a group, no other MA remote controllers can be connected to the same group.

2-4-3-11. AE-200E+AE-50E

AE-200E can control max. 200 indoor units/via AE-50E.

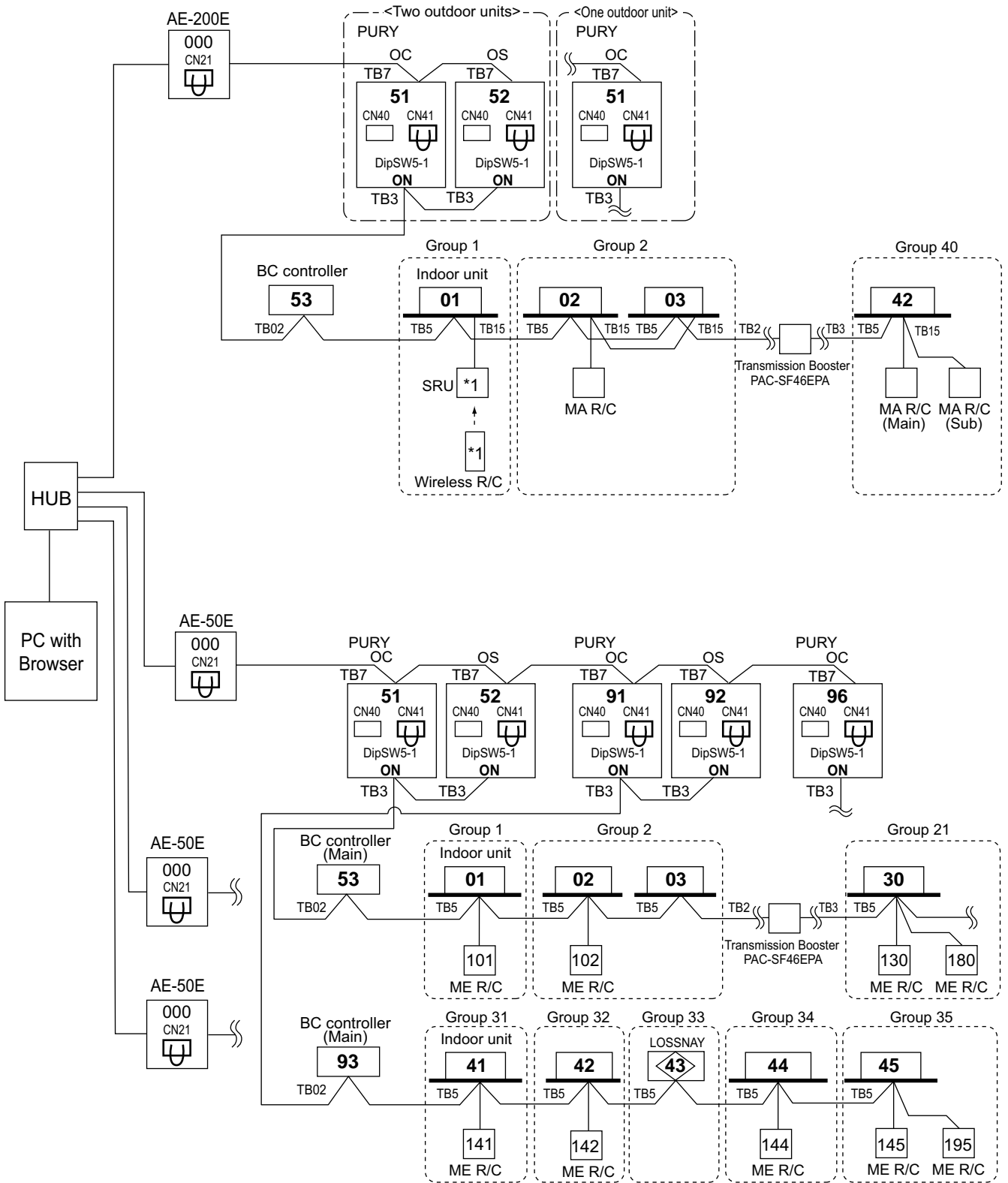

*1 For Wireless R/C and Signal receiver unit (SRU), channel 1, 2 and 3 are selectable and should be set to same channel.

*2 When a PAR-31MAA(E) is connected to a group, no other MA remote controllers can be connected to the same group.

2-4-3-12. LM-AP

LM-AP can transmit for max. 50 indoor units;

If system controller (SC) is used, DipSW1-2 at LM-AP and DipSW5-1 at Outdoor unit should set to "ON".

Change Jumper from CN41 to CN40 to activate power supply to LM-AP itself for those LM-AP connected without system controller (SC).

LM-AP can transmit for max. 50 indoor units in single-refrigerant-system or multi-refrigerant-system.

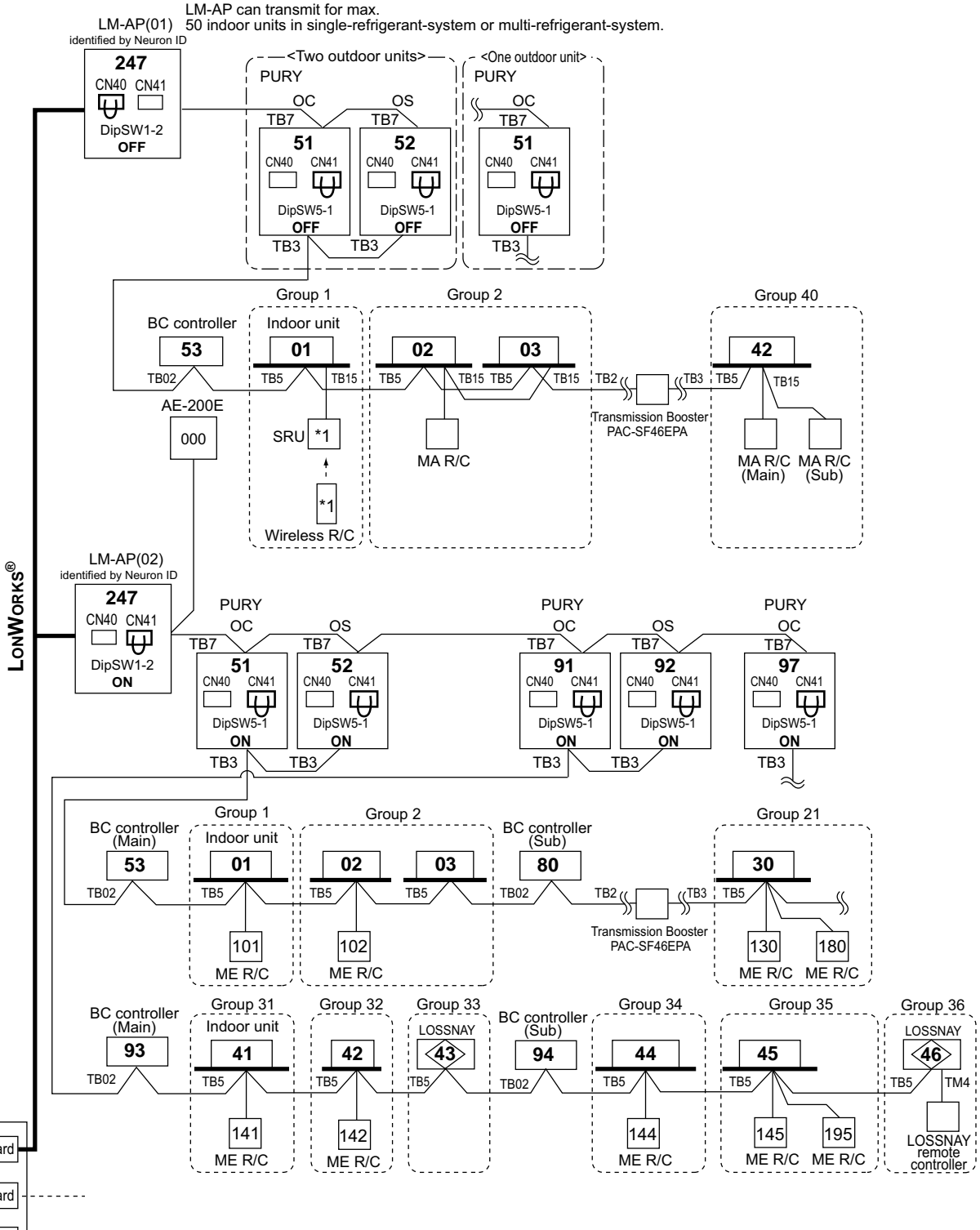

For other equipments (Lighting, security, elevator etc.)

*1 For Wireless R/C and Signal receiver unit (SRU), channel 1, 2 and 3 are selectable and should be set to same channel.

*2 When a PAR-31MAA(E) is connected to a group, no other MA remote controllers can be connected to the same group.

2-4-3-13. BM ADAPTER+AE-200E/AE-50E

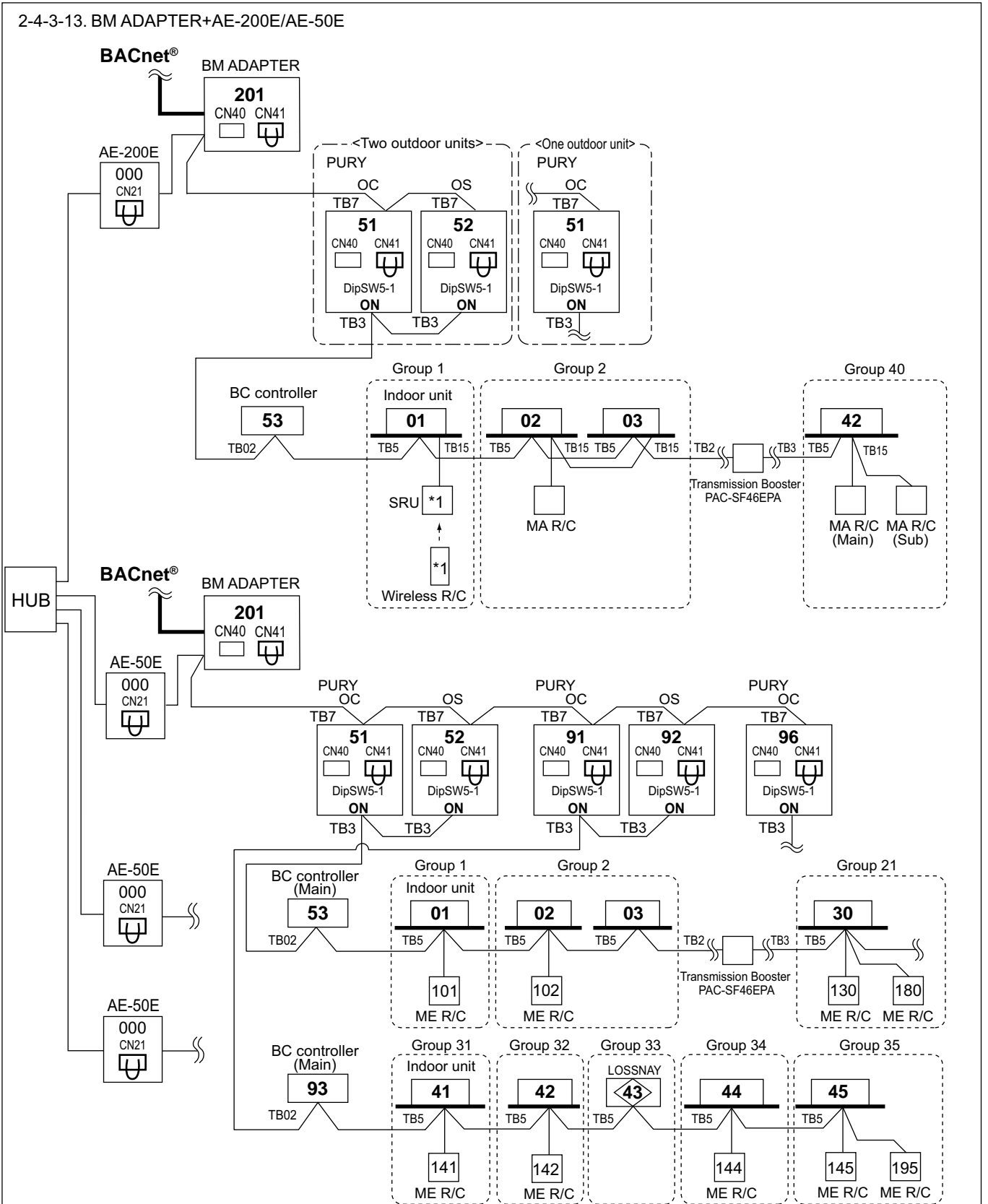

NOTE

•It is not necessary to connect the M-NET transmission line to the TB3 on BM ADAPTER. Leave the power jumper of BM ADAPTER connected to CN41.

*1 For Wireless R/C and Signal receiver unit (SRU), channel 1, 2 and 3 are selectable and should be set to same channel.

*2 Consult your dealer for restrictions when connecting both AE-200E/AE-50E and BM ADAPTER.

*3 When a PAR-31MAA(E) is connected to a group, no other MA remote controllers can be connected to the same group.

*4 In a system that uses AE-200E and/or AE-50E, each BM-ADAPTER must be connected to the M-NET line.

3-1. R410A Piping material

Refrigerant pipe for CITY MULTI shall be made of phosphorus deoxidized copper, and has two types.

A. Type-O : Soft copper pipe (annealed copper pipe), can be easily bent with human's hand.

B. Type-1/2H pipe : Hard copper pipe (Straight pipe), being stronger than Type-O pipe of the same radical thickness.

The maximum operation pressure of R410A air conditioner is 4.30 MPa [623psi]. The refrigerant piping should ensure the safety under the maximum operation pressure. MITSUBISHI ELECTRIC recommends pipe size as Table 3-1, or You shall follow the local industrial standard. Pipes of radical thickness 0.7mm or less shall not be used.

Table 3-1. Copper pipe size and radial thickness for R410A CITY MULTI.

Size (mm)	Size (inch)	Radial thickness (mm)	Radial thickness (mil)	Pipe type
ø6.35	ø1/4"	0.8	[32]	Type-O
ø9.52	ø3/8"	0.8	[32]	Type-O
ø12.7	ø1/2"	0.8	[32]	Type-O
ø15.88	ø5/8"	1.0	[40]	Type-O
ø19.05	ø3/4"	1.2	[48]	Type-O
ø19.05	ø3/4"	1.0	[40]	Type-1/2H or H
ø22.2	ø7/8"	1.0	[40]	Type-1/2H or H
ø25.4	ø1"	1.0	[40]	Type-1/2H or H
ø28.58	ø1-1/8"	1.0	[40]	Type-1/2H or H
ø31.75	ø1-1/4"	1.1	[44]	Type-1/2H or H
ø34.93	ø1-3/8"	1.2	[48]	Type-1/2H or H
ø41.28	ø1-5/8"	1.4	[56]	Type-1/2H or H

* For pipe sized ø19.05 (3/4") for R410A air conditioner, choice of pipe type is up to you.

* The figures in the radial thickness column are based on the Japanese standards and provided only as a reference. Use pipes that meet the local standards.

Flare

Due to the relative higher operation pressure of R410A compared to R22, the flare connection should follow dimensions mentioned below so as to achieve enough the air-tightness.

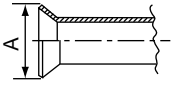
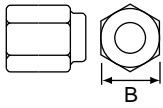
Flare pipe	Pipe size	A (For R410A)	(mm[in.])	Flare nut	Pipe size	B (For R410A)	(mm[in.])
	ø6.35 [1/4"]	9.1			ø6.35 [1/4"]	17.0	
	ø9.52 [3/8"]	13.2			ø9.52 [3/8"]	22.0	
	ø12.70 [1/2"]	16.6			ø12.70 [1/2"]	26.0	
	ø15.88 [5/8"]	19.7			ø15.88 [5/8"]	29.0	
	ø19.05 [3/4"]	24.0			ø19.05 [3/4"]	36.0	

3-2. Piping Design

3-2-1. IF 16 ports or less are in use, i.e., if only one BC controller is in use with no sub BC controller PURY-P-YLM-A1

- Note1. No Header usable on PURY system.
- Note2. Indoor unit sized P100-P250 should be connected to BC controller via Y shape joint CMY-R160-J1 ;
- Note3. Indoor unit sized P100-P250 does NOT share BC controller ports with other Indoor units ;
- Note4. As bents cause pressure loss on transportation of refrigerant, fewer bents design is better ;
Piping length needs to consider the actual length and equivalent length which bents are counted.
Equivalent piping length (m)=Actual piping length+"M" x Number of bent.
- Note5. Set DIP-SW 4-6 to ON of BC controller, in case of connected Indoor unit sized P100-P140 with 2 ports.
- Note6. It is also possible to connect Indoor unit sized P100-P140 with 1 port (set DIP-SW 4-6 to OFF).
However, the cooling capacity decreases a little (For details, refer to the chapter OUTDOOR UNITS, R2 SERIES, 6-4. Correction by port counts of the BC controller).
- Note7. Individual indoor units grouped together to connect to the BC controller via one port cannot operate individually in heating and cooling modes at the same time. I.e., they must all function in either heating or cooling together.
- Note8. Indoor capacity is described as its model size. For example, PEFY-P63VML-E, its capacity is P63.
- Note9. Total down-stream Indoor capacity is the summary of the model size of Indoors down-stream.
For example, PEFY-P63VML-E + PEFY-P32VML-E : Total Indoor capacity = P63 + P32 = P95.
- Note10. To enable the continuous heating mode, set SW4 (848) to ON.

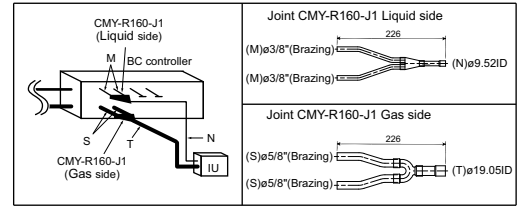

Fig. 3-2-1AA

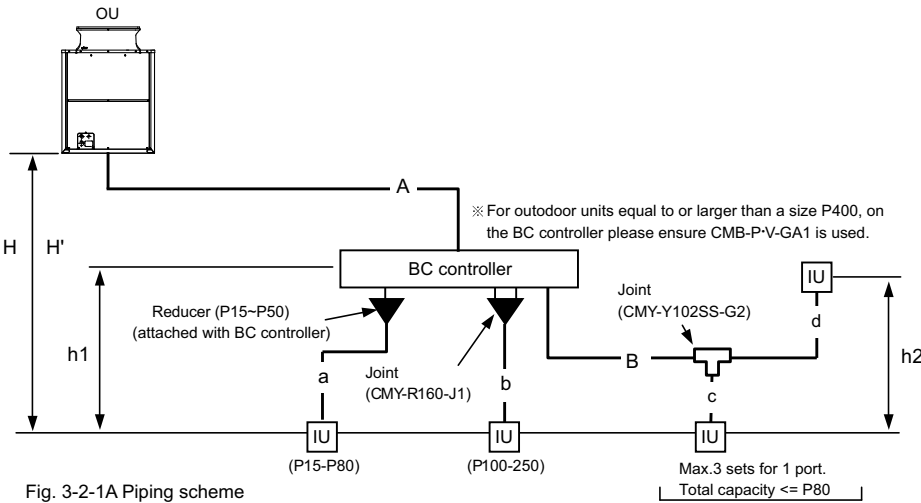

Fig. 3-2-1A Piping scheme

Table 3-2-1-1. Piping length limitation

Item	Piping in the figure	Max. length	Max. equivalent length
Total piping length	A+B+a+b+c+d	*1	-
Farthest IU from OU	A+B+d	165 [541']	190 [623']
Distance between OU and BC	A	110 [360'] *1	110 [360'] *1
Farthest IU from BC controller	B+d	40 [131'] *2*3	40 [131'] *3
Height between OU and IU (OU above IU)	H	50 [164'] *5	-
Height between OU and IU (OU under IU)	H'	40 [131'] *6	-
Height between IU and BC	h1	15 [49'] (10 [32']) *4	-
Height between IU and IU	h2	15 [49'] (10 [32']) *4	-

Table3-2-1-2. Bent equivalent length "M"

Outdoor Model	M (m/bent [ft./bent])
P200YLM-A1	0.35 [1.15']
P250YLM-A1	0.42 [1.38']
P300YLM-A1	0.42 [1.38']
P350YLM-A1	0.47 [1.54']
P400YLM-A1	0.50 [1.64']
P450YLM-A1	0.50 [1.64']
P500YLM-A1	0.50 [1.64']

OU : Outdoor Unit ; IU : Indoor Unit ; BC : BC controller

*1. Refer to the section 3-2-7.

*2. Details refer to Fig.3-2-1-1

*3. Farthest Indoor from BC controller "B+d" can exceed 40m till 60m if no Indoor sized P200, P250 connected. Details refer to Fig.3-2-1-1

*4. Distance of Indoor sized P200, P250 from BC must be less than 10m, if any.

*5. 90m is available depending on the model and installation conditions. For more detailed information, contact your local distributor.

*6. 60m is available depending on the model and installation conditions. For more detailed information, contact your local distributor.

Fig. 3-2-1-1 Piping length and height between IU and BC controller

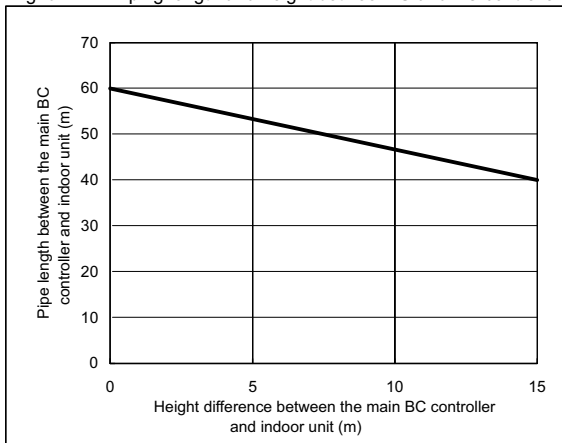

Table3-2-1-3. Piping "A" size selection rule (mm [in.])

Outdoor Model	Pipe(High pressure)	Pipe(Low pressure)
P200YLM-A1	ø15.88 [5/8"]	ø19.05 [3/4"]
P250YLM-A1	ø19.05 [3/4"]	ø22.20 [7/8"]
P300YLM-A1	ø19.05 [3/4"]	ø22.20 [7/8"]
P350YLM-A1	ø19.05 [3/4"]	ø28.58 [1-1/8"]
P400YLM-A1	ø22.20 [7/8"]	ø28.58 [1-1/8"]
P450YLM-A1	ø22.20 [7/8"]	ø28.58 [1-1/8"]
P500YLM-A1	ø22.20 [7/8"]	ø28.58 [1-1/8"]

Table3-2-1-4. Piping "B" size selection rule (mm [in.])

Total down-stream Indoor capacity	Pipe(Liquid)	Pipe(Gas)
P140 or less	ø9.52 [3/8"]	ø15.88 [5/8"]

Table3-2-1-5. Piping "a", "b", "c", "d" size selection rule (mm [in.])

Indoor Unit size	Pipe(Liquid)	Pipe(Gas)
P15 to P50, GUF-50RD(H)	ø6.35 [1/4"]	ø12.70 [1/2"]
P63 to P140, GUF-100RD(H)	ø9.52 [3/8"]	ø15.88 [5/8"]
P200	ø9.52 [3/8"]	ø19.05 [3/4"]
P250	ø9.52 [3/8"]	ø22.20 [7/8"]

3-2-2. IF 16 ports or less are in use, i.e., if only one BC controller is in use with no sub BC controller

PURY-EP-YLM

- Note1. No Header usable on PURY system.
- Note2. Indoor unit sized P100-P250 should be connected to BC controller via Y shape joint CMY-R160-J1 ;
- Note3. Indoor unit sized P100-P250 does NOT share BC controller ports with other Indoor units ;
- Note4. As bents cause pressure loss on transportation of refrigerant, fewer bents design is better ;
Piping length needs to consider the actual length and equivalent length which bents are counted.
Equivalent piping length (m)=Actual piping length+"M" x Number of bent.
- Note5. Set DIP-SW 4-6 to ON of BC controller, in case of connected Indoor unit sized P100-P140 with 2 ports.
- Note6. It is also possible to connect Indoor unit sized P100-P140 with 1 port (set DIP-SW 4-6 to OFF).
However, the cooling capacity decreases a little (For details, refer to the chapter OUTDOOR UNITS, R2 SERIES, 6-4. Correction by port counts of the BC controller).
- Note7. Individual indoor units grouped together to connect to the BC controller via one port cannot operate individually in heating and cooling modes at the same time. i.e., they must all function in either heating or cooling together.
- Note8. Indoor capacity is described as its model size. For example, PEFY-P63VML-E, its capacity is P63.
- Note9. Total down-stream Indoor capacity is the summary of the model size of Indoors down-stream.
For example, PEFY-P63VML-E + PEFY-P32VML-E : Total Indoor capacity = P63 + P32 = P95.
- Note10. To enable the continuous heating mode, set SW4 (848) to ON.

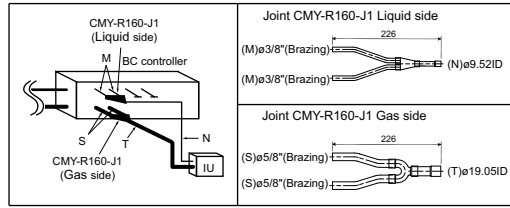

Fig. 3-2-1AA

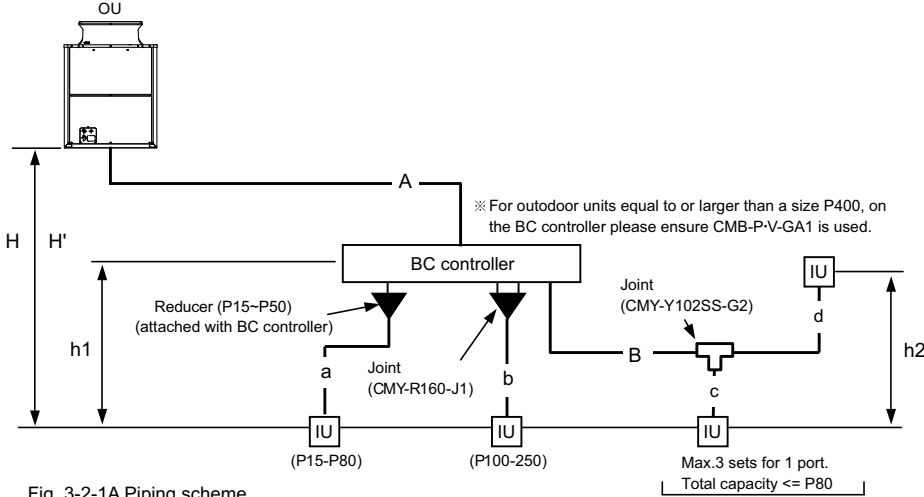

Fig. 3-2-1A Piping scheme

Table 3-2-1-1. Piping length limitation

Item	Piping in the figure	Max. length	Max. equivalent length
Total piping length	A+B+a+b+c+d	*1	-
Farthest IU from OU	A+B+d	165 [541']	190 [623']
Distance between OU and BC	A	110 [360'] *1	110 [360'] *1
Farthest IU from BC controller	B+d	40 [131'] *2*3	40 [131'] *3
Height between OU and IU (OU above IU)	H	50 [164'] *5	-
Height between OU and IU (OU under IU)	H'	40 [131'] *6	-
Height between IU and BC	h1	15 [49'] (10 [32']) *4	-
Height between IU and IU	h2	15 [49'] (10 [32']) *4	-

Table 3-2-1-2. Bent equivalent length "M"

Outdoor Model	M (m/bent [ft./bent])
EP200YLM	0.35 [1.15']
EP250YLM	0.42 [1.38']
EP300YLM	0.42 [1.38']
EP350YLM	0.47 [1.54']
EP400YLM	0.50 [1.64']
EP450YLM	0.50 [1.64']
EP500YLM	0.50 [1.64']

OU : Outdoor Unit ; IU : Indoor Unit ; BC : BC controller

- *1. Refer to the section 3-2-7.
- *2. Details refer to Fig.3-2-1-1

*3. Farthest Indoor from BC controller "B+d" can exceed 40m till 60m if no Indoor sized P200, P250 connected. Details refer to Fig.3-2-1-1

*4. Distance of Indoor sized P200, P250 from BC must be less than 10m, if any.

*5. 90m is available depending on the model and installation conditions. For more detailed information, contact your local distributor.

*6. 60m is available depending on the model and installation conditions. For more detailed information, contact your local distributor.

Fig. 3-2-1-1 Piping length and height between IU and BC controller

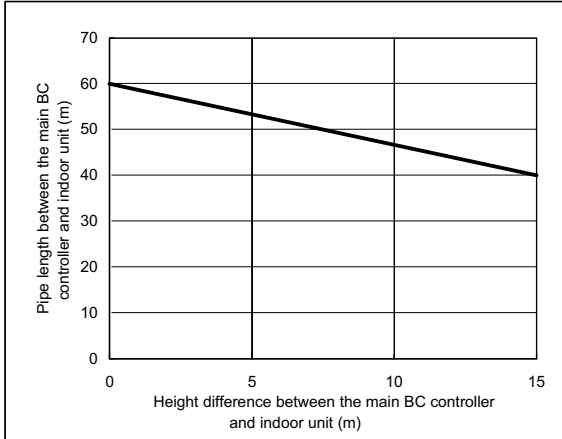

Table3-2-1-3. Piping "A" size selection rule (mm [in.])

Outdoor Model	Pipe(High pressure)	Pipe(Low pressure)
EP200YLM	ø15.88 [5/8"]	ø19.05 [3/4"]
EP250YLM	ø19.05 [3/4"]	ø22.20 [7/8"]
EP300YLM	ø19.05 [3/4"]	ø22.20 [7/8"]
EP350YLM	ø19.05 [3/4"]	ø28.58 [1-1/8"]
EP400YLM	ø22.20 [7/8"]	ø28.58 [1-1/8"]
EP450YLM	ø22.20 [7/8"]	ø28.58 [1-1/8"]
EP500YLM	ø22.20 [7/8"]	ø28.58 [1-1/8"]

Table3-2-1-4. Piping "B" size selection rule (mm [in.])

Total down-stream Indoor capacity	Pipe(Liquid)	Pipe(Gas)
P140 or less	ø9.52 [3/8"]	ø15.88 [5/8"]

Table3-2-1-5. Piping "a", "b", "c", "d" size selection rule (mm [in.])

Indoor Unit size	Pipe(Liquid)	Pipe(Gas)
P15 to P50, GUF-50RD(H)	ø6.35 [1/4"]	ø12.70 [1/2"]
P63 to P140, GUF-100RD(H)	ø9.52 [3/8"]	ø15.88 [5/8"]
P200	ø9.52 [3/8"]	ø19.05 [3/4"]
P250	ø9.52 [3/8"]	ø22.20 [7/8"]

3-2-3. IF more than 16 ports are in use, or if there is more than one BC controller in use for one outdoor unit
PURY-P-YLM-A1

- Note1. No Header usable on PURY system.
- Note2. Indoor unit sized P100-P250 should be connected to BC controller via Y shape joint CMY-R160-J1 ;
- Note3. Indoor unit sized P100-P250 does NOT share BC controller ports with other Indoor units ;
- Note4. As bends cause pressure loss on transportation of refrigerant, fewer bends design is better ;
 Piping length needs to consider the actual length and equivalent length which bends are counted.
 Equivalent piping length (m)=Actual piping length**M* x Number of bent.
- Note5. Set DIP-SW 4-6 to ON of BC controller, in case of connected Indoor unit sized P100-P140 with 2 ports.
- Note6. It is also possible to connect Indoor unit sized P100-P140 with 1 port (set DIP-SW 4-6 to OFF).
 However, the cooling capacity decreases a little (For details, refer to the chapter OUTDOOR UNITS, R2 SERIES, 6-4. Correction by port counts of the BC controller).
- Note7. Individual indoor units grouped together to connect to the BC controller via one port cannot operate individually in heating and cooling modes at the same time. I.e., they must all function in either heating or cooling together.
- Note8. For sub BC controller CMB-P-V-GB1 the connectable indoor unit capacities may sum to equal that of a P350 unit or less. However, if two sub controllers are used the TOTAL sum of connectable units connected to BOTH sub controllers must also not exceed that of a P350 unit.
 For sub BC controller CMB-P1016V-HB1 the connectable indoor unit capacities may sum to equal that of a P350 unit or less. However, if two sub controllers are used the TOTAL sum of connectable units connected to BOTH sub controllers must also not exceed that of a P450 unit.
- Note9. Indoor capacity is described as its model size. For example, PEFY-P63VML-E, its capacity is P63.
- Note10. Total down-stream Indoor capacity is the summary of the model size of Indoors down-stream.
 For example, PEFY-P63VML-E + PEFY-P32VML-E : Total Indoor capacity = P63 + P32 = P95.
- Note11. To enable the continuous heating mode, set SW4 (848) to ON.

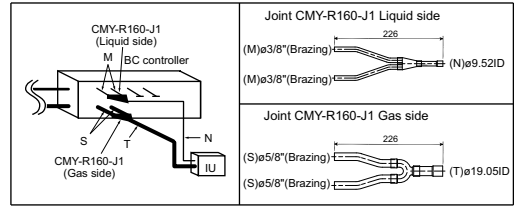

Fig. 3-2-2AA

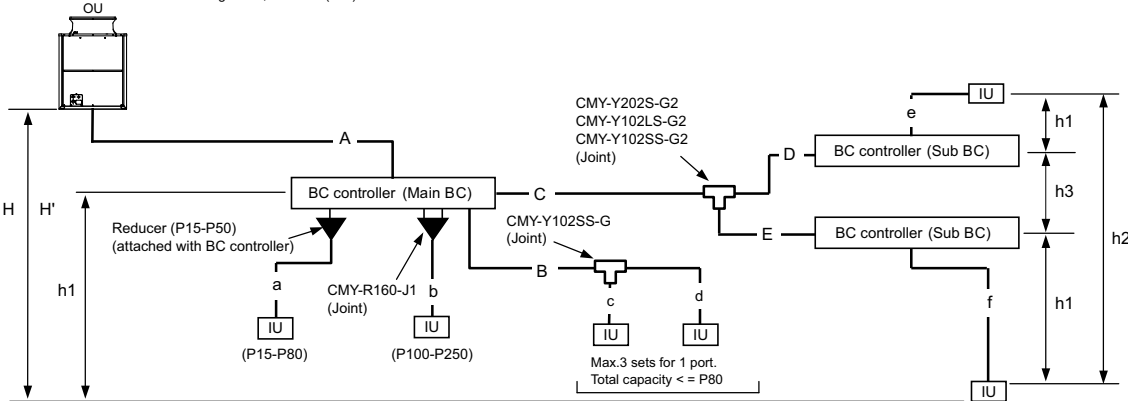

Fig. 3-2-2A Piping scheme

OU : Outdoor unit, IU : Indoor unit

Table 3-2-2-1. Piping length limitation

Item	Piping in the figure	Max. length	Max. equivalent length
Total piping length	A+B+C+D+E+a+b+c+d+e+f	*1	-
Farthest IU from OU	A+C+E+f	165 [541']	190 [623']
Distance between OU and BC	A	110 [360'] *1	110 [360'] *1
Farthest IU from BC controller	B+d or C+D+e or C+E+f	40 [131'] *2*3	40 [131'] *2*3
Height between OU and IU (OU above IU)	H	50 [164'] *6	-
Height between OU and IU (OU under IU)	H'	40 [131'] *7	-
Height between IU and BC	h1	15 [49'] (10 [32']) *4	-
Height between IU and IU	h2	15 [49'] (10 [32']) *4	-
Height between BC(Main or Sub) and BC(Sub)	h3	15 [49'] (10 [32']) *5	-

Table3-2-2-2. Bent equivalent length "M"

Outdoor Model	M (m/bent [ft./bent])
P200YLM-A1	0.35 [1.15']
P250YLM-A1	0.42 [1.38']
P300YLM-A1	0.42 [1.38']
P350YLM-A1	0.47 [1.54']
P400YLM-A1	0.50 [1.64']
P450YLM-A1	0.50 [1.64']
P500YLM-A1	0.50 [1.64']

OU : Outdoor Unit ; IU : Indoor Unit ; BC : BC controller

- *1. Refer to the section 3-2-7.
- *2. Details refer to Fig.3-2-2-1

*3. Farthest Indoor from BC controller "B+d or C+D+e or C+E+f" can exceed 40m till 60m if no Indoor sized P200, P250 connected. Details refer to Fig.3-2-2-1

*4. Distance of Indoor sized P200, P250 from BC must be less than 10m, if any.

*5. When using 2 Sub BC controllers, max. height "h3" should be considered.

*6. 90m is available depending on the model and installation conditions. For more detailed information, contact your local distributor.

*7. 60m is available depending on the model and installation conditions. For more detailed information, contact your local distributor.

Fig. 3-2-2-1 Piping length and height between IU and BC controller

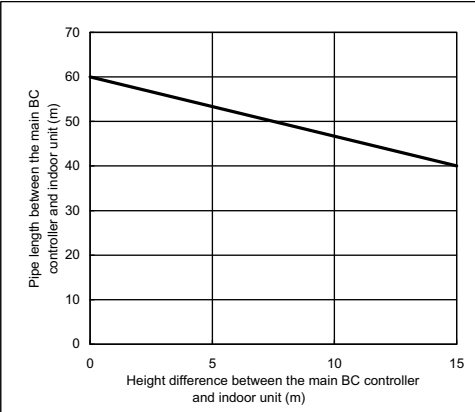

Table3-2-2-3. Piping "A" size selection rule (mm [in.])

Outdoor Model	Pipe(High pressure)	Pipe(Low pressure)
P200YLM-A1	ø15.88 [5/8"]	ø19.05 [3/4"]
P250YLM-A1	ø19.05 [3/4"]	ø22.20 [7/8"]
P300YLM-A1	ø19.05 [3/4"]	ø22.20 [7/8"]
P350YLM-A1	ø19.05 [3/4"]	ø28.58 [1-1/8"]
P400YLM-A1	ø22.20 [7/8"]	ø28.58 [1-1/8"]
P450YLM-A1	ø22.20 [7/8"]	ø28.58 [1-1/8"]
P500YLM-A1	ø22.20 [7/8"]	ø28.58 [1-1/8"]

Table3-2-2-4. Piping "B" size selection rule (mm [in.])

Total down-stream Indoor capacity	Pipe(Liquid)	Pipe(Gas)
P140 or less	ø9.52 [3/8"]	ø15.88 [5/8"]

Table3-2-2-5. Piping "C", "D", "E" size selection rule (mm [in.])

Total down-stream Indoor capacity	Pipe(Liquid)	Pipe(HP Gas)	Pipe(LP Gas)
P200 or less	ø9.52 [3/8"]	ø15.88 [5/8"]	ø19.05 [3/4"]
P201 to P300	ø9.52 [3/8"]	ø19.05 [3/4"]	ø22.20 [7/8"]
P301 to P350	ø12.70 [1/2"]	ø19.05 [3/4"]	ø28.58 [1-1/8"]
P351 to P400	ø12.70 [1/2"]	ø22.20 [7/8"]	ø28.58 [1-1/8"]
P401 to P450	ø15.88 [5/8"]	ø22.20 [7/8"]	ø28.58 [1-1/8"]

HP : High pressure, LP:Low pressure

Table3-2-2-6. Piping "a", "b", "c", "d", "e", "f" size selection rule (mm [in.])

Indoor Unit size	Pipe(Liquid)	Pipe(Gas)
P15 to P50, GUF-50RD(H)	ø6.35 [1/4"]	ø12.70 [1/2"]
P63 to P140, GUF-100RD(H)	ø9.52 [3/8"]	ø15.88 [5/8"]
P200	ø9.52 [3/8"]	ø19.05 [3/4"]
P250	ø9.52 [3/8"]	ø22.20 [7/8"]

3-2-4. IF more than 16 ports are in use, or if there is more than one BC controller in use for one outdoor unit

PURY-EP-YLM

- Note1. No Header usable on PURY system.
- Note2. Indoor unit sized P100-P250 should be connected to BC controller via Y shape joint CMY-R160-J1 ;
- Note3. Indoor unit sized P100-P250 does NOT share BC controller ports with other Indoor units ;
- Note4. As bents cause pressure loss on transportation of refrigerant, fewer bents design is better ;
Piping length needs to consider the actual length and equivalent length which bents are counted.
Equivalent piping length (m)=Actual piping length*M* x Number of bent.
- Note5. Set DIP-SW 4-6 to ON of BC controller, in case of connected Indoor unit sized P100-P140 with 2 ports.
- Note6. It is also possible to connect Indoor unit sized P100-P140 with 1 port (set DIP-SW 4-6 to OFF).
However, the cooling capacity decreases a little (For details, refer to the chapter OUTDOOR UNITS, R2 SERIES, 6-4. Correction by port counts of the BC controller).
- Note7. Individual indoor units grouped together to connect to the BC controller via one port cannot operate individually in heating and cooling modes at the same time. I.e., they must all function in either heating or cooling together.
- Note8. For sub BC controller CMB-P-V-GB1 the connectable indoor unit capacities may sum to equal that of a P350 unit or less. However, if two sub controllers are used the TOTAL sum of connectable units connected to BOTH sub controllers must also not exceed that of a P350 unit.
For sub BC controller CMB-P1016V-HB1 the connectable indoor unit capacities may sum to equal that of a P350 unit or less. However, if two sub controllers are used the TOTAL sum of connectable units connected to BOTH sub controllers must also not exceed that of a P450 unit.
- Note9. Indoor capacity is described as its model size. For example, PEFY-P63VML-E, its capacity is P63.
- Note10. Total down-stream Indoor capacity is the summary of the model size of Indoors down-stream.
For example, PEFY-P63VML-E + PEFY-P32VML-E : Total Indoor capacity = P63 + P32 = P95.
- Note11. To enable the continuous heating mode, set SW4 (848) to ON.

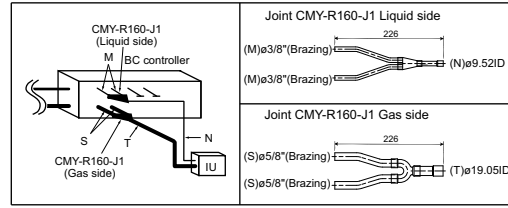

Fig. 3-2-2AA

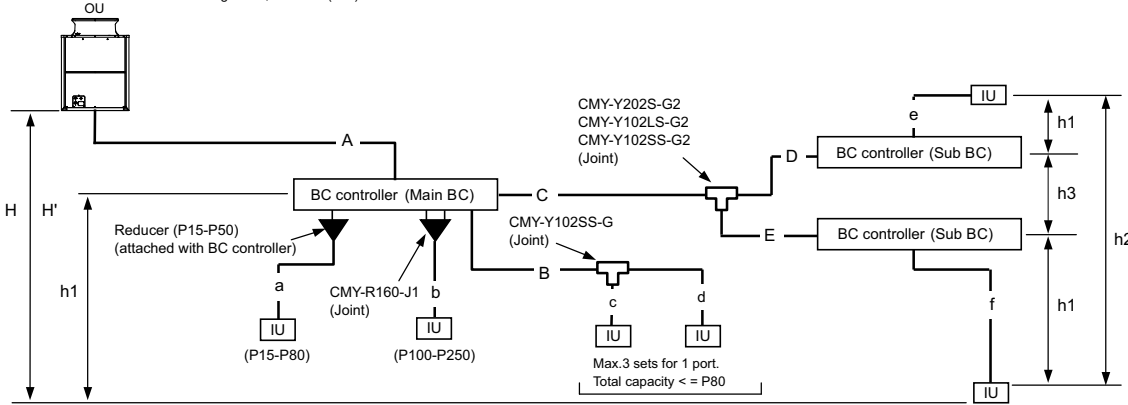

Fig. 3-2-2A Piping scheme

OU : Outdoor unit, IU : Indoor unit

Table 3-2-2-1. Piping length limitation

Item	Piping in the figure	Max. length	Max. equivalent length
Total piping length	A+B+C+D+E+a+b+c+d+e+f	*1	-
Farthest IU from OU	A+C+E+f	165 [541']	190 [623']
Distance between OU and BC	A	110 [360'] *1	110 [360'] *1
Farthest IU from BC controller	B+d or C+D+e or C+E+f	40 [131'] *2*3	40 [131'] *2*3
Height between OU and IU (OU above IU)	H	50 [164'] *6	-
Height between OU and IU (OU under IU)	H'	40 [131'] *7	-
Height between IU and BC	h1	15 [49'] (10 [32']) *4	-
Height between IU and IU	h2	15 [49'] (10 [32']) *4	-
Height between BC(Main or Sub) and BC(Sub)	h3	15 [49'] (10 [32']) *5	-

OU : Outdoor Unit ; IU : Indoor Unit ; BC : BC controller

- *1. Refer to the section 3-2-7.
- *2. Details refer to Fig.3-2-2-1
- *3. Farthest Indoor from BC controller "B+d or C+D+e or C+E+f " can exceed 40m till 60m if no Indoor sized P200, P250 connected.
Details refer to Fig.3-2-2-1
- *4. Distance of Indoor sized P200, P250 from BC must be less than 10m, if any.
- *5. When using 2 Sub BC controllers, max. height "h3" should be considered.
- *6. 90m is available depending on the model and installation conditions. For more detailed information, contact your local distributor.
- *7. 60m is available depending on the model and installation conditions. For more detailed information, contact your local distributor.

Fig. 3-2-2-1 Piping length and height between IU and BC controller

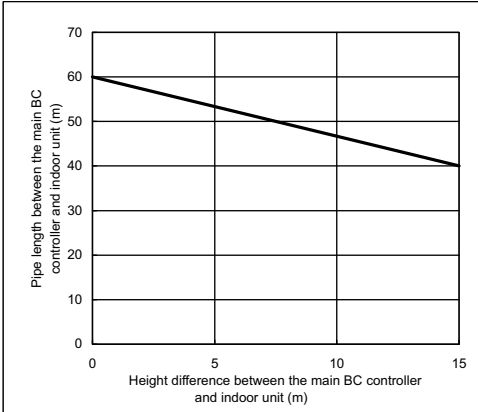

Table3-2-2-2. Bent equivalent length "M"

Outdoor Model	M (m/bent [ft./bent])
EP200YLM	0.35 [1.15']
EP250YLM	0.42 [1.38']
EP300YLM	0.42 [1.38']
EP350YLM	0.47 [1.54']
EP400YLM	0.50 [1.64']
EP450YLM	0.50 [1.64']
EP500YLM	0.50 [1.64']

Table3-2-2-3. Piping "A" size selection rule (mm [in.])

Outdoor Model	Pipe(High pressure)	Pipe(Low pressure)
EP200YLM	ø15.88 [5/8"]	ø19.05 [3/4"]
EP250YLM	ø19.05 [3/4"]	ø22.20 [7/8"]
EP300YLM	ø19.05 [3/4"]	ø22.20 [7/8"]
EP350YLM	ø19.05 [3/4"]	ø28.58 [1-1/8"]
EP400YLM	ø22.20 [7/8"]	ø28.58 [1-1/8"]
EP450YLM	ø22.20 [7/8"]	ø28.58 [1-1/8"]
EP500YLM	ø22.20 [7/8"]	ø28.58 [1-1/8"]

Table3-2-2-4. Piping "B" size selection rule (mm [in.])

Total down-stream Indoor capacity	Pipe(Liquid)	Pipe(Gas)
P140 or less	ø9.52 [3/8"]	ø15.88 [5/8"]

Table3-2-2-5. Piping "C", "D", "E" size selection rule (mm [in.])

Total down-stream Indoor capacity	Pipe(Liquid)	Pipe(HP Gas)	Pipe(LP Gas)
P200 or less	ø9.52 [3/8"]	ø15.88 [5/8"]	ø19.05 [3/4"]
P201 to P300	ø9.52 [3/8"]	ø19.05 [3/4"]	ø22.20 [7/8"]
P301 to P350	ø12.70 [1/2"]	ø19.05 [3/4"]	ø28.58 [1-1/8"]
P351 to P400	ø12.70 [1/2"]	ø22.20 [7/8"]	ø28.58 [1-1/8"]
P401 to P450	ø15.88 [5/8"]	ø22.20 [7/8"]	ø28.58 [1-1/8"]

HP : High pressure, LP:Low pressure

Table3-2-2-6. Piping "a", "b", "c", "d", "e", "f" size selection rule (mm [in.])

Indoor Unit size	Pipe(Liquid)	Pipe(Gas)
P15 to P50, GUF-50RD(H)	ø6.35 [1/4"]	ø12.70 [1/2"]
P63 to P140, GUF-100RD(H)	ø9.52 [3/8"]	ø15.88 [5/8"]
P200	ø9.52 [3/8"]	ø19.05 [3/4"]
P250	ø9.52 [3/8"]	ø22.20 [7/8"]

3-2-5. IF more than 16 ports are in use, or if there is more than one BC controller in use for two outdoor units
PURY-P-YSLM-A1

- Note1. No Header usable on PURY system.
- Note2. Indoor unit sized P100-P250 should be connected to BC controller via Y shape joint CMY-R160-J1 ;
- Note3. Indoor unit sized P100-P250 does NOT share BC controller ports with other Indoor units ;
- Note4. As bends cause pressure loss on transportation of refrigerant, fewer bends design is better ;
 Piping length needs to consider the actual length and equivalent length which bends are counted.
 Equivalent piping length (m)=Actual piping length**M* * N. Number of bent.
- Note5. Set DIP-SW 4-6 to ON of BC controller, in case of connected Indoor unit sized P100-P140 with 2 ports.
- Note6. It is also possible to connect Indoor unit sized P100-P140 with 1 port (set DIP-SW 4-6 to OFF).
 However, the cooling capacity decreases a little (For details, refer to the chapter OUTDOOR UNITS, R2 SERIES, 6-4. Correction by port counts of the BC controller).
- Note7. Individual indoor units grouped together to connect to the BC controller via one port cannot operate individually in heating and cooling modes at the same time. I.e., they must all function in either heating or cooling together.
- Note8. For sub BC controller CMB-P-V-GB1 the connectable indoor unit capacities may sum to equal that of a P350 unit or less. However, if two sub controllers are used the TOTAL sum of connectable units connected to BOTH sub controllers must also not exceed that of a P350 unit.
 For sub BC controller CMB-P1016V-HB1 the connectable indoor unit capacities may sum to equal that or a P350 unit or less. However, if two sub controllers are used the TOTAL sum of connectable units connected to BOTH sub controllers must also not exceed that of a P450 unit.
- Note9. Indoor capacity is described as its model size. For example, PEFY-P63VML-E, its capacity is P63.
- Note10. Total down-stream Indoor capacity is the summary of the model size of Indoors down-stream.
 For example, PEFY-P63VML-E + PEFY-P32VML-E : Total Indoor capacity = P63 + P32 = P95.
- Note11. To enable the continuous heating mode, set SW4 (848) to ON.

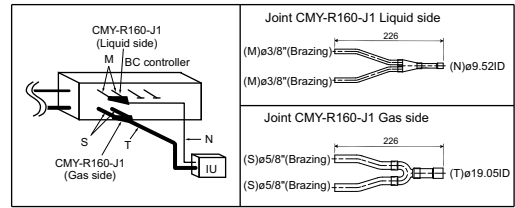

Fig. 3-2-3AA

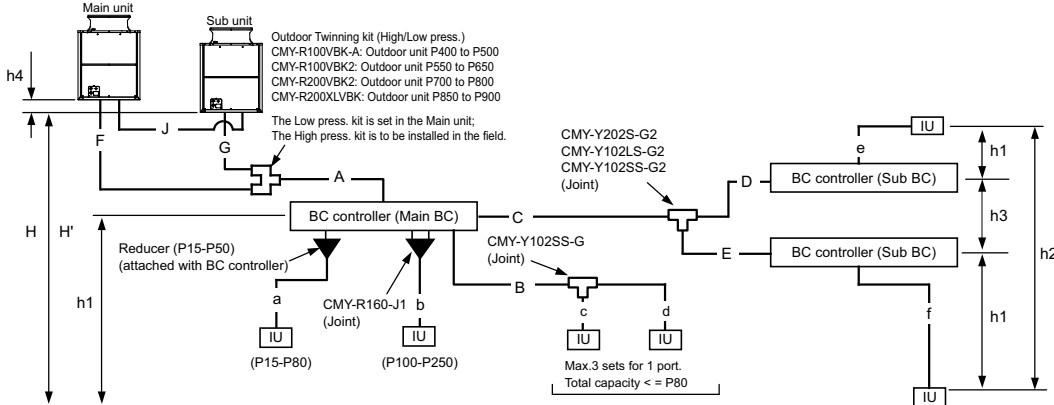

Fig. 3-2-3A Piping scheme

IU : Indoor unit

Table3-2-3-1. Piping length limitation

Item	Piping in the figure	Max. length	Max. equivalent length
Total piping length	F+G+J+A+B+C+D+E+a+b+c+d+e+f	*1	-
Farthest IU from OU	F(G)+A+C+E+f	165 [541']	190 [623']
Distance between OU and BC	F(G)+A	110 [360'] *1	110 [360'] *1
Farthest IU from BC controller	B+d or C+D+e or C+E+f	40 [131'] *2*3	40 [131'] *2*3
Height between OU and IU (OU above IU)	H	50 [164'] *6	-
Height between OU and IU (OU under IU)	H'	40 [131'] *7	-
Height between IU and BC	h1	15 [49'] (10 [32']) *4	-
Height between IU and IU	h2	15 [49'] (10 [32']) *4	-
Height between BC(Main or Sub) and BC(Sub)	h3	15 [49'] (10 [32']) *5	-
Distance between Main unit and Sub unit	F+G or J	5 [16']	-
Height between Main unit and Sub unit	h4	0.1 [0.3']	-

Table3-2-3-2. Bent equivalent length "M"

Outdoor Model	M (m/bent [ft./bent])
P400YSLM-A1	0.50 [1.64']
P450YSLM-A1	0.50 [1.64']
P500YSLM-A1	0.50 [1.64']
P550YSLM-A1	0.50 [1.64']
P600YSLM-A1	0.50 [1.64']
P650YSLM-A1	0.50 [1.64']
P700YSLM-A1	0.70 [2.29']
P750YSLM-A1	0.70 [2.29']
P800YSLM-A1	0.70 [2.29']
P850YSLM-A1	0.80 [2.62']
P900YSLM-A1	0.80 [2.62']

OU : Outdoor Unit ; IU : Indoor Unit ; BC : BC controller

*1. Refer to the section 3-2-7.

*2. Details refer to Fig.3-2-3-1

*3. Farthest Indoor from BC controller "B+d or C+D+e or C+E+f" can exceed 40m till 60m if no Indoor sized P200, P250 connected. Details refer to Fig.3-2-3-1

*4. Distance of Indoor sized P200, P250 from BC must be less than 10m, if any.

*5. When using 2 Sub BC controllers, max. height "h3" should be considered.

*6. 90m is available depending on the model and installation conditions. For more detailed information, contact your local distributor.

*7. 60m is available depending on the model and installation conditions. For more detailed information, contact your local distributor.

Fig. 3-2-3-1 Piping length and height between IU and BC controller

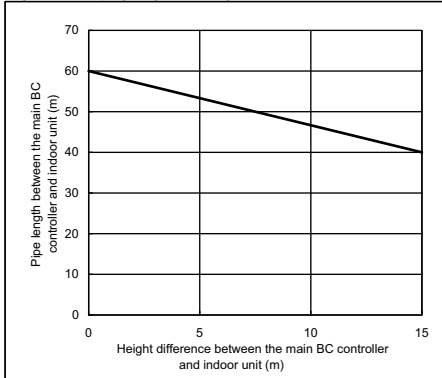

Table3-2-3-6. Piping "F", "G", "J" size selection rule (mm [in.])

Outdoor Model	Pipe(High pressure)	Pipe(Low pressure)
P200YLM-A1	ø15.88 [5/8"]	ø19.05 [3/4"]
P250YLM-A1	ø19.05 [3/4"]	ø22.20 [7/8"]
P300YLM-A1	ø19.05 [3/4"]	ø22.20 [7/8"]
P350YLM-A1	ø19.05 [3/4"]	ø28.58 [1-1/8"]
P400YLM-A1	ø22.20 [7/8"]	ø28.58 [1-1/8"]
P450YLM-A1	ø22.20 [7/8"]	ø28.58 [1-1/8"]
P500YLM-A1	ø22.20 [7/8"]	ø28.58 [1-1/8"]

Table3-2-3-3. Piping "A" size selection rule (mm [in.])

Outdoor Model	Pipe(High pressure)	Pipe(Low pressure)
P400YSLM-A1	ø22.20 [7/8"]	ø28.58 [1-1/8"]
P450YSLM-A1	ø22.20 [7/8"]	ø28.58 [1-1/8"]
P500YSLM-A1	ø22.20 [7/8"]	ø28.58 [1-1/8"]
P550YSLM-A1	ø28.58 [1-1/8"]	ø28.58 [1-1/8"]
P600YSLM-A1	ø28.58 [1-1/8"]	ø28.58 [1-1/8"]
P650YSLM-A1	ø28.58 [1-1/8"]	ø28.58 [1-1/8"]
P700YSLM-A1	ø28.58 [1-1/8"]	ø34.93 [1-3/8"]
P750YSLM-A1	ø28.58 [1-1/8"]	ø34.93 [1-3/8"]
P800YSLM-A1	ø28.58 [1-1/8"]	ø34.93 [1-3/8"]
P850YSLM-A1	ø28.58 [1-1/8"]	ø41.28 [1-5/8"]
P900YSLM-A1	ø28.58 [1-1/8"]	ø41.28 [1-5/8"]

Table3-2-3-4. Piping "B" size selection rule (mm [in.])

Total down-stream Indoor capacity	Pipe(Liquid)	Pipe(Gas)
P140 or less	ø9.52 [3/8"]	ø15.88 [5/8"]

Table3-2-3-5. Piping "C", "D", "E" size selection rule (mm [in.])

Total down-stream Indoor capacity	Pipe(Liquid)	Pipe(HP Gas)	Pipe(LP Gas)
P200 or less	ø9.52 [3/8"]	ø15.88 [5/8"]	ø19.05 [3/4"]
P201 to P300	ø9.52 [3/8"]	ø19.05 [3/4"]	ø22.20 [7/8"]
P301 to P350	ø12.70 [1/2"]	ø19.05 [3/4"]	ø28.58 [1-1/8"]
P351 to P400	ø12.70 [1/2"]	ø22.20 [7/8"]	ø28.58 [1-1/8"]
P401 to P450	ø15.88 [5/8"]	ø22.20 [7/8"]	ø28.58 [1-1/8"]

HP : High pressure, LP:Low pressure

Table3-2-3-7. Piping "a", "b", "c", "d", "e", "f" size selection rule (mm [in.])

Indoor Unit size	Pipe(Liquid)	Pipe(Gas)
P15 to P50	ø6.35 [1/4"]	ø12.70 [1/2"]
P63 to P140	ø9.52 [3/8"]	ø15.88 [5/8"]
P200	ø9.52 [3/8"]	ø19.05 [3/4"]
P250	ø9.52 [3/8"]	ø22.20 [7/8"]

3-2-6. IF more than 16 ports are in use, or if there is more than one BC controller in use for two outdoor units

PURY-EP-YSLM

- Note1. No Header usable on PURY system.
- Note2. Indoor unit sized P100-P250 should be connected to BC controller via Y shape joint CMY-R160-J1 ;
- Note3. Indoor unit sized P100-P250 does NOT share BC controller ports with other Indoor units ;
- Note4. As bends cause pressure loss on transportation of refrigerant, fewer bends design is better ; Piping length needs to consider the actual length and equivalent length which bends are counted. Equivalent piping length (m)=Actual piping length+“M” x Number of bent.
- Note5. Set DIP-SW 4-6 to ON of BC controller, in case of connected Indoor unit sized P100-P140 with 2 ports.
- Note6. It is also possible to connect Indoor unit sized P100-P140 with 1 port (set DIP-SW 4-6 to OFF). However, the cooling capacity decreases a little (For details, refer to the chapter OUTDOOR UNITS, R2 SERIES, 6-4. Correction by port counts of the BC controller).
- Note7. Individual indoor units grouped together to connect to the BC controller via one port cannot operate individually in heating and cooling modes at the same time. I.e., they must all function in either heating or cooling together.
- Note8. For sub BC controller CMB-P-V-GB1 the connectable indoor unit capacities may sum to equal that of a P350 unit or less. However, if two sub controllers are used the TOTAL sum of connectable units connected to BOTH sub controllers must also not exceed that of a P350 unit. For sub BC controller CMB-P1016V-HB1 the connectable indoor unit capacities may sum to equal that of a P350 unit or less. However, if two sub controllers are used the TOTAL sum of connectable units connected to BOTH sub controllers must also not exceed that of a P450 unit.
- Note9. Indoor capacity is described as its model size. For example, PEFY-P63VML-E, its capacity is P63.
- Note10. Total down-stream Indoor capacity is the summary of the model size of Indoors down-stream. For example, PEFY-P63VML-E + PEFY-P32VML-E : Total Indoor capacity = P63 + P32 = P95.
- Note11. To enable the continuous heating mode, set SW4 (848) to ON.

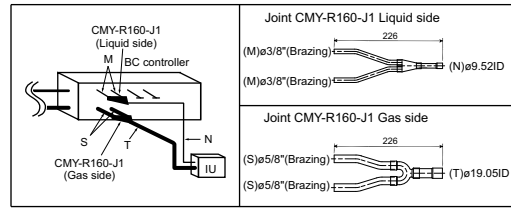

Fig. 3-2-3AA

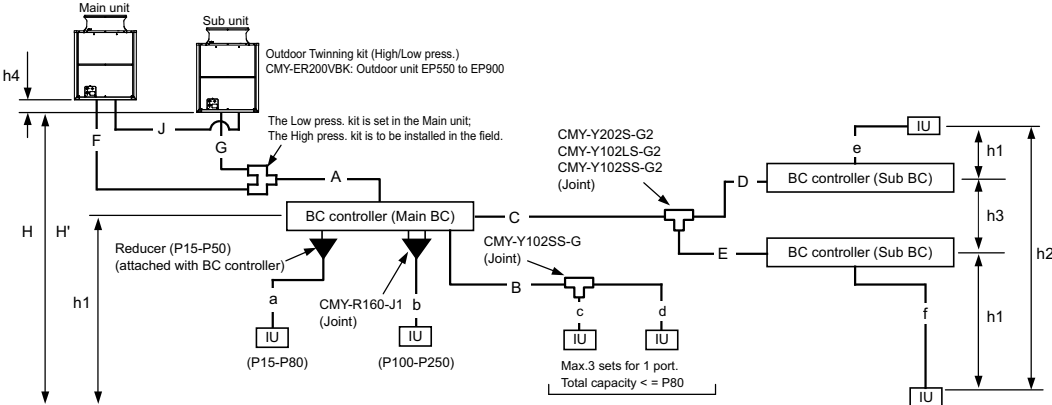

Fig. 3-2-3A Piping scheme

IU : Indoor unit

Table3-2-3-1. Piping length limitation

Item	Piping in the figure	Max. length	Max. equivalent length
Total piping length	F+G+J+A+B+C+D+E+a+b+c+d+e+f	*1	-
Farthest IU from OU	F(G)+A+C+E+f	165 [541']	190 [623']
Distance between OU and BC	F(G)+A	110 [360'] *1	110 [360'] *1
Farthest IU from BC controller	B+d or C+D+e or C+E+f	40 [131'] *2*3	40 [131'] *2*3
Height between OU and IU (OU above IU)	H	50 [164'] *6	-
Height between OU and IU (OU under IU)	H'	40 [131'] *7	-
Height between IU and BC	h1	15 [49'] (10 [32']) *4	-
Height between IU and IU	h2	15 [49'] (10 [32']) *4	-
Height between BC(Main or Sub) and BC(Sub)	h3	15 [49'] (10 [32']) *5	-
Distance between Main unit and Sub unit	F+G or J	5 [16']	-
Height between Main unit and Sub unit	h4	0.1 [0.3']	-

Table3-2-3-2. Bent equivalent length "M"

Outdoor Model	M (m/bent [ft./bent])
EP550YSLM	0.50 [1.64']
EP600YSLM	0.50 [1.64']
EP650YSLM	0.50 [1.64']
EP700YSLM	0.70 [2.29']
EP750YSLM	0.70 [2.29']
EP800YSLM	0.70 [2.29']
EP850YSLM	0.80 [2.62']
EP900YSLM	0.80 [2.62']

OU : Outdoor Unit ; IU : Indoor Unit ; BC : BC controller

*1. Refer to the section 3-2-4.

*2. Details refer to Fig.3-2-3-1

*3. Farthest indoor from BC controller "B+d or C+D+e or C+E+f" can exceed 40m till 60m if no Indoor sized P200, P250 connected. Details refer to Fig.3-2-3-1

*4. Distance of Indoor sized P200, P250 from BC must be less than 10m, if any.

*5. When using 2 Sub BC controllers, max. height "h3" should be considered.

*6. 90m is available depending on the model and installation conditions. For more detailed information, contact your local distributor.

*7. 60m is available depending on the model and installation conditions. For more detailed information, contact your local distributor.

Fig. 3-2-3-1 Piping length and height between IU and BC controller

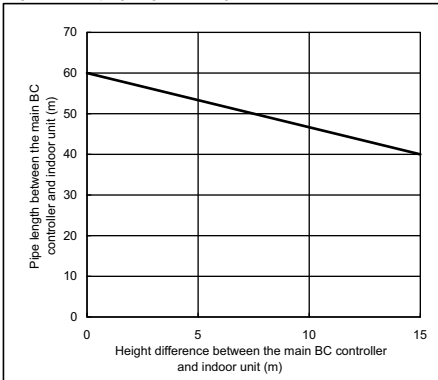

Table3-2-3-3. Piping "A" size selection rule (mm [in.])

Outdoor Model	Pipe(High pressure)	Pipe(Low pressure)
EP550YSLM	ø28.58 [1-1/8"]	ø28.58 [1-1/8"]
EP600YSLM	ø28.58 [1-1/8"]	ø28.58 [1-1/8"]
EP650YSLM	ø28.58 [1-1/8"]	ø28.58 [1-1/8"]
EP700YSLM	ø28.58 [1-1/8"]	ø34.93 [1-3/8"]
EP750YSLM	ø28.58 [1-1/8"]	ø34.93 [1-3/8"]
EP800YSLM	ø28.58 [1-1/8"]	ø34.93 [1-3/8"]
EP850YSLM	ø28.58 [1-1/8"]	ø41.28 [1-5/8"]
EP900YSLM	ø28.58 [1-1/8"]	ø41.28 [1-5/8"]

Table3-2-3-4. Piping "B" size selection rule (mm [in.])

Total down-stream Indoor capacity	Pipe(Liquid)	Pipe(Gas)
P140 or less	ø9.52 [3/8"]	ø15.88 [5/8"]

Table3-2-3-5. Piping "C", "D", "E" size selection rule (mm [in.])

Total down-stream Indoor capacity	Pipe(Liquid)	Pipe(HP Gas)	Pipe(LP Gas)
P200 or less	ø9.52 [3/8"]	ø15.88 [5/8"]	ø19.05 [3/4"]
P201 to P300	ø9.52 [3/8"]	ø19.05 [3/4"]	ø22.20 [7/8"]
P301 to P350	ø12.70 [1/2"]	ø19.05 [3/4"]	ø28.58 [1-1/8"]
P351 to P400	ø12.70 [1/2"]	ø22.20 [7/8"]	ø28.58 [1-1/8"]
P401 to P450	ø15.88 [5/8"]	ø22.20 [7/8"]	ø28.58 [1-1/8"]

HP : High pressure, LP:Low pressure

Table3-2-3-6. Piping "F", "G", "J" size selection rule (mm [in.])

Outdoor Model	Pipe(High pressure)	Pipe(Low pressure)
EP200YLM	ø15.88 [5/8"]	ø19.05 [3/4"]
EP250YLM	ø19.05 [3/4"]	ø22.20 [7/8"]
EP300YLM	ø19.05 [3/4"]	ø22.20 [7/8"]
EP350YLM	ø19.05 [3/4"]	ø28.58 [1-1/8"]
EP400YLM	ø22.20 [7/8"]	ø28.58 [1-1/8"]
EP450YLM	ø22.20 [7/8"]	ø28.58 [1-1/8"]

Table3-2-3-7. Piping "a", "b", "c", "d", "e", "f" size selection rule (mm [in.])

Indoor Unit size	Pipe(Liquid)	Pipe(Gas)
P15 to P50	ø6.35 [1/4"]	ø12.70 [1/2"]
P63 to P140	ø9.52 [3/8"]	ø15.88 [5/8"]
P200	ø9.52 [3/8"]	ø19.05 [3/4"]
P250	ø9.52 [3/8"]	ø22.20 [7/8"]

3-2-7. Total piping length restrictions

[PURY-P200, 250YLM-A1]

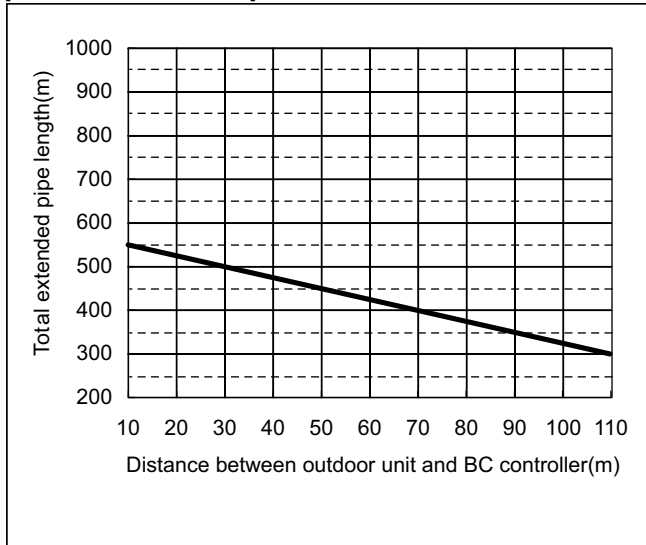

[PURY-P300, 350YLM-A1]

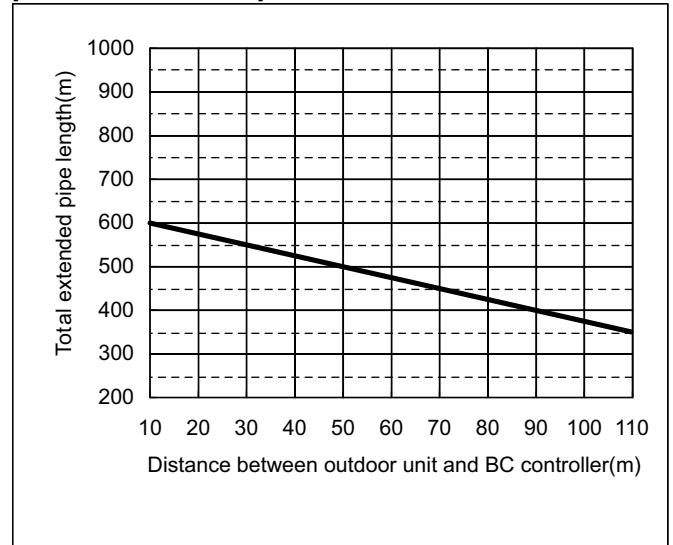

[PURY-P400, 450, 500, 550Y(S)LM-A1]

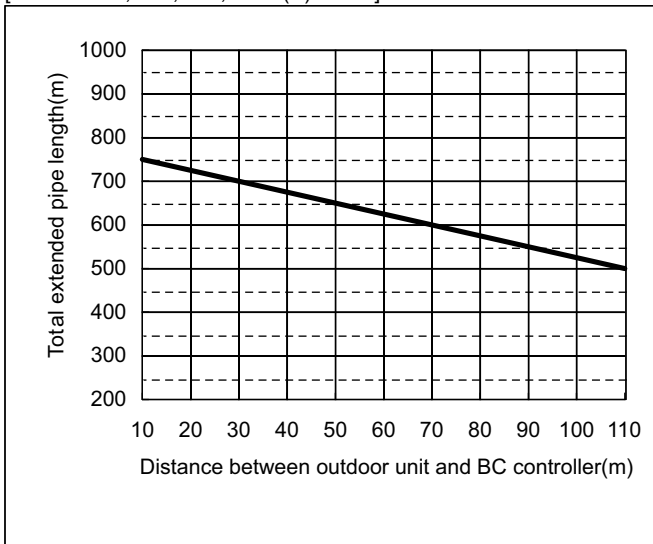

[PURY-P600, 650YSLM-A1]

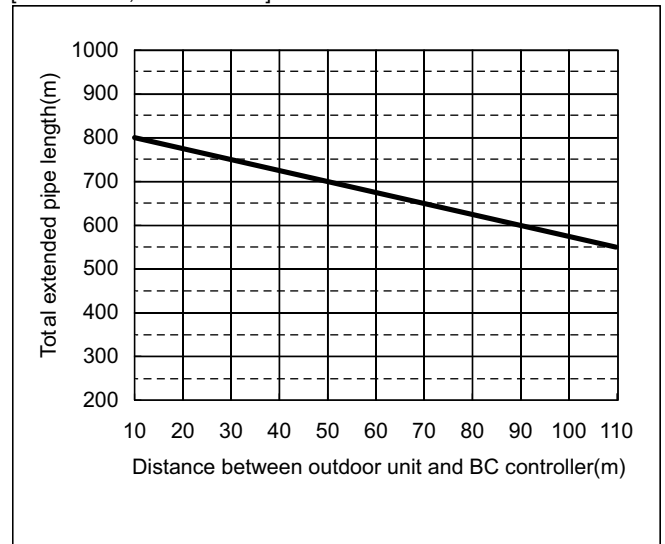

[PURY-P700, 750, 800, 850, 900YSLM-A1]

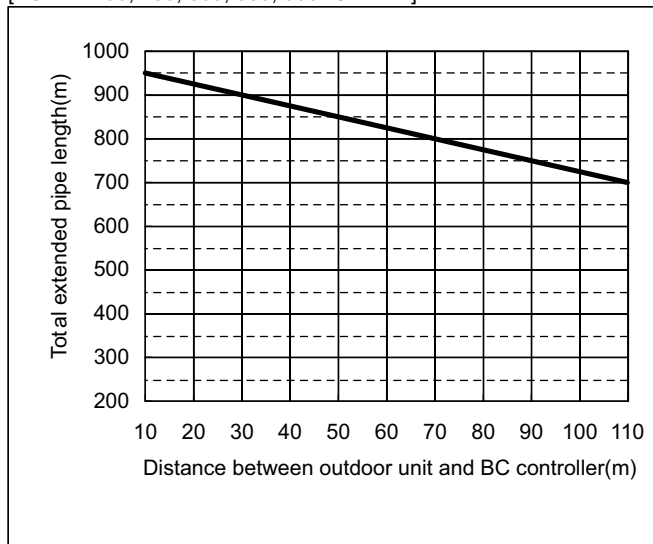

[PURY-EP200, 250YLM-A]

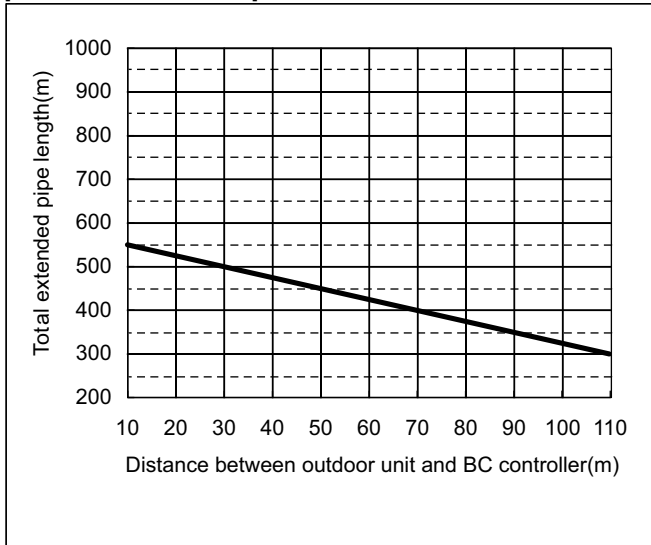

[PURY-EP300, 350, 400, 450, 500YLM-A]

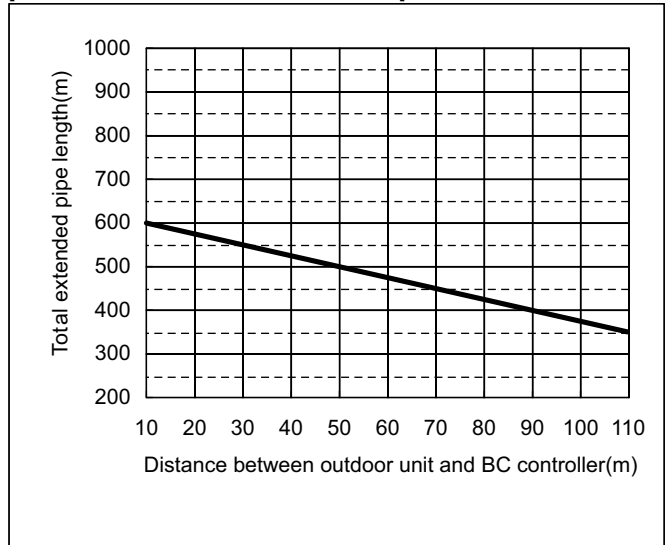

[PURY-EP550YSLM-A]

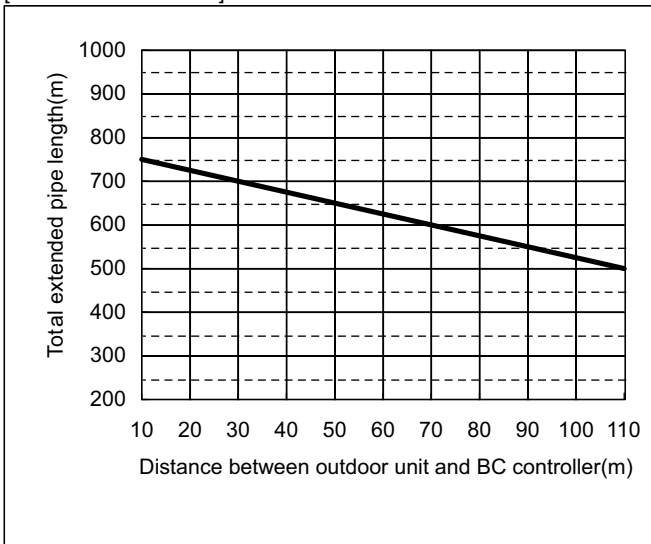

[PURY-EP600, 650YSLM-A]

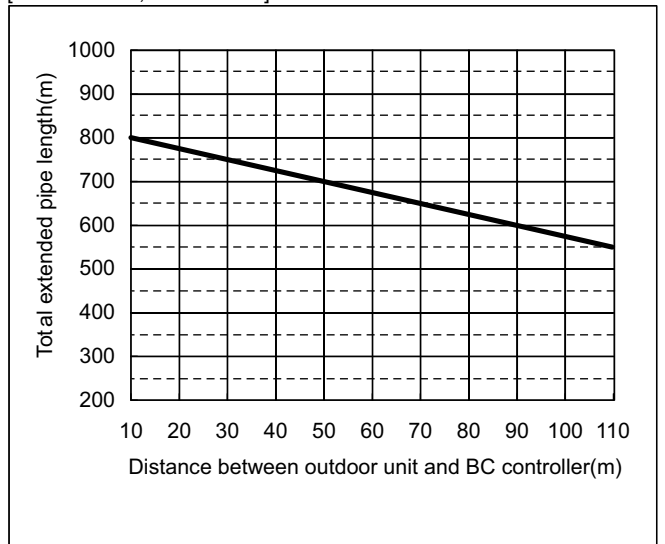

[PURY-EP700, 750, 800, 850, 900YSLM-A]

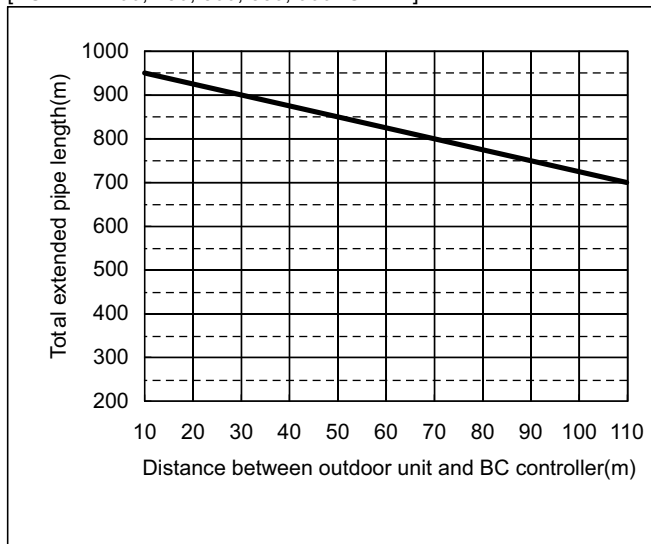

3-3. Refrigerant charging calculation

PURY-P-YLM-A1

Sample connection (with 3 BC controller and 6 indoor units) (PURY-P700YSLM-A1)

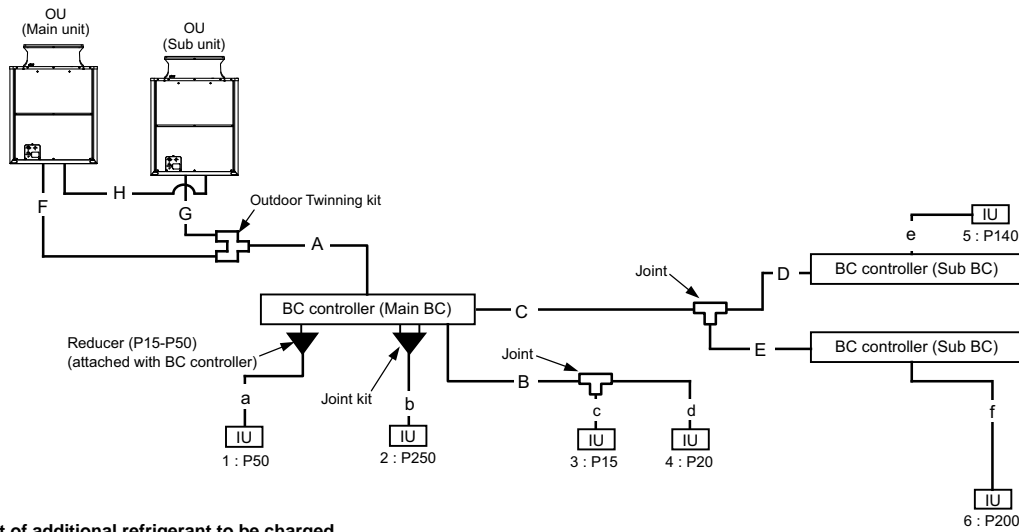

Amount of additional refrigerant to be charged

Refrigerant for extended pipes (field piping) is not factory-charged to the outdoor unit. Add an appropriate amount of refrigerant for each pipes on site. Record the size of each high pressure pipe and liquid pipe, and the amount of refrigerant that was charged on the outdoor unit for future reference.

Calculating the amount of additional refrigerant to be charged

The amount of refrigerant to be charged is calculated with the size of the on-site-installed high pressure pipes and liquid pipes, and their length. Calculate the amount of refrigerant to be charged according to the formula below. Round up the calculation result to the nearest 0.1kg. (i.e., 16.03 kg = 16.1 kg)

<Amount of additional refrigerant to be charged>

Calculating the amount of additional refrigerant to be charged

Units "m" and "kg" (In an R2 system)

<Formula>

• When the piping length from the outdoor unit to the farthest indoor unit is 30.5 m (100 ft) or shorter

Amount of additional charge (kg)	=	High-pressure pipe ø28.58 total length × 0.36 (kg/m)	+	High-pressure pipe ø22.2 total length × 0.23 (kg/m)	+	High-pressure pipe ø19.05 total length × 0.16 (kg/m)	+	High-pressure pipe ø15.88 total length × 0.11 (kg/m)	+	Liquid pipe ø15.88 total length × 0.2 (kg/m)
	+	Liquid pipe ø12.7 total length × 0.12 (kg/m)	+	Liquid pipe ø9.52 total length × 0.06 (kg/m)	+	Liquid pipe ø6.35 total length × 0.024 (kg/m)				

Total capacity of outdoor units	Amount (to be added for standard or main BC controller)	+	Main BC controller	Amount
P200	3.0kg		HA-type	2.0kg
P250	4.5kg			
P300	4.5kg			
P350-900	6.0kg			

Number of sub BC controllers	Amount (to be added for sub BC controller)	+	Total capacity of connected indoor units	Amount (to be added for indoor unit)
1	1.0kg		80 or below	2.0kg
2	2.0kg		81 to 160	2.5kg
			161 to 330	3.0kg
			331 to 390	3.5kg
			391 to 480	4.5kg
			481 to 630	5.0kg
			631 to 710	6.0kg
			711 to 800	8.0kg
			801 to 890	9.0kg
			891 to 1070	10.0kg
			1071 to 1250	12.0kg
			1251 or above	14.0kg

Outdoor unit model	Amount (to be added for outdoor unit)
Single	
P200 to P250YLM-A1	0kg
P300 to P400YLM-A1	0kg
P450 to P500YLM-A1	5.5kg
Combination	
P400 to P550YSLM-A1	0kg
P600 to P800YSLM-A1	0kg
P850YSLM-A1	5.5kg
P900YSLM-A1	11.0kg

• When the piping length from the outdoor unit to the farthest indoor unit is longer than 30.5 m (100 ft)

Amount of additional charge (kg)	=	High-pressure pipe ø28.58 total length × 0.33 (kg/m)	+	High-pressure pipe ø22.2 total length × 0.21 (kg/m)	+	High-pressure pipe ø19.05 total length × 0.14 (kg/m)	+	High-pressure pipe ø15.88 total length × 0.1 (kg/m)	+	Liquid pipe ø15.88 total length × 0.18 (kg/m)
----------------------------------	---	--	---	---	---	--	---	---	---	---

+	Liquid pipe ø12.7 total length × 0.11 (kg/m)	+	Liquid pipe ø9.52 total length × 0.054 (kg/m)	+	Liquid pipe ø6.35 total length × 0.021 (kg/m)
---	--	---	---	---	---

	Total capacity of outdoor units	+	Amount (to be added for standard or main BC controller)	+	Main BC controller	+	Amount
	P200		3.0kg		HA-type		2.0kg
	P250		4.5kg				
	P300		4.5kg				
	P350-900		6.0kg				

	Number of sub BC controllers	+	Amount (to be added for sub BC controller)	+	Total capacity of connected indoor units	+	Amount (to be added for indoor unit)
	1		1.0kg		80 or below		2.0kg
	2		2.0kg		81 to 160		2.5kg
					161 to 330		3.0kg
					331 to 390		3.5kg
					391 to 480		4.5kg
					481 to 630		5.0kg
					631 to 710		6.0kg
					711 to 800		8.0kg
					801 to 890		9.0kg
					891 to 1070		10.0kg
					1071 to 1250		12.0kg
					1251 or above		14.0kg

	Outdoor unit model	+	Amount (to be added for outdoor unit)
Single	P200 to P250YLM-A1		0kg
	P300 to P400YLM-A1		0kg
	P450 to P500YLM-A1		5.5kg
Combination	P400 to P550YSLM-A1		0kg
	P600 to P800YSLM-A1		0kg
	P850YSLM-A1		5.5kg
	P900YSLM-A1		11.0kg

Amount of factory charged refrigerant ■ **Sample calculation**

Outdoor unit Model	Charged amount
P200 P250	9.5 kg
P300 P350 P400	10.3 kg
P450 P500	11.8 kg

Indoor 1: 50 A: ø28.58 40m a: ø6.35 10m
 2: 250 B: ø9.52 10m b: ø9.52 5m
 3: 15 C: ø12.70 20m c: ø6.35 5m
 4: 20 D: ø9.52 5m d: ø6.35 10m
 5: 140 E: ø9.52 5m e: ø9.52 5m
 6: 200 F: ø19.05 3m f: ø9.52 5m
 G: ø19.05 1m

Outdoor P700

The total length of each liquid line is as follows:

ø28.58: A = 40 m
 ø19.05: F + G = 4 m
 ø12.70: C = 20 m
 ø9.52: B + D + E + b + e + f = 35 m
 ø6.35: a + c + d = 25 m

Therefore,
 <Calculation example>
 Additional refrigerant charge
 = 40 × 0.33 + 4 × 0.14 + 20 × 0.11 + 35 × 0.054 + 25 × 0.021 + 6
 + 2 + 2 + 6
 = 34.4 (34.375) kg

Limitation of the amount of refrigerant to be charged

The above calculation result of the amount of refrigerant to be charged must become below the value in the table below.

Outdoor unit model	P200 YLM-A1	P250 YLM-A1	P300 YLM-A1	P350 YLM-A1	P400 YLM-A1	P450 YLM-A1	P500 YLM-A1	P400 YSLM-A1	P450 YSLM-A1	P500 YSLM-A1	P550 YSLM-A1	P600 YSLM-A1	P650 YSLM-A1	P700 YSLM-A1	P750 YSLM-A1
Maximum amount of refrigerant *1	27.5kg	33.5kg	37.0kg	39.0kg	45.0kg	49.0kg	49.0kg	52.0kg	52.0kg	52.0kg	59.0kg	62.5kg	75.0kg	79.5kg	79.5kg

Outdoor unit model	P800 YSLM-A1	P850 YSLM-A1	P900 YSLM-A1
Maximum amount of refrigerant *1	79.5kg	84.0kg	89.0kg

*1 Amount of additional refrigerant to be charged on site

PURY-EP-YLM

Sample connection (with 3 BC controller and 6 indoor units) (PURY-EP700YSLM-A)

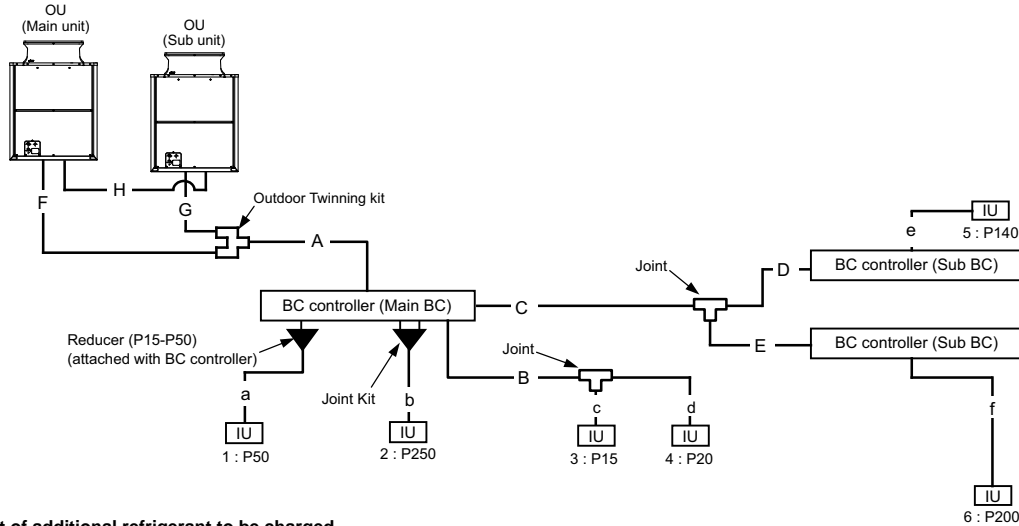

Amount of additional refrigerant to be charged

Refrigerant for extended pipes (field piping) is not factory-charged to the outdoor unit. Add an appropriate amount of refrigerant for each pipes on site. Record the size of each high pressure pipe and liquid pipe, and the amount of refrigerant that was charged on the outdoor unit for future reference.

Calculating the amount of additional refrigerant to be charged

The amount of refrigerant to be charged is calculated with the size of the on-site-installed high pressure pipes and liquid pipes, and their length. Calculate the amount of refrigerant to be charged according to the formula below. Round up the calculation result to the nearest 0.1kg. (i.e., 16.03 kg = 16.1 kg)

<Amount of additional refrigerant to be charged>

Calculating the amount of additional refrigerant to be charged

Units "m" and "kg" (In an R2 system)

<Formula>

• When the piping length from the outdoor unit to the farthest indoor unit is 30.5 m (100 ft) or shorter

Amount of additional charge (kg)	=	High-pressure pipe ø28.58 total length × 0.36 (kg/m)	+	High-pressure pipe ø22.2 total length × 0.23 (kg/m)	+	High-pressure pipe ø19.05 total length × 0.16 (kg/m)	+	High-pressure pipe ø15.88 total length × 0.11 (kg/m)	+	Liquid pipe ø15.88 total length × 0.2 (kg/m)
		Liquid pipe ø12.7 total length × 0.12 (kg/m)	+	Liquid pipe ø9.52 total length × 0.06 (kg/m)	+	Liquid pipe ø6.35 total length × 0.024 (kg/m)				

+	Total capacity of outdoor units	Amount (to be added for standard or main BC controller)	+	Main BC controller	Amount
	EP200	3.0kg		HA-type	2.0kg
	EP250	4.5kg			
	EP300	4.5kg			
	EP350-900	6.0kg			

+	Number of sub BC controllers	Amount (to be added for sub BC controller)	+	Total capacity of connected indoor units	Amount (to be added for indoor unit)
	1	1.0kg		80 or below	2.0kg
	2	2.0kg	81 to 160	2.5kg	
			161 to 330	3.0kg	
			331 to 390	3.5kg	
			391 to 480	4.5kg	
			481 to 630	5.0kg	
			631 to 710	6.0kg	
			711 to 800	8.0kg	
			801 to 890	9.0kg	
			891 to 1070	10.0kg	
			1071 to 1250	12.0kg	
			1251 or above	14.0kg	

+	Outdoor unit model		Amount (to be added for outdoor unit)
	Single	EP200 to EP250YLM	0kg
		EP300 to EP350YLM	0kg
		EP400 to EP500YLM	1.0kg
	Combination	EP550YSLM	0kg
		EP600 to EP700YSLM	0kg
		EP750YSLM	1.0kg
		EP800 to EP900YSLM	2.0kg

• When the piping length from the outdoor unit to the farthest indoor unit is longer than 30.5 m (100 ft)

Amount of additional charge (kg)	=	High-pressure pipe ø28.58 total length × 0.33 (kg/m)	+	High-pressure pipe ø22.2 total length × 0.21 (kg/m)	+	High-pressure pipe ø19.05 total length × 0.14 (kg/m)	+	High-pressure pipe ø15.88 total length × 0.1 (kg/m)	+	Liquid pipe ø15.88 total length × 0.18 (kg/m)
	+	Liquid pipe ø12.7 total length × 0.11 (kg/m)	+	Liquid pipe ø9.52 total length × 0.054 (kg/m)	+	Liquid pipe ø6.35 total length × 0.021 (kg/m)				

Total capacity of outdoor units	Amount (to be added for standard or main BC controller)	+	Main BC controller	Amount
EP200	3.0kg		HA-type	2.0kg
EP250	4.5kg			
EP300	4.5kg			
EP350-900	6.0kg			

Number of sub BC controllers	Amount (to be added for sub BC controller)	+	Total capacity of connected indoor units	Amount (to be added for indoor unit)
1	1.0kg		80 or below	2.0kg
2	2.0kg		81 to 160	2.5kg
			161 to 330	3.0kg
			331 to 390	3.5kg
			391 to 480	4.5kg
			481 to 630	5.0kg
			631 to 710	6.0kg
			711 to 800	8.0kg
			801 to 890	9.0kg
			891 to 1070	10.0kg
			1071 to 1250	12.0kg
			1251 or above	14.0kg

Outdoor unit model	Amount (to be added for outdoor unit)
Single	EP200 to EP250YLM: 0kg
	EP300 to EP350YLM: 0kg
	EP400 to EP500YLM: 1.0kg
Combination	EP550YSLM: 0kg
	EP600 to EP700YSLM: 0kg
	EP750YSLM: 1.0kg
	EP800 to EP900YSLM: 2.0kg

Amount of factory charged refrigerant

Outdoor unit Model	Charged amount
EP200 EP250	8.5 kg
EP300 EP350	9.3 kg
EP400 EP450 EP500	11.8 kg

Sample calculation

Indoor 1: 50 A: ø28.58 40m a: ø6.35 10m
 2: 250 B: ø9.52 10m b: ø9.52 5m
 3: 15 C: ø12.70 20m c: ø6.35 5m
 4: 20 D: ø9.52 5m d: ø6.35 10m
 5: 140 E: ø9.52 5m e: ø9.52 5m
 6: 200 F: ø19.05 3m f: ø9.52 5m
 G: ø19.05 1m

Outdoor EP700

The total length of each liquid line is as follows:

ø28.58: A = 40 m
 ø19.05: F + G = 4 m
 ø12.70: C = 20 m
 ø9.52: B + D + E + b + e + f = 35 m
 ø6.35: a + c + d = 25 m
 Therefore,
 <Calculation example>
 Additional refrigerant charge
 = 40 × 0.33 + 4 × 0.14 + 20 × 0.11 + 35 × 0.054 + 25 × 0.021 + 6
 + 2 + 2 + 6
 = 34.4 (34.375) kg

Limitation of the amount of refrigerant to be charged

The above calculation result of the amount of refrigerant to be charged must become below the value in the table below.

Outdoor unit model	EP200 YLM	EP250 YLM	EP300 YLM	EP350 YLM	EP400 YLM	EP450 YLM	EP500 YLM	EP550 YSLM	EP600 YSLM	EP650 YSLM	EP700 YSLM	EP750 YSLM	EP800 YSLM	EP850 YSLM	EP900 YSLM
Maximum amount of refrigerant *1	27.5kg	33.5kg	37.0kg	39.0kg	45.0kg	49.0kg	49.0kg	59.0kg	62.5kg	75.0kg	79.5kg	79.5kg	79.5kg	84.0kg	89.0kg

*1 Amount of additional refrigerant to be charged on site

4-1. Requirement on installation site

1. No direct thermal radiation to the unit.
2. No possibility of annoying the neighbors by the sound of the unit.

Valves and refrigerant flow on the outdoor unit may generate noise.

3. Avoid the sites where strong winds blow.
4. With strength to bear the weight of the unit.
5. Drain flow from the unit is cared at heating mode.
6. Enough space for installation and service as shown at 4-2.
7. Avoid the sites where acidic solutions or chemical sprays (sulfur series) are used frequently.
8. The unit should be secure from combustible gas, oil, steam, chemical gas like acidic solution, sulfur gas and so on.

4-2. Spacing

In case of single installation

- Secure enough space around the unit as shown in the figure.
- If the wall height exceeds the height limit, widen the space labeled "L" and "W" by the amount that exceeds the limit (labeled h in the figure).

S.D. R2

(1) Walls are lower than the height limit.

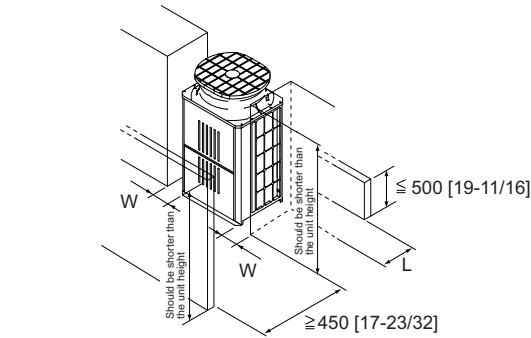

Condition	L	W
Minimum space behind the unit	≥ 100 [3-15/16]	≥ 50 [1-31/32]
Minimum space on both sides of the unit	≥ 300 [11-13/16]	≥ 15 [19/32]

(2) If the wall height (H) of the front, rear or side exceeds the wall height restriction

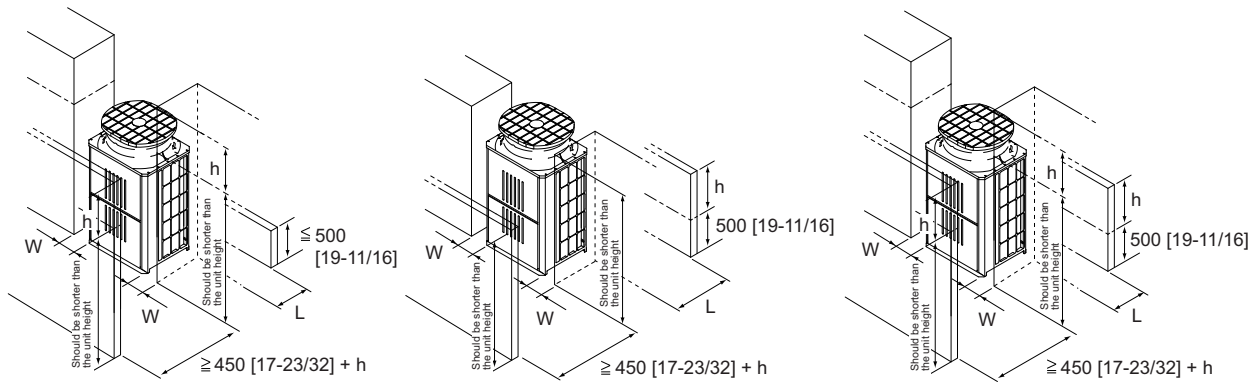

Condition	L	W
Minimum space behind the unit	≥ 100 [3-15/16] + h	≥ 50 [1-31/32] + h
Minimum space on both sides of the unit	≥ 300 [11-13/16] + h	≥ 15 [19/32] + h

(3) If there are obstacles at the upper part of the unit

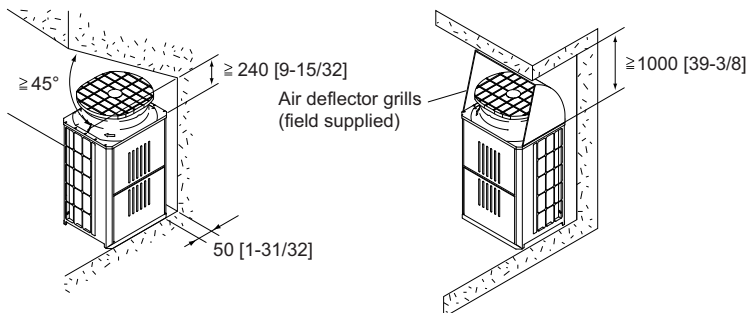

(Unit : mm [in.])

In case of collective installation and continuous installation

- When multiple units are installed adjacent to each other, secure enough space to allow for air circulation and passageways between groups of units as shown in the figures.
- * Leave both sides of each group of units open.
- As with single installation, if the wall height exceeds the height limit, widen the space in the front and the back of a given group of units by the amount that exceeds the limit (labeled h in the figure).
- If there is a wall at both the front and the rear of the unit, install up to six units (three units: P450, 500, EP400, 450, 500) consecutively in the side direction and provide a space of 1000mm or more as inlet space/passage space for each six units (three units: P450, 500, EP400, 450, 500).

(1) Side-by-side installation

<The space on both sides of a given group of units is minimum.>

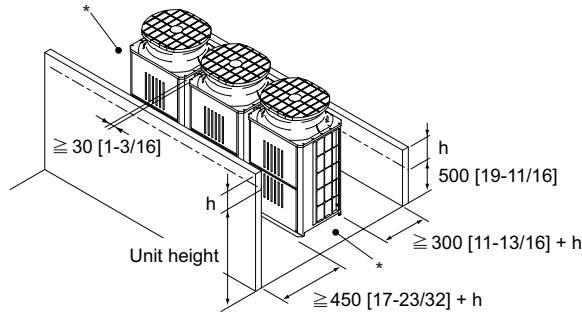

<The space on both sides of a given group of units is minimum.>

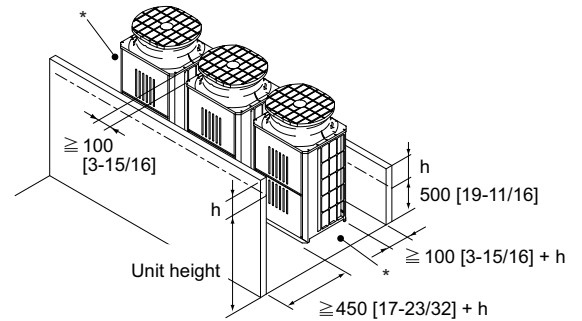

(2) Face-to-face installation

<There are walls in the front and the back of a given group of units.>

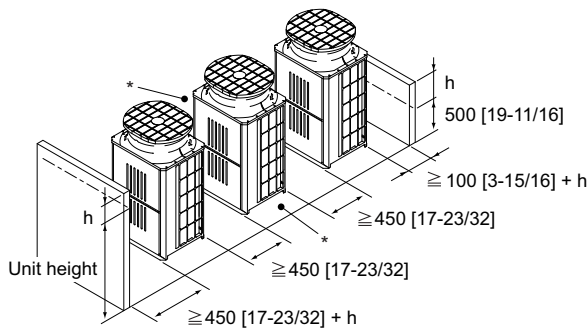

<There is a wall on one side.>

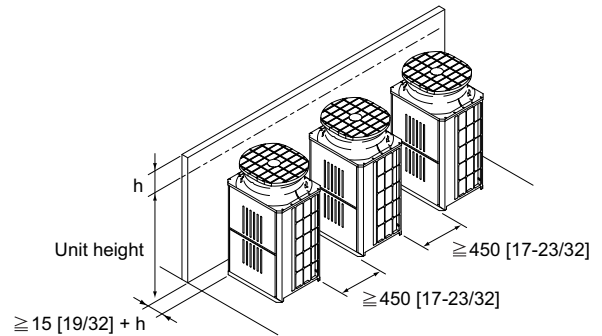

(3) Combination of face-to-face and side-by-side installations

<There are walls in the front and the back of a given group of units.>

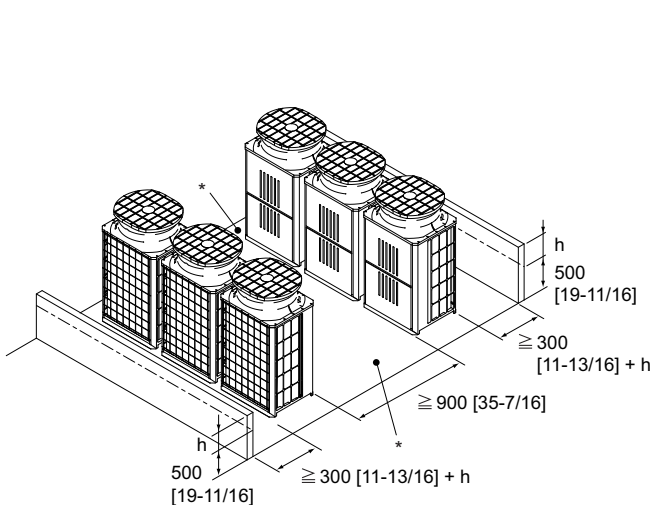

<There is a wall on one side and either the front or the back of a given group of unit.>

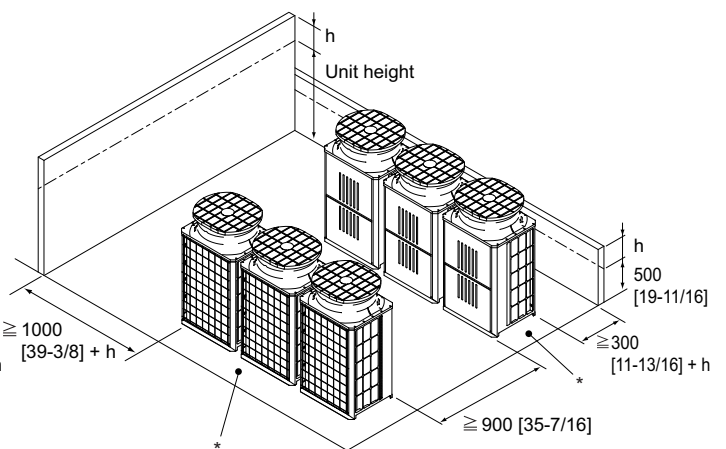

(Unit : mm [in.])

4-3. Piping direction

4-3-1. Lifting method

- When lifting the unit with ropes, run the ropes under the unit and use the lifting hole.
- Support the unit at four points with two ropes, and avoid giving mechanical shock.
- Suspension rope angle must be 40° or less, so as to avoid compressing fan guard.
- Use two ropes, each at least 8m [26 ft.] in length
- Use ropes strong enough to support the weight of the unit.
- Always suspend the unit from four corners. (It is dangerous to suspend a unit from two corners and must not be attempted.)
- Use protective pads to keep the ropes from scratching the panels on the unit.
- Use a 50mm [1-31/32 in.] or thicker cardboard or cloth as a protective pad on the top of the unit to prevent contact between the fan guard and slings.

① P200, 250
EP200, 250

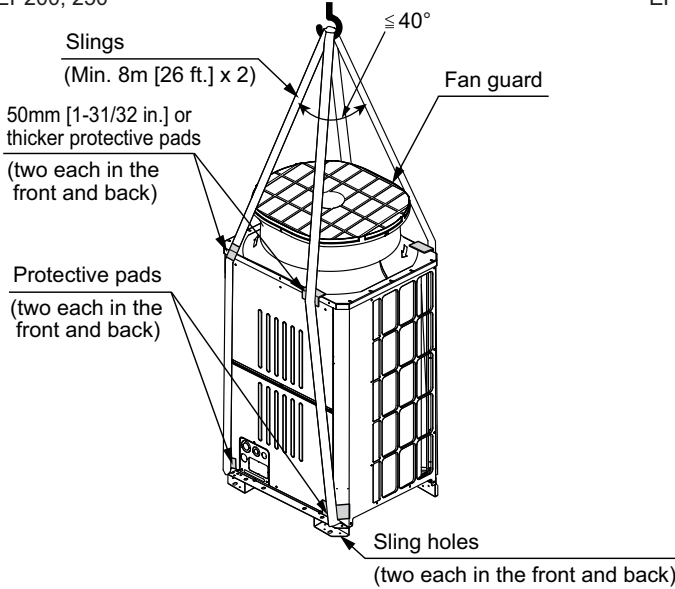

② P300, 350, 400
EP300, 350

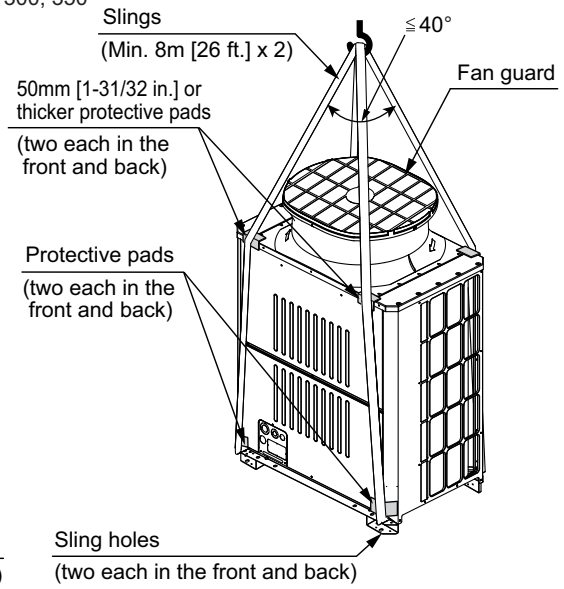

③ P450, 500
EP400, 450, 500

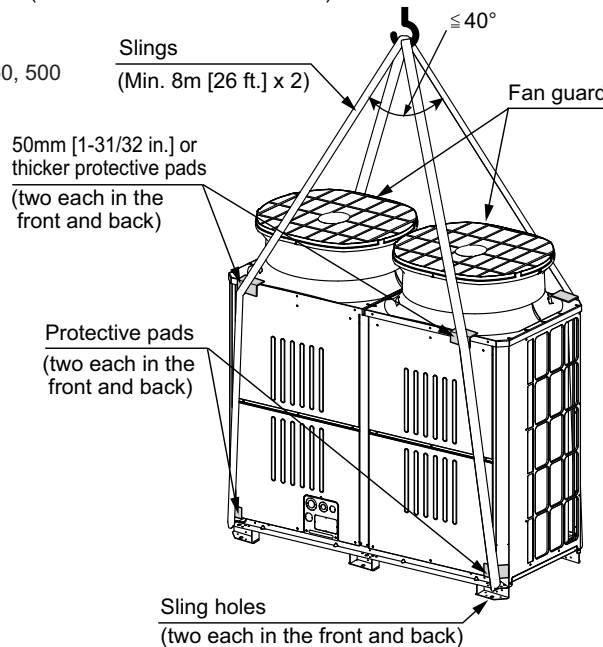

CAUTION

Exercise caution when transporting products.

- Products weighing more than 20 kg [45 LBS] should not be carried alone.
- Do not carry the product by the PPbands.
- To avoid the risk of injury, do not touch the heat exchanger fins.
- Plastic bags may pose a risk of choking hazard to children. Tear plastic bags into pieces before disposing of them.
- When lifting and transporting outdoor units with ropes, run the ropes through lifting hole at the unit base. Securely fix the unit so that the ropes will not slide off, and always lift the unit at four points to prevent the unit from falling.

4-3-2. Installation

- Secure the unit with anchor bolts as shown in the figure below so that the unit will not topple over with strong wind or during an earthquake.
- Install the unit on a durable base made of such materials as concrete or angle steel.
- Take appropriate anti-vibration measures (e.g., vibration damper pad, vibration isolation base) to keep vibrations and noise from being transmitted from the unit through walls and floors.
- When using a rubber cushion, install it so that the cushion covers the entire width of the unit leg.
- Install the unit in such a way that the corner of the angle bracket at the base of the unit shown in the figure below is securely supported.
- Install the anchor bolt in such a way that the top end of the anchor bolt do not stick out more than 30 mm [1-3/16 in.].
- This unit is not designed to be anchored with post-installation-type anchor bolts, although by adding fixing brackets anchoring with such type of anchor bolts becomes possible.

- (A) : M10 anchor bolt procured at the site.
- (B) : Corner is not seated.
- (C) : Fixing bracket for hole-in anchor bolt (3 locations to fix with screws).
- (D) : Anti-vibration rubber
Install it so that the rubber covers the entire width of the unit leg.

⚠ WARNING

Properly install the unit on a surface that can withstand the weight of the unit. Unit installed on an unstable surface may fall and cause injury.

⚠ WARNING

Take appropriate safety measures against strong winds and earthquakes to prevent the unit from falling.

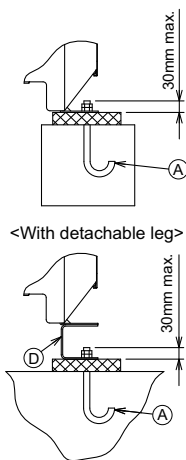

Install the unit in such a way that the corner of the angle bracket at the base of the unit shown in the figure is securely supported. The brackets may bend if they are not securely supported.

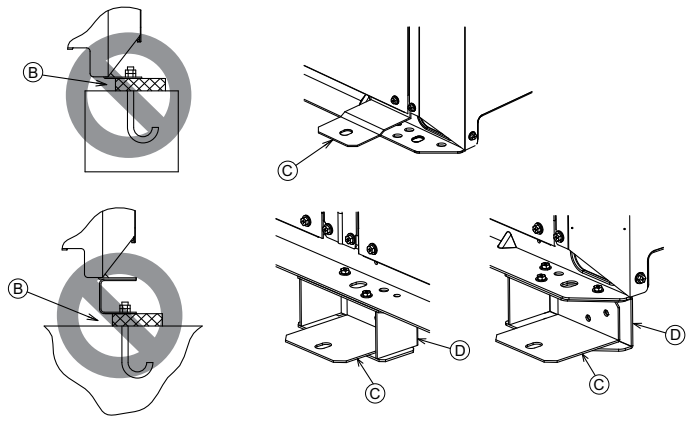

Install the unit in such a way that the corner of the angle bracket at the base of the unit shown in the figure is securely supported. The brackets may bend if they are not securely supported.

Take into consideration the durability of the base, water drainage route (Drain water is discharged from outdoor units during operation.), piping route, and wiring route when performing foundation work.

4-3-3. Anchor bolt positions

<P200-400, EP200-350>

• Individual installation

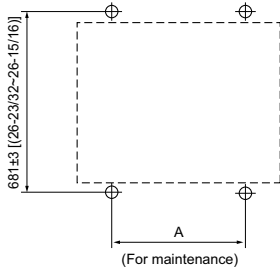

• Collective installation

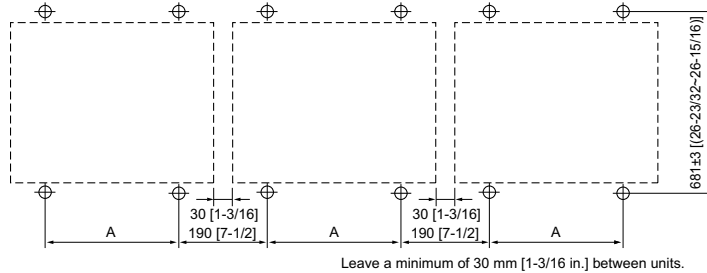

(Unit : mm [in.])

<P450, 500, EP400-500>

• Individual installation

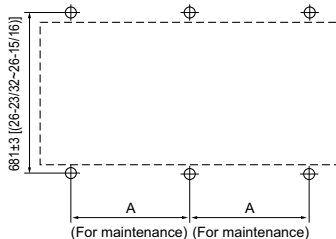

• Collective installation

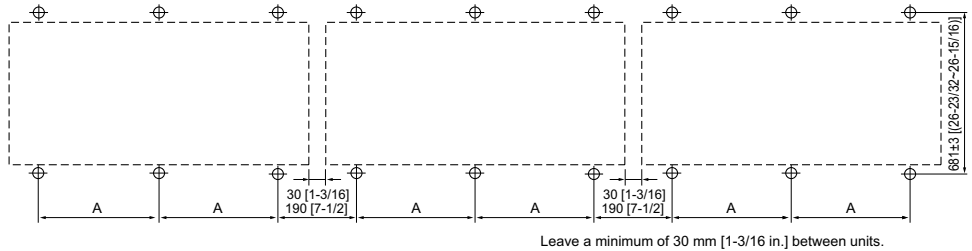

PURY	P200, 250, EP200, 250	P300, 350, 400, EP300, 350	P450, 500, EP400, 450, 500
A	760±2 [29-15/16(29-27/32-30)]	1060±2 [41-3/4(41-21/32-41-13/16)]	795±2 [31-5/16(31-1/4-31-13/32)]

4-3-4. Installation

When the pipes and/or cables are routed at the bottom of the unit, make sure that the through hole at the base of the unit does not get blocked with the installation base.

When the pipes are routed at the bottom of the unit, the base should be at least 100 mm [3-15/16 in.] in height.

(Unit: mm [in.])

· P200, 250, EP200, 250

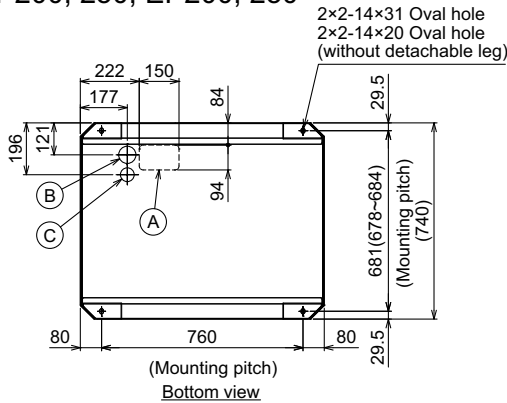

· P300, 350, 400, EP300, 350

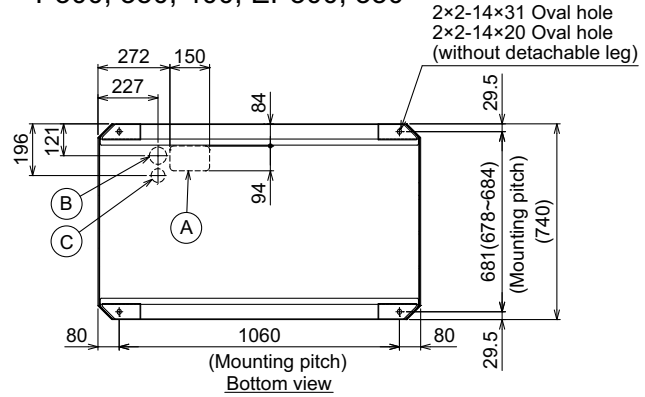

· P450, 500, EP400, 450, 500

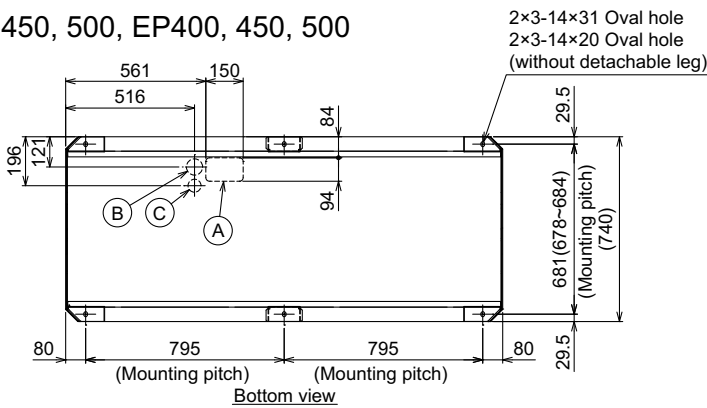

NO.	Usage	Specifications
(A)	For pipes	Bottom through hole 150 × 94 Knockout hole (5-29/32) (3-23/32)
(B)	For wires	Bottom through hole Ø65 Knockout hole (2-9/16)
(C)		Bottom through hole Ø52 Knockout hole (2-1/16)

Installation base parallel to the unit's front panel

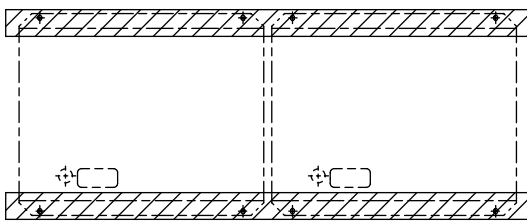

Installation base perpendicular to the unit's front panel

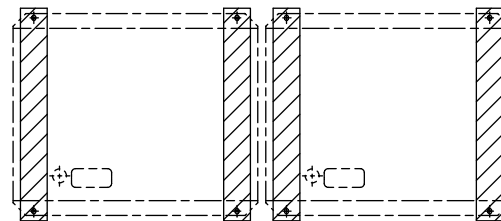

4-3-5. Refrigerant pipe routing

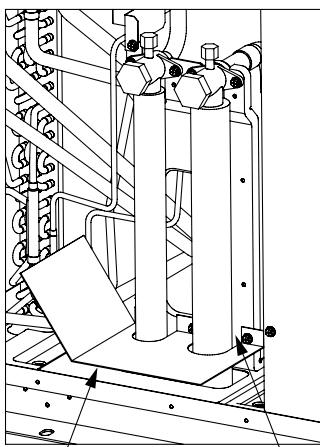

Example of closure materials (field supply)

Fill the gap at the site

The gaps around the edges of through holes for pipes and wires on the unit allow water or mice to enter the unit and damage its parts. Close these gaps with filler plates.

This unit allows two types of pipe routing:

- Bottom piping
- Front piping

CAUTION

To prevent small animals, water and snow from entering the unit and damage its parts, close the gap around the edges of through holes for pipes and wires with filler plates.

※ The figure above shows a unit on which a low-pressure twinning pipe kit is not installed.

4-3-6. Twinning on the outdoor unit side

- The pipe from multiple outdoor units must be installed so that oil will not accumulate in the pipe under certain conditions. Refer to the figures below for details.

* Small dots in the figures indicate branching points.

Ⓐ In an R2 system: To a BC controller

- The pipe from the outdoor units must be inclined downward to the indoor unit side. In the figure on the right, because the pipe is inclined upward, the oil in the pipe accumulates when Unit 1 is in operation and Unit 2 is stopped.



- The distance between the unit bottom and the pipe (H) must be 0.2 m (7-7/8 in) or below. In the figure on the right, because the distance is more than 0.2 m (7-7/8 in), the oil accumulates in Unit 1 when Unit 2 is in operation and Unit 1 is stopped.



- The vertical separation between units (H) must be 0.1 m (3-15/16 in) or below. In the figure on the right, because the distance is more than 0.1 m (3-15/16 in), the oil accumulates in Unit 1 when Unit 2 is in operation and Unit 1 is stopped.



- The vertical separation between units (H) must be 0.1 m (3-15/16 in) or below. In the figure on the right, because the distance is more than 0.1 m (3-15/16 in), the oil accumulates in Unit 2 when Unit 1 is in operation and Unit 2 is stopped.

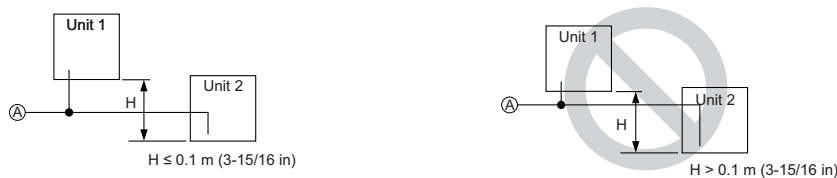

- Make sure that the inclination tolerance of the Twinning Kit is $\pm 15^\circ$ to the ground to avoid unit damage.

Ⓐ Twinning Kit

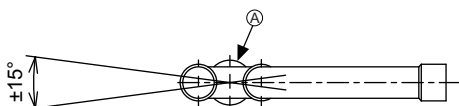

- Do not install traps to prevent oil backflow and compressor start-up failure.

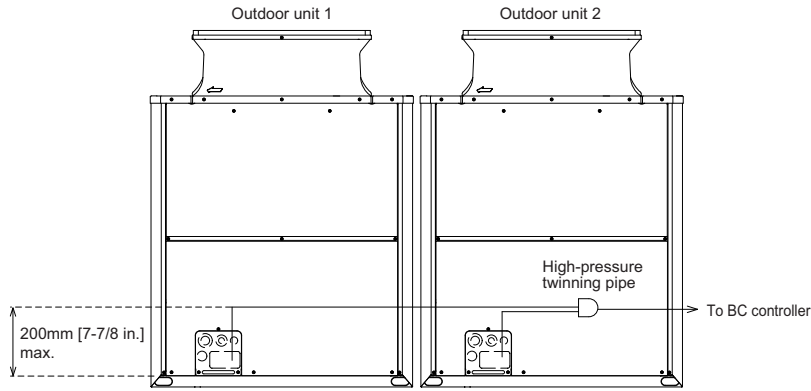

4-3-7. Twinning on the outdoor unit side

See the following drawing for connecting the pipes between the outdoor units.

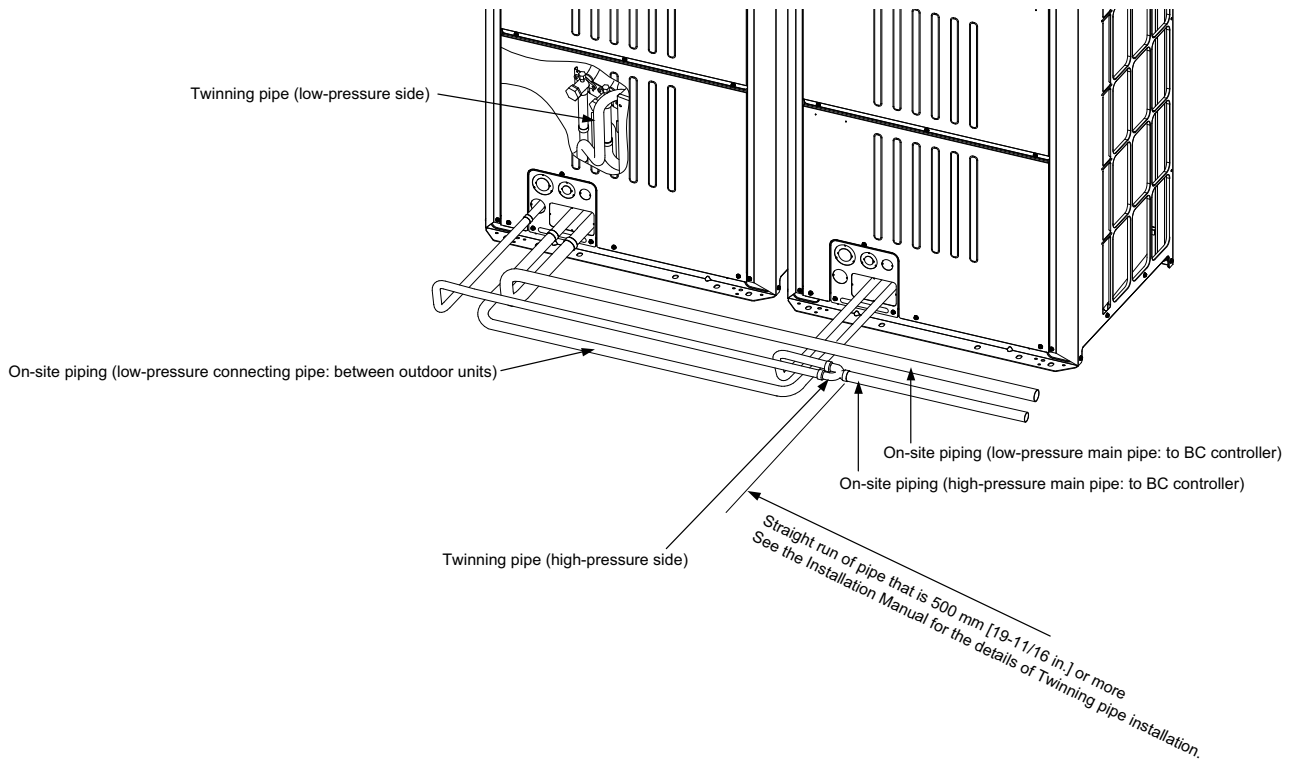

4-4. Weather countermeasure

In cold and/or snowy areas, sufficient countermeasures to wind and snow damages should be taken for operating unit in normal and good condition in winter time. Surround the units with snow nets or fences to protect them from snow. Even in the other areas, full consideration is required for installation of unit in order to prevent abnormal operations caused by wind or snow. **When rain and snow directly fall on unit in the case of air-conditioning operations in 10 or less degrees centigrade outdoor air (50 or less degrees fahrenheit outdoor air), mount inlet and outlet ducts on unit for assuring stable operations.**

Countermeasure to snow and wind

Prevention the Outdoor unit from wind and snow damages in cold or snowy areas, snow hood shown below is recommended and helpful.

*Do not use a snow hood made of stainless steel, which may cause the unit to rust. If the use of a stainless snow hood is the only option, contact the sales office before installing it.

- Snow hood

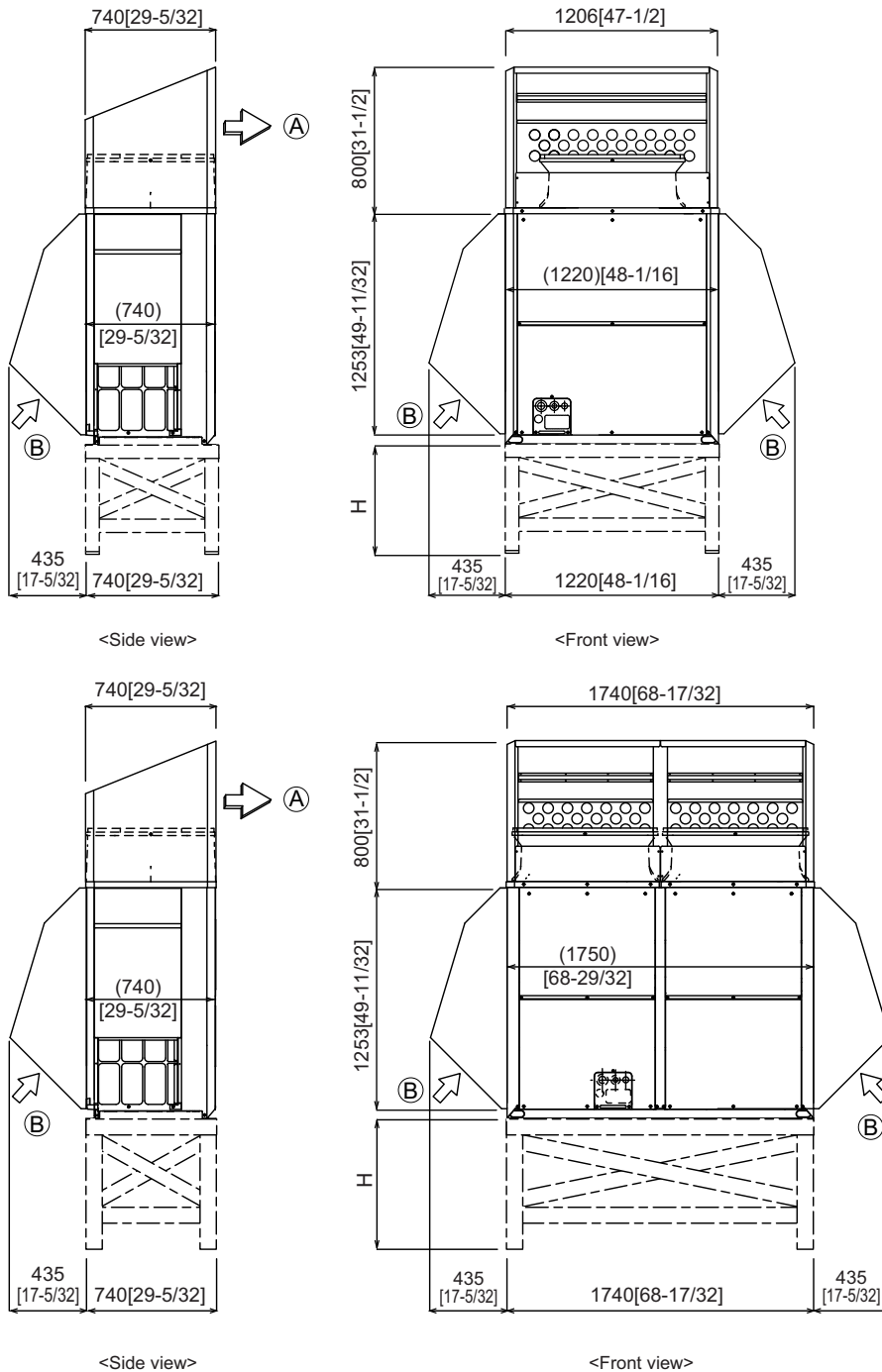

Note:

1. Height of frame base for snow damage prevention (H) shall be twice as high as expected snowfall. Width of frame base shall not exceed that of the unit. The frame base shall be made of angle steel, etc., and designed so that snow and wind slip through the structure. (If frame base is too wide, snow will be accumulated on it.)
2. Install unit so that wind will not directly lash against openings of inlet and outlet ducts.
3. Build frame base at customer referring to this figure.
 Material : Galvanized steel plate 1.2T [1/16 in. T]
 Painting : Overall painting with polyester powder
 Color : Munsell 5Y8/1 (same as that of unit)
4. To install units side by side, install a filler plate between the fan guard and the outlet-side snow food as shown in Figure A.
 (The filler plate provided accommodates the installation pitch of between 30-80 mm [1-3/16~3-5/32 in.])
5. When the unit is used in a cold region and the heating operation is continuously performed for a long time when the outside air temperature is below freezing, install a heater to the unit base or take other appropriate measures to prevent water from freezing on the base.

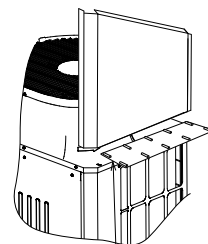
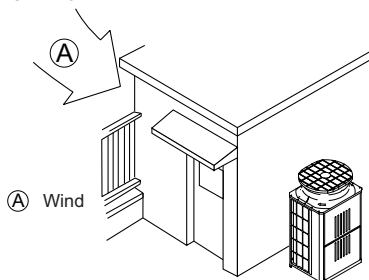

Figure A Filler plate

Countermeasure to wind

Referring to the figure shown below, take appropriate measures which will suit the actual situation of the place for installation. A unit installed alone is vulnerable to strong winds. Select the installation site carefully to minimize the effect of winds. To install a unit in a place where the wind always blows from the same direction, install the unit so that the outlet faces away from the direction of the wind.



Install the outdoor unit where seasonal winds do not blow directly against the unit, such as behind a building.

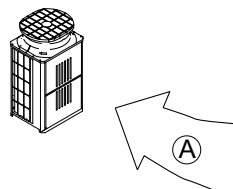

Install the outdoor unit to avoid having seasonal winds against the front of air outlet/inlet on the unit.

5-1. General precautions

5-1-1. Usage

- The air-conditioning system described in this Data Book is designed for human comfort.
- This product is not designed for preservation of food, animals, plants, precision equipment, or art objects. To prevent quality loss, do not use the product for purposes other than what it is designed for.
- To reduce the risk of water leakage and electric shock, do not use the product for air-conditioning vehicles or vessels.

5-1-2. Installation environment

- Do not install any unit other than the dedicated unit in a place where the voltage changes a lot, large amounts of mineral oil (e.g., cutting oil) are present, cooking oil may splash, or a large quantity of steam can be generated such as a kitchen.
- Do not install the unit in acidic or alkaline environment.
- Installation should not be performed in the locations exposed to chlorine or other corrosive gases. Avoid near a sewer.
- To reduce the risk of fire, do not install the unit in a place where flammable gas may be leaked or inflammable material is present.
- This air conditioning unit has a built-in microcomputer. Take the noise effects into consideration when deciding the installation position. Especially in a place where antenna or electronic device are installed, it is recommended that the air conditioning unit be installed away from them.
- Install the unit on a solid foundation according to the local safety measures against typhoons, wind gusts, and earthquakes to prevent the unit from being damaged, toppling over, and falling.

5-1-3. Backup system

- In a place where air conditioner's malfunctions may exert crucial influence, it is recommended to have two or more systems of single outdoor units with multiple indoor units.

5-1-4. Unit characteristics

- Heat pump efficiency depends on outdoor temperature. In the heating mode, performance drops as the outside air temperature drops. In cold climates, performance can be poor. Warm air would continue to be trapped near the ceiling and the floor level would continue to stay cold. In this case, heat pumps require a supplemental heating system or air circulator. Before purchasing them, consult your local distributor for selecting the unit and system.
- When the outdoor temperature is low and the humidity is high, the heat exchanger on the outdoor unit side tends to collect frost, which reduces its heating performance. To remove the frost, Auto-defrost function will be activated and the heating mode will temporarily stop for 3-10 minutes. Heating mode will automatically resume upon completion of defrost process.
- Air conditioner with a heat pump requires time to warm up the whole room after the heating operation begins, because the system circulates warm air in order to warm up the whole room.
- The sound levels were obtained in an anechoic room. The sound levels during actual operation are usually higher than the simulated values due to ambient noise and echoes. Refer to the section on "SOUND LEVELS" for the measurement location.
- Depending on the operation conditions, the unit generates noise caused by valve actuation, refrigerant flow, and pressure changes even when operating normally. Please consider to avoid location where quietness is required. For BC controller, it is recommended to unit to be installed in places such as ceilings of corridor, restrooms and plant rooms.
- The total capacity of the connected indoor units can be greater than the capacity of the outdoor unit. However, when the connected indoor units operate simultaneously, each unit's capacity may become smaller than the rated capacity.
- When the unit is started up for the first time within 12 hours after power on or after power failure, it performs initial startup operation (capacity control operation) to prevent damage to the compressor. The initial startup operation requires 90 minutes maximum to complete, depending on the operation load.

5-1-5. Relevant equipment

- Use an earth leakage breaker (ELB) with medium sensitivity, and an activation speed of 0.1 second or less.
- Consult your local distributor or a qualified technician when installing an earth leakage breaker.
- If the unit is inverter type, select an earth leakage breaker for handling high harmonic waves and surges.
- Leakage current is generated not only through the air conditioning unit but also through the power wires. Therefore, the leakage current of the main power supply is greater than the total leakage current of each unit. Take into consideration the capacity of the earth leakage breaker or leakage alarm when installing one at the main power supply. To measure the leakage current simply on site, use a measurement tool equipped with a filter, and clamp all the four power wires together. The leakage current measured on the ground wire may not accurate because the leakage current from other systems may be included to the measurement value.
- Do not install a phase advancing capacitor on the unit connected to the same power system with an inverter type unit and its equipment.
- If a large current flows due to the product malfunctions or faulty wiring, both the earth leakage breaker on the product side and the upstream overcurrent breaker may trip almost at the same time. Separate the power system or coordinate all the breakers depending on the system's priority level.

5-1-6. Unit installation

- Your local distributor or a qualified technician must read the Installation Manual that is provided with each unit carefully before performing installation work.
- Consult your local distributor or a qualified technician when installing the unit. Improper installation by an unqualified person may result in water leakage, electric shock, or fire.
- Ensure there is enough space around each unit.

5-1-7. Optional accessories

- Only use accessories recommended by Mitsubishi Electric. Consult your local distributor or a qualified technician when installing them. Improper installation by an unqualified person may result in water leakage, electric leakage, system breakdown, or fire.
- Some optional accessories may not be compatible with the air conditioning unit to be used or may not be suitable for the installation conditions. Check the compatibility when considering any accessories.
- Note that some optional accessories may affect the air conditioner's external form, appearance, weight, operating sound, and other characteristics.

5-1-8. Operation/Maintenance

- Read the Instruction Book that is provided with each unit carefully prior to use.
- Maintenance or cleaning of each unit may be risky and require expertise. Read the Instruction Book to ensure safety. Consult your local distributor or a qualified technician when special expertise is required such as when the indoor unit needs to be cleaned.

5-2. Precautions for Indoor unit

5-2-1. Operating environment

- The refrigerant (R410A) used for air conditioner is non-toxic and nonflammable. However, if the refrigerant leaks, the oxygen level may drop to harmful levels. If the air conditioner is installed in a small room, measures must be taken to prevent the refrigerant concentration from exceeding the safety limit even if the refrigerant should leak.
- If the units operate in the cooling mode at the humidity above 80%, condensation may collect and drip from the indoor units.

5-2-2. Unit characteristics

- The return air temperature display on the remote controller may differ from the ones on the other thermometers.
- The clock on the remote controller may be displayed with a time lag of approximately one minute every month.
- The temperature using a built-in temperature sensor on the remote controller may differ from the actual room temperature due to the effect of the wall temperature.
- Use a built-in thermostat on the remote controller or a separately-sold thermostat when indoor units installed on or in the ceiling operate the automatic cooling/heating switchover.
- The room temperature may rise drastically due to Thermo OFF in the places where the air conditioning load is large such as computer rooms.
- Be sure to use a regular filter. If an irregular filter is installed, the unit may not operate properly, and the operation noise may increase.
- The room temperature may rise over the preset temperature in the environment where the heating air conditioning load is small.

5-2-3. Unit installation

- For simultaneous cooling/heating operation type air conditioners (R2, WR2 series), the G-type BC controller cannot be connected to the 16HP outdoor unit model or above, and the G- and GA-type BC controllers cannot be connected to the 28HP model or above. The GB- and HB-type BC controllers (sub) cannot be connected to the outdoor unit directly, and be sure to use them with GA- and HA-type BC controllers (main).
- The insulation for low pressure pipe between the BC controller and outdoor unit shall be at least 20 mm thick. If the unit is installed on the top floor or in a high-temperature, high-humidity environment, thicker insulation may be necessary.
- Do not have any branching points on the downstream of the refrigerant pipe header.
- When a field-supplied external thermistor is installed or when a device for the demand control is used, abnormal stop of the unit or damage of the electromagnetic contactor may occur. Consult your local distributor for details.
- When indoor units operate a fresh air intake, install a filter in the duct (field-supplied) to remove the dust from the air.
- The 4-way or 2-way Airflow Ceiling Cassette Type units that have an outside air inlet can be connected to the duct, but need a booster fan to be installed at site. Refer to the chapter "Indoor Unit" for the available range for fresh air intake volume.
- Operating fresh air intake on the indoor unit may increase the sound pressure level.

5-3. Precautions for Fresh air intake type indoor unit

5-3-1. Usage

- This unit mainly handles the outside air load, and is not designed to maintain the room temperature. Install other air conditioners for handling the air conditioning load in the room.

5-3-2. Unit characteristics

- This unit cannot perform the drying operation. The unit will continue the fan operation and blow fresh air (air that is not air-conditioned) when the Heating Thermo-OFF or Cooling Thermo-OFF mode is selected.
- The fan may stop tentatively when the unit is connected to the simultaneous cooling/heating operation type outdoor unit (R2, WR2 series) or during the defrost cycle.
- This unit switches the Thermo ON or OFF depending on the room temperature. The outside air is directly supplied into the room during Thermo OFF. Take caution of the cold supply air due to low outside air temperature and of condensation in the room due to high humidity of the outside air.
- Outside air temperature ranges for the operation must be as follows:
Cooling: 21°C D.B./15.5°C W.B. ~ 43°C D.B./35°C W.B.
Heating: -10°C D.B. ~ 20°C D.B.
The unit is forced to operate Thermo OFF (fan operation) when the outside air temperature is as follows.
Cooling: 21°C D.B. or below; Heating: 20°C D.B. or above
- Either a remote controller (sold separately) or a remote sensor (sold separately) must be installed to monitor the room temperature.
- If only this unit is used as an indoor unit, condensation may form at the supply air grill while the unit is operated in the cooling mode. This unit cannot operate dehumidifying.
- Use the unit in the way that the airflow rate will not exceed the 110% of the rated airflow.

5-4. Precautions for Outdoor unit/Heat source unit

5-4-1. Installation environment

- Outdoor unit with salt-resistant specification is recommended to use in a place where it is subject to salt air.
- Even when the unit with salt-resistant specification is used, it is not completely protected against corrosion. Be sure to follow the directions or precautions described in Instructions Book and Installation Manual for installation and maintenance. The salt-resistant specification is referred to the guidelines published by JRAIA (JRA9002).
- Install the unit in a place where the flow of discharge air is not obstructed. If not, the short-cycling of discharge air may occur.
- Provide proper drainage around the unit base, because the condensation may collect and drip from the outdoor units. Provide water-proof protection to the floor when installing the units on the rooftop.
- In a region where snowfall is expected, install the unit so that the outlet faces away from the direction of the wind, and install a snow guard to protect the unit from snow. Install the unit on a base approximately 50 cm higher than the expected snowfall. Close the openings for pipes and wiring, because the ingress of water and small animals may cause equipment damage. If SUS snow guard is used, refer to the Installation Manual that comes with the snow guard and take caution for the installation to avoid the risk of corrosion.
- When the unit is expected to operate continuously for a long period of time at outside air temperatures of below 0°C, take appropriate measures, such as the use of a unit base heater, to prevent icing on the unit base. (Not applicable to the PUMY series)
- Install the snow guard so that the outlet/inlet faces away from the direction of the wind.
- When the snow accumulates approximately 50 cm or more on the snow guard, remove the snow from the guard. Install a roof that is strong enough to withstand snow loads in a place where snow accumulates.
- Provide proper protection around the outdoor units in places such as schools to avoid the risk of injury.
- A cooling tower and heat source water circuit should be a closed circuit that water is not exposed to the atmosphere. When a tank is installed to ensure that the circuit has enough water, minimize the contact with outside air so that the oxygen from being dissolved in the water should be 1 mg/L or less.
- Install a strainer (50 mesh or more recommended) on the water pipe inlet on the heat source unit.
- Interlock the heat source unit and water circuit pump.
- Note the followings to prevent the freeze bursting of pipe when the heat source unit is installed in a place where the ambient temperature can be 0°C or below.
- Keep the water circulating to prevent it from freezing when the ambient temperature is 0°C or below.
- Before a long period of non use, be sure to purge the water out of the unit.
- Salt-resistant unit is resistant to salt corrosion, but not salt-proof.
Please note the following when installing and maintaining outdoor units in marine atmosphere.
 1. Install the salt-resistant unit out of direct exposure to sea breeze, and minimize the exposure to salt water mist.
 2. Avoid installing a sun shade over the outdoor unit, so that rain will wash away salt deposits off the unit.
 3. Install the unit horizontally to ensure proper water drainage from the base of the unit. Accumulation of water in the base of the outdoor unit will significantly accelerate corrosion.
 4. Periodically wash salt deposits off the unit, especially when the unit is installed in a coastal area.
 5. Repair all noticeable scratches after installation and during maintenance.
 6. Periodically check the unit, and apply anti-rust agent and replace corroded parts as necessary.

5-4-2. Circulating water

- ♦ Follow the guidelines published by JRAIA (JRA-GL02-1994) to check the water quality of the water in the heat source unit regularly.
- ♦ A cooling tower and heat source water circuit should be a closed circuit that water is not exposed to the atmosphere. When a tank is installed to ensure that the circuit has enough water, minimize the contact with outside air so that the oxygen from being dissolved in the water should be 1 mg/L or less.

5-4-3. Unit characteristics

- ♦ When the Thermo ON and OFF is frequently repeated on the indoor unit, the operation status of outdoor units may become unstable.

5-4-4. Relevant equipment

- ♦ Provide grounding in accordance with the local regulations.

5-5. Precautions for Control-related items**5-5-1. Product specification**

- ♦ To introduce the MELANS system, a consultation with us is required in advance. Especially to introduce the electricity charge apportioning function or energy-save function, further detailed consultation is required. Consult your local distributor for details.
- ♦ Billing calculation for AE-200E/AE-50E, AG-150A, GB-50ADA, TG-2000A, or the billing calculation unit is unique and based on our original method. (Backup operation is included.) It is not based on the metering method, and do not use it for official business purposes. It is not the method that the amount of electric power consumption (input) by air conditioner is calculated. Note that the electric power consumption by air conditioner is apportioned by using the ratio corresponding to the operation status (output) for each air conditioner (indoor unit) in this method.
- ♦ In the apportioned billing function for AE-200E/AE-50E, AG-150A and GB-50ADA, use separate watt-hour meters for A-control units, K-control units, and packaged air conditioner for City Multi air conditioners. It is recommended to use an individual watt-hour meter for the large-capacity indoor unit (with two or more addresses).
- ♦ When using the peak cut function on the AE-200E/AE-50E, AG-150A or GB-50ADA, note that the control is performed once every minute and it takes time to obtain the effect of the control. Take appropriate measures such as lowering the criterion value. Power consumption may exceed the limits if AE-200E/AE-50E, AG-150A or GB-50ADA malfunctions or stops. Provide a back-up remedy as necessary.
- ♦ The controllers cannot operate while the indoor unit is OFF. (No error)
Turn ON the power to the indoor unit when operating the controllers.
- ♦ When using the interlocked control function on the AE-200E/AE-50E, AG-150A, GB-50ADA, PAC-YG66DCA, or PAC-YG63MCA, do not use it for the control for the fire prevention or security. (This function should never be used in the way that would put people's lives at risk.) Provide any methods or circuit that allow ON/OFF operation using an external switch in case of failure.

5-5-2. Installation environment

- ♦ The surge protection for the transmission line may be required in areas where lightning strikes frequently occur.
- ♦ A receiver for a wireless remote controller may not work properly due to the effect of general lighting. Leave a space of at least 1 m between the general lighting and receiver.
- ♦ When the Auto-elevating panel is used and the operation is made by using a wired remote controller, install the wired remote controller to the place where all air conditioners controlled (at least the bottom part of them) can be seen from the wired remote controller. If not, the descending panel may cause damage or injury, and be sure to use a wireless remote controller designed for use with elevating panel (sold separately).
- ♦ Install the wired remote controller (switch box) to the place where the following conditions are met.
 - ♦ Where installation surface is flat
 - ♦ Where the remote controller can detect an accurate room temperature
The temperature sensors that detect a room temperature are installed both on the remote controller and indoor unit. When a room temperature is detected using the sensor on the remote controller, the main remote controller is used to detect a room temperature. In this case, follow the instructions below.
 - ♦ Install the controller in a place where it is not subject to the heat source.
(If the remote controller faces direct sunlight or supply air flow direction, the remote controller cannot detect an accurate room temperature.)
 - ♦ Install the controller in a place where an average room temperature can be detected.
 - ♦ Install the controller in a place where no other wires are present around the temperature sensor.
(If other wires are present, the remote controller cannot detect an accurate room temperature.)
- ♦ To prevent unauthorized access, always use a security device such as a VPN router when connecting AE-200E/AE-50E, AG-150A, GB-50ADA, or TG-2000A to the Internet.

The installer and/or air conditioning system specialist shall secure safety against refrigerant leakage according to local regulations or standards. The following standard may be applicable if no local regulation or standard is available.

6-1. Refrigerant property

R410A refrigerant is harmless and incombustible. The R410A is heavier than the indoor air in density. Leakage of the refrigerant in a room has possibility to lead to a hypoxia situation. Therefore, the Critical concentration specified below shall not be exceeded even if the leakage happens.

• Critical concentration

Critical concentration hereby is the refrigerant concentration in which no human body would be hurt if immediate measures can be taken when refrigerant leakage happens.

Critical concentration of R410A: 0.44kg/m³

(The weight of refrigeration gas per 1 m³ air conditioning space.);

* The Critical concentration is subject to ISO5149, EN378-1.

For the CITY MULTI system, the concentration of refrigerant leaked should not have a chance to exceed the Critical concentration in any situation.

6-2. Confirm the Critical concentration and take countermeasure

The maximum refrigerant leakage concentration (Rmax) is defined as the result of the possible maximum refrigerant weight (Wmax) leaked into a room divided by its room capacity (V). It is referable to Fig.6-1. The refrigerant of Outdoor unit here includes its original charge and additional charge at the site.

The additional charge is calculated according to "3-3. Refrigerant charging calculation" and shall not be over charged at the site.

Procedure 6-2-1~3 tells how to confirm maximum refrigerant leakage concentration (Rmax) and how to take countermeasures against a possible leakage.

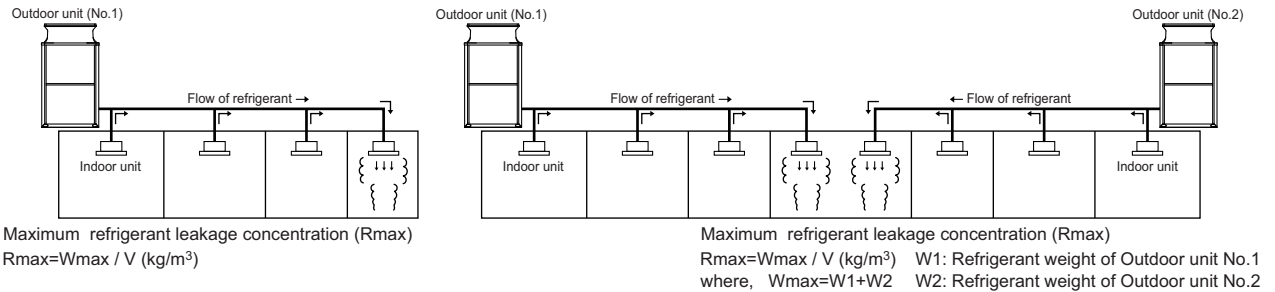

Fig. 6-1 The maximum refrigerant leakage concentration

6-2-1. Find the room capacity (V),

If a room having total opening area more than 0.15% of the floor area at a low position with another room/space, the two rooms/space are considered as one. The total space shall be added up.

6-2-2. Find the possible maximum leakage (Wmax) in the room. If a room has Indoor unit(s) from more than 1 Outdoor unit, add up the refrigerant of the Outdoor units.

6-2-3. Divide (Wmax) by (V) to get the maximum refrigerant leakage concentration (Rmax).

6-2-4. Find if there is any room in which the maximum refrigerant leakage concentration (Rmax) is over 0.44kg/m³.

If no, then the CITY MULTI is safe against refrigerant leakage.

If yes, following countermeasure is recommended to do at site.

Countermeasure 1: Let-out (making V bigger)

Design an opening of more than 0.15% of the floor area at a low position of the wall to let out the refrigerant whenever leaked.

e.g. make the upper and lower seams of door big enough.

Countermeasure 2: Smaller total charge (making Wmax smaller)

e.g. Avoid connecting more than 1 Outdoor unit to one room.

e.g. Using smaller model size but more Outdoor units.

e.g. Shorten the refrigerant piping as much as possible.

Countermeasure 3: Fresh air in from the ceiling (Ventilation)

As the density of the refrigerant is bigger than that of the air. Fresh air supply from the ceiling is better than air exhausting from the ceiling.

Fresh air supply solution refers to Fig.6-2~4.

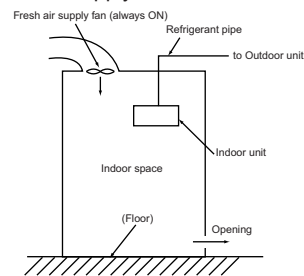

Fig.6-2. Fresh air supply always ON

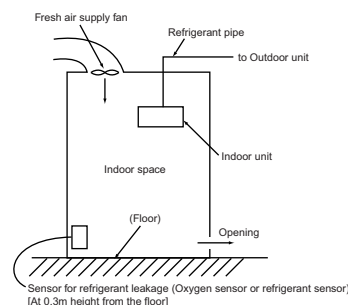

Fig.6-3. Fresh air supply upon sensor action

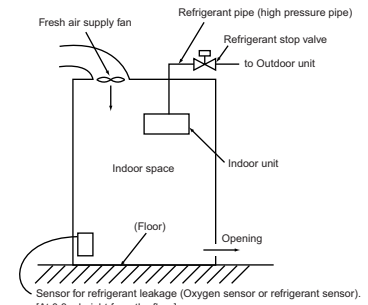

Fig.6-4. Fresh air supply and refrigerant shut-off upon sensor action

Note 1. Countermeasure 3 should be done in a proper way in which the fresh air supply shall be on whenever the leakage happens.

Note 2. In principle, MITSUBISHI ELECTRIC requires proper piping design, installation and air-tight testing after installation to avoid leakage happening.

In the area should earthquake happen, anti-vibration measures should be fully considered.

The piping should consider the extension due to the temperature variation.

CITY MULTI R410A series YKB/YLM

DATA BOOK



for a greener tomorrow

Eco Changes is the Mitsubishi Electric Group's environmental statement, and expresses the Group's stance on environmental management. Through a wide range of businesses, we are helping contribute to the realization of a sustainable society.

⚠ Warning

- Do not use refrigerant other than the type indicated in the manuals provided with the unit and on the nameplate.
 - Doing so may cause the unit or pipes to burst, or result in explosion or fire during use, during repair, or at the time of disposal of the unit.
 - It may also be in violation of applicable laws.
 - MITSUBISHI ELECTRIC CORPORATION cannot be held responsible for malfunctions or accidents resulting from the use of the wrong type of refrigerant.
- Our air-conditioning equipments and heat pumps contain a fluorinated greenhouse gas, R410A.

MITSUBISHI ELECTRIC CORPORATION

HEAD OFFICE: TOKYO BLDG., 2-7-3, MARUNOUCHI, CHIYODA-KU, TOKYO 100-8310, JAPAN
www.MitsubishiElectric.com