

## ECOPLUS 050.1 ÷ 165.2

### Water cooled water chillers



McQuay is participating in the Eurovent Certification Programme. Product are as listed in the Eurovent Directory of Certified Products and on the web site [www.eurovent-certification.com](http://www.eurovent-certification.com)





# Introduction

## Purpose of the manual

The manual allows the installer and the operator to perform correctly all the operations required for the installation and maintenance of the chiller without provoking any damages to the unit or to the qualified personnel.

Therefore the manual is essential to help qualified personnel that have to arrange the equipment to provide the correct installation in accordance with local codes and regulation.

## Inspection

When the equipment is received, all items on the bill of lading should be carefully checked to insure a complete shipment. All units should be carefully checked and all shipping damage should be reported to the carrier. The unit serial plate should be checked before unloading the unit to be sure that it agrees with the power supply available. Physical damage to unit after acceptance is not McQuay's responsibility.

## Responsibilities

McQuay Italia declines all present and future responsibilities referred to injuries to people and damage to things and unit, coming from operators negligence, the unrespected installation/maintenance data carrier in this manual, the lacking of the current regulations respect referred to the safety of the equipment and the qualified personnel.

## Servicing and maintenance

Servicing and maintenance of these unit must carried out by experienced personnel with specific training in refrigeration. Regular checking of safety devices should be carried out but routine maintenance should be carried out in line with the recommendations list in the main section.

The simple design of the refrigeration circuit minimizes potential problems during normal unit operation.

# Characteristics

## General description

McQuay water cooled ECOPLUS chillers are equipped with 1, 2 McQuay StarGate™ Frame 3200 single screw compressors. They are manufactured by McQuay to satisfy the requirements of the consultants and the end user. McQuay ECOPLUS units are designed to minimise energy costs while maximising the refrigeration capacities. Once again McQuay has developed a line of chillers unsurpassed in performance and quality that will meet the most stringent requirements of comfort cooling, ice storage and process applications.

McQuay's chiller design experience, combined with outstanding features makes the ECOPLUS chiller unmatched in the industry.

## Safety measures

The unit must be suitably clamped to the ground.

It is necessary to follow these cautions and warnings:

- The unit must be lifted only by using the proper tools able to support the weight of the unit.
- No admittance to unauthorized or unqualified personnel should be allowed.
- No operation on electrical components is allowed without having switched off electricity supply.
- No operation on electrical components is allowed without using insulated platforms; no water or moisture should be present.
- All the operation on refrigerant circuit and pressurised components are to be performed by qualified personnel only.
- Compressor substitution or oil addition must be performed by qualified personnel only.
- Avoid contamination of unrelated bodies into the water piping during the unit connection to the water system.
- It is necessary that a mechanical filter is fitted to the piping connected to the exchangers entry.

# Installation

Before any operation please check the instruction for use.

## Warning

Installation and maintenance are to be performed only by qualified personnel who are familiar with local codes and regulations, and who are experienced with this type of equipment. Must be avoided the installation of the unit in places that could be considered dangerous for maintenance operations.

## Receiving and Handling

Inspect the unit immediately after receipt for possible damage. The unit is shipped ex-factory and all claims for handling and shipping damage are the responsibility of the consignee. Leave the shipping skid in place until the unit is in final position. This will aid in handling the equipment. Use extreme care when rigging the equipment to prevent damage to the control center, or refrigerant piping. See Dimensional Data for the center of gravity of the unit.

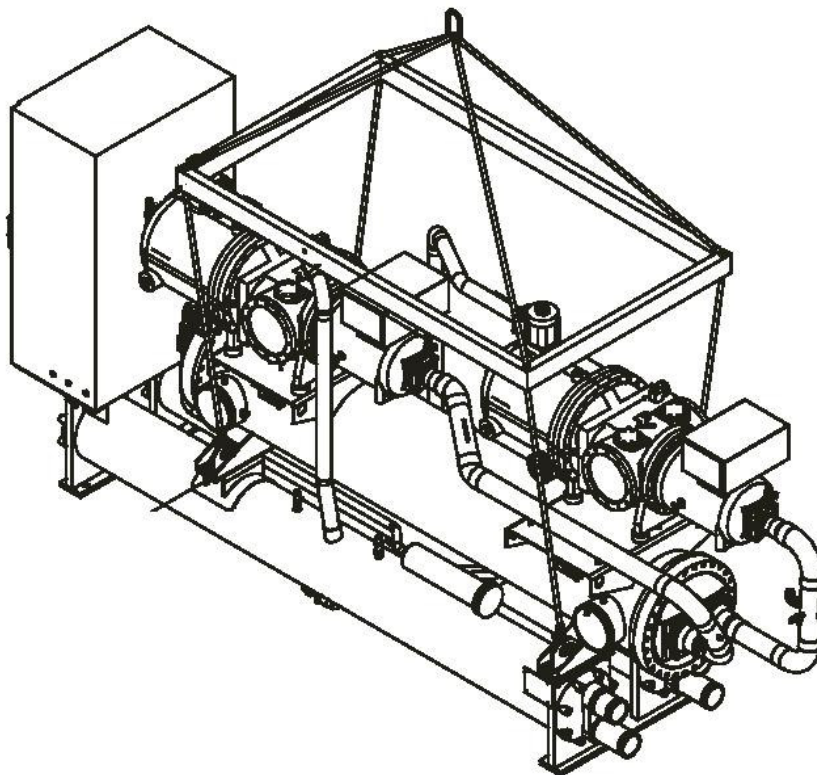

**Figure 1: Lifting the unit**

Perform all moving and handling with skids or dollies under the unit when possible, and do not remove them until the unit is in the final location.

In moving, always apply pressure to the base on the skids only and not to the piping or other components. A long bar will help move the unit. Do not drop the unit at the end of the roll.

Do not attach slings to piping or equipment. Do not attempt to lift the unit by lifting points mounted on the compressors. They are for lifting only the compressor should one need to be removed from the unit. Move unit in the upright horizontal position at all times. Set unit down gently when lowering from the truck or rollers.

## Location

A levelled and sufficiently strong floor is required. If necessary, additional structural members should be provided to transfer the weight of the unit to the nearest beams.

Rubber-in-shear isolators can be furnished and field placed under each corner of the package. A rubber anti-skid pad should be used under isolators if hold-down bolts are not used.

Vibration isolator in all water piping connected to the chiller are recommended to avoid straining the piping and transmitting vibration and noise.

## Compressor Condensation

Condensation occurs on the compressor surface when the temperature of the compressor surface is lower than the ambient dew point temperature. Drain pans with drain connections are provided underneath each compressor to collect the condensate. The compressor motor housing extends past the drain pans. Install a floor drain close to the unit to collect condensate from motor housing and condensate pans.

## Water treatment

If unit is operating with a cooling tower, clean and flush cooling tower. Make sure tower "blowdown" or bleedoff is operating. Atmospheric air contains many contaminants which increases the need for water treatment. The use of untreated water may result in corrosion, erosion, sliming, scaling, or algae formation. A water treatment service is recommended. McQuay International is not responsible for damage or faulty operation from untreated or improperly treated water.

## Head pressure control, tower system

The minimum entering water temperature to the condenser must not be lower than 15 °C at full tower water flow. If lower temperature water is used, the flow must be reduced proportionally. Use a three-way bypass valve around the tower to modulate the condenser water flow. Figure 1 shows a three-way pressure actuator water regulating valve used for cooling applications. This regulating valve will assure an adequate condensing pressure if the inlet condenser water temperature falls below 15 °C.

## Head Pressure Control, Well Water System

When using city or well water for condensing refrigerant, install a normally closed direct acting water regulating valve in the outlet piping of the condenser. This regulating valve will assure an adequate condensing pressure if the inlet condenser water temperature falls below 15 °C. The condenser service valve provides a pressure tap for the regulating valve. The valve can modulate in response to head pressure. On shutdown, the valve closes, preventing water from siphoning out of the condenser. Siphoning causes condenser waterside drying and accelerates fouling. If a valve is not used, Figure 2 illustrates the recommendation of a loop at the outlet. Size the loop height (H) to offset the negative pressure caused by the siphoning effect. A vacuum breaker may be required.

Figure 2, Bypass valve

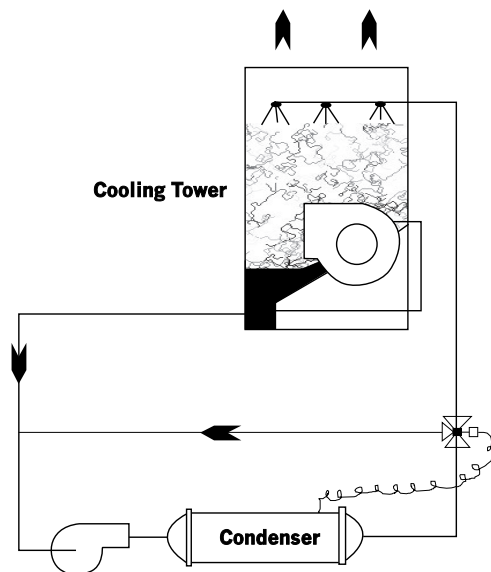
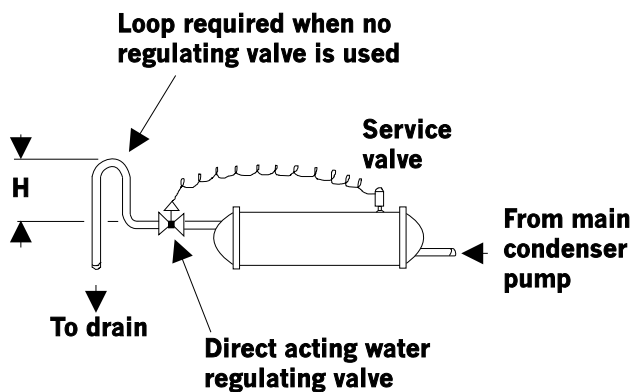

Figure 3, Well Water System



## Temperature and Water Flow Limitations

ECOPLUS units are designed to operate in conditions from -8 °C to +15 °C leaving water temperature on the evaporator side and +15 °C to +55 °C entering water temperature on the condenser side. Glycol in the evaporator is required on all applications below +4 °C leaving evaporator fluid temperature. The maximum allowable water temperature to the cooler in a non-operating cycle is 40 °C. The non-operating leaving condenser water temperature maximum is 46°C. Flow rates below the minimum values shown in the evaporator and condenser pressure drop curves may cause freeze-up problems, scaling and poor control. Flow rates above the maximum values shown in the evaporator and condenser pressure drop curves will result in unacceptable pressure drops, excessive nozzle and tube erosion and possibly cause tube failure.

## Evaporator Freeze Protection

When freeze protection is a concern, do the following:

- If the unit will not be operated during the winter, drain and flush the evaporator and chilled water piping with glycol. Drain and vent connections are provided on the evaporator.
- When using a cooling tower, add glycol solution to the chilled water system. Freeze point should be approximately 6°C below minimum design ambient temperature.
- Insulate field water piping, especially on the chilled water side.

**Note:** Freeze damage is not considered a warranty failure and is not the responsibility of McQuay International.

## Water piping

Due to the variety of piping practices, it is advisable to follow the recommendations of local authorities. They can supply the installer with the proper building and safety codes required for a safe and proper installation.

Basically, the piping should be designed with a minimum number of bends and changes in elevation to keep system cost down and performance up. It should contain:

1. Vibration eliminators to reduce vibration and noise transmission to the building.
2. Shutoff valves to isolate the unit from the piping system during unit servicing.
3. Manual or automatic air vent valves at the high points of the system. Drains at the low parts in the system. The evaporator should not be the highest point in the piping system.
4. Some means of maintaining adequate system water pressure (e.g., expansion tank or regulating valve).
5. Water temperature and pressure indicators located at the unit to aid in unit servicing.
6. A strainer or some means of removing foreign matter from the water before it enters the pump. The strainer should be placed far enough upstream to prevent cavitation at the pump inlet (consult pump manufacturer for recommendations). The use of a strainer will prolong pump life and help maintain high system performance levels.
7. A strainer should also be placed in the supply water line just prior to the inlet of the evaporator. This will aid in preventing foreign material from entering and decreasing the performance of the evaporator.
8. The shell-and-tube evaporator has a thermostat and heating cable to prevent freeze-up down to -28°C. Any water piping to the unit must also be protected to prevent freezing.
9. If the unit is used as a replacement chiller on a previously existing piping system, the system should be thoroughly flushed prior to unit installation and then regular chilled water analysis and chemical water treatment is recommended immediately at equipment start-up.
10. In the event glycol is added to the water system, as an afterthought for freeze protection, recognize that the refrigerant suction pressure will be lower, cooling performance less, and water side pressure drop greater. System safety devices such as freeze protection and low pressure protection must be reset.

Prior to insulating the piping and filling the system, a preliminary leak check should be made.

## Chilled Water Thermostat

The ECOPLUS water-cooled chiller is equipped with the MicroTech II leaving water controller. Be careful when working around the unit to avoid damaging lead wires and sensor cables. Check lead wires before running the unit. Avoid rubbing the lead wires on the frame or other components. Verify the lead wires are firmly anchored. If the sensor is removed from the well for servicing, do not wipe off the heat conducting compound supplied in the well.

## Refrigerant Charge

All units are designed for use with HFC-134a and are shipped with a full operating charge. The operating charge for each unit is shown in the Physical Data Table.

## Flow Switch

A water flow switch must be mounted in either the entering or leaving water line to insure that there will be adequate water flow to the evaporator before the unit can start. This will safeguard against slugging the compressors on start-up. It also serves to shut down the unit in the event that water flow is interrupted to guard against evaporator freeze-up. A flow switch is available from McQuay and it is a "paddle" type switch and adaptable to any pipe size from 1" (25mm) to 8" (203mm) nominal.

Certain minimum flow rates are required to close the switch and are listed in Table 1.

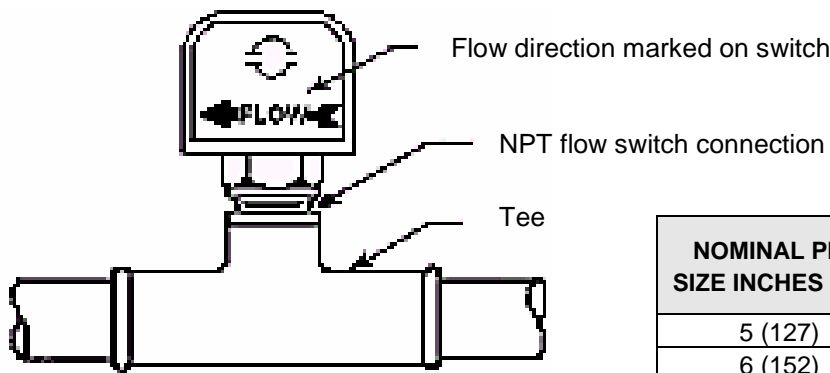

Figure 4 – Flow Switch

NOMINAL PIPE SIZE INCHES (MM)	MINIMUM REQUIRED FLOW TO ACTIVATE SWITCH – LITERS PER SECONDS
5 (127)	3.7
6 (152)	5.0
8 (203)	8.8

Table 1

## Glycol Solutions

Use industrial grade glycols only. Do not use an automotive grade antifreeze. Automotive antifreeze contains inhibitors that will cause plating on the copper tubes within the chiller evaporator. The type and handling of glycol used must be consistent with local codes.

## Evaporator and Condenser Water Flow and Pressure Drop

Flow rates must fall between the minimum and maximum values shown on the appropriate evaporator and condenser curves. Flow rates below the minimum values shown will result in laminar flow that will reduce efficiency, cause erratic operation of the electronic expansion valve and could cause low temperature cutouts. Flow rates exceeding the maximum values shown can cause erosion on the evaporator water connections and tubes. Measure the chilled water pressure drop through the evaporator at field installed pressure taps. It is important not to include the effect of valves or strainers in these readings. Do not vary the water flow through the evaporator while the compressor(s) are operating. MicroTech II control setpoints are based on constant flow.

## Operating limits

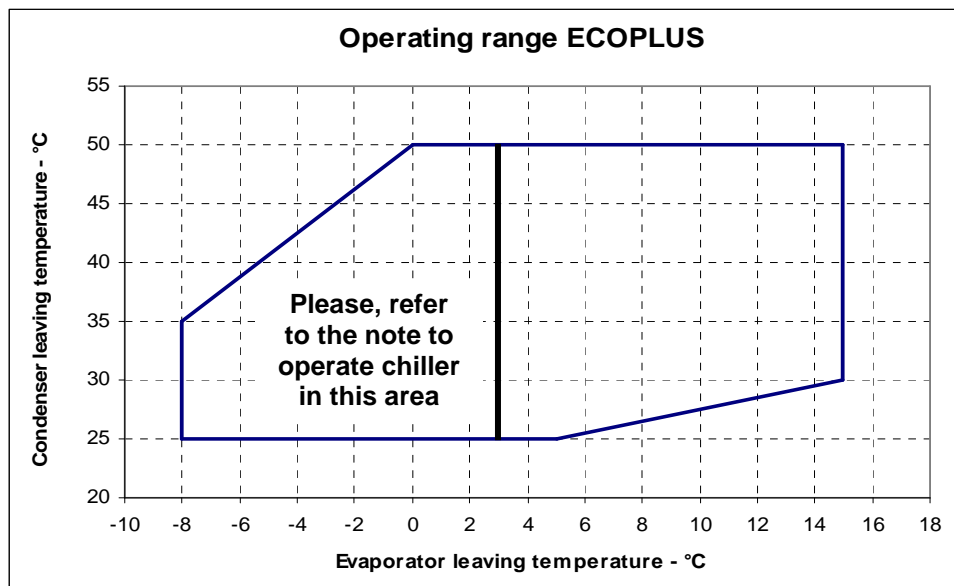

**Note:** the use of glycol is necessary for evaporator leaving water temperature below +3°C



## Physical data ECOPLUS SE with HFC 134a

ECOPLUS unit size		050.1	060.1	073.1	080.1	100.2
Cooling capacity (1)	kW	165,5	201,2	252,8	280,4	333,9
Power input (1)	kW	42,1	50,7	64,9	75,4	84,3
McQuay Stargate™ Screw compressor	N.	1	1	1	1	2
Refrigerant circuits	N.	1	1	1	1	2
Refrigerant charge HFC 134a	kg	50	50	50	50	100
Min % of capacity reduction	%	25	25	25	25	12,5

### Evaporator

Evaporators / water volume	N./l	1 / 60	1 / 56	1 / 123	1 / 123	1 / 118
Max operating pressure	bar	10,5	10,5	10,5	10,5	10,5

### Condenser

Condensers / water volume	N./l	1 / 13	1 / 15	1 / 15	1 / 15	2 / 26
Max operating pressure	bar	10,5	10,5	10,5	10,5	10,5

### Weight and dimensions

Standard unit shipping weight	kg	1393	1410	1503	1503	2687
Standard unit operating weight	kg	1470	1480	1650	1650	2840
Unit length	mm	3435	3435	3435	3435	4305
Unit width	mm	920	920	920	920	860
Unit height	mm	1860	1860	1860	1860	1880

Note: (1) Nominal cooling capacity and power input are based on: 12/7 °C entering/leaving evaporator water temperature; 30/35 °C entering/leaving condenser water temperature.

## Physical data ECOPLUS SE with HFC 134a

ECOPLUS unit size		110.2	120.2	133.2	146.2	165.2
Cooling capacity (1)	kW	372,2	402,5	448,3	493,7	555,7
Power input (1)	kW	93,1	101,4	115,1	129,0	150,2
McQuay Stargate™ Screw compressor	N.	2	2	2	2	2
Refrigerant circuits	N.	2	2	2	2	2
Refrigerant charge HFC 134a	kg	100	100	100	100	100
Min % of capacity reduction	%	12,5	12,5	12,5	12,5	12,5

### Evaporator

Evaporators / water volume	N./l	1 / 113	1 / 113	1 / 173	1 / 168	1 / 168
Max operating pressure	bar	10,5	10,5	10,5	10,5	10,5

### Condenser

Condensers / water volume	N./l	2 / 28	2 / 30	2 / 30	2 / 30	2 / 30
Max operating pressure	bar	10,5	10,5	10,5	10,5	10,5

### Weight and dimensions

Standard unit shipping weight	kg	2697	2702	2757	2762	2762
Standard unit operating weight	kg	2850	2860	2970	2970	2970
Unit length	mm	4305	4305	4305	4305	4305
Unit width	mm	860	860	860	860	860
Unit height	mm	1880	1880	1880	1880	1880

Note: (1) Nominal cooling capacity and power input are based on: 12/7 °C entering/leaving evaporator water temperature; 30/35 °C entering/leaving condenser water temperature.

## Physical data ECOPLUS XE with HFC 134a

<b>ECOPLUS unit size</b>		<b>050.1</b>	<b>060.1</b>	<b>073.1</b>	<b>080.1</b>	<b>100.2</b>
<b>Cooling capacity (1)</b>	<b>kW</b>	186,4	223,3	276,5	306,7	366,3
<b>Power input (1)</b>	<b>kW</b>	39,7	48,1	59,3	71,4	79,3
<b>McQuay Stargate™ Screw compressor</b>	<b>N.</b>	1	1	1	1	2
<b>Refrigerant circuits</b>	<b>N.</b>	1	1	1	1	2
<b>Refrigerant charge HFC 134a</b>	<b>kg</b>	50	50	50	50	100
<b>Min % of capacity reduction</b>	<b>%</b>	25	25	25	25	12,5

### Evaporator

<b>Evaporators / water volume</b>	<b>N./l</b>	1 / 125	1 / 120	1 / 110	1 / 110	1 / 170
<b>Max operating pressure</b>	<b>bar</b>	10,5	10,5	10,5	10,5	10,5

### Condenser

<b>Condensers / water volume</b>	<b>N./l</b>	1 / 22	1 / 25	1 / 25	1 / 25	2 / 44
<b>Max operating pressure</b>	<b>bar</b>	10,5	10,5	10,5	10,5	10,5

### Weight and dimensions

<b>Standard unit shipping weight</b>	<b>kg</b>	1650	1665	1680	1680	2800
<b>Standard unit operating weight</b>	<b>kg</b>	1800	1810	1820	1820	3020
<b>Unit length</b>	<b>mm</b>	3435	3435	3435	3435	4305
<b>Unit width</b>	<b>mm</b>	920	920	920	920	860
<b>Unit height</b>	<b>mm</b>	1860	1860	1860	1860	1880

**Note:** (1) Nominal cooling capacity and power input are based on: 12/7 °C entering/leaving evaporator water temperature; 30/35 °C entering/leaving condenser water temperature.

## Physical data ECOPLUS XE with HFC 134a

<b>ECOPLUS unit size</b>		<b>110.2</b>	<b>120.2</b>	<b>133.2</b>	<b>146.2</b>	<b>165.2</b>
<b>Cooling capacity (1)</b>	<b>kW</b>	408,2	443,6	496,0	540,5	603,9
<b>Power input (1)</b>	<b>kW</b>	87,2	95,0	104,8	114,4	137,7
<b>McQuay Stargate™ Screw compressor</b>	<b>N.</b>	2	2	2	2	2
<b>Refrigerant circuits</b>	<b>N.</b>	2	2	2	2	2
<b>Refrigerant charge HFC 134a</b>	<b>kg</b>	100	100	100	100	100
<b>Min % of capacity reduction</b>	<b>%</b>	12,5	12,5	12,5	12,5	12,5

### Evaporator

<b>Evaporators / water volume</b>	<b>N./l</b>	1 / 285	1 / 285	1 / 280	1 / 280	1 / 280
<b>Max operating pressure</b>	<b>bar</b>	10,5	10,5	10,5	10,5	10,5

### Condenser

<b>Condensers / water volume</b>	<b>N./l</b>	2 / 47	2 / 50	2 / 59	2 / 68	2 / 68
<b>Max operating pressure</b>	<b>bar</b>	10,5	10,5	10,5	10,5	10,5

### Weight and dimensions

<b>Standard unit shipping weight</b>	<b>kg</b>	2945	2955	2975	2990	2990
<b>Standard unit operating weight</b>	<b>kg</b>	3280	3290	3315	3340	3340
<b>Unit length</b>	<b>mm</b>	4305	4305	4305	4305	4305
<b>Unit width</b>	<b>mm</b>	860	860	860	860	860
<b>Unit height</b>	<b>mm</b>	1880	1880	1880	1880	1880

**Note:** (1) Nominal cooling capacity and power input are based on: 12/7 °C entering/leaving evaporator water temperature; 30/35 °C entering/leaving condenser water temperature.

## Electrical data ECOPLUS SE with HFC 134a

ECOPLUS unit size		050.1	060.1	073.1	080.1	100.2
Standard voltage (1)		400 V - 3f - 50 Hz				
Nominal unit current (2)	A	81	92	111	131	163
Max unit current (3)	A	112	133	164	174	225
Max unit inrush current (4)	A	288	288	288	288	349
Max unit current for wires sizing (5)	A	124	147	165	190	248

ECOPLUS unit size		110.2	120.2	133.2	146.2	165.2
Standard voltage (1)		400 V - 3f - 50 Hz				
Nominal unit current (2)	A	174	184	202	221	260
Max unit current (3)	A	246	266	299	329	345
Max unit inrush current (4)	A	353	357	366	371	439
Max unit current for wires sizing (5)	A	271	294	312	330	380

- Note:**
- (1) Allowed voltage tolerance  $\pm 10\%$ . Voltage unbalance between phases must be within  $\pm 3\%$ .
  - (2) Absorbed current referred to nominal condition: 12/7 °C entering/leaving evaporator water temperature; 30/35 °C entering/leaving condenser water temperature.
  - (3) Absorbed current referred to the following conditions: 14/9 °C entering/leaving evaporator water temperature; 45/50°C entering/leaving condenser water temperature.
  - (4) Inrush compressor's current for unit with one compressor OR 75% of nominal absorbed current of compressor n°1 + inrush current of last compressor (n°2).
  - (5) Compressor FLA (Full Load Ampere).

## Electrical data ECOPLUS XE with HFC 134a

ECOPLUS unit size		050.1	060.1	073.1	080.1	100.2
Standard voltage (1)		400 V - 3f - 50 Hz				
Nominal unit current (2)	A	79	89	103	124	157
Max unit current (3)	A	108	128	154	162	215
Max unit inrush current (4)	A	288	288	288	288	347
Max unit current for wires sizing (5)	A	124	147	165	190	248

ECOPLUS unit size		110.2	120.2	133.2	146.2	165.2
Standard voltage (1)		400 V - 3f - 50 Hz				
Nominal unit current (2)	A	167	175	188	201	238
Max unit current (3)	A	234	253	276	299	313
Max unit inrush current (4)	A	351	354	359	363	430
Max unit current for wires sizing (5)	A	271	294	312	330	380

- Note:**
- (1) Allowed voltage tolerance  $\pm 10\%$ . Voltage unbalance between phases must be within  $\pm 3\%$ .
  - (2) Absorbed current referred to nominal condition: 12/7 °C entering/leaving evaporator water temperature; 30/35 °C entering/leaving condenser water temperature.
  - (3) Absorbed current referred to the following conditions: 14/9 °C entering/leaving evaporator water temperature; 45/50°C entering/leaving condenser water temperature.
  - (4) Inrush compressor's current for unit with one compressor OR 75% of nominal absorbed current of compressor n°1+ inrush current of last compressor (n°2).
  - (5) Compressor FLA (Full Load Ampere).

# Evaporator pressure drop ECOPLUS SE/XE 050.1 ÷ 165.2

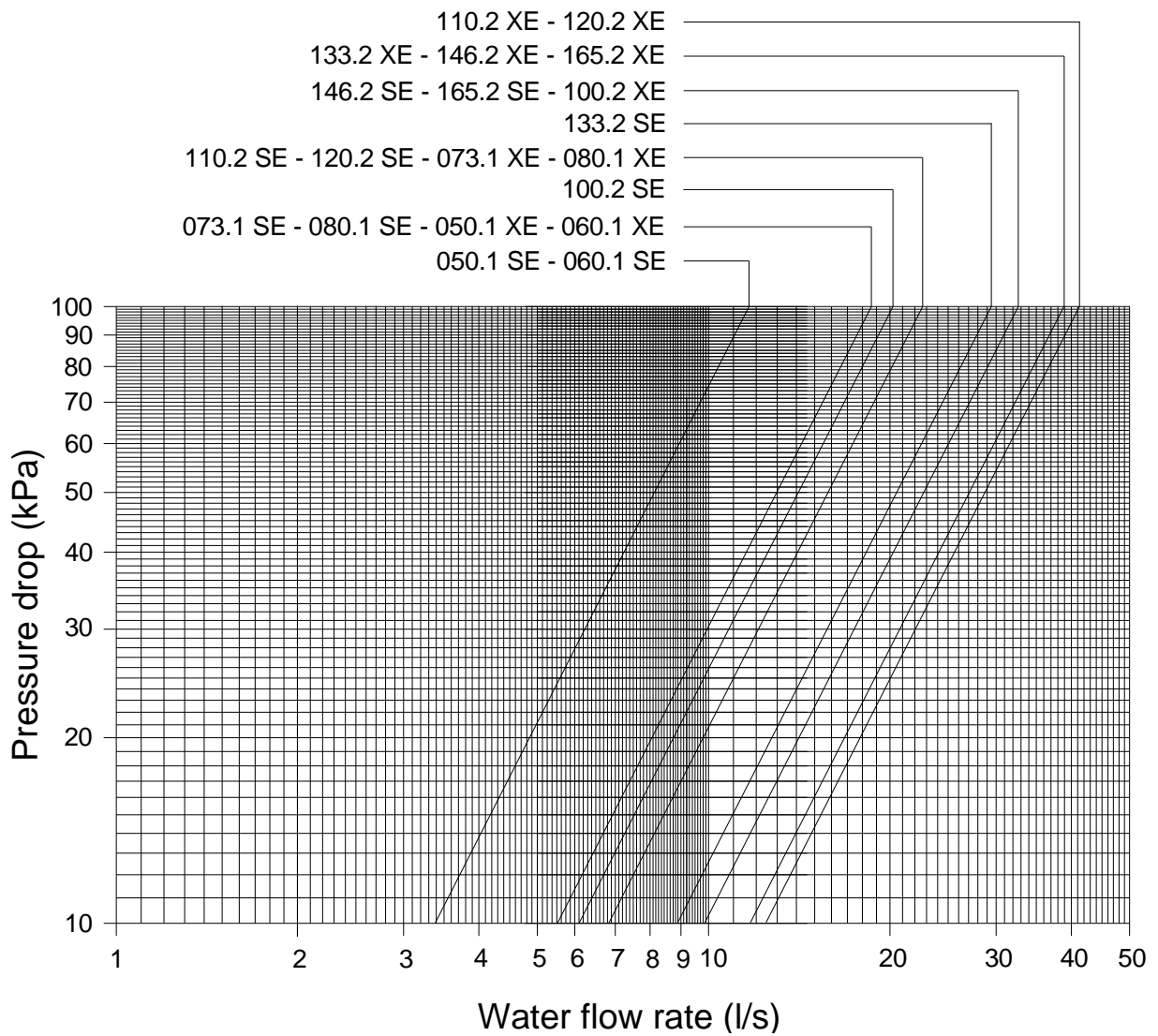

# Condenser pressure drop ECOPLUS SE/XE 050.1 ÷ 165.2

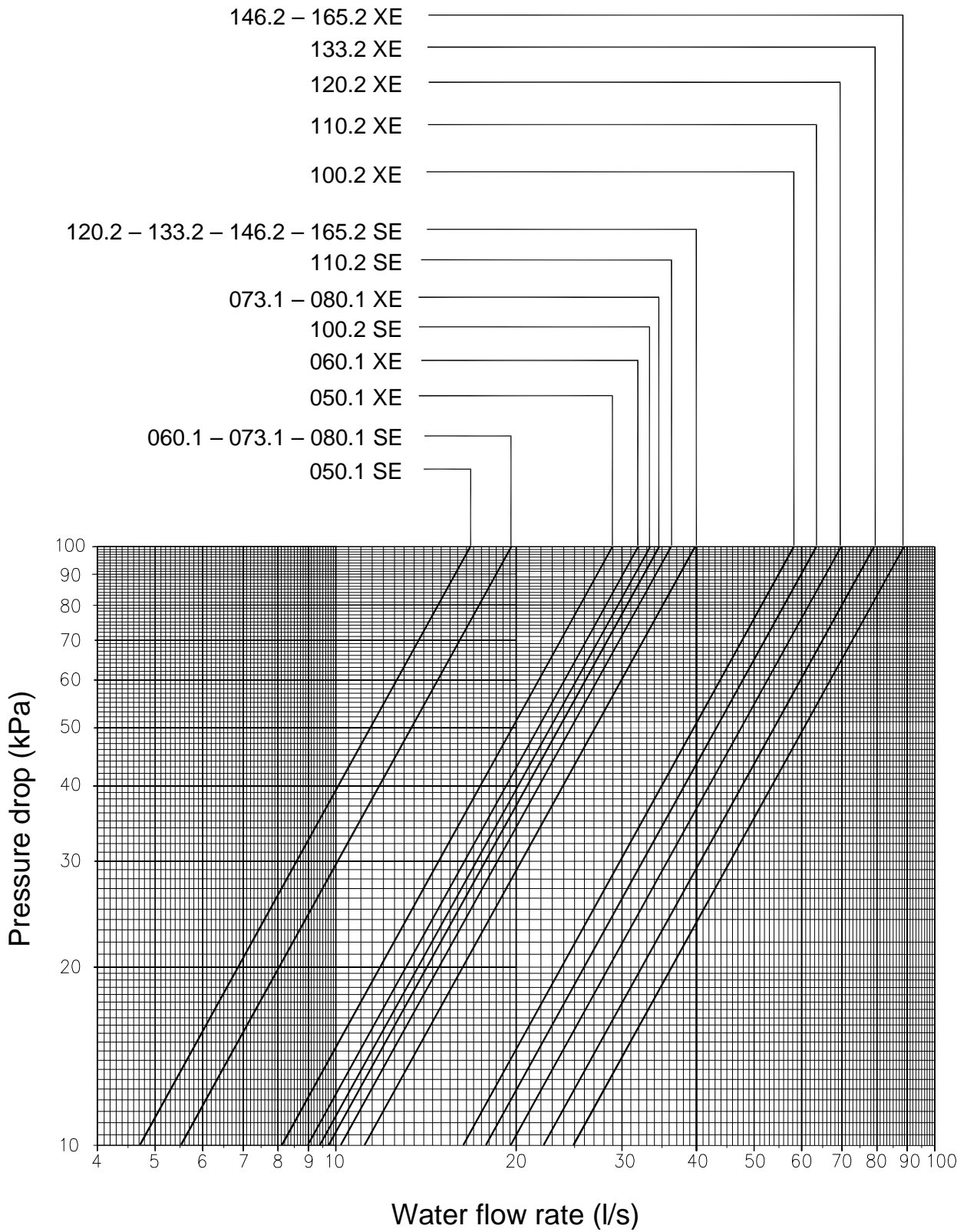

## Partial heat recovery ratings ECOPLUS 050.1 ÷ 165.2

Unit	Leaving desuper-heaters water temperature °C	Entering condenser water temperature °C				
		30	35	40	45	50
		Heating capacity	Heating capacity	Heating capacity	Heating capacity	Heating capacity
		(kW)	(kW)	(kW)	(kW)	(kW)
050.1	45	21	22	23	24	25
	50	10	18	22	23	24
	55	6	11	17	20	21
060.1	45	22	29	30	31	32
	50	17	23	28	29	30
	55	10	16	24	26	27
073.1	45	35	36	37	38	39
	50	28	34	35	36	37
	55	19	30	31	32	33
080.1	45	48	43	44	45	46
	50	39	45	42	43	44
	55	28	44	38	38	39
100.2	45	42	44	46	48	50
	50	20	36	44	46	48
	55	12	22	34	40	42
110.2	45	43	51	53	55	57
	50	27	41	50	52	54
	55	16	27	41	46	48
120.2	45	44	58	60	62	64
	50	34	46	56	58	60
	55	20	32	48	52	54
133.2	45	57	65	67	69	71
	50	45	57	63	65	67
	55	29	46	55	58	60
146.2	45	70	72	74	76	78
	50	56	68	70	72	74
	55	38	60	62	64	66
165.2	45	96	86	88	90	92
	50	78	90	84	86	88
	55	56	88	76	76	78

**Note:** (1) Leaving evaporator water temperature 7°C -  $\Delta T$  5°C;  $\Delta T$  condenser water temperature 5°C.

### Heating capacity correction factors for different evaporator leaving water temp.

Evaporator leaving water temp.	9	8	7	6	5	4
Heating capacity correction factor	1,062	1,029	1,000	0,973	0,941	0,914

# Partial heat recovery pressure drop ECOPLUS SE/XE 050.1 ÷ 165.2

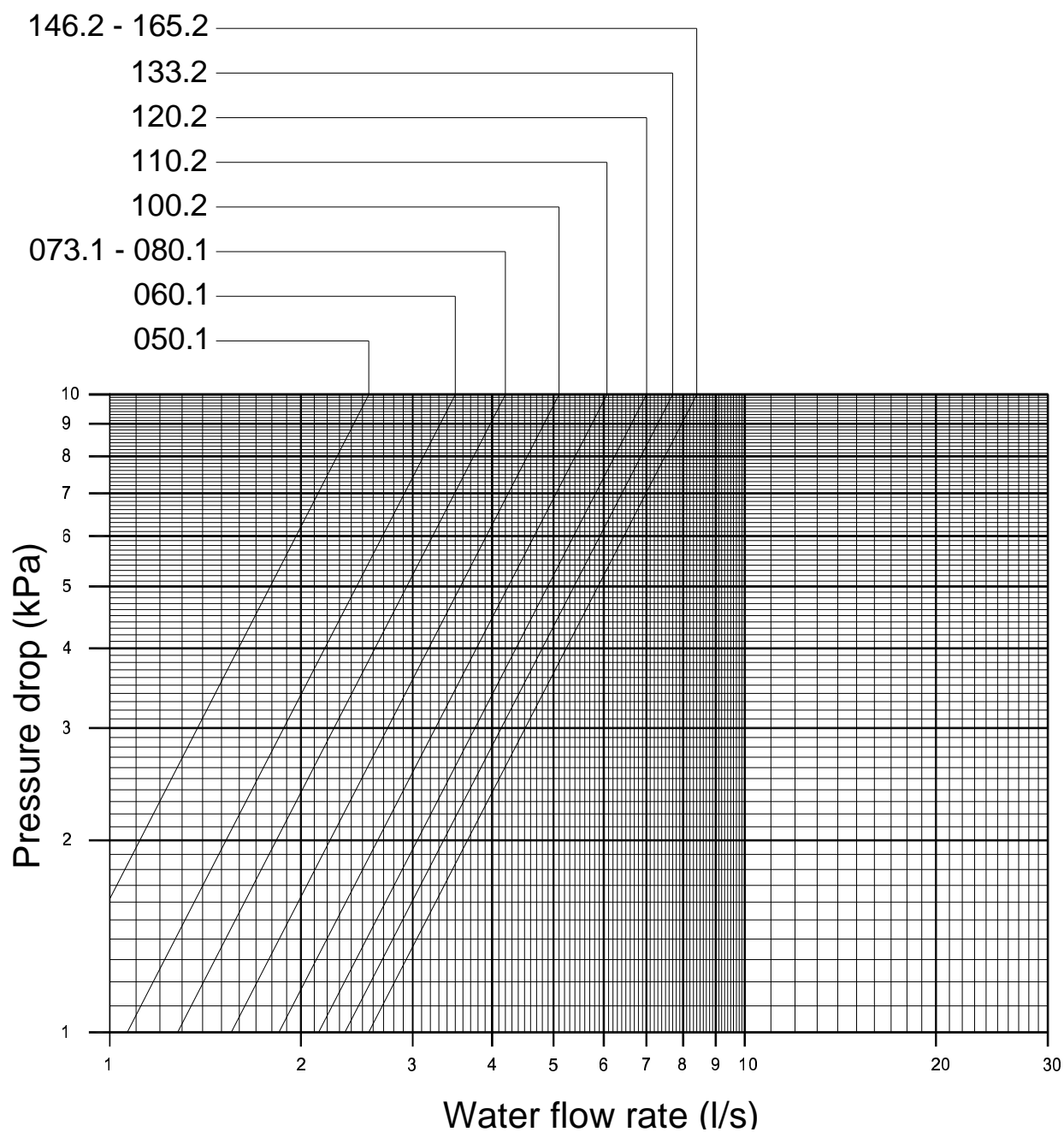

## Total heat recovery ratings – ECOPLUS SE 050.1 ÷ 100.2

ECOPLUS Unit size	Evaporator Leaving Water Temperature (°C)	Heat recovery leaving water temperature - °C											
		35			40			45			50		
		Cooling Cap.ty [kW]	Power Input [kW]	Total Heat [kW]	Cooling Cap.ty [kW]	Power Input [kW]	Total Heat [kW]	Cooling Cap.ty [kW]	Power Input [kW]	Total Heat [kW]	Cooling Cap.ty [kW]	Power Input [kW]	Total Heat [kW]
050.1	4	151,6	37,5	189,1	145,2	42,3	187,5	138,6	47,5	186,1	131,7	53,1	184,8
	5	156,4	37,7	194,1	149,9	42,5	192,4	143,2	47,6	190,8	136,1	53,3	189,4
	6	161,4	37,8	199,2	154,7	42,6	197,3	147,8	47,8	195,6	140,7	53,5	194,2
	7	166,4	38,0	204,4	159,6	42,8	202,4	152,6	48,0	200,6	145,3	53,7	199,0
	8	171,5	38,1	209,6	164,6	43,0	207,6	157,4	48,2	205,6	150,0	53,9	203,9
	9	176,7	38,3	215,0	169,7	43,2	212,9	162,4	48,5	210,9	154,8	54,1	208,9
060.1	4	184,5	45,0	229,5	176,8	50,8	227,6	168,7	57,0	225,7	160,2	63,7	223,9
	5	190,4	45,2	235,6	182,5	51,0	233,5	174,3	57,2	231,5	165,6	64,0	229,6
	6	196,4	45,4	241,8	188,4	51,2	239,6	180,0	57,5	237,5	171,2	64,2	235,4
	7	202,5	45,6	248,1	194,3	51,4	245,7	185,8	57,7	243,5	176,8	64,5	241,3
	8	208,7	45,8	254,5	200,4	51,7	252,1	191,7	58,0	249,7	182,5	64,7	247,2
	9	215,0	46,0	261,0	206,5	51,9	258,4	197,7	58,2	255,9	188,3	65,0	253,3
073.1	4	234,2	55,9	290,1	224,2	63,0	287,2	213,7	70,6	284,3	202,7	78,8	281,5
	5	241,8	56,2	298,0	231,6	63,3	294,9	220,9	70,9	291,8	209,6	79,1	288,7
	6	249,6	56,5	306,1	239,1	63,6	302,7	228,2	71,3	299,5	216,7	79,5	296,2
	7	257,5	56,8	314,3	246,8	63,9	310,7	235,7	71,6	307,3	223,9	79,9	303,8
	8	265,5	57,0	322,5	254,6	64,3	318,9	243,3	72,0	315,3	231,3	80,3	311,6
	9	273,7	57,3	331,0	262,6	64,6	327,2	251,0	72,4	323,4	238,8	80,7	319,5
080.1	4	269,9	65,4	335,3	257,4	71,1	328,5	245,2	77,7	322,9	232,4	85,1	317,5
	5	279,0	66,3	345,3	266,3	72,0	338,3	253,3	78,5	331,8	240,3	85,9	326,2
	6	288,4	67,3	355,7	275,4	72,9	348,3	261,8	79,4	341,2	248,5	86,7	335,2
	7	297,9	68,3	366,2	284,6	73,9	358,5	270,8	80,3	351,1	256,6	87,5	344,1
	8	307,5	69,3	376,8	294,0	74,9	368,9	280,0	81,2	361,2	265,3	88,4	353,7
	9	317,3	70,3	387,6	303,7	75,9	379,6	289,2	82,2	371,4	274,2	89,3	363,5
100.2	4	305,9	75,1	381,0	292,9	84,7	377,6	279,5	95,0	374,5	265,5	106,2	371,7
	5	315,7	75,4	391,1	302,5	85,0	387,5	288,8	95,4	384,2	274,5	106,6	381,1
	6	325,7	75,7	401,4	312,2	85,4	397,6	298,2	95,8	394,0	283,7	107,1	390,8
	7	335,9	76,0	411,9	322,2	85,7	407,9	307,9	96,2	404,1	293,1	107,5	400,6
	8	346,3	76,3	422,6	332,3	86,1	418,4	317,7	96,6	414,3	302,6	107,9	410,5
	9	356,8	76,6	433,4	342,5	86,5	429,0	327,7	97,0	424,7	312,4	108,4	420,8

**Note:** Values are based on  $\Delta T=5^{\circ}\text{C}$  entering/leaving condenser water temperature;  $\Delta T=5^{\circ}\text{C}$  entering/leaving evaporator water temperature and with evaporator fouling factor=0,0176  $\text{m}^2\text{/kW}$ , condenser fouling factor=0,0440  $\text{m}^2\text{/kW}$ .



## Total heat recovery ratings – ECOPLUS SE 110.2 ÷ 165.2

ECOPLUS Unit size	Evaporator Leaving Water Temperature (°C)	Heat recovery leaving water temperature - °C											
		35			40			45			50		
		Cooling Cap.ty [kW]	Power Input [kW]	Total Heat [kW]	Cooling Cap.ty [kW]	Power Input [kW]	Total Heat [kW]	Cooling Cap.ty [kW]	Power Input [kW]	Total Heat [kW]	Cooling Cap.ty [kW]	Power Input [kW]	Total Heat [kW]
110.2	4	341,2	82,7	423,9	326,7	93,2	419,9	311,7	104,6	416,3	295,9	117,0	412,9
	5	352,2	83,1	435,3	337,5	93,6	431,1	322,1	105,1	427,2	306,0	117,4	423,4
	6	363,4	83,4	446,8	348,4	94,1	442,5	332,7	105,5	438,2	316,3	117,9	434,2
	7	374,8	83,8	458,6	359,5	94,5	454,0	343,5	106,0	449,5	326,8	118,4	445,2
	8	386,5	84,1	470,6	370,8	94,9	465,7	354,5	106,4	460,9	337,5	118,9	456,4
	9	398,3	84,4	482,7	382,3	95,3	477,6	365,7	106,9	472,6	348,4	119,4	467,8
120.2	4	369,2	90,1	459,3	353,8	101,6	455,4	337,6	114,0	451,6	320,6	127,5	448,1
	5	381,0	90,5	471,5	365,2	102,0	467,2	348,8	114,5	463,3	331,4	127,9	459,3
	6	393,0	90,8	483,8	376,9	102,4	479,3	360,2	115,0	475,2	342,5	128,4	470,9
	7	405,2	91,2	496,4	388,8	102,9	491,7	371,7	115,4	487,1	353,7	129,0	482,7
	8	417,6	91,6	509,2	400,9	103,3	504,2	383,5	115,9	499,4	365,2	129,5	494,7
	9	430,2	92,0	522,2	413,2	103,8	517,0	395,5	116,4	511,9	376,9	130,0	506,9
133.2	4	413,3	100,7	514,0	395,9	113,5	509,4	377,8	127,3	505,1	358,6	142,3	500,9
	5	426,5	101,2	527,7	408,8	114,0	522,8	390,3	127,9	518,2	370,8	142,9	513,7
	6	439,9	101,7	541,6	421,9	114,6	536,5	403,0	128,5	531,5	383,1	143,5	526,6
	7	453,6	102,1	555,7	435,2	115,1	550,3	416,0	129,0	545,0	395,7	144,1	539,8
	8	467,5	102,6	570,1	448,8	115,6	564,4	429,2	129,6	558,8	408,5	144,7	553,2
	9	481,7	103,0	584,7	462,6	116,2	578,8	442,6	130,2	572,8	421,6	145,4	567,0
146.2	4	457,3	111,4	568,7	438,0	125,5	563,5	417,9	140,7	558,6	396,7	157,2	553,9
	5	471,9	112,0	583,9	452,3	126,1	578,4	431,7	141,4	573,1	410,1	157,8	567,9
	6	486,8	112,5	599,3	466,8	126,7	593,5	445,8	142,0	587,8	423,8	158,5	582,3
	7	502,0	113,1	615,1	481,5	127,4	608,9	460,2	142,7	602,9	437,7	159,2	596,9
	8	517,4	113,6	631,0	496,5	128,0	624,5	474,8	143,4	618,2	451,8	160,0	611,8
	9	533,0	114,2	647,2	511,8	128,6	640,4	489,6	144,1	633,7	466,2	160,7	626,9
165.2	4	529,5	129,8	659,3	505,4	141,4	646,8	480,5	154,5	635,0	454,2	169,3	623,5
	5	547,0	131,5	678,5	522,6	143,0	665,6	497,0	156,1	653,1	470,4	170,8	641,2
	6	564,9	133,3	698,2	540,1	144,8	684,9	514,0	157,8	671,8	486,8	172,4	659,2
	7	583,2	135,2	718,4	557,9	146,6	704,5	531,3	159,5	690,8	503,5	174,0	677,5
	8	601,8	137,2	739,0	576,0	148,4	724,4	548,9	161,3	710,2	520,6	175,7	696,3
	9	621,2	139,2	760,4	594,4	150,4	744,8	566,8	163,1	729,9	538,0	177,5	715,5

**Note:** Values are based on  $\Delta T=5^{\circ}\text{C}$  entering/leaving condenser water temperature;  $\Delta T=5^{\circ}\text{C}$  entering/leaving evaporator water temperature and with evaporator fouling factor= $0,0176\text{ m}^2\text{ }^{\circ}\text{C}/\text{kW}$ , condenser fouling factor= $0,0440\text{ m}^2\text{ }^{\circ}\text{C}/\text{kW}$ .

## Total heat recovery ratings – ECOPLUS XE 050.1 ÷ 100.2

ECOPLUS Unit size	Evaporator Leaving Water Temperature (°C)	Heat recovery leaving water temperature - °C											
		35			40			45			50		
		Cooling Cap.ty [kW]	Power Input [kW]	Total Heat [kW]	Cooling Cap.ty [kW]	Power Input [kW]	Total Heat [kW]	Cooling Cap.ty [kW]	Power Input [kW]	Total Heat [kW]	Cooling Cap.ty [kW]	Power Input [kW]	Total Heat [kW]
050.1	4	167,1	37,1	204,2	159,6	41,9	201,5	151,9	47,0	198,9	143,9	52,6	196,5
	5	172,9	37,2	210,1	165,2	42,0	207,2	157,3	47,2	204,5	149,2	52,8	202,0
	6	178,8	37,3	216,1	171,0	42,2	213,2	162,9	47,4	210,3	154,6	53,0	207,6
	7	184,8	37,4	222,2	176,8	42,3	219,1	168,6	47,5	216,1	160,1	53,1	213,2
	8	191,0	37,5	228,5	182,8	42,5	225,3	174,4	47,7	222,1	165,7	53,3	219,0
060.1	4	200,8	44,6	245,4	192,0	50,4	242,4	182,8	56,6	239,4	173,2	63,2	236,4
	5	207,7	44,8	252,5	198,7	50,6	249,3	189,3	56,8	246,1	179,5	63,4	242,9
	6	214,7	44,9	259,6	205,5	50,7	256,2	195,9	57,0	252,9	185,9	63,7	249,6
	7	221,8	45,1	266,9	212,4	50,9	263,3	202,6	57,2	259,8	192,4	63,9	256,3
	8	229,1	45,2	274,3	219,5	51,1	270,6	209,5	57,4	266,9	199,1	64,1	263,2
073.1	4	248,9	54,7	303,6	237,9	61,7	299,6	226,6	69,3	295,9	214,7	77,4	292,1
	5	257,4	54,9	312,3	246,2	62,0	308,2	234,6	69,5	304,1	222,4	77,7	300,1
	6	266,1	55,1	321,2	254,7	62,2	316,9	242,8	69,8	312,6	230,3	78,0	308,3
	7	275,0	55,3	330,3	263,3	62,5	325,8	251,2	70,1	321,3	238,4	78,3	316,7
	8	284,1	55,5	339,6	272,1	62,7	334,8	259,7	70,4	330,1	246,7	78,6	325,3
080.1	4	287,4	64,6	352,0	274,8	70,1	344,9	261,8	76,3	338,1	248,1	83,4	331,5
	5	296,9	65,5	362,4	284,1	71,0	355,1	270,8	77,1	347,9	256,9	84,1	341,0
	6	306,6	66,5	373,1	293,6	71,8	365,4	280,0	78,0	358,0	265,8	84,9	350,7
	7	316,6	67,5	384,1	303,3	72,8	376,1	289,4	78,8	368,2	275,0	85,7	360,7
	8	326,7	68,5	395,2	313,1	73,7	386,8	299,0	79,7	378,7	284,2	86,6	370,8
100.2	4	328,4	74,1	402,5	314,0	83,7	397,7	299,0	93,9	392,9	283,5	105,1	388,6
	5	339,6	74,3	413,9	324,8	83,9	408,7	309,5	94,3	403,8	293,7	105,4	399,1
	6	351,1	74,5	425,6	336,0	84,2	420,2	320,3	94,6	414,9	304,2	105,7	409,9
	7	362,8	74,7	437,5	347,3	84,5	431,8	331,3	94,9	426,2	314,9	106,1	421,0
	8	374,7	74,9	449,6	358,9	84,8	443,7	342,6	95,2	437,8	325,8	106,5	432,3
	9	386,9	75,1	462,0	370,8	85,0	455,8	354,1	95,6	449,7	336,9	106,8	443,7

**Note:** Values are based on  $\Delta T=5^{\circ}\text{C}$  entering/leaving condenser water temperature;  $\Delta T=5^{\circ}\text{C}$  entering/leaving evaporator water temperature and with evaporator fouling factor=0,0176  $\text{m}^2\text{/kW}$ , condenser fouling factor=0,0440  $\text{m}^2\text{/kW}$ .

## Total heat recovery ratings – ECOPLUS XE 110.2 ÷ 165.2

ECOPLUS Unit size	Evaporator Leaving Water Temperature (°C)	Heat recovery leaving water temperature - °C											
		35			40			45			50		
		Cooling Cap.ty [kW]	Power Input [kW]	Total Heat [kW]	Cooling Cap.ty [kW]	Power Input [kW]	Total Heat [kW]	Cooling Cap.ty [kW]	Power Input [kW]	Total Heat [kW]	Cooling Cap.ty [kW]	Power Input [kW]	Total Heat [kW]
110.2	4	366,0	81,5	447,5	349,9	92,0	441,9	333,2	103,4	436,6	315,8	115,6	431,4
	5	378,6	81,8	460,4	362,1	92,3	454,4	345,0	103,7	448,7	327,2	115,9	443,1
	6	391,4	82,0	473,4	374,5	92,7	467,2	357,1	104,1	461,2	338,9	116,3	455,2
	7	404,4	82,2	486,6	387,2	93,0	480,2	369,4	104,4	473,8	350,8	116,7	467,5
	8	417,8	82,5	500,3	400,2	93,3	493,5	381,9	104,8	486,7	363,0	117,1	480,1
	9	431,4	82,7	514,1	413,4	93,6	507,0	394,8	105,2	500,0	375,5	117,6	493,1
120.2	4	398,0	88,8	486,8	380,7	100,3	481,0	362,7	112,6	475,3	343,8	125,9	469,7
	5	411,5	89,1	500,6	393,8	100,6	494,4	375,5	113,0	488,5	356,2	126,3	482,5
	6	425,3	89,4	514,7	407,2	101,0	508,2	388,5	113,4	501,9	368,8	126,8	495,6
	7	439,4	89,6	529,0	420,9	101,3	522,2	401,7	113,8	515,5	381,7	127,2	508,9
	8	453,7	89,8	543,5	434,8	101,6	536,4	415,2	114,2	529,4	394,8	127,6	522,4
	9	468,3	90,1	558,4	449,0	101,9	550,9	429,1	114,6	543,7	408,2	128,1	536,3
133.2	4	444,8	98,1	542,9	425,5	110,8	536,3	405,5	124,4	529,9	384,6	139,1	523,7
	5	459,9	98,4	558,3	440,2	111,2	551,4	419,8	124,8	544,6	398,4	139,6	538,0
	6	475,3	98,7	574,0	455,2	111,5	566,7	434,3	125,3	559,6	412,5	140,0	552,5
	7	491,0	99,0	590,0	470,4	111,9	582,3	449,1	125,7	574,8	426,8	140,5	567,3
	8	507,0	99,2	606,2	486,0	112,2	598,2	464,3	126,1	590,4	441,5	141,0	582,5
	9	523,4	99,5	622,9	501,9	112,6	614,5	479,7	126,6	606,3	456,5	141,5	598,0
146.2	4	484,8	107,3	592,1	464,1	121,1	585,2	442,7	136,1	578,8	420,2	152,2	572,4
	5	501,0	107,6	608,6	479,9	121,5	601,4	458,0	136,5	594,5	435,1	152,6	587,7
	6	517,6	107,9	625,5	496,1	121,9	618,0	473,7	137,0	610,7	450,3	153,1	603,4
	7	534,5	108,2	642,7	512,5	122,3	634,8	489,7	137,4	627,1	465,8	153,6	619,4
	8	551,7	108,5	660,2	529,3	122,7	652,0	506,0	137,9	643,9	481,6	154,1	635,7
	9	569,3	108,8	678,1	546,4	123,1	669,5	522,7	138,3	661,0	497,7	154,6	652,3
165.2	4	561,0	126,1	687,1	537,3	137,0	674,3	512,4	149,4	661,8	486,4	163,4	649,8
	5	580,0	127,8	707,8	555,2	138,5	693,7	529,9	150,8	680,7	503,4	164,8	668,2
	6	600,3	129,6	729,9	573,6	140,1	713,7	547,7	152,3	700,0	520,7	166,2	686,9
	7	621,0	131,5	752,5	593,6	141,9	735,5	565,9	153,9	719,8	538,4	167,6	706,0
	8	641,8	133,5	775,3	614,2	143,8	758,0	585,1	155,6	740,7	556,4	169,1	725,5
	9	663,0	135,5	798,5	634,9	145,7	780,6	605,5	157,4	762,9	574,7	170,7	745,4

**Note:** Values are based on  $\Delta T=5^{\circ}\text{C}$  entering/leaving condenser water temperature;  $\Delta T=5^{\circ}\text{C}$  entering/leaving evaporator water temperature and with evaporator fouling factor= $0,0176\text{ m}^2\text{ }^{\circ}\text{C}/\text{kW}$ , condenser fouling factor= $0,0440\text{ m}^2\text{ }^{\circ}\text{C}/\text{kW}$ .

# Total heat recovery pressure drop ECOPLUS SE/XE 050.1 ÷ 165.2

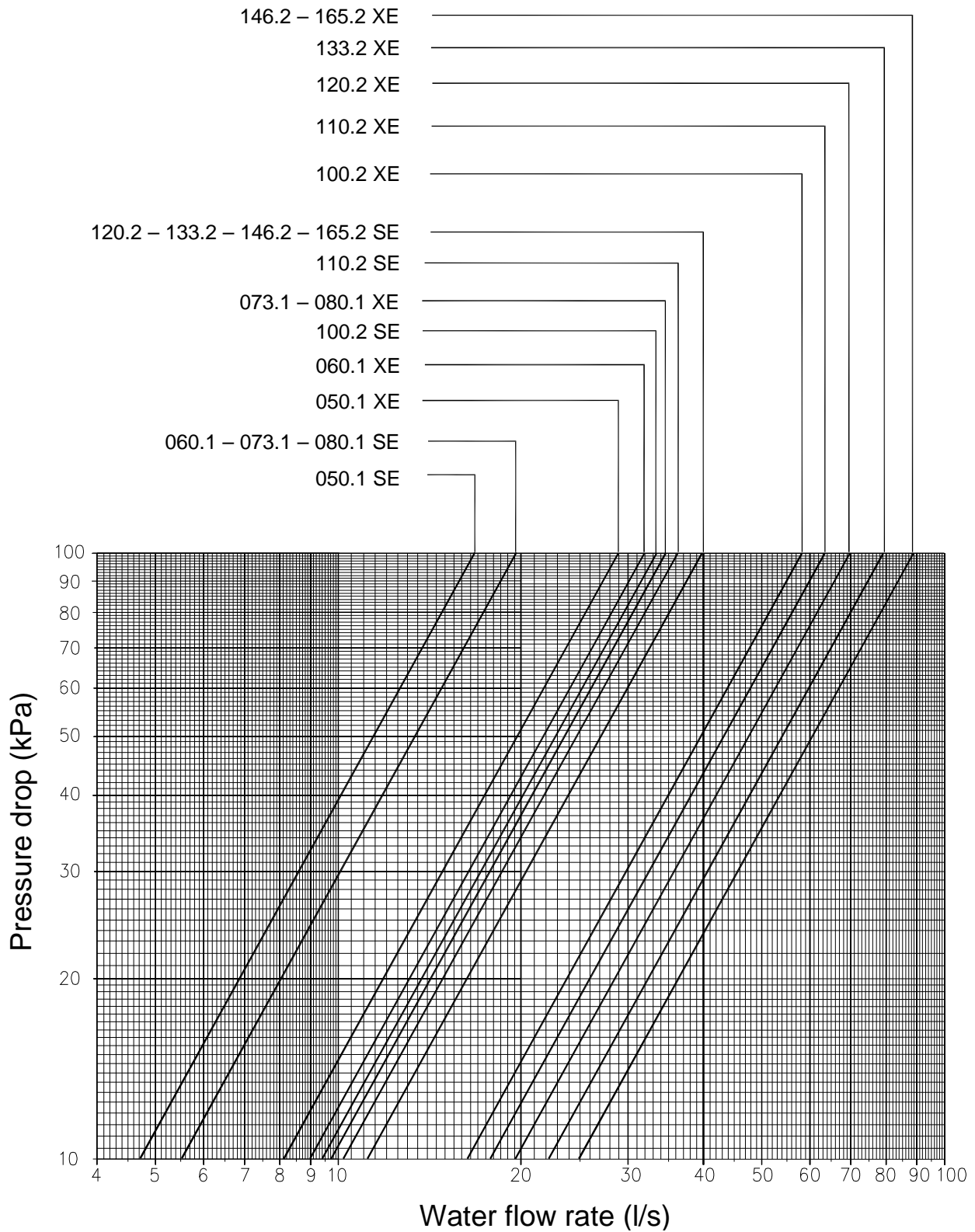

## Screw compressors

Stargate™ single-screw compressor has a well balanced compression mechanism which cancels the screw rotor load in both the radial and axial directions. Inherent to the basic single-screw compressor design is the virtually load-free operation, that gives main bearing design life of 3-4 times greater than twin-screws, and eliminates expensive and complicated thrust balancing schemes. The two exactly opposed gaterotors create two exactly opposed compression cycles. Compression is made at the lower and upper parts of the screw rotor at the same time, thus cancelling the radial loads. Also, both ends of the screw rotor are subjected to suction pressure only, which cancels the axial loads and eliminates the huge thrust loads inherent in twin-screw compressors.

Oil injection is used for these compressors in order to get high COP at high condensing pressure. ECOPLUS is equipped with single screw compressor Frame 3200 that is provided with an high efficiency integrated oil separator to maximise oil extraction.

Compressors have a infinitely variable capacity control down to 25% of its total capacity. This control is made by means of capacity slides controlled by microprocessors.

Standard start is star-delta type; Soft start type is available (as option) in order to have lower inrush current.

## Standard controls

### High pressure control

The high pressure switch will shut-down the compressor when the discharge pressure exceeds the setting point value.

**Warning:** during testing, stand by the emergency stop switch on control panel, to shut the unit down should the safety control malfunction. Be sure that the installed gauge is accurately adjusted.

### Phase/voltage monitor

The phase/voltage monitor is a device which provides protection against three-phase electrical motor loss due to power failure conditions, phase loss, and phase reversal. Whenever any of these conditions occur, a contact opens to the microprocessor which then de-energizes all inputs. When proper power is restored, contacts close and microprocessor enables compressors for operation. When three-phase power has been applied, the output relay should close and the "run light" should come on. If the output relay does not close, perform the following tests:

1. Check the voltages between L1-L2, L1-L3 and L2-L3 (L1, L2, L3 are the three phases). These voltages should be approximately equal and within + 10% of the rated three-phase line-to-line voltage.
2. If these voltages are extremely low or widely unbalanced check the power system to determine the cause of the problem.
3. If the voltages are good, using a phase tester, verify that phases are in A, B, C sequence for L1, L2 and L3. Correct rotation is required for compressor operation. If required to do so by phase sequence, turn off the power and interchange any two of the supply power leads at the disconnect. This may be necessary as the phase voltage monitor is sensitive to phase reversal. Turn on the power. The output relay should now close after the appropriate delay.

## System Maintenance

### General

To ensure proper operation at peak capacity and to avoid damage to package components, a program of periodic inspections should be set up and followed. The following items are intended as a guide and are to be used during inspection and must be combined with sound refrigeration and electrical practices to ensure trouble-free performance. The liquid line sightglass indicator on all circuits must be checked to be sure the glass is full and clear. If the indicator shows that a wet condition exists or if bubbles show in the glass, even with a full refrigerant charge, the filter-drier element must be changed.

## Compressor maintenance

The screw Frame 3200 compressor does not require frequent maintenance. However, vibration is an excellent check for proper mechanical operation. Compressor vibration is an indicator of the requirement for maintenance and contributes to a decrease in unit performance and efficiency. It is recommended that the compressor be checked with a vibration analyzer at or shortly after start-up and again on an annual basis. When performing the test the load should be maintained as closely as possible to the load of the original test. The vibration analyzer test provides a fingerprint of the compressor and when performed routinely can give a warning of impending problems. The compressor is supplied with a cartridge oil filter. It is a good policy to replace this filter anytime the compressor is opened for servicing.

## Electrical control centre

**Warning:** Electric shock hazard. Turn off all power before continuing with following service.

**Caution:** It is necessary to de-energize the complete panel, including crankcase heater, before doing any servicing inside.

Prior to attempting any service on the control centre it is advisable to study the wiring diagram so that you understand the operation of the water chiller. Electrical components do not require particular maintenance other than a monthly tightening of cables.

**Warning:** The warranty becomes void if the wiring is not in accordance with the specification. A blown fuse or tripped protector indicates a short ground or overload.

Before replacing the fuse or restarting the compressor, the problem must be found and corrected. It is important to have a qualified control panel electrician service this panel. Unqualified tampering with the controls can cause serious damage to equipment and void the warranty.

## Refrigerant sightglass

The refrigerant sightglasses should be observed periodically (a weekly observation should be adequate). A clear glass of liquid indicates that there is adequate refrigerant charge in the system to insure proper feed through the expansion valve. Bubbling refrigerant in the sightglass, during stable run conditions, indicates that the system may be short of refrigerant charge. Refrigerant gas flashing in the sightglass could also indicate an excessive pressure drop in the liquid line, possibly due to a clogged filter-drier or a restriction elsewhere in the liquid line. If subcooling is low add charge to clear the sightglass. If subcooling is normal and flashing is visible in the sightglass check the pressure drop across the filter-drier. An element inside the sightglass indicates the moisture condition corresponding to a given element color. If the sightglass does not indicate a dry condition after about 3 hours of operation, the unit should be pumped down and the filter-driers changed.

The following table is a guide to determine the dry or wet condition of the system:

COLOUR	MEANS
Green (Sky Blue)	Dry
Yellow (Pink)	Wet

## Filter-driers

A replacement of the filter-drier is recommended during scheduled service maintenance of the unit, any time excessive pressure drop is read across the filter-drier and/or when bubbles occur in the sightglass with normal subcooling. The maximum recommended pressure drop across the filter-drier at 75% to 100% circuit loading is 70 kPa. The maximum recommended pressure drop across the filter-drier at 25% to 50% circuit loading is 35 kPa. The filter-drier should also be changed if the moisture indicating liquid line sightglass indicates excess moisture by the wet system color indicators. During the first few months of operation the filter-drier replacement may be necessary if the pressure drop across the filter-drier exceeds the values listed in the paragraph above. Any residual particles from the unit heat transfer tubing, compressor and miscellaneous components are swept by the refrigerant into the liquid line and are caught by the filter-drier.

To change the filter drier, pump the unit down by moving the ON/OFF compressors switches in "off" position.

Move the ON/OFF switch unit Q0 to the "off" position. Turn off all power to the unit and install jumpers across the terminals.

This jumps out the low pressure control. Close the manual liquid line shutoff valve.

Turn the power of the unit back on and restart the unit by moving the ON/OFF switch unit Q0. The unit will start pumping down past the low pressure setting.

When the evaporator pressure reaches 0,3 bar, move switch Q0 to the “off” position. Remove the jump. Close the suction line valve. Remove and replace the filter-drier. Evacuate the lines through the liquid line manual shutoff valve to remove non condensables that may have entered during filter replacement. Open the suction line valve. A leak check is recommended before returning the unit to operation.

## Electronic expansion valve

The ECOPLUS water cooled chiller is equipped with the most advanced electronic expansion valve to achieve precise control of refrigerant mass flow. As today's system requires improved energy efficiency, tighter temperature control, wider range of operating conditions and incorporate features like remote monitoring and diagnostics, the application of electronic expansion valves becomes mandatory. ECOPLUS's electronic expansion valve proposes features that makes it unique: short opening and closing time, high resolution, positive shut-off function to eliminate use of additional solenoid valve, highly linear flow capacity, continuous modulation of mass flow without stress in the refrigerant circuit and corrosion resistance stainless steel body.

## Evaporator

The evaporator is a direct expansion type with refrigerant inside the copper tubes and water on the outside. The evaporators are manufactured with carbon steel shells, high efficiency copper tubes and polypropylene baffles. The copper tubes are roll expanded into carbon steel tube plates.

## Condensers

Condensers are shell and cleanable, through-tube type (1 pass). The unit has independent condensers, one per circuit. Each condenser has a carbon steel and seamless, integrally finned high efficiency copper tubes, roll expanded into heavy carbon steel tube sheets. Water heads are removable and include vent and drain plugs. Condensers come complete with liquid shut-off valve, spring loaded relief valve.

**Note:** The units are furnished with 1 pass condensers as standard (water entering a side and water leaving the opposite side of the heat exchanger). On request the chillers will be equipped with 2 passes condensers (entering and leaving water on the same side of the heat exchanger); two different options are available:

- condensers two passes standard water  $\Delta T$  ( $\Delta T$  between 4 and 8 °C)
- condensers two passes high water  $\Delta T$  ( $\Delta T$  between 8 and 15 °C). In this case total heat recovery is not available.

## Lubricating oils

Besides lubricating the bearing and other moving parts, the oil has the equally important task of sealing the clearances between the rotors and other potential leakage paths thereby improving pumping efficiency; the oil also assists in dissipating the heat of compression. The amount of oil injected is therefore well in excess of that required for lubrication alone.

Lubricating oil approved by McQuay is mentioned on the compressor label.

The oil differential pressure switch monitors the pressure differential between oil injection pressure and compressor suction pressure.

After the compressor has started and been in operation for a short time, allowing sufficient time for the system pressure differential to become established, the oil differential pressure switch is brought into the safety trip circuit. Oil is now being supplied to the compressor under the action of the system pressure differential, monitored by the switch. If the pressure differential falls below the switch contacts ' break ' setting and the oil differential pressure switch trips and stops the compressor.

Because the oil pressure is generated by discharge pressure, a minimum discharge pressure must be maintained; this minimum pressure increases as the suction pressure increases in order to maintain the pressure difference required.

## Crankcase and oil separator heaters

The function of the heaters is to prevent oil dilution with refrigerant during compressor shutdown, which would cause foaming and consequent reduction in lubricating oil flow to the moving parts. Electric heaters are energized every time the compressor shuts-down.

**Warning:** Verify the heaters have operated for at least 12 hours prior to start-up.

# Preventive maintenance schedule

Operation Ref. No.	TYPE OF OPERATION	PERIODICITY			
		Weekly	Monthly	Six-Monthly	Yearly
1	Reading and recording of suction pressure	X			
2	Reading and recording of discharge pressure	X			
3	Reading and recording of supply voltage	X			
4	Reading and recording of current intensity	X			
5	Check refrigerant charge and possible moisture in the circuit refrigerant through the liquid sight glass	X			
6	Check the suction temperature and the superheating		X		
7	Check setting and operation of safety devices		X		
8	Check setting and proper operation of control devices			X	
9	Inspect the condenser for possible scaling or studding				X

## Refrigerant

### Refrigerant charging

ECOPLUS water cooled screw chillers are shipped factory charged with a full operating charge of refrigerant but there may be times that a unit must be recharged at the jobsite. Follow these recommendations when field charging. ECOPLUS water cooled screw chillers are more sensitive to under-charging than to overcharging therefore it is preferable to be slightly overcharged rather than undercharged on a circuit. The optimum charge is the charge which allows the unit to run with a solid stream of liquid in the liquid line at all operating conditions. When the liquid line temperature does not drop with the addition of 2,2-4,5 Kg of charge then the subcooler is nearly full and proper charge has been reached. If the liquid line temperature does not drop and the discharge pressure goes up 20,7-34,5 kPa as 2,2-4,5 Kg of refrigerant is added the correct maximum charge has been reached. Unit charging can be done at any steady load condition, at any outdoor ambient temperature. Unit must be allowed to run 5 minutes or longer so that the condenser fan staging is stabilized at normal operating discharge pressure.

In case moisture is noticed in the system, through the moisture indicator, the system must be evacuated to eliminate cause of trouble. After the evacuation, the system must be dried reducing it to an almost perfect vacuum. For this purpose, a displacement vacuum pump should be used.

Any moisture and air left in the system will be absorbed by the dry nitrogen used to break the vacuum, and they will be almost completely removed by the three evacuations.

If burnt oil or sludge are found in the refrigerant circuit (caused by the compressor motor burn-out), before the vacuum operation it will be necessary to carefully clean the system using the filter dryer cleanout method; which basically involves the use of special filter dryers incorporating a suitable desiccant in both the liquid and suction lines.

Excessive refrigerant losses can also leak oil from the system. Check the separator oil level during operation and ensure that oil is visible in the top sightglass.

1. If the unit is slightly undercharged the unit will show bubbles in the sightglass. Recharge the unit.
2. If the unit is moderately undercharged the unit will most likely trip on freeze protection. Recharge the unit as described in the charging procedure below.



### **Procedure to charge a moderately undercharged ECOPLUS unit**

1. If a unit is low on refrigerant you must first determine the cause before attempting to recharge the unit. Locate and repair any refrigerant leak. Evidence of oil is a good indicator of leakage however, oil may not be visible at all leaks. Liquid leak detector fluids work well to show bubbles at medium size leaks but electronic leak detector may be needed to locate small leaks.
2. Add the charge to the system through the schrader fitting on the tube entering the evaporator between the expansion valve and the evaporator head.
3. The charge can be added at any load condition.

### **Charging the refrigerant**

1. Connect the refrigerant bottle with a filling pipe to the filling valve on the evaporator head. Before firmly tightening the refrigerant bottle valve, open it and force the air out from the filling pipe. Tighten the charging valve connection.
2. When the refrigerant stops to enter the system, start the compressor and complete the refrigerant charge.
3. When the exact quantity of refrigerant has been predetermined, check the liquid sight glass.

If you do not know how much refrigerant has to be added, shut off the bottle valve every 5 minutes and continue to charge the refrigerant until the sight glass is clear and free from bubbles.

**Note:** Do not discharge the refrigerant into the atmosphere. To recover it, use empty, clean and dry bottles. The liquid refrigerant recovery can be made through the valve provided on the condenser coil subcooler outlet. To facilitate the recovery of refrigerant, put the bottle inside a container full of ice; avoid excessive filling of the bottle (70÷80% max).

## **Start-up and shut-down**

### **Pre-Start-up**

1. Open all electrical disconnects and check electrical connections are tight.
2. Verify water piping flow directions are correct and properly connected at the evaporator and condenser.
3. Using a phase tester, check that electrical phasing to each compressor circuit is A-B-C for phases L1, L2, & L3 respectively
4. Verify unit power supply is within 10% of nameplate rating.
5. Verify power supply wiring is the correct size and has a minimum temperature insulation rating of 75°C.
6. Verify all mechanical and electrical inspections have been completed according to local code.
7. Make certain all auxiliary control equipment is operative and an adequate cooling load is available.
8. Check all compressor valve connections for tightness.
9. Open compressor suction valve until backseated.
10. Open discharge shutoff valve until backseated.
11. Vent air from the evaporator and condenser water system piping.
12. Open all water flow valves and start chilled water pump.
13. Check all piping for leaks.
14. Flush the evaporator and condenser system piping.

## Initial Start-up

Initial Start-up must be performed by McQuayService personnel.

1. Set up control as described in Initial Conditions.
2. Turn front panel switch to Auto position. (chilled water flow pump relay will energize.)
3. If the field installed flow indicator does not indicate chilled water flow after 30 seconds, then the alarm output will be energized.

**Note:** The unit starts the compressor with the least starts and run hours while in auto lead lag setting

4. When the Active Setpoint is 3 °C lower than the actual leaving water temperature, the chiller starts.
5. When the chiller starts the following occurs:
  - Crank case heaters de-energize
  - Compressor starts
  - Motor cooling solenoid is energized
6. Suction injection will turn off when the following conditions have been met:
  - Discharge superheat drops below 3 °C
  - Liquid Presence sensor shows liquid

## In warranty return material procedure

Material may not be returned except by permission of McQuayService department. A "Return Goods" tag will be included with the returned material. This tag will all informations required to expedite handling at our factory. Return of the parts does not constitute an order for replacement. Therefore, a purchase order must be entered through our nearest Sales Representative. The order should include part name, part number, model number and serial number of the unit involved. Following our personal inspection of the returned part, if it is determined that the failure is due to faulty material or workmanship, credit will be issued on the customer's purchase order. All parts shall be returned to McQuay factory, transportation charges prepaid.

## Service & replacement parts

Always quote the model number, confirmation number and the machine's serial number stamped on the plaque attached to the machine itself, whenever ordering maintenance service or replacement parts.

If replacement parts are being ordered, state the date the machine was installed and the date the breakdown occurred. For an exact definition of the replacement part requested, make reference to the relative code number or, failing that, attach a description of the part being requested.



We reserve the right to make changes in design and construction at any time without notice, thus the cover picture is not binding.

McQuay partecipa al programma di  
Certificazione Eurovent.  
I prodotti interessati figurano nella Guida  
Eurovent dei Prodotti Certificati.



McQuay is participating in the Eurovent  
Certification Programme  
Product are as listed in the Eurovent  
Directory of Certified Products

**McQuay**<sup>®</sup>  
International

McQuay Italia S.P.A.

S.S. Nettunense, km 12+300 – 00040 Cecchina (Roma) Italia – Tel. (06) 937311 – Fax (06) 9374014 – E-mail: [info@mcquayeuropa.com](mailto:info@mcquayeuropa.com)  
[www.mcquayeuropa.com](http://www.mcquayeuropa.com)