



# Service Manual

---

Models: GWH09YD-S6DBA2A  
GWH12YD-S6DBA2A  
(Refrigerant:R32)

## Table of Contents

<b>Part I : Technical Information</b> .....	1
<b>1. Summary</b> .....	1
<b>2. Specifications</b> .....	2
2.1 Specification Sheet.....	2
2.2 Operation Characteristic Curve .....	4
2.3 Capacity Variation Ratio According to Temperature .....	4
2.4 Cooling and Heating Data Sheet in Rated Frequency .....	5
2.5 Noise Curve.....	5
<b>3. Outline Dimension Diagram</b> .....	6
3.1 Indoor Unit.....	6
3.2 Outdoor Unit .....	7
<b>4. Refrigerant System Diagram</b> .....	8
<b>5. Electrical Part</b> .....	9
5.1 Wiring Diagram.....	9
5.2 PCB Printed Diagram .....	11
<b>6. Function and Control</b> .....	13
6.1 Remote Controller Introduction .....	13
6.2 GREE+ App Operation Manual .....	23
6.3 Ewpe Smart App Operation Manual .....	24
6.4 Brief Description of Modes and Functions.....	25
<b>Part II : Installation and Maintenance</b> .....	30
<b>7. Notes for Installation and Maintenance</b> .....	30
<b>8. Installation</b> .....	34
8.1 Installation Dimension Diagram.....	34
8.2 Installation Parts-checking .....	36
8.3 Selection of Installation Location.....	36
8.4 Electric Connection Requirement.....	36
8.5 Installation of Indoor Unit.....	36
8.6 Installation of Outdoor Unit.....	39
8.7 Vacuum Pumping and Leak Detection .....	40
8.8 Check after Installation and Test Operation .....	40
8.9 Wired Controller .....	41

<b>9. Maintenance</b>	51
9.1 Error Code List	51
9.2 Procedure of Troubleshooting	58
9.3 Maintenance Method for Normal Malfunction	73
<b>10. Exploded View and Parts List</b>	75
10.1 Indoor Unit	75
10.2 Outdoor Unit	78
<b>11. Removal Procedure</b>	80
11.1 Removal Procedure of Indoor Unit	80
11.2 Removal Procedure of Outdoor Unit	85
<b>Appendix:</b>	91
Appendix 1: Reference Sheet of Celsius and Fahrenheit	91
Appendix 2: Configuration of Connection Pipe	91
Appendix 3: Pipe Expanding Method	92
Appendix 4: List of Resistance for Temperature Sensor	93

# Part I : Technical Information

---

## 1. Summary

### Indoor Unit:

GWH09YD-S6DBA2A/I  
GWH12YD-S6DBA2A/I

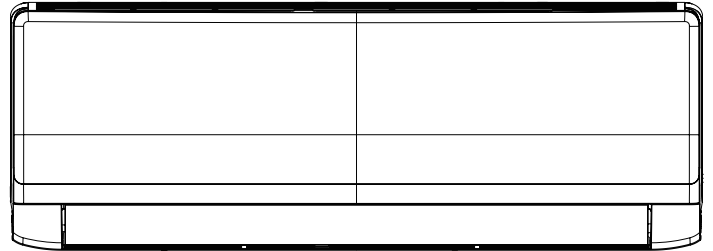

### Outdoor Unit:

GWH09YD-S6DBA2A/O  
GWH12YD-S6DBA2A/O

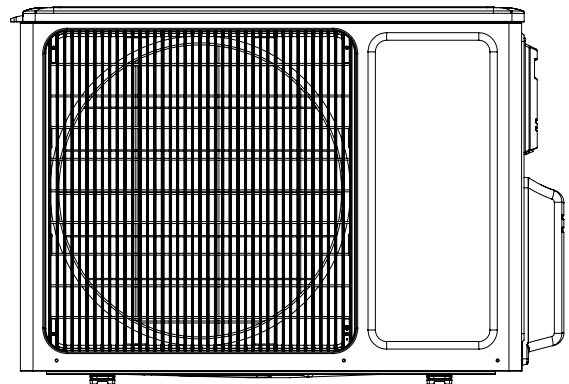

### Remote Controller:

YAG1FB

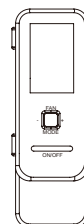

YAG1FB3(WiFi)





## 2. Specifications

### 2.1 Specification Sheet

Model			GWH09YD-S6DBA2A	GWH12YD-S6DBA2A
Product Code			CB466000100/CB466000102	CB466000200
Power Supply	Rated Voltage	V~	220-240	220-240
	Rated Frequency	Hz	50/60	50/60
	Phases		1	1
Power Supply Mode			Outdoor	Outdoor
Cooling Capacity		W	2700	3530
Heating Capacity		W	3500	4200
Cooling Power Input		W	550	840
Heating Power Input		W	745	950
Cooling Power Current		A	3.52	5.10
Heating Power Current		A	4.63	5.70
Rated Input		W	2400	2600
Rated Current		A	10.65	12
Air Flow Volume(SH/H/MH/M/ML/L/SL)		m <sup>3</sup> /h	800/720/570/620/560/500/450	800/730/680/630/580/530/430
Dehumidifying Volume		L/h	0.8	1.40
EER		W/W	4.91	4.20
COP		W/W	4.70	4.42
SEER		W/W	8.50	8.50
HSPF		W/W	/	/
Application Area		m <sup>2</sup>	12-18	16-24
Indoor Unit	Model of indoor unit		GWH09YD-S6DBA2A/I	GWH12YD-S6DBA2A/I
	Indoor Unit Product Code		CB466N00100/CB466N00102	CB466N00200
	Fan Type		Cross-flow	Cross-flow
	Diameter Length(DXL)		mm	Φ106X706
	Fan Motor Cooling Speed		r/min	1200/1100/1030/960/890/820/750/500
	Fan Motor Heating Speed		r/min	1300/1200/1120/1040/960/880/800/-
	Output of Fan Motor		W	60
	Fan Motor RLA		A	0.09
	Fan Motor Capacitor		μF	/
	Input of Heater		W	/
	Evaporator Form			Aluminum Fin-copper Tube
	Pipe Diameter		mm	Φ7
	Row-fin Gap		mm	2-1.4
	Coil Length (LXDXW)		mm	715X25.4X304.8
	Swing Motor Model			MP35CJ/MP24HF
	Output of Swing Motor		W	2.5/1.5
	Fuse		A	3.15
	Sound Pressure Level (SH/H/MH/M/ML/L/SL)		dB (A)	43/41/38/36/33/31/18
	Sound Power Level (SH/H/MH/M/ML/L/SL)		dB (A)	58/51/48/46/43/41/28
	Dimension (WXHXD)		mm	996X301X225
	Dimension of Carton Box (LXWXH)		mm	1057X377X307
Dimension of Package (LXWXH)		mm	1060X380X322	
Net Weight		kg	13	
Gross Weight		kg	16	

Outdoor Unit	Model of Outdoor Unit		GWH09YD-S6DBA2A/O	GWH12YD-S6DBA2A/O
	Outdoor Unit Product Code		CB466W00100	CB466W00200
	Compressor Manufacturer/Trademark		ZHUHAI LANDA COMPRESSOR CO., LTD	ZHUHAI LANDA COMPRESSOR CO., LTD
	Compressor Model		QXFT-B123zE170A	QXFT-B123zE170A
	Compressor Oil		FW68DA	FW68DA/equivalent
	Compressor Type		Rotary	Rotary
	L.R.A.	A	20	35
	Compressor RLA	A	7.9	7.9
	Compressor Power Input	W	1230	1230
	Overload Protector		/	/
	Throttling Method		Electron expansion valve	Electron expansion valve
	Operation Temp	°C	16~30	16~30
	Ambient Temp (Cooling)	°C	-18~54	-18~54
	Ambient Temp (Heating)	°C	-30~24	-30~24
	Condenser Form		Aluminum Fin-copper Tube	Aluminum Fin-copper Tube
	Pipe Diameter	mm	Φ7	Φ7.94
	Rows-fin Gap	mm	2.5-1.4	2.5-1.4
	Coil Length (LXDXW)	mm	763X57X550	783X57X550
	Fan Motor Speed	rpm	900	850
	Output of Fan Motor	W	30	30
	Fan Motor RLA	A	0.24	0.24
	Fan Motor Capacitor	μF	/	/
	Air Flow Volume of Outdoor Unit	m <sup>3</sup> /h	2400	2400
	Fan Type		Axial-flow	Axial-flow
	Fan Diameter	mm	Φ438	Φ438
	Defrosting Method		Automatic Defrosting	Automatic Defrosting
	Climate Type		T1	T1
	Isolation		I	I
	Moisture Protection		IPX4	IPX4
	Permissible Excessive Operating Pressure for the Discharge Side	MPa	4.3	4.3
	Permissible Excessive Operating Pressure for the Suction Side	MPa	2.5	2.5
	Sound Pressure Level (H/M/L)	dB (A)	53/-/-	54/-/-
	Sound Power Level (H/M/L)	dB (A)	62/-/-	62/-/-
Dimension (WXHXD)	mm	899X596X378	899X596X378	
Dimension of Carton Box (LXWXH)	mm	945X417X630	945X417X630	
Dimension of Package (LXWXH)	mm	948X420X645	948X420X645	
Net Weight	kg	44.5	45.5	
Gross Weight	kg	47.5	48.5	
Refrigerant		R32	R32	
Refrigerant Charge	kg	1	1	
Connection Pipe	Length	m	5	5
	Gas Additional Charge	g/m	20	20
	Outer Diameter Liquid Pipe	mm	Φ6	Φ6
	Outer Diameter Gas Pipe	mm	Φ9.52	Φ9.52
	Max Distance Height	m	10	20
	Max Distance Length	m	15	40
Note: The connection pipe applies metric diameter.				

The above data is subject to change without notice; please refer to the nameplate of the unit.

## 2.2 Operation Characteristic Curve

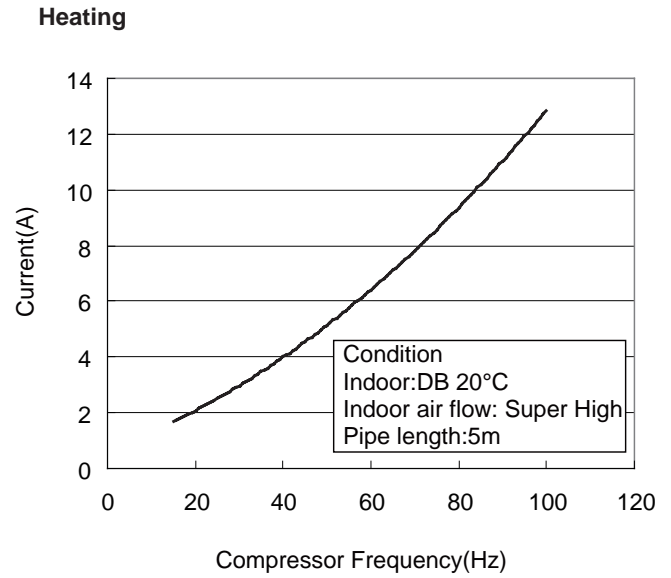
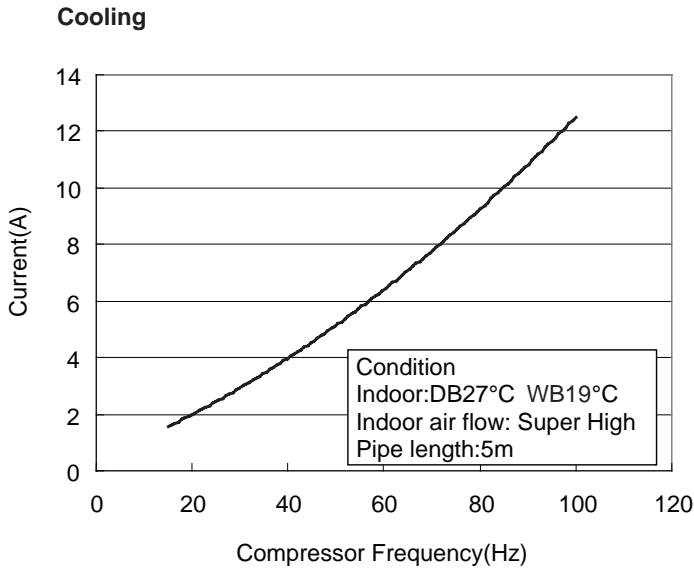

## 2.3 Capacity Variation Ratio According to Temperature

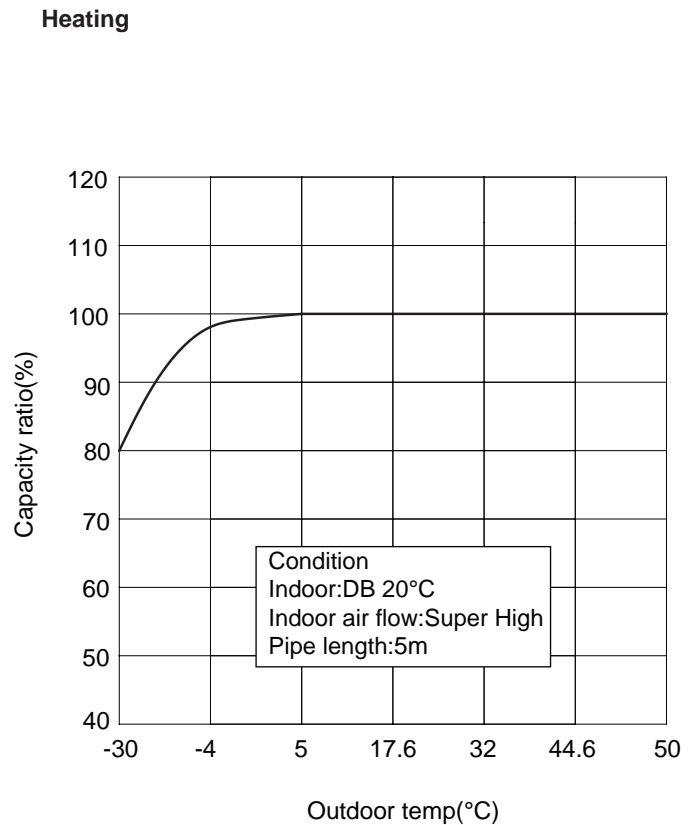
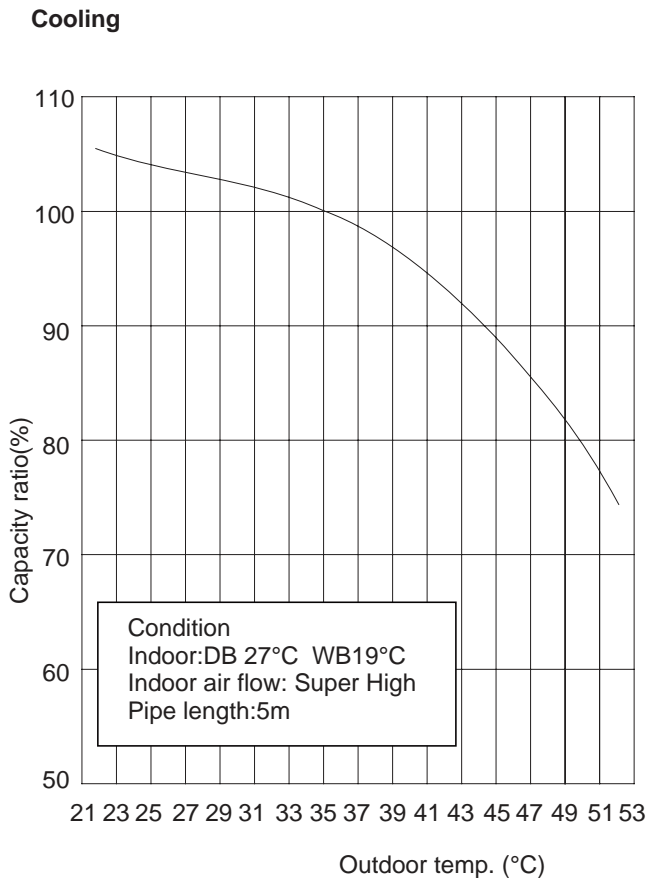

## 2.4 Cooling and Heating Data Sheet in Rated Frequency

Cooling:

Rated cooling condition(°C) (DB/WB)		Model	Pressure of gas pipe connecting indoor and outdoor unit	Inlet and outlet pipe temperature of heat exchanger		Fan speed of indoor unit	Fan speed of outdoor unit
Indoor	Outdoor			T1 (°C)	T2 (°C)		
27/19	35/24	9K	0.9 to 1.1	12 to 14	75 to 37	Super High	High
27/19	35/24	12K	0.9 to 1.1	12 to 14	75 to 37	Super High	High

Heating:

Rated heating condition(°C) (DB/WB)		Model	Pressure of gas pipe connecting indoor and outdoor unit	Inlet and outlet pipe temperature of heat exchanger		Fan speed of indoor unit	Fan speed of outdoor unit
Indoor	Outdoor			T1 (°C)	T2 (°C)		
20/-	7/6	9K	2.8 to 3.0	70 to 35	2 to 4	Super High	High
20/-	7/6	12K	2.8 to 3.0	70 to 35	2 to 4	Super High	High

**Instruction:**

T1: Inlet and outlet pipe temperature of evaporator

T2: Inlet and outlet pipe temperature of condenser

P: Pressure at the side of big valve

Connection pipe length: 5m.

## 2.5 Noise Curve

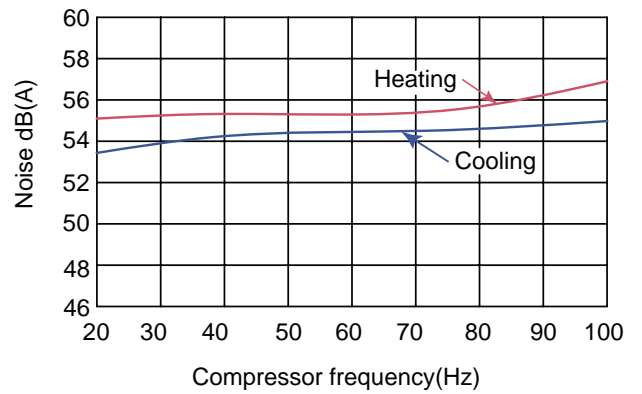
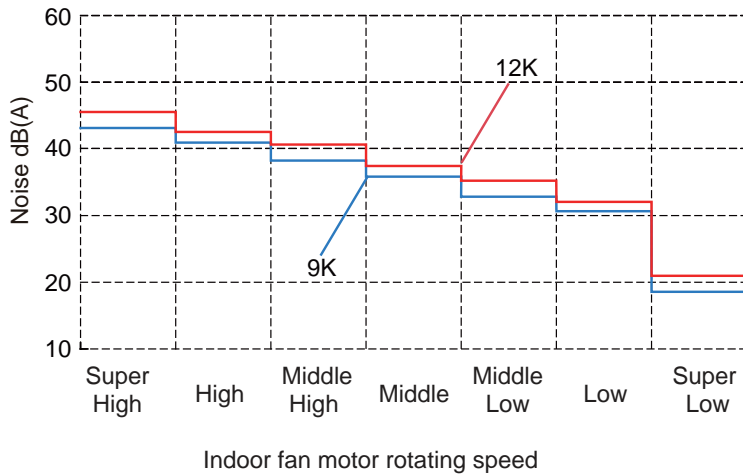

### 3. Outline Dimension Diagram

#### 3.1 Indoor Unit

09/12K

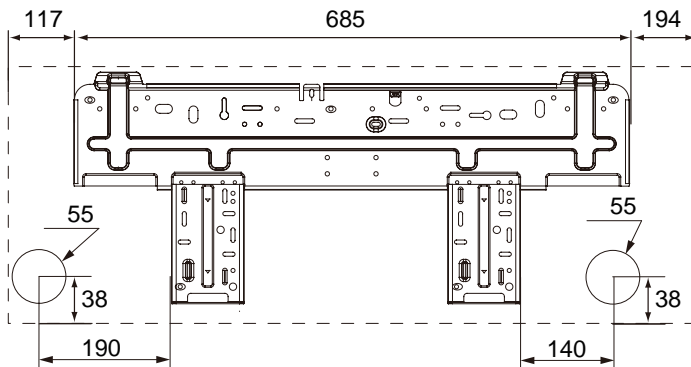
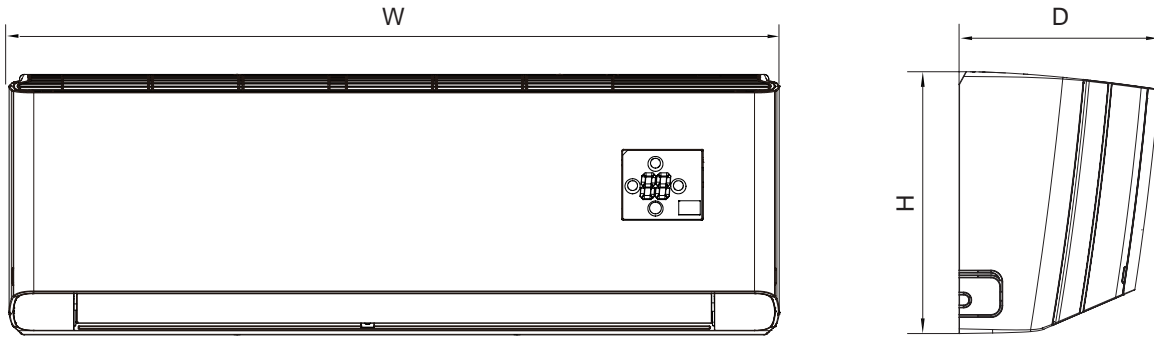

Unit:mm

Model	W	H	D
09K/12K	996	301	225

### 3.2 Outdoor Unit

GWH09YD-S6DBA2A/O GWH12YD-S6DBA2A/O

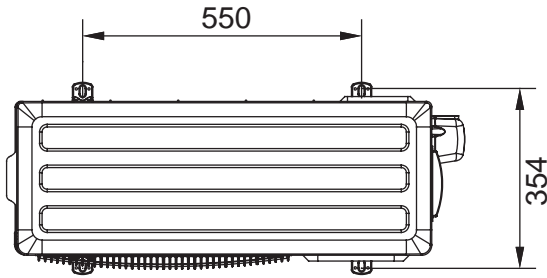
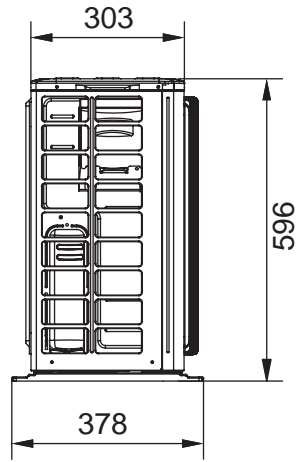
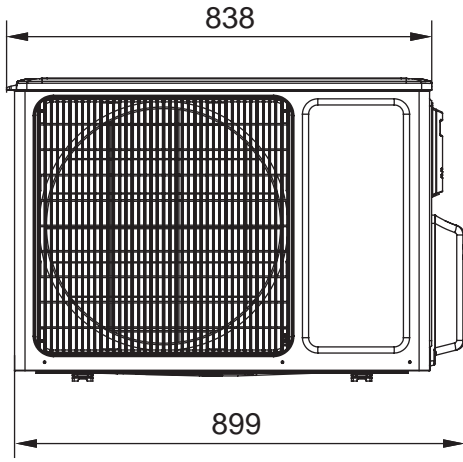

Unit:mm

# 4. Refrigerant System Diagram

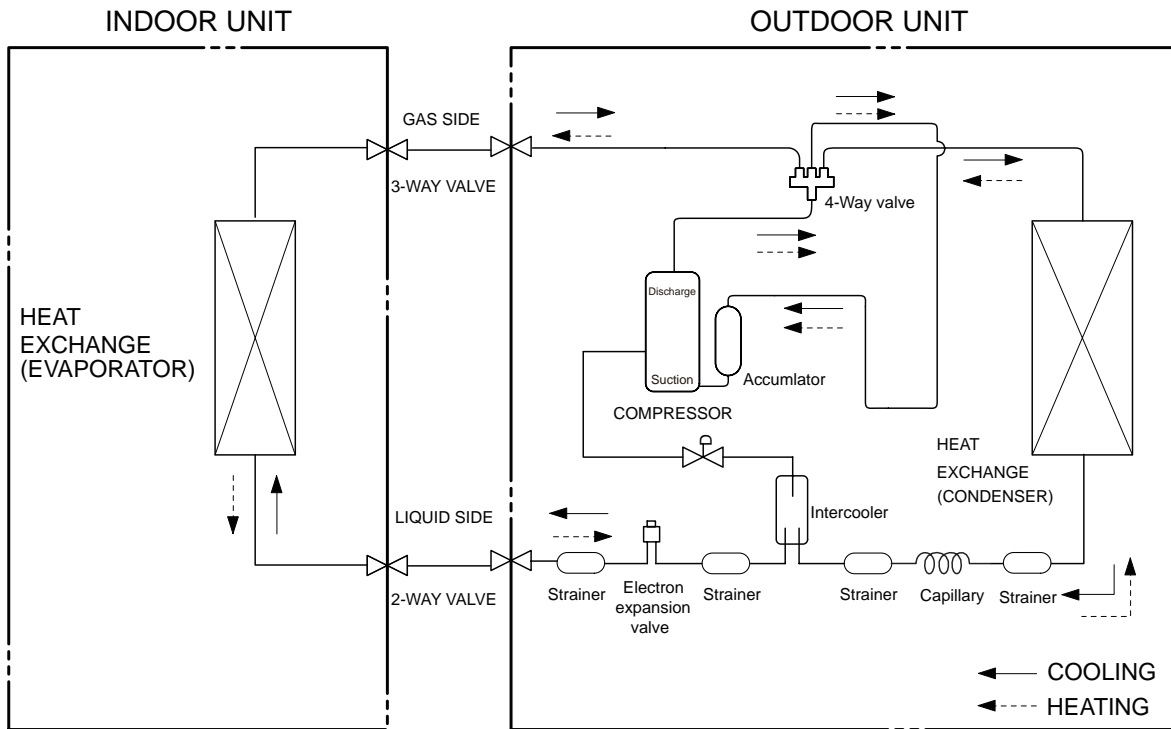

Connection pipe specification:  
 Liquid pipe: 1/4" (6mm)  
 Gas pipe: 3/8" (9.52mm)

# 5. Electrical Part

## 5.1 Wiring Diagram

### • Instruction

Symbol	Symbol Color	Symbol	Symbol Color	Symbol	Name
WH	White	GN	Green	CAP	Jumper cap
YE	Yellow	BN	Brown	COMP	Compressor
RD	Red	BU	Blue		Grounding wire
YEGN	Yellow/Green	BK	Black	/	/

Note: Jumper cap is used to determine fan speed and the swing angle of horizontal lover for this model.

### • Indoor Unit

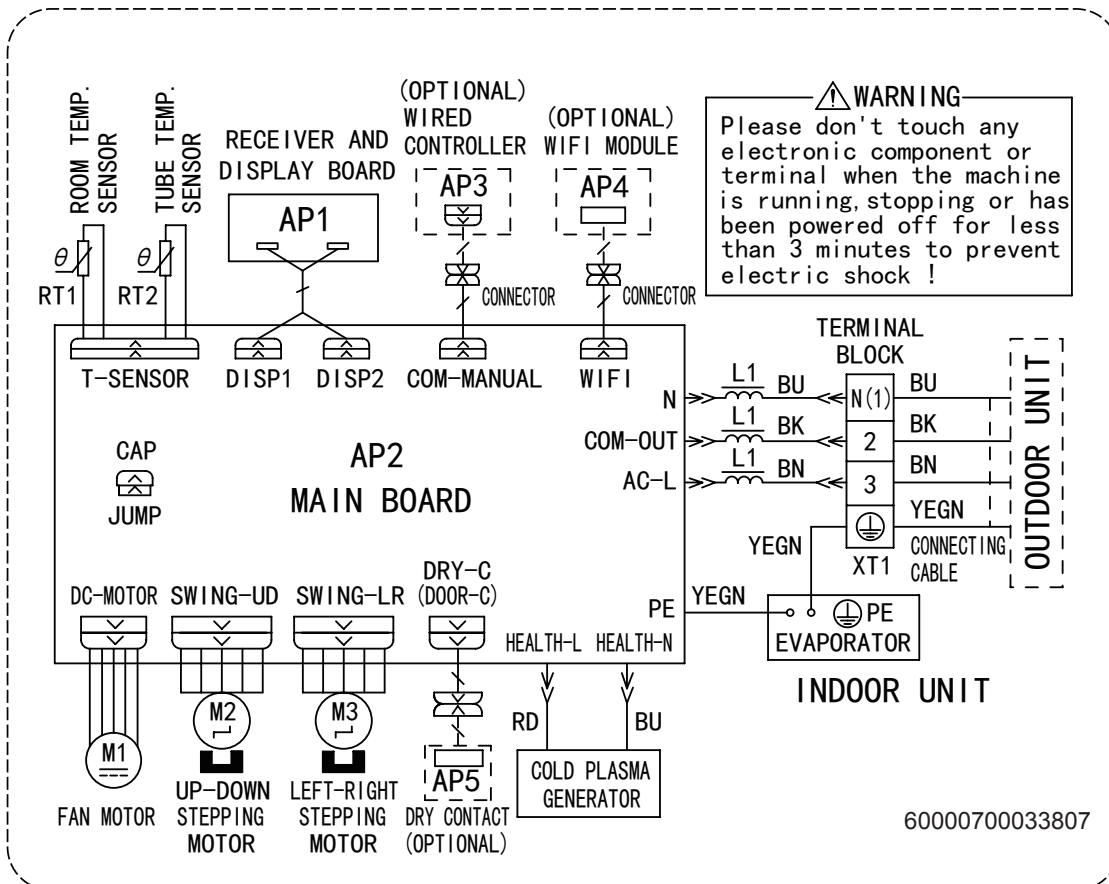



• Outdoor Unit

GWH12YD-S6DBA2A/O(CB466W00200)

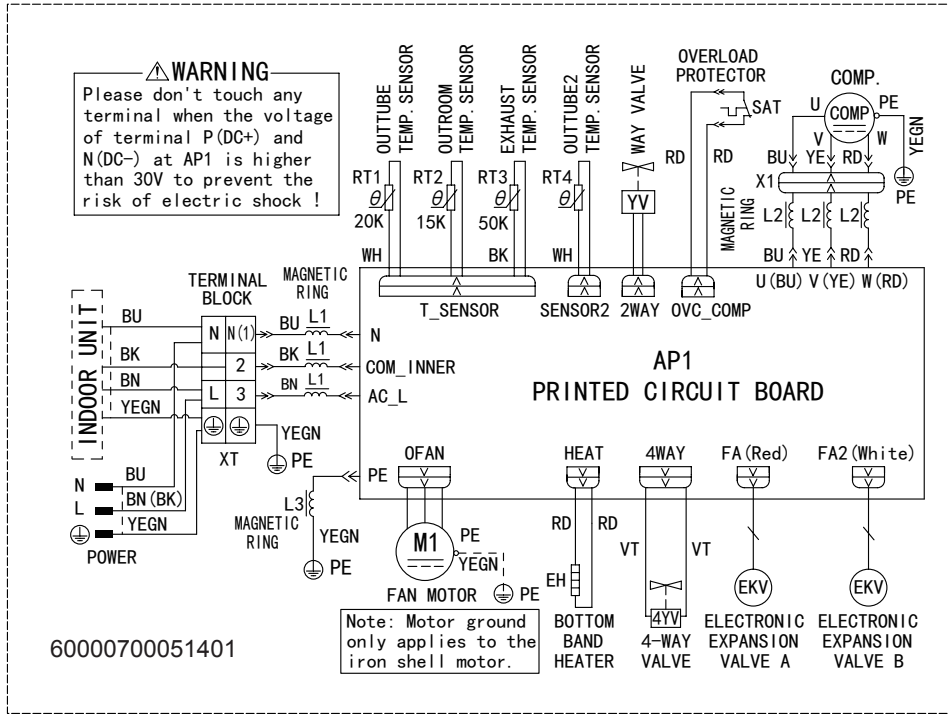

GWH09YD-S6DBA2A/O(CB466W00100)

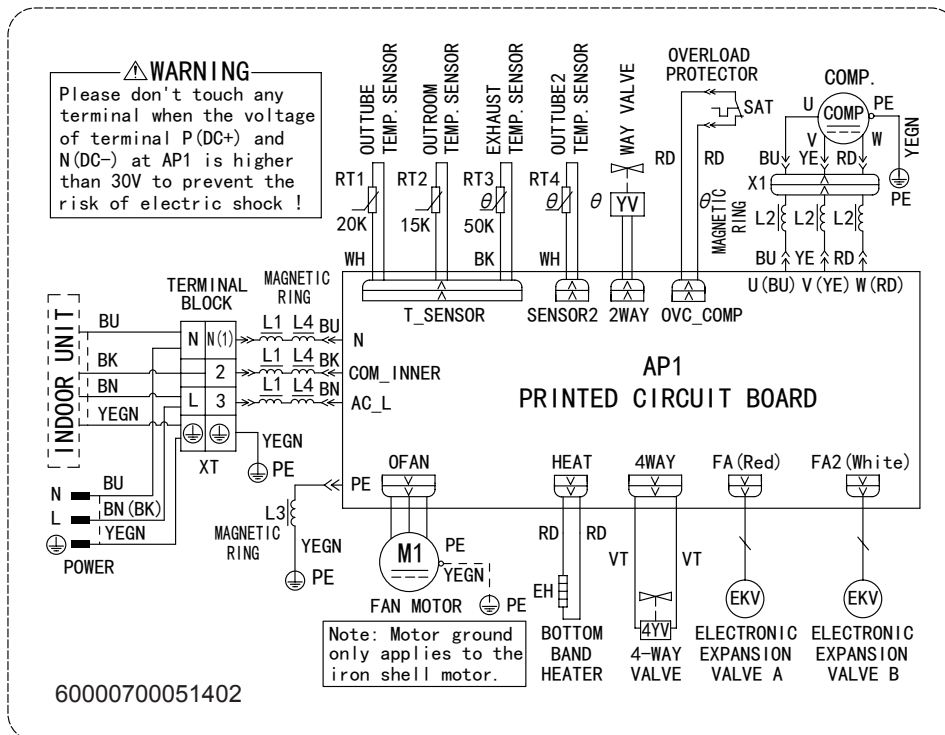

These wiring diagrams are subject to change without notice; please refer to the one supplied with the unit.

## 5.2 PCB Printed Diagram

### • Indoor Unit

#### • Top view

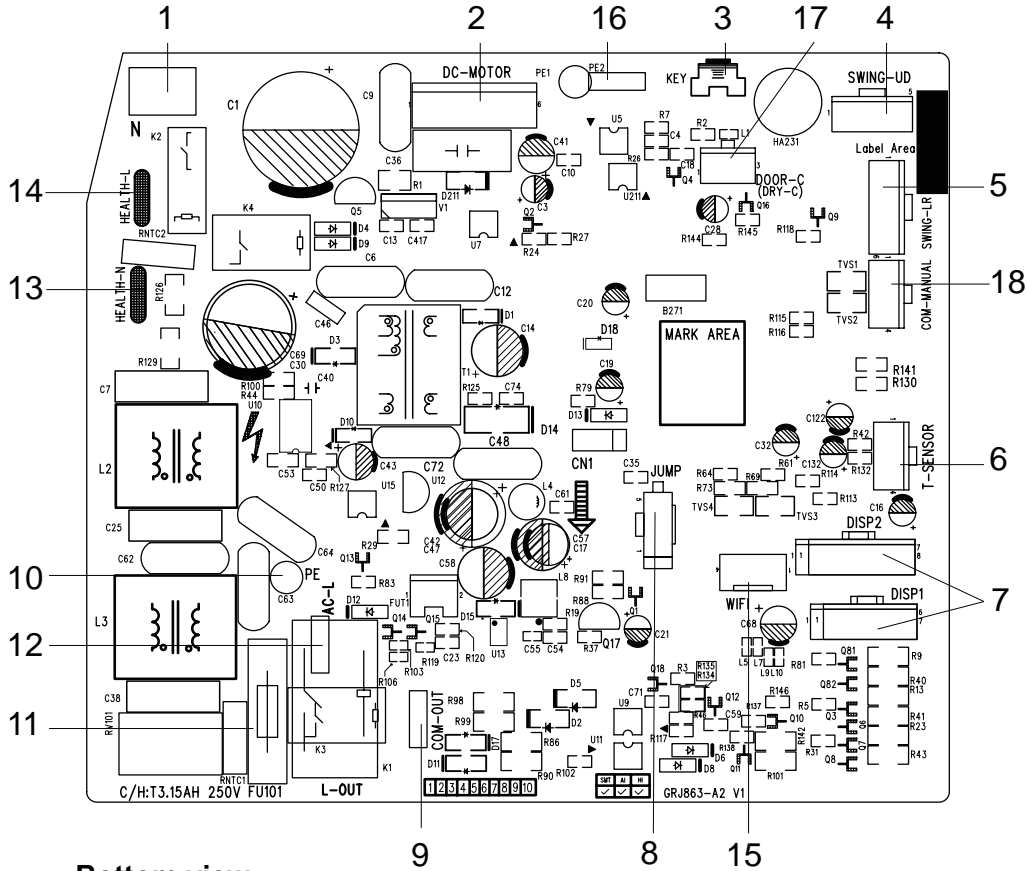

No.	Name
1	Neutral wire
2	Needle stand for indoor fan
3	Auto button
4	Up&down swing motor
5	left&right swing motor
6	Interface of temperature sensor
7	Terminal for display board connection
8	Terminal of jumper cap
9	Communication wire
10	Connect earthing wire(only for the mode with this function)
11	Fuse
12	Live wire interface
13	Interface of health function neutral wire
14	Interface of health function live wire
15	Detecting plate(WIFI )
16	Connect earthing wire(only for the mode with this function)
17	Interface of gate control (only for the mode with this function)
18	Wired controller (only for the mode with this function)

#### • Bottom view

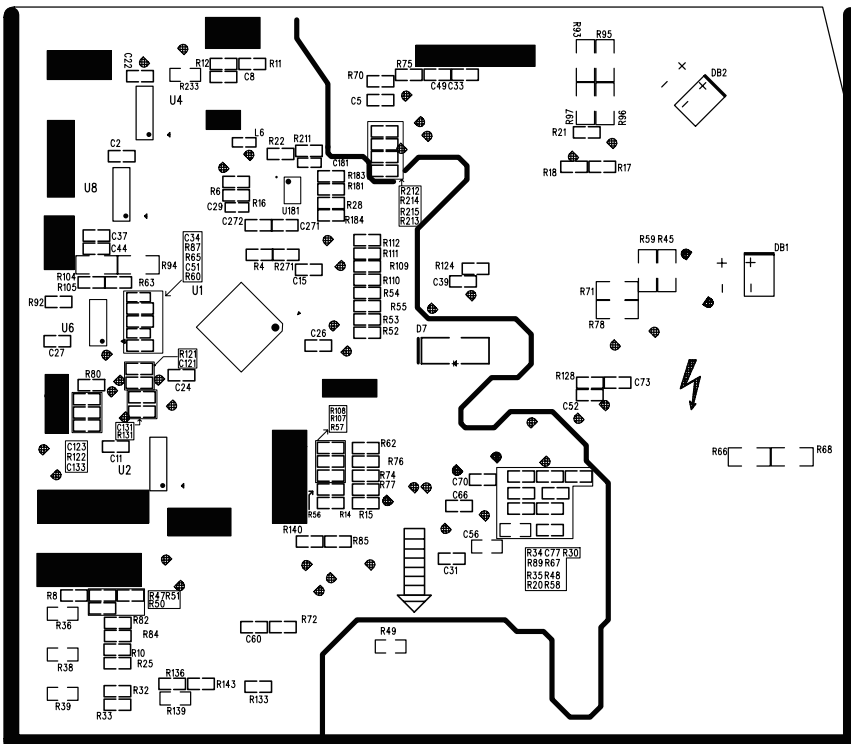



## 6. Function and Control

### 6.1 Remote Controller Introduction

#### Buttons on Remote Controller

YAG1FB

When the mode is selected in a sequence that goes from AUTO, COOL, DRY, FAN, and HEAT,

the unit will operate with heating function.



In AUTO mode, the air conditioner will operate automatically according to ex-factory setting. Set temperature can't be adjusted as well. Press "Fan" button can adjust fan speed. Press "Swing" button can adjust fan blowing angle.

In COOL mode, the air conditioner will operate under cool mode. Cool indicator "❄️" on indoor unit is ON. Press " " or " " button to adjust set temperature. Press "Fan" button to adjust fan speed. Press "Swing" button to adjust fan blowing angle.

In DRY mode, the air conditioner operates at low speed under dry mode. Dry indicator "💧" on indoor unit is ON. Under dry mode, the air conditioner will only blow fan, no cooling and no heating. All mode indicators on indoor display are OFF.

In FAN mode, the air conditioner operates under fan mode. Fan indicator "🌀" on indoor unit is ON. Press " " or " " button to adjust fan speed. Press "Swing" button to adjust fan blowing angle.

In HEAT mode, the air conditioner operates under heat mode. Heat indicator "🔥" on indoor unit is ON. Press " " or " " button to adjust set temperature. Press "Fan" button to adjust fan speed. Press "Swing" button to adjust fan blowing angle. (Cooling only unit will not operate in heat mode. If setting heat mode with remote controller, press ON/OFF button can't start up the unit).

After starting up heating mode, indoor unit will delay 1~5 minutes to blow air (actual delay time is depend on room temperature).

Temperature range from remote controller: 16~30°C ; Fan speed: auto, low speed, medium speed, high speed.

When setting Fan Speed in the sequence that goes from AUTO, [Auto], [Low], [Med], [High], then back to Auto.

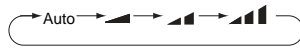

In AUTO mode, the air conditioner will select proper fan speed automatically according to ex-factory setting. The fan speed is low speed.

#### Introduction for Icons on Display Screen

In AUTO mode, set temperature is not adjustable.

Press " " or " " button to increase or decrease set temperature 1°C. Holding " " or " " button, 2s later, set temperature on remote controller will change accordingly. On releasing button after setting is finished, temperature indicator on indoor unit will change accordingly. (Temperature indicator will be displayed under auto mode)

When setting Timer On or Timer Off, press " " or " " button to adjust the time. (See TIMER Button for setting details)

Press " " or " " button to up & down swing angle.

When setting up & down swing angle. Fan blow angle can be selected circularly as below:

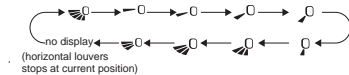

In AUTO mode, the air conditioner is blowing fan automatically. Horizontal louver will automatically swing up & down at

up & down, air conditioner is blowing fan at fixed position. Horizontal louver will stop at the fixed

up & down, air conditioner is blowing fan at fixed angle. Horizontal louver will send air at the fixed angle. Press " " or " " button 2s to set your required swing angle. When reaching your required angle, release the button.

#### Introduction for Buttons on Remote Controller

When the power is on, the air conditioner will blow fan automatically.

##### Note:

- This is a general use remote controller, it could be used for the air conditioners with multifunction; For some function, which the model don't have, if press the corresponding button on the remote controller that the unit will keep the original running status.
- After putting through the power, the air conditioner will give out a sound. Operation indicator "🔴" is ON (red indicator). After that, you can operate the air conditioner by using remote controller.
- Under on status, pressing the button on the remote controller, the signal icon "📶" on the display of remote controller will blink once and the air conditioner will give out a "de" sound, which means the signal has been sent to the air conditioner.
- Under off status, set temperature and clock icon will be displayed on the display of remote controller (If timer on, timer off and light functions are set, the corresponding icons will be displayed on the display of remote controller at the same time); Under on status, the display will show the corresponding set function icons.

##### 1. ON/OFF button

Press this button, the unit will be turned on, press it once more, the unit will be turned off. Sleep function will be canceled, while unit off.

## 2. FAN button

Press this button, Auto, Low, Medium-low, Medium, Medium-high, High speed can be circularly selected. After powered on, Auto fan speed is default. Under DRY mode, Low fan speed only can be set up.



Note: It's Low fan speed under Dry mode.

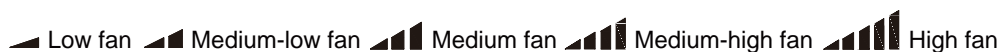

## 3. MODE button

Press this button, Auto, Cool, Dry, Fan, Heat mode can be selected circularly. Auto mode is default while power on. Under Auto mode, the temperature will not be displayed; Under Heat mode, the initial value is 28°C(82°F); Under other modes, the initial value is 25°C(77°F).

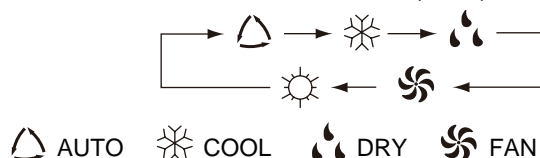

(only for cooling and heating unit. As for cooling only unit, it won't have any action when it receives the signal of heating operation.)

## 4. +/- button

- Presetting temperature can be increased.

Press this button, the temperature can be set up, continuously press this button and hold for two seconds, the relative contents can quickly change, until unhold this button and send the order that the °C(°F) signal will be displayed all the time. The temperature adjustment is unavailable under the Auto mode, but the order can be sent by if pressing this button. Temperature of Celsius degree setting: 16-30; for Fahrenheit degree setting: 61-86.

- Presetting temperature can be decreased.

Press this button, the temperature can be set up, continuously press this button and hold for two seconds, the relative contents can quickly change, until unhold this button and send the order that the °C(°F) signal will be displayed all the time. The temperature adjustment is unavailable under the Auto mode, but the order can be sent by if pressing this button.

## 5. TURBO button

Under Cool or Heat mode, press this button can turn on or turn off the Turbo function. After the Turbo function turned on, the signal of Turbo will display. The signal will be automatically cancelled if changing the mode or fan speed.

## 6. button

Press this button to set left & right swing angle cycling as below:

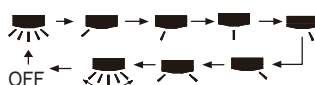

## 7. button

Press this button to set swing angle, which circularly changes as below:







This remote controller is universal. If it receives three kinds of following status, the swing angle will remain original.



If guide louver is stopped when it is swinging up and down, it will remain its present position.

 indicates guide louver swings back and forth in the five places, as shown in the figure.

## 8. CLOCK button

Press this button, the clock can be set up, signal  blink and display. Within 5 seconds, the value can be adjusted by pressing + or - button, if continuously press this button for 2 seconds above, in every 0.5 seconds, the value on ten place of Minute will be increased 1. During blinking, repress the Clock button or Confirm button, signal  will be constantly displayed and it denotes the setting succeeded. After powered on, 12:00 is defaulted to display and signal  will be displayed. If there is signal  be displayed that denotes the current time value is Clock value, otherwise is Timer value.

## 9. TIMER ON/TIMER OFF button

- Timer On setting: Signal "ON" will blink and display, signal  will conceal, the numerical section will become the timer on setting status. During 5 seconds blink, by pressing + or - button to adjust the time value of numerical section, every press of that button, the value will be increased or decreased 1 minute. Hold pressing + or - button, 2 seconds later, it quickly change, the way of change is: During the initial 2.5 seconds, ten numbers change in the one place of minute, then the one place is constant, ten numbers change in the ten splace of minute at 2.5 seconds speed and carry. During 5s blink, press the Timer button, the timer setting succeeds. The Timer On has been set up, repress the timer button, the Timer On will be canceled. Before setting the Timer, please adjust the Clock to the current actual time.

- One press this key to enter into TIMER OFF setup, in which case the TIMER OFF icon will blink. The method of setting is the same as for TIMER ON.

### 10. TEMP button

Press this button, you can see indoor set temperature, indoor ambient temperature or outdoor ambient temperature on indoor unit's display. The setting on remote controller is selected circularly as below:



When selecting "🏠" with remote controller or no display, temperature indicator on indoor unit displays set temperature; When selecting "🏠↓" with remote controller, temperature indicator on indoor unit displays indoor ambient temperature; When selecting "🏠↑" with remote controller, temperature indicator on indoor unit displays outdoor ambient temperature. 3s later it will return to the setting temperature or it depends on the other received signal within 3s.

Attention: When displaying the outdoor ambient, the displaying range is 32-99°F and 0-60°C. When it goes beyond the range, it keeps the threshold data (the smallest—0°C or 32°F and the largest 99°F or 60°C).

Warm tips: When operating buttons on the cover please make sure the cover is closed completely.

### 11. 🏠 / 🏠 button (This function is only available for some models)

Press this button to achieve the on and off of healthy and scavenging functions in operation status. Press this button for the first time to start scavenging function; LCD displays "🏠". Press the button for the second time to start healthy and scavenging functions simultaneously; LCD displays "🏠" and "🌿". Press this button for the third time to quit healthy and scavenging functions simultaneously. Press the button for the fourth time to start healthy function; LCD display "🌿". Press this button again to repeat the operation above.

### 12. I FEEL button

Press this button once, to turn on the I FEEL function, then the figure of "I FEEL" will be displayed, after every press of other function button, every 200ms to send I FEEL once, after this function started, the remote control will send temperature to the main unit in every 10 minutes. When repress this button, this function will be turned off.

### 13. LIGHT button

Press this button at unit On or Off status, Light On and Light Off can be set up. After powered on, Light On is defaulted.

### 14. X-FAN button

Pressing X-FAN button in COOL or DRY mode, the icon 🌀 is displayed and the indoor fan will continue operation for 2 minutes in order to dry the indoor unit even though you have turned off the unit. After energization, X-FAN OFF is defaulted. X-FAN is not available in AUTO, FAN or HEAT mode.

### 15. QUIET button

Press this button, the Quiet status is under the Auto Quiet mode (display "🔇" and "Auto" signal) and Quiet mode (display "🔇" signal) and Quiet OFF (there is no signal of "🔇" displayed), after powered on, the Quiet OFF is defaulted. Under the Quiet mode (Display "🔇" signal), the fan speed is not available.

### 16. SLEEP button

- Press this button, can select Sleep 1 (🌙<sup>1</sup>), Sleep 2 (🌙<sup>2</sup>), Sleep 3 (🌙<sup>3</sup>) and cancel the Sleep, circulate between these, after electrified, Sleep Cancel is defaulted.
- Sleep 1 is Sleep mode 1, in Cool, Dehumidify modes: sleep status after run for one hour, the main unit setting temperature will increase 1°C (1°F~2°F), 2 hours, setting temperature increased 2°C (3°F~4°F), the unit will run at this setting temperature; In Heat mode: sleep status after run for one hour, the setting temperature will decrease 1°C (1°F~2°F), 2 hours, setting temperature will decrease 2°C (3°F~4°F), then the unit will run at this setting temperature.
- Sleep 2 is sleep mode 2, that is air conditioner will run according to the presetting a group of sleep temperature curve.

In Cool mode:

- (1) When setting the initial temperature 16~23°C (61°F~74°F), after turned on Sleep function, the temperature will be increased 1°C (1°F~2°F) in every hour, after 3°C (5°F~6°F) the temperature will be maintained, after 7 hours, the temperature will be decreased 1°C (1°F~2°F), after that the unit will keep on running under this temperature;
- (2) When setting the initial temperature 24~27°C (75°F~81°F), after turned on Sleep function, the temperature will be increased 1°C (1°F~2°F) in every hour, after 2°C (3°F~4°F) the temperature will be maintained, after 7 hours, the temperature will be decreased 1°C (1°F~2°F), after that the unit will keep on running under this temperature;
- (3) When setting the initial temperature 28~29°C (82°F~85°F), after turned on Sleep function, the temperature will be increased 1°C (1°F~2°F) in every hour, after 1°C (1°F~2°F) the temperature will be maintained, after 7 hours, the temperature will be decreased 1°C (1°F~2°F), after that the unit will keep on running under this temperature;
- (4) When setting the initial temperature 30°C (86°F), under this temperature setting, after 7 hours, the temperature will be decreased 1°C (1°F~2°F), after that the unit will keep on running under this temperature;

In Heat mode:

- (1) Under the initial presetting temperature 16°C (61°F), it will run under this setting temperature all along.
- (2) Under the initial presetting temperature 17~20°C (62°F~68°F), after Sleep function started up, the temperature will decrease 1°C (1°F~2°F) in every hour, after 1°C (1°F~2°F) decreased, this temperature will be maintained.
- (3) Under the initial presetting temperature 21~27°C (69°F~81°F), after Sleep function started up, the temperature will decrease 1°C (1°F~2°F) in every hour, after 2°C (3°F~4°F) decreased, this temperature will be maintained.
- (4) Under the initial presetting temperature 28~30°C (82°F~86°F), after Sleep function started up, the temperature will decrease 1°C (1°F~2°F) in every hour, after 3°C (5°F~6°F) decreased, this temperature will be maintained.



●Sleep 3- the sleep curve setting under Sleep mode by DIY:

- (1) Under Sleep 3 mode, press "Turbo" button for a long time, remote control enters into user individuation sleep setting status, at this time, the time of remote control will display "1hour ", the setting temperature "88" will display the corresponding temperature of last setting sleep curve and blink (The first entering will display according to the initial curve setting value of original factory);
- (2) Adjust "+" and "-" button, could change the corresponding setting temperature, after adjusted, press "Trubo "button for confirmation;
- (3) At this time, 1hour will be automatically increased at the timer position on the remote control, (that are "2hours" or "3hours" or "8hours "), the place of setting temperature "88" will display the corresponding temperature of last setting sleep curve and blink;
- (4) Repeat the above step (2)~(3) operation, until 8hours temperature setting finished, sleep curve setting finished, at this time, the remote control will resume the original timer display;temperature display will resume to original setting temperature.

●Sleep3- the sleep curve setting under Sleep mode by DIY could be inquired:

The user could accord to sleep curve setting method to inquire the presetting sleep curve, enter into user individuation sleep setting status, but do not change the temperature, press "Turbo" button directly for confirmation.

Note: In the above presetting or enquiry procedure, if continuously within10s, there is no button pressed, the sleep curve setting status will be automatically quit and resume to display the original displaying. In the presetting or enquiry procedure, press "ON/OFF" button, "Mode" button, "Timer" button or "Sleep" button, the sleep curve setting or enquiry status will quit similarly.

#### 17. About X-FAN function

This function indicates that moisture on evaporator of indoor unit will be blown after the unit is stopped to avoid mould.

- (1)Having set X-FAN function on: After turning off the unit by pressing ON/OFF button indoor fan will continue running for about 2 min. at low speed. In this period, press X-FAN button to stop indoor fan directly.
- (2)Having set X-FAN function off: After turning off the unit by pressing ON/OFF button, the complete unit will be off directly.

#### 18. About AUTO RUN

When AUTO RUN mode is selected, the setting temperature will not be displayed on the LCD, the unit will be in accordance with the room temp. automatically to select the suitable running method and to make ambient comfortable.



#### 19. About turbo function

If start this function, the unit will run at super-high fan speed to cool or heat quickly so that the ambient temp. approaches the preset temp. as soon as possible.



#### 20. About lock

Press + and - buttons simultaneously to lock or unlock the keyboard. If the remote controller is locked, the icon  will be displayed on it, in which case, press any button, the mark will flicker for three times. If the keyboard is unlocked, the mark will disappear.

#### 21. About swing up and down

- (1)Press swing up and down button continuously more than 2s,the main unit will swing back and forth from up to down, and then loosen the button, the unit will stop swinging and present position of guide louver will be kept immediately.
- (2)Under swing up and down mode, when the status is switched from off to , if press this button again 2s later,  status will switch to off status directly; if press this button again within 2s,the change of swing status will also depend on the circulation sequence stated above.

#### 22. About swing left and right

- (1)Press swing left and right button continuously more than 2s,the main unit will swing back and forth from left to right, and then loosen the button, the unit will stop swinging and present position of guide louver will be kept immediately.
- (2)Under swing left and right mode, when the status is switched from off to , if press this button again 2s later,  status will switch to off status directly; if press this button again within 2s,the change of swing status will also depend on the circulation sequence stated above.

#### 23. About switch between Fahrenheit and Centigrade

Under status of unit off, press MODE and - buttons simultaneously to switch °C and °F.

#### 24. Combination of "TEMP" and "CLOCK" buttons : About Energy-saving Function

Press "TEMP" and "CLOCK" simultaneously in COOL mode to start energy-saving function.Nixie tube on the remote controller displays "SE". Repeat the operation to quit the function.

#### 25. Combination of "TEMP" and "CLOCK" buttons : About 8°C(46°F) Heating Function

Press "TEMP" and "CLOCK" simultaneously in HEAT mode to start 8°C(46°F) Heating Function.Nixie tube on the remote controller displays "S" and a selected temperature of "8°C" (46°F if Fahrenheit is adopted). Repeat the operation to quit the function.

#### 26. About Auto Quiet function

When auto quiet function is selected:

- (1)Under cooling mode: indoor fan operates at notch 4 speed. 10 minutes later or when indoor ambient temperature $\leq$ 28°C(82°F), indoor fan will operate at notch 2 speed or quiet mode according to the comparison between indoor ambient temperature and set temperature.
- (2)Under heating mode: indoor fan operates at notch 3 speed or quiet mode according to the comparison between indoor ambient temperature and set temperature.
- (3)Under dry, fan mode: indoor fan operates at quiet mode.
- (4)Under auto mode: the indoor fan operates at the auto quiet mode according to actual cooling, heating or fan mode.

#### 27. About Sleep function

Under the Fan and Auto mode, the Sleep function cannot be set up, under Dehumidify mode, only Sleep 1 can be selected.Select and enter into any kind of Sleep mode, the Quiet function will be attached and started, different Quiet status could be optional and turned off.

## 28.WIFI Function

Press "MODE" and "TURBO" button simultaneously to turn on or turn off WIFI function. When WIFI function is turned on, the "WiFi" icon will be displayed on remote controller; Long press "MODE" and "TURBO" buttons simultaneously for 10s, remote controller will send WIFI reset code and then the WIFI function will be turned on. WIFI function is defaulted ON after energization of the remote controller.(This function only applicable for some models. )

### Operation Guide

#### 1. General operation

- (1)After powered on, press ON/OFF button, the unit will start to run. (Note: When it is powered on, the guide louver of main unit will close automatically.)
- (2)Press MODE button, select desired running mode.
- (3)Pressing + or - button, to set the desired temperature (It is unnecessary to set the temp. at AUTO mode.)
- (4)Pressing FAN button, set fan speed, can select AUTO FAN,LOW, MEDIUM-LOW, MEDIUM, MEDIUM-HIGH and HIGH.
- (5)Pressing and button, to select the swing.

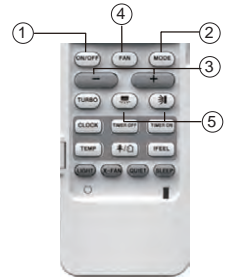

#### 2. Optional operation

- (1)Press SLEEP button, to set sleep.
- (2)Press TIMER ON and TIMER OFF button, can set the scheduled timer on or timer off.
- (3)Press LIGHT button, to control the on and off of the displaying part of the unit (This function may be not available for some units).
- (4)Press TURBO button, can realize the ON and OFF of TURBO function.

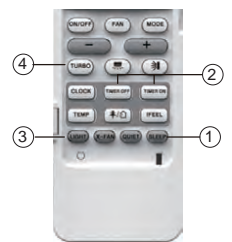

### Replacement of Batteries in Remote Controller

1. Press the back side of remote controller marked with "🔋", as shown in the fig, and then push out the cover of battery box along the arrow direction.
2. Replace two 7# (AAA 1.5V) dry batteries, and make sure the position of "+" polar and "-" polar are correct.
3. Reinstall the cover of battery box.

Note:

- During operation, point the remote control signal sender at the receiving window on indoor unit.
- The distance between signal sender and receiving window should be no more than 8m, and there should be no obstacles between them.
- Signal may be interfered easily in the room where there is fluorescent lamp or wireless telephone; remote controller should be close to indoor unit during operation.
- Replace new batteries of the same model when replacement is required.
- When you don't use remote controller for a long time, please take out the batteries.
- If the display on remote controller is fuzzy or there's no display, please replace batteries.

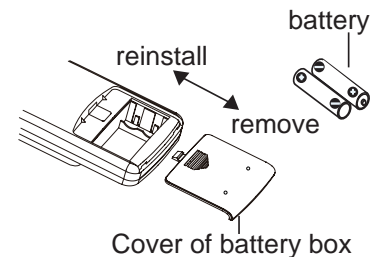



## Buttons on Remote Controller

YAG1FB3(WiFi)

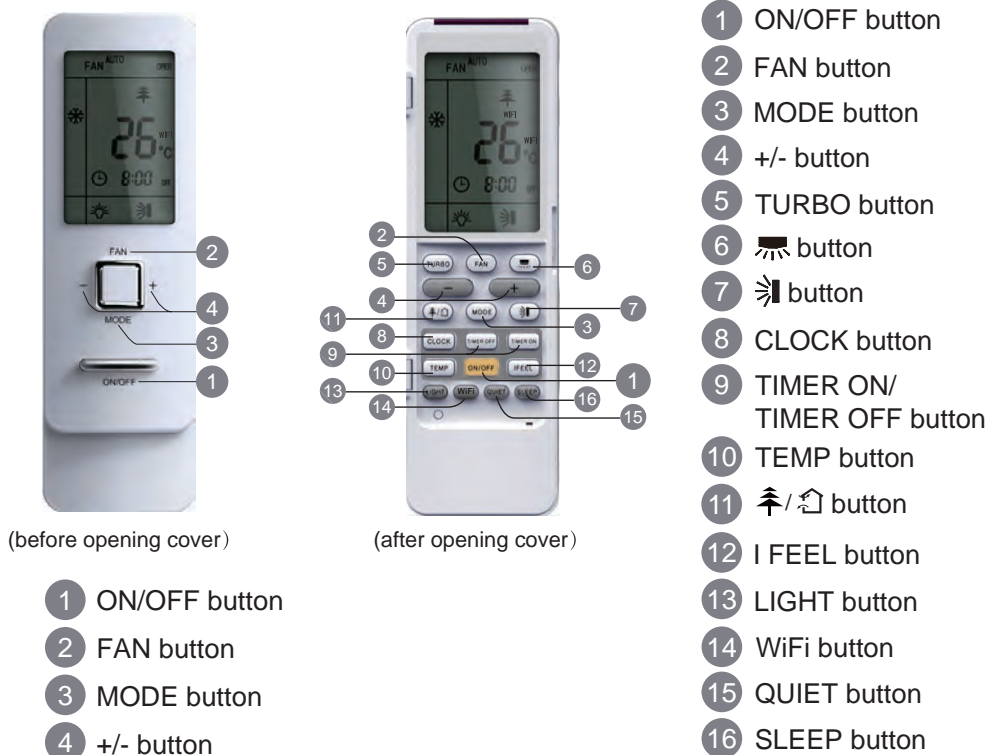

## Introduction for Icons on Display Screen

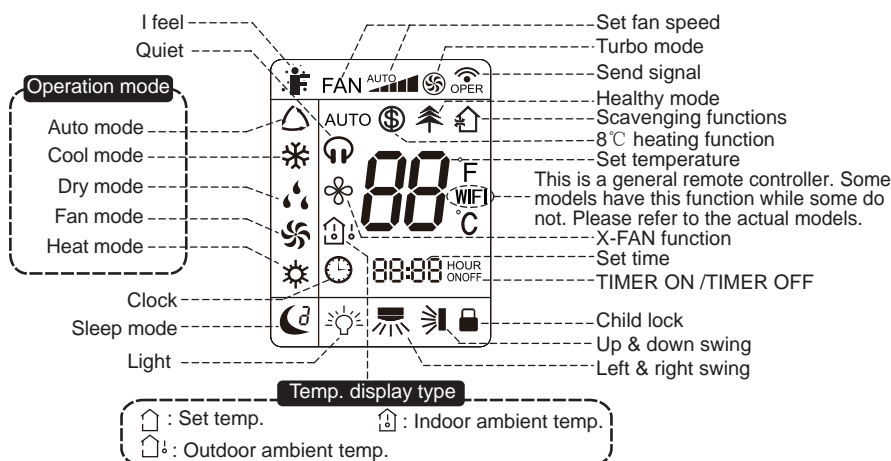

## Introduction for Buttons on Remote Controller

### Note:

- This is a general use remote controller, it could be used for the air conditioners with multifunction; For some function, which that model doesn't have, if press the corresponding button on the remote controller that the unit will keep the original running status.
- After putting through the power, the air conditioner will give out a sound. Operation indicator " " is ON (red indicator). After that operate the air conditioner by using remote controller.
- Under on status, pressing the button on the remote controller, the signal icon " " on the display of remote controller will blink the air conditioner will give out a "de" sound, which means the signal has been sent to the air conditioner.
- Under off status, set temperature and clock icon will be displayed on the display of remote controller (If timer on, timer off and functions are set, the corresponding icons will be displayed on the display of remote controller at the same time); Under on status display will show the corresponding set function icons.

### 1. ON/OFF button

Press this button, the unit will be turned on, press it once more, the unit will be turned off. Sleep function will be canceled, while

## 2. FAN button

Press this button, Auto, Low, Medium-low, Medium, Medium-high, High speed can be circularly selected. After powered on, Auto fan speed is default. Under DRY mode, Low fan speed only can be set up.

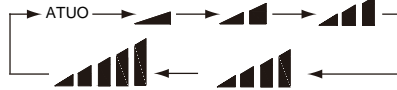

▲ Low fan ▲▲ Medium-low fan ▲▲▲ Medium fan ▲▲▲▲ Medium-high fan ▲▲▲▲▲ High fan

### Note:

It's Low fan speed under Dry mode.

X-FAN function: Hold fan speed button for 2s in COOL or DRY mode, the icon “” is displayed and the indoor fan will continue operation for a few minutes in order to dry the indoor unit even though you have turned off the unit. After energization, X-FAN OFF is defaulted. X-FAN is not available in AUTO, FAN or HEAT mode.

This function indicates that moisture on evaporator of indoor unit will be blown after the unit is stopped to avoid mould.

Having set X-FAN function on: After turning off the unit by pressing ON/OFF button indoor fan will continue running for a few minutes. at low speed. In this period, Hold fan speed button for 2s to stop indoor fan directly.

Having set X-FAN function off: After turning off the unit by pressing ON/OFF button, the complete unit will be off directly.

## 3. MODE button

Press this button, Auto, Cool, Dry, Fan, Heat mode can be selected circularly. Auto mode is default while power on. Under Auto mode, the temperature will not be displayed; Under Heat mode, the initial value is 28°C( 82°F); Under other modes, the initial value is 25°C(77°F).

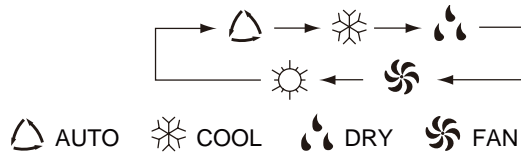

(only for cooling and heating unit. As for cooling only unit, it won't have any action when it receives the signal of heating operation.)

## 4. +/- button

Press " + " or " - " button once increase or decrease set temperature 1°C(°F). Holding " + " or " - " button, set temperature on remote controller will change quickly. On releasing button after setting is finished, temperature indicator on indoor unit will change accordingly. When setting TIMER ON, TIMER OFF or CLOCK, press " + " or " - " button to adjust time. (Refer to CLOCK, TIMER ON, TIMER OFF buttons) When setting TIMER ON, TIMER OFF or CLOCK, press " + " or " - " button to adjust time. (Refer to CLOCK, TIMER ON, TIMER OFF buttons)

## 5. TURBO button

Under Cool or Heat mode, press this button can turn on or turn off the Turbo function. After the Turbo function turned on, the signal of Turbo will display. The signal will be automatically cancelled if changing the mode or fan speed.

## 6. button

Press this button to set left & right swing angle cycling as below:

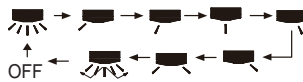

## 7. button

Press this button to set swing angle, which circularly changes as below:







This remote controller is universal. If it receives three kinds of following status, the swing angle will remain original.



If guide louver is stopped when it is swinging up and down, it will remain its present position.

 indicates guide louver swings back and forth in the five places, as shown in the figure.

## 8. CLOCK button

Press this button, the clock can be set up, signal  blink and display. Within 5 seconds, the value can be adjusted by pressing + or - button, if continuously press this button for 2 seconds above, in every 0.5 seconds, the value on ten place of Minute will be increased 1. During blinking, repress the Clock button or Confirm button, signal  will be constantly displayed and it denotes the setting succeeded. After powered on, 12:00 is defaulted to display and signal  will be displayed. If there is signal  be displayed that denotes the current time value is Clock value, otherwise is Timer value.



### 9. TIMER ON/TIMER OFF button

- Timer On setting: Signal "ON" will blink and display, signal  will conceal, the numerical section will become the timer on setting status. During 5 seconds blink, by pressing + or - button to adjust the time value of numerical section, every press of that button, the value will be increased or decreased 1 minute. Hold pressing + or - button, 2 seconds later, it quickly change, the way of change is: During the initial 2.5 seconds, ten numbers change in the one place of minute, then the one place is constant, ten numbers change in the ten space of minute at 2.5 seconds speed and carry. During 5s blink, press the Timer button, the timer setting succeeds. The Timer On has been set up, repress the timer button, the Timer On will be canceled. Before setting the Timer, please adjust the Clock to the current actual time.
- One press this key to enter into TIMER OFF setup, in which case the TIMER OFF icon will blink. The method of setting is the same as for TIMER ON.

### 10. TEMP button

Press this button, you can see indoor set temperature, indoor ambient temperature or outdoor ambient temperature on indoor unit's display. The setting on remote controller is selected circularly as below:



When selecting "  " with remote controller or no display, temperature indicator on indoor unit displays set temperature; When selecting "  " with remote controller, temperature indicator on indoor unit displays indoor ambient temperature; When selecting "  " with remote controller, temperature indicator on indoor unit displays outdoor ambient temperature. 3s later it will return to the setting temperature or it depends on the other received signal within 3s.





Attention: When displaying the outdoor ambient, the displaying range is 32-99°F and 0-60°C. When it goes beyond the range, it keeps the threshold data (the smallest—0°C or 32°F and the largest 99°F or 60°C).

Warm tips: When operating buttons on the cover please make sure the cover is closed completely.

Note:

Outdoor temperature display is not available for some models. At that time, indoor unit receives "  " signal, while it displays indoor set temperature.

### 11. / button (This function is only available for some models)

Press this button to achieve the on and off of healthy and scavenging functions in operation status. Press this button for the first time to start scavenging function; LCD displays "  ". Press the button for the second time to start healthy and scavenging functions simultaneously; LCD displays "  " and "  ". Press this button for the third time to quit healthy and scavenging functions simultaneously. Press the button for the fourth time to start healthy function; LCD display "  ". Press this button again to repeat the operation above.

### 12. I FEEL button

Press this button once, to turn on the I FEEL function, then the figure of "I FEEL" will be displayed, after every press of other function button, every 200ms to send I FEEL once, after this function started, the remote controller will send temperature to the main unit in every 10 minutes. When repress this button, this function will be turned off. When I FEEL function is turned on, the remote controller should be put within the area where indoor unit can receive the signal sent by the remote controller.

### 13. LIGHT button





Press this button at unit On or Off status, Light On and Light Off can be set up. After powered on, Light On is defaulted.

### 14. WiFi button

Press " WiFi " button to turn on or turn off WiFi function. When WiFi function is turned on, the " WiFi " icon will be displayed on remote controller; Under status of remote controller off, press "MODE" and " WiFi " buttons simultaneously for 1s, WiFi module will restore to factory default setting.

- This function is only available for some models.

### 15. QUIET button

Press this button, the Quiet status is under the Auto Quiet mode (display "  " and "Auto" signal) and Quiet mode (display "  " signal) and Quiet OFF (there is no signal of "  " displayed), after powered on, the Quiet OFF is defaulted. Under the Quiet mode (Display "  " signal).

The Quiet function is only available for some models.

### 16. SLEEP button

Press this button, can select Sleep 1 (  ), Sleep 2 (  ), Sleep 3 (  ) and cancel the Sleep, circulate between these, after electrified, Sleep Cancel is de-faulted.

Sleep 1 is Sleep mode 1, in Cool modes: sleep status after run for one hour, the main unit setting temperature will increase 1°C, 2 hours, setting temperature increased 2°C, the unit will run at this setting temperature; In Heat mode: sleep status after run for one hour, the setting temperature will decrease 1°C, 2 hours, setting temperature will decrease 2°C, then the unit will run at this setting temperature.

Sleep 2 is sleep mode 2, that is air conditioner will run according to the presetting a group of sleep temperature curve.

In Cool mode:

- (1) When setting the initial temperature 16°C-23°C, after turned on Sleep function, the temperature will be increased 1°C in every hour, after 3°C the temperature will be maintained, after 7 hours, the temperature will be decreased 1°C, after that the unit will keep on running under this temperature;
- (2) When setting the initial temperature 24°C-27°C, after turned on Sleep function, the temperature will be increased 1°C in every hour, after 2°C the temperature will be maintained, after 7 hours, the temperature will be decreased 1°C, after that the unit will keep on running under this temperature;
- (3) When setting the initial temperature 28°C-29°C, after turned on Sleep function, the temperature will be increased 1°C in every hour, after 1°C the temperature will be maintained, after 7 hours, the temperature will be decreased 1°C, after that the unit will keep on running under this temperature;

(4) When setting the initial temperature 30 °C, under this temperature setting, after 7 hours, the temperature will be decreased 1 °C, after that the unit will keep on running under this temperature;

In Heat mode:

(1) Under the initial presetting temperature 16 °C, it will run under this setting temperature all along.

(2) Under the initial presetting temperature 17 °C-20 °C, after Sleep function started up, the temperature will decrease 1 °C in every hour, after 1 °C decreased, this temperature will be maintained.

(3) Under the initial presetting temperature 21 °C-27 °C, after Sleep function started up, the temperature will decrease 1 °C in every hour, after 2 °C decreased, this temperature will be maintained.

(4) Under the initial presetting temperature 28 °C-30 °C, after Sleep function started up, the temperature will decrease 1 °C in every hour, after 3 °C decreased, this temperature will be maintained.

Sleep 3 - the sleep curve setting under Sleep mode by DIY:

(1) Under Sleep 3 mode, press "Turbo" button for a long time, remote controller enters into user individualization sleep setting status, at this time, the time of remote controller will display "1 hour", the setting temperature "88" will display the corresponding temperature of last setting sleep curve and blink (The first entering will display according to the initial curve setting value of original factory);

2) Adjust "+" and "-" button, could change the corresponding setting temperature, after adjusted, press "Turbo" button for confirmation;

(3) At this time, 1 hour will be automatically increased at the timer position on the remote controller, (that are "2 hours" or "3 hours" or "8 hours"), the place of setting temperature "88" will display the corresponding temperature of last setting sleep curve and blink;

(4) Repeat the above step (2)~(3) operation, until 8 hours temperature setting finished, sleep curve setting finished, at this time, the remote controller will resume the original timer display; temperature display will resume to original setting temperature.

Sleep 3 - the sleep curve setting under Sleep mode by DIY could be inquired: The user could accord to sleep curve setting method to inquire the presetting sleep curve, enter into user individualization sleep setting status, but do not change the temperature, press "Turbo" button directly for confirmation.

Note: In the above presetting or enquiry procedure, if continuously within 10s, there is no button pressed, the sleep curve setting status will be automatically quit and resume to display the original displaying. In the presetting or enquiry procedure, press "ON/OFF" button, "Mode" button, "Timer" button or "Sleep" button, the sleep curve setting or enquiry status will quit similarly.

## Introduction for special function

### About AUTO RUN

When AUTO RUN mode is selected, the unit will be in accordance with the room temp. automatically to select the suitable running method and to make ambient comfortable.

### About turbo function



If start this function, the unit will run at super-high fan speed to cool or heat quickly so that the ambient temp. approaches the preset temp. as soon as possible.

### About lock



Press + and - buttons simultaneously to lock or unlock the keyboard. If the remote controller is locked, the icon  will be displayed on it, in which case, press any button, the mark will flicker for three times. If the keyboard is unlocked, the mark will disappear.

### About swing up and down

1. Press swing up and down button continuously more than 2s, the main unit will swing back and forth from up to down, and then loosen the button, the unit will stop swing and present position of guide louver will be kept immediately.

2. Under swing up and down mode, when the status is switched from off to , if press this button again 2s later,  status will switch to off status directly; if press this button again within 2s, the change of swing status will also depend on the circulation sequence stated above.

### About swing left and right

1. Press swing left and right button continuously more than 2s, the main unit will swing back and forth from left to right, and then loosen the button, the unit will stop swing and present position of guide louver will be kept immediately. 2. Under swing left and right mode, when the status is switched from off to , if press this button again 2s later,  status will switch to off status directly; if press this button again within 2s, the change of swing status will also depend on the circulation sequence stated above.

### About switch between Fahrenheit and Centigrade

Under status of unit off, press MODE and - buttons simultaneously to switch °C and °F.

### Combination of "TEMP" and "CLOCK" buttons: About Energy - saving Function

Press "TEMP" and "CLOCK" simultaneously in COOL mode to start energy-saving function. Nixie tube on the remote controller displays "SE". Repeat the operation to quit the function.

### Combination of "TEMP" and "CLOCK" buttons: About 8 °C Heating Function

Press "TEMP" and "CLOCK" simultaneously in HEAT mode to start 8 °C Heating Function. Nixie tube on the remote controller displays "8" and a selected temperature of "8 °C". (46 °F if Fahrenheit is adopted). Repeat the operation to quit the function.

### About Quiet function

When quiet function is selected:

1. Under cooling mode: indoor fan operates at notch 4 speed. 10 minutes later or when indoor ambient temperature 28 °C, indoor fan will operate at notch 2 speed or quiet mode according to the comparison between indoor ambient temperature and set temperature.

2. Under heating mode: indoor fan operates at notch 3 speed or quiet mode according to the comparison between indoor ambient temperature and set temperature.

3. Under dry, fan mode: indoor fan operates at quiet mode.



4. Under auto mode: the indoor fan operates at the auto quiet mode according to actual cooling, heating or fan mode.

### About Sleep function

Under the Fan, Dry and Auto mode, the Sleep function cannot be set up, Select and enter into any kind of Sleep mode, the Quiet function will be attached and started, different Quiet status could be optional and turned off.

## Operation Guide

### 1. General operation

1. After powered on, press ON/OFF button, the unit will start to run. (Note: When it is powered on, the guide louver of main unit will close automatically.)
2. Press MODE button, select desired running mode.
3. Pressing + or - button, to set the desired temperature.
4. Pressing FAN button, set fan speed, can select AUTO FAN, LOW, MEDIUM-LOW, MEDIUM, MEDIUM-HIGH and HIGH.
5. Pressing  and  button, to select the swing.

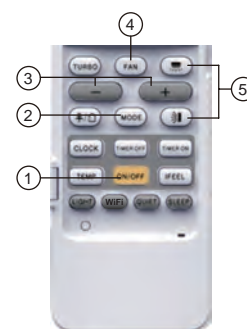

### 2. Optional operation

1. Press SLEEP button, to set sleep.
2. Press TIMER ON and TIMER OFF button, can set the scheduled timer on or timer off.
3. Press LIGHT button, to control the on and off of the displaying part of the unit (This function may be not available for some units).
4. Press TURBO button, can realize the ON and OFF of TURBO function.

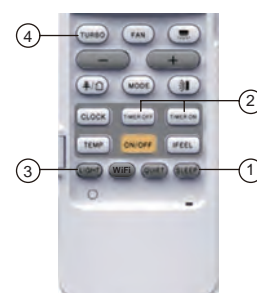

## Replacement of Batteries in Remote Controller

1. Press the back side of remote controller marked with "", as shown in the fig, and then push out the cover of battery box along the arrow direction.
2. Replace two 7# (AAA 1.5V) dry batteries, and make sure the position of "+" polar and "-" polar are correct.
3. Reinstall the cover of battery box.

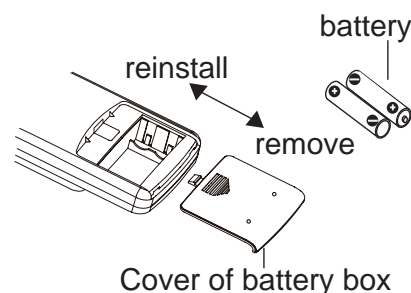

### Note:

During operation, point the remote control signal sender at the receiving window on indoor unit.  
 The distance between signal sender and receiving window should be no more than 8m, and there should be no obstacles between them.  
 Signal may be interfered easily in the room where there is fluorescent lamp or wireless telephone; remote controller should be close to indoor unit during operation.  
 Replace new batteries of the same model when replacement is required.  
 When you don't use remote controller for a long time, please take out the batteries.  
 If the display on remote controller is fuzzy or there's no display, please replace batteries.





## 6.3 Ewpe Smart App Operation Manual

### Control Flow Chart

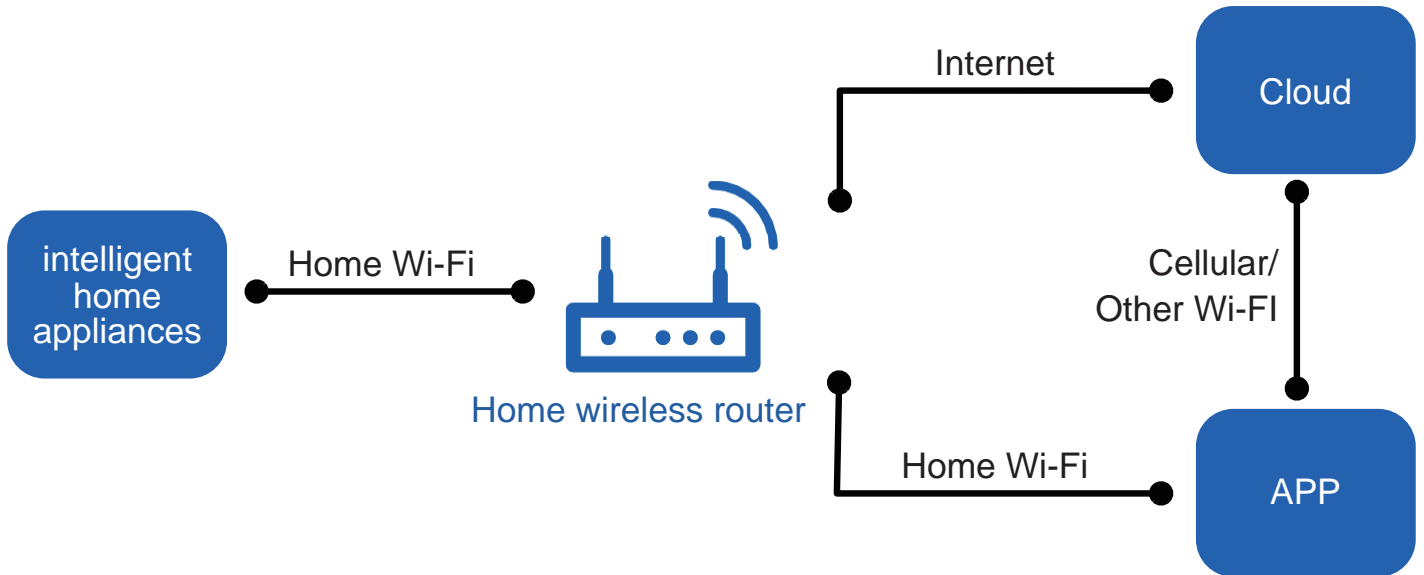

### Operating Systems

Requirement for User's smart phone:



iOS system  
Support iOS7.0 and  
above version



Android system  
Support Android 4.0 and  
above version

### Download and installation



App Download Linkage

Scan the QR code or search "Ewpe Smart" in the application market to download and install it. When "Ewpe Smart" App is installed, register the account and add the device to achieve long-distance control and LAN control of smart home appliances. For more information, please refer to "Help" in App.

## 6.4 Brief Description of Modes and Functions

### 1. Temperature Parameters

- ◆ Indoor preset temperature ( $T_{\text{preset}}$ )
- ◆ Indoor ambient temperature ( $T_{\text{amb.}}$ )

### 2. Basic Functions

Once energized, in no case should the compressor be restarted within less than 3 minutes. In the situation that memory function is available, for the first energization, if the compressor is at stop before de-energization, the compressor will be started without a 3-minute lag; if the compressor is in operation before de-energization, the compressor will be started with a 3-minute lag; and once started, the compressor will not be stopped within 6 minutes regardless of changes in room temperature.

#### (1) Cooling Mode

##### ① The condition and process of cooling

If  $T_{\text{amb.}} \geq T_{\text{preset}}$  cooling mode will act, the compressor and outdoor fan will run, and the indoor fan will run at the set speed.

If  $T_{\text{amb.}} \leq T_{\text{preset}} - 2^{\circ}\text{C}$  (3.6°F), the compressor will stop, the outdoor fan will delay 30 seconds to stop, and the indoor fan will run at the set speed.

If  $T_{\text{preset}} - 2^{\circ}\text{C}$  (3.6°F)  $< T_{\text{amb.}} < T_{\text{preset}}$ , the unit will keep running in the previous mode.

When  $0 \leq T_{\text{preset}} - T_{\text{amb.}} < 2^{\circ}\text{C}$  (3.6°F), if indoor fan speed is high, it will turn to medium fan speed; if indoor fan speed is medium or low, it will keep the same; (this condition will be valid only when the compressor is operating); if indoor fan speed is super high, it will keep the same;

When  $T_{\text{amb.}} - T_{\text{preset}} \geq 1^{\circ}\text{C}$  (1.8°F), the fan speed will return to set fan speed;

In this mode, the reversal valve will not be powered on and the temperature setting range is 16~30°C (68~86°F).

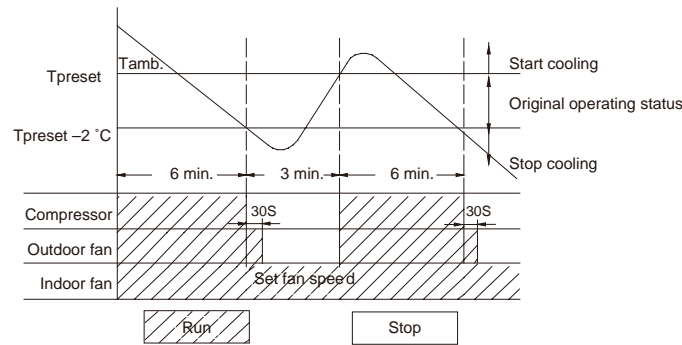

##### ② Protection function

###### ◆ Overcurrent protection

If total current is high, the compressor will run in limited frequency. If total current is too high, the compressor will stop, the outdoor fan will delay 30 seconds to stop, indoor unit will display E5 and out door yellow light will blink 5 times.

###### ◆ Antifreezing protection

When the antifreezing protection is detected, the compressor will stop, the outdoor fan will stop after 30 seconds, and the indoor fan and swing motor will keep running in the original mode. When antifreezing protection is eliminated and the compressor has stopped for 3 minutes, the compressor will resume running in the original mode.

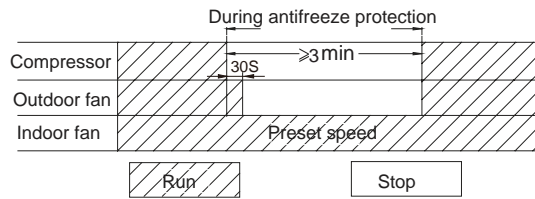

#### (2) Dehumidifying Mode

##### ① Working conditions and process of dehumidifying

If  $T_{\text{amb.}} > T_{\text{preset}}$ , the unit will enter cooling and dehumidifying mode, in which case the compressor and the outdoor fan will operate and the indoor fan will run at low speed.

If  $T_{\text{preset}} - 2^{\circ}\text{C}$  (3.6°F)  $\leq T_{\text{amb.}} \leq T_{\text{preset}}$ , the compressor remains at its original operation state.

If  $T_{\text{amb.}} < T_{\text{preset}} - 2^{\circ}\text{C}$  (3.6°F), the compressor will stop, the outdoor fan will stop with a time lag of 30s, and the indoor fan will operate at low speed.

##### ② Protection function

Protection is the same as that under the cooling mode.

#### (3) Heating Mode

##### ① The condition and process of heating

If  $T_{\text{amb.}} \leq T_{\text{preset}} + 2^{\circ}\text{C}$  (3.6°F), heating mode will act, the compressor, outdoor fan and reversal valve will run, the indoor fan will delay 3min to stop at the latest

If  $T_{\text{preset}} + 2^{\circ}\text{C}$  (3.6°F)  $< T_{\text{amb.}} < T_{\text{preset}} + 5^{\circ}\text{C}$  (9°F), the unit will keep running in the original mode.

If  $T_{\text{amb.}} \geq T_{\text{preset}} + 5^{\circ}\text{C}$  (9°F), the compressor will stop, the outdoor fan will delay 30s to stop and indoor fan will blow 60s at low speed, the fan speed cannot be shifted within blow residual heat.

◆ In this mode, the temperature setting range is 16 ~30°C (68~86°F).

◆ The air conditioner will adjust the running frequency of the compressor automatically according to the change of ambient temperature.

◆ When the unit is turned off in heating mode, or switched to other mode from heating mode, the four-way valve will be powered off after the compressor stops.



◆ When compressor is running (not including each malfunction and protection):

- a. When outdoor ambient temperature  $\geq 20^{\circ}\text{C}$  ( $68^{\circ}\text{F}$ ) and indoor fan speed is low or medium, the fan speed will turn to high; if indoor fan speed is high or super high, it will keep the same.
- b. When outdoor ambient temperature  $\leq 18^{\circ}\text{C}$  ( $64.4^{\circ}\text{F}$ ), the fan speed will resume set fan speed.
- c. When  $18^{\circ}\text{C} < \text{outdoor ambient temperature} < 20^{\circ}\text{C}$  ( $68^{\circ}\text{F}$ ), it will run at present fan speed (set fan speed or high fan speed); but when first exiting cold air prevention after entering heating mode, it will run in set fan speed.

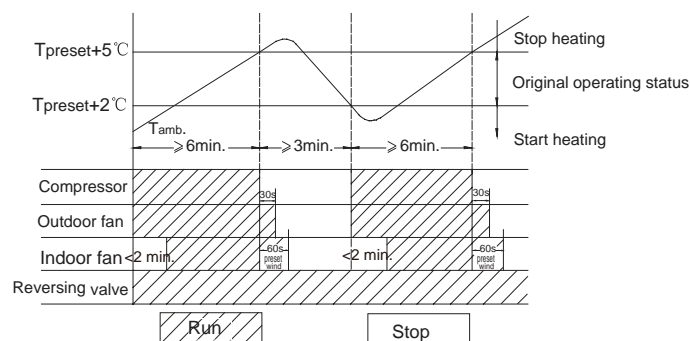

② Condition and process of defrost

When duration of successive heating operation is more than 45 minutes, or accumulated heating time more than 90 minutes, and one of the following conditions is reached, the unit will enter the defrost mode after 3 minutes.

- (1).  $T_{\text{outdoor ambient}} > 5^{\circ}\text{C}$  ( $41^{\circ}\text{F}$ ),  $T_{\text{outdoor tube}} \leq -2^{\circ}\text{C}$  ( $28.4^{\circ}\text{F}$ );
  - (2).  $-2^{\circ}\text{C} \leq T_{\text{outdoor ambient}} < 5^{\circ}\text{C}$  ( $41^{\circ}\text{F}$ ),  $T_{\text{outdoor tube}} \leq -6^{\circ}\text{C}$  ( $21.2^{\circ}\text{F}$ );
  - (3).  $-5^{\circ}\text{C} \leq T_{\text{outdoor ambient}} < -2^{\circ}\text{C}$  ( $28.4^{\circ}\text{F}$ ),  $T_{\text{outdoor tube}} \leq -8^{\circ}\text{C}$  ( $17.6^{\circ}\text{F}$ );
  - (4).  $-10^{\circ}\text{C} \leq T_{\text{outdoor ambient}} < -5^{\circ}\text{C}$  ( $23^{\circ}\text{F}$ ),  $T_{\text{outdoor tube}} - T_{\text{compensatory}} \leq (T_{\text{outdoor ambient}} - 3^{\circ}\text{C})$  ( $5.4^{\circ}\text{F}$ )
  - (5).  $T_{\text{outdoor ambient}} < -10^{\circ}\text{C}$  ( $14^{\circ}\text{F}$ ),  $T_{\text{outdoor tube}} - T_{\text{compensatory}} \leq (T_{\text{outdoor ambient}} - 3^{\circ}\text{C})$  ( $5.4^{\circ}\text{F}$ )
- (after energizing,  $T_{\text{compensatory}} = 0^{\circ}\text{C}$  ( $32^{\circ}\text{F}$ ) during the first defrosting; if it is not the first defrosting,  $T_{\text{compensatory}}$  is confirmed by  $T_{\text{outdoor tube}}$  of quitting last defrosting: a. when  $T_{\text{outdoor tube}} > 2^{\circ}\text{C}$  ( $35.6^{\circ}\text{F}$ ),  $T_{\text{compensatory}} = 0^{\circ}\text{C}$  ( $32^{\circ}\text{F}$ ); b. when  $T_{\text{outdoor tube}} \leq 2^{\circ}\text{C}$  ( $35.6^{\circ}\text{F}$ ),  $T_{\text{compensatory}} = 3^{\circ}\text{C}$  ( $37.4^{\circ}\text{F}$ ))

At that time, the indoor fan stops and the compressor stops, and after 30 seconds the outdoor fan will stop, and then after 30 seconds, the four-way valve will stop. After 30 seconds, the compressor is initiated for raising the frequency to defrost frequency. When the compressor has operated under defrost mode for 7.5 minutes, or  $T_{\text{outdoor ambient}} \geq 10^{\circ}\text{C}$ , the compressor will be converted to 46Hz operation. After 30 seconds, the compressor will stop. And after another 30 seconds, the four-way valve will be opened, and after 60 seconds, the compressor and the outdoor fan will be started, the indoor fan will run under preset cold air prevention conditions, and H1 will be displayed at temperature display area on the display panel. Defrost frequency is 85Hz.

③ Protection

◆ Cold air prevention

The unit is started under heating mode (the compressor is ON):

- ① In the case of  $T_{\text{indoor amb.}} < 24^{\circ}\text{C}$  ( $75.2^{\circ}\text{F}$ ): if  $T_{\text{tube}} \leq 40^{\circ}\text{C}$  ( $104^{\circ}\text{F}$ ) and the indoor fan is at stop state, the indoor fan will begin to run at low speed with a time lag of 2 minutes. Within 2 minutes, if  $T_{\text{tube}} > 40^{\circ}\text{C}$  ( $104^{\circ}\text{F}$ ), the indoor fan also will run at low speed; and after 1-minute operation at low speed, the indoor fan will be converted to operation at preset speed. Within 1-minute low speed operation or 2-minute nonoperation, if  $T_{\text{tube}} > 42^{\circ}\text{C}$  ( $107.6^{\circ}\text{F}$ ), the fan will run at present speed.
- ② In the case of  $T_{\text{indoor amb.}} \geq 24^{\circ}\text{C}$  ( $75.2^{\circ}\text{F}$ ): if  $T_{\text{tube}} \leq 42^{\circ}\text{C}$  ( $107.6^{\circ}\text{F}$ ), the indoor fan will run at low speed, and after one minute, the indoor fan will be converted to preset speed. Within one-minute low speed operation, if  $T_{\text{tube}} > 42^{\circ}\text{C}$  ( $107.6^{\circ}\text{F}$ ), the indoor fan will be converted to preset speed.

Note:  $T_{\text{indoor amb.}}$  indicated in ① and ② refers to, under initially heating mode, the indoor ambient temperature before the command to start the compressor is performed according to the program, or after the unit is withdrawn from defrost, the indoor ambient temperature before the defrost symbol is cleared.

(5) Fan Mode

Under the mode, the indoor fan will run at preset speed and the compressor, the outdoor fan, the four-way valve and the electric heater will stop.

Under the mode, temperature can be set within a range of  $16 \sim 30^{\circ}\text{C}$  ( $60.8 \sim 86^{\circ}\text{F}$ ).

(6) AUTO Mode

① Operation way of AUTO mode

- a. When  $T_{\text{ambient}} \geq 26^{\circ}\text{C}$  ( $78.8^{\circ}\text{F}$ ), it will run in cooling mode. The implied set temperature is  $25^{\circ}\text{C}$  ( $77^{\circ}\text{F}$ ) (note: the set temperature sending to outdoor unit is  $25^{\circ}\text{C}$  ( $77^{\circ}\text{F}$ )).
- b. For heating and cooling unit, when  $T_{\text{ambient}} \leq 22^{\circ}\text{C}$  ( $71.6^{\circ}\text{F}$ ), it will run in heating mode. The implied set temperature is  $20^{\circ}\text{C}$  ( $68^{\circ}\text{F}$ ); for cooling only unit, when  $T_{\text{ambient}} \leq 22^{\circ}\text{C}$  ( $71.6^{\circ}\text{F}$ ), it will run in fan mode and the displayed set temperature is  $25^{\circ}\text{C}$  ( $77^{\circ}\text{F}$ ).

c. For heating and cooling unit, when  $22^{\circ}\text{C}(71.6^{\circ}\text{F}) < T_{\text{indoor ambient}} < 26^{\circ}\text{C}(78.8^{\circ}\text{F})$  (for cooling only unit,  $22^{\circ}\text{C}(71.6^{\circ}\text{F}) < T_{\text{indoor ambient}} < 26^{\circ}\text{C}(78.8^{\circ}\text{F})$ ), it will keep the original running mode. If the unit is energized for the first time, it will run in fan mode.

② Protection

- a. In cooling operation, protection is the same as that under the cooling mode;
- b. In heating operation, protection is the same as that under the heating mode;
- c. When ambient temperature changes, operation mode will be converted preferentially. Once started, the compressor will remain unchanged for at least 6 minutes.

(7) Common Protection Functions and Fault Display under COOL, HEAT, DRY and AUTO Modes

① Overload protection

$T_{\text{tube}}$ : measured temperature of outdoor heat exchanger under cooling mode; and measured temperature of indoor heat exchanger under heating mode.

1) Cooling overload

- a. If  $T_{\text{tube}} \leq 52^{\circ}\text{C}(125.6^{\circ}\text{F})$ , the unit will return to its original operation state.
- b. If  $T_{\text{tube}} \geq 55^{\circ}\text{C}(131^{\circ}\text{F})$ , frequency rise is not allowed.
- c. If  $T_{\text{tube}} \geq 58^{\circ}\text{C}(136.4^{\circ}\text{F})$ , the compressor will run at reduced frequency.
- d. If  $T_{\text{tube}} \geq 62^{\circ}\text{C}(143.6^{\circ}\text{F})$ , the compressor will stop and the indoor fan will run at preset speed.

2) Heating overload

- a. If  $T_{\text{tube}} \leq 50^{\circ}\text{C}(122^{\circ}\text{F})$ , the unit will return to its original operation state.
- b. If  $T_{\text{tube}} \geq 53^{\circ}\text{C}(127.4^{\circ}\text{F})$ , frequency rise is not allowed.
- c. If  $T_{\text{tube}} \geq 56^{\circ}\text{C}(132.8^{\circ}\text{F})$ , the compressor will run at reduced frequency.
- d. If  $T_{\text{tube}} \geq 60^{\circ}\text{C}(140^{\circ}\text{F})$ , the compressor will stop and the indoor fan will blow residue heat and then stop.

② Exhaust temperature protection of compressor

- If exhaust temperature  $\geq 98^{\circ}\text{C}(208.4^{\circ}\text{F})$ , frequency is not allowed to rise.
- If exhaust temperature  $\geq 103^{\circ}\text{C}(217.4^{\circ}\text{F})$ , the compressor will run at reduced frequency.
- If exhaust temperature  $\geq 110^{\circ}\text{C}(230^{\circ}\text{F})$ , the compressor will stop.
- If exhaust temperature  $\leq 90^{\circ}\text{C}(194^{\circ}\text{F})$ , and the compressor has stayed at stop for at least 3 minutes, the compressor will resume its operation.

③ Communication fault

If the unit fails to receive correct signals for durative 3 minutes, communication fault can be justified and the whole system will stop.

④ Module protection

Under module protection mode, the compressor will stop. When the compressor remains at stop for at least 3 minutes, the compressor will resume its operation. If module protection occurs six times in succession, the compressor will not be started again.

⑤ Overload protection

If temperature sensed by the overload sensor is over 115, the compressor will stop and the outdoor fan will stop with a time lag of 30 seconds. If temperature is below 95, the overload protection will be relieved.

⑥ DC bus voltage protection

If voltage on the DC bus is below 150V or over 420V, the compressor will stop and the outdoor fan will stop with a time lag of 30 seconds. When voltage on the DC bus returns to its normal value and the compressor has stayed at stop for at least 3 minutes, the compressor will resume its operation.

⑦ Faults of temperature sensors

Designation of sensors	Faults
Indoor ambient temperature	The sensor is detected to be open-circuited or short-circuited for successive 5 seconds
Indoor tube temperature	The sensor is detected to be open-circuited or short-circuited for successive 5 seconds
Outdoor ambient temperature	The sensor is detected to be open-circuited or short-circuited for successive 30 seconds
Outdoor tube temperature	The sensor is detected to be open-circuited or short-circuited for successive 30 seconds, and no detection is performed within 10 minutes after defrost begins.
Exhaust	After the compressor has operated for 3 minutes, the sensor is detected to be open-circuited or short-circuited for successive 30 seconds.
Overload	After the compressor has operated for 3 minutes, the sensor is detected to be open-circuited or short-circuited for successive 30 seconds.

3. Other Controls

(1) ON/OFF

Press the remote button ON/OFF: the on-off state will be changed once each time you press the button.

(2) Mode Selection:

Press the remote button MODE, then select and show in the following ways: AUTO, COOL, DRY, FAN, HEAT, AUTO.

(3) Temperature Setting Option Button

Each time you press the remote button TEMP+ or TEMP-, the setting temperature will be up or down by  $1^{\circ}\text{C}(1.8^{\circ}\text{F})$ . Regulating Range:  $16(60.8^{\circ}\text{F}) \sim 30^{\circ}\text{C}(86^{\circ}\text{F})$ , the button is useless under the AUTO mode.

(4) Time Switch

You should start and stop the machine according to the setting time by remote control.

(5) SLEEP State Control



## 1. In cooling mode:

1.1 When the initial set temperature is 16-23°C(60.8~73.4°F), the temperature will rise 1°C(1.8°F) by every hour after sleep function is set; the temperature will not change after rising 3°C(5.4°F); after running for 7 hours, the temperature will decrease 1°C(1.8°F) and it will not change after that.

1.2 When the initial set temperature is 24-27°C(75.2~80.6°F), the temperature will rise 1°C(1.8°F) by every hour after sleep function is set; the temperature will not change after rising 2°C(3.6°F); after running for 7 hours, the temperature will decrease 1°C(1.8°F) and it will not change after that.

1.3 When the initial set temperature is 28-29°C(82.4~84.2°F), the temperature will rise 1°C(1.8°F) by every hour after sleep function is set; the temperature will not change after rising 1°C(1.8°F); after running for 7 hours, the temperature will decrease 1°C(1.8°F) and it will not change after that.

1.4 When the initial set temperature is 30°C(86°F), the unit will keep on running at this temperature; after running for 7 hours, the temperature will decrease 1°C(1.8°F) and it will not change after that.

Relationship between set temperature and running time:

Initial Temp.	Running time(T)								
	0(start)	1	2	3	4	5	6	7	8
16	17	18	19	19	19	19	19	18	18
17	18	19	20	20	20	20	20	19	19
18	19	20	21	21	21	21	21	20	20
19	20	21	22	22	22	22	22	21	21
20	21	22	23	23	23	23	23	22	22
21	22	23	24	24	24	24	24	23	23
22	23	24	25	25	25	25	25	24	24
23	24	25	26	26	26	26	26	25	25
24	25	26	26	26	26	26	26	25	25
25	26	27	27	27	27	27	27	26	26
26	27	28	28	28	28	28	28	27	27
27	28	29	29	29	29	29	29	28	28
28	29	29	29	29	29	29	29	28	28
29	30	30	30	30	30	30	30	29	29
30	30	30	30	30	30	30	30	29	29

## 2. In heating mode:

2.1 When the initial set temperature is 16°C(60.8°F), the unit will keep on running at this temperature;

2.2 When the initial set temperature is 17-20°C(62.6~68°F), the temperature will decrease 1°C(1.8°F) by every hour after sleep function is set; the temperature will not change after decreasing 1°C(1.8°F);

2.3 When the initial set temperature is 21-27°C(69.8~80.6°F), the temperature will decrease 1°C(1.8°F) by every hour after sleep function is set; the temperature will not change after decreasing 2°C(3.6°F);

2.4 When the initial set temperature is 28-30°C(82.4~86°F), the temperature will decrease 1°C(1.8°F) by every hour after sleep function is set; the temperature will not change after decreasing 3°C(5.4°F);

Relationship between set temperature and running time:

Initial Temp.	Running time(T)								
	0(start)	1	2	3	4	5	6	7	8
16	16	16	16	16	16	16	16	16	16
17	16	16	16	16	16	16	16	16	16
18	17	17	17	17	17	17	17	17	17
19	18	18	18	18	18	18	18	18	18
20	19	19	19	19	19	19	19	19	19
21	20	19	19	19	19	19	19	19	19
22	21	20	20	20	20	20	20	20	20
23	22	21	21	21	21	21	21	21	21
24	23	22	22	22	22	22	22	22	22
25	24	23	23	23	23	23	23	23	23
26	25	24	24	24	24	24	24	24	24
27	26	25	25	25	25	25	25	25	25
28	27	26	25	25	25	25	25	25	25
29	28	27	26	26	26	26	26	26	26
30	29	28	27	27	27	27	27	27	27

## (6) Indoor Fan Control

Indoor fan could be set at ultra-high, high, medium, low speed by wireless remote controller and operated as that speed.

Auto fan speed could be set as well, indoor fan will operate under auto fan speed as following:

1. Under heating mode: auto speed under heating or auto heating mode:

- a. When  $T_{amb} \leq T_{preset} + 1^{\circ}\text{C} (1.8^{\circ}\text{F})$ , indoor fan will operate at high speed;
- b. When  $T_{preset} + 1^{\circ}\text{C} (1.8^{\circ}\text{F}) < T_{amb} < T_{preset} + 3^{\circ}\text{C} (5.4^{\circ}\text{F})$ , indoor fan will operate at medium speed;
- c. When  $T_{amb} \geq T_{preset} + 3^{\circ}\text{C} (5.4^{\circ}\text{F})$ , indoor fan will operate at low speed;

There should be at least 180s operation time during switchover of each speed.

2. Under cooling mode: auto speed under cooling or auto cooling mode:

- a. When  $T_{amb} \geq T_{preset} + 2^{\circ}\text{C} (3.6^{\circ}\text{F})$ , indoor fan will operate at high speed;
- b. When  $T_{preset} < T_{amb} < T_{preset} + 2^{\circ}\text{C} (3.6^{\circ}\text{F})$ , indoor fan will operate at medium speed;
- c. When  $T_{amb} \leq T_{preset}$ , indoor fan will operate at low speed

There should be at least 210s operation time during switchover of each speed.

(7) Buzzer Control

The buzzer will send a “Di” sound when the air conditioner is powered up or received the information sent by the remote control or there is a button input, the single tube cooler doesn’t receive the remote control ON signal under the mode of heating mode.

(8) Auto button

If the controller is on, it will stop by pressing the button, and if the controller is off, it will be automatic running state by pressing the button, swing on and light on, and the main unit will run based on the remote control if there is remote control order.

(9) Up-and-Down Swinging Control

When power on, the up-and-down motor will firstly move the air deflector to 0 counter-clockwise, close the air outlet.

After starting the machine, if you don’t set the swinging function, heating mode and auto-heating mode, the up-and-down air deflector will move to D clockwise; under other modes, the up-and-down air deflector will move to L1. If you set the swinging function when you start the machine, then the wind blade will swing between L and D. The air deflector has 7 swinging states: Location L, Location A, Location B, Location C, Location D, Location L to Location D, stop at any location between L-D (the included angle between L~D is the same).

The air deflector will be closed at 0 Location, and the swinging is effectual only on condition that setting the swinging order and the inner fan is running. The indoor fan and compressor may get the power when air deflector is on the default location.

The air deflector will be closed at 0 Location, and the swinging is effectual only on condition that setting the swinging order and the inner fan is running. The indoor fan and compressor may get the power when air deflector is on the default location.

(10) Display

① Operation pattern and mode pattern display

All the display patterns will display for a time when the power on, the operation indication pattern will display in red under standby status. When the machine is start by remote control, the indication pattern will light and display the current operation mode (the mode light includes: Cooling, heating and dehumidify). If you close the light key, all the display patterns will close.

② Double-8 display

According to the different setting of remote control, the nixie light may display the current temperature (the temperature scope is from 16°C (60.8°F) to 30°C (86°F)) and indoor ambient temperature. The set temperature displayed in auto cooling and fan mode is 25°C (77°F) and the set temperature displayed in auto heating mode is 20°C (68°F). Under heating mode, nixie tube displays H1 or heating indicator is off 0.5s and blinks 10s in defrosting. (If you set the fahrenheit temperature display, the nixie light will display according to fahrenheit temperature) (11)

Protection function and failure display

- E2: Freeze-proofing protection      E4: Exhausting protection      E5: Overcurrent protection      E6: Communication failure
- F1: Indoor ambient sensor start and short circuit (continuously measured failure in 5s)
- F2: Indoor evaporator sensor start and short circuit (continuously measured failure in 5s)
- F3: Outdoor ambient sensor start and short circuit (continuously measured failure in 30s)
- F4: Outdoor condenser sensor start and short circuit (continuously measured failure in 30s, and don’t measure within 10 minutes after defrosted)
- F5: Outdoor exhausting sensor start and short circuit (continuously measured failure in 30s after the compressor operated 3 minutes)
- H3: Overload protection of compressor      H5: Module protection      PH: High-voltage protection      PL: Low-voltage protection
- P1: Nominal cooling and heating test      P2: Maximum cooling and heating test
- P3: Medium cooling and heating test      P0: Minimum cooling and heating test

(12) Drying Function

You may start or stop the drying function under the modes of cooling and dehumidify at the starting status (The modes of automatism, heating and air supply do not have drying function). When you start the drying function, after stop the machine by pressing the switch button, you should keep running the inner fans for 2 minutes under low air damper (The swing will operate as the D1 status within 2 minutes, and other load is stopped), then stop the entire machine; When you stop the drying function, press the switch button will stop the machine directly. When you start the drying function, operating the drying button will stop the inner fans and close the guide louver.

(13) Memory Function

When interrupting the power supply memory content: mode, swing function, light, set temperature and wind speed.

After interrupted the power supply, the machine will start when recovering the power according to the memory content automatically.

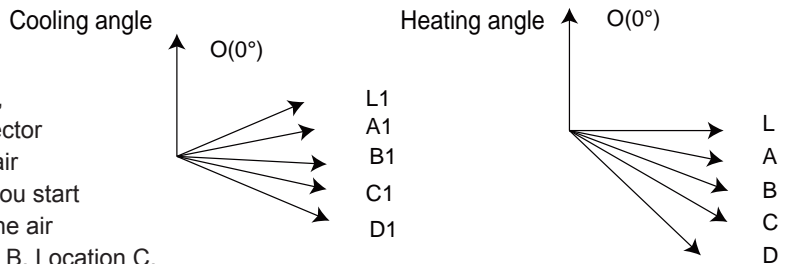

# Part II : Installation and Maintenance

## 7. Notes for Installation and Maintenance

### Safety Precautions: Important!

Please read the safety precautions carefully before installation and maintenance.

The following contents are very important for installation and maintenance.

Please follow the instructions below.

- The installation or maintenance must accord with the instructions.
- Comply with all national electrical codes and local electrical codes.
- Pay attention to the warnings and cautions in this manual.
- All installation and maintenance shall be performed by distributor or qualified person.
- All electric work must be performed by a licensed technician according to local regulations and the instructions given in this manual.
- Be caution during installation and maintenance. Prohibit incorrect operation to prevent electric shock, casualty and other accidents.



## Warnings

### Electrical Safety Precautions:

1. Cut off the power supply of air conditioner before checking and maintenance.
2. The air condition must apply specialized circuit and prohibit share the same circuit with other appliances.
3. The air conditioner should be installed in suitable location and ensure the power plug is touchable.
4. Make sure each wiring terminal is connected firmly during installation and maintenance.
5. Have the unit adequately grounded. The grounding wire cant be used for other purposes.
6. Must apply protective accessories such as protective boards, cable-cross loop and wire clip.
7. The live wire, neutral wire and grounding wire of power supply must be corresponding to the live wire, neutral wire and grounding wire of the air conditioner.
8. The power cord and power connection wires cant be pressed by hard objects.
9. If power cord or connection wire is broken, it must be replaced by a qualified person.

10. If the power cord or connection wire is not long enough, please get the specialized power cord or connection wire from the manufacture or distributor. Prohibit prolong the wire by yourself.

11. For the air conditioner without plug, an air switch must be installed in the circuit. The air switch should be all-pole parting and the contact parting distance should be more than 3mm.

12. Make sure all wires and pipes are connected properly and the valves are opened before energizing.

13. Check if there is electric leakage on the unit body. If yes, please eliminate the electric leakage.

14. Replace the fuse with a new one of the same specification if it is burnt down; dont replace it with a cooper wire or conducting wire.

15. If the unit is to be installed in a humid place, the circuit breaker must be installed.

### Installation Safety Precautions:

1. Select the installation location according to the requirement of this manual.(See the requirements in installation part)
2. Handle unit transportation with care; the unit should not be carried by only one person if it is more than 20kg.
3. When installing the indoor unit and outdoor unit, a sufficient fixing bolt must be installed; make sure the installation support is firm.
4. Ware safety belt if the height of working is above 2m.
5. Use equipped components or appointed components during installation.
6. Make sure no foreign objects are left in the unit after finishing installation.

### Refrigerant Safety Precautions:

1. Avoid contact between refrigerant and fire as it generates poisonous gas; Prohibit prolong the connection pipe by welding.
2. Apply specified refrigerant only. Never have it mixed with any other refrigerant. Never have air remain in the refrigerant line as it may lead to rupture or other hazards.
3. Make sure no refrigerant gas is leaking out when installation is completed.
4. If there is refrigerant leakage, please take sufficient measure to minimize the density of refrigerant.
5. Never touch the refrigerant piping or compressor without wearing glove to avoid scald or frostbite.

Improper installation may lead to fire hazard, explosion, electric shock or injury.



## Safety Precautions for Installing and Relocating the Unit:

To ensure safety, please be mindful of the following precautions.



### Warnings

**1. When installing or relocating the unit, be sure to keep the refrigerant circuit free from air or substances other than the specified refrigerant.**

Any presence of air or other foreign substance in the refrigerant circuit will cause system pressure rise or compressor rupture, resulting in injury.

**2. When installing or moving this unit, do not charge the refrigerant which is not comply with that on the nameplate or unqualified refrigerant.**

Otherwise, it may cause abnormal operation, wrong action, mechanical malfunction or even series safety accident.

**3. When refrigerant needs to be recovered during relocating or repairing the unit, be sure that the unit is running in cooling mode. Then, fully close the valve at high pressure side (liquid valve). About 30-40 seconds later, fully close the valve at low pressure side (gas valve), immediately stop the unit and disconnect power. Please note that the time for refrigerant recovery should not exceed 1 minute.**

If refrigerant recovery takes too much time, air may be sucked in and cause pressure rise or compressor rupture, resulting in injury.

**4. During refrigerant recovery, make sure that liquid valve and gas valve are fully closed and power is disconnected before detaching the connection pipe.**

If compressor starts running when stop valve is open and connection pipe is not yet connected, air will be sucked in and cause pressure rise or compressor rupture, resulting in injury.

**5. When installing the unit, make sure that connection pipe is securely connected before the compressor starts running.**

If compressor starts running when stop valve is open and connection pipe is not yet connected, air will be sucked in and cause pressure rise or compressor rupture, resulting in injury.

**6. Prohibit installing the unit at the place where there may be leaked corrosive gas or flammable gas.**

If there leaked gas around the unit, it may cause explosion and other accidents.

**7. Do not use extension cords for electrical connections. If the electric wire is not long enough, please contact a local service center authorized and ask for a proper electric wire.**

Poor connections may lead to electric shock or fire.

**8. Use the specified types of wires for electrical connections between the indoor and outdoor units. Firmly clamp the wires so that their terminals receive no external stresses.**

Electric wires with insufficient capacity, wrong wire connections and insecure wire terminals may cause electric shock or fire.

## Safety Precautions for Refrigerant

●To realize the function of the air conditioner unit, a special refrigerant circulates in the system. The used refrigerant is the fluoride R32, which is specially cleaned. The refrigerant is flammable and inodorous. Furthermore, it can lead to explosion under certain conditions. But the flammability of the refrigerant is very low. It can be ignited only by fire.

●Compared to common refrigerants, R32 is a nonpolluting refrigerant with no harm to the ozoneosphere. The influence upon the greenhouse effect is also lower. R32 has got very good thermodynamic features which lead to a really high energy efficiency. The units therefore need a less filling.

### WARNING:

●Do not use means to accelerate the defrosting process or to clean, other than those recommended by the manufacture.

Should repair be necessary, contact your nearest authorized Service Centre. Any repairs carried out by unqualified personnel may be dangerous. The appliance shall be stored in a room without continuously operating ignition sources. (for example: open flames, an operating gas appliance or an operating electric heater.)

●Do not pierce or burn.

●Appliance shall be installed, operated and stored in a room with a floor area larger than 4m (or 6m).

●Appliance filled with flammable gas R32. For repairs, strictly follow manufacturers instructions only. Be aware that refrigerants not contain odour.

●Read specialists manual.

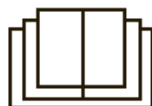

# Safety Operation of Flammable Refrigerant

## Qualification requirement for installation and maintenance man

- All the work men who are engaging in the refrigeration system should bear the valid certification awarded by the authoritative organization and the qualification for dealing with the refrigeration system recognized by this industry. If it needs other technician to maintain and repair the appliance, they should be supervised by the person who bears the qualification for using the flammable refrigerant.
- It can only be repaired by the method suggested by the equipments manufacturer.

## Installation notes

- The air conditioner is not allowed to use in a room that has running fire (such as fire source, working coal gas ware, operating heater).
- It is not allowed to drill hole or burn the connection pipe.
- The air conditioner must be installed in a room that is larger than the minimum room area.  
The minimum room area is shown on the nameplate or following table a.
- Leak test is a must after installation.

table a - Minimum room area(m<sup>2</sup>)

Minimum room area(m <sup>2</sup> )	Charge amount (kg)	≤1.2	1.3	1.4	1.5	1.6	1.7	1.8	1.9	2	2.1	2.2	2.3	2.4	2.5
	floor location	/	14.5	16.8	19.3	22	24.8	27.8	31	34.3	37.8	41.5	45.4	49.4	53.6
wall mounted	/	5.2	6.1	7	7.9	8.9	10	11.2	12.4	13.6	15	16.3	17.8	19.3	
window mounted	/	1.6	1.9	2.1	2.4	2.8	3.1	3.4	3.8	4.2	4.6	5	5.5	6	
ceiling mounted	/	1.1	1.3	1.4	1.6	1.8	2.1	2.3	2.6	2.8	3.1	3.4	3.7	4	

## Maintenance notes

- Check whether the maintenance area or the room area meet the requirement of the nameplate.  
— Its only allowed to be operated in the rooms that meet the requirement of the nameplate.
- Check whether the maintenance area is well-ventilated.  
— The continuous ventilation status should be kept during the operation process.
- Check whether there is fire source or potential fire source in the maintenance area.  
— The naked flame is prohibited in the maintenance area; and the “no smoking” warning board should be hanged.
- Check whether the appliance mark is in good condition.  
— Replace the vague or damaged warning mark.

## Welding

- If you should cut or weld the refrigerant system pipes in the process of maintaining, please follow the steps as below:
  - a. Shut down the unit and cut power supply
  - b. Eliminate the refrigerant
  - c. Vacuuming
  - d. Clean it with N2 gas
  - e. Cutting or welding
  - f. Carry back to the service spot for welding
- Make sure that there isnt any naked flame near the outlet of the vacuum pump and its well-ventilated.
- The refrigerant should be recycled into the specialized storage tank.

## Filling the refrigerant

- Use the refrigerant filling appliances specialized for R32. Make sure that different kinds of refrigerant wont contaminate with each other.
- The refrigerant tank should be kept upright at the time of filling refrigerant.
- Stick the label on the system after filling is finished (or havent finished).
- Dont overfilling.
- After filling is finished, please do the leakage detection before test running; another time of leak detection should be done when its removed.

## Safety instructions for transportation and storage

- Please use the flammable gas detector to check before unload and open the container.
- No fire source and smoking.
- According to the local rules and laws.





## 8. Installation

### 8.1 Installation Dimension Diagram

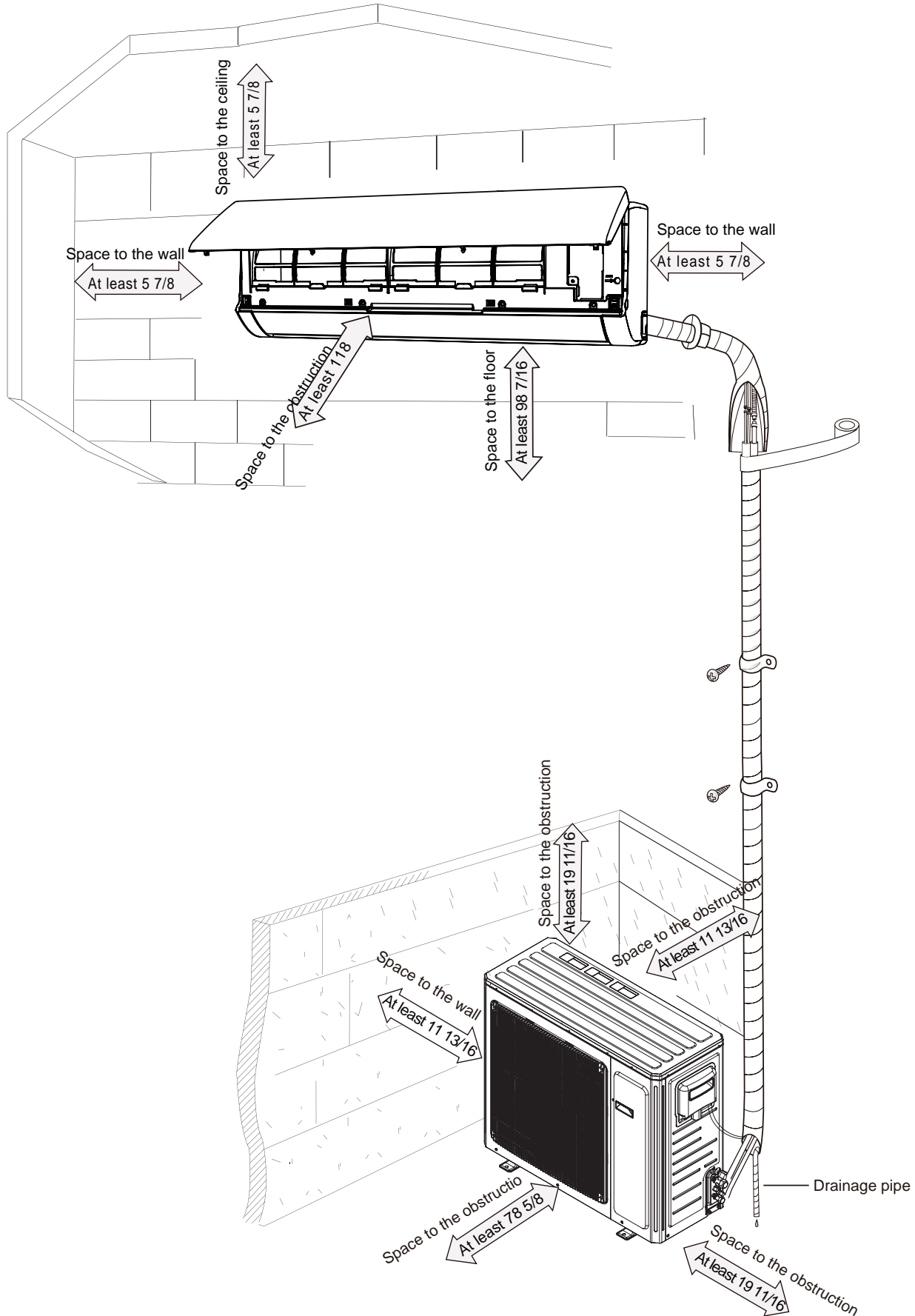



## 8.2 Installation Parts-checking

No.	Name	No.	Name
1	Indoor unit	8	Sealing gum
2	Outdoor unit	9	Wrapping tape
3	Connection pipe	10	Support of outdoor unit
4	Drainage pipe	11	Fixing screw
5	Wall-mounting frame	12	Drainage plug(cooling and heating unit)
6	Connecting cable(power cord)	13	Owner's manual, remote controller
7	Wall pipe		

### ⚠ Note:

- 1.Please contact the local agent for installation.
- 2.Don't use unqualified power cord.

## 8.3 Selection of Installation Location

### 1. Basic Requirement:

Installing the unit in the following places may cause malfunction. If it is unavoidable, please consult the local dealer:

- (1) The place with strong heat sources, vapors, flammable or explosive gas, or volatile objects spread in the air.
- (2) The place with high-frequency devices (such as welding machine, medical equipment).
- (3) The place near coast area.
- (4) The place with oil or fumes in the air.
- (5) The place with sulfureted gas.
- (6) Other places with special circumstances.
- (7) The appliance shall not be installed in the laundry.

### 2. Indoor Unit:

- (1) There should be no obstruction near air inlet and air outlet.
- (2) Select a location where the condensation water can be dispersed easily and won't affect other people.
- (3) Select a location which is convenient to connect the outdoor unit and near the power socket.
- (4) Select a location which is out of reach for children.
- (5) The location should be able to withstand the weight of indoor unit and won't increase noise and vibration.
- (6) The appliance must be installed 2.5m above floor.
- (7) Don't install the indoor unit right above the electric appliance.
- (8) Please try your best to keep way from fluorescent lamp.

### 3. Outdoor Unit:

- (1) Select a location where the noise and outflow air emitted by the outdoor unit will not affect neighborhood.
- (2) The location should be well ventilated and dry, in which the outdoor unit won't be exposed directly to sunlight or strong wind.
- (3) The location should be able to withstand the weight of outdoor unit.
- (4) Make sure that the installation follows the requirement of installation dimension diagram.
- (5) Select a location which is out of reach for children and far away from animals or plants.If it is unavoidable, please add fence for safety purpose.

## 8.4 Electric Connection Requirement

### 1. Safety Precaution

- (1) Must follow the electric safety regulations when installing the unit.
- (2) According to the local safety regulations, use qualified power supply circuit and air switch.
- (3) Make sure the power supply matches with the requirement of air conditioner. Unstable power supply or incorrect wiring may result in electric shock, fire hazard or malfunction. Please install proper power supply cables before using the air conditioner.

Air-conditioner	Air switch capacity
09/12K	16A

- (4) Properly connect the live wire, neutral wire and grounding wire of power socket.
- (5) Be sure to cut off the power supply before proceeding any work related to electricity and safety.
- (6) Do not put through the power before finishing installation.
- (7) For appliances with type Y attachment, the instructions shall contain the substance of the following. If the supply cord is damaged, it must be replaced by the manufacturer, its service agent or similarly qualified persons in order to avoid a hazard.
- (8) The temperature of refrigerant circuit will be high, please keep the interconnection cable away from the copper tube.
- (9) The appliance shall be installed in accordance with national wiring regulations.

### 2. Grounding Requirement:

- (1) The air conditioner is first class electric appliance. It must be properly grounded with specialized grounding device by a professional. Please make sure it is always grounded effectively, otherwise it may cause electric shock.
- (2) The yellow-green wire in air conditioner is grounding wire, which can't be used for other purposes.
- (3) The grounding resistance should comply with national electric safety regulations.
- (4) The appliance must be positioned so that the plug is accessible.
- (5) An all-pole disconnection switch having a contact separation of at least 3mm in all poles should be connected in fixed wiring.
- (6) Including an air switch with suitable capacity, please note the following table. Air switch should be included magnet buckle and heating buckle function, it can protect the circuit-short and overload. (Caution: please do not use the fuse only for protect the circuit)

## 8.5 Installation of Indoor Unit

### 1. Choosing Installation location

Recommend the installation location to the client and then confirm it with the client.

### 2. Install Wall-mounting Frame

- (1) Hang the wall-mounting frame on the wall; adjust it in horizontal position with the level meter and then point out the screw fixing holes on the wall.
- (2) Drill the screw fixing holes on the wall with impact drill (the specification of drill head should be the same as the plastic expansion particle) and then fill the plastic expansion particles

in the holes.

(3) Fix the wall-mounting frame on the wall with tapping screws (ST4.2X25TA) and then check if the frame is firmly installed by pulling the frame. If the plastic expansion particle is loose, please drill another fixing hole nearby.

### 3. Install Wall-mounting Frame

(1) Choose the position of piping hole according to the direction of outlet pipe. The position of piping hole should be a little lower than the wall-mounted frame.(As show in Fig.1)

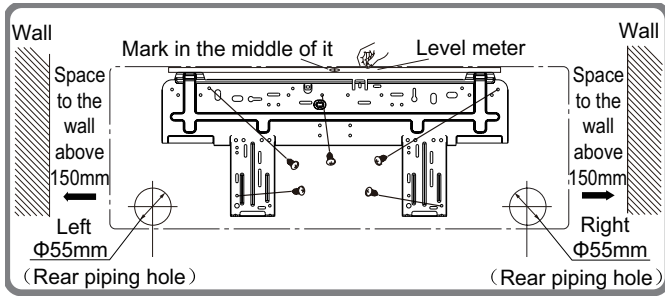

Fig.1

(2) Open a piping hole with the diameter of Φ70mm on the selected outlet pipe position. In order to drain smoothly, slant the piping hole on the wall slightly downward to the outdoor side with the gradient of 5-10°. (As show in Fig.2)

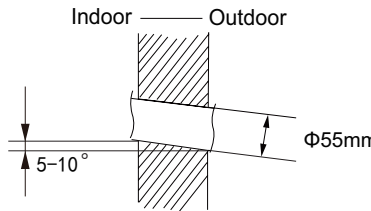

Fig.2

#### ⚠ Note:

- (1) Pay attention to dust prevention and take relevant safety measures when opening the hole.
- (2) The plastic expansion particles are not provided and should be bought locally.

### 4. Outlet Pipe

- (1) The pipe can be led out in the direction of right, rear right, left or rear left.(As show in Fig.3)
- (2) When selecting leading out the pipe from left or right, please cut off the corresponding hole on the bottom case.(As show in Fig.4)

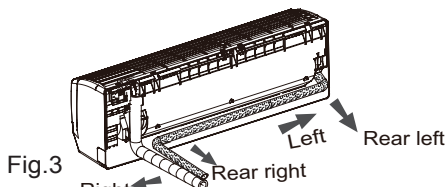

Fig.3

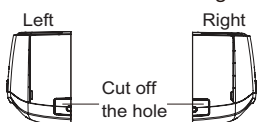

Fig.4

### 5. Connect the Pipe of Indoor Unit

- (1) Aim the pipe joint at the corresponding bellmouth.(As show in Fig.5)
- (2) Pretightening the union nut with hand.
- (3) Adjust the torque force by referring to the following sheet. Place the open-end wrench on the pipe joint and place the torque wrench on the union nut. Tighten the union nut with torque wrench.(As show in Fig.6)
- (4) Wrap the indoor pipe and joint of connection pipe with insulating pipe, and then wrap it with tape.(As show in Fig.7)

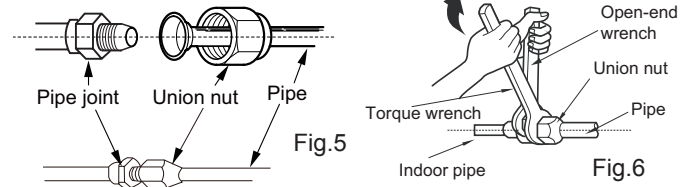

Fig.5

Fig.6

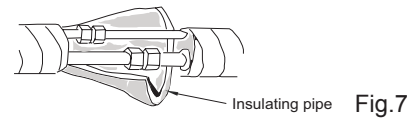

Fig.7

Refer to the following table for wrench moment of force:

Hex nut diameter(mm)	Tightening torque(N·m)
Φ6	15~20
Φ9.52	30~40
Φ12	45~55
Φ16	60~65
Φ19	70~75

### 6. Install Drain Hose

- (1) Connect the drain hose to the outlet pipe of indoor unit.(As show in Fig.8)
- (2) Bind the joint with tape.(As show in Fig.9)

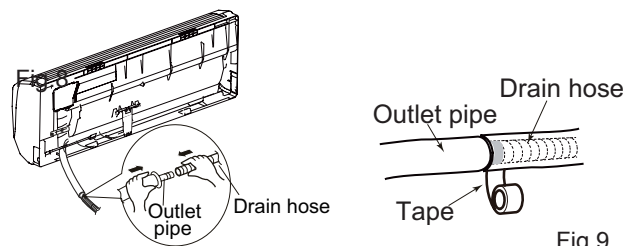

Fig.9

#### ⚠ Note:

- (1) Add insulating pipe in the indoor drain hose in order to prevent condensation.
- (2) The plastic expansion particles are not provided. (As show in Fig.10)

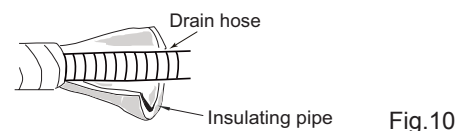

Fig.10

### 7. Connect Wire of Indoor Unit

(1) Open the panel, remove the screw on the wiring cover and then take down the cover.(As show in Fig.11)

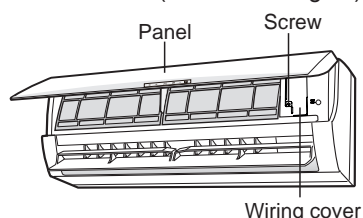

Fig.11

(2) Make the power connection wire go through the cable-cross hole at the back of indoor unit and then pull it out from the front side.(As show in Fig.12)

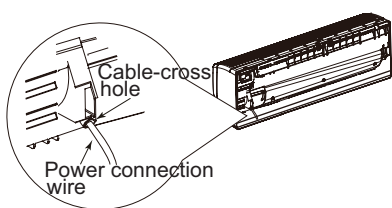

Fig.12

(3) Remove the wire clip; connect the power connection wire and signal control wire to the wiring terminal according to the color; tighten the screw and then fix them with wire clip.(As show in Fig.13)

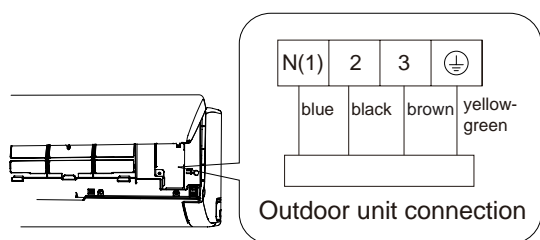

Fig.13

Note: the wiring connect is for reference only, please refer to the actual one.

(4) Put wiring cover back and then tighten the screw.  
 (5) Close the panel.

#### ⚠ Note:

- (1) All wires of indoor unit and outdoor unit should be connected by a professional.
- (2) If the length of power connection wire is insufficient, please contact the supplier for a new one. Avoid extending the wire by yourself.
- (3) For the air conditioner with plug, the plug should be reachable after finishing installation.
- (4) For the air conditioner without plug, an air switch must be installed in the line. The air switch should be all-pole parting and the contact parting distance should be more than 3mm.

### 8. Bind up Pipe

- (1) Bind up the connection pipe, power cord and drain hose with the band.(As show in Fig.14)
- (2) Reserve a certain length of drain hose and power cord for installation when binding to a certain degree, separate the indoor power and then separate the drain hose.(As show in Fig.15)
- (3) Bind them evenly.
- (4) The liquid pipe and gas pipe should be bound separately at the end.

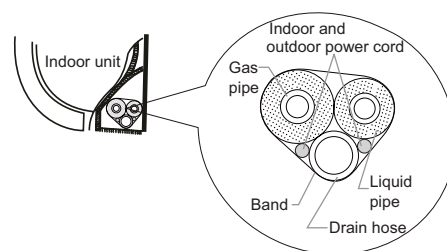

Fig.14

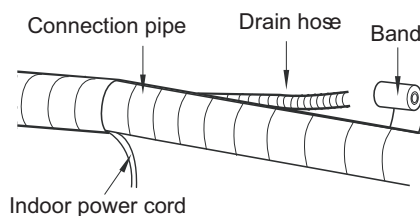

Fig.15

#### ⚠ Note:

- (1) The power cord and control wire can't be crossed or winding.
- (2) The drain hose should be bound at the bottom.

### 9. Hang the Indoor Unit

- (1) Put the bound pipes in the wall pipe and then make them pass through the wall hole.
- (2) Hang the indoor unit on the wall-mounting frame.
- (3) Stuff the gap between pipes and wall hole with sealing gum.
- (4) Fix the wall pipe.(As show in Fig.16)
- (5) Check if the indoor unit is installed firmly and closed to the wall.(As show in Fig.17)

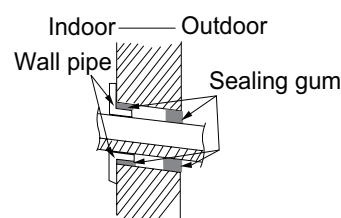
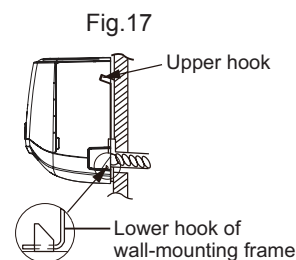

Fig.16



#### ⚠ Note:

Do not bend the drain hose too excessively in order to prevent blocking.

## 8.6 Installation of Outdoor Unit

### 1. Fix the Support of Outdoor Unit(Select it according to the actual installation situation)

- (1) Select installation location according to the house structure.
- (2) Fix the support of outdoor unit on the selected location with expansion screws.

**⚠ Note:**

- (1) Take sufficient protective measures when installing the outdoor unit.
- (2) Make sure the support can withstand at least four times the unit weight.
- (3) The outdoor unit should be installed at least 3cm above the floor in order to install drain joint.(As show in Fig.18)
- (4) For the unit with cooling capacity of 2300W~5000W, 6 expansion screws are needed; for the unit with cooling capacity of 6000W~8000W, 8 expansion screws are needed; for the unit with cooling capacity of 10000W~16000W, 10 expansion screws are needed.

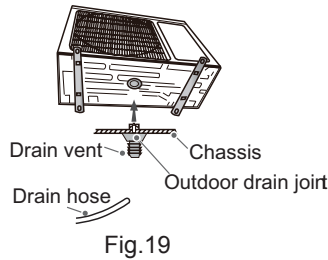
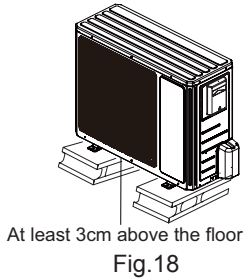

### 2. Install Drain Joint(Only for cooling and heating unit)

- (1) Connect the outdoor drain joint into the hole on the chassis.
  - (2) Connect the drain hose into the drain vent.
- (As show in Fig.19)

### 3. Fix Outdoor Unit

- (1) Place the outdoor unit on the support.
- (2) Fix the foot holes of outdoor unit with bolts. (As show in Fig.20)

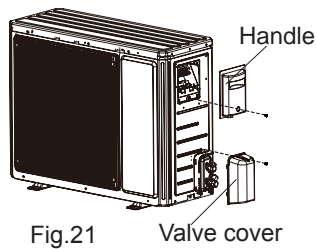
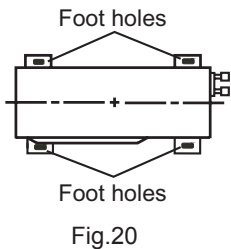

### 4. Connect Indoor and Outdoor Pipes

- (1) Remove the screw on the handle and valve cover of outdoor unit and then remove the handle and valve cover.(As show in Fig.21)
- (2) Remove the screw cap of valve and aim the pipe joint at the bellmouth of pipe.(As show in Fig.22)

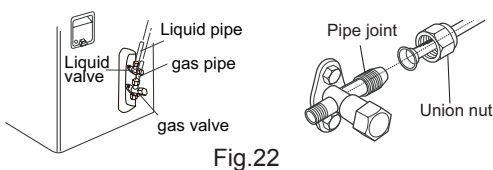

- (3) Pretightening the union nut with hand.
- (4) Tighten the union nut with torque wrench .

Refer to the following table for wrench moment of force:

Hex nut diameter(mm)	Tightening torque(N·m)
Φ6	15~20
Φ9.52	30~40
Φ12	45~55
Φ16	60~65
Φ19	70~75

### 5. Connect Outdoor Electric Wire

- (1) Remove the wire clip; connect the power connection wire and signal control wire (only for cooling and heating unit) to the wiring terminal according to the color; fix them with screws.(As show in Fig.23)

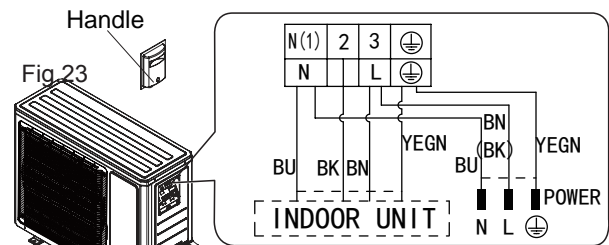

Note: the wiring connect is for reference only, please refer to the actual one.

- (2) Fix the power connection wire and signal control wire with wire clip.

**⚠ Note:**

- (1) After tightening the screw, pull the power cord slightly to check if it is firm.
- (2) Never cut the power connection wire to prolong or shorten the distance.

### 6. Neaten the Pipes

- (1) The pipes should be placed along the wall, bent reasonably and hidden possibly. Min. semidiameter of bending the pipe is 10cm.
- (2) If the outdoor unit is higher than the wall hole, you must set a U-shaped curve in the pipe before pipe goes into the room, in order to prevent rain from getting into the room.(As show in Fig.24)

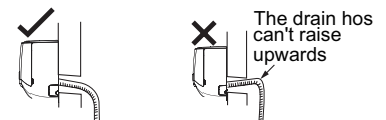
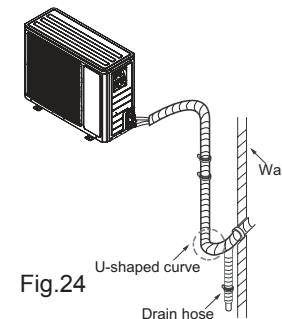



**⚠ Note:**

- (1) The through-wall height of drain hose shouldn't be higher than the outlet pipe hole of indoor unit.(As show in Fig.25)
- (2) Slant the drain hose slightly downwards. The drain hose can't be curved, raised and fluctuant, etc.(As show in Fig.26)
- (3) The water outlet can't be placed in water in order to drain smoothly.(As show in Fig.27)

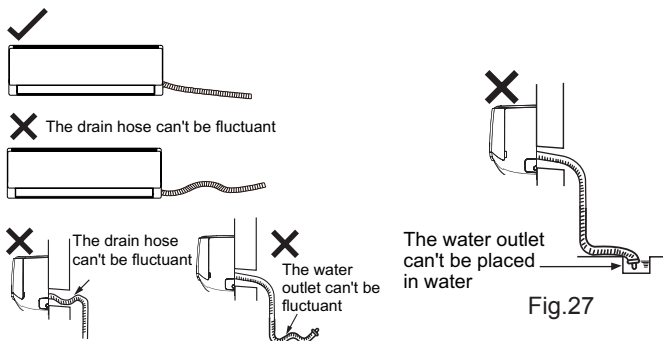

Fig.26

Fig.27

## 8.7 Vacuum Pumping and Leak Detection

### 1. Use Vacuum Pump

- (1) Remove the valve caps on the liquid valve and gas valve and the nut of refrigerant charging vent.
- (2) Connect the charging hose of piezometer to the refrigerant charging vent of gas valve and then connect the other charging hose to the vacuum pump.
- (3) Open the piezometer completely and operate for 10-15min to check if the pressure of piezometer remains in -0.1MPa.
- (4) Close the vacuum pump and maintain this status for 1-2min to check if the pressure of piezometer remains in -0.1MPa. If the pressure decreases, there may be leakage.
- (5) Remove the piezometer, open the valve core of liquid valve and gas valve completely with inner hexagon spanner.
- (6) Tighten the screw caps of valves and refrigerant charging vent.(As show in Fig.28)

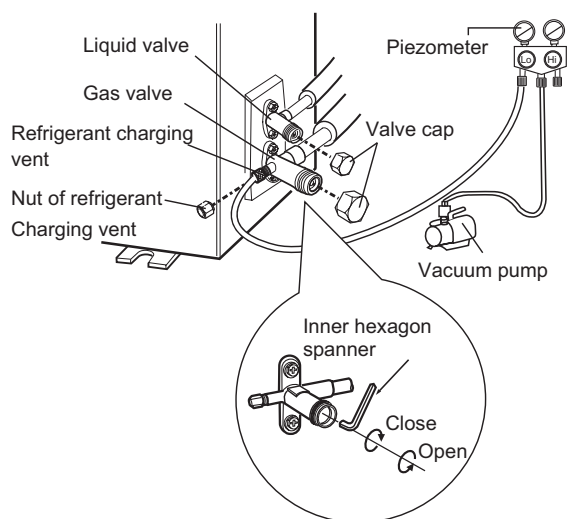

Fig.28

### 2. Leakage Detection

- (1) With leakage detector:  
Check if there is leakage with leakage detector.
- (2) With soap water:  
If leakage detector is not available, please use soap water for leakage detection. Apply soap water at the suspected position and keep the soap water for more than 3min. If there are air bubbles coming out of this position, there's a leakage.

## 8.8 Check after Installation and Test Operation

### 1. Check after Installation

Check according to the following requirement after finishing installation.

NO.	Items to be checked	Possible malfunction
1	Has the unit been installed firmly?	The unit may drop, shake or emit noise.
2	Have you done the refrigerant leakage test?	It may cause insufficient cooling (heating) capacity.
3	Is heat insulation of pipeline sufficient?	It may cause condensation and water dripping.
4	Is water drained well?	It may cause condensation and water dripping.
5	Is the voltage of power supply according to the voltage marked on the nameplate?	It may cause malfunction or damage the parts.
6	Is electric wiring and pipeline installed correctly?	It may cause malfunction or damage the parts.
7	Is the unit grounded securely?	It may cause electric leakage.
8	Does the power cord follow the specification?	It may cause malfunction or damage the parts.
9	Is there any obstruction in air inlet and air outlet?	It may cause insufficient cooling (heating) capacity.
10	The dust and sundries caused during installation are removed?	It may cause malfunction or damaging the parts.
11	The gas valve and liquid valve of connection pipe are open completely?	It may cause insufficient cooling (heating) capacity.
12	Is the inlet and outlet of piping hole been covered?	It may cause insufficient cooling (heating) capacity or waster electricity.

### 2. Test Operation

- (1) Preparation of test operation
  - The client approves the air conditioner installation.
  - Specify the important notes for air conditioner to the client.
- (2) Method of test operation
  - Put through the power, press ON/OFF button on the remote controller to start operation.
  - Press MODE button to select AUTO, COOL, DRY, FAN and HEAT to check whether the operation is normal or not.
  - If the ambient temperature is lower than 16°C , the air conditioner can't start cooling.

### 8.9 Wired Controller

If the product you bought is equipped with wired controller, please refer to the following introductions of wired controller.

#### 1. Displaying Part



Fig1.1.1 Outline of wired controller

#### 1.1 LCD Display of Wired Controller

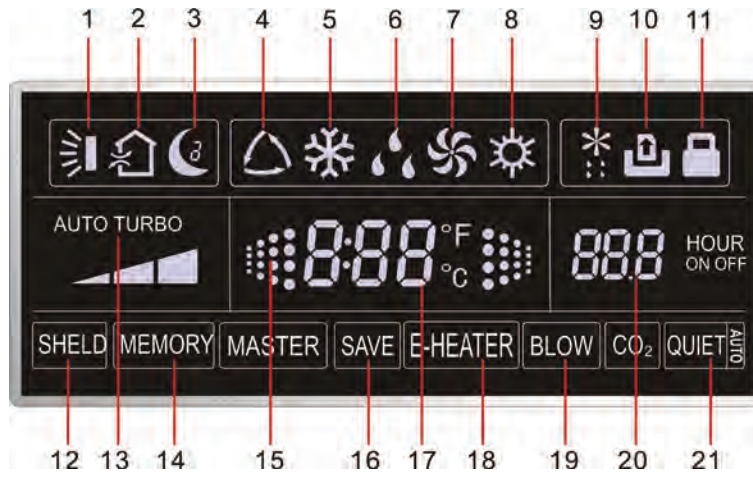





Fig.1.1.2 LCD display

#### 1.2 Instruction to LCD Display

No.	Symbols	Description
1		Swing function
2		Air exchange function (this function is yet unavailable for this unit)
3		Sleep function (Only sleep 1)
4		Each kind of running mode of indoor unit (auto mode)
5		Cooling mode
6		Dry mode
7		Fan mode
8		Heating mode
9		Defrosting function for the outdoor unit
10		Gate-control function (this function is yet unavailable for this unit)



11		Lock function
12	SHIELD	Shield functions (Button operation, temperature setting, On/Off operation, Mode setting are disabled by the remote monitoring system.)
13	TURBO	Turbo function state
14	MEMORY	Memory function (The indoor unit resumes the original setting state after power failure and then power recovery)
15		It blinks under on state of the unit without operation of any button
16	SAVE	Energy-saving function
17		Ambient/setting temperature value
18	E-HEATER	Electric auxiliary heating function (this function is yet unavailable for this unit)
19	BLOW	Blow function
20		Timing value
21	QUIET	Quiet function (two types: quiet and auto quiet) (this function is yet unavailable for this unit).

## 2 Buttons

### 2.1 Layout of Buttons

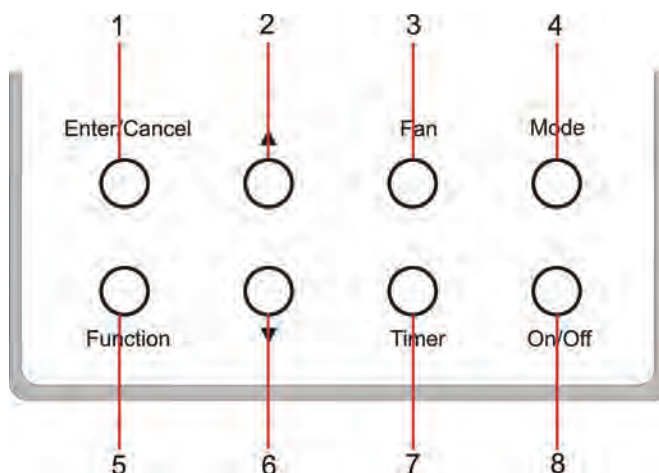

### 2.2 Functions of Buttons

No.	Name	Function
1	Enter/Cancel	Function selection and cancellation.
2	▲	① Running temperature setting of the indoor unit, range:16~30°C.
6	▼	② Timer setting, range:0.5-24 hr.
3	Fan	Setting of the high/middle/low/auto fan speed.
4	Mode	Setting of the Cooling/Heating/Fan/Dry/Auto mode of the indoor unit.
6	Function	Switchover among the functions of Turbo/Save/E-heater/Blow etc.
7	Timer	Timer setting.
8	On/Off	Turn on/off the indoor unit.
4+2	▲+Mode	Press them for 5s under off state of the unit to enter/cancel the Memory function (If memory is set, indoor unit after power failure and then power recovery will resume the original setting state. If not, the indoor unit is defaulted to be off after power recovery. Memory off is default before delivery.)
3+6	Fan+▼	By pressing them at the same time under off state of the unit, ❄️ will be displayed on the wired controller for the cooling only unit, while ☀️ will be displayed on the wired controller for the cooling and heating unit.
2+6	▲+▼	Upon startup of the unit without malfunction or under off state of the unit, press them at the same time for 5s to enter the lock state, in which case, any other buttons won't respond to the press. Re-press them for 5s to quit this state.

### 3 Operation Instructions

#### 3.1 On/Off

Press On/Off to turn on the unit and turn it off by another press.

Note: The state shown in Fig.3.1.1 indicates the “Off” state of the unit after power on. The state shown in Fig.3.1.2 indicates the “On” state of the unit after power on.



Fig.3.1.1 “Off” State



Fig.3.1.2 “On” State

#### 3.2 Mode Setting

Under ON state of the unit, press the Mode to switch the operation modes as the following sequence: Auto–Cooling–Dry–Fan–Heating.

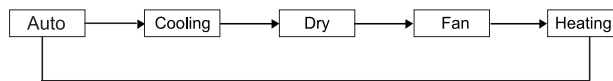

#### 3.3 Temperature Setting

Press ▲ or ▼ to increase/decrease the preset temperature. If pressing either of them continuously, the temperature will be increased or decreased by 1°C every 0.5s, as shown in Fig.3.3.1.

In the Cooling, Dry, Fan or Heating mode, the temperature setting range is 16~30°C(61~86°F).

In the Auto mode, the setting temperature is unadjustable.



Fig.3.3.1



Fig.3.4.1

#### 3.4 Fan Setting

Under the “On” state of the unit, press Fan and then fan speed of the indoor unit will change circularly as shown in Fig.3.4.1.

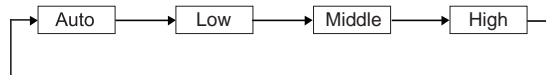

#### 3.5 Timer Setting

Under on-state of the unit, Press Timer button to set timer off of the unit. Under off-state of the unit, press Timer button to set timer on of the unit in the same way.

##### • Timer on setting:

Under off-state of the unit without timer setting, if Timer button is pressed, LCD will display xx.Hour, with ON blinking. In this case, press ▲ or ▼ button to adjust timer on and then press Timer to confirm.

• Timer off setting:

Under on-state of the unit without timer setting, if Timer button is pressed, LCD will display xx. Hour,with OFF blinking. In this case, press ▲ or ▼ button to adjust timer on and then press Timer to confirm.

• Cancel timer:

After setting of timer, if Timer button is pressed, LCD wont display xx. Hour so that timer setting is canceled.

Timer off setting under the “On” state of the unit is shown as Fig.3.5.1.

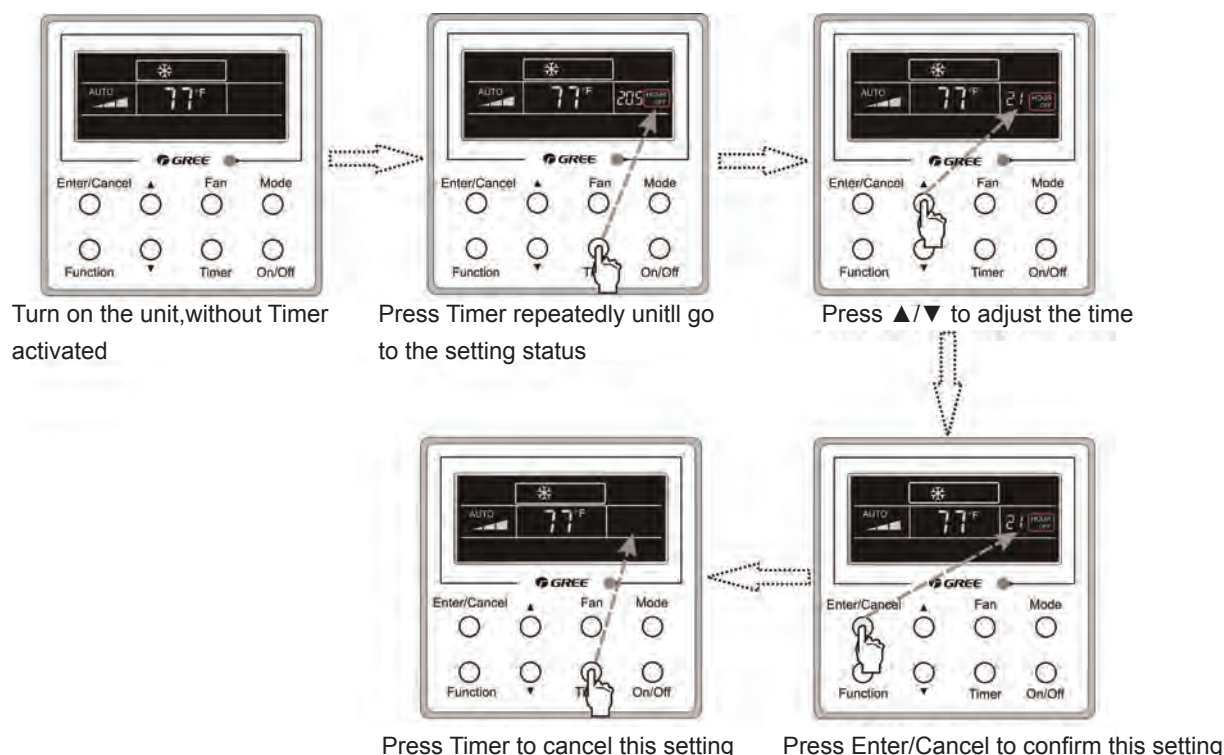

Fig.3.5.1 Timer off Setting under the “On” State of the Unit

Timer on setting under the “Off” state of the unit is shown as Fig.3.5.2.

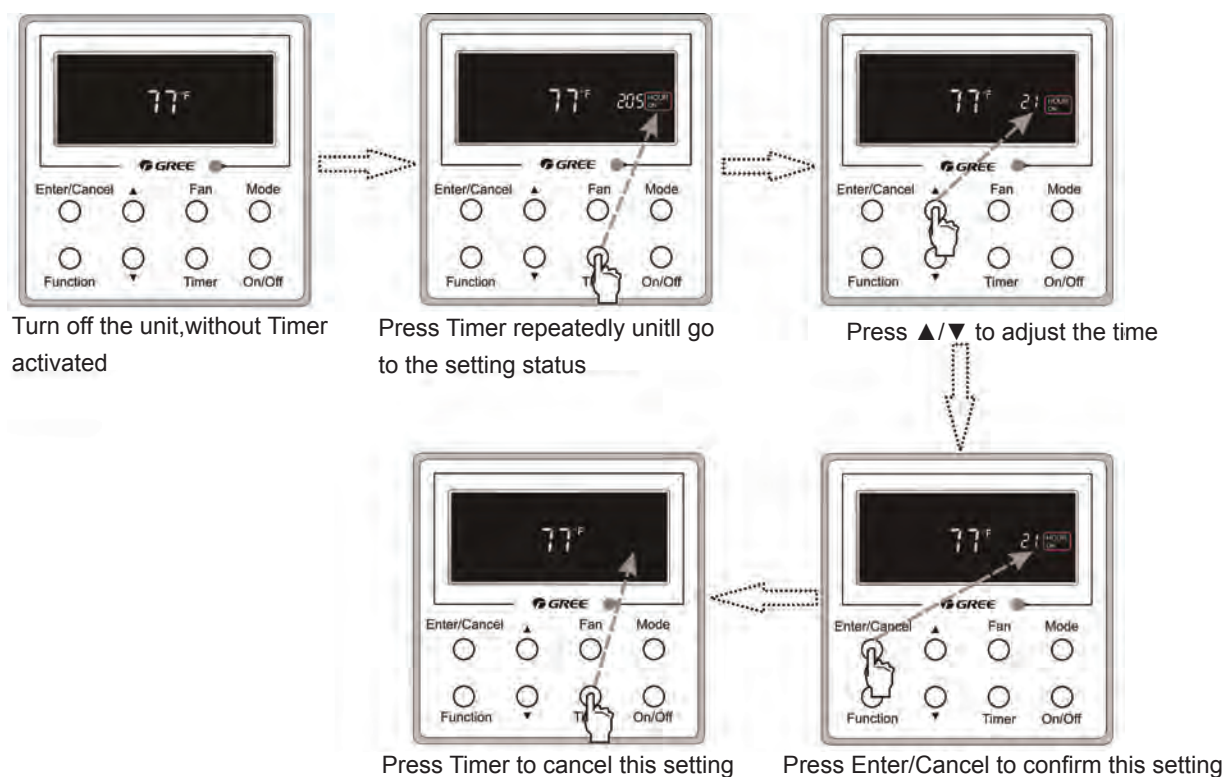



Fig.3.5.2 Timer on Setting under the “Off” State of the Unit

Timer range: 0.5-24hr. Every press of ▲ or ▼ will make the set time increased or decreased by 0.5hr. If either of them is pressed continuously, the set time will increase/ decrease by 0.5hr every 0.5s.

### 3.6 Swing Setting

Swing On: Press Function under on state of the unit to activate the swing function. In this case,  will blink, After that, press Enter/Cancel to make a confirmation.

Swing Off: When the Swing function is on, press Function to enter the Swing setting interface, with  blinking. After that, press Enter/Cancel to cancel this function. Swing setting is shown as Fig.3.6.1.

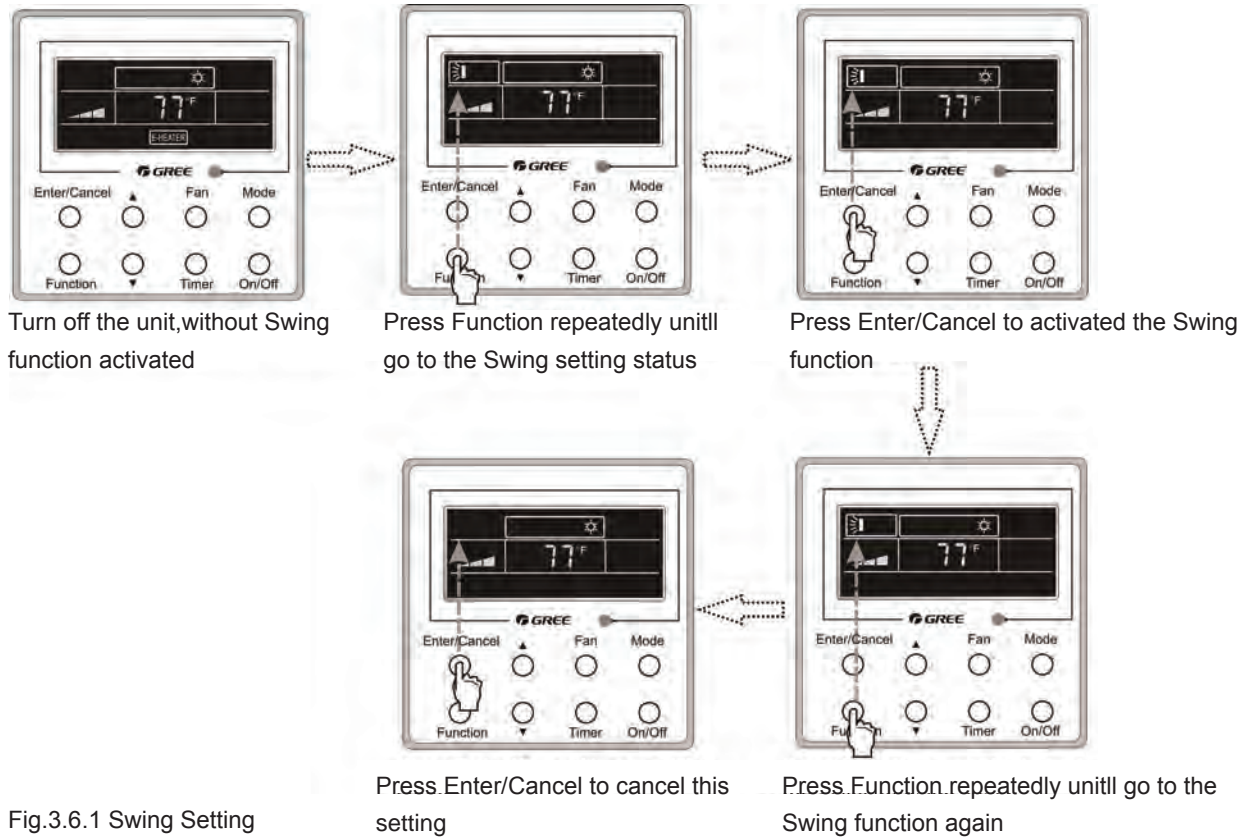

Fig.3.6.1 Swing Setting

#### Notes:

- (1) Sleep, Turbo or Blow setting is the same as the Swing setting.
- (2) After the setting has been done, it has to press the key “Enter/Cancel” to back to the setting status or quit automatically five seconds later.

### 3.7 Sleep Setting

Sleep on: Press Function under the On state of the unit till the unit enters the Sleep setting state. After that, press Enter/Cancel to confirm this setting.

Sleep off: When the Sleep function is activated, press Function to enter the Sleep setting status. After that, press Enter/Cancel to cancel this function.

In the Cooling or Dry mode, the temperature will increase by 1°C(1~2°F) after the unit runs under Sleep1 for 1hr and 1°C(1~2°F) after another 1hr. After that, the unit will run at this temperature.

In the Heating mode, the temperature will decrease by 1°C(1~2°F) after the unit runs under Sleep 1 for 1hr and 1°C(1~2°F) after another 1hr. After that, the unit will run at this temperature.



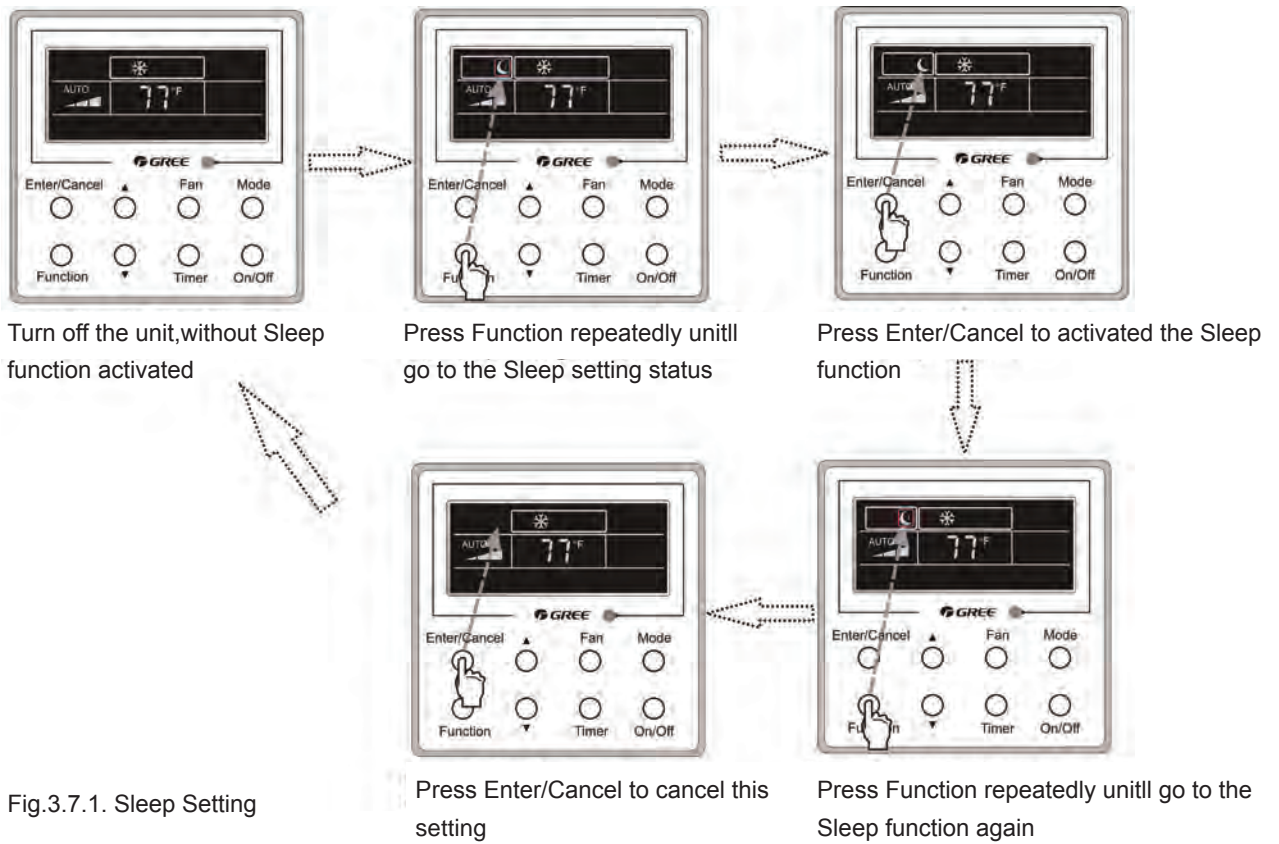

Fig.3.7.1. Sleep Setting

### 3.8 Turbo Setting

Turbo function: The unit at the high fan speed can realize quick cooling or heating so that the room temperature can quickly approach the setting value.

In the Cooling or Heating mode, press Function till the unit enters the Turbo setting status and then press Enter/Cancel to confirm the setting.

When the Turbo function is activated, press Function to enter the Turbo setting status and then press Enter/Cancel to cancel this function.

Turbo function setting is as shown in Fig.3.8.1.

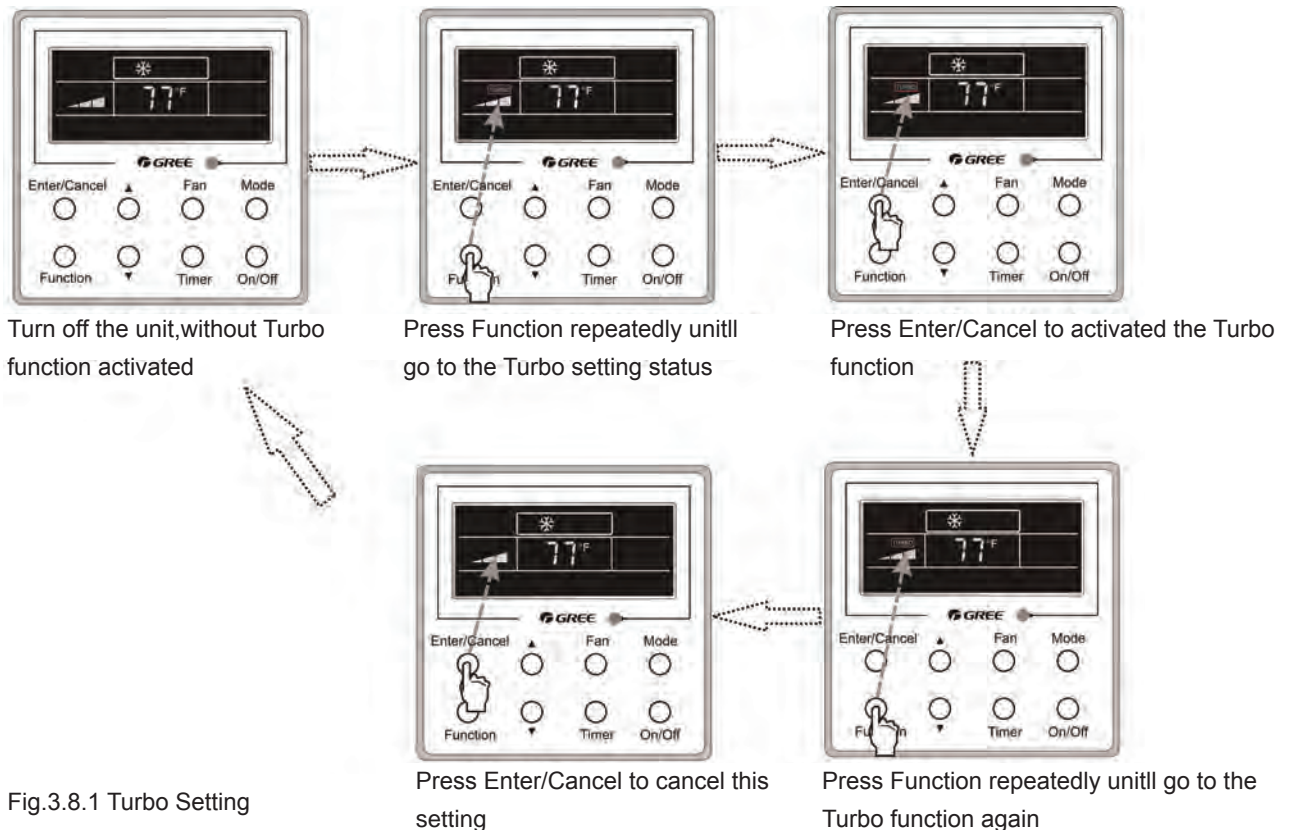

Fig.3.8.1 Turbo Setting

### 3.9 E-heater Setting

E-heater (auxiliary electric heating function): In the Heating mode, E-heater is allowed to be turned on for improvement of efficiency. Once the wired controller or the remote controller enters the Heating mode, this function will be turned on automatically.

Press Function in the Heating mode to enter the E-heater setting interface and then press Enter/Cancel to cancel this function.

Press Function to enter the E-heater setting status, if the E-heater function is not activated, and then press Enter/Cancel to activate it.

The setting of this function is shown as Fig.3.9.1 below:

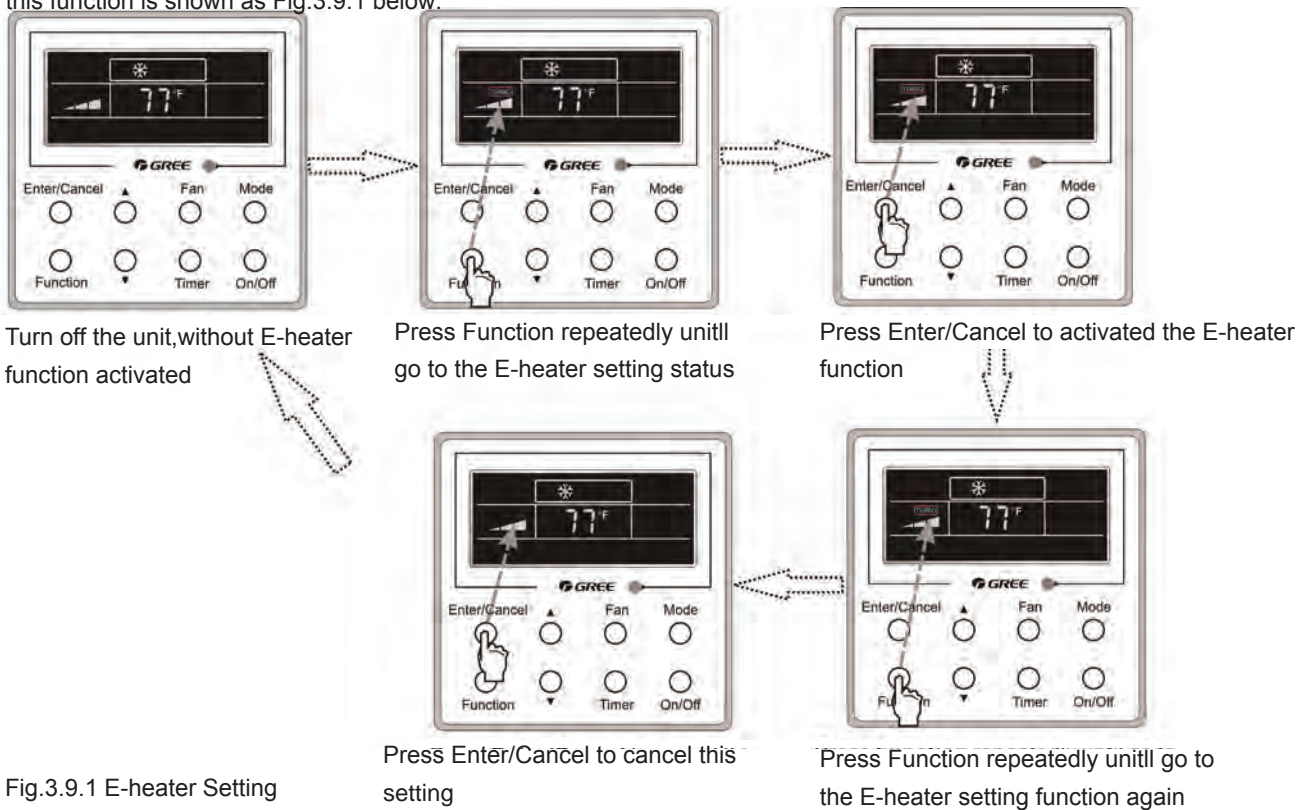

Fig.3.9.1 E-heater Setting

### 3.10 Blow Setting

Blow function: After the unit is turned off, the water in evaporator of indoor unit will be automatically evaporated to avoid mildew.

In the Cooling or Dry mode, press Function till the unit enters the Blow setting status and then press Enter/Cancel to activate this function.

When the Blow function is activated, press Function to the Blow setting status and then press Enter/Cancel to cancel this function.

Blow function setting is as shown in Fig.3.10.1

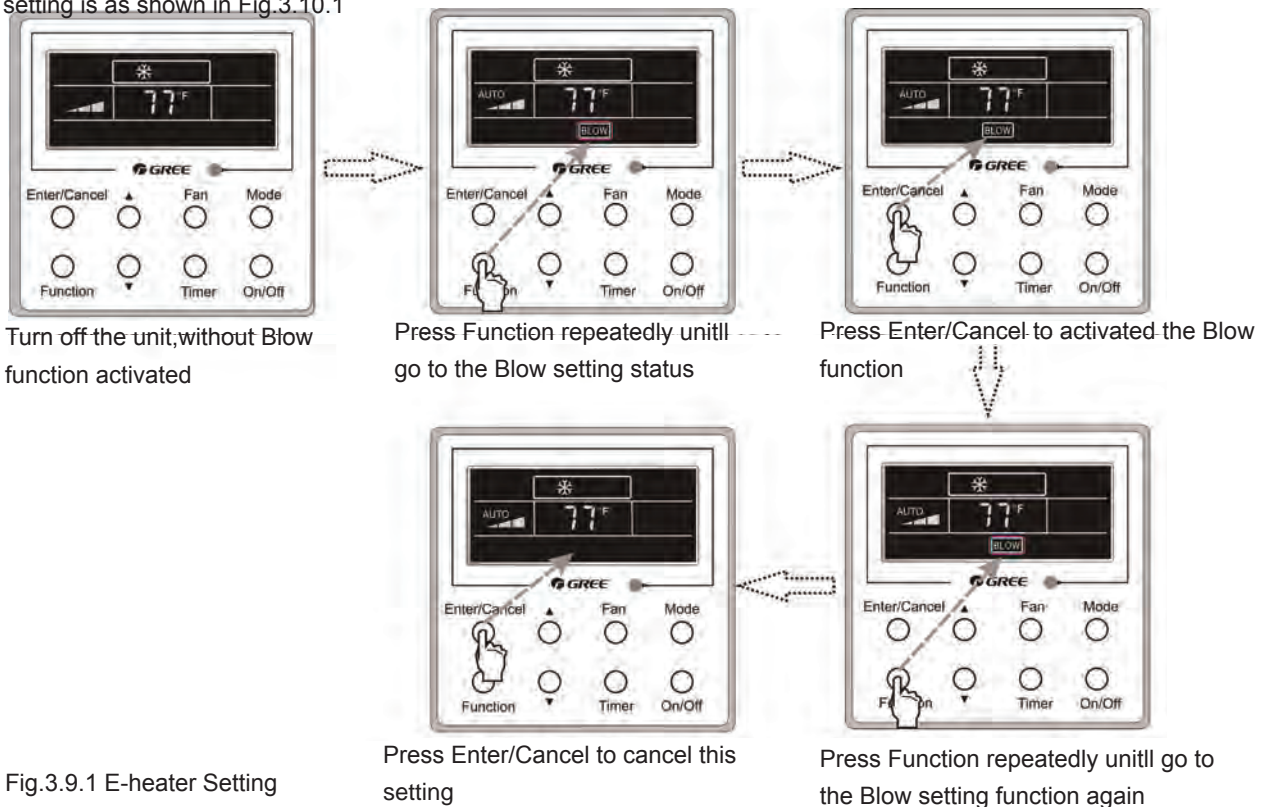

Fig.3.9.1 E-heater Setting

**Notes:**

(1)When the Blow function is activated, if turning off the unit by pressing On/Off or by the remote controller, the indoor fan will run at the low fan speed for 2 min, with “BLOW” displayed on the LCD. While, if the Blow function is deactivated, the indoor fan will be turned off directly.

(2)Blow function is unavailable in the Fan or Heating mode.

**3.11 Other Functions**

**a. Lock**

Upon startup of the unit without malfunction or under the “Off” state of the unit, press ▲ and ▼ at the same time for 5s till the wired controller enters the Lock function. In this case, LCD displays .

After that, repress these two buttons at the same time for 5s to quit this function.

Under the Lock state, any other button press wont get any response.

**b. Memory**

Memory switchover: Under the “Off” state of the unit, press Mode and ▲ at the same time for 5s to switch memory states between memory on and memory off. When this function is activated, Memory will be displayed. If this function is not set, the unit will be under the “Off” state after power failure and then power recovery.

Memory recovery: If this function has been set for the wired controller, the wired controller after power failure will resume its original running state upon power recovery. Memory contents: On/Off, Mode, set temperature, set fan speed and Lock function.

**4. Installation and Dismantlement**

**4.1 Connection of the Signal Line of the Wired Controller**

- Open the cover of the electric control box of the indoor unit.
- Let the single line of the wired controller through the rubber ring.
- Connect the signal line of the wired control to the 4-pin socket of the indoor unit PCB.
- Tighten the signal wire with ties.
- The communication distance between the main board and the wired controller can be up to 20 meters ( the standard distance is 8 meters)

**4.2 Installation of the Wired Controller**

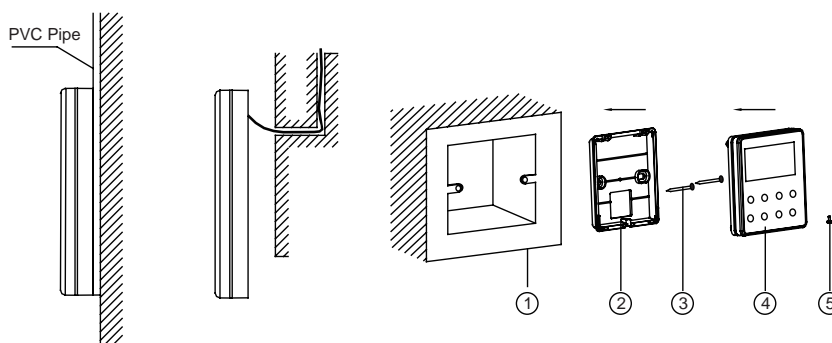

Fig.4.1 Accessories for the Installation of the Wired Controller

No.	1	2	3	4	5
Name	Socket box embedded in the wall	Soleplate of the Wired Controller	Screw M4X25	Front Panel of the Wired Controller	Screw ST 2.9X6



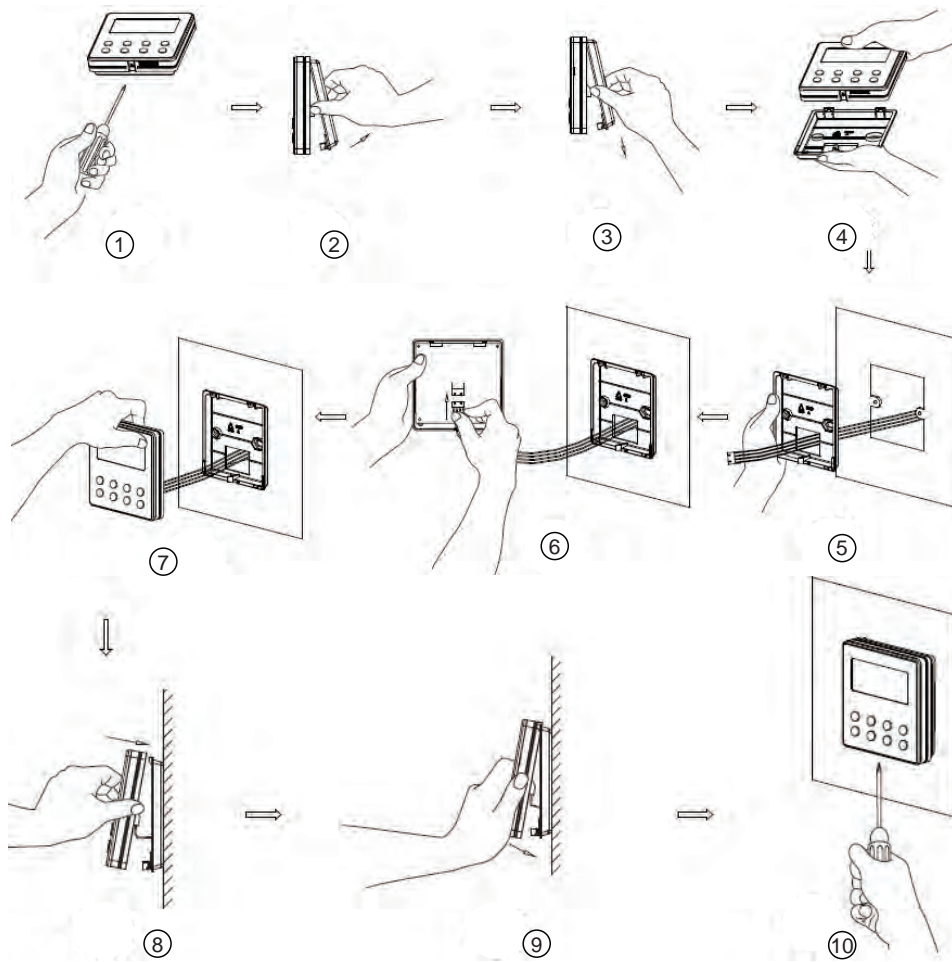

Fig.4.2

Fig.4.2 shows the installation steps of the wired controller, but there are some issues that need your attention.

- (1) Prior to the installation, please firstly cut off the power supply of the wire buried in the installation hole, that is, no operation is allowed with electricity during the whole installation.
- (2) Pull out the four-core twisted pair line from the installation holes and then let it go through the rectangular hole behind the soleplate of the wired controller.
- (3) Stick the soleplate of the wire controller to the wall over the installation hole and then fix it with screws M4X25.
- (4) Insert the four-core twisted pair line into the slot of the wired controller and then buckle the front panel and the soleplate of the wired controller together.
- (5) Finally, fix the front panel and the soleplate of the wired controller tightly by screws ST2.9X6.

**⚠ CAUTION!**

Please pay special attention to the followings during the connection to avoid the malfunction of the air conditioning unit due to electromagnetic interference.

- (1) Separate the signal and communication lines of the wired controller from the power cord and connection lines between the indoor and outdoor unit, with a minimum interval of 20cm, otherwise the communication of the unit will probably work abnormally.
- (2) If the air conditioning unit is installed where is vulnerable to electromagnetic interference, then the signal and communication lines of the wired controller must be the shielding twisted pair lines.

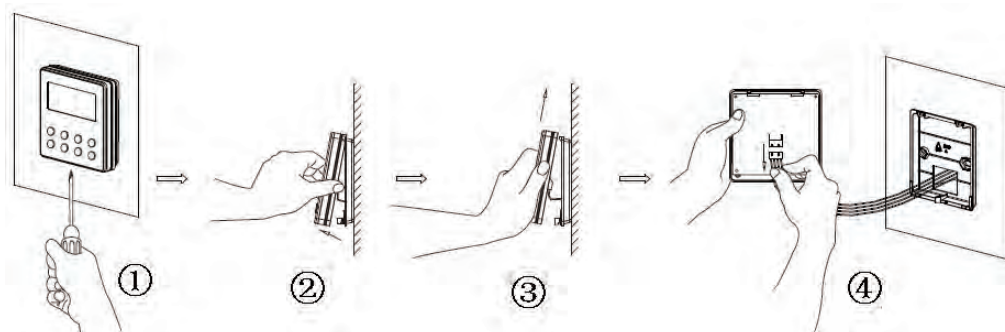

## 5 Errors Display

If there is an error occurring during the operation of the system, the error code will be displayed on the LCD, as show in Fig.5.1. If multi errors occur at the same time, their codes will be displayed circularly.

Note: In event of any error, please turn off the unit and contact the professionally skilled personnel.

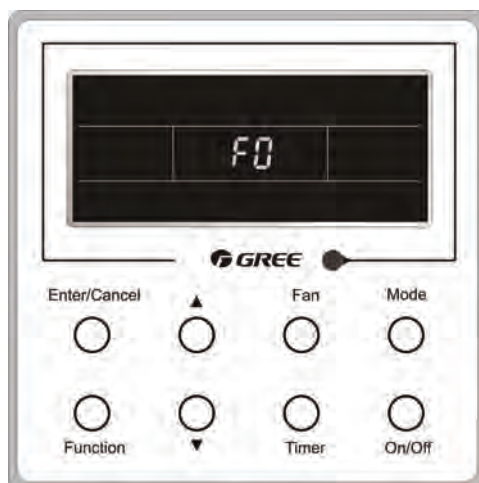

Fig.5.1

## 9. Maintenance

### 9.1 Error Code List

NO.	Malfunction Name	Display Method of Indoor Unit			A/C status	Possible Causes	
		Dual-8 Code Display	Indicator Display (during blinking, ON 0.5s and OFF 0.5s)				
			Operation Indicator	Cool Indicator			Heating Indicator
1	High pressure protection of system	E1				During cooling and drying operation, except indoor fan operates, all loads stop operation. During heating operation, the complete unit stops.	Possible reasons: 1. Refrigerant was superabundant; 2. Poor heat exchange (including filth blockage of heat exchanger and bad radiating environment ); Ambient temperature is too high.
2	Antifreezing protection	E2				During cooling and drying operation, compressor and outdoor fan stop while indoor fan operates.	1. Poor air-return in indoor unit; 2. Fan speed is abnormal; 3. Evaporator is dirty.
3	Refrigerant leakage protection	F0				The Dual-8 Code Display will show F0 and the complete unit stops.	1.Refrigerant leakage; 2.Indoor evaporator temperature sensor works abnormally; 3.The unit has been plugged up somewhere.
4	High discharge temperature protection of compressor	E4				During cooling and drying operation, compressor and outdoor fan stop while indoor fan operates. During heating operation, all loads stop.	Please refer to the malfunction analysis (discharge protection, overload).
5	Overcurrent protection	E5				During cooling and drying operation, compressor and outdoor fan stop while indoor fan operates. During heating operation, all loads stop.	1. Supply voltage is unstable; 2. Supply voltage is too low and load is too high; 3. Evaporator is dirty.
6	Communication Malfunction	E6				During cooling operation, compressor stops while indoor fan motor operates. During heating operation, the complete unit stops.	Refer to the corresponding malfunction analysis.
7	High temperature resistant protection	E8				During cooling operation: compressor will stop while indoor fan will operate. During heating operation, the complete unit stops.	Refer to the malfunction analysis (overload, high temperature resistant).
8	EEPROM malfunction	EE				During cooling and drying operation, compressor will stop while indoor fan will operate; During heating operation, the complete unit will stop	Replace outdoor control panel AP1
9	Limit/decrease frequency due to high temperature of module	EU				All loads operate normally, while operation frequency for compressor is decreased	Discharging after the complete unit is de-energized for 20mins, check whether the thermal grease on IPM Module of outdoor control panel AP1 is sufficient and whether the radiator is inserted tightly. If its no use, please replace control panel AP1.
10	Malfunction protection of jumper cap	C5				Wireless remote receiver and button are effective, but can not dispose the related command	1. No jumper cap insert on mainboard. 2. Incorrect insert of jumper cap. 3. Jumper cap damaged. 4. Abnormal detecting circuit of mainboard.

NO.	Malfunction Name	Display Method of Indoor Unit			A/C status	Possible Causes	
		Dual-8 Code Display	Indicator Display (during blinking, ON 0.5s and OFF 0.5s)				
			Operation Indicator	Cool Indicator			Heating Indicator
11	Gathering refrigerant	Fo				When the outdoor unit receive signal of Gathering refrigerant ,the system will be forced to run under cooling mode for gathering refrigerant	Nominal cooling mode
12	Indoor ambient temperature sensor is open/short circuited	F1				During cooling and drying operation, indoor unit operates while other loads will stop; during heating operation, the complete unit will stop operation.	<ol style="list-style-type: none"> <li>1. Loosening or bad contact of indoor ambient temp. sensor and mainboard terminal.</li> <li>2. Components in mainboard fell down leads short circuit.</li> <li>3. Indoor ambient temp. sensor damaged.(check with sensor resistance value chart)</li> <li>4. Mainboard damaged.</li> </ol>
13	Indoor evaporator temperature sensor is open/short circuited	F2				AC stops operation once reaches the setting temperature. Cooling, drying: internal fan motor stops operation while other loads stop operation; heating: AC stop operation	<ol style="list-style-type: none"> <li>1. Loosening or bad contact of Indoor evaporator temp. sensor and mainboard terminal.</li> <li>2. Components on the mainboard fall down leads short circuit.</li> <li>3. Indoor evaporator temp. sensor damaged.(check temp. sensor value chart for testing)</li> <li>4. Mainboard damaged.</li> </ol>
14	Outdoor ambient temperature sensor is open/short circuited	F3				During cooling and drying operating, compressor stops while indoor fan operates; During heating operation, the complete unit will stop operation	Outdoor temperature sensor hasnt been connected well or is damaged. Please check it by referring to the resistance table for temperature sensor)
15	Outdoor condenser temperature sensor is open/short circuited	F4				During cooling and drying operation, compressor stops while indoor fan will operate; During heating operation, the complete unit will stop operation.	Outdoor temperature sensor hasnt been connected well or is damaged. Please check it by referring to the resistance table for temperature sensor)
16	Outdoor discharge temperature sensor is open/short circuited	F5				During cooling and drying operation, compressor will sop after operating for about 3 mins, while indoor fan will operate; During heating operation, the complete unit will stop after operating for about 3 mins.	<ol style="list-style-type: none"> <li>1.Outdoor temperature sensor hasnt been connected well or is damaged. Please check it by referring to the resistance table for temperature sensor)</li> <li>2.The head of temperature sensor hasnt been inserted into the copper tube</li> </ol>
17	Limit/ decrease frequency due to overload	F6				All loads operate normally, while operation frequency for compressor is decreased	Refer to the malfunction analysis (overload, high temperature resistant)
18	Decrease frequency due to overcurrent	F8				All loads operate normally, while operation frequency for compressor is decreased	The input supply voltage is too low; System pressure is too high and overload

NO.	Malfunction Name	Display Method of Indoor Unit				A/C status	Possible Causes
		Dual-8 Code Display	Indicator Display (during blinking, ON 0.5s and OFF 0.5s)				
			Operation Indicator	Cool Indicator	Heating Indicator		
19	Decrease frequency due to high air discharge	F9				All loads operate normally, while operation frequency for compressor is decreased	Overload or temperature is too high; Refrigerant is insufficient; Malfunction of electric expansion valve (EKV)
20	Limit/decrease frequency due to antifreezing	FH				All loads operate normally, while operation frequency for compressor is decreased	Poor air-return in indoor unit or fan speed is too low
21	Voltage for DC bus-bar is too high	PH				During cooling and drying operation, compressor will stop while indoor fan will operate; During heating operation, the complete unit will stop operation.	1. Measure the voltage of position L and N on wiring board (XT), if the voltage is higher than 265VAC, turn on the unit after the supply voltage is increased to the normal range. 2.If the AC input is normal, measure the voltage of electrolytic capacitor C on control panel (AP1), if its normal, theres malfunction for the circuit, please replace the control panel (AP1)
22	Voltage of DC bus-bar is too low	PL				During cooling and drying operation, compressor will stop while indoor fan will operate; During heating operation, the complete unit will stop	1. Measure the voltage of position L and N on wiring board (XT), if the voltage is higher than 150VAC, turn on the unit after the supply voltage is increased to the normal range. 2.If the AC input is normal, measure the voltage of electrolytic capacitor C on control panel (AP1), if its normal, theres malfunction for the circuit, please replace the control panel (AP1)
23	Compressor Min frequency in test state	P0					Showing during min. cooling or min. heating test
24	Compresso r rated frequency in test state	P1					Showing during nominal cooling or nominal heating test
25	Compressor maximum frequency in test state	P2					Showing during max. cooling or max. heating test

NO.	Malfunction Name	Display Method of Indoor Unit			A/C status	Possible Causes	
		Dual-8 Code Display	Indicator Display (during blinking, ON 0.5s and OFF 0.5s)				
			Operation Indicator	Cool Indicator			Heating Indicator
26	Compressor intermediate frequency in test state	P3				Showing during middle cooling or middle heating test	
27	Overcurrent protection of phase current for compressor	P5			During cooling and drying operation, compressor will stop while indoor fan will operate; During heating operation, the complete unit will stop operation.	Refer to the malfunction analysis (IPM protection, loss of synchronism protection and overcurrent protection of phase current for compressor).	
28	Charging malfunction of capacitor	PU			During cooling and drying operation, compressor will stop while indoor fan will operate; During heating operation, the complete unit will stop	Refer to the part three—charging malfunction analysis of capacitor	
29	Malfunction of module temperature sensor circuit	P7			During cooling and drying operation, compressor will stop while indoor fan will operate; During heating operation, the complete unit will stop	Replace outdoor control panel AP1	
30	Module high temperature protection	P8			During cooling operation, compressor will stop while indoor fan will operate; During heating operation, the complete unit will stop	After the complete unit is de-energized for 20mins, check whether the thermal grease on IPM Module of outdoor control panel AP1 is sufficient and whether the radiator is inserted tightly. If its no use, please replace control panel AP1.	
31	Decrease frequency due to high temperature resistant during heating operation	H0			All loads operate normally, while operation frequency for compressor is decreased	Refer to the malfunction analysis (overload, high temperature resistant)	
32	Static dedusting protection	H2					
33	Overload protection for compressor	H3			During cooling and drying operation, compressor will stop while indoor fan will operate; During heating operation, the complete unit will stop operation.	1. Wiring terminal OVC-COMP is loosened. In normal state, the resistance for this terminal should be less than 1ohm. 2.Refer to the malfunction analysis (discharge protection, overload)	

NO.	Malfunction Name	Display Method of Indoor Unit				A/C status	Possible Causes
		Dual-8 Code Display	Indicator Display (during blinking, ON 0.5s and OFF 0.5s)				
			Operation Indicator	Cool Indicator	Heating Indicator		
34	System is abnormal	H4				During cooling and drying operation, compressor will stop while indoor fan will operate; During heating operation, the complete unit will stop operation.	Refer to the malfunction analysis (overload, high temperature resistant)
35	IPM protection	H5				During cooling and drying operation, compressor will stop while indoor fan will operate; During heating operation, the complete unit will stop operation.	Refer to the malfunction analysis (IPM protection, loss of synchronism protection and overcurrent protection of phase current for compressor.
36	Internal motor (fan motor) do not operate	H6				Internal fan motor, external fan motor, compressor and electric heater stop operation,guide louver stops at present location.	<ol style="list-style-type: none"> <li>1. Bad contact of DC motor feedback terminal.</li> <li>2. Bad contact of DC motor control end.</li> <li>3. Fan motor is stalling.</li> <li>4. Motor malfunction.</li> <li>5. Malfunction of mainboard rev detecting circuit.</li> </ol>
37	Desynchronizing of compressor	H7				During cooling and drying operation, compressor will stop while indoor fan will operate; During heating operation, the complete unit will stop operation.	Refer to the malfunction analysis (IPM protection, loss of synchronism protection and overcurrent protection of phase current for compressor.
38	PFC protection	HC				During cooling and drying operation, compressor will stop while indoor fan will operate; During heating operation, the complete unit will stop operation.	Refer to the malfunction analysis
39	Outdoor DC fan motor malfunction	L3				Outdoor DC fan motor malfunction lead to compressor stop operation,	DC fan motor malfunction or system blocked or the connector loosed
40	power protection	L9				compressor stop operation and Outdoor fan motor will stop 30s latter , 3 minutes latter fan motor and compressor will restart	To protect the electrical components when detect high power
41	Indoor unit and outdoor unit doesn't match	LP				compressor and Outdoor fan motor can't work	Indoor unit and outdoor unit doesn't match
42	Failure start-up	LC				During cooling and drying operation, compressor will stop while indoor fan will operate; During heating operation, the complete unit will stop operation.	Refer to the malfunction analysis



NO.	Malfunction Name	Display Method of Indoor Unit				A/C status	Possible Causes
		Dual-8 Code Display	Indicator Display (during blinking, ON 0.5s and OFF 0.5s)				
			Operation Indicator	Cool Indicator	Heating Indicator		
43	Malfunction of phase current detection circuit for compressor	U1				During cooling and drying operation, compressor will stop while indoor fan will operate; During heating operation, the complete unit will stop	Replace outdoor control panel AP1
44	Malfunction of voltage dropping for DC bus-bar	U3				During cooling and drying operation, compressor will stop while indoor fan will operate; During heating operation, the complete unit will stop	Supply voltage is unstable
45	Malfunction of complete units current detection	U5				During cooling and drying operation, the compressor will stop while indoor fan will operate; During heating operating, the complete unit will stop operation.	Theres circuit malfunction on outdoor units control panel AP1, please replace the outdoor units control panel AP1.
46	The four-way valve is abnormal	U7				If this malfunction occurs during heating operation, the complete unit will stop operation.	1. Supply voltage is lower than AC175V; 2. Wiring terminal 4V is loosened or broken; 3. 4V is damaged, please replace 4V.
47	Zero-crossing malfunction of outdoor unit	U9				During cooling operation, compressor will stop while indoor fan will operate; during heating, the complete unit will stop operation.	Replace outdoor control panel AP1
48	Frequency limiting (power)						
49	Compressor running						
50	The temperature for turning on the unit is reached						
51	Frequency limiting (module temperature)						

NO.	Malfunction Name	Display Method of Indoor Unit				A/C status	Possible Causes
		Dual-8 Code Display	Indicator Display (during blinking, ON 0.5s and OFF 0.5s)				
			Operation Indicator	Cool Indicator	Heating Indicator		
52	Normal communication						
53	Defrosting		OFF 3S and blink once (during blinking, ON 10s and OFF 0.5s)			Defrosting will occur in heating mode. Compressor will operate while indoor fan will stop operation.	Its the normal state
54	Malfunction of zero-cross detection circuit	U8				The complete unit stops	1.Power supply is abnormal; 2.Detection circuit of indoor control mainboard is abnormal.
55	Malfunction of detecting plate(WIFI )	JF					

## 9.2 Procedure of Troubleshooting

### 1. Malfunction of Temperature Sensor F1, F2

Main detection points:

- Is the wiring terminal between the temperature sensor and the controller loosened or poorly contacted?
- Is there short circuit due to trip-over of the parts?
- Is the temperature sensor broken?
- Is mainboard broken?

Malfunction diagnosis process:

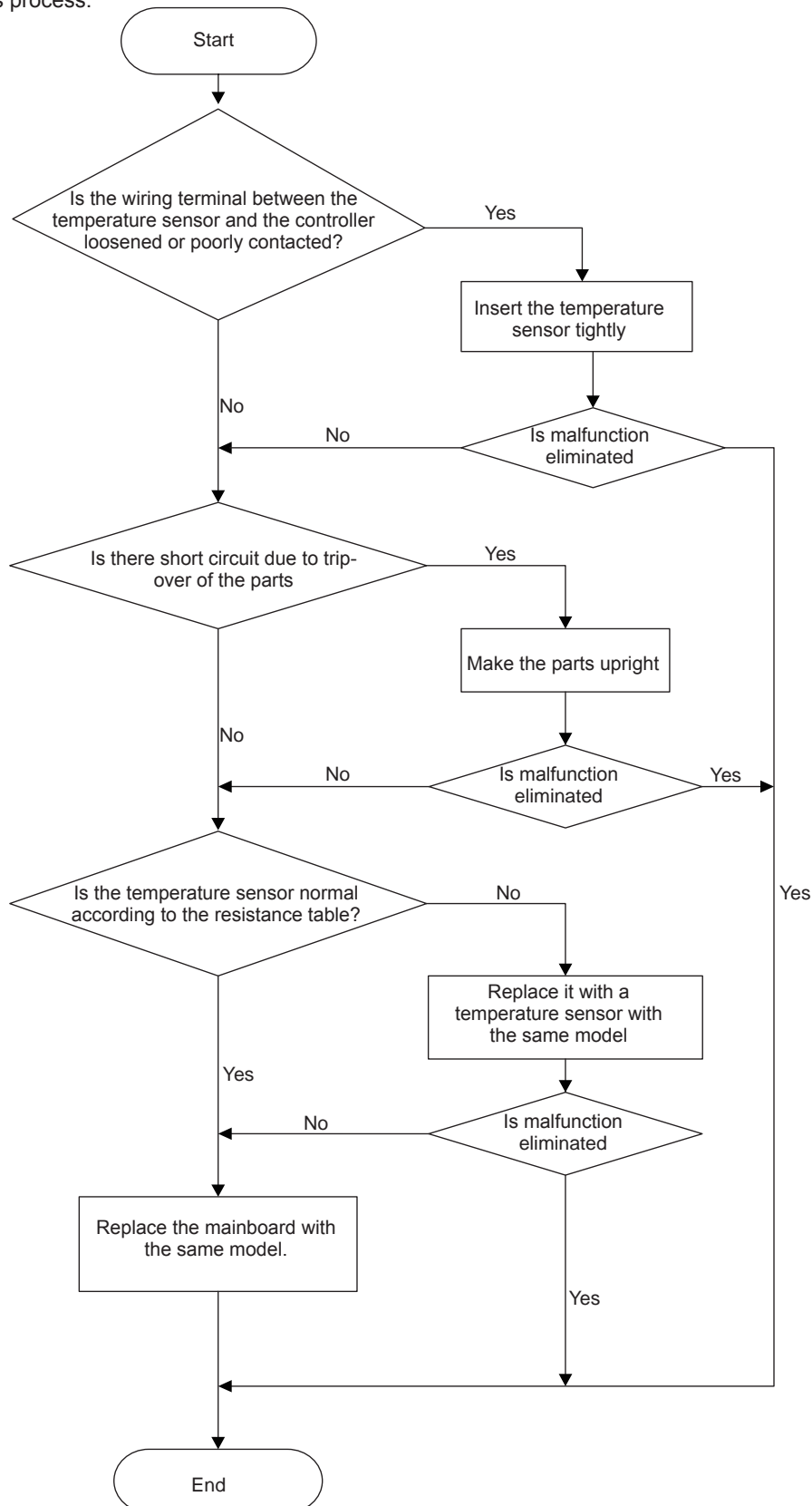

## 2. Malfunction of Blocked Protection of IDU Fan Motor H6

Main detection points:

- Smoothly is the control terminal of PG motor connected tightly?
- Smoothly is the feedback interface of PG motor connected tightly?
- The fan motor can't operate?
- The motor is broken?
- Detection circuit of the mainboard is defined abnormal?

Malfunction diagnosis process:

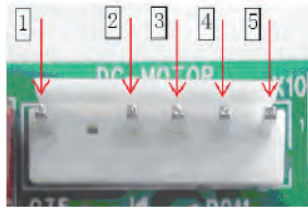
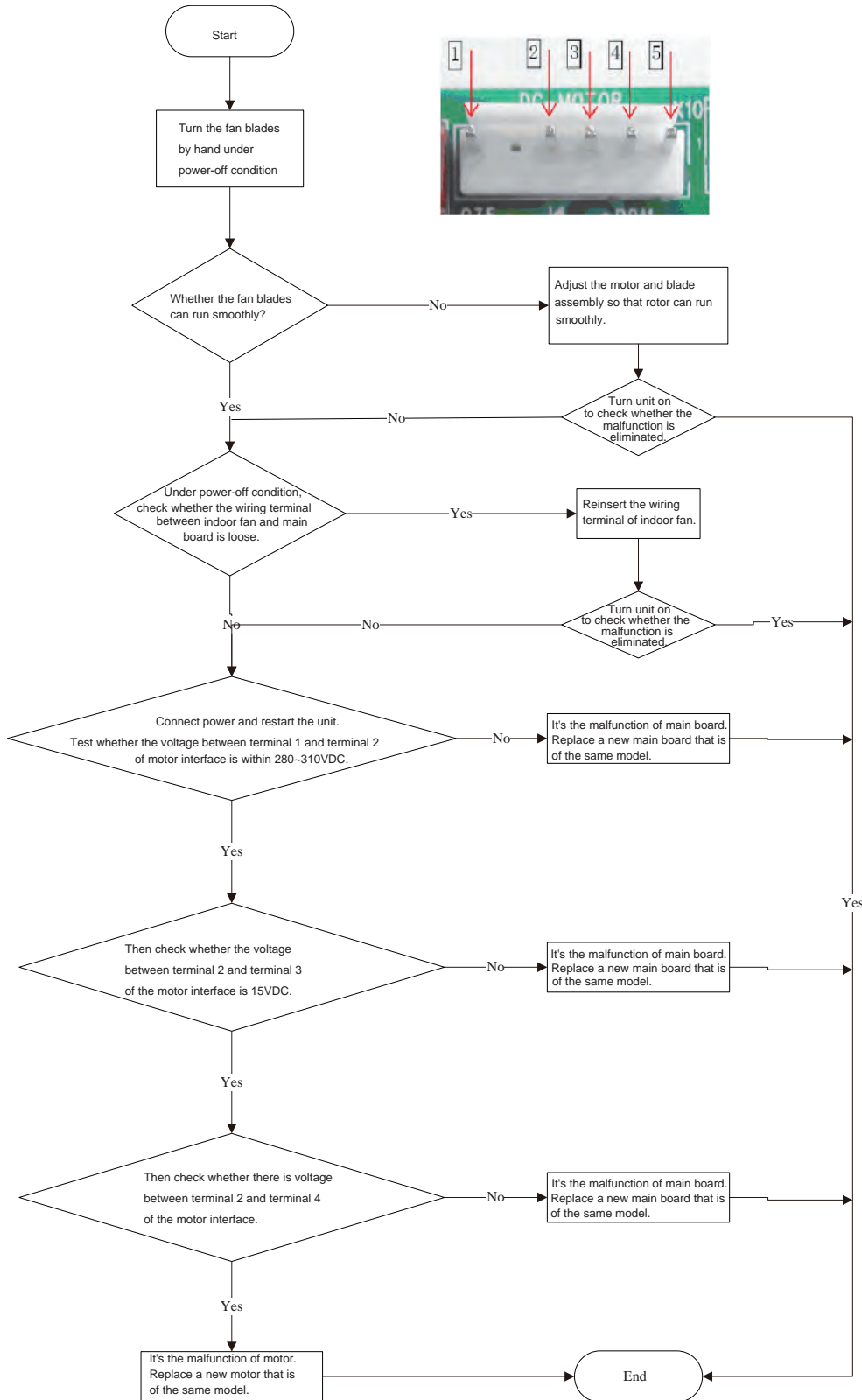

### 3. Malfunction of Protection of Jumper Cap C5

Main detection points:

- Is there jumper cap on the mainboard?
- Is the jumper cap inserted correctly and tightly?
- The jumper is broken?
- The motor is broken?
- Detection circuit of the mainboard is defined abnormal?

Malfunction diagnosis process:

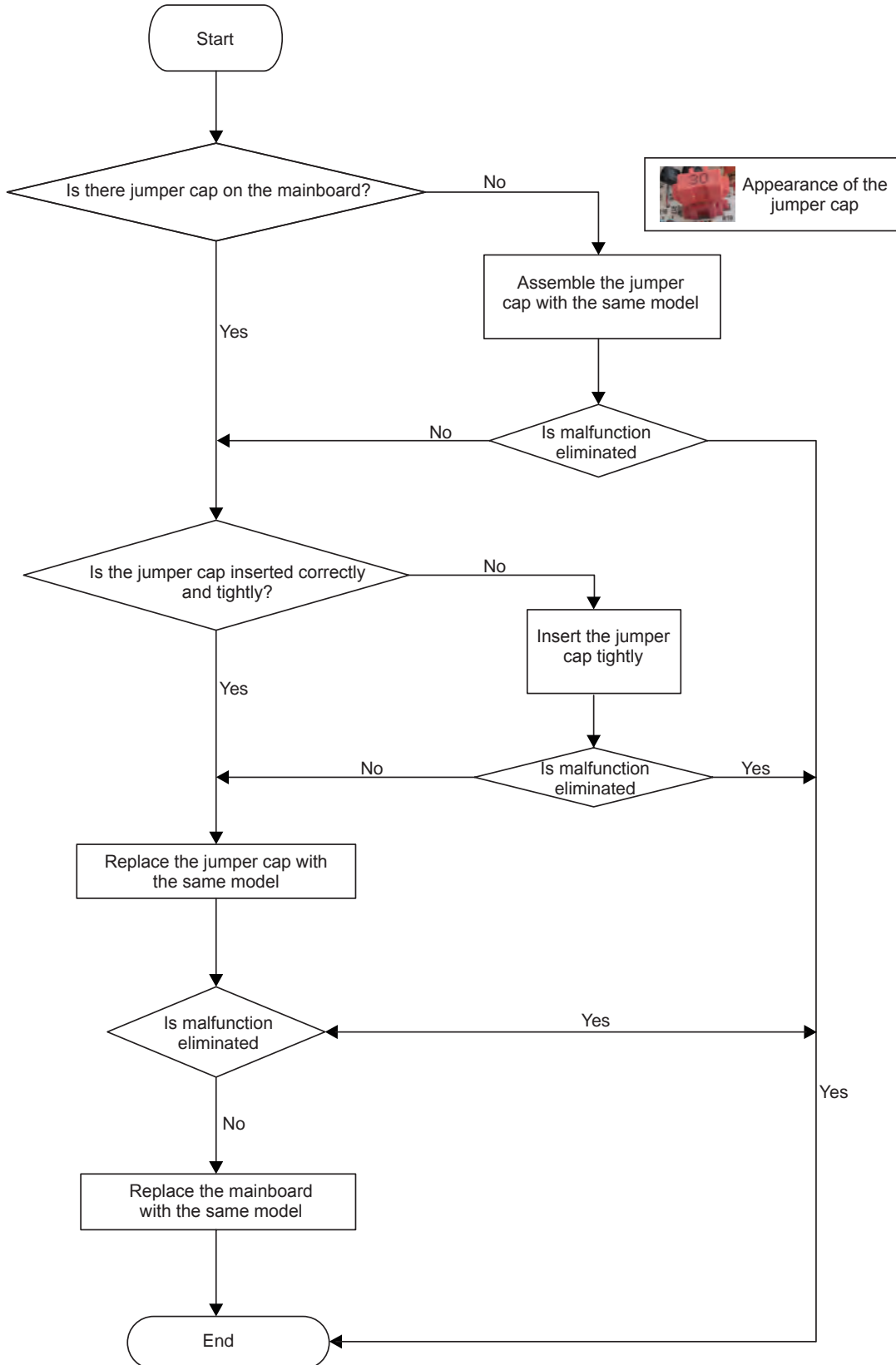

#### 4. Malfunction of Overcurrent Protection E5

Main detection points:

- Is the supply voltage unstable with big fluctuation?
- Is the supply voltage too low with overload?
- Hardware trouble?

Malfunction diagnosis process:

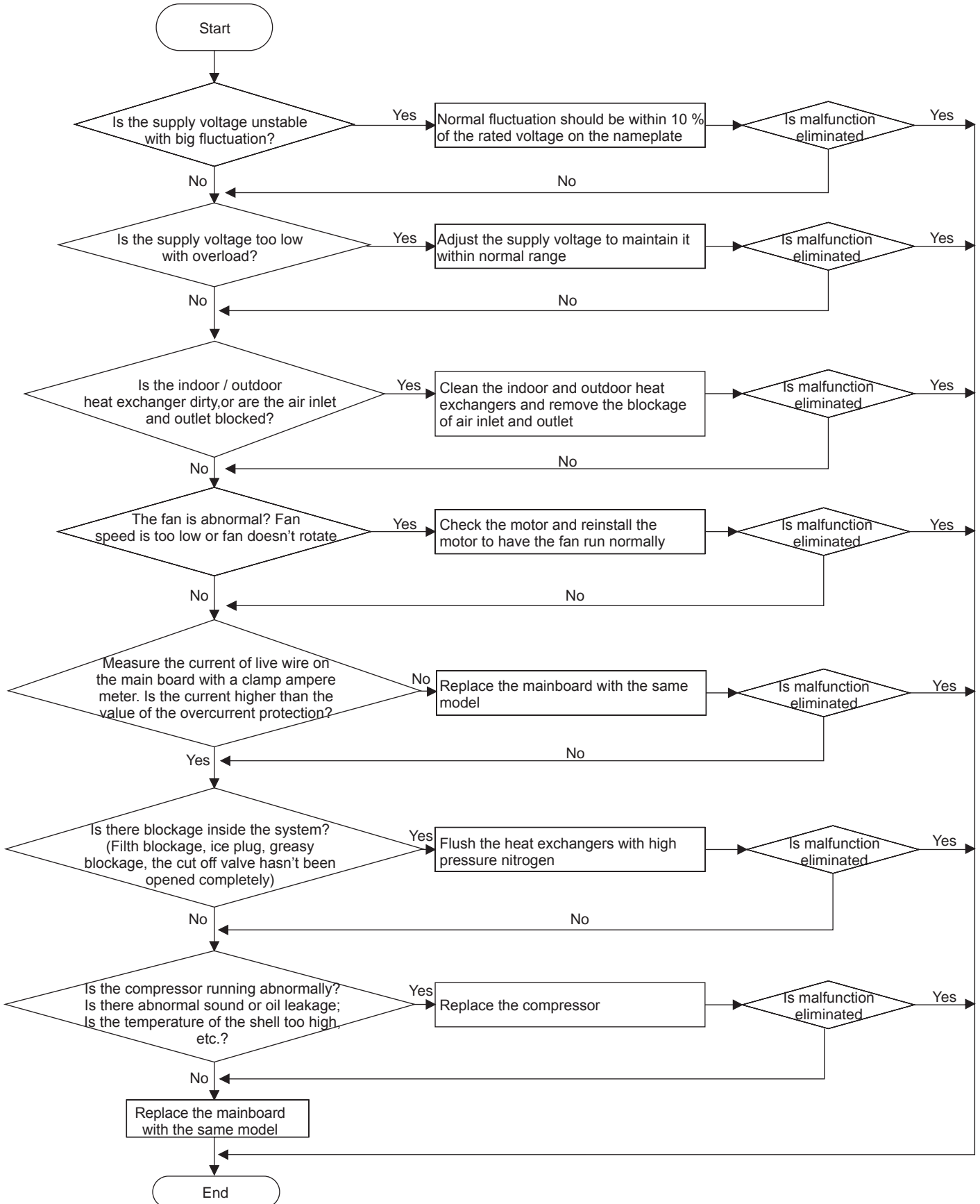

5. Communication Malfunction E6

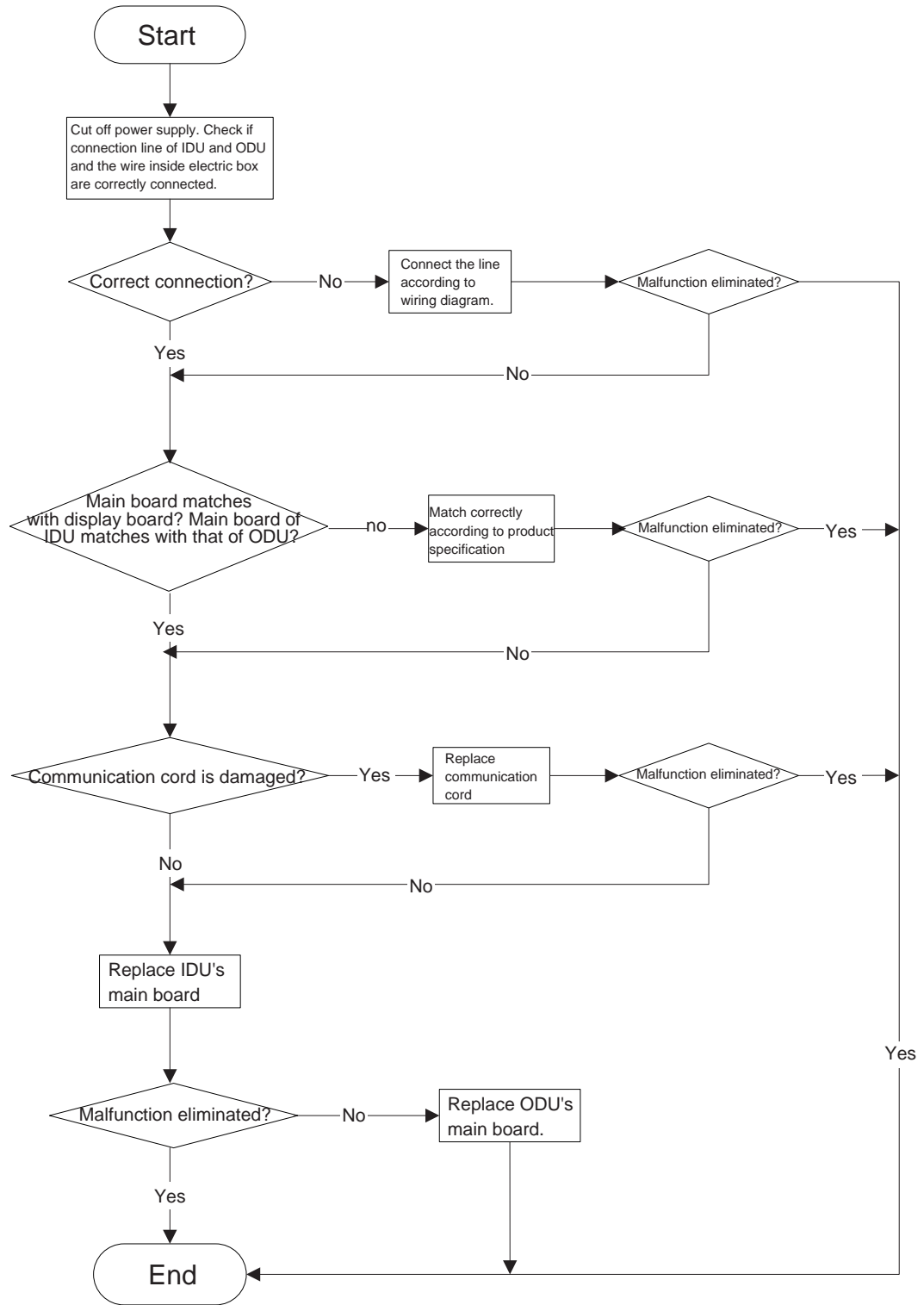



### 6. Malfunction of Zero-crossing Inspection Circuit Malfunction of the IDU Fan Motor U8

Main detection points:

- Instant energization after de-energization while the capacitor discharges slowly?
- The zero-cross detection circuit of the mainboard is defined abnormal?

Malfunction diagnosis process:

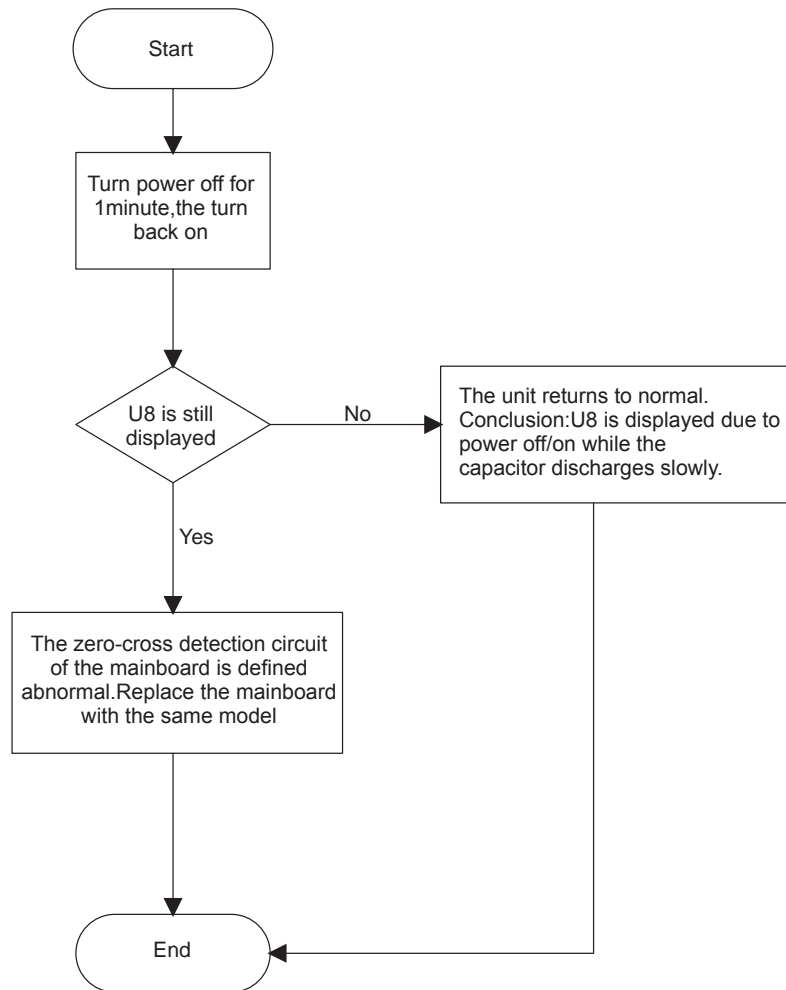

7. Malfunction of detecting plate(WIFI) JF

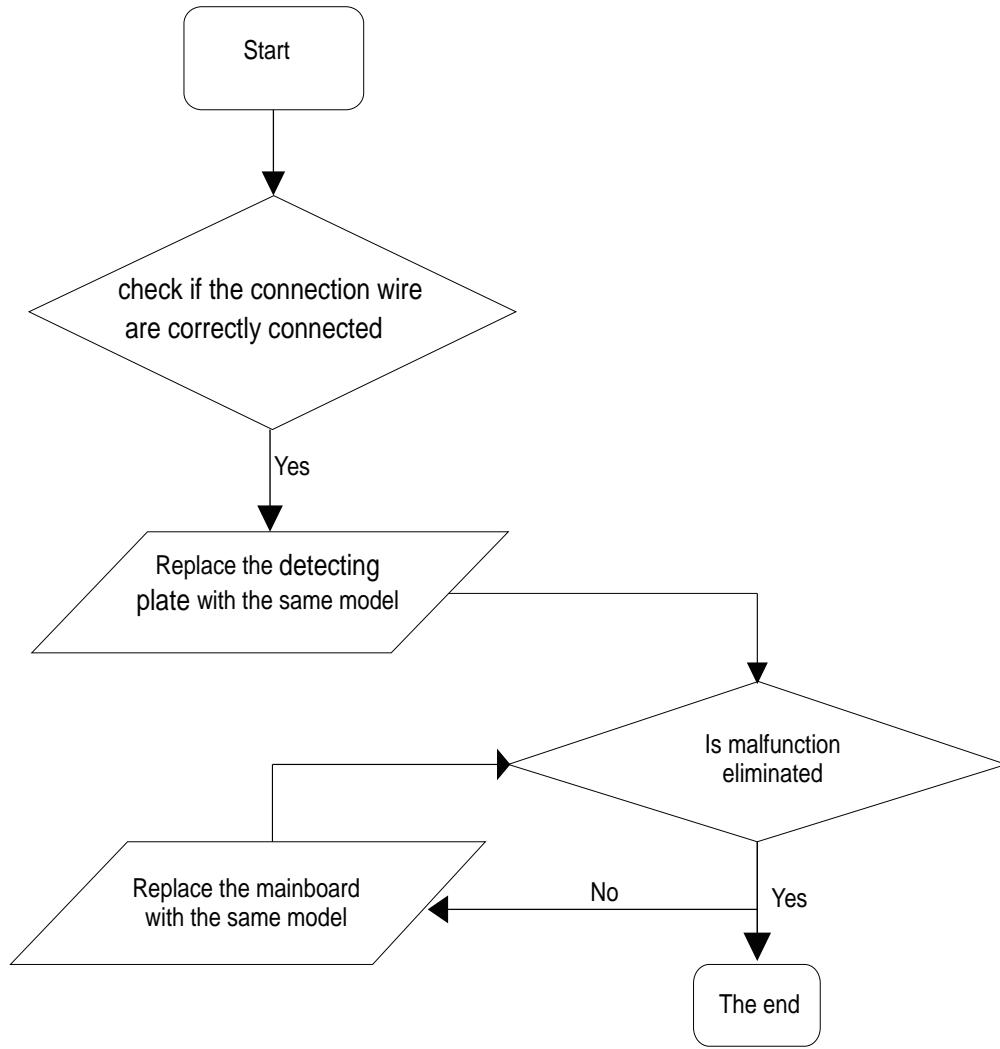

Outdoor Unit

1. Capacity charging malfunction (outdoor unit malfunction) (AP1 below means control board of outdoor unit)

Main detection points:

- Detect if the voltage of L and N terminal of XT wiring board is between 210VAC-240VAC by alternating voltage meter;
- Is reactor (L) well connected? Is connection wire loosened or pulled out? Is reactor (L) damaged?

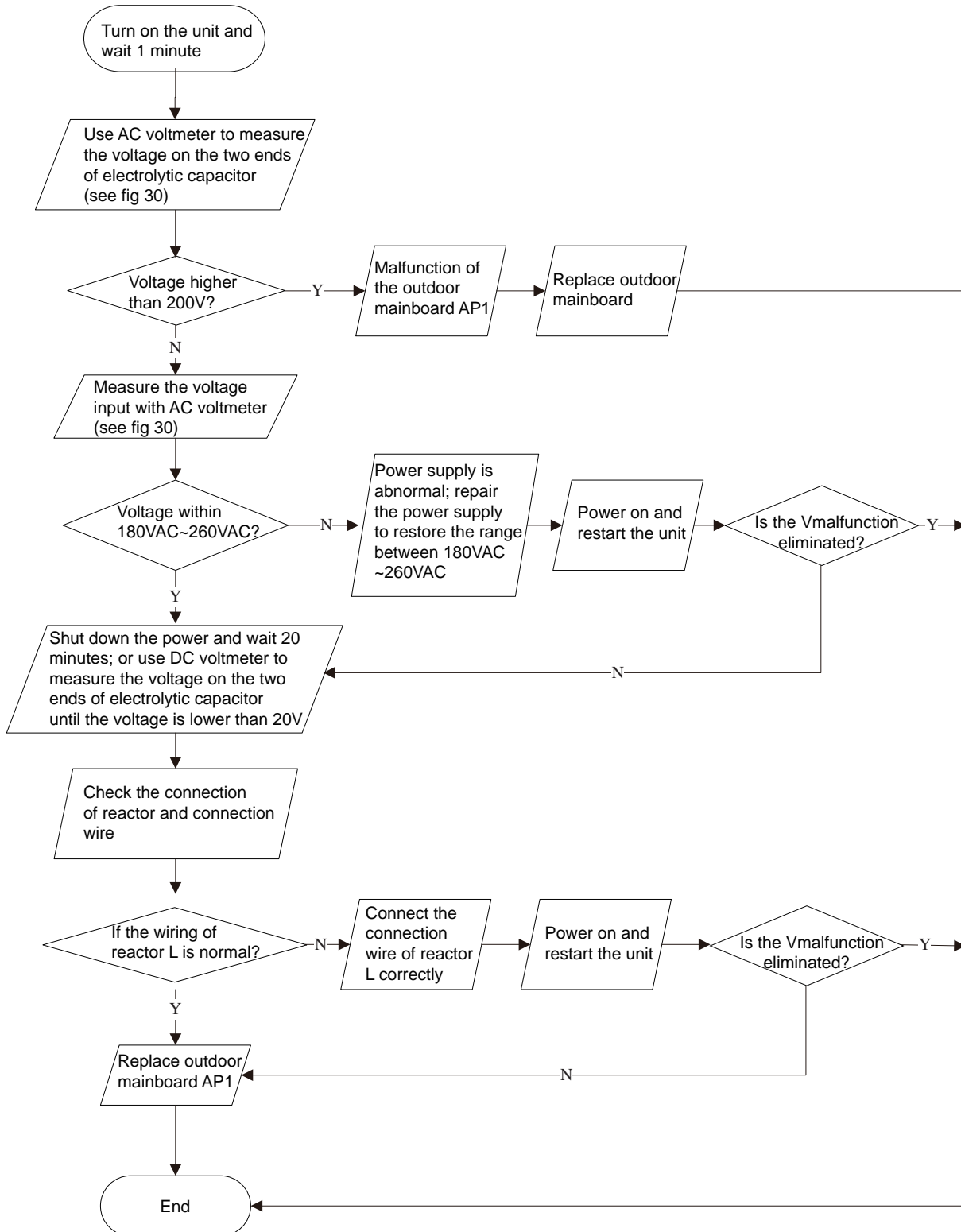

**2. IPM protection(H5), desynchronizing malfunction(H7), overcurrent of compressor phase current (P5) (AP1 below means control board of outdoor unit)**

Main detection points:

- Is voltage input within the normal range
- If the control board AP1 is well connected with compressor COMP? If they are loosened? If the connection sequence is correct?
- Heat exchange of unit is not good (heat exchanger is dirty and unit radiating environment is bad);
- If the system pressure is too high?
- If the refrigerant charging amount is appropriate?
- If coil resistance of compressor is normal? Is compressor coil insulating to copper pipe well?
- If the work load of unit is heavy? If radiating of unit is good?

Malfunction diagnosis process:

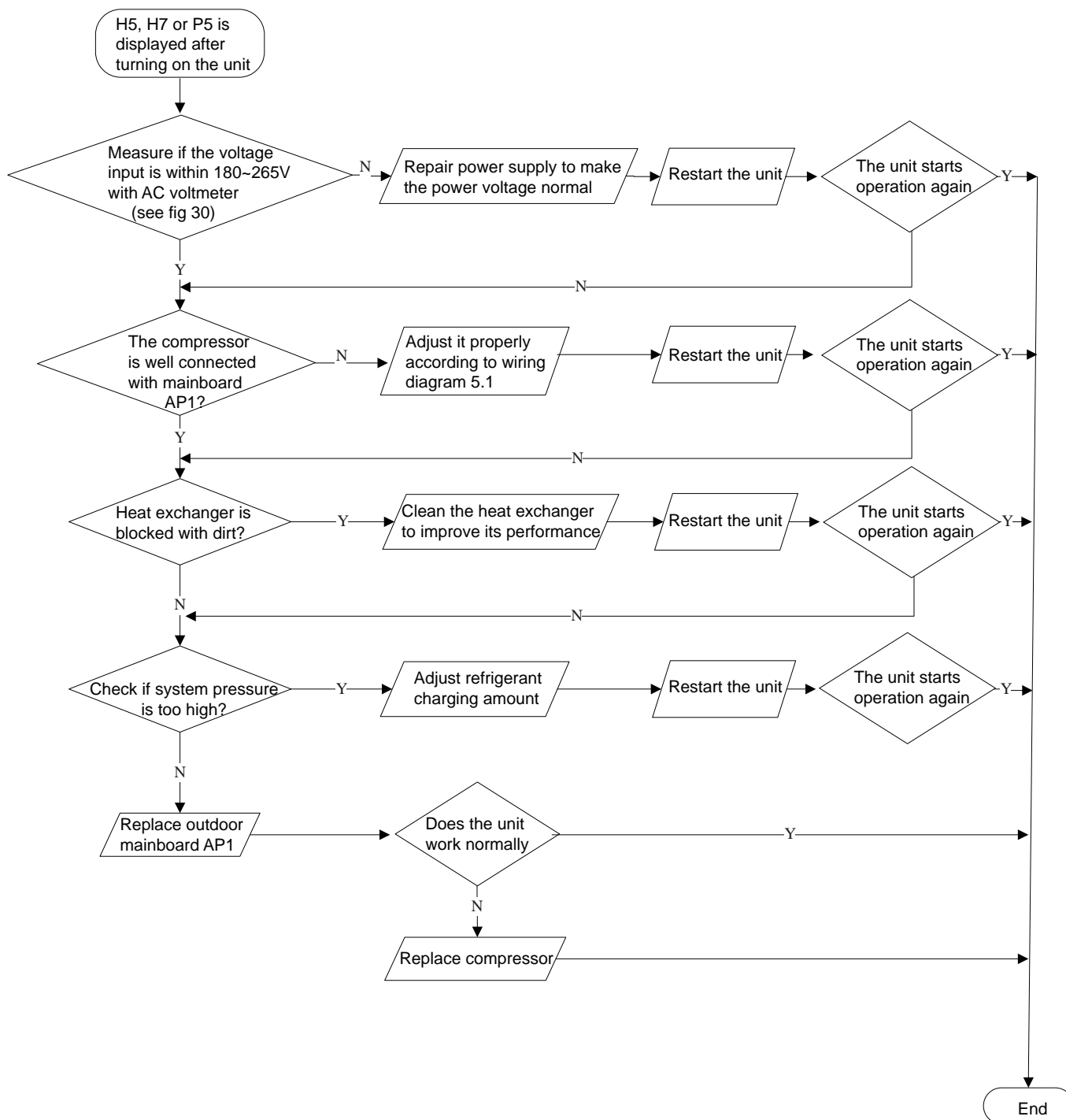

3. High temperature and overload protection (E8)(AP1 below means control board of outdoor unit)

Main detection points:

- If the outdoor ambient temperature is in normal range;
- If the indoor and outdoor fan are running normally;
- If the radiating environment of indoor and outdoor unit is good.

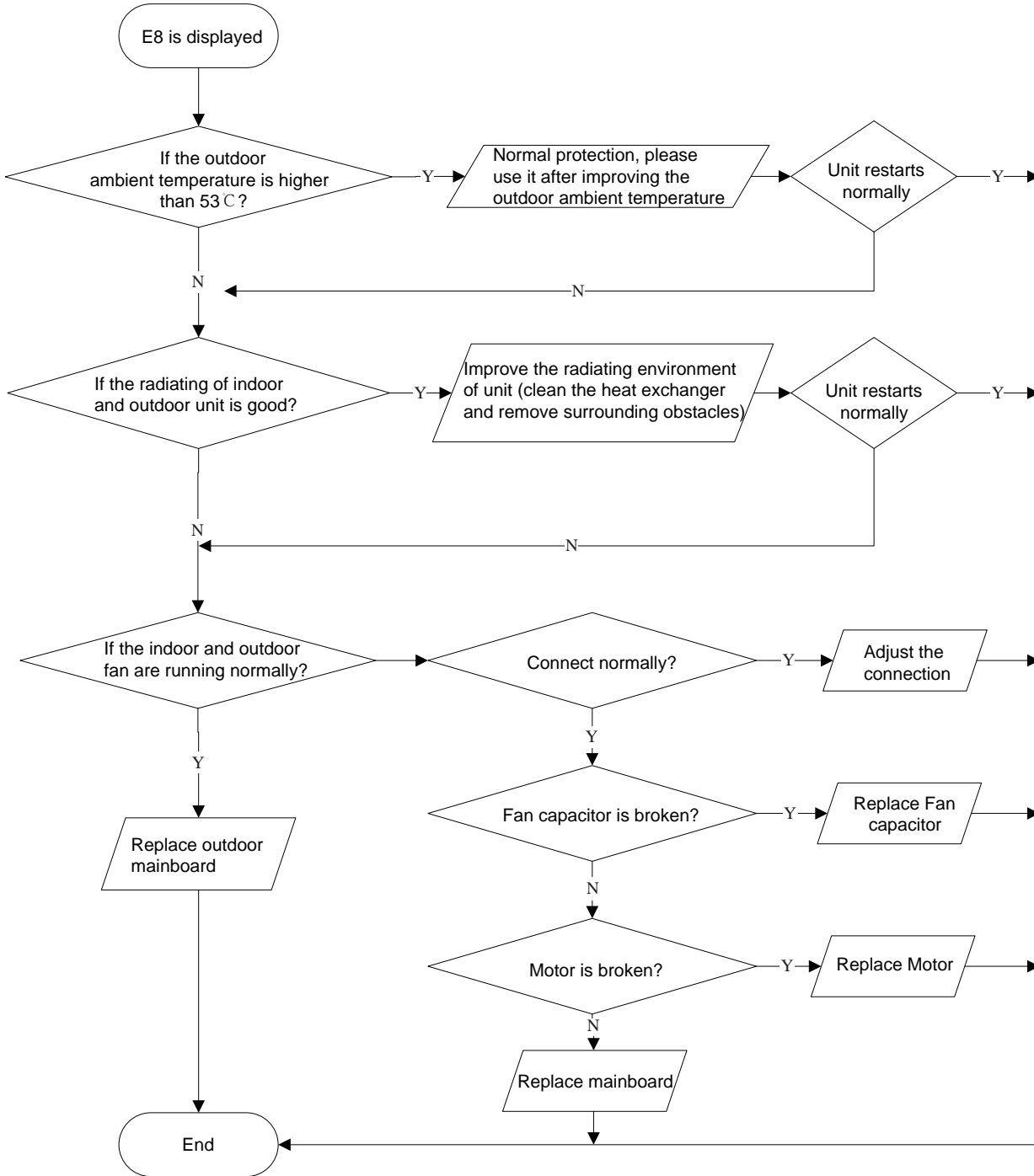

4. Start-up failure (LC) (AP1 below means control board of outdoor unit)

Main detection points:

- If the compressor wiring is correct?
- If the stop time of compressor is sufficient?
- If the compressor is damaged?
- If the refrigerant charging amount is too much?

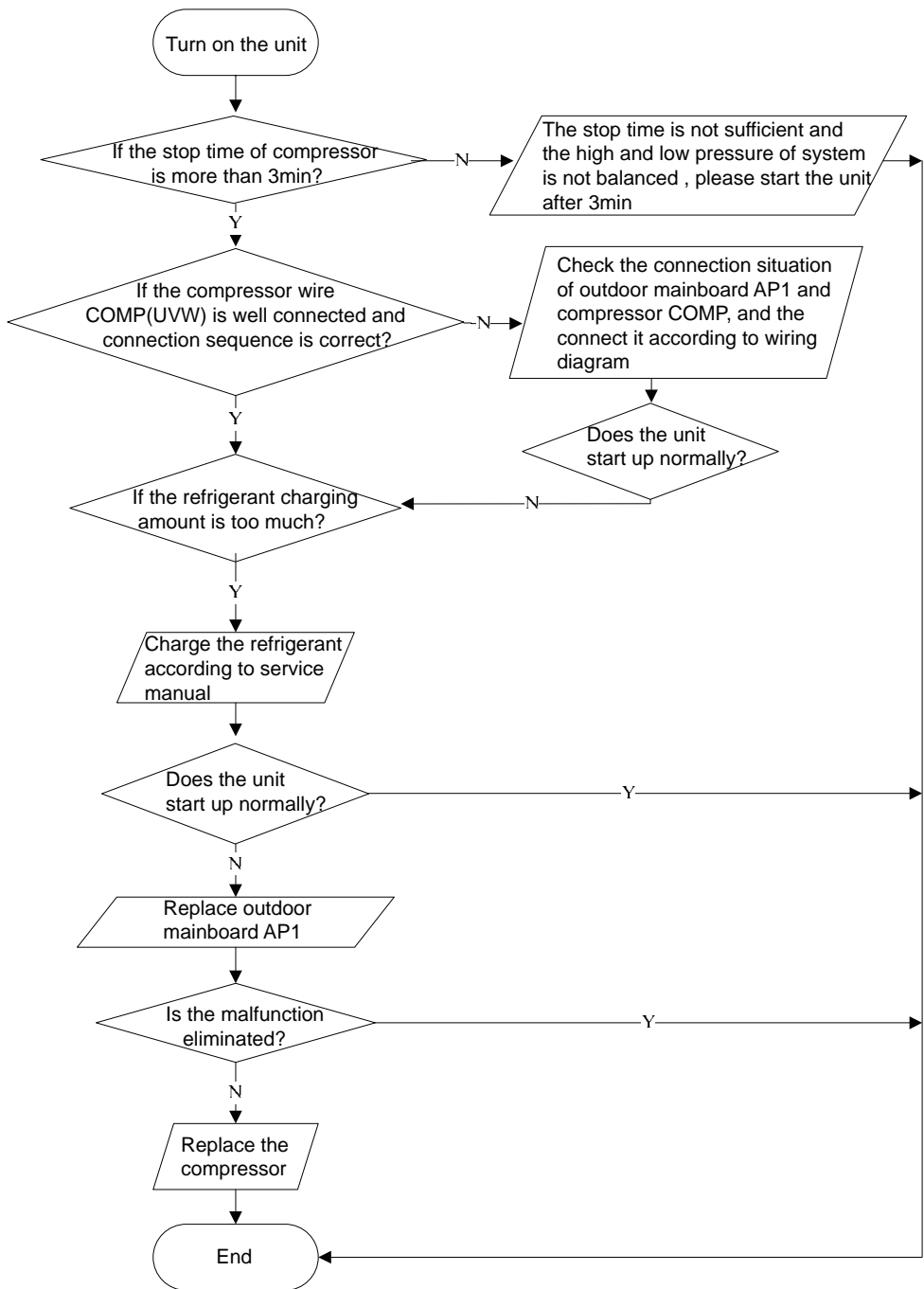

### 5. Overload and high discharge temperature malfunction

Main detection points:

- If the electronic expansion valve is connected well? Is the electronic expansion valve damaged?
- If the refrigerant is leaked?
- The compressor overload protection terminal is not connected well with the mainboard?
- If the overload protector is damaged?
- Heat exchange of unit is not good? (heat exchanger is dirty and unit radiating environment is bad)
- Too much load of the system causes high temperature of compressor after working for a long time?
- Malfunction of discharge temperature sensor?



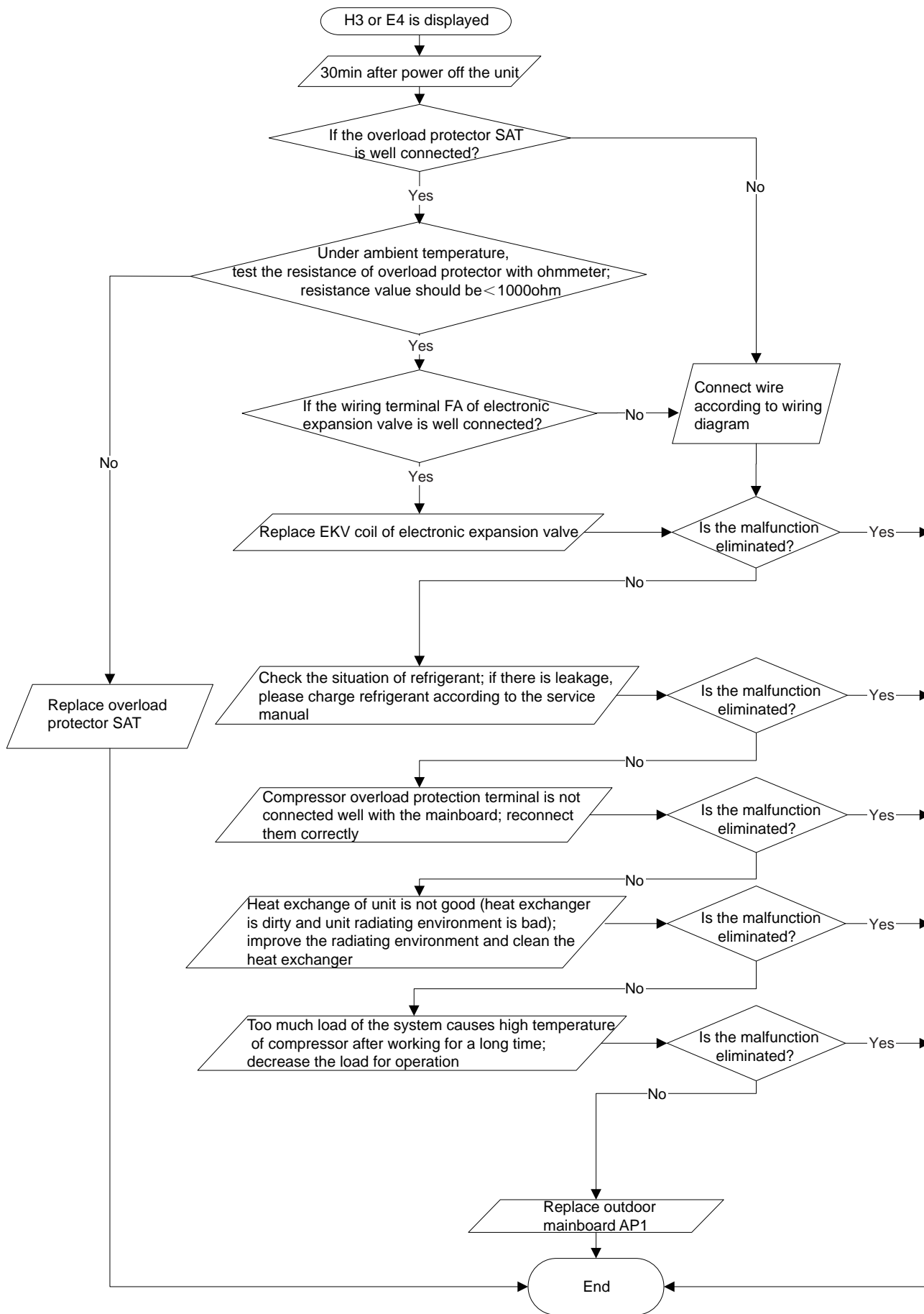

### 6. PFC (correction for power factor) malfunction (outdoor unit malfunction)

Main detection points:

- Check if power plug is connected well with the socket
- Check if the reactor of outdoor unit is damaged?

Malfunction diagnosis process:

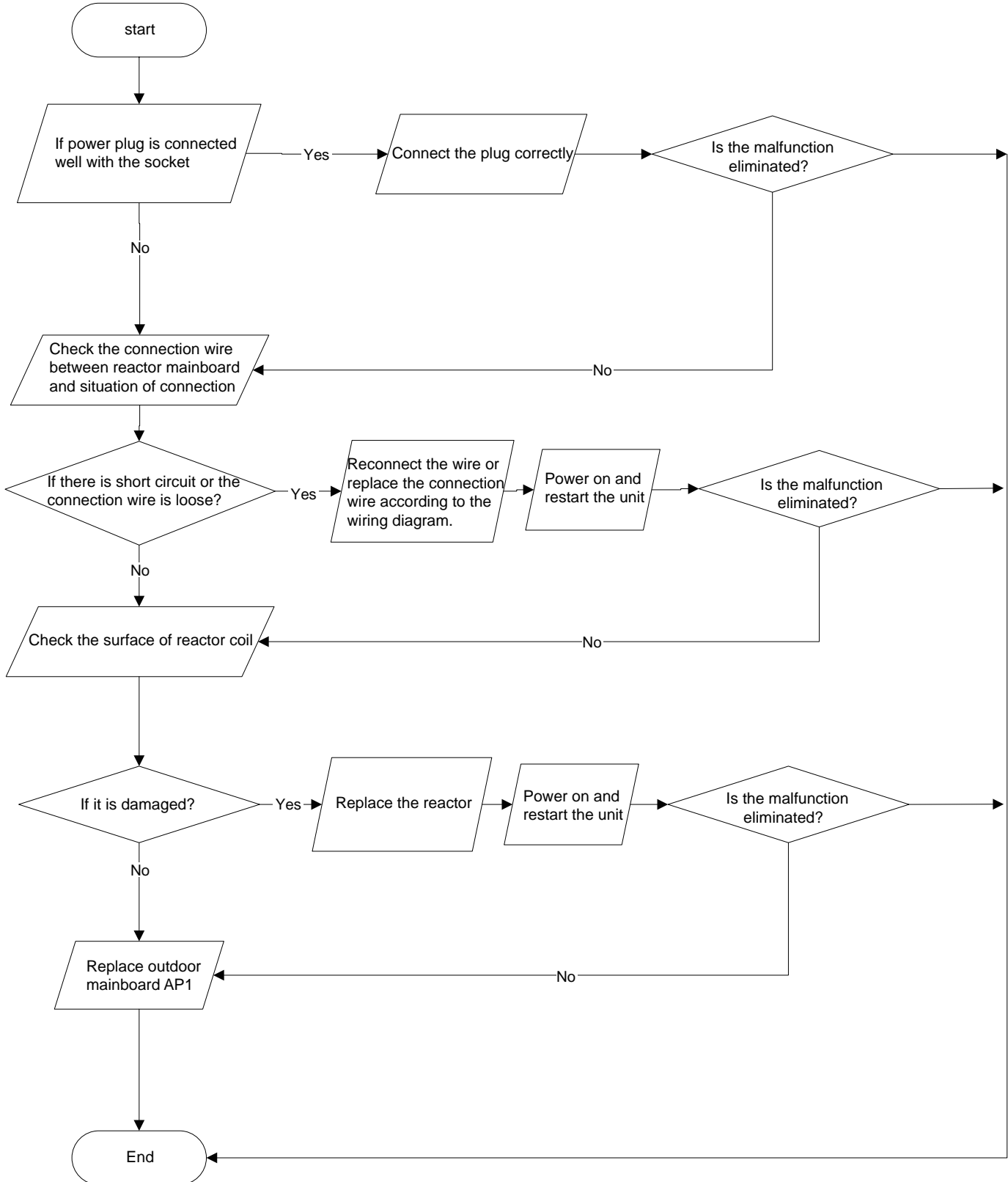

### 7. Communication malfunction (E6)

Main detection points:

- Check if the connection wire and the built-in wiring of indoor and outdoor unit are connected well and without damage;
- If the communication circuit of indoor mainboard is damaged? If the communication circuit of outdoor mainboard (AP1) is damaged?

Malfunction diagnosis process:

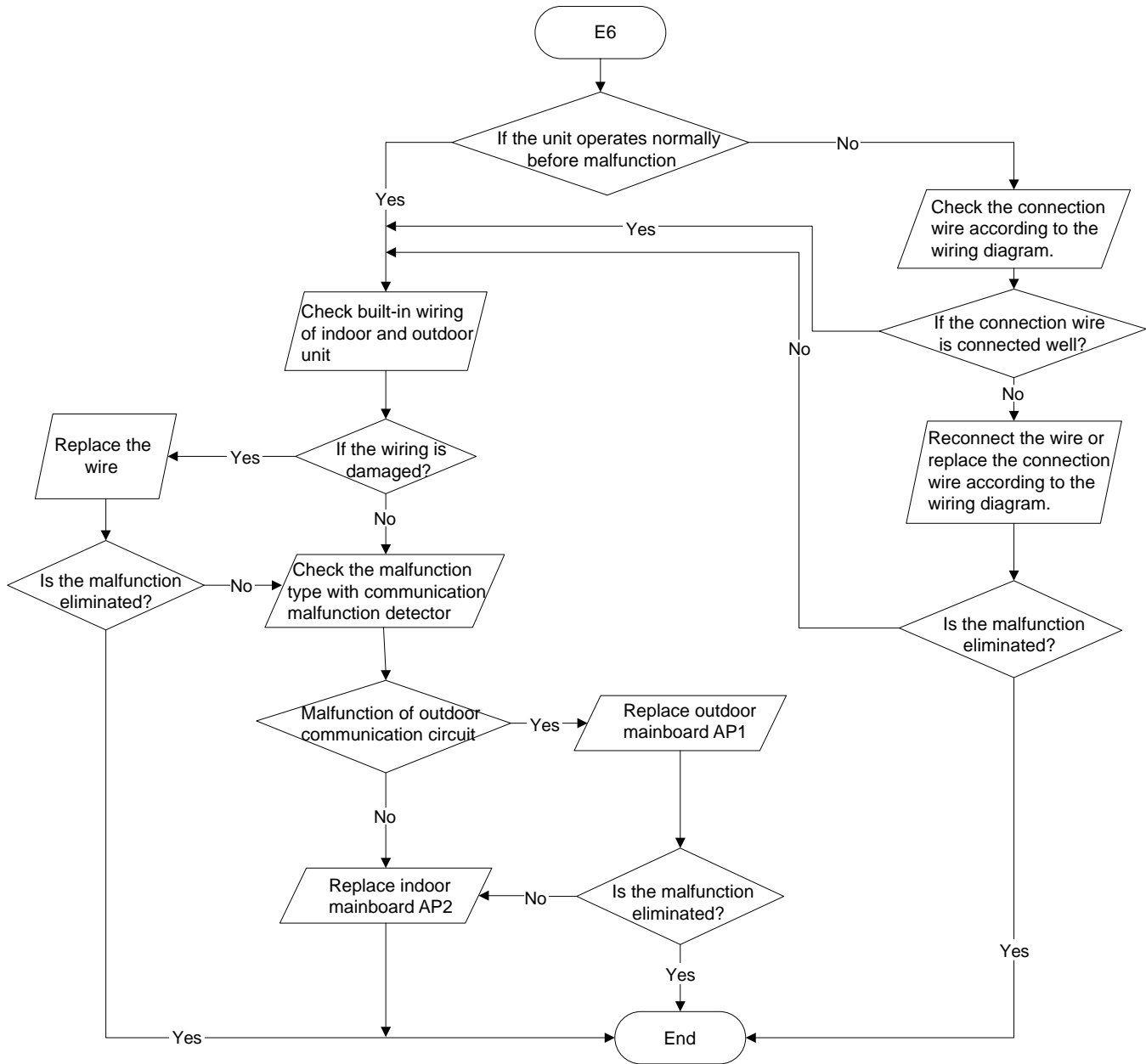

## 9.3 Maintenance Method for Normal Malfunction

### 1. Air Conditioner Can't be Started Up

Possible Causes	Discriminating Method (Air conditioner Status)	Troubleshooting
No power supply, or poor connection for power plug	After energization, operation indicator isn't bright and the buzzer can't give out sound	Confirm whether it's due to power failure. If yes, wait for power recovery. If not, check power supply circuit and make sure the power plug is connected well.
Wrong wire connection between indoor unit and outdoor unit, or poor connection for wiring terminals	Under normal power supply circumstances, operation indicator isn't bright after energization	Check the circuit according to circuit diagram and connect wires correctly. Make sure all wiring terminals are connected firmly
Electric leakage for air conditioner	After energization, room circuit breaker trips off at once	Make sure the air conditioner is grounded reliably Make sure wires of air conditioner is connected correctly Check the wiring inside air conditioner. Check whether the insulation layer of power cord is damaged; if yes, place the power cord.
Model selection for air switch is improper	After energization, air switch trips off	Select proper air switch
Malfunction of remote controller	After energization, operation indicator is bright, while no display on remote controller or buttons have no action.	Replace batteries for remote controller Repair or replace remote controller

### 2. Poor Cooling (Heating) for Air Conditioner

Possible Causes	Discriminating Method (Air conditioner Status)	Troubleshooting
Set temperature is improper	Observe the set temperature on remote controller	Adjust the set temperature
Rotation speed of the IDU fan motor is set too low	Small wind blow	Set the fan speed at high or medium
Filter of indoor unit is blocked	Check the filter to see it's blocked	Clean the filter
Installation position for indoor unit and outdoor unit is improper	Check whether the installation position is proper according to installation requirement for air conditioner	Adjust the installation position, and install the rainproof and sunproof for outdoor unit
Refrigerant is leaking	Discharged air temperature during cooling is higher than normal discharged wind temperature; Discharged air temperature during heating is lower than normal discharged wind temperature; Unit's pressure is much lower than regulated range	Find out the leakage causes and deal with it. Add refrigerant.
Malfunction of 4-way valve	Blow cold wind during heating	Replace the 4-way valve
Malfunction of capillary	Discharged air temperature during cooling is higher than normal discharged wind temperature; Discharged air temperature during heating is lower than normal discharged wind temperature; Unit's pressure is much lower than regulated range. If refrigerant isn't leaking, part of capillary is blocked	Replace the capillary
Flow volume of valve is insufficient	The pressure of valves is much lower than that stated in the specification	Open the valve completely
Malfunction of horizontal louver	Horizontal louver can't swing	Refer to point 3 of maintenance method for details
Malfunction of the IDU fan motor	The IDU fan motor can't operate	Refer to troubleshooting for H6 for maintenance method in details
Malfunction of the ODU fan motor	The ODU fan motor can't operate	Refer to point 4 of maintenance method for details
Malfunction of compressor	Compressor can't operate	Refer to point 5 of maintenance method for details

### 3. Horizontal Louver Can't Swing

Possible Causes	Discriminating Method (Air conditioner Status)	Troubleshooting
Wrong wire connection, or poor connection	Check the wiring status according to circuit diagram	Connect wires according to wiring diagram to make sure all wiring terminals are connected firmly
Stepping motor is damaged	Stepping motor can't operate	Repair or replace stepping motor
Main board is damaged	Others are all normal, while horizontal louver can't operate	Replace the main board with the same model

**4. ODU Fan Motor Can't Operate**

Possible causes	Discriminating method (air conditioner status)	Troubleshooting
Wrong wire connection, or poor connection	Check the wiring status according to circuit diagram	Connect wires according to wiring diagram to make sure all wiring terminals are connected firmly
Capacity of the ODU fan motor is damaged	Measure the capacity of fan capacitor with an universal meter and find that the capacity is out of the deviation range indicated on the nameplate of fan capacitor.	Replace the capacity of fan
Power voltage is a little low or high	Use universal meter to measure the power supply voltage. The voltage is a little high or low	Suggest to equip with voltage regulator
Motor of outdoor unit is damaged	When unit is on, cooling/heating performance is bad and ODU compressor generates a lot of noise and heat.	Change compressor oil and refrigerant. If no better, replace the compressor with a new one

**5. Compressor Can't Operate**

Possible causes	Discriminating method (air conditioner status)	Troubleshooting
Wrong wire connection, or poor connection	Check the wiring status according to circuit diagram	Connect wires according to wiring diagram to make sure all wiring terminals are connected firmly
Capacity of compressor is damaged	Measure the capacity of fan capacitor with an universal meter and find that the capacity is out of the deviation range indicated on the nameplate of fan capacitor.	Replace the compressor capacitor
Power voltage is a little low or high	Use universal meter to measure the power supply voltage. The voltage is a little high or low	Suggest to equip with voltage regulator
Coil of compressor is burnt out	Use universal meter to measure the resistance between compressor terminals and it's 0	Repair or replace compressor
Cylinder of compressor is blocked	Compressor can't operate	Repair or replace compressor

**6. Air Conditioner is Leaking**

Possible causes	Discriminating method (air conditioner status)	Troubleshooting
Drain pipe is blocked	Water leaking from indoor unit	Eliminate the foreign objects inside the drain pipe
Drain pipe is broken	Water leaking from drain pipe	Replace drain pipe
Wrapping is not tight	Water leaking from the pipe connection place of indoor unit	Wrap it again and bundle it tightly

**7. Abnormal Sound and Vibration**

Possible causes	Discriminating method (air conditioner status)	Troubleshooting
When turn on or turn off the unit, the panel and other parts will expand and there's abnormal sound	There's the sound of "PAPA"	Normal phenomenon. Abnormal sound will disappear after a few minutes.
When turn on or turn off the unit, there's abnormal sound due to flow of refrigerant inside air conditioner	Water-running sound can be heard	Normal phenomenon. Abnormal sound will disappear after a few minutes.
Foreign objects inside the indoor unit or there're parts touching together inside the indoor unit	There's abnormal sound fro indoor unit	Remove foreign objects. Adjust all parts' position of indoor unit, tighten screws and stick damping plaster between connected parts
Foreign objects inside the outdoor unit or there're parts touching together inside the outdoor unit	There's abnormal sound fro outdoor unit	Remove foreign objects. Adjust all parts' position of outdoor unit, tighten screws and stick damping plaster between connected parts
Short circuit inside the magnetic coil	During heating, the way valve has abnormal electromagnetic sound	Replace magnetic coil
Abnormal shake of compressor	Outdoor unit gives out abnormal sound	Adjust the support foot mat of compressor, tighten the bolts
Abnormal sound inside the compressor	Abnormal sound inside the compressor	If add too much refrigerant during maintenance, please reduce refrigerant properly. Replace compressor for other circumstances.

# 10. Exploded View and Parts List

## 10.1 Indoor Unit

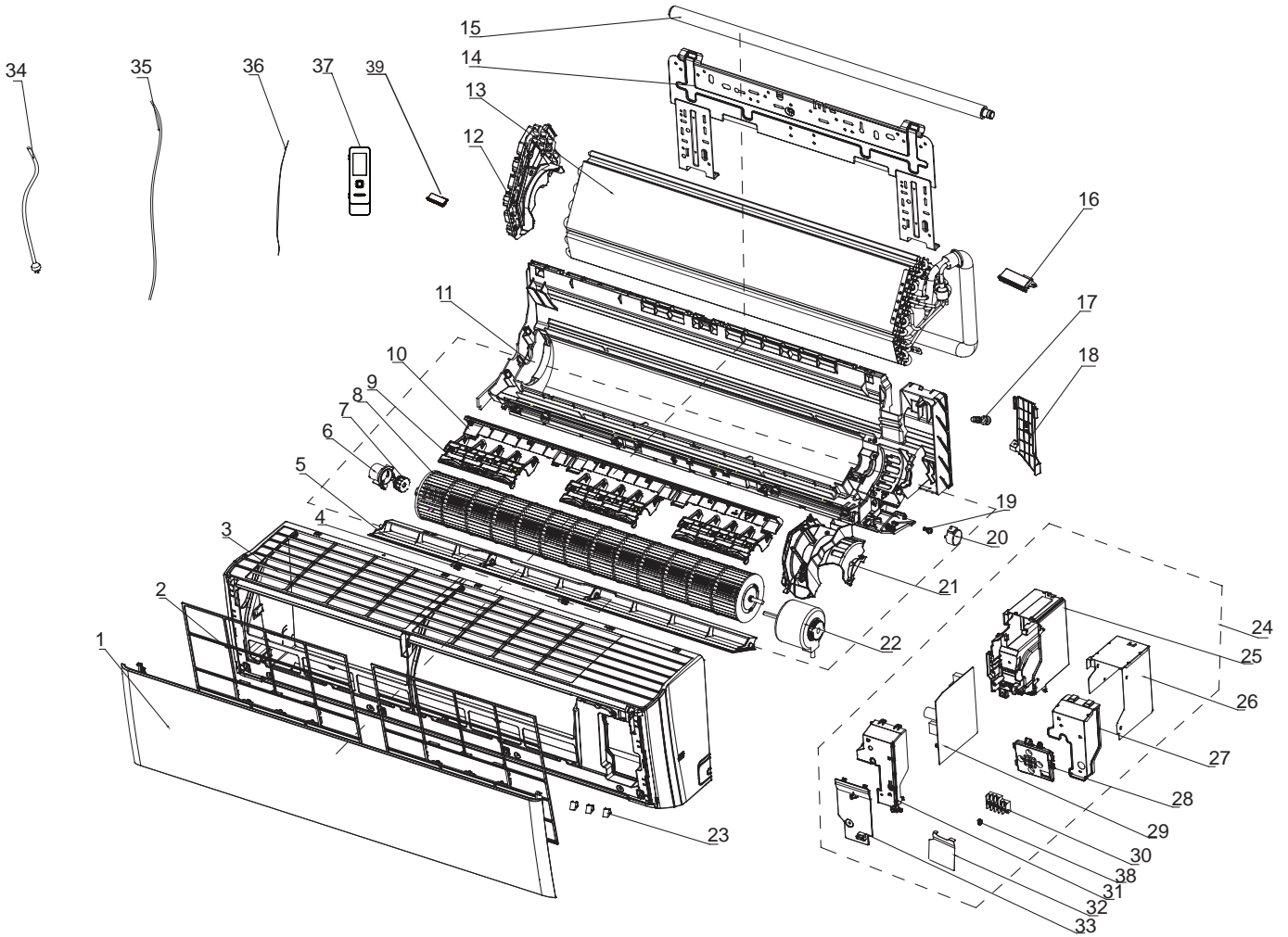

The component picture is only for reference; please refer to the actual product.

No.	Description	Part Code		Qty
		GWH09YD-S6DBA2A/I	GWH12YD-S6DBA2A/I	
	Product Code	CB466N00100	CB466N00200	
1	Front Panel	00000300008303	00000300008303	1
2	Filter Sub-Assy	11122089	11122089	2
3	Front Case Sub-Assy	00000200060	00000200060	1
4	Axile Bush	10542036	10542036	2
5	Guide Louver	10512501	10512501	1
6	Ring of Bearing	26152025	26152025	1
7	O-Gasket of Cross Fan Bearing	76512203	76512203	1
8	Cross Flow Fan	10352060	10352060	1
9	Air Louver(Manual)	10512501	10512501	1
10	Helicoid Tongue	26112512	26112512	1
11	Rear Case assy	00000100177	00000100177	1
12	Evaporator Support	24212177	24212177	1
13	Evaporator Assy	011001000472	011001000472	1
14	Wall Mounting Frame	01362026	01362026	1
15	Drainage Hose	05230014	05230014	1
16	Cold Plasma Generator	1114001602	1114001602	1
17	Rubber Plug (Water Tray)	76712012	76712012	1
18	Connecting pipe clamp	2611218801	2611218801	1
19	Crank	73012005	73012005	1
20	Stepping Motor	1521240212/1521210704	1521240212/1521210704	1
21	Motor Press Plate	26112511	26112511	1
22	Fan Motor	15012136	15012136	1
23	Screw Cover	2425201726	2425201726	3
24	Electric Box Assy	100002000983	100002000983	1
25	Electric Box	2011221102	2011221102	1
26	Lower Shield of Electric Box	01592139	01592139	1
27	Shield Cover of Electric Box	01592176	01592176	1
28	Display Board	300001000095	300001000095	1
29	Main Board	300002000101	300002000101	1
30	Terminal Board	42011233	42011233	1
31	Electric Box Cover	20112209	20112209	1
32	Electric Box Cover2	20112210	20112210	1
33	Shield Cover of Electric Box Cover 2	01202000099	01202000099	1
34	Connecting Cable	4002052317	4002052317	0
35	Connecting Cable	/	/	/
36	Temperature Sensor	3900031302	3900031302	1
37	Remote Controller	30510137	30510137	1
38	Jumper	4202021911	4202021911	1
39	Detecting Plate	000409000001	000409000001	1

Above data is subject to change without notice.



No.	Description	Part Code	
		GWH09YD-S6DBA2A/I	
		Product Code	
		CB466N00102	
1	Front Panel	00000300008303	1
2	Filter Sub-Assy	11122089	2
3	Front Case Sub-Assy	00000200060	1
4	Axile Bush	10542036	2
5	Guide Louver	10512501	1
6	Ring of Bearing	26152025	1
7	O-Gasket of Cross Fan Bearing	76512203	1
8	Cross Flow Fan	10352060	1
9	Air Louver(Manual)	10512501	1
10	Helicoid Tongue	26112512	1
11	Rear Case assy	00000100177	1
12	Evaporator Support	24212177	1
13	Evaporator Assy	011001000472	1
14	Wall Mounting Frame	01362026	1
15	Drainage Hose	05230014	1
16	Cold Plasma Generator	1114001602	1
17	Rubber Plug (Water Tray)	76712012	1
18	Connecting pipe clamp	2611218801	1
19	Crank	73012005	1
20	Stepping Motor	1521240212	1
21	Motor Press Plate	26112511	1
22	Fan Motor	15012136	1
23	Screw Cover	2425201726	3
24	Electric Box Assy	100002004024	1
25	Electric Box	2011221102	1
26	Lower Shield of Electric Box	01592139	1
27	Shield Cover of Electric Box	01592176	1
28	Display Board	300001000095	1
29	Main Board	300002000858	1
30	Terminal Board	42011233	1
31	Electric Box Cover	20112209	1
32	Electric Box Cover2	20112210	1
33	Shield Cover of Electric Box Cover 2	01202000099	1
34	Connecting Cable	4002052317	0
35	Connecting Cable	/	/
36	Temperature Sensor	3900031302	1
37	Remote Controller	305001000139	1
38	Jumper	4202021911	1
39	Detecting Plate	000409000001	1

Above data is subject to change without notice.

## 10.2 Outdoor Unit

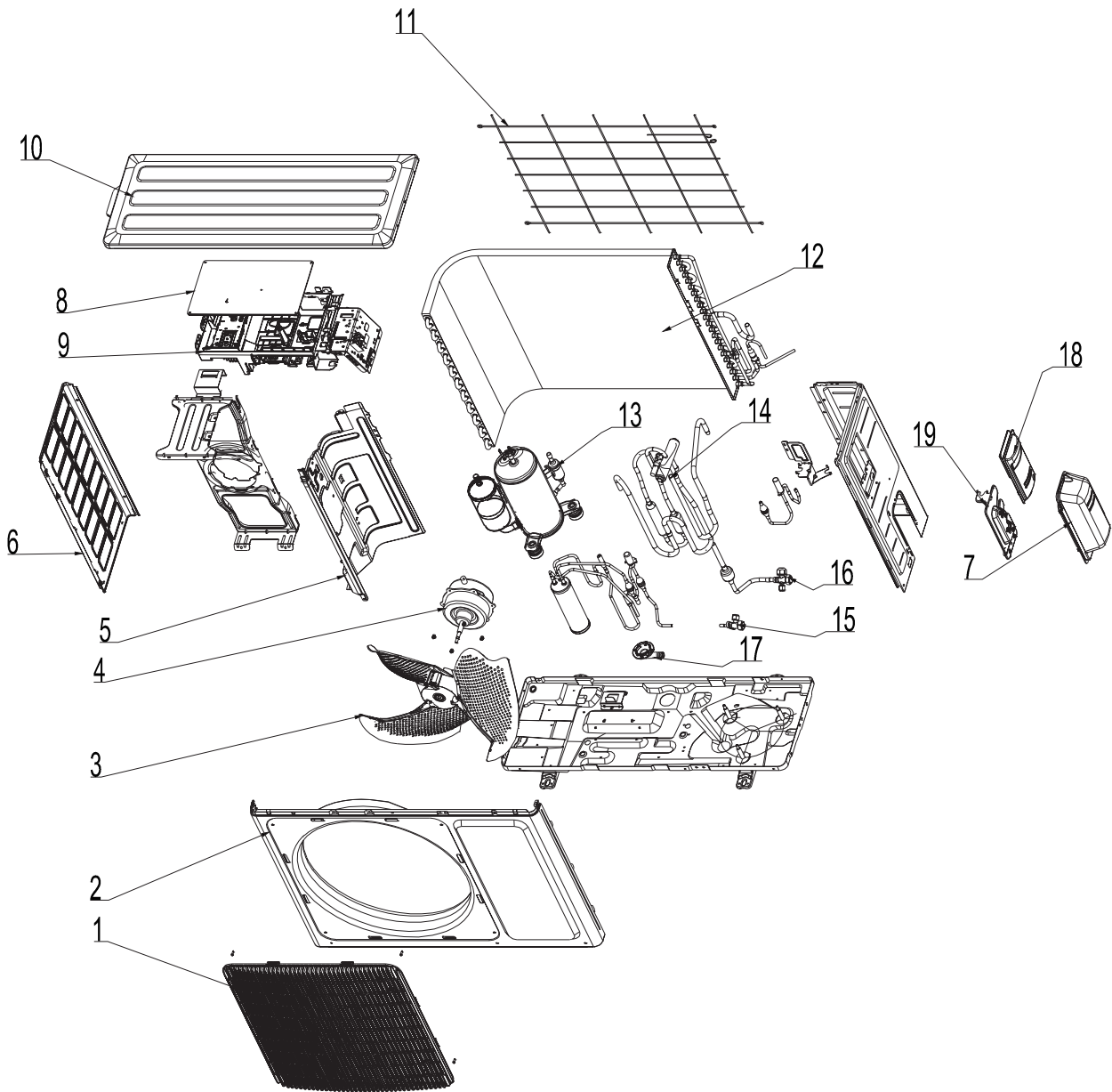

The component picture is only for reference; please refer to the actual product.

No.	Description	Part Code		Qty
		GWH09YD-S6DBA2A/O	GWH12YD-S6DBA2A/O	
		Product Code		
		CB466W00100	CB466W00200	
1	Front Grill	22413046	22413046	1
2	Cabinet	01433034P	01433034P	1
3	Axial Flow Fan	10333011	10333011	/
4	Brushless DC Motor	1501308511	1501308511	1
5	Clapboard Sub-Assy	01235094	01235094	1
6	Left Side Plate	01303169P	01303169P	1
7	Valve Cover	22243005	22243005	1
8	Main Board	300027000056	300027000056	1
9	Electric Box Assy	100002000997	100002000997	2
10	Coping	01253034P	01253034P	1
11	Rear Grill	01475022	01475022	1
12	Condenser Assy	011002000422	011002000422	1
13	Compressor and Fittings	00900100022901	00900100022901	1
14	4-Way Valve Assy	030152000214	030152000214	1
15	Cut off Valve	07130239	07130239	1
16	Cut off Valve	071302391	071302391	1
17	Drainage Joint	26113009	26113009	1
18	Big Handle	2623343106	2623343106	1
19	Valve Support Sub-Assy	01710400005P	01710400005P	1

Above data is subject to change without notice.

# 11. Removal Procedure

**⚠ Caution: discharge the refrigerant completely before removal.**

## 11.1 Removal Procedure of Indoor Unit

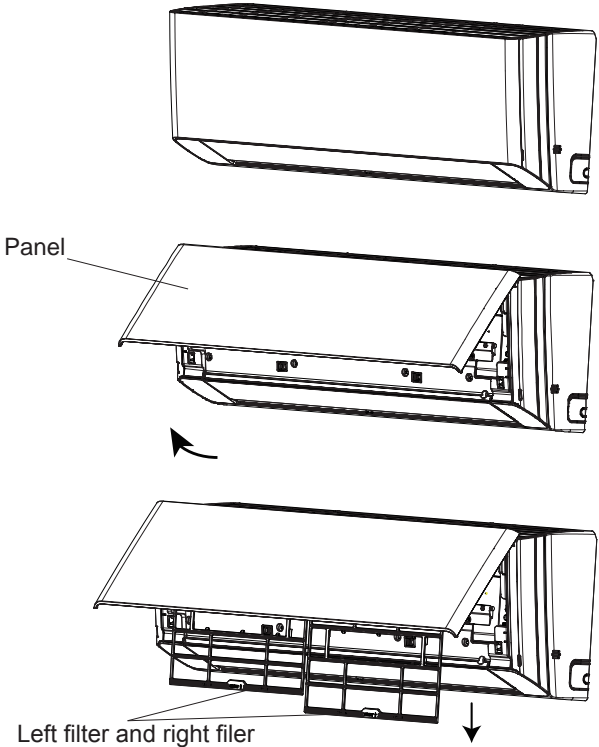
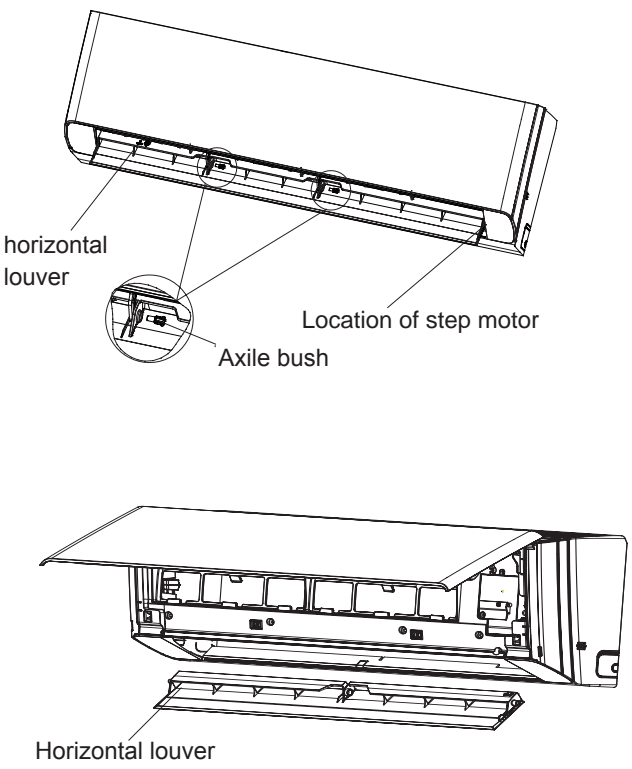
Step	Procedure
<p>1.Remove filter</p> <p>a. Open the panel.</p> <p>b. Loosen the clasp shown and then pull the left filter and right filter outwards to remove them.</p>	 <p>Panel</p> <p>Left filter and right filter</p>
<p>2.Remove horizontal louver</p> <p>Push out the axile bush on horizontal louver. Bend the horizontal louver with hand and then separate the horizontal louver from the crankshaft of step motor to remove it.</p>	 <p>horizontal louver</p> <p>Location of step motor</p> <p>Axile bush</p> <p>Horizontal louver</p>

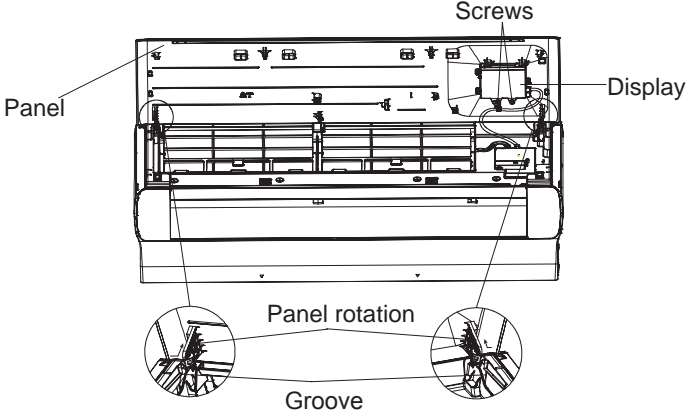
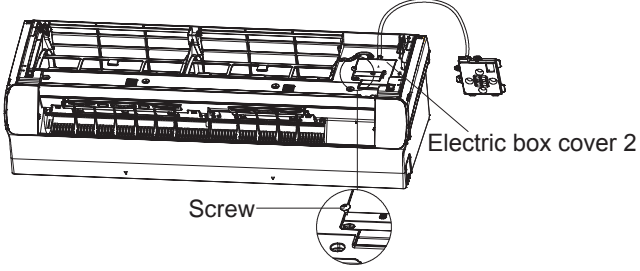
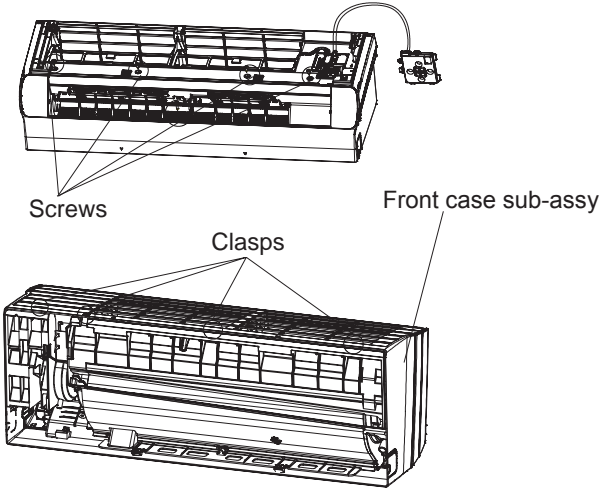
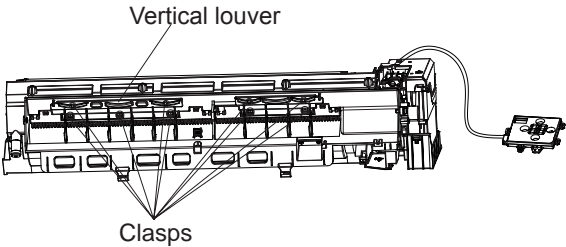
Step		Procedure
3.Remove display and panel	<p>a. Screws that are locking the display board. Separate the display board from the front panel.</p> <p>b. Open the front panel; separate the panel rotation shaft from the groove fixing the front panel and then removes the front panel.</p>	
4.Remove electric box cover 2	<p>Remove the screws on the electric box cover to remove the electric box cover 2.</p>	
5.Remove front case sub-assy	<p>Remove the screws fixing front case. Loosen the clasps of front case. Lift the front case sub-assy upwards to remove it.</p>	
6. Remove vertical louver	<p>Loosen the connection clasps between vertical louver and bottom case to remove vertical louver.</p>	

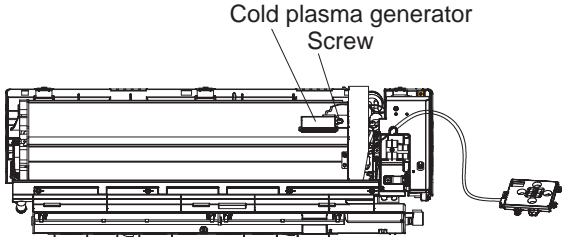
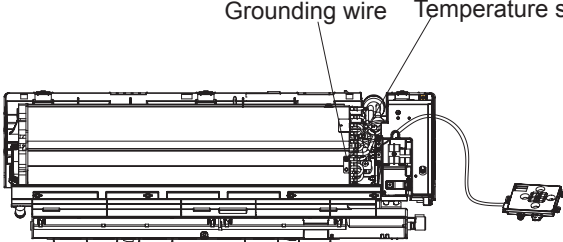
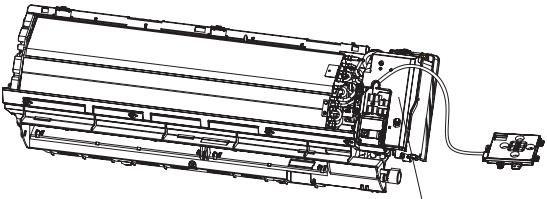
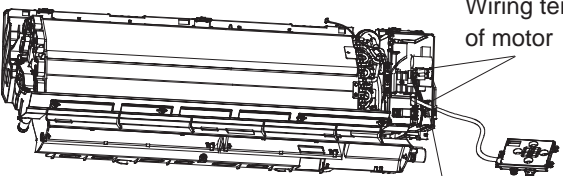
Step	Procedure	
7.Remove cold plasma generator	<p>Screws that are locking the cold plasma generator. Separate the display board from the evaporator assy.</p>	 <p>Cold plasma generator Screw</p>
8.Remove temperature sensor and grounding wire	<p>Cut off the tieline which binding the temperature sensor and grounding wire on the evaporator, and then pull out the indoor tube temperature sensor from the evaporator. Remove the screws at the connection place between grounding wire and evaporator.</p>	 <p>Grounding wire Temperature sensor</p>
9.Remove shield cover of electric box sub-assy	<p>Loosen the connection clasps between shield cover of electric box sub-assy and electric box, and then remove the shield cover of electric box sub-assy.</p>	 <p>Shield cover of electric box sub-assy</p>
10.Remove wiring terminal	<p>Pull out the wiring terminal of motor and wiring terminal of step motor from the mainboard. Note: When pulling out the wiring terminal, pay attention to loose the clasp and don't pull it so hard.</p>	 <p>Wiring terminal of motor Wiring terminal of step motor</p>

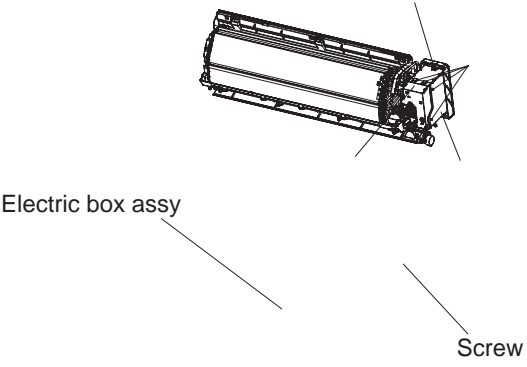
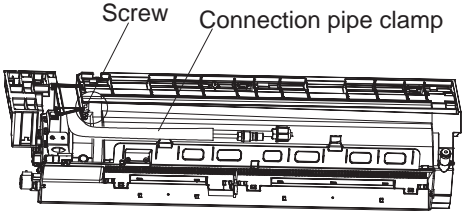
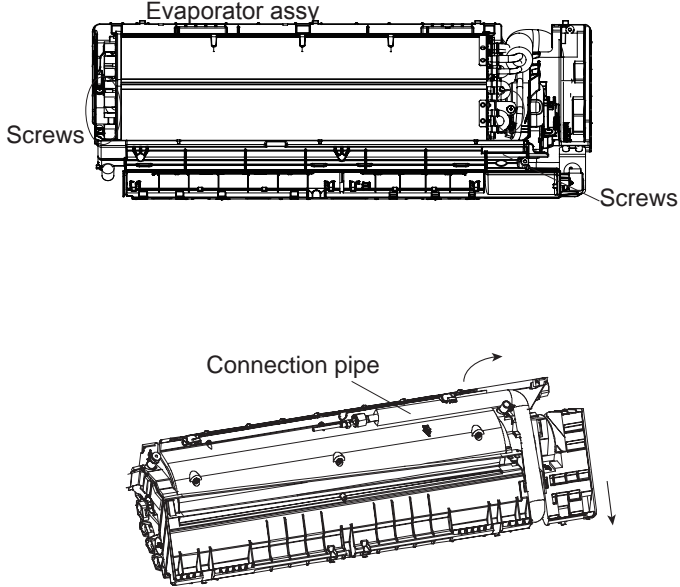
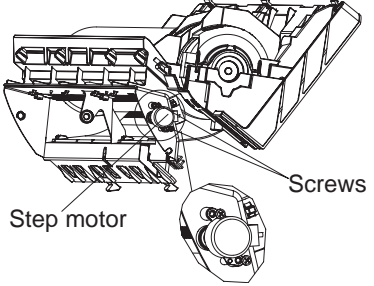
Step	Procedure
<p>11. Electric box assy</p>	<p>Remove the screw fixing electric box assy and then remove the electric box assy.</p> 
<p>12. Remove connection pipe clamp</p>	<p>At the back of the unit, remove the screw fixing connection pipe clamp and then remove the connection pipe clamp.</p> 
<p>13. Remove evaporator assy</p>	<p>Remove 3 screws fixing evaporator assy. Adjust the position of connection pipe on evaporator slightly and then lift the evaporator upwards to remove it.</p> 
<p>14. Remove stepping motor</p>	<p>Remove the screw fixing step motor and then remove the step motor.</p> 

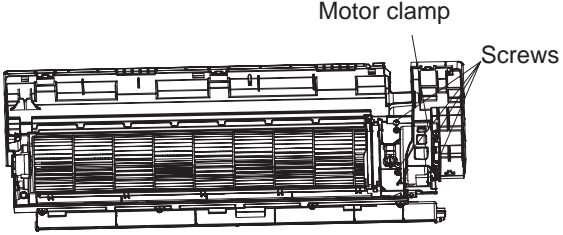
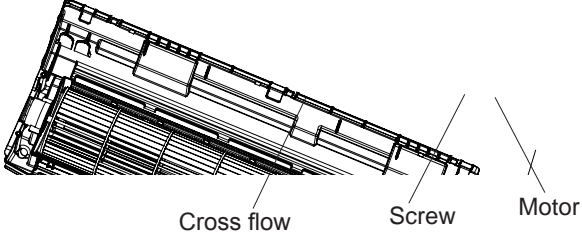
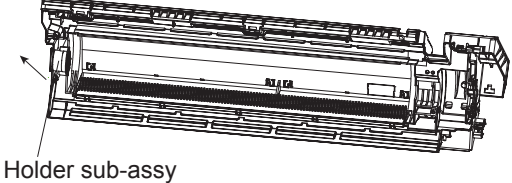

Step	Procedure	
15.Remove motor and cross flow blade		
a.	Remove the screws fixing motor clamp and then remove the motor clamp.	
b.	Remove the screws at the connection place of cross flow blade and motor; lift the motor and cross flow blade upwards to remove them.	
c.	Remove the bearing holder sub-assy.	

## 11.2 Removal Procedure of Outdoor Unit

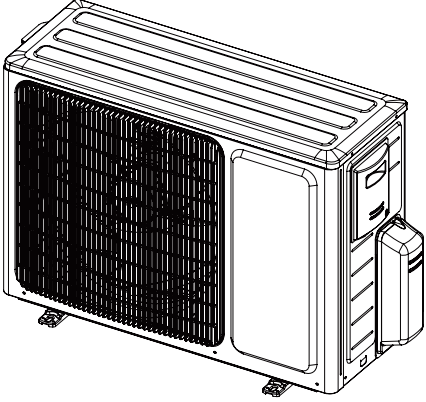
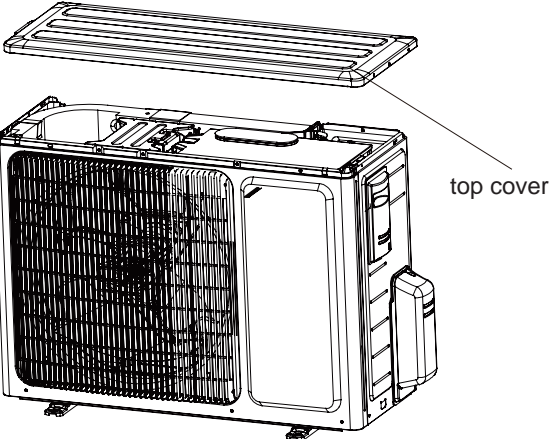
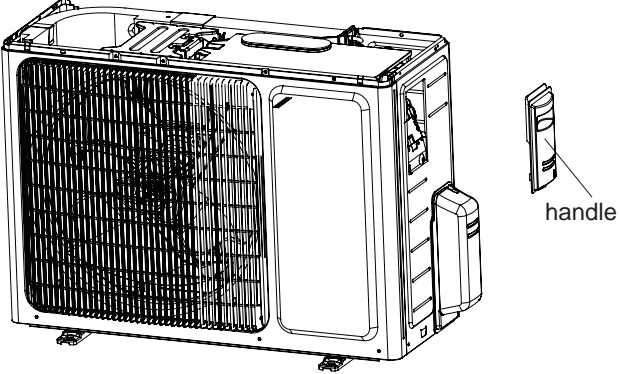
Steps	Procedure
1. Before disassembly	
2. Remove top cover	<p data-bbox="237 1017 781 1126">Remove the screws connecting top cover, left and right side plate, as well as panel, to remove the top cover.</p> 
3. Remove handle	<p data-bbox="228 1552 794 1618">Remove the screws connecting handle and right side plate, to remove the handle.</p> 

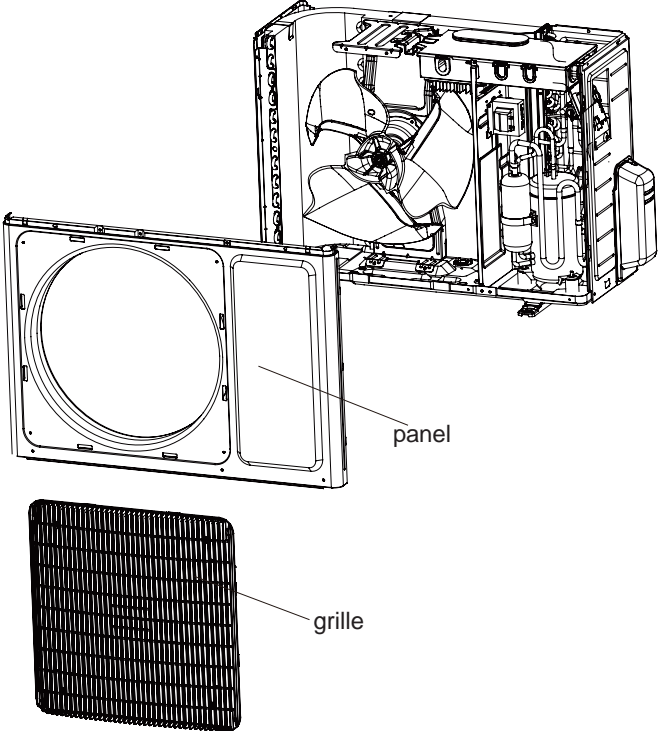
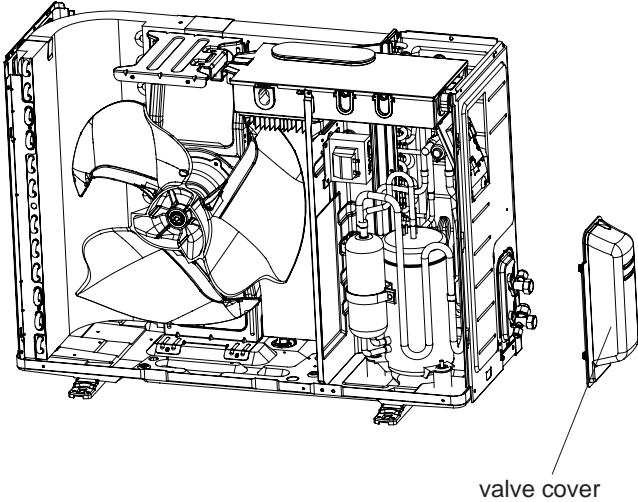
Steps	Procedure
<p>4. Remove panel and grille</p>	<p>Remove the screws fixing panel, to remove the panel. Remove the screws connecting panel grille and panel, loosen the clamp, to remove the panel grille.</p> 
<p>5. Remove valve cover</p>	<p>Remove the screw fixing valve cover, to remove the cover.</p> 

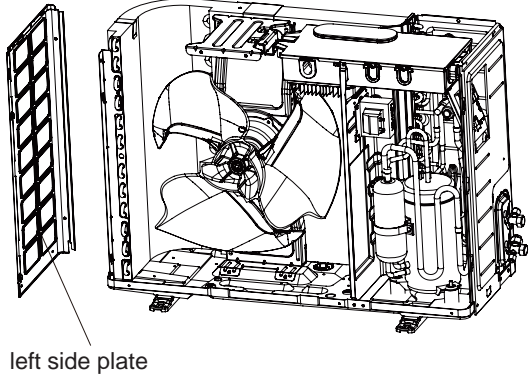
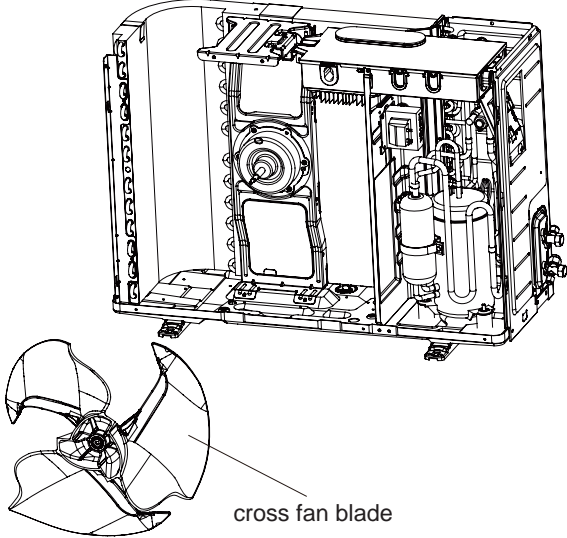
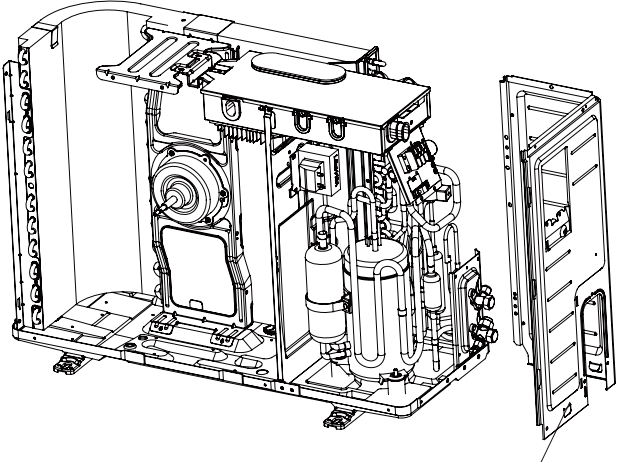
Steps	Procedure
6. Remove left side plate	<p data-bbox="235 399 808 469">Remove the screws fixing left side plate and condenser support board, to remove the left side plate.</p> 
7. Remove cross fan blade	<p data-bbox="235 891 808 1004">Remove the screw nut fixing cross fan blade, remove the gasket and spring cushion, to remove the cross fan blade.</p> 
8. Remove right side plate	<p data-bbox="235 1517 808 1587">Remove the screws fixing right side plate and valve support, to remove the right side plate.</p> 

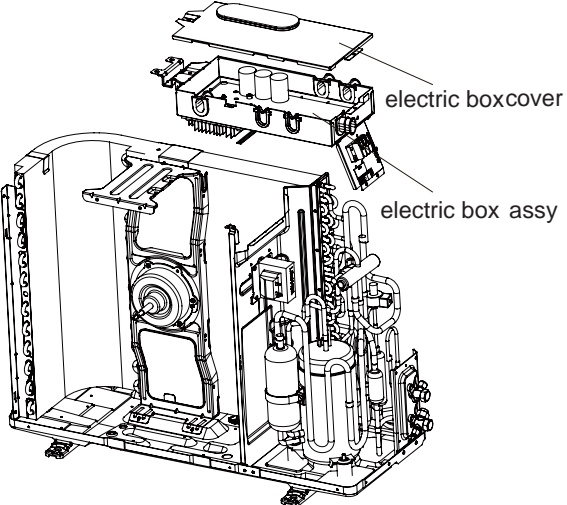
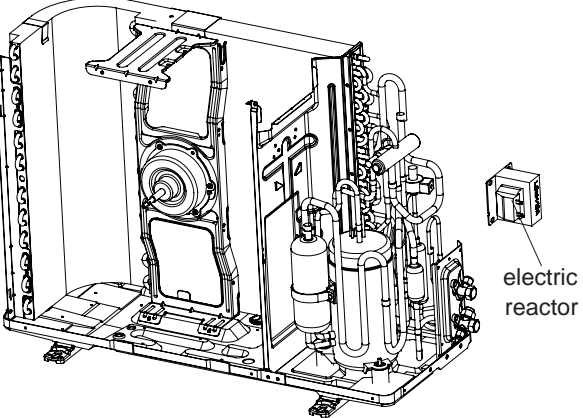
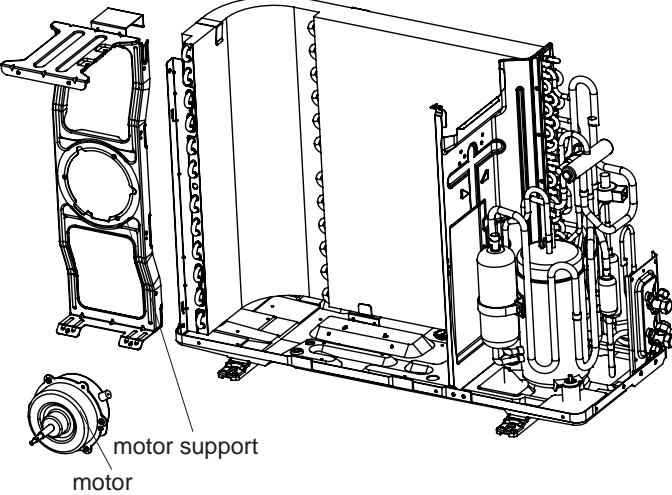
Steps	Procedure
<p>9. Remove electric box assy</p>	<p>Remove screws fixing electric box assy and mid-isolation board, loosen the bonding tie, pull off the wiring terminal, lift to remove the electric box assy.</p>  <p>electric box cover electric box assy</p>
<p>10. Remove electric reactor</p>	<p>Remove the screws fixing electric reactor, to remove the electric reactor.</p>  <p>electric reactor</p>
<p>11. Remove motor and motor support</p>	<p>Remove the four tapping screws fixing motor, pull out the contact tag of motor wiring, to remove the motor. Remove the two tapping screws fixing motor support and chassis, lift to remove the motor support.</p>  <p>motor support motor</p>

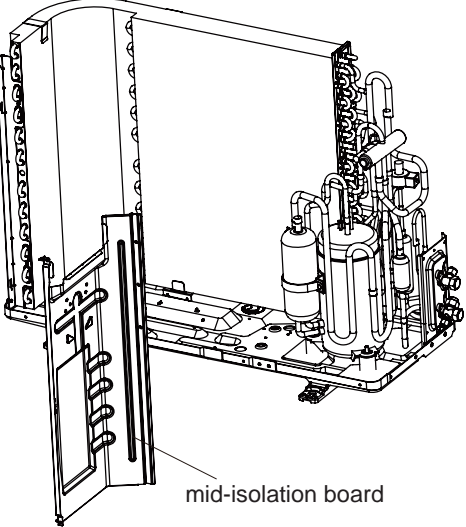
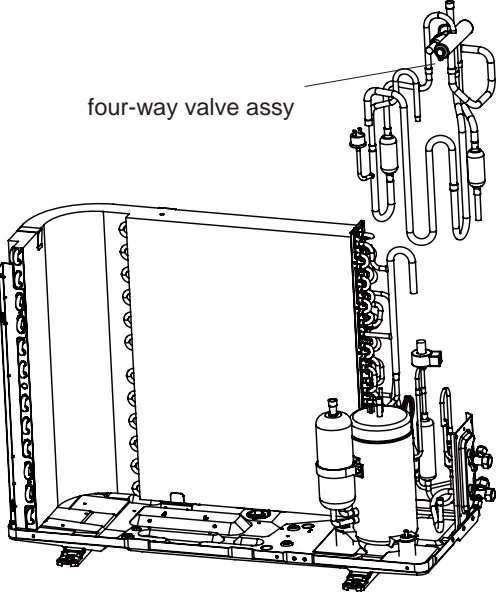
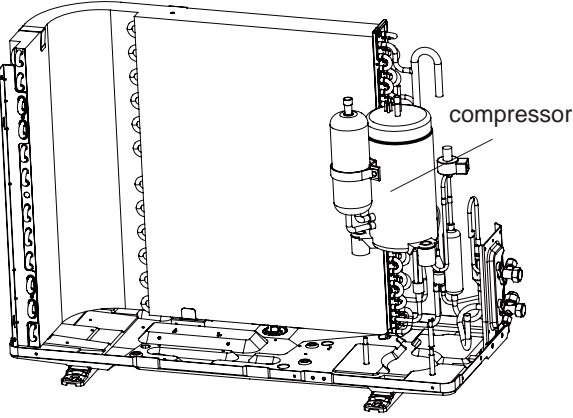
Steps	Procedure
12. Remove mid-isolation board	<p>Remove the screws connecting mid-isolation board, chassis and condenser assy, to remove the mid-isolation.</p>  <p>The diagram shows a side view of the unit's chassis with the condenser assembly mounted. A vertical mid-isolation board is attached to the chassis. A label 'mid-isolation board' points to this board.</p>
13. Remove four-way valve assy	<p>Welding cut the spot weld of four-way valve assy, compressor air suction/discharging valve and condenser pipe outlet, lift to remove the four-way valve assy. (Note: release the refrigerant before welding cutting.)</p>  <p>The diagram shows the unit's chassis with the condenser assembly. A separate four-way valve assembly is shown being lifted away from the condenser. A label 'four-way valve assy' points to the valve assembly.</p>
14. Remove compressor	<p>Remove the three feet screw nuts fixing compressor, to remove the compressor.</p>  <p>The diagram shows the unit's chassis with the condenser assembly. The compressor is mounted to the chassis. A label 'compressor' points to the compressor unit.</p>

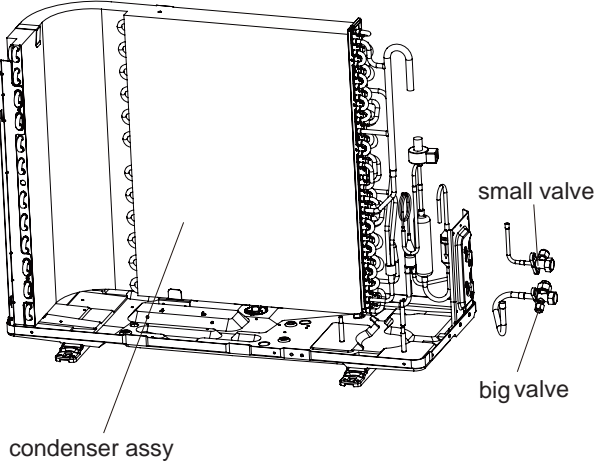

Steps	Procedure
15. Remove big and small valve assy	<p data-bbox="256 421 771 570">Remove screws connecting condenser assy and chassis, to remove the condenser assy. Remove the screws fixing big and small valve, to remove the valves.</p> 

# Appendix:

## Appendix 1: Reference Sheet of Celsius and Fahrenheit

Conversion formula for Fahrenheit degree and Celsius degree:  $T_f = T_c \times 1.8 + 32$

### Set temperature

Fahrenheit display temperature (°F)	Fahrenheit (°F)	Celsius(°C)	Fahrenheit display temperature (°F)	Fahrenheit (°F)	Celsius(°C)	Fahrenheit display temperature (°F)	Fahrenheit (°F)	Celsius(°C)
61	60.8	16	69/70	69.8	21	78/79	78.8	26
62/63	62.6	17	71/72	71.6	22	80/81	80.6	27
64/65	64.4	18	73/74	73.4	23	82/83	82.4	28
66/67	66.2	19	75/76	75.2	24	84/85	84.2	29
68	68	20	77	77	25	86	86	30

### Ambient temperature

Fahrenheit display temperature (°F)	Fahrenheit (°F)	Celsius(°C)	Fahrenheit display temperature (°F)	Fahrenheit (°F)	Celsius(°C)	Fahrenheit display temperature (°F)	Fahrenheit (°F)	Celsius(°C)
32/33	32	0	55/56	55.4	13	79/80	78.8	26
34/35	33.8	1	57/58	57.2	14	81	80.6	27
36	35.6	2	59/60	59	15	82/83	82.4	28
37/38	37.4	3	61/62	60.8	16	84/85	84.2	29
39/40	39.2	4	63	62.6	17	86/87	86	30
41/42	41	5	64/65	64.4	18	88/89	87.8	31
43/44	42.8	6	66/67	66.2	19	90	89.6	32
45	44.6	7	68/69	68	20	91/92	91.4	33
46/47	46.4	8	70/71	69.8	21	93/94	93.2	34
48/49	48.2	9	72	71.6	22	95/96	95	35
50/51	50	10	73/74	73.4	23	97/98	96.8	36
52/53	51.8	11	75/76	75.2	24	99	98.6	37
54	53.6	12	77/78	77	25			

## Appendix 2: Configuration of Connection Pipe

1. Standard length of connection pipe

- 5m, 7.5m, 8m.

2. Min length of connection pipe For the unit with standard connection pipe of 5m, there is no limitation for them in length of connection pipe. For the unit with standard connection pipe of 7.5m and 8m, the min length of connection pipe is 3m.

3. Max length of connection pipe (More details please refer to the specifications)

4. The additional refrigerant oil and refrigerant charging required after prolonging connection pipe

- After the length of connection pipe is prolonged for 10m at the basis of standard length, you should add 5ml of refrigerant oil for each additional 5m of connection pipe.

- The calculation method of additional refrigerant charging amount (on the basis of liquid pipe):

- Basing on the length of standard pipe, add refrigerant according to the requirement as shown in the table. The additional refrigerant charging amount per meter is different according to the diameter of liquid pipe. See Sheet 2.

- Additional refrigerant charging amount = prolonged length of liquid pipe X additional refrigerant charging amount per meter

Additional refrigerant charging amount for R32				
Diameter of connection pipe		Indoor unit throttl	Outdoor unit throttle	
Liquid pipe	Gas pipe	Cooling only, cooling and heating(g / m)	Cooling only(g / m)	Cooling and heating(g / m)
Φ6	Φ9.5 or Φ12	16	12	16
Φ6 or Φ9.5	Φ16 or Φ19	40	12	40
Φ12	Φ19 or Φ22.2	80	24	96
Φ16	Φ25.4 or Φ31.8	136	48	96
Φ19	/	200	200	200
Φ22.2	/	280	280	280

Note: The additional refrigerant charging amount in Sheet 2 is recommended value, not compulsory.

## Appendix 3: Pipe Expanding Method

**⚠ Note:**

**Improper pipe expanding is the main cause of refrigerant leakage. Please expand the pipe according to the following steps:**

**A: Cut the pip**

- Confirm the pipe length according to the distance of indoor unit and outdoor unit.
- Cut the required pipe with pipe cutter.

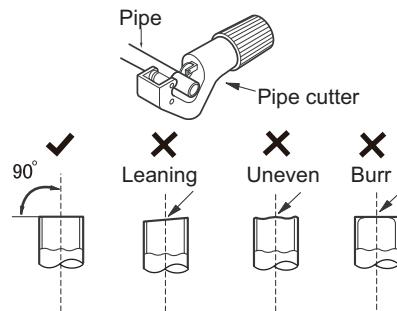

**B: Remove the burrs**

- Remove the burrs with shaper and prevent the burrs from getting into the pipe.

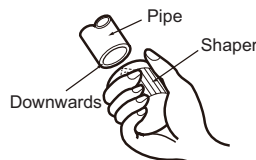

**C: Put on suitable insulating pipe**

**D: Put on the union nut**

- Remove the union nut on the indoor connection pipe and outdoor valve; install the union nut on the pipe.

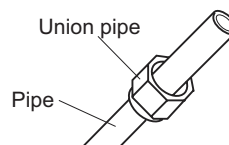

**E: Expand the port**

- Expand the port with expander.

**⚠ Note:**

- "A" is different according to the diameter, please refer to the sheet below:

Outer diameter(mm)	A(mm)	
	Max	Min
Φ6 - 6.35 (1/4")	1.3	0.7
Φ9.52 (3/8")	1.6	1.0
Φ12 - 12.70 (1/2")	1.8	1.0
Φ16 - 15.88 (5/8")	2.4	2.2

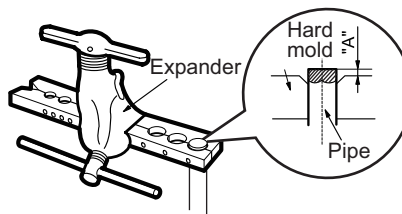

**F: Inspection**

- Check the quality of expanding port. If there is any blemish, expand the port again according to the steps above.

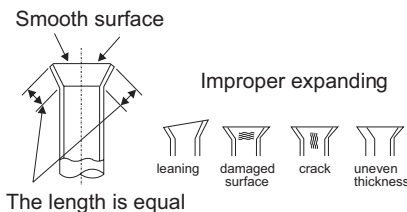

## Appendix 4: List of Resistance for Temperature Sensor

Resistance Table of Ambient Temperature Sensor for Indoor and Outdoor (15K)

Temp(°C)	Resistance(kΩ)	Temp(°C)	Resistance(kΩ)	Temp(°C)	Resistance(kΩ)	Temp(°C)	Resistance(kΩ)
-19	138.1	20	18.75	59	3.848	98	1.071
-18	128.6	21	17.93	60	3.711	99	1.039
-17	121.6	22	17.14	61	3.579	100	1.009
-16	115	23	16.39	62	3.454	101	0.98
-15	108.7	24	15.68	63	3.333	102	0.952
-14	102.9	25	15	64	3.217	103	0.925
-13	97.4	26	14.36	65	3.105	104	0.898
-12	92.22	27	13.74	66	2.998	105	0.873
-11	87.35	28	13.16	67	2.896	106	0.848
-10	82.75	29	12.6	68	2.797	107	0.825
-9	78.43	30	12.07	69	2.702	108	0.802
-8	74.35	31	11.57	70	2.611	109	0.779
-7	70.5	32	11.09	71	2.523	110	0.758
-6	66.88	33	10.63	72	2.439	111	0.737
-5	63.46	34	10.2	73	2.358	112	0.717
-4	60.23	35	9.779	74	2.28	113	0.697
-3	57.18	36	9.382	75	2.206	114	0.678
-2	54.31	37	9.003	76	2.133	115	0.66
-1	51.59	38	8.642	77	2.064	116	0.642
0	49.02	39	8.297	78	1.997	117	0.625
1	46.6	40	7.967	79	1.933	118	0.608
2	44.31	41	7.653	80	1.871	119	0.592
3	42.14	42	7.352	81	1.811	120	0.577
4	40.09	43	7.065	82	1.754	121	0.561
5	38.15	44	6.791	83	1.699	122	0.547
6	36.32	45	6.529	84	1.645	123	0.532
7	34.58	46	6.278	85	1.594	124	0.519
8	32.94	47	6.038	86	1.544	125	0.505
9	31.38	48	5.809	87	1.497	126	0.492
10	29.9	49	5.589	88	1.451	127	0.48
11	28.51	50	5.379	89	1.408	128	0.467
12	27.18	51	5.197	90	1.363	129	0.456
13	25.92	52	4.986	91	1.322	130	0.444
14	24.73	53	4.802	92	1.282	131	0.433
15	23.6	54	4.625	93	1.244	132	0.422
16	22.53	55	4.456	94	1.207	133	0.412
17	21.51	56	4.294	95	1.171	134	0.401
18	20.54	57	4.139	96	1.136	135	0.391
19	19.63	58	3.99	97	1.103	136	0.382

Resistance Table of Tube Temperature Sensors for Indoor and Outdoor (20K)

Temp(°C)	Resistance(kΩ)	Temp(°C)	Resistance(kΩ)	Temp(°C)	Resistance(kΩ)	Temp(°C)	Resistance(kΩ)
-19	181.4	20	25.01	59	5.13	98	1.427
-18	171.4	21	23.9	60	4.948	99	1.386
-17	162.1	22	22.85	61	4.773	100	1.346
-16	153.3	23	21.85	62	4.605	101	1.307
-15	145	24	20.9	63	4.443	102	1.269
-14	137.2	25	20	64	4.289	103	1.233
-13	129.9	26	19.14	65	4.14	104	1.198
-12	123	27	18.13	66	3.998	105	1.164
-11	116.5	28	17.55	67	3.861	106	1.131
-10	110.3	29	16.8	68	3.729	107	1.099
-9	104.6	30	16.1	69	3.603	108	1.069
-8	99.13	31	15.43	70	3.481	109	1.039
-7	94	32	14.79	71	3.364	110	1.01
-6	89.17	33	14.18	72	3.252	111	0.983
-5	84.61	34	13.59	73	3.144	112	0.956
-4	80.31	35	13.04	74	3.04	113	0.93
-3	76.24	36	12.51	75	2.94	114	0.904
-2	72.41	37	12	76	2.844	115	0.88
-1	68.79	38	11.52	77	2.752	116	0.856
0	65.37	39	11.06	78	2.663	117	0.833
1	62.13	40	10.62	79	2.577	118	0.811
2	59.08	41	10.2	80	2.495	119	0.77
3	56.19	42	9.803	81	2.415	120	0.769
4	53.46	43	9.42	82	2.339	121	0.746
5	50.87	44	9.054	83	2.265	122	0.729
6	48.42	45	8.705	84	2.194	123	0.71
7	46.11	46	8.37	85	2.125	124	0.692
8	43.92	47	8.051	86	2.059	125	0.674
9	41.84	48	7.745	87	1.996	126	0.658
10	39.87	49	7.453	88	1.934	127	0.64
11	38.01	50	7.173	89	1.875	128	0.623
12	36.24	51	6.905	90	1.818	129	0.607
13	34.57	52	6.648	91	1.736	130	0.592
14	32.98	53	6.403	92	1.71	131	0.577
15	31.47	54	6.167	93	1.658	132	0.563
16	30.04	55	5.942	94	1.609	133	0.549
17	28.68	56	5.726	95	1.561	134	0.535
18	27.39	57	5.519	96	1.515	135	0.521
19	26.17	58	5.32	97	1.47	136	0.509

Resistance Table of Discharge Temperature Sensor for Outdoor (50K)

Temp(°C)	Resistance(kΩ)	Temp(°C)	Resistance(kΩ)	Temp(°C)	Resistance(kΩ)	Temp(°C)	Resistance(kΩ)
-29	853.5	10	98	49	18.34	88	4.75
-28	799.8	11	93.42	50	17.65	89	4.61
-27	750	12	89.07	51	16.99	90	4.47
-26	703.8	13	84.95	52	16.36	91	4.33
-25	660.8	14	81.05	53	15.75	92	4.20
-24	620.8	15	77.35	54	15.17	93	4.08
-23	580.6	16	73.83	55	14.62	94	3.96
-22	548.9	17	70.5	56	14.09	95	3.84
-21	516.6	18	67.34	57	13.58	96	3.73
-20	486.5	19	64.33	58	13.09	97	3.62
-19	458.3	20	61.48	59	12.62	98	3.51
-18	432	21	58.77	60	12.17	99	3.41
-17	407.4	22	56.19	61	11.74	100	3.32
-16	384.5	23	53.74	62	11.32	101	3.22
-15	362.9	24	51.41	63	10.93	102	3.13
-14	342.8	25	49.19	64	10.54	103	3.04
-13	323.9	26	47.08	65	10.18	104	2.96
-12	306.2	27	45.07	66	9.83	105	2.87
-11	289.6	28	43.16	67	9.49	106	2.79
-10	274	29	41.34	68	9.17	107	2.72
-9	259.3	30	39.61	69	8.85	108	2.64
-8	245.6	31	37.96	70	8.56	109	2.57
-7	232.6	32	36.38	71	8.27	110	2.50
-6	220.5	33	34.88	72	7.99	111	2.43
-5	209	34	33.45	73	7.73	112	2.37
-4	198.3	35	32.09	74	7.47	113	2.30
-3	199.1	36	30.79	75	7.22	114	2.24
-2	178.5	37	29.54	76	7.00	115	2.18
-1	169.5	38	28.36	77	6.76	116	2.12
0	161	39	27.23	78	6.54	117	2.07
1	153	40	26.15	79	6.33	118	2.02
2	145.4	41	25.11	80	6.13	119	1.96
3	138.3	42	24.13	81	5.93	120	1.91
4	131.5	43	23.19	82	5.75	121	1.86
5	125.1	44	22.29	83	5.57	122	1.82
6	119.1	45	21.43	84	5.39	123	1.77
7	113.4	46	20.6	85	5.22	124	1.73
8	108	47	19.81	86	5.06	125	1.68
9	102.8	48	19.06	87	4.90	126	1.64

JF00303370



**GREE ELECTRIC APPLIANCES,INC.OF ZHUHAI**

Add: West Jinji Rd, Qianshan, Zhuhai, Guangdong, China 519070

Tel: (+86-756) 8522218 Fax: (+86-756) 8669426

**HONG KONG GREE ELECTRIC APPLIANCES SALES LIMITED**

Add: Unit 2612,26/F.,Miramar Tower 132 Nathan Road,TST,Kowloon,HK

Tel: (852) 31658898 Fax: (852) 31651029

For product improvement, specifications and appearance in this manual are subject to change without prior notice.