

Installation manual

R32 split series

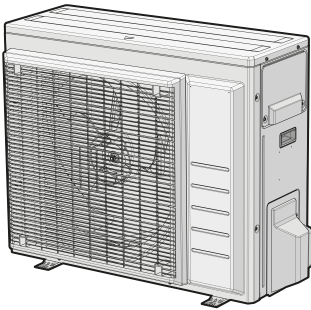

**RXF50B2V1B
RXF60B2V1B
RXF71A2V1B**

**ARXF50A2V1B
ARXF60A2V1B
ARXF71A2V1B**

**RXP50M2V1B
RXP60M2V1B
RXP71M2V1B**

**ARXM50R2V1B
ARXM60R2V1B
ARXM71R2V1B**

**RXM42R2V1B
RXM50R2V1B
RXM60R2V1B
RXM71R2V1B**

RXJ50N2V1B

**RXA42B2V1B
RXA50B2V1B**

Table of Contents

1	About the documentation	12
1.1	About this document.....	12
2	Specific installer safety instructions	12
3	About the box	14
3.1	Outdoor unit.....	14
3.1.1	To remove the accessories from the outdoor unit.....	14
4	Unit installation	14
4.1	Preparing the installation site.....	14
4.1.1	Installation site requirements of the outdoor unit.....	14
4.1.2	Additional installation site requirements of the outdoor unit in cold climates.....	15
4.2	Mounting the outdoor unit.....	15
4.2.1	To provide the installation structure.....	15
4.2.2	To install the outdoor unit.....	15
4.2.3	To provide drainage.....	15
5	Piping installation	16
5.1	Preparing refrigerant piping.....	16
5.1.1	Refrigerant piping requirements.....	16
5.1.2	Refrigerant piping insulation.....	16
5.1.3	Refrigerant piping length and height difference.....	16
5.2	Connecting the refrigerant piping.....	16
5.2.1	To connect the refrigerant piping to the outdoor unit ..	16
5.3	Checking the refrigerant piping.....	17
5.3.1	To check for leaks.....	17
5.3.2	To perform vacuum drying.....	17
6	Charging refrigerant	17
6.1	About the refrigerant.....	17
6.2	To determine the additional refrigerant amount.....	18
6.3	To determine the complete recharge amount.....	18
6.4	To charge additional refrigerant.....	18
6.5	To fix the fluorinated greenhouse gases label.....	18
7	Electrical installation	18
7.1	Specifications of standard wiring components.....	19
7.2	To connect the electrical wiring to the outdoor unit.....	19
8	Finishing the outdoor unit installation	20
8.1	To finish the outdoor unit installation.....	20
9	Commissioning	20
9.1	Checklist before commissioning.....	20
9.2	Checklist during commissioning.....	20
9.3	To perform a test run.....	20
10	Troubleshooting	20
10.1	Fault diagnosis using LED on outdoor unit PCB.....	20
11	Disposal	21
12	Technical data	21
12.1	Wiring diagram.....	21
12.1.1	Unified wiring diagram legend.....	21
12.2	Piping diagram.....	22
12.2.1	Piping diagram: Outdoor unit.....	22

1 About the documentation

1.1 About this document



INFORMATION

Make sure that the user has the printed documentation and ask him/her to keep it for future reference.

Target audience

Authorised installers



WARNING

Make sure installation, servicing, maintenance, repair and applied materials follow the instructions from Daikin and, in addition, comply with applicable legislation and are performed by qualified persons only. In Europe and areas where IEC standards apply, EN/IEC 60335-2-40 is the applicable standard.



INFORMATION

This document only describes installation instructions specific to the outdoor unit. For installation of the indoor unit (mounting the indoor unit, connecting the refrigerant piping to the indoor unit, connecting the electrical wiring to the indoor unit ...), see the installation manual of the indoor unit.

Documentation set

This document is part of a documentation set. The complete set consists of:

- **General safety precautions:**
 - Safety instructions that you **MUST** read before installing
 - Format: Paper (in the box of the outdoor unit)
- **Outdoor unit installation manual:**
 - Installation instructions
 - Format: Paper (in the box of the outdoor unit)
- **Installer reference guide:**
 - Preparation of the installation, reference data,...
 - Format: Digital files on site.

Latest revisions of the supplied documentation may be available on the regional Daikin website or via your dealer.

The original documentation is written in English. All other languages are translations.

Technical engineering data

- A **subset** of the latest technical data is available on the regional Daikin website (publicly accessible).
- The **full set** of latest technical data is available on the Daikin Business Portal (authentication required).

2 Specific installer safety instructions

Always observe the following safety instructions and regulations.

Unit installation (see "**4 Unit installation**" [▶ 14])



WARNING

Installation shall be done by an installer, the choice of materials and installation shall comply with the applicable legislation. In Europe, EN378 is the applicable standard.

Installation site (see "4.1 Preparing the installation site" [p 14])



CAUTION

- Check if the installation location can support the unit's weight. Poor installation is hazardous. It can also cause vibrations or unusual operating noise.
- Provide sufficient service space.
- Do NOT install the unit so that it is in contact with a ceiling or a wall, as this may cause vibrations.



WARNING

The appliance shall be stored in a room without continuously operating ignition sources (example: open flames, an operating gas appliance or an operating electric heater).

Connecting the refrigerant piping (see "5.2 Connecting the refrigerant piping" [p 16])



CAUTION

- No brazing or welding on site for units with R32 refrigerant charge during shipment.
- During installation of the refrigeration system, joining of parts with at least one part charged shall be performed taking into account the following requirements:
 - ⇒ inside occupied spaces non permanent joints are not allowed for R32 refrigerant except for site made joints directly connecting the indoor unit to piping. Site made joints directly connecting piping to indoor units shall be of non permanent type.



CAUTION

- Use the flare nut fixed to the unit.
- To prevent gas leakage, apply refrigeration oil only to the inside of the flare. Use refrigeration oil for R32.
- Do NOT reuse joints.



CAUTION

- Do NOT use mineral oil on flared part.
- Do NOT reuse piping from previous installations.
- NEVER install a drier to this R32 unit to guarantee its lifetime. The drying material may dissolve and damage the system.



WARNING

Connect the refrigerant piping securely before running the compressor. If the refrigerant piping is NOT connected and the stop valve is open when the compressor is run, air will be sucked in. This will cause abnormal pressure in the refrigeration cycle, which may result in equipment damage and even injury.



CAUTION

- Incomplete flaring may cause refrigerant gas leakage.
- Do NOT re-use flares. Use new flares to prevent refrigerant gas leakage.
- Use flare nuts that are included with the unit. Using different flare nuts may cause refrigerant gas leakage.



CAUTION

Do NOT open the valves before flaring is complete. This would cause refrigerant gas leakage.



DANGER: RISK OF EXPLOSION

Do NOT start the unit if it is vacuumed.

Charging refrigerant (see "6 Charging refrigerant" [p 17])



WARNING

The refrigerant inside the unit is mildly flammable, but normally does NOT leak. If the refrigerant leaks in the room and comes in contact with fire from a burner, a heater, or a cooker, this may result in fire, or the formation of a harmful gas.

Turn off any combustible heating devices, ventilate the room, and contact the dealer where you purchased the unit.

Do NOT use the unit until a service person confirms that the part from which the refrigerant leaked has been repaired.



WARNING

- Only use R32 as refrigerant. Other substances may cause explosions and accidents.
- R32 contains fluorinated greenhouse gases. Its global warming potential (GWP) value is 675. Do NOT vent these gases into the atmosphere.
- When charging refrigerant, ALWAYS use protective gloves and safety glasses.



CAUTION

To avoid compressor breakdown, do NOT charge more than the specified amount of refrigerant.



WARNING

NEVER directly touch any accidental leaking refrigerant. This could result in severe wounds caused by frostbite.

Electrical installation (see "7 Electrical installation" [p 18])



WARNING

Appliance shall be installed in accordance with national wiring regulations.



WARNING

- All wiring MUST be performed by an authorised electrician and MUST comply with the applicable legislation.
- Make electrical connections to the fixed wiring.
- All components procured on-site and all electrical construction MUST comply with the applicable legislation.



WARNING

- If the power supply has a missing or wrong N-phase, equipment might break down.
- Establish proper earthing. Do NOT earth the unit to a utility pipe, surge absorber, or telephone earth. Incomplete earthing may cause electrical shock.
- Install the required fuses or circuit breakers.
- Secure the electrical wiring with cable ties so that the cables do NOT come in contact with sharp edges or piping, particularly on the high-pressure side.
- Do NOT use taped wires, stranded conductor wires, extension cords, or connections from a star system. They can cause overheating, electrical shock or fire.
- Do NOT install a phase advancing capacitor, because this unit is equipped with an inverter. A phase advancing capacitor will reduce performance and may cause accidents.

3 About the box



WARNING

ALWAYS use multicore cable for power supply cables.



WARNING

Use an all-pole disconnection type breaker with at least 3 mm between the contact point gaps that provide full disconnection under overvoltage category III.



WARNING

If the supply cord is damaged, it MUST be replaced by the manufacturer, its service agent or similarly qualified persons in order to avoid a hazard.



WARNING

Do NOT connect the power supply to the indoor unit. This could result in electrical shock or fire.



WARNING

- Do NOT use locally purchased electrical parts inside the product.
- Do NOT branch the power supply for the drain pump, etc. from the terminal block. This could result in electrical shock or fire.



WARNING

Keep the interconnection wiring away from copper pipes without thermal insulation as such pipes will be very hot.



DANGER: RISK OF ELECTROCUTION

All electrical parts (including thermistors) are powered by the power supply. Do not touch them with bare hands.



DANGER: RISK OF ELECTROCUTION

Disconnect the power supply for more than 10 minutes, and measure the voltage at the terminals of main circuit capacitors or electrical components before servicing. The voltage MUST be less than 50 V DC before you can touch electrical components. For the location of the terminals, see the wiring diagram.

Finishing indoor unit installation (see "8 Finishing the outdoor unit installation" [p 20])



DANGER: RISK OF ELECTROCUTION

- Make sure that the system is earthed properly.
- Turn off the power supply before servicing.
- Install the switch box cover before turning on the power supply.

Commissioning (see "9 Commissioning" [p 20])



DANGER: RISK OF ELECTROCUTION



DANGER: RISK OF BURNING/SCALDING



CAUTION

Do NOT perform the test operation while working on the indoor units.

When performing the test operation, NOT only the outdoor unit, but the connected indoor unit will operate as well. Working on an indoor unit while performing a test operation is dangerous.



CAUTION

Do NOT insert fingers, rods or other objects into the air inlet or outlet. Do NOT remove the fan guard. When the fan is rotating at high speed, it will cause injury.

3 About the box

3.1 Outdoor unit

3.1.1 To remove the accessories from the outdoor unit

- Lift the outdoor unit.
- Remove the accessories at the bottom of the package.

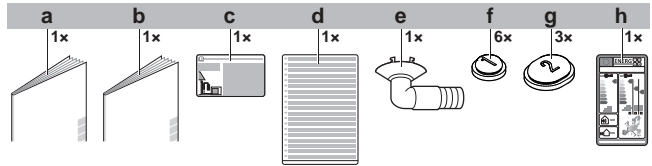

- a General safety precautions
- b Outdoor unit installation manual
- c Fluorinated greenhouse gases label
- d Multilingual fluorinated greenhouse gases label
- e Drain plug (located on the bottom of the packing case)
- f Drain cap (1)
- g Drain cap (2)
- h Energy label

4 Unit installation



WARNING

Installation shall be done by an installer, the choice of materials and installation shall comply with the applicable legislation. In Europe, EN378 is the applicable standard.

4.1 Preparing the installation site



WARNING

The appliance shall be stored in a room without continuously operating ignition sources (example: open flames, an operating gas appliance or an operating electric heater).

4.1.1 Installation site requirements of the outdoor unit

Mind the following spacing guidelines:

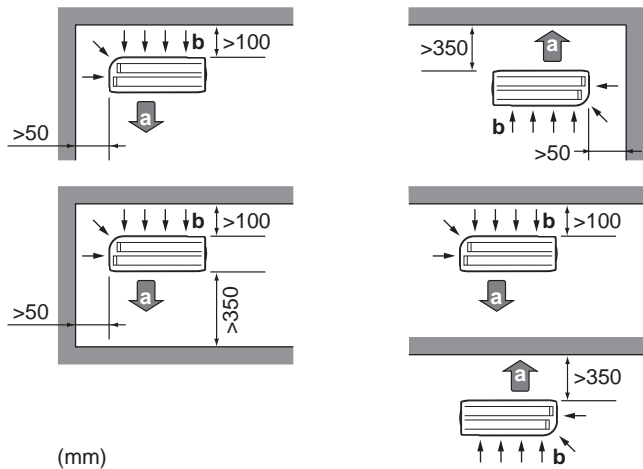

(mm)

- a Air outlet
- b Air inlet



NOTICE

The height of the wall on the outlet side of the outdoor unit MUST be ≤ 1200 mm.

Do NOT install the unit in sound sensitive areas (e.g. near a bedroom), so that the operation noise will cause no trouble.

Note: If the sound is measured under actual installation conditions, the measured value might be higher than the sound pressure level mentioned in "Sound spectrum" in the data book due to environmental noise and sound reflections.



INFORMATION

The sound pressure level is less than 70 dBA.

4.1.2 Additional installation site requirements of the outdoor unit in cold climates

Protect the outdoor unit against direct snowfall and take care that the outdoor unit is NEVER snowed up.

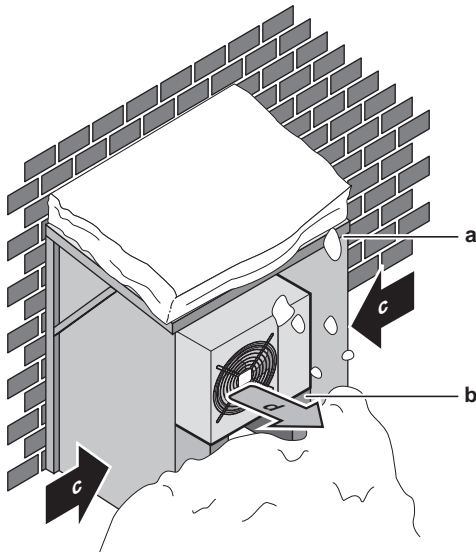

- a Snow cover or shed
- b Pedestal
- c Prevailing wind direction
- d Air outlet

It is recommended to provide at least 150 mm of free space below the unit (300 mm for heavy snowfall areas). Additionally, make sure the unit is positioned at least 100 mm above the maximum expected level of snow. If necessary, construct a pedestal. See "4.2 Mounting the outdoor unit" [p. 15] for more details.

In heavy snowfall areas it is very important to select an installation site where the snow will NOT affect the unit. If lateral snowfall is possible, make sure that the heat exchanger coil is NOT affected by the snow. If necessary, install a snow cover or shed and a pedestal.

4.2 Mounting the outdoor unit

4.2.1 To provide the installation structure

Use a vibration-proof rubber (field supply) in cases where vibrations may be transmitted to the building.

Prepare 4 sets of M8 or M10 anchor bolts, nuts and washers (field supply).

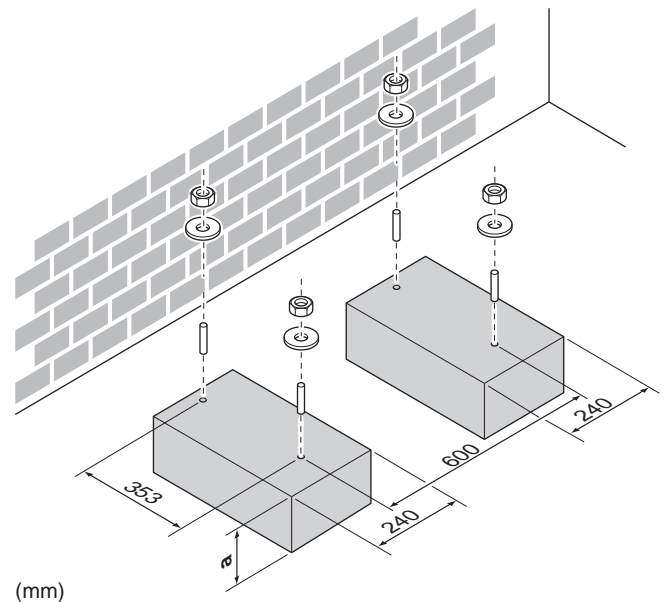
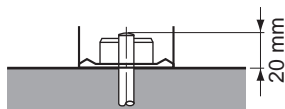

a 100 mm above expected level of snow

4.2.2 To install the outdoor unit

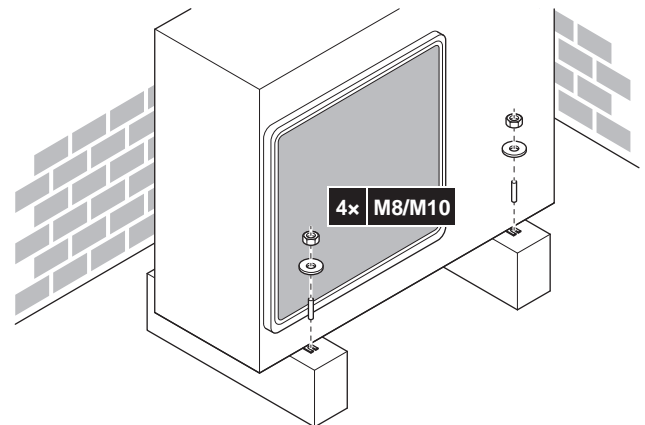

4.2.3 To provide drainage



NOTICE

If the unit is installed in a cold climate, take adequate measures so that the evacuated condensate CANNOT freeze.



NOTICE

If the drain holes of the outdoor unit are blocked up by a mounting base or floor surface, place additional foot bases ≤ 30 mm under the outdoor unit's feet.



INFORMATION

For information on the available options, contact your dealer.

- 1 Use a drain plug for drainage.
- 2 Use a $\varnothing 16$ mm hose (field supply).

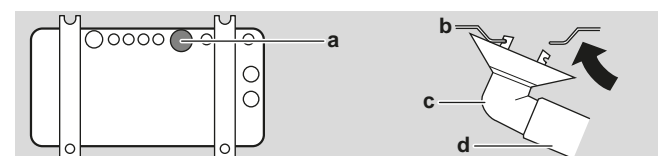

- a Drain port
- b Bottom frame

5 Piping installation

- c Drain plug
- d Hose (field supply)

To close the drain holes and attach the drain socket

NOTICE

In cold areas, do NOT use a drain socket, hose and caps (1, 2) with the outdoor unit. Take adequate measures so that the evacuated condensate CANNOT freeze.

- 1 Install drain caps 1 and 2 (accessory). Make sure the edges of the drain caps close off the holes completely.

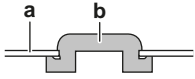

- a Bottom frame
- b Drain cap

- 2 Install the drain socket.

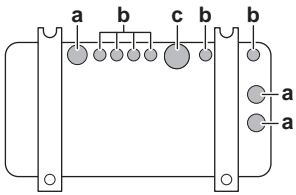

- a Drain hole. Install a drain cap (2).
- b Drain hole. Install a drain cap (1).
- c Drain hole for drain socket

5 Piping installation

5.1 Preparing refrigerant piping

5.1.1 Refrigerant piping requirements

NOTICE

The piping and other pressure-containing parts shall be suitable for refrigerant. Use phosphoric acid deoxidised seamless copper for refrigerant.

- **Piping material:** Phosphoric acid deoxidised seamless copper.
- **Flare connections:** Only use annealed material.
- **Piping diameter:**

Models	Liquid piping	Gas piping
RXM71R	Ø6.4 mm (1/4")	Ø15.9 mm (5/8")
ARXM71R	Ø9.5 mm (3/8")	Ø15.9 mm (5/8")
RXM42R	Ø6.4 mm (1/4")	Ø9.5 mm (3/8")
Other	Ø6.4 mm (1/4")	Ø12.7 mm (1/2")

- **Piping temper grade and thickness:**

Outer diameter (Ø)	Temper grade	Thickness (t) ^(a)	
6.4 mm (1/4")	Annealed (O)	≥0.8 mm	
9.5 mm (3/8")			
12.7 mm (1/2")			
15.9 mm (5/8")		≥1 mm	

^(a) Depending on the applicable legislation and the maximum working pressure of the unit (see "PS High" on the unit name plate), larger piping thickness might be required.

5.1.2 Refrigerant piping insulation

- Use polyethylene foam as insulation material:
 - with a heat transfer rate between 0.041 and 0.052 W/mK (0.035 and 0.045 kcal/mh°C)
 - with a heat resistance of at least 120°C
- Insulation thickness

Pipe outer diameter (Ø _p)	Insulation inner diameter (Ø _i)	Insulation thickness (t)
6.4 mm (1/4")	8~10 mm	≥10 mm
9.5 mm (3/8")	10~14 mm	≥13 mm
12.7 mm (1/2")	14~16 mm	≥10 mm
15.9 mm (5/8")	16~20 mm	≥13 mm

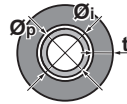

If the temperature is higher than 30°C and the humidity is higher than RH 80%, the thickness of the insulation materials should be at least 20 mm to prevent condensation on the surface of the insulation.

5.1.3 Refrigerant piping length and height difference

What?	Distance
Maximum allowable pipe length	30 m
Minimum allowable pipe length	3 m
Maximum allowable height distance	20 m

5.2 Connecting the refrigerant piping

DANGER: RISK OF BURNING/SCALDING

CAUTION

- No brazing or welding on site for units with R32 refrigerant charge during shipment.
- During installation of the refrigeration system, joining of parts with at least one part charged shall be performed taking into account the following requirements:
 - ⇒ inside occupied spaces non permanent joints are not allowed for R32 refrigerant except for site made joints directly connecting the indoor unit to piping. Site made joints directly connecting piping to indoor units shall be of non permanent type.

WARNING

- Only use R32 as refrigerant. Other substances may cause explosions and accidents.
- R32 contains fluorinated greenhouse gases. Its global warming potential (GWP) value is 675. Do NOT vent these gases into the atmosphere.
- When charging refrigerant, ALWAYS use protective gloves and safety glasses.

5.2.1 To connect the refrigerant piping to the outdoor unit

- **Piping length.** Keep field piping as short as possible.
- **Piping protection.** Protect the field piping against physical damage.



WARNING

Connect the refrigerant piping securely before running the compressor. If the refrigerant piping is NOT connected and the stop valve is open when the compressor is run, air will be sucked in. This will cause abnormal pressure in the refrigeration cycle, which may result in equipment damage and even injury.



CAUTION

- Use the flare nut fixed to the unit.
- To prevent gas leakage, apply refrigeration oil only to the inside of the flare. Use refrigeration oil for R32.
- Do NOT reuse joints.

- Connect the liquid refrigerant connection from the indoor unit to the liquid stop valve of the outdoor unit.

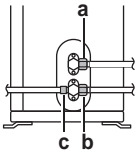

- a Liquid stop valve
- b Gas stop valve
- c Service port

- Connect the gas refrigerant connection from the indoor unit to the gas stop valve of the outdoor unit.



NOTICE

It is recommended that the refrigerant piping between indoor and outdoor unit is installed in a ducting or the refrigerant piping is wrapped with finishing tape.

5.3 Checking the refrigerant piping

5.3.1 To check for leaks



NOTICE

Do NOT exceed the unit's maximum working pressure (see "PS High" on the unit name plate).



NOTICE

Make sure to use a recommended bubble test solution from your wholesaler. Do not use soap water, which may cause cracking of flare nuts (soap water may contain salt, which absorbs moisture that will freeze when the piping gets cold), and/or lead to corrosion of flared joints (soap water may contain ammonia which causes a corrosive effect between the brass flare nut and the copper flare).

- Charge the system with nitrogen gas up to a gauge pressure of at least 200 kPa (2 bar). It is recommended to pressurize to 3000 kPa (30 bar) in order to detect small leaks.
- Check for leaks by applying the bubble test solution to all connections.
- Discharge all nitrogen gas.

5.3.2 To perform vacuum drying



DANGER: RISK OF EXPLOSION

Do NOT start the unit if it is vacuumed.

- Vacuum the system until the pressure on the manifold indicates -0.1 MPa (-1 bar).
- Leave as is for 4-5 minutes and check the pressure:

If the pressure...	Then...
Does not change	There is no moisture in the system. This procedure is finished.
Increases	There is moisture in the system. Go to the next step.

- Vacuum the system for at least 2 hours to a manifold pressure of -0.1 MPa (-1 bar).
- After turning the pump OFF, check the pressure for at least 1 hour.
- If you do NOT reach the target vacuum or CANNOT maintain the vacuum for 1 hour, do the following:
 - Check for leaks again.
 - Perform vacuum drying again.



NOTICE

Make sure to open the stop valves after installing the refrigerant piping and performing vacuum drying. Running the system with the stop valves closed may break the compressor.

6 Charging refrigerant

6.1 About the refrigerant

This product contains fluorinated greenhouse gases. Do NOT vent gases into the atmosphere.

Refrigerant type: R32

Global warming potential (GWP) value: 675



WARNING: MILDLY FLAMMABLE MATERIAL

The refrigerant inside this unit is mildly flammable.



WARNING

The appliance shall be stored in a room without continuously operating ignition sources (example: open flames, an operating gas appliance or an operating electric heater).



WARNING

- Do NOT pierce or burn refrigerant cycle parts.
- Do NOT use cleaning materials or means to accelerate the defrosting process other than those recommended by the manufacturer.
- Be aware that the refrigerant inside the system is odourless.



WARNING

The refrigerant inside the unit is mildly flammable, but normally does NOT leak. If the refrigerant leaks in the room and comes in contact with fire from a burner, a heater, or a cooker, this may result in fire, or the formation of a harmful gas.

Turn off any combustible heating devices, ventilate the room, and contact the dealer where you purchased the unit.

Do NOT use the unit until a service person confirms that the part from which the refrigerant leaked has been repaired.

7 Electrical installation



WARNING

NEVER directly touch any accidental leaking refrigerant. This could result in severe wounds caused by frostbite.

6.2 To determine the additional refrigerant amount

For ARXM71R	
If the total liquid piping length is...	Then...
≤10 m	Do NOT add additional refrigerant.
>10 m	R=(total length (m) of liquid piping-10 m)×0.035 R=Additional charge (kg) (rounded in units of 0.01 kg)

For other outdoor units	
If the total liquid piping length is...	Then...
≤10 m	Do NOT add additional refrigerant.
>10 m	R=(total length (m) of liquid piping-10 m)×0.020 R=Additional charge (kg) (rounded in units of 0.01 kg)



INFORMATION

Piping length is the one-way length of liquid piping.

6.3 To determine the complete recharge amount



INFORMATION

If a complete recharge is necessary, the total refrigerant charge is: the factory refrigerant charge (see unit name plate) + the determined additional amount.

6.4 To charge additional refrigerant



WARNING

- Only use R32 as refrigerant. Other substances may cause explosions and accidents.
- R32 contains fluorinated greenhouse gases. Its global warming potential (GWP) value is 675. Do NOT vent these gases into the atmosphere.
- When charging refrigerant, ALWAYS use protective gloves and safety glasses.

Prerequisite: Before charging refrigerant, make sure the refrigerant piping is connected and checked (leak test and vacuum drying).

- Connect the refrigerant cylinder to the service port.
- Charge the additional refrigerant amount.
- Open the gas stop valve.

6.5 To fix the fluorinated greenhouse gases label

- Fill in the label as follows:

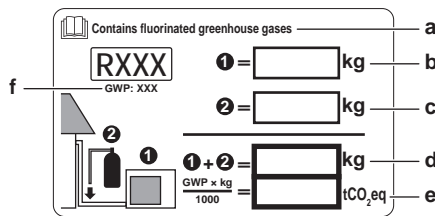

- If a multilingual fluorinated greenhouse gases label is delivered with the unit (see accessories), peel off the applicable language and stick it on top of a.
- Factory refrigerant charge: see unit name plate
- Additional refrigerant amount charged
- Total refrigerant charge
- Quantity of fluorinated greenhouse gases** of the total refrigerant charge expressed as tonnes CO₂ equivalent.
- GWP = Global warming potential



NOTICE

Applicable legislation on **fluorinated greenhouse gases** requires that the refrigerant charge of the unit is indicated both in weight and CO₂ equivalent.

Formula to calculate the quantity in CO₂ equivalent tonnes: GWP value of the refrigerant × total refrigerant charge [in kg] / 1000

Use the GWP value mentioned on the refrigerant charge label.

- Fix the label on the inside of the outdoor unit near the gas and liquid stop valves.

7 Electrical installation



DANGER: RISK OF ELECTROCUTION



WARNING

- All wiring **MUST** be performed by an authorised electrician and **MUST** comply with the applicable legislation.
- Make electrical connections to the fixed wiring.
- All components procured on-site and all electrical construction **MUST** comply with the applicable legislation.



WARNING

Appliance shall be installed in accordance with national wiring regulations.



WARNING

ALWAYS use multicore cable for power supply cables.



WARNING

Use an all-pole disconnection type breaker with at least 3 mm between the contact point gaps that provide full disconnection under overvoltage category III.



WARNING

If the supply cord is damaged, it **MUST** be replaced by the manufacturer, its service agent or similarly qualified persons in order to avoid a hazard.



WARNING

Do NOT connect the power supply to the indoor unit. This could result in electrical shock or fire.



WARNING

- Do NOT use locally purchased electrical parts inside the product.
- Do NOT branch the power supply for the drain pump, etc. from the terminal block. This could result in electrical shock or fire.



WARNING

Keep the interconnection wiring away from copper pipes without thermal insulation as such pipes will be very hot.



DANGER: RISK OF ELECTROCUTION

All electrical parts (including thermistors) are powered by the power supply. Do not touch them with bare hands.



DANGER: RISK OF ELECTROCUTION

Disconnect the power supply for more than 10 minutes, and measure the voltage at the terminals of main circuit capacitors or electrical components before servicing. The voltage MUST be less than 50 V DC before you can touch electrical components. For the location of the terminals, see the wiring diagram.

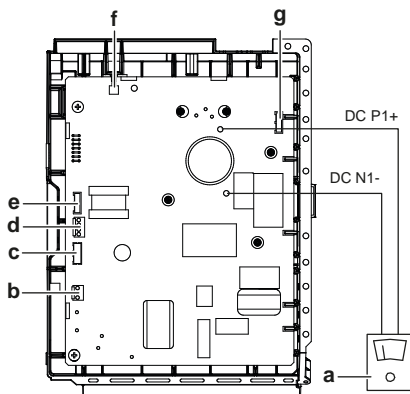

- a Multimeter (DC voltage range)
- b S80 – reversing solenoid valve lead wire
- c S20 – electronic expansion valve lead wire
- d S40 – thermal overload relay lead wire
- e S90 – thermistor lead wire
- f LED
- g S70 – fan motor lead wire

7.1 Specifications of standard wiring components

Component		
Power supply cable	Voltage	220~240 V
	Phase	1~
	Frequency	50 Hz
	Wire sizes	3-core cable 2.5 mm ² ~4.0 mm ² H05RN-F (60245 IEC 57)
Interconnection cable (indoor↔outdoor)	4-core cable 1.5 mm ² ~2.5 mm ² and applicable for 220~240 V H05RN-F (60245 IEC 57)	

Component		
Recommended circuit breaker	RXM71R	20 A ^(a)
	RXP50~71M	
	RXF50+60B	
	RXF71A	
	ARXF50~71A	
	ARXM50~71R	16 A
Earth leakage circuit breaker	RXM50+60R	
	RXM42R	13 A
	RXA42+50R	
	RXJ50N	
Earth leakage circuit breaker	MUST comply with applicable legislation	

^(a) Electrical equipment complying with EN/IEC 61000-3-12 (European/International Technical Standard setting the limits for harmonic currents produced by equipment connected to public low-voltage systems with input current >16 A and ≤75 A per phase).

7.2 To connect the electrical wiring to the outdoor unit

- Remove the switch box cover.
- Open the wire clamp.
- Connect the interconnection cable and power supply as follows:

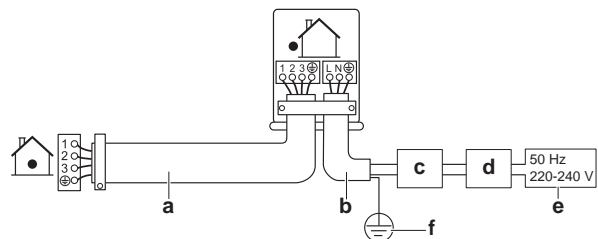

- a Interconnection cable
- b Power supply cable
- c Circuit breaker
- d Residual current device
- e Power supply
- f Earth

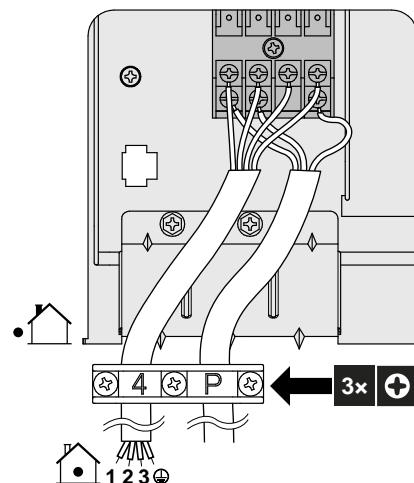

- Tighten the terminal screws securely. We recommend using a Phillips screwdriver.
- Install the switch box cover.

8 Finishing the outdoor unit installation

8 Finishing the outdoor unit installation

8.1 To finish the outdoor unit installation



DANGER: RISK OF ELECTROCUTION

- Make sure that the system is earthed properly.
- Turn off the power supply before servicing.
- Install the switch box cover before turning on the power supply.

1 Insulate and fix the refrigerant piping and cables as follows:

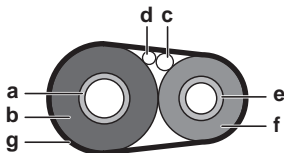

- a Gas pipe
- b Gas pipe insulation
- c Interconnection cable
- d Field wiring (if applicable)
- e Liquid pipe
- f Liquid pipe insulation
- g Finishing tape

2 Install the service cover.

9 Commissioning



NOTICE

ALWAYS operate the unit with thermistors and/or pressure sensors/switches. If NOT, burning of the compressor might be the result.

9.1 Checklist before commissioning

After the installation of the unit, first check the items listed below. Once all checks are fulfilled, the unit must be closed. Power-up the unit after it is closed.

<input type="checkbox"/>	The indoor unit is properly mounted.
<input type="checkbox"/>	The outdoor unit is properly mounted.
<input type="checkbox"/>	The system is properly earthed and the earth terminals are tightened.
<input type="checkbox"/>	The power supply voltage matches the voltage on the identification label of the unit.
<input type="checkbox"/>	There are NO loose connections or damaged electrical components in the switch box.
<input type="checkbox"/>	There are NO damaged components or squeezed pipes on the inside of the indoor and outdoor units.
<input type="checkbox"/>	There are NO refrigerant leaks .
<input type="checkbox"/>	The refrigerant pipes (gas and liquid) are thermally insulated.
<input type="checkbox"/>	The correct pipe size is installed and the pipes are properly insulated.
<input type="checkbox"/>	The stop valves (gas and liquid) on the outdoor unit are fully open.
<input type="checkbox"/>	The following field wiring has been carried out according to this document and the applicable legislation between the outdoor unit and the indoor unit.

<input type="checkbox"/>	Drainage Make sure drainage flows smoothly. Possible consequence: Condensate water might drip.
<input type="checkbox"/>	The indoor unit receives the signals of the user interface .
<input type="checkbox"/>	The specified wires are used for the interconnection cable .
<input type="checkbox"/>	The fuses, circuit breakers , or locally installed protection devices are installed according to this document, and have NOT been bypassed.

9.2 Checklist during commissioning

<input type="checkbox"/>	To perform an air purge .
<input type="checkbox"/>	To perform a test run .

9.3 To perform a test run

Prerequisite: Power supply **MUST** be in the specified range.

Prerequisite: Test run may be performed in cooling or heating mode.

Prerequisite: Test run should be performed in accordance with the operation manual of the indoor unit to make sure that all functions and parts are working properly.

- In cooling mode, select the lowest programmable temperature. In heating mode, select the highest programmable temperature. Test run can be disabled if necessary.
- When the test run is finished, set the temperature to a normal level. In cooling mode: 26~28°C, in heating mode: 20~24°C.
- The system stops operating 3 minutes after the unit is turned OFF.



INFORMATION

- Even if the unit is turned OFF, it consumes electricity.
- When the power turns back on after a power break, the previously selected mode will be resumed.

10 Troubleshooting

10.1 Fault diagnosis using LED on outdoor unit PCB

LED is...	Diagnosis
flashing	Normal. <ul style="list-style-type: none"> Check the indoor unit.
ON	<ul style="list-style-type: none"> Turn the power OFF and back ON, and check the LED within approximately 3 minutes. If the LED is ON again, the outdoor unit PCB is faulty.
OFF	<ol style="list-style-type: none"> Supply voltage (for power saving). Power supply fault. Turn the power OFF and back ON, and check the LED within approximately 3 minutes. If the LED is OFF again, the outdoor unit PCB is faulty.

**DANGER: RISK OF ELECTROCUTION**

- When the unit is not operating, the LEDs on the PCB are turned off in order to save power.
- Even when the LEDs are off, the terminal block and the PCB may be powered.

11 Disposal

**NOTICE**

Do NOT try to dismantle the system yourself: dismantling of the system, treatment of the refrigerant, oil and other parts MUST comply with applicable legislation. Units MUST be treated at a specialised treatment facility for reuse, recycling and recovery.

12 Technical data

- A **subset** of the latest technical data is available on the regional Daikin website (publicly accessible).
- The **full set** of latest technical data is available on the Daikin Business Portal (authentication required).

12.1 Wiring diagram

The wiring diagram is delivered with the unit, located inside of the outdoor unit (bottom side of the top plate).

12.1.1 Unified wiring diagram legend

For applied parts and numbering, refer to the wiring diagram on the unit. Part numbering is by Arabic numbers in ascending order for each part and is represented in the overview below by "*" in the part code.

Symbol	Meaning	Symbol	Meaning
	Circuit breaker		Protective earth
	Connection		Protective earth (screw)
	Connector		Rectifier
	Earth		Relay connector
	Field wiring		Short-circuit connector
	Fuse		Terminal
	Indoor unit		Terminal strip
	Outdoor unit		Wire clamp
	Residual current device		

Symbol	Colour	Symbol	Colour
BLK	Black	ORG	Orange
BLU	Blue	PNK	Pink
BRN	Brown	PRP, PPL	Purple
GRN	Green	RED	Red
GRY	Grey	WHT	White
		YLW	Yellow

Symbol	Meaning
A*P	Printed circuit board
BS*	Pushbutton ON/OFF, operation switch
BZ, H*O	Buzzer
C*	Capacitor
AC*, CN*, E*, HA*, HE*, HL*, HN*, HR*, MR*_A, MR*_B, S*, U, V, W, X*A, K*R_*, NE	Connection, connector
D*, V*D	Diode
DB*	Diode bridge
DS*	DIP switch
E*H	Heater
FU*, F*U, (for characteristics, refer to PCB inside your unit)	Fuse
FG*	Connector (frame ground)
H*	Harness
H*P, LED*, V*L	Pilot lamp, light emitting diode
HAP	Light emitting diode (service monitor green)
HIGH VOLTAGE	High voltage
IES	Intelligent eye sensor
IPM*	Intelligent power module
K*R, KCR, KFR, KHuR, K*M	Magnetic relay
L	Live
L*	Coil
L*R	Reactor
M*	Stepper motor
M*C	Compressor motor
M*F	Fan motor
M*P	Drain pump motor
M*S	Swing motor
MR*, MRCW*, MRM*, MRN*	Magnetic relay
N	Neutral
n=*, N=*	Number of passes through ferrite core
PAM	Pulse-amplitude modulation
PCB*	Printed circuit board
PM*	Power module
PS	Switching power supply
PTC*	PTC thermistor
Q*	Insulated gate bipolar transistor (IGBT)
Q*C	Circuit breaker
Q*DI, KLM	Earth leak circuit breaker
Q*L	Overload protector
Q*M	Thermo switch
Q*R	Residual current device
R*	Resistor
R*T	Thermistor
RC	Receiver
S*C	Limit switch
S*L	Float switch
S*NG	Refrigerant leak detector
S*NPH	Pressure sensor (high)
S*NPL	Pressure sensor (low)
S*PH, HPS*	Pressure switch (high)

12 Technical data

Symbol	Meaning
S*PL	Pressure switch (low)
S*T	Thermostat
S*RH	Humidity sensor
S*W, SW*	Operation switch
SA*, F1S	Surge arrester
SR*, WLU	Signal receiver
SS*	Selector switch
SHEET METAL	Terminal strip fixed plate
T*R	Transformer
TC, TRC	Transmitter

Symbol	Meaning
V*, R*V	Varistor
V*R	Diode bridge, Insulated-gate bipolar transistor (IGBT) power module
WRC	Wireless remote controller
X*	Terminal
X*M	Terminal strip (block)
Y*E	Electronic expansion valve coil
Y*R, Y*S	Reversing solenoid valve coil
Z*C	Ferrite core
ZF, Z*F	Noise filter

12.2 Piping diagram

12.2.1 Piping diagram: Outdoor unit

PED categories of equipment:

- High pressure switch: category IV,
- Compressor: category II;
- Other equipment: art. 4§3.

RXP50M, RXF50B, ARXF50A

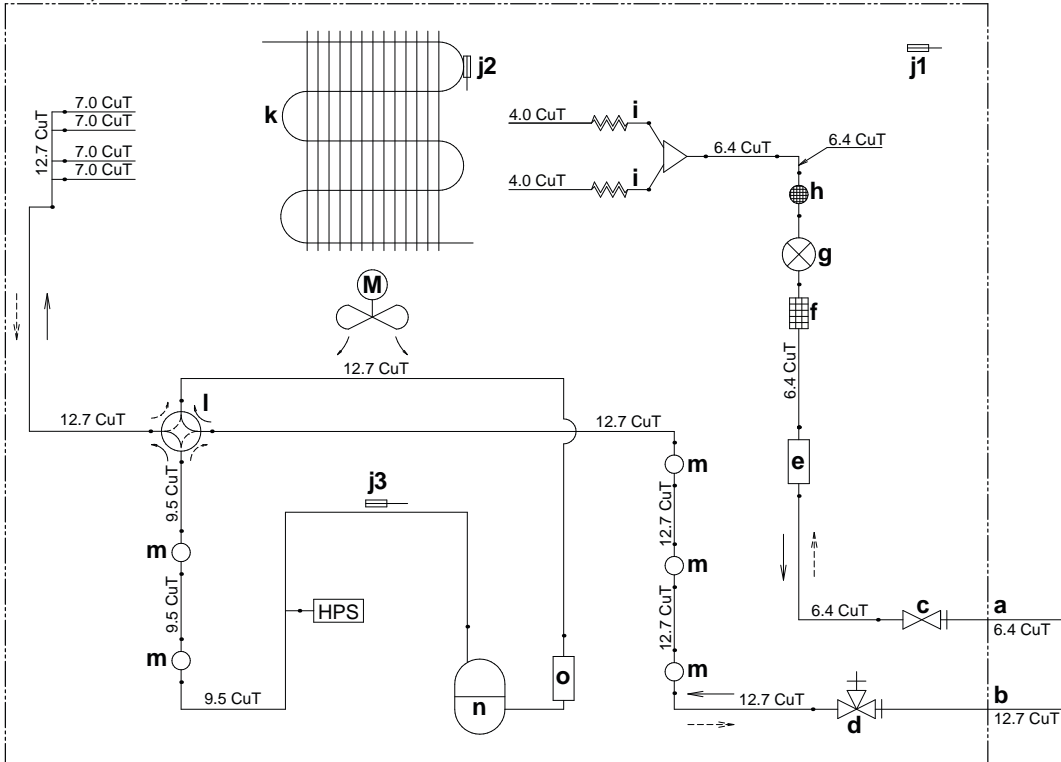

- | | | | |
|----|--------------------------------|------|--|
| a | Liquid field piping | j3 | Discharge pipe thermistor |
| b | Gas field piping | k | Heat exchanger |
| c | Liquid stop valve | l | 4-way valve (ON: heating) |
| d | Gas stop valve | m | Muffler |
| e | Liquid receiver | n | Compressor |
| f | Filter | o | Accumulator |
| g | Electronic expansion valve | HPS | High pressure switch (automatic reset) |
| h | Muffler with filter | M | Propeller fan |
| i | Capillary tube | → | Refrigerant flow: cooling |
| j1 | Outdoor temperature thermistor | ---→ | Refrigerant flow: heating |
| j2 | Heat exchanger thermistor | | |

RXP60M, RXP71M, RXF60B, RXF71A, ARXF60A, ARXF71A

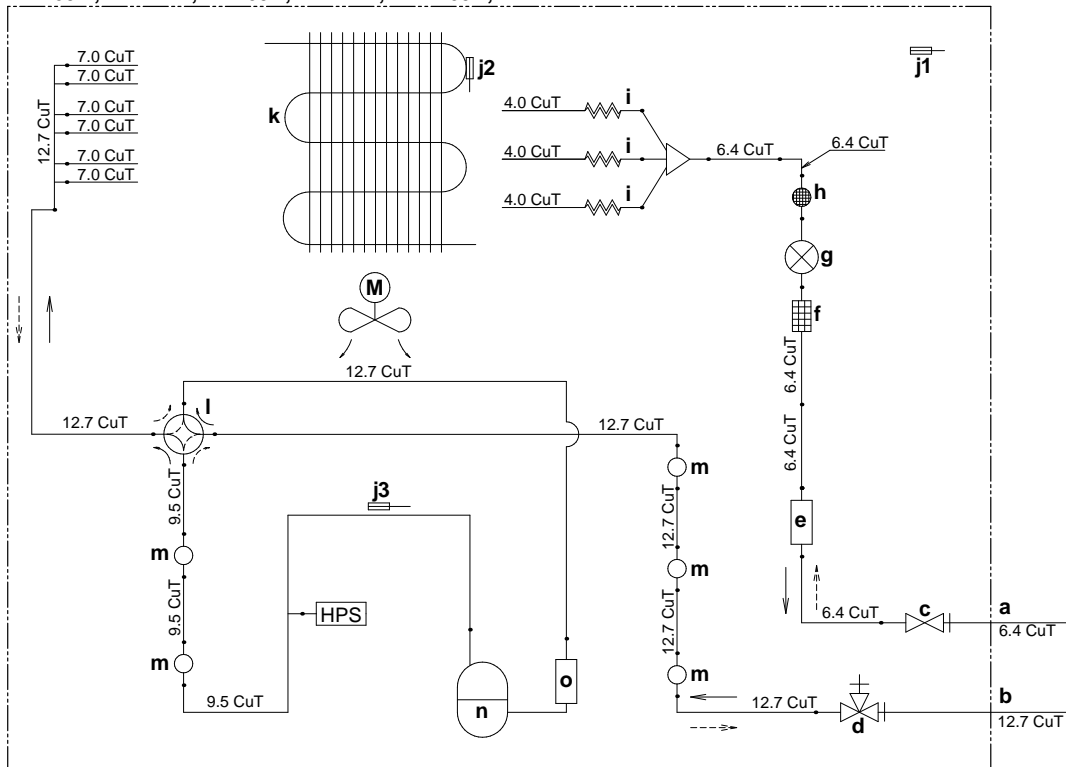

RXM71R

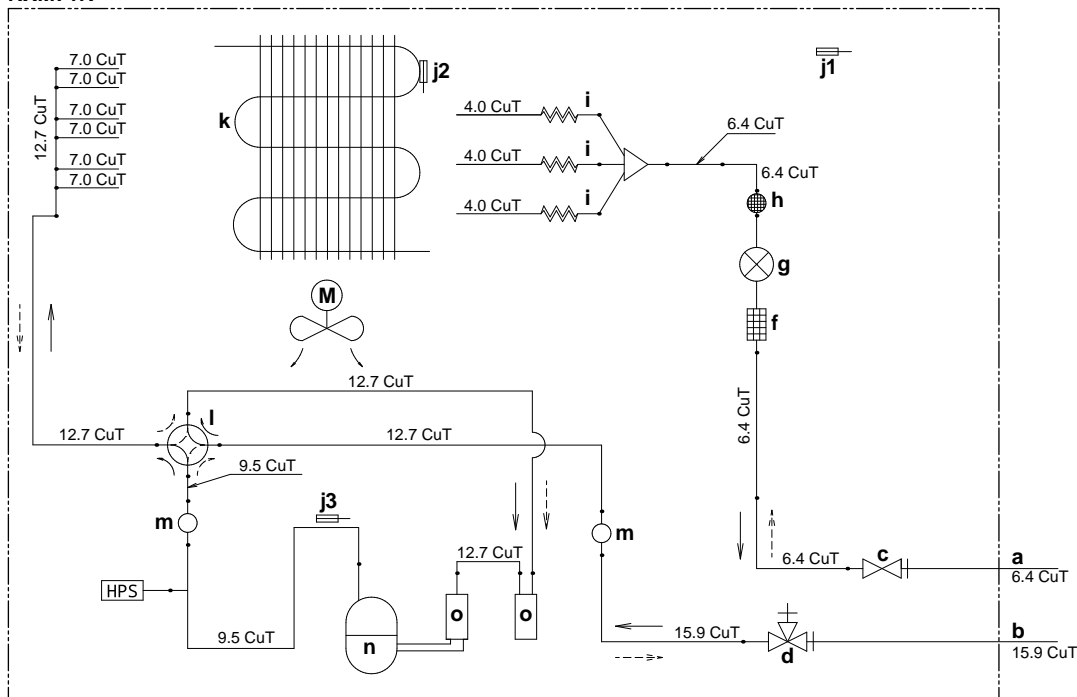

- | | | | |
|----|--------------------------------|------|--|
| a | Liquid field piping | j3 | Discharge pipe thermistor |
| b | Gas field piping | k | Heat exchanger |
| c | Liquid stop valve | l | 4-way valve (ON: heating) |
| d | Gas stop valve | m | Muffler |
| e | Liquid receiver | n | Compressor |
| f | Filter | o | Accumulator |
| g | Electronic expansion valve | HPS | High pressure switch (automatic reset) |
| h | Muffler with filter | M | Propeller fan |
| i | Capillary tube | → | Refrigerant flow: cooling |
| j1 | Outdoor temperature thermistor | ---> | Refrigerant flow: heating |
| j2 | Heat exchanger thermistor | | |

12 Technical data

RXJ50N, RXA42B, RXA50B

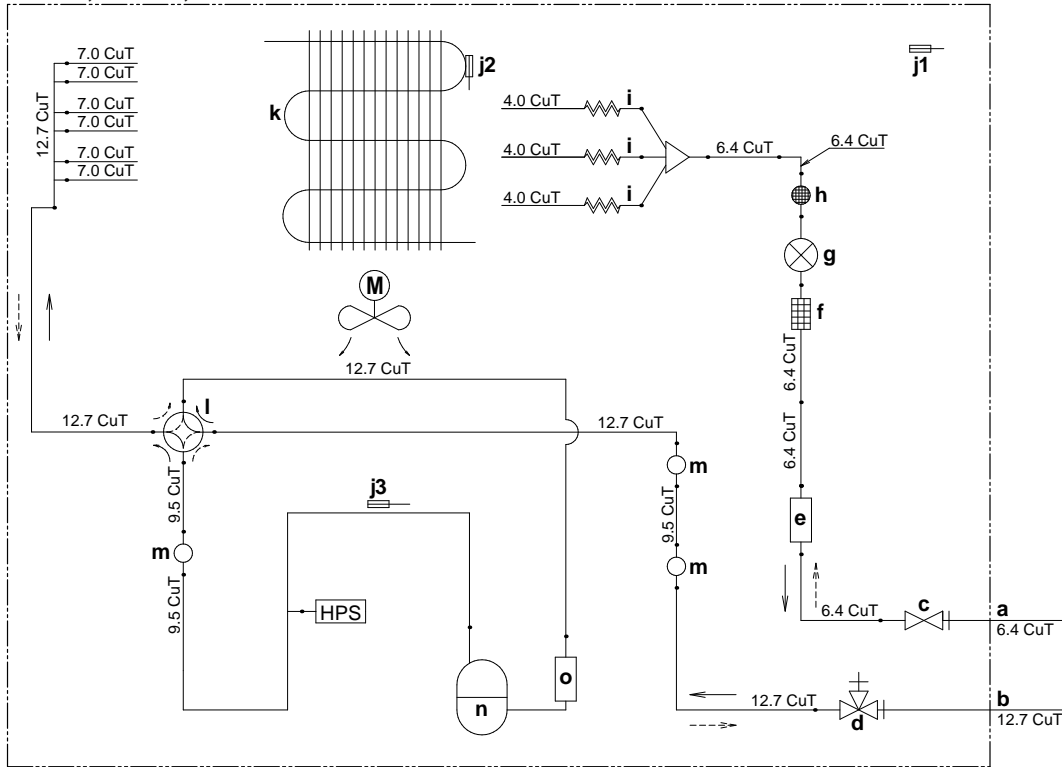

ARXM71R

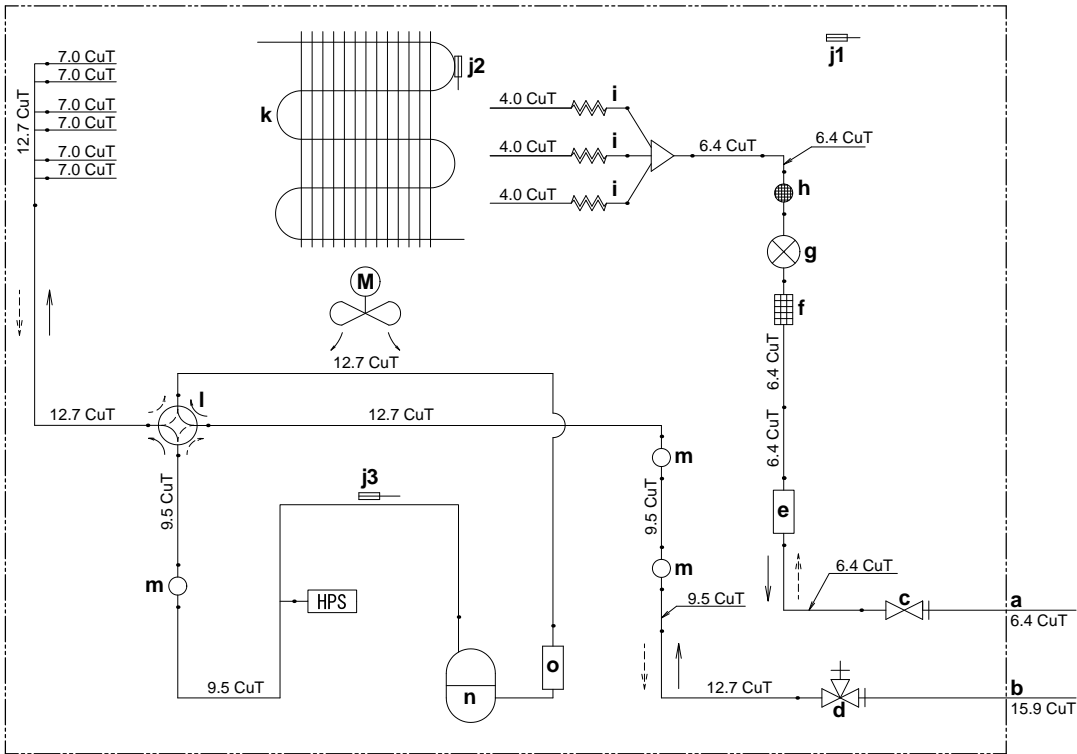

- | | | | |
|----|--------------------------------|------|--|
| a | Liquid field piping | j3 | Discharge pipe thermistor |
| b | Gas field piping | k | Heat exchanger |
| c | Liquid stop valve | l | 4-way valve (ON: heating) |
| d | Gas stop valve | m | Muffler |
| e | Liquid receiver | n | Compressor |
| f | Filter | o | Accumulator |
| g | Electronic expansion valve | HPS | High pressure switch (automatic reset) |
| h | Muffler with filter | M | Propeller fan |
| i | Capillary tube | → | Refrigerant flow: cooling |
| j1 | Outdoor temperature thermistor | ---→ | Refrigerant flow: heating |
| j2 | Heat exchanger thermistor | | |

RXM42R

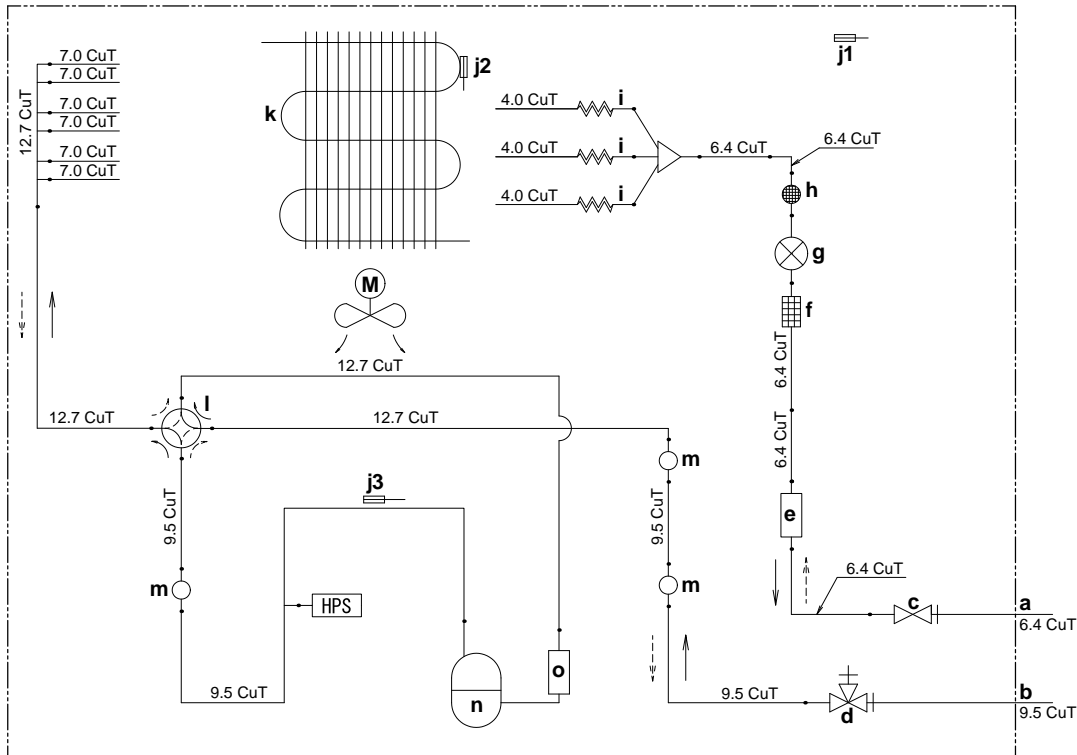

RXM50R, RXM60R, ARXM50R, ARXM60R

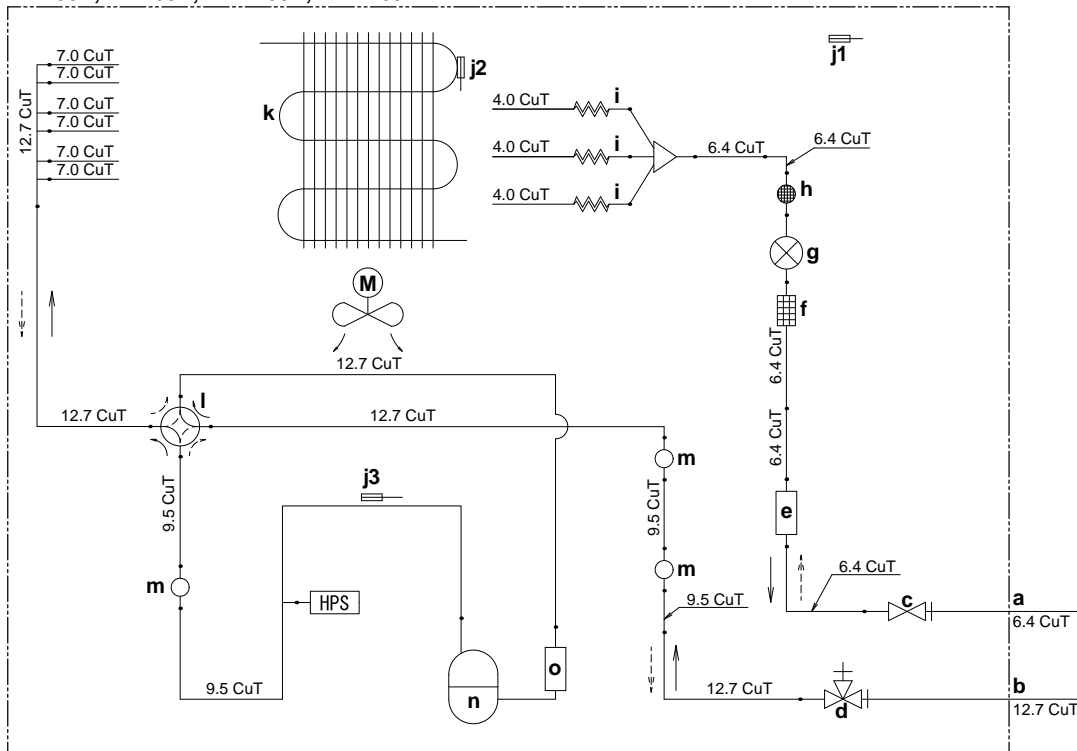

- | | |
|--|---|
| <p>a Liquid field piping
 b Gas field piping
 c Liquid stop valve
 d Gas stop valve
 e Liquid receiver
 f Filter
 g Electronic expansion valve
 h Muffer with filter
 i Capillary tube
 j1 Outdoor temperature thermistor
 j2 Heat exchanger thermistor</p> | <p>j3 Discharge pipe thermistor
 k Heat exchanger
 l 4-way valve (ON: heating)
 m Muffler
 n Compressor
 o Accumulator
 HPS High pressure switch (automatic reset)
 M Propeller fan
 Refrigerant flow: cooling
 Refrigerant flow: heating</p> |
|--|---|

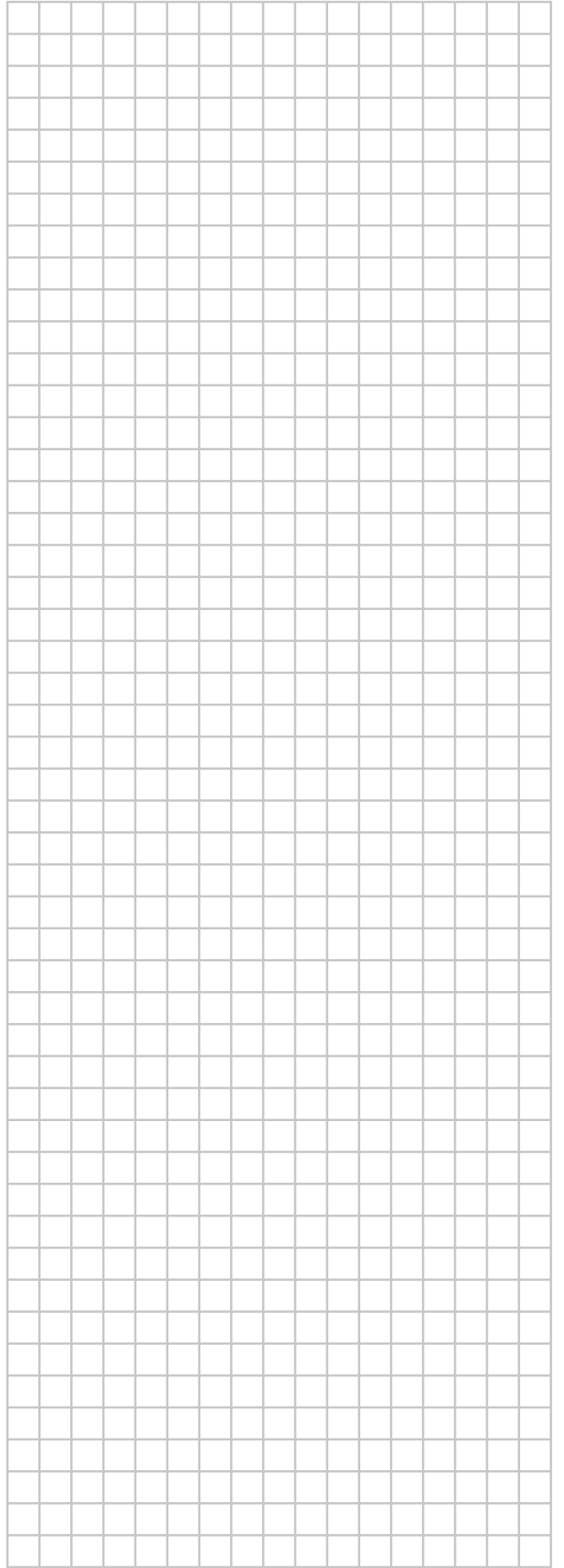
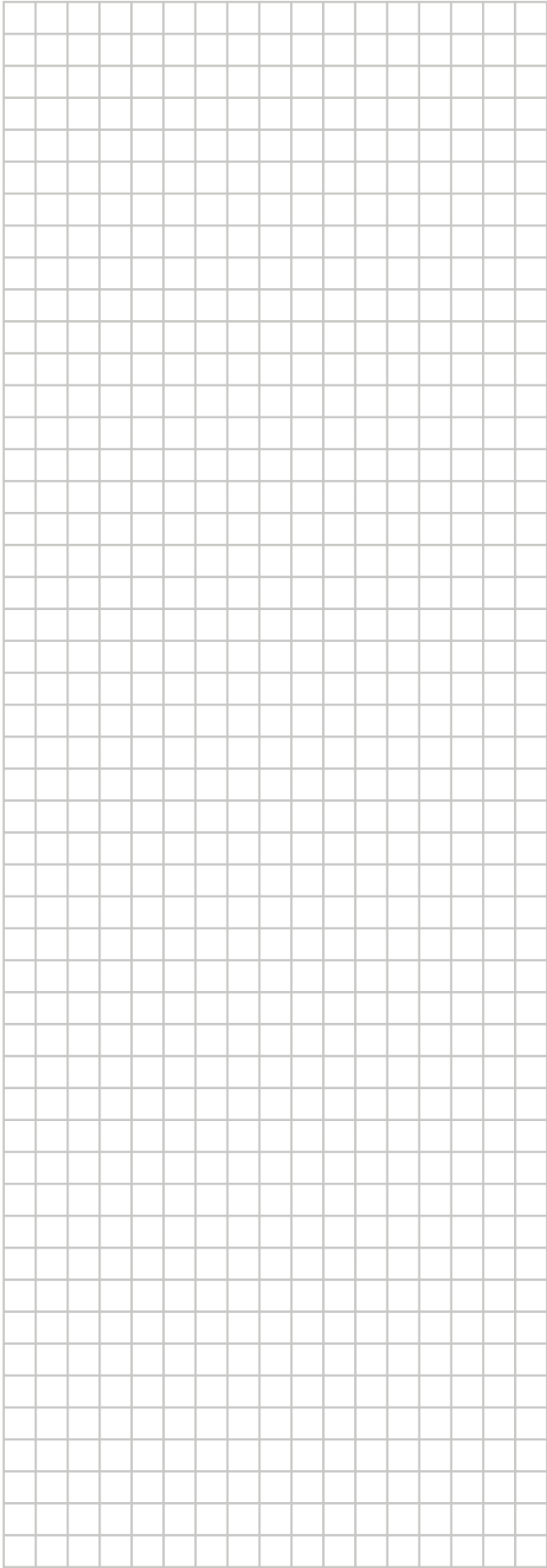

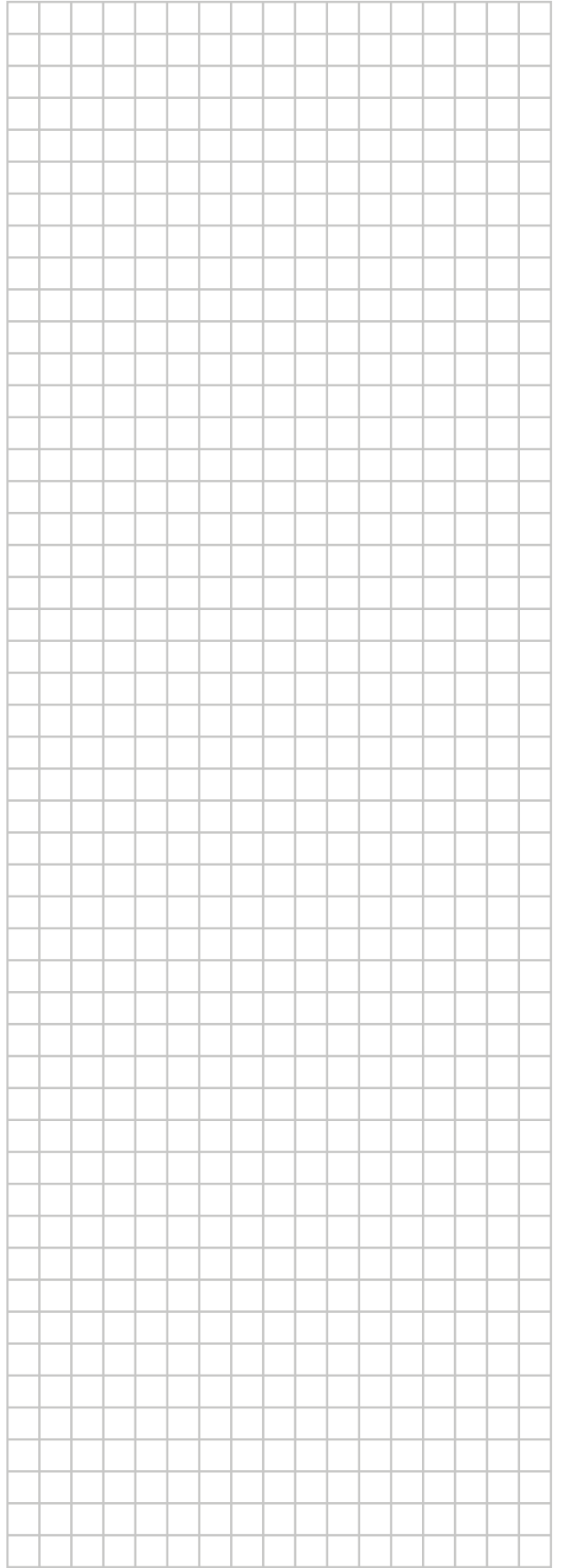
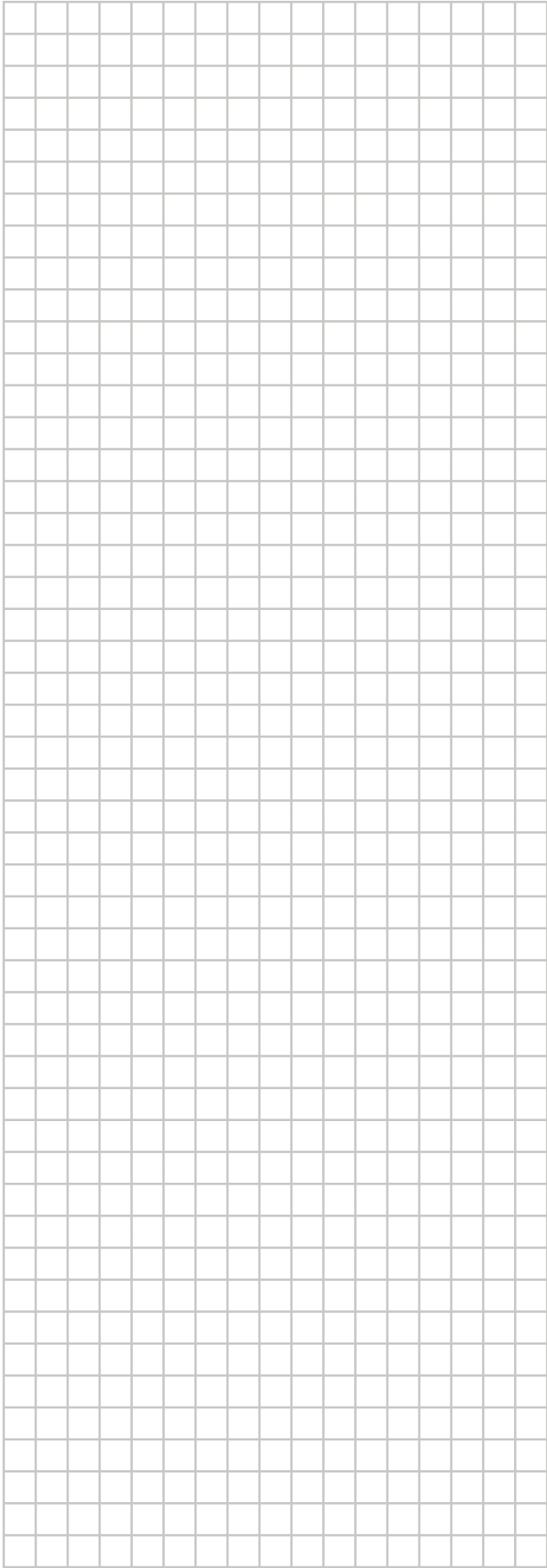

ERC



DAIKIN INDUSTRIES CZECH REPUBLIC s.r.o.
U Nové Hospody 1/1155, 301 00 Plzeň Skvrňany, Czech Republic

DAIKIN EUROPE N.V.
Zandvoordestraat 300, B-8400 Oostende, Belgium

Copyright 2020 Daikin

3P512025-9S 2020.05