

DAIKIN

INVERTER

DAIKIN ROOM AIR CONDITIONER

Operation Manual

MODELS FTXR28EV1B
FTXR42EV1B
FTXR50EV1B

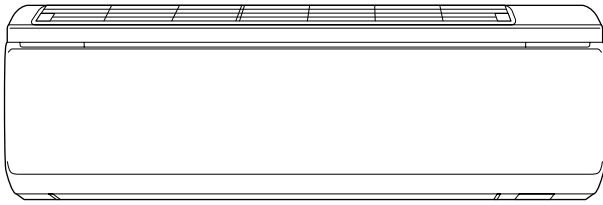

English

Deutsch

Français

Nederlands

Español

Italiano

Ελληνικά

Portugues

Русский

Türkçe

CONTENTS

READ BEFORE OPERATION

Safety Precautions	2
Names of Parts	3
Preparation Before Operation	5

OPERATION

COOLING · “SARARA” DRYING Operation.....	7
HEATING · “URURU” HUMIDIFYING Operation	8
AUTO Operation	9
MOISTURIZING Operation	9
ADJUSTING AIRFLOW DIRECTION · COMFORT AIRFLOW MODE · COOLING BREEZE · AIRFLOW RATE	10
FLASH STREAMER AIR PURIFYING · FRESH AIR SUPPLY VENTILATION Operation	11
HOME LEAVE VENTILATION	11
TIMER Operation	12
COMFORT SLEEP Operation.....	13
POWERFUL Operation	13
SET UP	14
MOLD PROOF Operation	15
MOLD SHOCK OUT Operation.....	16
INFORMATION DISPLAY	16

CARE

Care and Cleaning	17
-------------------------	----

TROUBLE SHOOTING





Trouble Shooting.....	25
-----------------------	----

Safety Precautions



- Keep this manual where the operator can easily find them.
- Read this manual attentively before starting up the unit.
- For safety reason the operator must read the following cautions carefully.
- This manual classifies precautions into WARNING and CAUTION. Be sure to follow all precautions below: they are all important for ensuring safety.

⚠ WARNING If you do not follow these instructions exactly, the unit may cause property damage, personal injury or loss of life.





⚠ CAUTION If you do not follow these instructions exactly, the unit may cause minor or moderate property damage or personal injury.

 Never do.	 Be sure to follow the instructions.	 Be sure to earth the air conditioner.
 Never cause the air conditioner (including the remote controller) to get wet.	 Never touch the air conditioner (including the remote controller) with a wet hand.	

⚠ WARNING

- In order to avoid fire, explosion or injury, do not operate the unit when harmful, among which flammable or corrosive gases, are detected near the unit. 
- It is not good for health to expose your body to the air flow for a long time.
- Do not put a finger, a rod or other objects into the air outlet or inlet. As the fan is rotating at a high speed, it will cause injury.
- Do not attempt to repair, relocate, modify or reinstall the air conditioner by yourself. Incorrect work will cause electric shocks, fire etc. For repairs and reinstallation, consult your Daikin dealer for advice and information.
- Do not insert fingers, poles, or other objects into the moving parts of the front panel or the outlet vent panel.
- The refrigerant used in the air conditioner is safe. Although leaks should not occur, if for some reason any refrigerant happens to leak into the room, make sure it does not come in contact with any flame as of gas heaters, kerosene heaters or gas range. 
- If the air conditioner is not cooling (heating) properly, the refrigerant may be leaking, so call your dealer. When carrying out repairs accompanying adding refrigerant, check the content of the repairs with our service staff.
- Do not attempt to install the air conditioner by your self. Incorrect work will result in water leakage, electric shocks or fire. For installation, consult the dealer or a qualified technician.
- In order to avoid electric shock, fire or injury, if you detect any abnormally such as smell of fire, stop the operation and turn off the breaker. And call your dealer for instructions.

⚠ CAUTION

- The air conditioner must be earthed. Incomplete earthing may result in electric shocks. Do not connect the earth line to a gas pipe, water pipe, lightning rod, or a telephone earth line. 
- In order to avoid any quality deterioration, do not use the unit for cooling precision instruments, food, plants, animals or works of art. 
- Never expose little children, plants or animals directly to the air flow.
- Do not place appliances which produce open fire in places exposed to the air flow from the unit or under the indoor unit. It may cause incomplete combustion or deformation of the unit due to the heat.
- Do not block air inlets nor outlets. Impaired air flow may result in insufficient performance or trouble.
- Do not stand or sit on the outdoor unit. Do not place any object on the unit to avoid injury, do not remove the fan guard.
- Do not place anything under the indoor or outdoor unit that must be kept away from moisture. In certain conditions, moisture in the air may condense and drip.
- After a long use, check the unit stand and fittings for damage.
- Do not touch the air inlet and aluminum fins of outdoor unit. It may cause injury.
- The appliance is not intended for use by young children or infirm persons without supervision.
- Young children should be supervised to ensure that they do not play with the appliance.
- To avoid oxygen deficiency, ventilate the room sufficiently if equipment with burner is used together with the air conditioner. 
- Before cleaning, be sure to stop the operation, turn the breaker off or pull out the supply cord.
- Do not connect the air conditioner to a power supply different from the one as specified. It may cause trouble or fire.
- Depending on the environment, an earth leakage breaker must be installed. Lack of an earth leakage breaker may result in electric shocks, or fire.
- Arrange the drain hose to ensure smooth drainage. Incomplete draining may cause wetting of the building, furniture etc.
- Do not place objects in direct proximity of the outdoor unit and do not let leaves and other debris accumulate around the unit. Leaves are a hotbed for small animals which can enter the unit. Once in the unit, such animals can cause malfunctions, smoke or fire when making contact with electrical parts.
- Do not operate the air conditioner with wet hands. 
- Do not wash the indoor unit with excessive water, only use a slightly wet cloth. 
- Do not place things such as vessels containing water or anything else on top of the unit. Water may penetrate into the unit and degrade electrical insulations, resulting in an electric shock.

Installation site.

- To install the air conditioner in the following types of environments, consult the dealer.
 - Places with an oily ambient or where steam or soot occurs.
 - Salty environment such as coastal areas.
 - Places where sulfide gas occurs such as hot springs.
 - Places where snow may block the outdoor unit.
- The drain from the outdoor unit must be discharged to a place of good drainage.

Consider nuisance to your neighbours from noises.

- For installation, choose a place as described below.
 - A place solid enough to bear the weight of the unit which does not amplify the operation noise or vibration.
 - A place from where the air discharged from the outdoor unit or the operation noise will not annoy your neighbours.

Electrical work.

- For power supply, be sure to use a separate power circuit dedicated to the air conditioner.

System relocation.

- Relocating the air conditioner requires specialized knowledge and skills. Please consult the dealer if relocation is necessary for moving or remodeling.

Names of Parts

Indoor Unit

1. Streamer unit: (page 20-22.)
2. Deodorizing filter for streamer (Black)
3. Air inlet
4. Front panel
5. Upper panel
6. Air filter (Light blue): (page 19.)
7. Titanium apatite photocatalytic air-purifying filter (Black): (page 20-22.)
8. Air supply filter (Yellow): (page 23.)
9. Horizontal louver: (page 10.)
10. Vertical louver:
 - In the air outlet. (page 10.)
11. Air outlet
12. Room humidity sensor:
 - It senses the air humidity around the indoor unit.
13. Room temperature sensor:
 - It senses the air temperature around the indoor unit.
14. Display
15. Indoor unit ON/OFF switch:
 - Push this switch once to start operation.
 - Push once again to stop it.
16. Multi-colored indicator lamp:
 - The lamp color changes according to the operation.
 - HEATING Red
 - "URURU" HUMIDIFYING / HUMID HEATING Orange
 - COOLING Green
 - "SARARA" DRYING / DRY COOLING Yellow
 - The lamp color also changes according to the optional function.
 - FLASH STREAMER AIR PURIFYING / FRESH AIR SUPPLY VENTILATION ... White (Only for the first 2 seconds during operation of the air conditioner.)
17. TIMER lamp (Orange): (page 12.)
18. MOISTURIZING lamp (Green): (page 9.)
19. Signal receiver:
 - Receives / sends signals from/to the remote controller.
 - The multi-colored indicator lamp blinks with beep sound to indicate signal reception.
 - Operation start two beeps
 - Settings changed one beep
 - Operation stop long beep

Indoor Unit

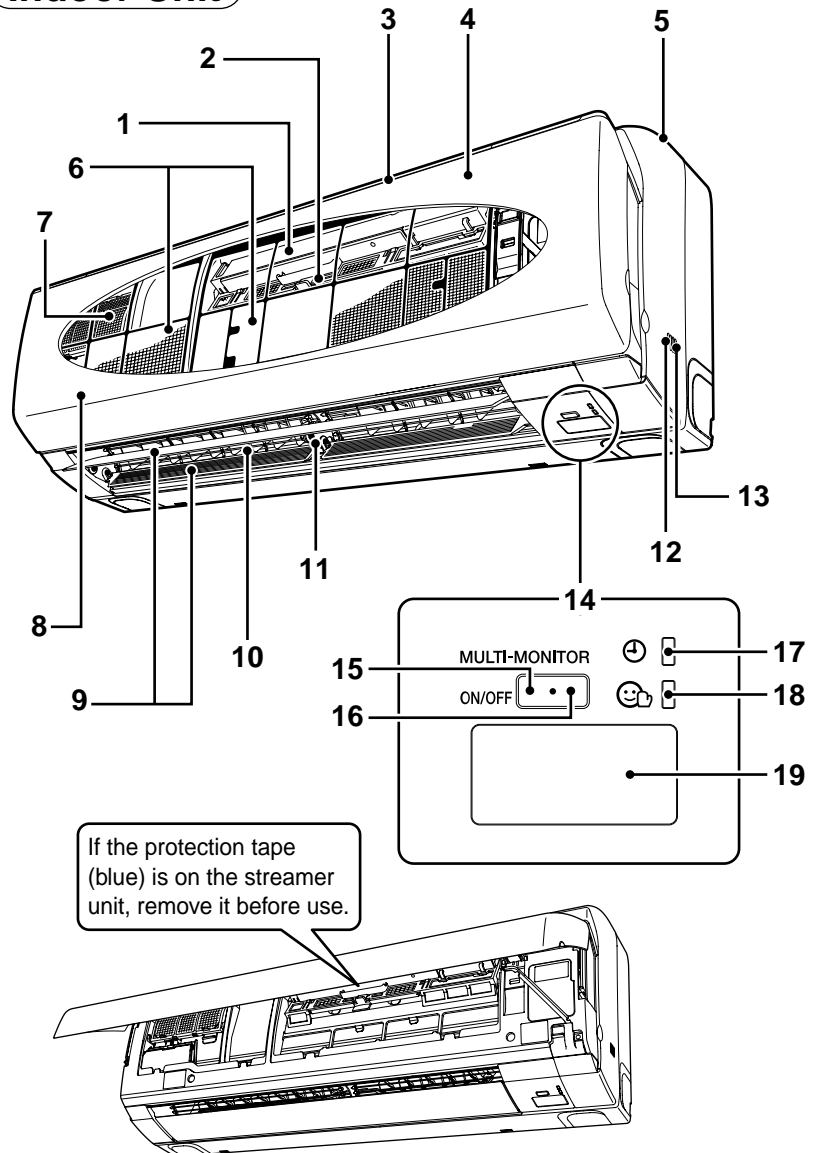

Outdoor Unit

Outdoor Unit

20. Humidify unit air outlet: (Front side)
21. Air inlet: (Back and left side)
22. Air outlet
23. Humidify unit air intake: (Front and back)
24. Outdoor temperature sensor:
 - It senses the air temperature around the outdoor unit. (Back side)
25. Refrigerant piping, humidifying hose and inter-unit cable
26. Drain hose:
 - Drains water coming from the indoor unit.
27. Earth terminal:
 - It is inside of this cover.

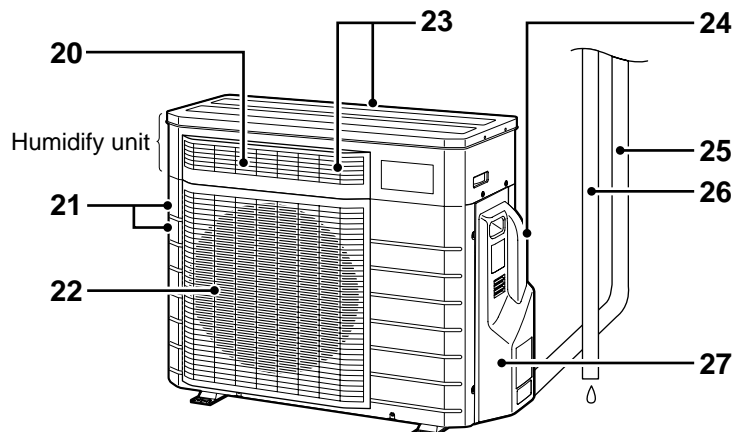

Remote Controller

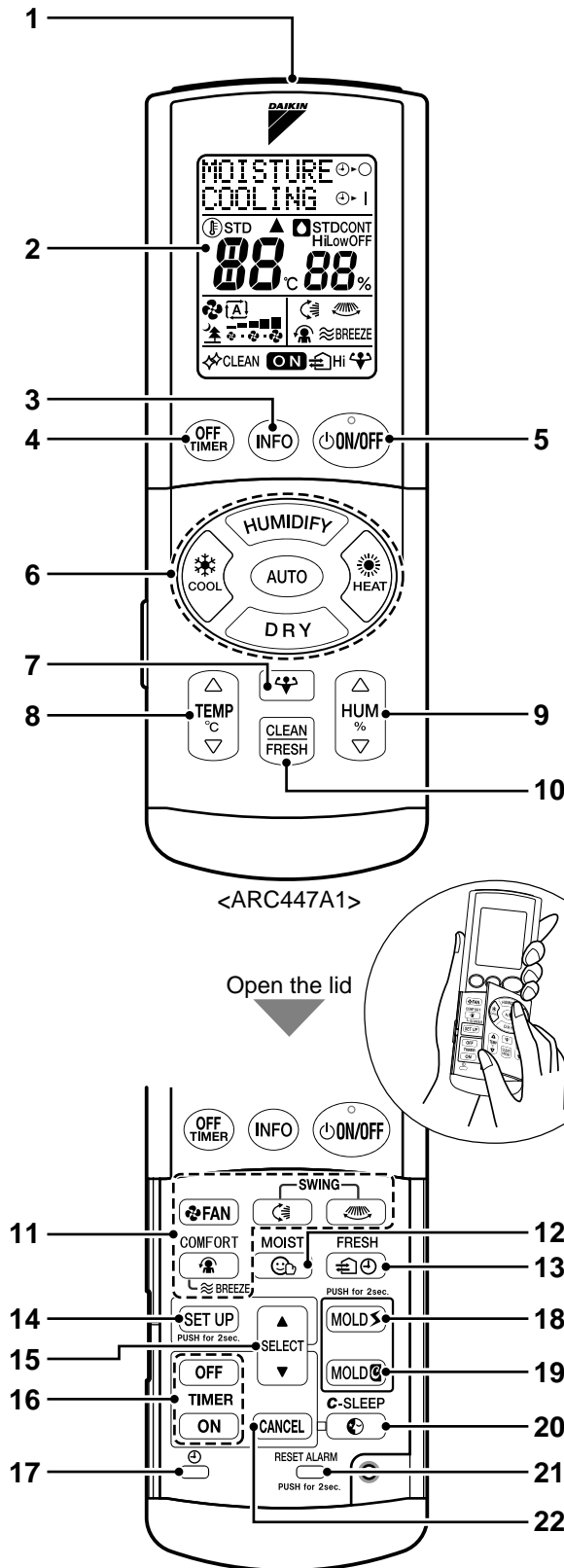

Remote Controller

1. Transmitter / Receiver

2. Display:

- It displays the current settings.
(In this illustration, each section is shown with all its displays ON for the purpose of explanation.)
* The protection sheet is on the display to protect against scratch. Remove it before use.

3. INFORMATION button:

- Displays the indoor temperature and humidity and the outdoor temperature. (page 16.)

4. COUNTDOWN OFF TIMER button:

- Sets time to stop. (page 12.)

5. ON/OFF button:

- Stops operation selected with the direct operation button. Another press will restart the same operation.

6. Direct operation button:

- AUTO button (page 9.)
- “URURU” HUMIDIFYING button (page 8.)
- HEATING button (page 8.)
- “SARARA” DRYING button (page 7.)
- COOLING button (page 7.)

7. POWERFUL button:

- Makes cooling or heating more powerful. (Canceled in 20 minutes.) (page 13.)

8. TEMPERATURE adjustment buttons:

- It changes the temperature setting.

9. HUMIDITY buttons:

- It changes the humidity setting.

10. FLASH STREAMER AIR PURIFYING / FRESH AIR SUPPLY VENTILATION button:

- Cleans the room air. (page 11.)

11. AIRFLOW DIRECTION / AIRFLOW RATE / COMFORT AIRFLOW / COOLING BREEZE button:

- Adjusts air direction and volume. (page 10.)

12. MOISTURIZING button:

- Keeps humidity high to moisturizes your skin. (page 9.)

13. HOME LEAVE VENTILATION button:

- Ventilates the room during home leaving.

14. SET UP button:

- Sets the unit operation and remote controller display according to your preference. (page 14.)

15. TIMER SELECT button

16. TIMER Setting button:

- Sets the time for timer-on or timer-off. (page 12.)

17. CLOCK button:

- Sets the present time. (page 6.)

18. MOLD SHOCK OUT button:

- Continuously runs the dehumidifying operation to keep the room air dry and clean. (page 16.)

19. MOLD PROOF button:

- Dries the inside of the unit to prevent mold and odor growth. (page 15.)

20. COMFORT SLEEP button:

- Controls the room temperature to support comfort sleep and pleasant wake-up. (page 13.)

21. RESET button:

- Cleaning indicator reset. (page 17.)

22. CANCEL button

Preparation Before Operation

■ To set the batteries

1. Press  with a finger and slide the cover to take it off.
2. Set two dry batteries (AAA).
3. Set the cover as before.

- Characters on the display will blink. Set the present time. (page 6.)

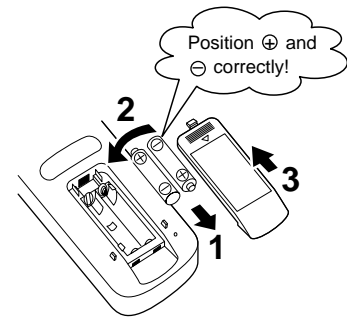

■ How to use

- To use the remote controller, aim the transmitter at the indoor unit. If there is anything to block signals between the unit and the remote controller, such as a curtain, the unit will not operate.
- The maximum distance for communication is about 7m.
- Do not drop the remote controller. Do not get it wet. (Damage to LCD may occur.)

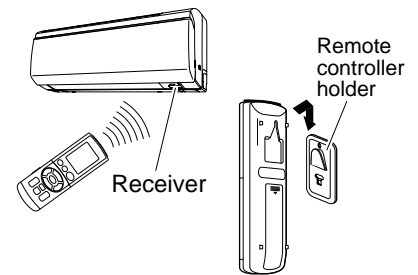

■ To fix the remote controller holder on the wall

1. Choose a place from where the signals reach the unit.
2. Fix the remote controller holder to a wall or pillar using the included screws.
3. Hook the holes on back of the remote controller to the protruding tabs on the remote controller holder.

■ Attach the Titanium apatite photocatalytic air-purifying filter, deodorizing filter for streamer, and air supply filter (page 20, 23.)

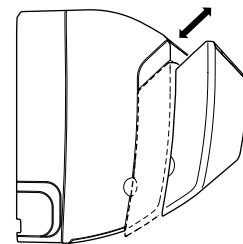

■ Turn on the power breaker

- Turning on the power breaker will cause the front panel and horizontal louver to open once and then close again. (This is a normal procedure.)

⚠ CAUTION

- During operation (i.e. when the panel is open or being opened or closed), do not touch the panel with your hands.

ATTENTION

- Wrap the terminals with tape to insulate them before discarding batteries. Mixing with other metals or batteries may cause heat, explosion or fire.

PRECAUTION

■ About batteries

- The included batteries are provided to be used at first. Depending on when the air conditioner was manufactured, these batteries may run out in less than a year.
- We recommend replacing once a year, although if the remote controller display begins to fade or if reception deteriorates, please replace with new alkaline batteries.
- When replacing the batteries, use batteries of the same type, and replace the two old batteries together.
- Batteries close to their expiration dates will have to be replaced sooner.
- To prevent breakage or injury due to leaking or explosion, remove the batteries if the unit is not used for a long period of time.

■ About remote controller

- Signal communication may be disabled if an electronic-starter-type fluorescent lamp (such as inverter-type lamps) is in the room. Consult the shop if that is the case.
- If the remote controller signals happen to operate another appliance, move that appliance to somewhere else, or consult the shop.
- Direct sunlight on the transmitter/receiver may cause the unit to work harder.

■ To set the clock

* Time cannot be set during unit operation.

1. Press “⊕”.

Do not hold the button.



0:00 is displayed.

⊕ blinks.

2. Press “SELECT” to set the clock to the present time.

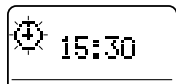

• Holding the button changes the time faster.

3. Press “⊕”.

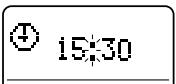

⋮ blinks.

⊕ is displayed.

• Setting is complete.

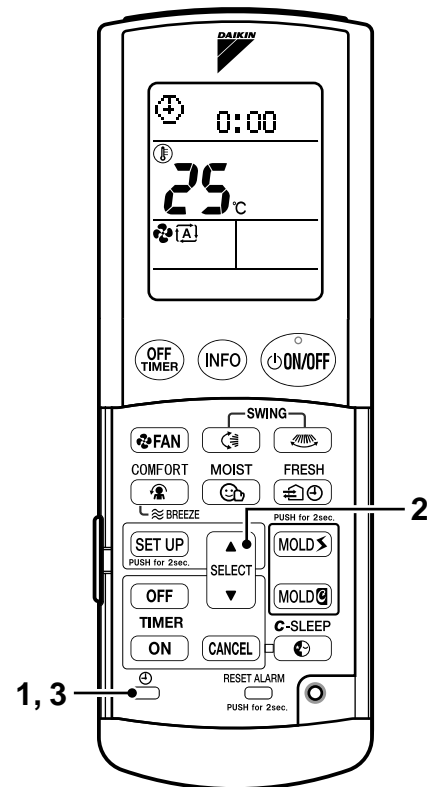

ATTENTION

If other messages than time appear on the display with the step 1 operation, do not operate the button for about 60 seconds. The display will return to normal.

■ Tips for saving energy

- Be careful not to cool (heat) the room too much. Keeping the temperature setting at a moderate level helps save energy.
- Cover windows with a blind or a curtain. Blocking sunlight and air from outdoors increases the cooling (heating) effect.
- Clogged air filters cause inefficient operation and waste energy. Periodically clean the filter.

■ Please note

- The air conditioner consumes power even when it is not operating.
- If you are not going to use the air conditioner for a long period, for example in spring or autumn, turn the breaker OFF.
- When the outdoor temperature is below -15°C , turn on the breaker more than 1 hour before starting the operation. (This is to warm up the compressor.)

■ Operating conditions

- Running the unit under conditions not listed below may cause the safety device to activate, stopping the unit. Also, condensation may form on the indoor unit and drip. (DRY / COOLING operation)

COOLING	Outdoor temperature : 21 to 43°C Indoor temperature : 18 to 32°C Indoor humidity : 80% max.	HEATING	Outdoor temperature : -20 to 24°C Indoor temperature : 10 to 30°C Indoor humidity : 70% max.
DRY	Outdoor temperature : 10 to 42°C Indoor temperature : 18 to 30°C Indoor humidity : 80% max.	HUMIDIFYING	Outdoor temperature : -10 to 24°C Indoor temperature : 12 to 30°C Indoor humidity : 70% max.

■ Reachable Humidity

- The ability of humidification drops when the outdoor temperature and humidity are low. (See Fig.1 as reference.)

Fig.1 Reachable Humidity

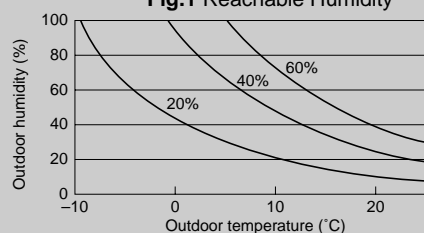

Condition;
Model: FTXR50EV1B
Indoor temperature setting: 20°C
Airflow rate: Max.
Room volume: 120m³
Air change rate: 0.5/hour
Humidifying hose length: 7.5m

Recommended temperature setting
For cooling : 26°C – 28°C
For heating : 20°C – 22°C

COOLING · “SARARA” DRYING Operation

■ COOLING operation

- To lower temperature



- To lower temperature and humidity



* It is recommended to switch to COOLING operation if you want to lower temperature preferentially during DRY COOLING operation.

■ “SARARA” DRYING operation

- To lower humidity

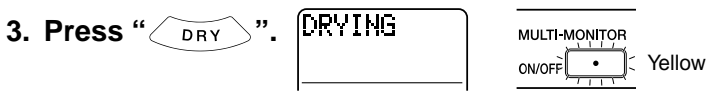

■ To change the airflow direction and airflow rate (page 10.)



- The airflow rate is set to “AUTO” during DRY COOLING or “SARARA” DRYING operation. Airflow rate cannot be changed.

■ To stop operation

4. Press “”.

The multi-colored indicator of the unit will go off.

■ To change the temperature or humidity setting

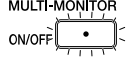
	COOLING	DRY COOLING	DRY
		18°C – 32°C	-3°C – STD
		OFF ⇄ HIGH ⇄ STD ⇄ LOW ⇄ CONT	HIGH ⇄ STD ⇄ LOW ⇄ CONT
	Green	Yellow	

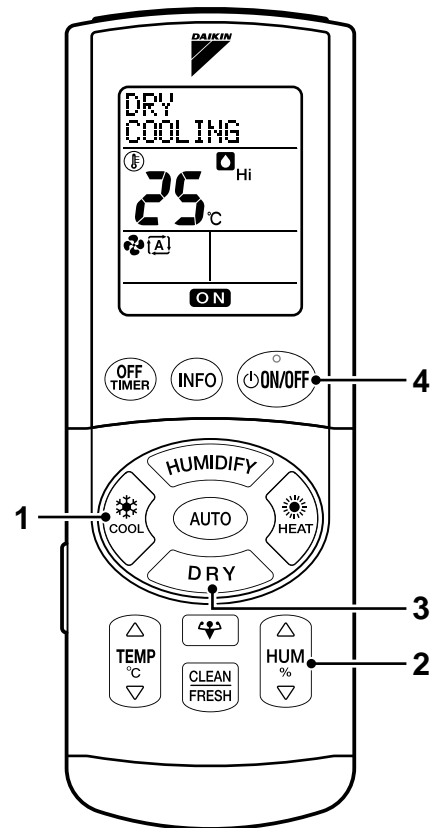

NOTE

■ Note on ON / OFF button

- Pressing “” will start the same operation as the last time.

■ Note on COOLING operation

- This air conditioner cools the room by blowing the hot air in the room outside, so if the outside temperature is high, performance drops.

■ Note on DRY COOLING

- Pressing the humidity button down in COOLING mode set the unit to DRY COOLING.
- Removes more humidity than the normal COOLING operation. It is recommended, however, to set temperature slightly lower than the room temperature to lower humidity because this operation mode does not heat air supplementary.

■ Note on “SARARA” DRYING operation

- Removes humidity with less lowering of the room temperature by heating air supplementary.
- The operation mode change from COOLING to “SARARA” DRYING may raise humidity temporarily.

HEATING · “URURU” HUMIDIFYING Operation

■ HEATING operation

- To raise temperature



- To raise temperature and humidity



■ “URURU” HUMIDIFYING operation

- To raise humidity





■ To change the airflow direction and airflow rate (page 10.)

■ To stop operation

4. Press “”.

The multi-colored indicator of the unit will go off.

■ To change the temperature or humidity setting

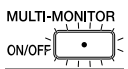
	HEATING	HUMID HEATING	HUMIDIFYING
		10°C – 30°C	—
		OFF ⇄ LOW ⇄ STD ⇄ HIGH ⇄ CONT	LOW ⇄ STD ⇄ HIGH ⇄ CONT
	Red	Orange	

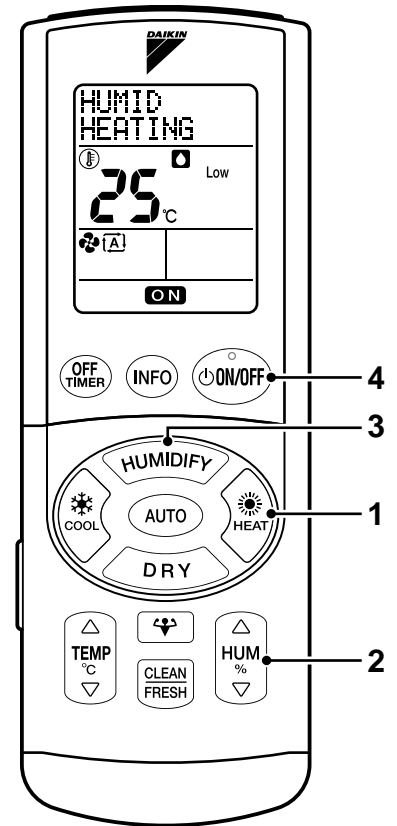

NOTE

■ Note on HEATING operation

- Since this air conditioner heats the room by taking heat from outdoor air to indoors, the HEATING capacity becomes smaller in lower outdoor temperatures. If the HEATING effect is insufficient, it is recommended to use another HEATING appliance in combination with the air conditioner.
- The heat pump system heats the room by circulating hot air around all parts of the room. After the start of HEATING operation, it takes some time before the room gets warmer.
- In HEATING operation, frost may occur on the outdoor unit and lower the HEATING capacity. In that case, the system switches into defrosting operation to take away the frost.
- During defrosting operation, hot air does not flow out of indoor unit.

■ Note on HUMID HEATING and “URURU” HUMIDIFYING operation

- The ability of the unit to humidify drops when the outdoor temperature and humidity are low, or when the set fan strength is low.
- The operation noise is higher than in normal HEATING.
- The outdoor noise or odor may be captured because the outdoor air is heated with the heater and resultant moisture is taken into the room for humidification.
- The top of the outdoor unit may get warm during operation, but this is not a malfunction.
- The operation noise may change depending on the outdoor temperature and humidity. (Water supply is not necessary because moisture from the outdoor air is taken into the room.)

■ Note on “URURU” HUMIDIFYING operation

- Can adjust the room humidify only according to your preference.
- When the room temperature gets low, slight heating may be on to continue humidification.

AUTO Operation

After pressing the AUTO button, the air conditioner will operate according to room conditions in an automatic mode.

1. Press “”.

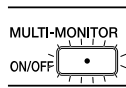
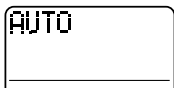

- HEATING: Red
- COOLING: Green

- The color of the multi-colored indicator changes according to the actual operations.
- When the AUTO button is pressed, the color according to the operation selected by the air conditioner will light up.

■ To change the airflow direction and airflow rate (page 10.)

■ To stop operation

2. Press “”.

The multi-colored indicator of the unit will go off.

■ To change the temperature setting



NOTE

■ Note on AUTO operation

- In AUTO operation, the system selects an appropriate operation mode (COOLING or HEATING) based on the room temperature at the start of the operation.
- The system automatically reselects setting at a regular interval to bring the room temperature to user setting level.
- If you do not like AUTO operation, you can manually select the operation mode and setting you like.

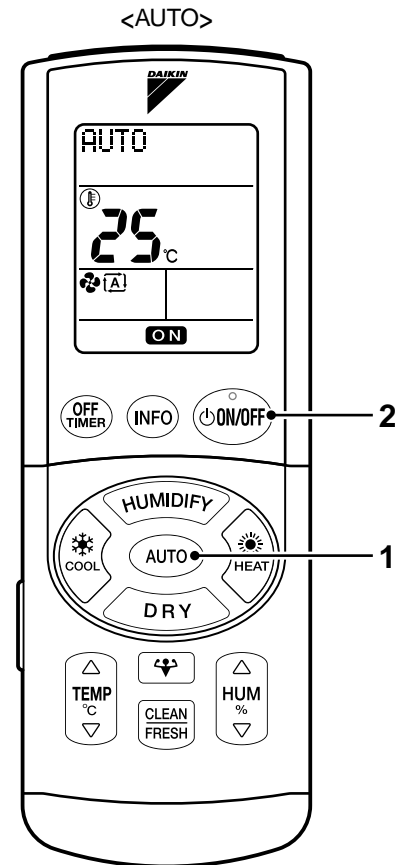

MOISTURIZING Operation

This mode moisturizes your skin.

1. Press “” during operation.

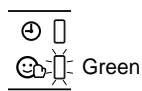
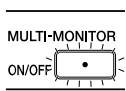
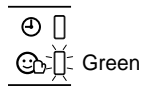
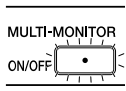

- The airflow rate and airflow direction settings are changed to auto and COMFORT AIRFLOW MODE respectively.
- In MOISTURIZING operation, COOLING BREEZE mode cannot be selected.

■ To change the temperature setting

- The same changes as COOLING and HEATING are possible. (page 7, 8.)
- Humidity and airflow rate cannot be changed.

■ To change the airflow direction (page 10.)

- The recommended airflow direction is COMFORT AIRFLOW MODE, but it can be changed.

■ To cancel the MOISTURIZING operation

2. Press “” again.

- The operation mode goes back to the previous one. The multi-colored indicator on the unit also goes back to the previous color.
- The MOISTURE lamp on the unit will go off.

NOTE

■ Note on MOISTURIZING operation

- The relative humidity is higher than in normal operation.
- Can be used for COOLING, DRY COOLING, HEATING and HUMID HEATING.
- The operation noise is slightly louder.

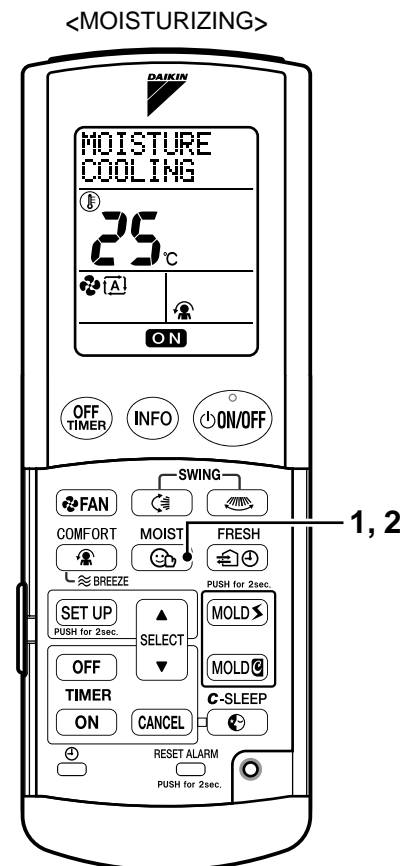

ADJUSTING AIRFLOW DIRECTION · COMFORT AIRFLOW MODE · COOLING BREEZE · AIRFLOW RATE

More comfortable airflow is provided with airflow direction and airflow rate adjustment.



■ To change vertical and horizontal airflow directions

1. Press “” or “” during operation.

 (In case of vertical direction) • The airflow direction indication will display.



The horizontal and vertical louvers respectively move vertically and horizontally automatically.

■ If you want to fix airflow direction

2. Press “” or “” again.



■ To use 3-D AIRFLOW

3. Press “” and then “” during operation.

  • The vertical and horizontal airflow direction indications will display.

The horizontal and vertical louvers move alternately.

■ To cancel 3-D AIRFLOW

4. Press “” or “” again.

■ COMFORT AIRFLOW MODE and COOLING BREEZE operation

5. The indication will change every time “” is pressed.

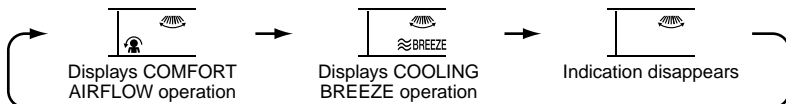

■ COMFORT AIRFLOW MODE operation

- The airflow direction and airflow rate are adjusted so that the air from the unit does not blow directly on the occupants of the room.
- < COOLING/DRYING > The flap will go up.
- < HEATING/HUMIDIFYING > The flap will go down.
- **The airflow rate is set to “AUTO”.**

■ COOLING BREEZE operation

- COOLING BREEZE operation is for COOLING, “SARARA” DRYING and FLASH STREAMER AIR PURIFYING operation.







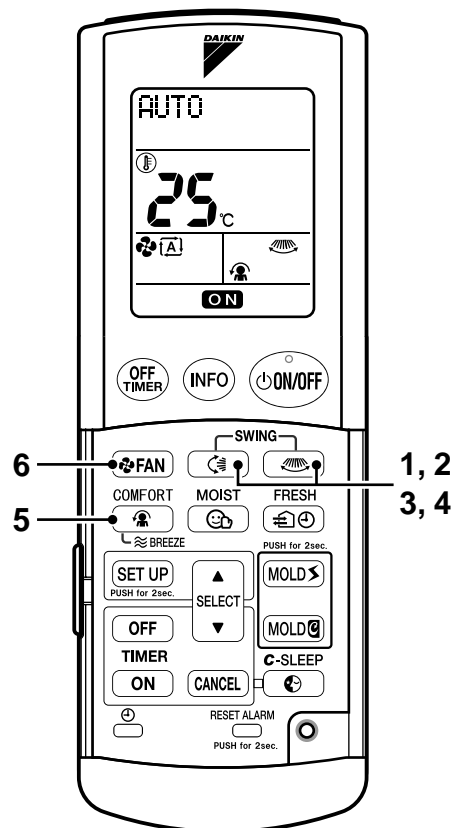

■ To change the airflow rate







6. Press “” during operation. (Refer to right table.)

- COOLING or HEATING with “” or other weak airflow rate may not cool or heat the room sufficiently.
- Indoor unit quiet operation

When the air flow is set to “”, the noise from the indoor unit will become quieter.



Operating mode	Airflow rate setting		
“SARARA” DRYING		●	●
DRY COOLING		●	●
MOISTURIZING		●	●
AUTO / COOLING		●	●
HEATING		●	●
HUMID HEATING		●	●
“URURU” HUMIDIFYING	   	●	●
FLASH STREAMER AIR PURIFYING / FRESH AIR SUPPLY VENTILATION			●

 : COMFORT AIRFLOW MODE operation is possible.
 : COOLING BREEZE operation is possible.
 Five levels of air flow rate setting from “” to “” plus “” “” are available.

NOTE

- If the unit is operated with the horizontal louvers pointed down and stopped in COOLING, “SARARA” DRYING, or DRY COOLING operation, the louvers will move automatically after about one hour. (This is to prevent condensation from forming on them.)

■ ATTENTION

- Be sure to use the remote controller to adjust the airflow direction. Manual operation of the louvers may cause it to work improperly.

■ Note on COMFORT AIRFLOW MODE operation

- The airflow direction is as fig. 1;

■ Note on COOLING BREEZE operation

- The vertical movement of the horizontal louvers with “1/ f breeze” rhythm provides comfort air like natural breeze. The room temperature is felt cooler with cooling breeze.

■ Note on Adjusting the vertical airflow direction

- The movable area for the horizontal louver is different depending on the operation mode.

■ Note on 3-D AIRFLOW

- Using 3-D AIRFLOW circulates cold air, which tends to be collected at the bottom of the room, and hot air, which tends to be collected near the ceiling, throughout the room, preventing areas of cold and hot from developing.

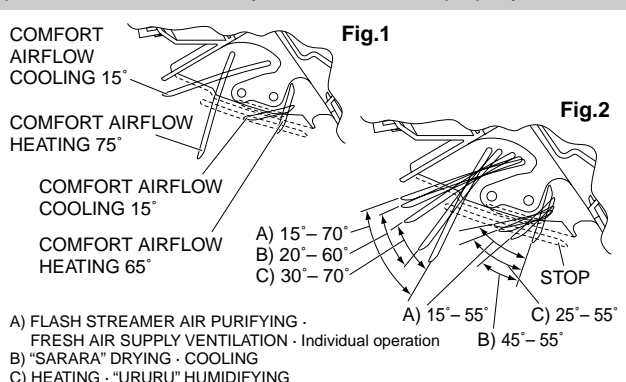

FLASH STREAMER AIR PURIFYING · FRESH AIR SUPPLY VENTILATION Operation

The absorption power of the Titanium apatite photocatalytic air-purifying filter and air supply filter and the resolving power of the streamer discharge reduce bad odors and viruses, cleaning the room air.

1. Press “”.

(Can be used together with heating or cooling, or on its own.)

- Changes every time the button is pressed. (Use instead of FAN operation.)

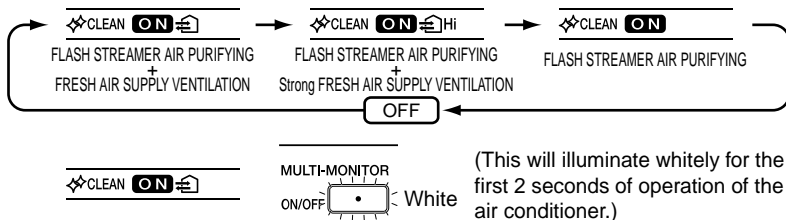

■ To change the airflow direction and airflow rate (page 10.)

ATTENTION

- Temperature and humidity cannot be changed during FLASH STREAMER AIR PURIFYING or FRESH AIR SUPPLY VENTILATION operation only.

NOTE

■ Note on FLASH STREAMER AIR PURIFYING operation

- The streamer discharge energy and Titanium apatite photocatalytic air-purifying filter clean the air in the room.

■ Note on FRESH AIR SUPPLY VENTILATION operation

- Fresh air is taken from outdoor through the outdoor unit.
- The outdoor noise and odor may be captured because the outdoor air is taken into the room. The operation noise is slightly louder.
- The operation noise may change depending on the outdoor temperature and humidity.

■ What is streamer discharge?

- It generates high-speed electron with high oxidizing power in the unit to resolve odor and harmful gas.
(It is safe because the high-speed electron is generated and goes away inside the unit.)
- * The streamer discharge fizzes, but this is not a malfunction.

HOME LEAVE VENTILATION

Ventilates the room during your absence to maintain it comfortable.

1. Press “”.



- Stops automatically after 4 hours.
- The default setting is 4 hours.

■ To change the time to stop

2. Press “”.

- It can be set to between 1 and 9 hours, in 1-hour increments.
- To use both HOME LEAVE VENTILATION and ON TIMER, set the ON TIMER first. (page 12.)

■ To change the airflow direction (page 10.)

- Temperature, humidity and airflow rate cannot be changed.

■ To cancel the HOME LEAVE VENTILATION

3. Press “”.

NOTE

■ Note on HOME LEAVE VENTILATION

- The FRESH AIR SUPPLY VENTILATION operation and COUNTDOWN OFF TIMER can be set with one button at the same time.

<FLASH STREAMER AIR PURIFYING / FRESH AIR SUPPLY VENTILATION>

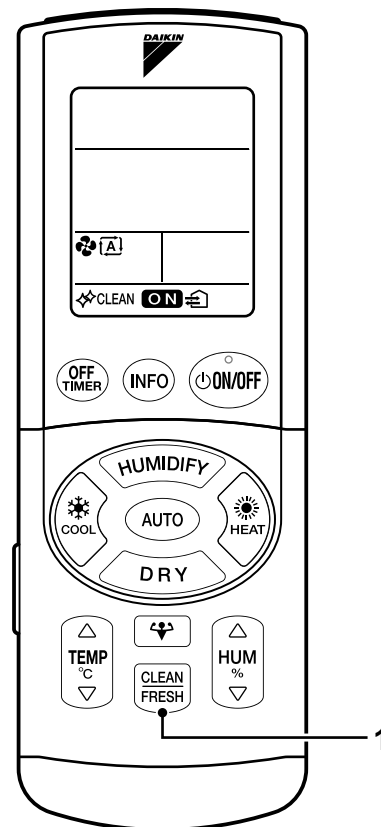

<HOME LEAVE VENTILATION>

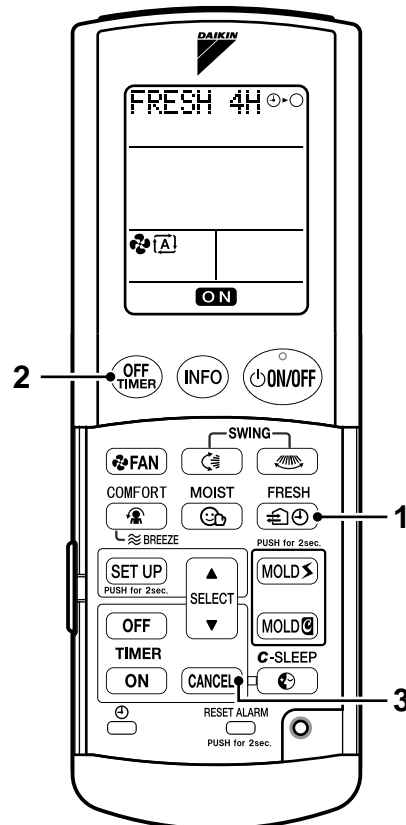

TIMER Operation

Timer functions are useful for automatically switching the air conditioner on or off at night or in the morning. The timer operates only one time. Set the timer for each use.

■ COUNTDOWN OFF TIMER operation

Set the time to stop.

1. Press “OFF TIMER”.

- The displayed time, which changes in 0.5 hour increments every time the button is pressed, is set. The time from 0.5 to 9.5 hours can be set.

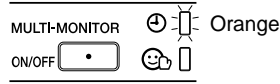

■ ON/OFF TIMER operation

Set time for ON TIMER or OFF TIMER.

- Check that the clock is correct. If not, set the clock to the present time. (page 6.)
- The present time display disappears when the time ON/OFF TIMER is reserved.

2. Press “OFF” for OFF TIMER and press “ON” for ON TIMER.

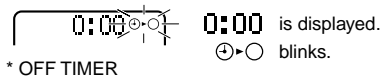

* OFF TIMER

3. Press “SELECT” to set the time to be reserved.

- Pressing the button changes the time in 10 minutes. Holding the button makes the time change faster.

4. Press “OFF” for OFF TIMER and press “ON” for ON TIMER.

The displayed time is set.

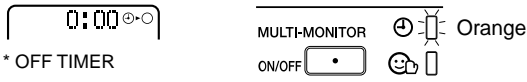

* OFF TIMER

■ To cancel the TIMER operation

5. Press “CANCEL”.

- The TIMER lamp will go off and the TIMER will be canceled.

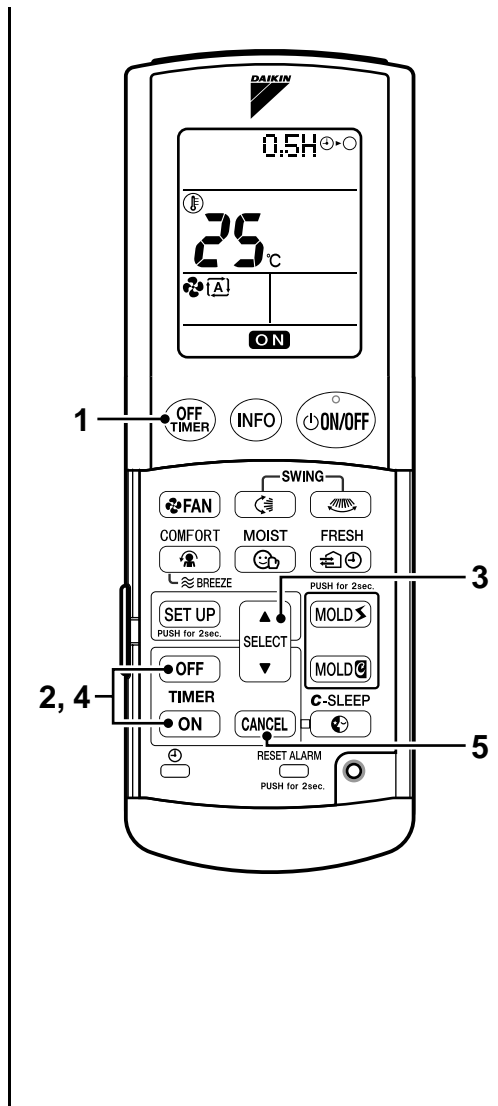

NOTE

■ In the following cases, set the timer again.

- After a breaker has turned OFF.
- After a power failure.
- After replacing batteries in the remote controller.

■ Note on TIMER operation

- Starting COUNTDOWN OFF TIMER and OFF TIMER causes the unit to automatically change the set temperature 1 hour later to prevent the room from becoming too cold or too hot. (Turns up 0.5°C during COOLING or DRY COOLING and turns down 2°C during HEATING or HUMID HEATING.)
- Reserving the ON TIMER will cause the unit to start running up to 1 hour before, in order to make sure the temperature reaches the temperature set on the remote controller by the set time.
- When operating the unit via the COUNTDOWN OFF TIMER or OFF TIMER, the actual length of operation may vary from the time entered by the user.
- Once you set ON/OFF TIMER, the time setting is kept in the memory. However, the COUNTDOWN OFF TIMER does not have this memory function. (The memory is canceled when remote controller batteries are replaced.)
- Cannot operate with COMFORT SLEEP operation.

■ To combine ON TIMER and OFF TIMER

- See the right example for reserving in combination of COUNTDOWN OFF TIMER and ON TIMER as well as OFF TIMER and ON TIMER.

■ To cancel combined reservation

- Press “ON” and then “CANCEL” to cancel the ON TIMER only.
- Press “OFF” and then “CANCEL” to cancel the OFF TIMER only.
- Press “OFF TIMER” several times to reach 9.5 hours and then press it one more time to cancel the COUNTDOWN OFF TIMER only.

(Example)

Present time: 11:00 pm (air conditioner is running).
You want to have the unit run for 1 more hour and then turn back on at 7:00 am.

Setting the COUNTDOWN OFF TIMER to ☉•○ 1 hour later
Setting the ON TIMER to ☉• | at 7:00 am

Setting the OFF TIMER to ☉•○ at 0:00 am
Setting the ON TIMER to ☉• | at 7:00 am

COMFORT SLEEP Operation

Controlling the room temperature supports comfort sleep and pleasant wake-up.

- Check that the clock is correct. If not, set the clock to the present time. (page 6.)
- The present time display disappears when the COMFORT SLEEP operation is set.

1. Press “” during operation.

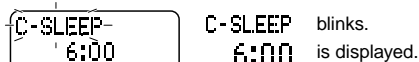

2. Press “” to set the time to wake up.

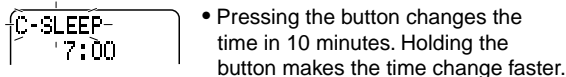

3. Press “”.

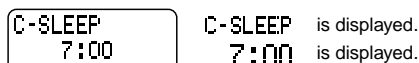

- When settings are made while the unit is not running, press “” to start the operation.

■ To cancel the comfort sleep operation

4. Press “”.

ATTENTION

- Make the room temperature comfortable to some extent before sleep.

<Recommended set temperature> COOLING 26°C – 29°C
HEATING 20°C – 25°C

- * Too low set temperature may cause you to get chilled while asleep.

NOTE

■ Note on COMFORT SLEEP operation

- Can be used for COOLING, DRY COOLING, MOISTURE COOLING, HEATING, HUMID HEATING and MOISTURE HEATING.
- Cannot be used with TIMER operation.

■ How to use COMFORT SLEEP operation effectively

- Starting COMFORT SLEEP operation lowers the set temperature by 2°C in 3 hours and starts raising it by 1°C 1 hour before the set time, offering V-curve temperature control. (See the right figure.)
- Set the airflow direction so that the air from the unit does not directly blow on the occupants of the room.

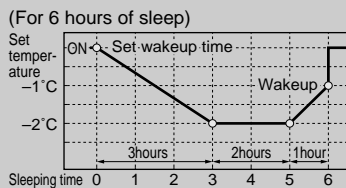

POWERFUL Operation

POWERFUL operation quickly maximizes the cooling (heating) effect in any operation mode.

1. Press “” during operation.

- POWERFUL operation ends in 20 minutes.



■ To change the airflow direction (page 10.)

- Temperature, humidity and airflow rate cannot be changed.



■ To cancel POWERFUL operation

2. Press “” again.

- The operation mode goes back to the previous one. The multi-colored indicator on the unit also goes back to the previous color.

NOTE

■ Note on POWERFUL operation

- Can be used for COOLING, DRY COOLING, HEATING, HUMID HEATING and MOISTURE HEATING. (Cannot be used while the unit is not running.)
- Pressing “” during COOLING, DRY COOLING or MOISTURE COOLING changes the operation mode to POWERFUL COOLING.
- Pressing “” during HEATING, HUMID HEATING or MOISTURE HEATING changes the operation mode to POWERFUL HEATING.
- The operation noise is slightly louder during POWERFUL operation.

<COMFORT SLEEP>

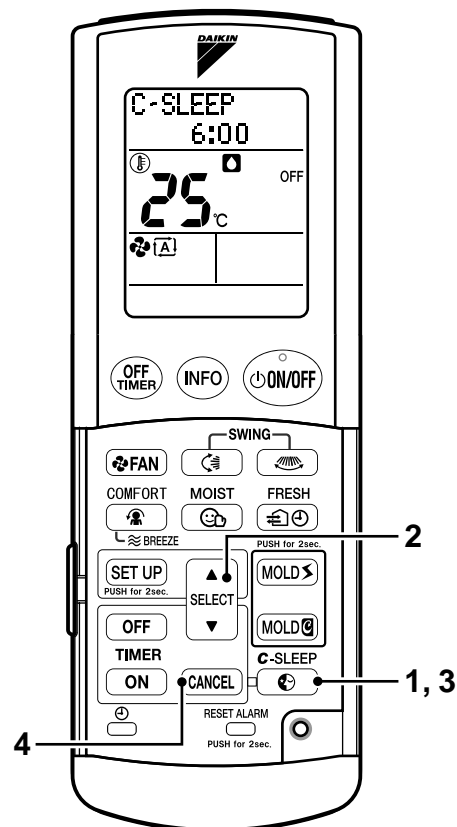

<POWERFUL>

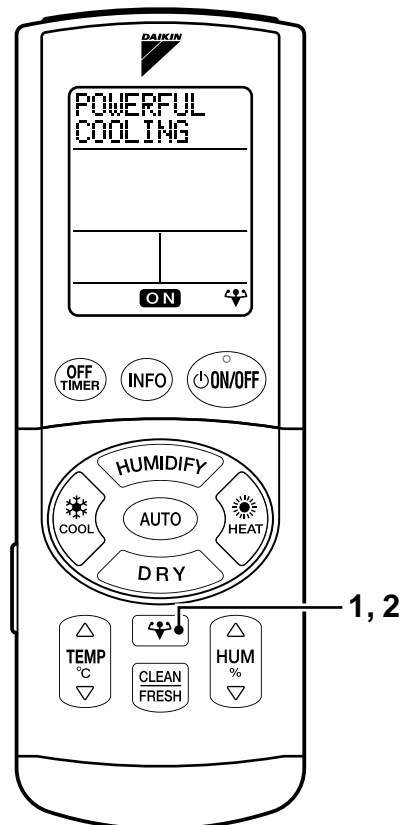

SET UP

Sets the unit operation and remote controller display according to your preference.

1. Hold “**SET UP**” for about 2 seconds.

- The setup mode will be activated.

2. The item will change every time “**SET UP**” is pressed.

3. The settings will change every time “**SELECT**” is pressed respectively.

- Direct the remote controller toward the main unit to make settings.

□ is default.

Item	Setting	Description
CHILD PROOF LOCK ON/OFF	OFF ◀▶ ON	• Restricts the remote controller operations to avoid misuse by children. (See NOTE.)
MOLD PROOF ON/OFF	OFF ◀▶ ON	• If the unit is set to “MOLD PROOF ON”, it may automatically enter MOLD PROOF operation mode after operating in DRYING, DRY COOLING or COOLING operation mode, depending on the amount of time it had been operating. This is to dry out the interior of the air conditioner. (page 15.)
MONITOR BRIGHTNESS	HIGH ◀▶ LOW ▶▶ OFF	• Changes the brightness of the indoor unit display.
BEEP volume	LOW ◀▶ HIGH ▶▶ OFF	• Sets the receiving tone volume.
CONTRAST Setting	1 ◀▶ 6 ▶▶ 16	• Sets the grayscale for the remote controller LCD. • Selectable from contrast 1 to 16.

Setting complete : The display on the remote control goes back to normal if no setting is made for 10 seconds.

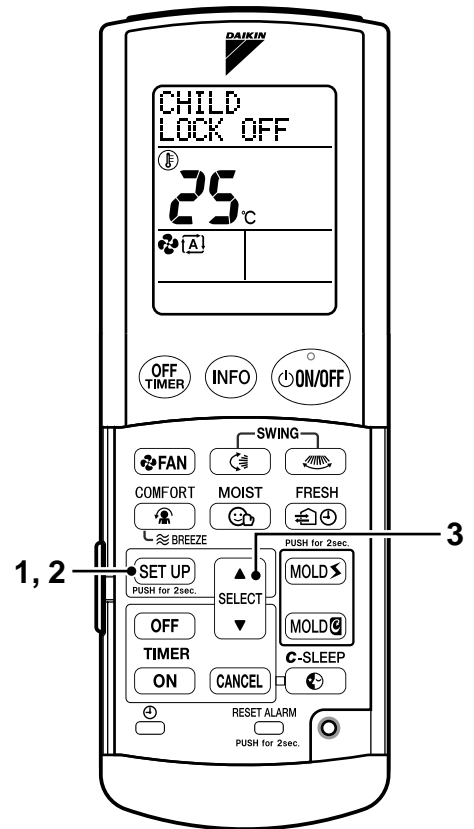

NOTE

■ Note on CHILD PROOF LOCK

- Selecting “ON” while CHILD PROOF LOCK setting and then pressing “**SET UP**” or making no setting for 10 seconds will cause the CHILD PROOF LOCK to be enabled and the display to show “**CHILD LOCK**”.
 
- The button operations other than “**SET UP**” are disabled in CHILD PROOF LOCK mode.
- To cancel the CHILD PROOF LOCK, set to “OFF” following the above steps from 1 to 3.

MOLD PROOF Operation

Dries the inside of the unit to prevent mold and odors.

■ Auto operation

(approximately once every 2 weeks)

If the unit is set to "MOLD PROOF ON", the MOLD PROOF operation will start automatically after the unit has been run in "SARARA" DRYING or COOLING mode, depending on the amount of time the unit has been run (approximately once every 2 weeks). (page 14.) The default is set to "MOLD PROOF OFF".

■ Manual operation

1. Hold "MOLD" for about 2 seconds while the unit is not running.



The MOLD PROOF operation will start.
The display will return to normal.

- The front panel and horizontal louver will open.
- The MOLD PROOF operation runs for about 3 hours, changing the color of the multi-colored indicator lamp of the unit.

<Color of multi-colored indicator lamp>

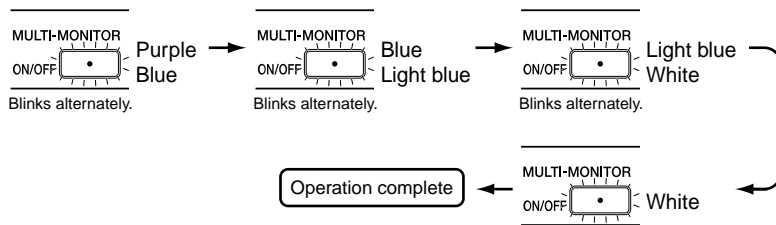

■ If you want to stop MOLD PROOF operation during operation

2. Hold "MOLD" (again) for about 2 seconds.

- The front panel and horizontal louver will close.
- The multi-colored indicator of the unit will go off.

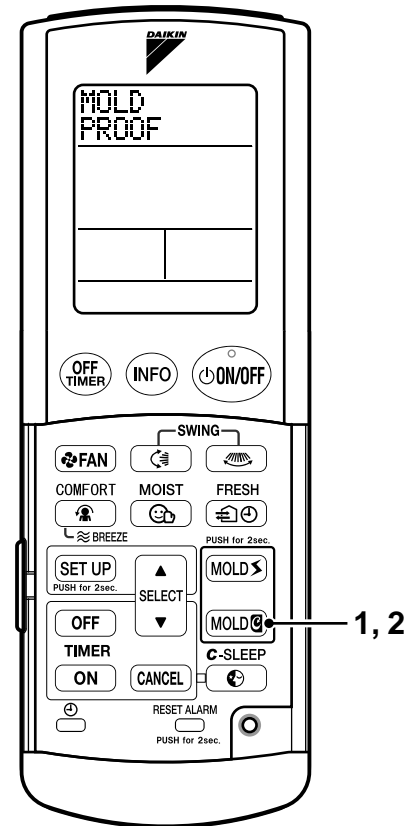

(In case of manual operation)

NOTE

■ Note on MOLD PROOF operation

- Dries out the interior of the air conditioner using FAN and HEATING operation mode to exhaust humidity to the outdoor. This prevents mold and odor growth. This function is not designed to remove existing dust or mold.
- During MOLD PROOF operation, the room temperature may rise and humidity from the machine may be sent into the room. Some odors may be noticed, too.
- The mode may not be used if the outside temperature or humidity is very high.
- The exhausting operation may not be run depending on the outdoor temperature.
- MOLD PROOF operation mode is not available if the unit is shut off using the COUNTDOWN OFF TIMER. MOLD PROOF operation mode only comes on automatically if the unit has been stopped using the operation/stop switch on the remote controller or the main unit.
- If MOLD PROOF operation is stopped during AUTO mode, the operation comes on automatically next time, depending on the amount of time the unit had been operating. To cancel the AUTO mode, set to "MOLD PROOF OFF". (page 14.)

MOLD SHOCK OUT Operation

This mode dehumidifies the air in the room and prevents mold growth. Continuous drying operation lowers the room humidity rapidly.

1. Hold “**MOLD**” for about 2 seconds while the unit is not running.



The MOLD SHOCK OUT operation will start. The display will return to normal.

- The front panel and horizontal louver will open.
- The MOLD SHOCK OUT operation runs for about 3 hours, changing the color of the multi-colored indicator lamp on the unit.

<Color of multi-colored indicator lamp>

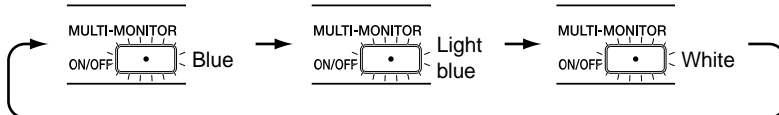

- Blinks in order during the MOLD SHOCK OUT operation.

■ If you want to stop MOLD SHOCK OUT operation during operation

2. Hold “**MOLD**” (again) for about 2 seconds.

- The front panel and horizontal louver will close.
- The multi-colored indicator of the unit will go off.

NOTE

■ Note on MOLD SHOCK OUT operation

- The mode may not be used depending on the outdoor temperature.
<Operating range> Outdoor temperature of from 12 to 40°C
- Temperature and humidity may not satisfy your preference during MOLD SHOCK OUT operation. Run this operation mode while no one is in the room. It is generally said that mold growth can be reduced when the humidity is below 60%.

<MOLD SHOCK OUT>

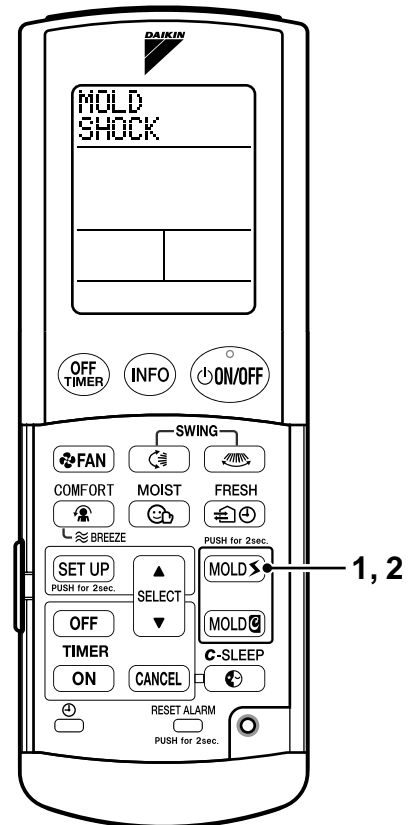

INFORMATION DISPLAY

Displays the room temperature and humidity and outdoor temperature.

1. Press “**INFO**”.

- After pressing “**INFO**”, point the remote controller at the air conditioner unit for 2 seconds.

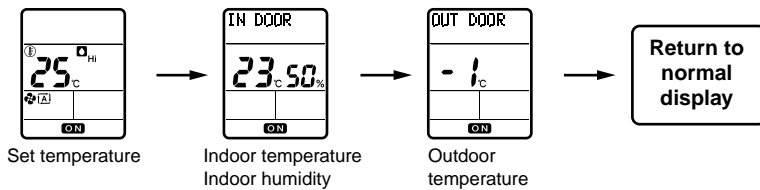

<INFORMATION DISPLAY>

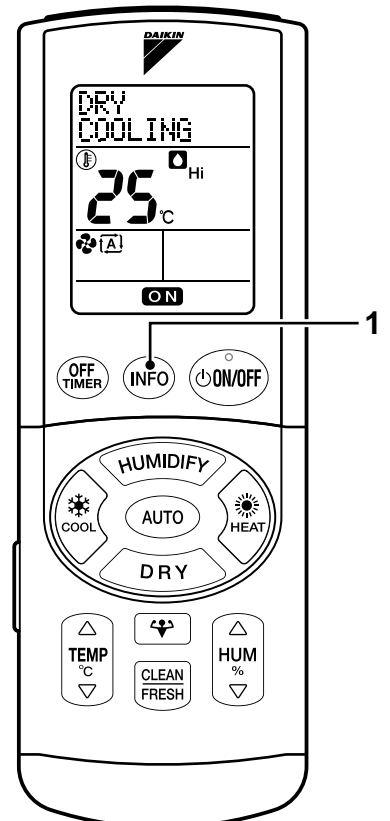

■ The display changes every time “**INFO**” is pressed.

NOTE

■ Note on INFORMATION DISPLAY

- The signal from the air conditioner is not being received properly if “Reception Failed” is displayed when you press “**INFO**”. Repeat, aiming the remote controller at the air conditioner.
- During operation, the outdoor temperature may sometimes be displayed higher than it actually is in COOLING or “SARARA” DRYING mode or lower in HEATING mode (especially if frost has accumulated on the outdoor unit), due to the effects of the air blown from the outdoor unit or the temperature of the heat exchanger.
- The lowest indoor and outdoor temperature which can be displayed is -9°C. This will be displayed even if the actual temperature is lower. The highest temperature is 39°C. This will be displayed even if the actual temperature is higher.
- The indoor and outdoor temperatures and the humidity which are displayed are those near the sensors attached to the main air conditioner unit.
- The displayed temperature and humidity should only be taken as approximations, as they may be affected if there are objects around the sensors or due to direct sunlight, depending on where the air conditioner is installed.

Care and Cleaning

Quick reference for cleaning



CAUTION

- Before cleaning, be sure to stop the operation and turn the breaker OFF.
- Do not touch the metal parts in the indoor unit. Doing so may cause injury.

1. Front panel

Wipe off if it gets dirty.
(Cleaning : page 18.)

2. Air filter

Vacuum/Rinse if “CLEAN FILTER” displays.
(Cleaning : page 19.)

3. Air supply filter (Yellow)

Cannot be washed with water.

Vacuum once in about 3 months.

- **Replace** once in about 1 year.

(Cleaning : page 23.)

4. Titanium apatite photocatalytic air-purifying filter (Black)

Soak if “CLEAN STREAMER” displays.

- **Replace** once in about 3 years.

(Cleaning : page 21.)

5. Deodorizing filter for streamer (Black)

Soak if “CLEAN FILTER” display.

- **Replace** once in about 3 years.

(Cleaning : page 21.)

6. Upper panel

Wipe off if it gets dirty.
(Cleaning : page 18.)

7. Streamer unit

Soak if “CLEAN STREAMER” displays.

- **Replace** once in about 3 years.

(Cleaning : page 21.)

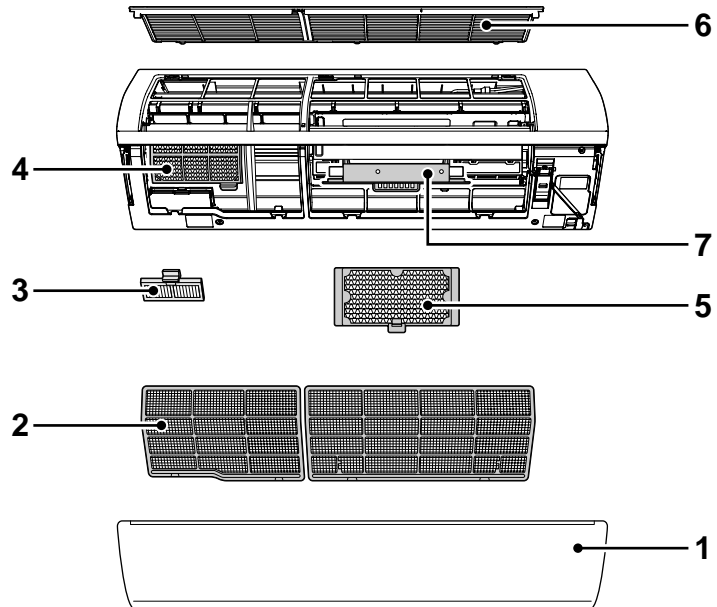

To reset the filter cleaning indicator

While the unit is not operating, the filter cleaning indicator may be displayed on the remote controller depending the amount of time the unit had been operating. This sign indicates the cleaning timing for the air filter, Titanium apatite photocatalytic air-purifying filter, deodorizing filter for streamer or streamer unit.



1. After cleaning, press “” for about 2 seconds directing the remote controller toward the main unit with powered on.

- Indication disappears.



NOTE

- “CLEAN FILTER” sign will appear after about 340 hours of operation.
- “CLEAN STREAMER” sign will appear after about 1800 hours of operation.
- Operating the unit without cleaning with the “CLEAN STREAMER” sign displayed will lower the deodorizing capability.
- Periodical cleaning leads to energy saving.

Attaching and removing the front panel



CAUTION

- Only open the front panel after turning the unit off.
Opening the panel during operation may cause the panel to fall off.

1. Open the front panel.

- Placing a finger on the panel tab on either side of the front panel.

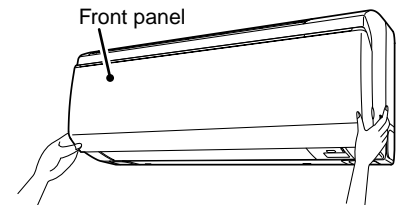

2. Remove the front panel.

- Spread out the shaft hole and remove the rotating shaft. (Both left and right sides.)

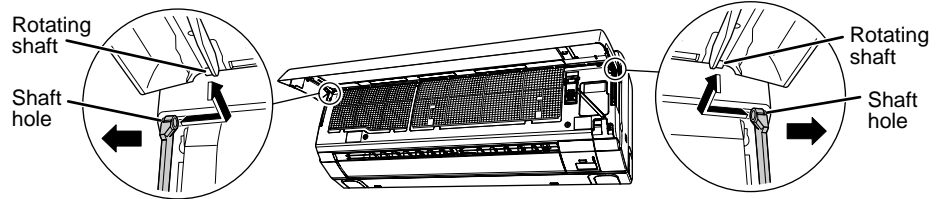

3. Attach the front panel.

- Place the revolving axes on either side of the front panel into the holes and slowly close.
(Press either side of the front panel.)

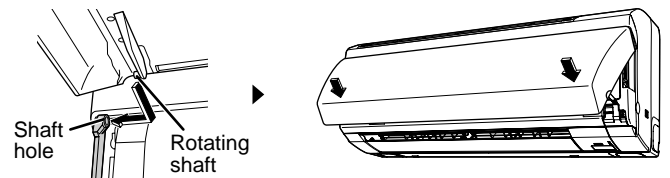

Attaching and removing the upper panel

1. Remove the front panel and pull out the air filter. (page 19.)

2. Remove the upper panel.

- 1) Hold the 2 tabs on either side of the upper panel and pull forward to remove.
- 2) Remove the tab in the center and lift.

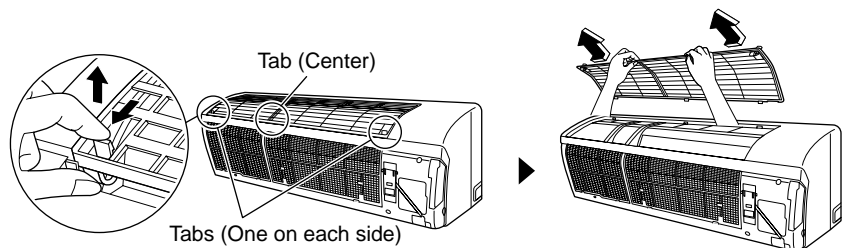

3. Attach the upper panel.

- Insert the 3 tabs on back of the upper panel and then push it down.
- Push the upper panel down until it clicks.

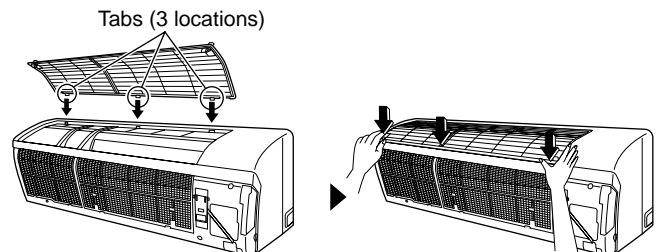

Cleaning for each case

- Wipe it with a soft cloth soaked in water. (Only neutral detergent may be used.)
- In case of washing the front panel with water, dry it with cloth, dry it up in the shade after washing.



CAUTION

- When removing or attaching the front panel, use a robust and stable stool and watch your steps carefully.
- When removing or attaching the front panel, support the front panel securely with hand to prevent it from falling.
- For cleaning, do not use hot water above 40°C, benzene, gasoline, thinner, nor other volatile oils, polishing compound, scrubbing brushes, nor other hand stuff.
- After cleaning, make sure that the front panel is securely fixed.
- Wipe the front panel with a soft cloth. Wiping with a hard cloth may scratch it.

Care and Cleaning

Cleaning the air filter

(If “**CLEAN FILTER**” is displayed on the remote controller)

1. Open the front panel.

- Open the front panel by placing a finger on the panel tab on either side of the front panel and then secure it using the supporting plate on the right.

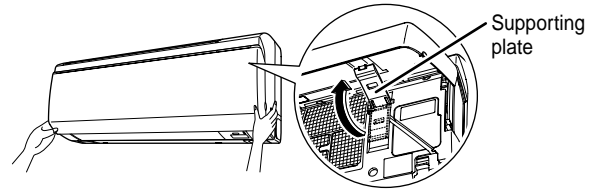

2. Pull out the air filters.

- Push a little upwards the air filter.

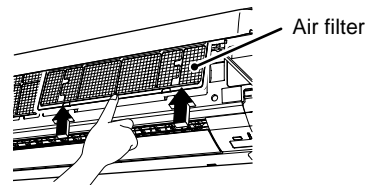

- Pull the air filter down.

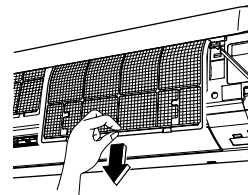

3. Clean the air filter.

- Wash the air filters with water or clean them with vacuum cleaner.
- If the dust does not come off easily, wash them with neutral detergent thinned with lukewarm water, then dry them up in the shade.

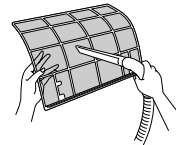

4. Set the air filter as it was and close the front panel.

- Insert the air filter with the “FRONT” marking to the front.
- Be sure to insert the two tabs below.
- Return the supporting plate to its previous position.
- Press either side of the front panel.

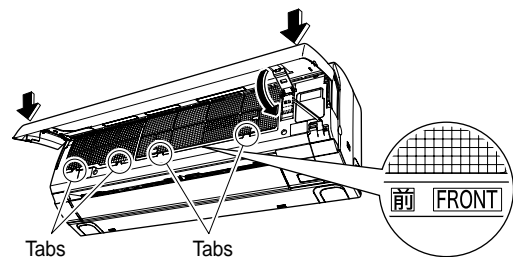

5. Reset the filter cleaning indicator. (page 17.)

ATTENTION

- Using without cleaning will lower the COOLING or HEATING capability, wasting electricity.

Attaching and removing the deodorizing filter for streamer, Titanium apatite photocatalytic air-purifying filter, streamer unit

1. Open the front panel and pull out the air filter. (page 19.)

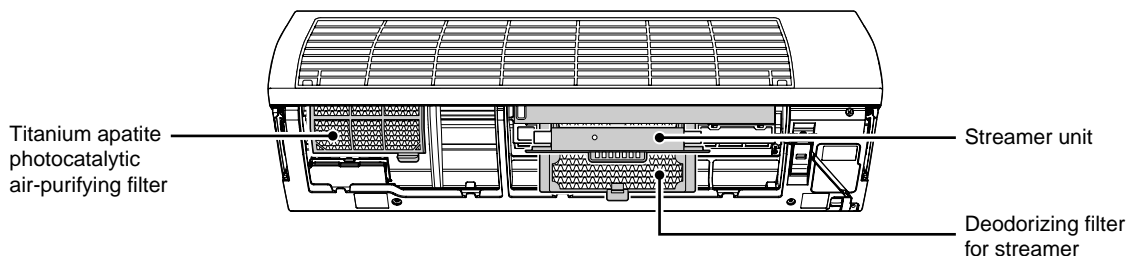

Removing

2. Remove the deodorizing filter for streamer.

- Discharge the tab and pull out the knob in a downward direction.

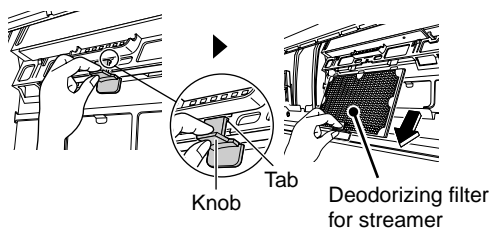

3. Pull out the streamer unit.

- Hold the center of the handle and pull out in a downward direction.

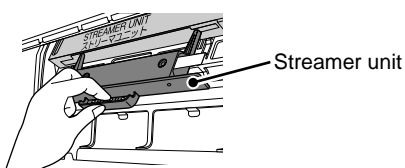

4. Remove the Titanium apatite photocatalytic air-purifying filter.

- Pull up the filter frame, discharge the tabs on both sides of the Titanium apatite photocatalytic air-purifying filter from the hooks, and pull down the filter in a downward direction.

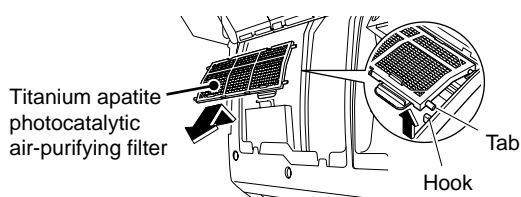

Attaching

5. Replace the streamer unit to its original position.

- Attach the streamer unit in opposite procedure to removing 3.

6. Attach the deodorizing filter for streamer.

- Insert the deodorizing filter for streamer until it clicks.

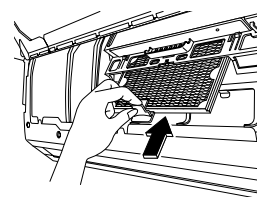

7. Attach the Titanium apatite photocatalytic air-purifying filter.

- Insert the 2 upper tabs on the Titanium apatite photocatalytic air-purifying filter into the guides on the main unit and then hook up the 2 lower tabs.

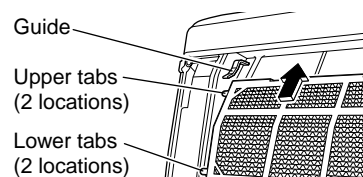

8. Replace the air filter to its original position and close the front panel.

Care and Cleaning

Cleaning the deodorizing filter for streamer, Titanium apatite photocatalytic air-purifying filter and streamer unit

(If "CLEAN STREAMER" is displayed on the remote controller)

■ Attaching and removing each part (page 20.)

Deodorizing filter for streamer / Titanium apatite photocatalytic air-purifying filter

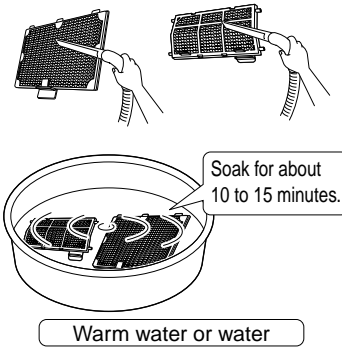
<p>Vacuum dusts, and soak in warm water or water for about 10 to 15 minutes if dirt is heavy.</p>		<ul style="list-style-type: none"> • Do not use cleaning agents. This may lower deodorizing capability. • Do not scrub the filter while cleaning. • Do not take the filter out of the frame while soaking. • After soaking, drain water away and dry well in a shade. • Do not squeeze the filter to drain away water.
---	---	---

Streamer unit

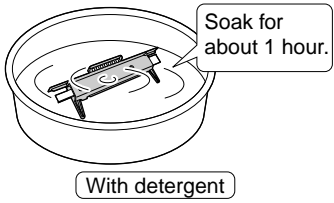
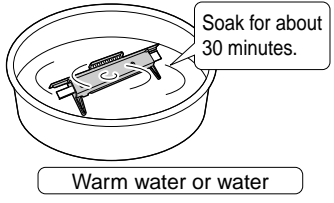
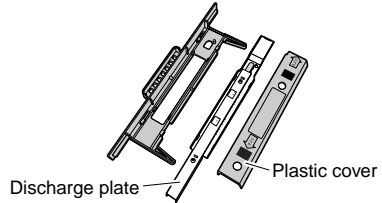
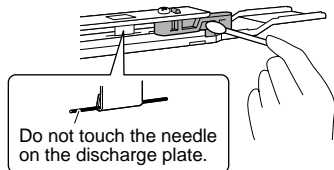
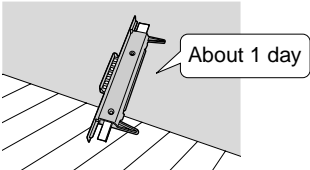
<p>1) Soak in warm water with mild liquid detergent for about 1 hour.</p>		<ul style="list-style-type: none"> • Observe the volume of mild liquid detergent specified in the instruction. • Do not use powder or alkaline detergent. • If very dirty, disassemble the streamer unit and clean with cotton swabs, etc. (Disassembly instructions: page 22.) <p>Disassembly</p>
<p>2) Rinse with running water and soak in warm water or water again.</p>		 <p>Discharge plate</p>
<p>3) Rinse with running water.</p>		
<p>4) Drain water away and dry in a breezy shade.</p>		<p>Do not touch the needle on the discharge plate (2 locations). Bending the needle will affect the unit's ability to deodorize.</p>

■ Resetting the filter cleaning indicator (page 17.)

ATTENTION

- Using without cleaning lowers the deodorizing capability.

How to replace

■ Deodorizing filter for streamer

(Once in about 3 years)

- Remove from the filter frame and replace the filter with a new one.

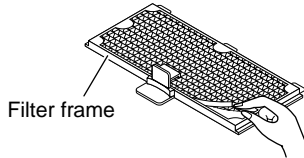

- The deodorizing filter for streamer and the titanium apatite photocatalytic air-purifying filter do not have front and back sides.
- Dispose a used filter as burnable waste. (material: paper)

■ Titanium apatite photocatalytic air-purifying filter

(Once in about 3 years)

- Discharge the 4 tabs of the filter frame and replace the filter with a new one.

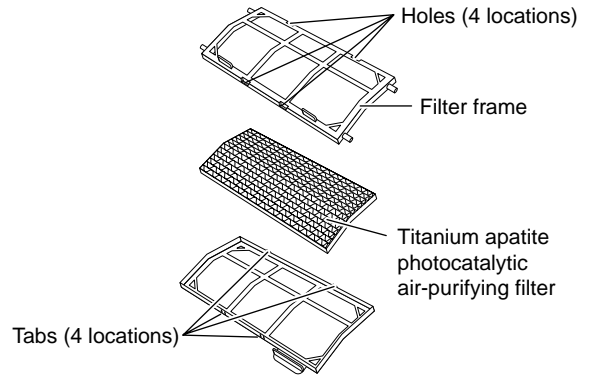

How to disassemble and assemble the streamer unit

- Before disposing the streamer unit, disassemble it.

How to disassemble

- Use gloves for safety.
- Apply one hand to the striped part and push the plastic part with another hand.
- Disassemble the streamer unit into the plastic cover and the discharge plate.
- Match up the securing parts of the various parts of the streamer unit and assemble as it was.

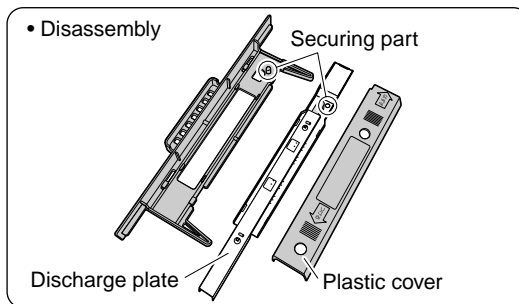
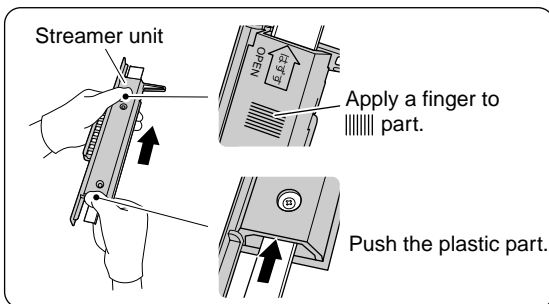

⚠ CAUTION

- Be careful not to cut yourself when disassembling and assembling the streamer unit.

Care and Cleaning

Attaching, cleaning and replacing the air supply filter

(Clean once in about 3 months and replace once in about 1 year.)

Cannot be washed with water.

1. Open the front panel to pull out the air filter and Titanium apatite photocatalytic air-purifying filter. (page 19, 20.)
2. Pull out the air supply filter.

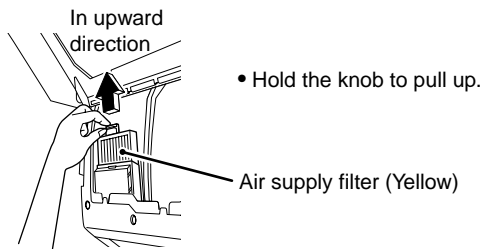

3. Cleaning

- Remove dust with a vacuum cleaner.
- The component of the filter is weak in water. Do not rinse the filter.

Replacing

Discharge the 4 tabs of the filter frame and replace the filter with a new one.

- Dispose a used filter as unburnable waste. (material: polyester)

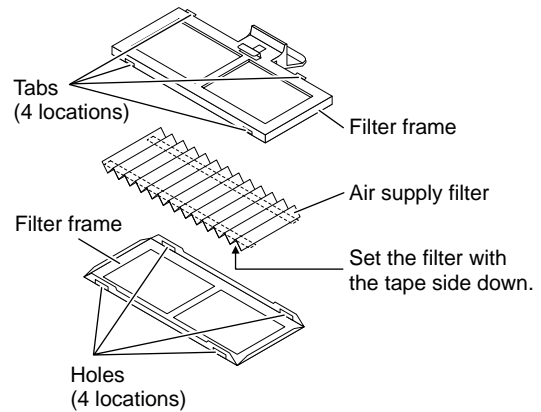

4. Replace the air supply filter to its original position.
5. Set the Titanium apatite photocatalytic air-purifying filter and the air filter as they were and close the front panel. (page 19, 20.)

⚠ CAUTION

- Do not forget to replace the filter to its original position after cleaning it. Operating the unit in HUMIDIFYING mode without attaching the filter may cause condensation to form inside the panel or others, causing water to leak.

Cleaning the indoor unit and the remote controller

- Wipe with a soft dry cloth.
- For cleaning, do not use hot water above 40°C, benzene, gasoline, thinner, nor other volatile oils, polishing compound, scrubbing brushes, nor other hand stuff.

NOTE

- The deodorizing filter for stream and the titanium apatite photocatalytic air-purifying filter should be cleaned regularly.

We recommend replacing the filter in the following situations.

- If it is damaged during cleaning because it is made of paper.
- If it is very dirty after long use.

Item	Part No.
Air purifying filter set	KAF974B42S
Air supply filter (with frame)	KAF963A43

- To order Titanium apatite photocatalytic air-purifying filter, deodorizing filter for streamer, air supply filter and streamer unit contact to the service shop there you bought the air conditioner.

- Using the dirty parts will:

- Prevent proper air purification.
- Prevent proper deodorizing.
- Reduce COOLING and HEATING capacity.
- Cause the unit to produce foul odors.

Check

- Check that the base, stand and other fittings of the outdoor unit are not decayed or corroded.
- Check that nothing blocks the air inlets and the outlets of the indoor unit and the outdoor unit.
- Check that the drain comes smoothly out of the drain hose during COOLING or DRY operation.
 - If no drain water is seen, water may be leaking from the indoor unit.
Stop operation and consult the service shop if this is the case.
- Is the earth wire out or disconnected in the middle?
 - An incomplete ground wire may cause electrical shock. Contact the service shop.

Before a long idle period

1. Operate the "MOLD PROOF" for several hours on a fine day to dry out the inside.

MOLD PROOF operation

Hold "MOLD" for about 2 seconds while the unit is not running.



The operation will stop in about 3 hours.

2. After operation stops, turn off the breaker for the room air conditioner.
3. Clean the air filters and set them again.
4. Take out batteries from the remote controller.

Trouble Shooting

■ These cases are not troubles.

The following cases are not air conditioner troubles but have some reasons. You may just continue using it.

Case	Explanation
Operation does not start soon. <ul style="list-style-type: none"> When ON/OFF button was pressed soon after operation was stopped. When the mode was reselected. 	<ul style="list-style-type: none"> This is to protect the air conditioner. You should wait for about 3 minutes.
Hot air does not flow out soon after the start of heating operation.	<ul style="list-style-type: none"> The air conditioner is warming up. You should wait for 1 to 4 minutes.
Makes a noise.	<ul style="list-style-type: none"> ■ Clicking sound can be heard either when the unit is running or stopped <ul style="list-style-type: none"> This is either the sound of the valves regulating the refrigerant or the electrical parts working. ■ Sound of running water <ul style="list-style-type: none"> Refrigerant is flowing through the air conditioner. ■ Blowing sound <ul style="list-style-type: none"> The flow of refrigerant through the air conditioner is switching. ■ Creaking sound <ul style="list-style-type: none"> The air conditioner itself is expanding or shrinking due to a change in the humidity. ■ Clopping sound <ul style="list-style-type: none"> Can be heard coming from inside the air conditioner when the ventilator is on and the room is shut. Open a window or turn off the ventilator. ■ Clicking sound can be heard either when the unit is running or stopped <ul style="list-style-type: none"> This is the sound of the electrical parts working when the front panel opens or closes. ■ Blowing, cracky or burning sound <ul style="list-style-type: none"> This is the sound of streamer discharging.
Fizzes during HUMIDIFYING or VENTILATING operation.	<ul style="list-style-type: none"> This is the sound of humidified or ventilated air being discharged. The operation noise may change depending on the outdoor temperature and humidity.
Makes a sound during HUMIDIFYING operation.	<ul style="list-style-type: none"> ■ Operation noise changes <ul style="list-style-type: none"> This is because the fan for humidification moves or stops.
The indoor unit makes a noise even after HUMIDIFYING operation is stopped.	<ul style="list-style-type: none"> The fan for humidification rotates for about 3 minutes after the operation stops for product protection.
Units stops during HEATING and the sound of running water can be heard.	<ul style="list-style-type: none"> The frost on the outdoor unit is being removed. You should wait for about 3 to 10 minutes.
The outdoor unit emits water or steam.	<ul style="list-style-type: none"> ■ In HEATING operation <ul style="list-style-type: none"> The frost on the outdoor unit melts into water or steam when the air conditioner is in defrost operation. ■ In COOLING operation <ul style="list-style-type: none"> Moisture in the air condenses into water on the cool surface of outdoor unit piping and drips.
Mist comes out of the indoor unit.	<ul style="list-style-type: none"> This happens when the air in the room is cooled into mist by the cold air flow during COOLING operation. This is because moisture on the heat exchanger evaporates when "SARARA" DRYING operation is run after COOLING or DRY COOLING operation.
The indoor unit gives out odor.	<ul style="list-style-type: none"> This happens when smells of the room, furniture, or cigarettes are absorbed into the unit and discharged with the air flow. (If this happens, we recommend you to have the indoor unit washed by a technician. Consult the service shop where you bought the air conditioner.) The outdoor odor may be captured. Stop the "URURU" HUMIDIFYING operation to eliminate the cause of odor.
Cold air blows at the start of "SARARA" DRYING operation.	<ul style="list-style-type: none"> This is because the air conditioner is not warmed up.
The outdoor fan rotates while the air conditioner is not in operation.	<ul style="list-style-type: none"> ■ After operation is stopped: <ul style="list-style-type: none"> The outdoor fan continues rotating for another 60 seconds for system protection. ■ While the air conditioner is not in operation: <ul style="list-style-type: none"> When the outdoor temperature is very high, the outdoor fan starts rotating for system protection.
The operation stopped suddenly. (Multi-colored indicator lamp is on.)	<ul style="list-style-type: none"> For system protection, the air conditioner may stop operating on a sudden large voltage fluctuation. It automatically resumes operation in about 3 minutes.
Unit stops suddenly (when in ON TIMER mode).	<ul style="list-style-type: none"> Reserving the on timer will cause the unit to start running up 1 hour before, in order to make sure the temperature reaches the temperature set on the remote controller by the set time. Using the remote controller during this time (other than the operation/stop button) will stop the unit. Restart the unit with the remote controller.
Unit operates even though the multi-colored indicator lamp is off.	<ul style="list-style-type: none"> The multi-colored indicator lamp will go off if "Monitor OFF" is set using the remote controller.
Unit continues to operate even after "SARARA" DRYING, DRY COOLING or COOLING operation is stopped.	<ul style="list-style-type: none"> The MOLD PROOF operation will start. (If you don't want it, set to "MOLD PROOF OFF" using the remote controller. (page 15.))
Room lamp flickers during HUMIDIFYING operation.	<ul style="list-style-type: none"> It might happen the flickers of lighting in the case of insufficient power supply.

■ Check again.

Please check again before calling a repair person.

Case	Check
The air conditioner does not operate. (Multi-colored indicator lamp is off.)	<ul style="list-style-type: none"> • Hasn't a breaker turned OFF or a fuse blown? • Isn't it a power failure? • Are batteries set in the remote controller? • Is the timer setting correct?
The air conditioner does not operate. (Multi-colored indicator lamp flashes.)	<ul style="list-style-type: none"> • Turn off the breaker and then start the unit using the remote controller. • If the lamp still flashes, consult the service shop where you bought the air conditioner. Turn off the breaker.
Operation stops suddenly. (Multi-colored indicator lamp flashes.)	<ul style="list-style-type: none"> • Are the air filters clean? • Is there anything to block the air inlet or the outlet of the indoor and the outdoor units? Clean the air filters or take all obstacles away and turn the breaker OFF. Then turn it ON again and try operating the air conditioner with the remote controller. If the lamp still flashes, consult the service shop where you bought the air conditioner. Turn off the breaker.
Cooling (Heating) effect is poor.	<ul style="list-style-type: none"> • Are the air filters clean? • Is there anything to block the air inlet or the outlet of the indoor and the outdoor units? • Is the temperature setting appropriate? • Are the windows and doors closed? • Are the air flow rate and the air direction set appropriately? • Is the ventilator fan spinning?
An abnormal functioning happens during operation.	<ul style="list-style-type: none"> • Do you put your hand in the main unit while it is operating? (Do you touch inside the unit?) • Putting your hand (or touching) inside the unit may cause malfunctions due to static discharge. Do not put your hand in the main unit. • The air conditioner may malfunction with lightning or radio waves. Turn the breaker OFF, turn it ON again and try operating the air conditioner with the remote controller.
Front panel does not open. (Multi-colored indicator lamp flashes.)	<ul style="list-style-type: none"> • Is there something caught in the front panel? Remove the object and attempt operation again using the remote controller. If the panel still does not open, contact your dealer if the operation lamp is still flashing.
The multi-colored indicator lamp flashes for a certain amount of time (about 2 minutes) at the start of or during FLASH STREAMER AIR PURIFYING operation.	<ul style="list-style-type: none"> • Is the streamer unit installed securely? • Turn off the breaker, check to see if the streamer unit is installed securely, turn the power on, and then operate the unit again using the remote controller. • If the lamp still flashes, consult the service shop where you bought the air conditioner.

Trouble Shooting

■ Call the service shop immediately.

WARNING

- When an abnormality (such as a burning smell) occurs, stop operation and turn the breaker OFF. Continued operation in an abnormal condition may result in troubles, electric shocks or fire. Consult the service shop where you bought the air conditioner.
- Do not attempt to repair or modify the air conditioner by yourself. Incorrect work may result in electric shocks or fire. Consult the service shop where you bought the air conditioner.
- If the air conditioner does not cool (or heat), leaking refrigerant is a possible cause, so please contact your dealer. Please talk to a service repairman about any repairs needed when adding refrigerant. Refrigerant used for the air conditioner is safe. Refrigerant does not leak usually, but if it leaks into the room and comes in contact with any kind of flame, including those in fan heaters, gas stoves, gas heaters, etc., toxic gas may be generated.

If one of the following symptoms takes place, call the service shop immediately.

- The power cord is abnormally hot or damaged.
- An abnormal sound is heard during operation.
- An object or water got into the unit.
- The safety breaker, a fuse, or the earth leakage breaker cuts off the operation frequently.
- A switch or a button often fails to work properly.
- There is a burning smell.
- Water leaks from the indoor unit.

Turn the breaker OFF and call the service shop. 

- Cool or warm air comes from the unit but the multi-colored indicator lamp blinks for a certain amount of time (about 2 minutes) at the start of or during operation.

This indicates the malfunction or initial failure of the humidifying unit or some sensors. The unit is operating in COOLING / HEATING mode as a temporary operation. Contact your dealer. 

■ After a power failure

- The air conditioner automatically resumes operation in about 3 minutes. You should just wait for a while.
- MOLD SHOCK OUT mode, MOLD PROOF mode and COMFORT SLEEP mode will be canceled. Re-set.

■ Lightning

If lightning may strike the neighbouring area, stop operation and turn the breaker OFF for system protection.

Disposal requirements



Your air conditioning product is marked with this symbol. This means that electrical and electronic products shall not be mixed with unsorted household waste.

Do not try to dismantle the system yourself: the dismantling of the air conditioning system, treatment of the refrigerant, of oil and of other parts must be done by a qualified installer in accordance with relevant local and national legislation.

Air conditioners must be treated at a specialized treatment facility for re-use, recycling and recovery. By ensuring this product is disposed of correctly, you will help to prevent potential negative consequences for the environment and human health. Please contact the installer or local authority for more information.

Batteries must be removed from the remote controller and disposed of separately in accordance with relevant local and national legislation.

We recommend periodical maintenance.

In certain operating conditions, the inside of the air conditioner may get foul after several seasons of use, resulting in poor performance. It is recommended to have periodical maintenance by a specialist aside from regular cleaning by the user. For specialist maintenance, contact the service shop where you bought the air conditioner.

The maintenance cost must be born by the user.

■ FAULT DIAGNOSIS BY REMOTE CONTROLLER

In the ARC447A1, the temperature display sections on the main unit indicate corresponding codes.

1. When the CANCEL button is held down for 5 seconds, a “00” indication flashes on the temperature display section.

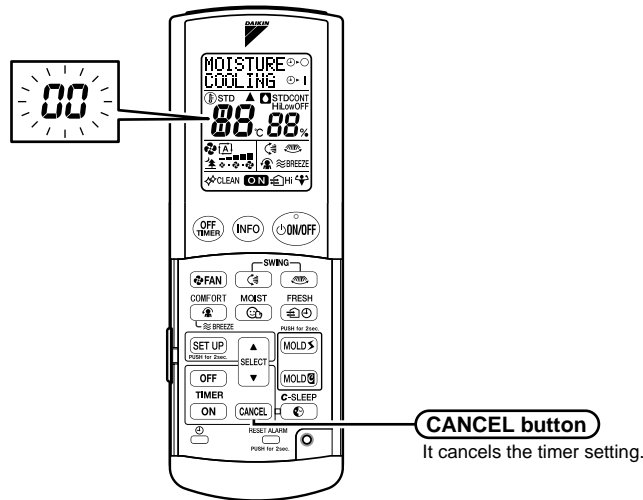

2. Press the CANCEL button repeatedly until a continuous beep is produced.

- The code indication changes as shown below, and notifies with a long beep.

	CODE	MEANING
SYSTEM	00	NORMAL
	UA	INDOOR-OUTDOOR UNIT COMBINATION FAULT
	U0	REFRIGERANT SHORTAGE
	U2	DROP VOLTAGE OR MAIN CIRCUIT OVERVOLTAGE
	U4	FAILURE OF TRANSMISSION (BETWEEN INDOOR UNIT AND OUTDOOR UNIT)
	U7	CIRCUIT BOARD TRANSMISSION FAULT
INDOOR UNIT	AH	STREAMER FAULT
	A1	INDOOR PCB DEFECTIVENESS
	A5	HIGH PRESSURE CONTROL OR FREEZE-UP PROTECTOR
	A6	FAN MOTOR FAULT
	CC	HUMIDITY SENSOR FAULT
	C4	FAULTY HEAT EXCHANGER TEMPERATURE SENSOR
	C7	FRONT PANEL OPEN/CLOSE FAULT
	C9	FAULTY SUCTION AIR TEMPERATURE SENSOR
	UA	HOSE LENGTH NOT SET
OUTDOOR UNIT	EA	COOLING-HEATING SWITCHING FAULT
	E1	CIRCUIT BOARD FAULT
	E5	OL STARTED
	E6	FAULTY COMPRESSOR START UP
	E7	DC FAN MOTOR FAULT
	E8	OVERCURRENT INPUT
	FA	EJECTION PRESSURE FAULT
	F3	HIGH TEMPERATURE DISCHARGE PIPE CONTROL
	F6	HIGH PRESSURE CONTROL (IN COOLING)
	H0	SENSOR FAULT
	H1	DAMPER FAULT
	H6	OPERATION HALT DUE TO FAULTY POSITION DETECTION SENSOR
	H8	CT ABNORMALITY
	H9	FAULTY SUCTION AIR TEMPERATURE SENSOR
	J3	FAULTY DISCHARGE PIPE TEMPERATURE SENSOR
	J6	FAULTY HEAT EXCHANGER TEMPERATURE SENSOR
	L3	ELECTRICAL PARTS HEAT FAULT
	L4	HIGH TEMPERATURE AT INVERTER CIRCUIT HEATSINK
	L5	OUTPUT OVERCURRENT
	P4	FAULTY INVERTER CIRCUIT HEATSINK TEMPERATURE SENSOR
HUMIDIFY UNIT	PA	HEATER LINE BROKEN FAULT
	PH	HUMIDIFYING FAN OUTLET THERMISTOR FAULT, HEATER TEMPERATURE FAULT
	P9	HUMIDIFYING FAN LOCK

NOTE

- 1) A short beep and two consecutive beeps indicate non-corresponding codes.
- 2) To cancel the code display, hold the CANCEL button down for 5 seconds. The code display also cancel itself if the button is not pressed for 1 minute.

DAIKIN INDUSTRIES, LTD.

Head office:

Umeda Center Bldg., 2-4-12, Nakazaki-Nishi,
Kita-ku, Osaka, 530-8323 Japan

Tokyo office:

JR Shinagawa East Bldg., 2-18-1, Konan,
Minato-ku, Tokyo, 108-0075 Japan

DAIKIN EUROPE NV

Zandvoordestraat 300, B-8400 Oostende, Belgium