

Air Conditioning

Technical Data

CTXA-AW/BB/BS/BT
FTXA-AW/BB/BS/BT



- > CTXA15A2V1BW
- > CTXA15B2V1BB
- > CTXA15B2V1BS
- > CTXA15B2V1BT
- > FTXA20A2V1BW
- > FTXA20B2V1BB

- > FTXA20B2V1BS
- > FTXA20B2V1BT
- > FTXA25A2V1BW
- > FTXA25B2V1BB
- > FTXA25B2V1BS
- > FTXA25B2V1BT

- > FTXA35A2V1BW
- > FTXA35B2V1BB
- > FTXA35B2V1BS
- > FTXA35B2V1BT
- > FTXA42A2V1BW
- > FTXA42B2V1BB

- > FTXA42B2V1BS
- > FTXA42B2V1BT
- > FTXA50A2V1BW
- > FTXA50B2V1BB
- > FTXA50B2V1BS
- > FTXA50B2V1BT

TABLE OF CONTENTS

CTXA-AW/BB/BS/BT, FTXA-AW/BB/BS/BT

1	Features	2
	CTXA-AW	2
	CTXA-BB	3
	CTXA-BS	4
	CTXA-BT	5
	FTXA-AW	6
	FTXA-BB	7
	FTXA-BS	8
	FTXA-BT	9
2	Specifications	10
	Technical Specifications	10
	Technical Specifications	11
	Technical Specifications	13
	Electrical Specifications	15
	Electrical Specifications	15
	Electrical Specifications	15
3	Options	16
4	Dimensional drawings	17
5	Centre of gravity	18
6	Piping diagrams	19
7	Wiring diagrams	20
	Wiring Diagrams - Single Phase	20
8	Sound data	21
	Sound Power Spectrum	21
	Sound Pressure Spectrum	24

1 Features

1 - 1 CTXA-AW

- A compact and functional design suitable for all interiors in a matt crystal white finish
- The Coanda effect optimises the airflow for a comfortable climate. By using specially designed flaps, a more focused airflow allows a better temperature distribution throughout the whole room
- The intelligent thermal sensor determines the current room temperature and distributes air evenly throughout the room before switching to an airflow pattern that directs warm or cool air to areas that need it
- Powerful air purification increases indoor air quality with Daikin Flash Streamer technology
- Practically inaudible: the unit runs so quietly, you will almost forget it is there.
- Online controller: control your indoor from any location with an app, via your local network or internet
- Choosing for an R-32 product, reduces the environmental impact with 68% compared to R-410A and leads directly to lower energy consumption thanks to its high energy efficiency
- Seasonal efficiency values up to A+++ in cooling and heating

1



Practically inaudible	Coanda effect - cooling	Coanda effect - heating	Intelligent thermal sensor	Econo mode	Energy saving during standby mode	Night set mode	Fan only	Comfort mode
Powerful mode	Auto cooling-heating changeover	Indoor unit silent operation	Outdoor unit silent operation	3-D air flow	Vertical auto swing	Horizontal auto swing	Auto fan speed	Fan speed steps
Dry programme	Flash Streamer	Titanium apatite deodorising filter	Air filter	Weekly timer	Infrared remote control	Wired remote control	Centralised control	Online controller
Auto-restart	Self diagnosis	Multi model application						

1 Features

1 - 2 CTXA-BB

- A compact and functional design suitable for all interiors in a matt black finish
- The Coanda effect optimises the airflow for a comfortable climate. By using specially designed flaps, a more focused airflow allows a better temperature distribution throughout the whole room
- The intelligent thermal sensor determines the current room temperature and distributes air evenly throughout the room before switching to an airflow pattern that directs warm or cool air to areas that need it
- Online controller: control your indoor from any location with an app, via your local network or internet
- Powerful air purification increases indoor air quality with Daikin Flash Streamer technology
- Practically inaudible: the unit runs so quietly, you will almost forget it is there.
- Choosing for an R-32 product, reduces the environmental impact with 68% compared to R-410A and leads directly to lower energy consumption thanks to its high energy efficiency
- Seasonal efficiency values up to A+++ in cooling and heating

1



Practically inaudible	Coanda effect - cooling	Coanda effect - heating	Intelligent thermal sensor	Econo mode	Energy saving during standby mode	Night set mode	Fan only	Comfort mode
Powerful mode	Auto cooling-heating changeover	Indoor unit silent operation	Outdoor unit silent operation	3-D air flow	Vertical auto swing	Horizontal auto swing	Auto fan speed	Fan speed steps
Dry programme	Flash Streamer	Titanium apatite deodorising filter	Air filter	Weekly timer	Infrared remote control	Wired remote control	Centralised control	Online controller
Auto-restart	Self diagnosis	Multi model application						

1 Features

1 - 3 CTXA-BS

1

- A compact and functional design suitable for all interiors in a silver coloured elegant finish
- The Coanda effect optimises the airflow for a comfortable climate. By using specially designed flaps, a more focused airflow allows a better temperature distribution throughout the whole room
- The intelligent thermal sensor determines the current room temperature and distributes air evenly throughout the room before switching to an airflow pattern that directs warm or cool air to areas that need it
- Online controller: control your indoor from any location with an app, via your local network or internet
- Powerful air purification increases indoor air quality with Daikin Flash Streamer technology
- Practically inaudible: the unit runs so quietly, you will almost forget it is there.
- Choosing for an R-32 product, reduces the environmental impact with 68% compared to R-410A and leads directly to lower energy consumption thanks to its high energy efficiency
- Seasonal efficiency values up to A+++ in cooling and heating



Practically inaudible



Coanda effect - cooling



Coanda effect - heating



Intelligent thermal sensor



Econo mode



Energy saving during standby mode



Night set mode



Fan only



Comfort mode



Powerful mode



Auto cooling-heating changeover



Indoor unit silent operation



Outdoor unit silent operation



3-D air flow



Vertical auto swing



Horizontal auto swing



Auto fan speed



Fan speed steps



Dry programme



Flash Streamer



Titanium apatite deodorising filter



Air filter



Weekly timer



Infrared remote control



Wired remote control



Centralised control



Online controller



Auto-restart



Self diagnosis



Multi model application

1 Features

1 - 4 CTXA-BT

- A compact and functional design suitable for all interiors in blackwood finish
- The Coanda effect optimises the airflow for a comfortable climate. By using specially designed flaps, a more focused airflow allows a better temperature distribution throughout the whole room
- The intelligent thermal sensor determines the current room temperature and distributes air evenly throughout the room before switching to an airflow pattern that directs warm or cool air to areas that need it
- Online controller: control your indoor from any location with an app, via your local network or internet
- Powerful air purification increases indoor air quality with Daikin Flash Streamer technology
- Practically inaudible: the unit runs so quietly, you will almost forget it is there.
- Choosing for an R-32 product, reduces the environmental impact with 68% compared to R-410A and leads directly to lower energy consumption thanks to its high energy efficiency
- Seasonal efficiency values up to A+++ in cooling and heating



Practically inaudible	Coanda effect - cooling	Coanda effect - heating	Intelligent thermal sensor	Econo mode	Energy saving during standby mode	Night set mode	Fan only	Comfort mode
Powerful mode	Auto cooling-heating changeover	Indoor unit silent operation	Outdoor unit silent operation	3-D air flow	Vertical auto swing	Horizontal auto swing	Auto fan speed	Fan speed steps
Dry programme	Flash Streamer	Titanium apatite deodorising filter	Air filter	Weekly timer	Infrared remote control	Wired remote control	Centralised control	Online controller
Auto-restart	Self diagnosis	Multi model application						

1 Features

1 - 5 FTXA-AW

1

- A compact and functional design suitable for all interiors in a matt crystal white finish
- The Coanda effect optimises the airflow for a comfortable climate. By using specially designed flaps, a more focused airflow allows a better temperature distribution throughout the whole room
- The intelligent thermal sensor determines the current room temperature and distributes air evenly throughout the room before switching to an airflow pattern that directs warm or cool air to areas that need it
- Powerful air purification increases indoor air quality with Daikin Flash Streamer technology
- Practically inaudible: the unit runs so quietly, you will almost forget it is there.
- Online controller: control your indoor from any location with an app, via your local network or internet
- Choosing for an R-32 product, reduces the environmental impact with 68% compared to R-410A and leads directly to lower energy consumption thanks to its high energy efficiency
- Seasonal efficiency values up to A+++ in cooling and heating



Practically inaudible	Coanda effect - cooling	Coanda effect - heating	Intelligent thermal sensor	Econo mode	Energy saving during standby mode	Night set mode	Fan only	Comfort mode
Powerful mode	Auto cooling-heating changeover	Indoor unit silent operation	Outdoor unit silent operation	3-D air flow	Vertical auto swing	Horizontal auto swing	Auto fan speed	Fan speed steps
Dry programme	Silver allergen removal and air purifying filter	Flash Streamer	Titanium apatite deodorising filter	Air filter	Weekly timer	Infrared remote control	Wired remote control	Centralised control
Online controller	Auto-restart	Self diagnosis	Multi model application					

1 Features

1 - 6 FTXA-BB

- A compact and functional design suitable for all interiors in a matt black finish
- The Coanda effect optimises the airflow for a comfortable climate. By using specially designed flaps, a more focused airflow allows a better temperature distribution throughout the whole room
- The intelligent thermal sensor determines the current room temperature and distributes air evenly throughout the room before switching to an airflow pattern that directs warm or cool air to areas that need it
- Online controller: control your indoor from any location with an app, via your local network or internet
- Powerful air purification increases indoor air quality with Daikin Flash Streamer technology
- Practically inaudible: the unit runs so quietly, you will almost forget it is there.
- Choosing for an R-32 product, reduces the environmental impact with 68% compared to R-410A and leads directly to lower energy consumption thanks to its high energy efficiency
- Seasonal efficiency values up to A+++ in cooling and heating



Practically inaudible	Coanda effect - cooling	Coanda effect - heating	Intelligent thermal sensor	Econo mode	Energy saving during standby mode	Night set mode	Fan only	Comfort mode
Powerful mode	Auto cooling-heating changeover	Indoor unit silent operation	Outdoor unit silent operation	3-D air flow	Vertical auto swing	Horizontal auto swing	Auto fan speed	Fan speed steps
Dry programme	Silver allergen removal and air purifying filter	Flash Streamer	Titanium dioxide deodorising filter	Air filter	Weekly timer	Infrared remote control	Wired remote control	Centralised control
Online controller	Auto-restart	Self diagnosis	Multi model application					

1 Features

1 - 7 FTXA-BS

1

- A compact and functional design suitable for all interiors in a silver coloured elegant finish
- The Coanda effect optimises the airflow for a comfortable climate. By using specially designed flaps, a more focused airflow allows a better temperature distribution throughout the whole room
- The intelligent thermal sensor determines the current room temperature and distributes air evenly throughout the room before switching to an airflow pattern that directs warm or cool air to areas that need it
- Online controller: control your indoor from any location with an app, via your local network or internet
- Powerful air purification increases indoor air quality with Daikin Flash Streamer technology
- Practically inaudible: the unit runs so quietly, you will almost forget it is there.
- Choosing for an R-32 product, reduces the environmental impact with 68% compared to R-410A and leads directly to lower energy consumption thanks to its high energy efficiency
- Seasonal efficiency values up to A+++ in cooling and heating



Practically inaudible	Coanda effect - cooling	Coanda effect - heating	Intelligent thermal sensor	Econo mode	Energy saving during standby mode	Night set mode	Fan only	Comfort mode
Powerful mode	Auto cooling-heating changeover	Indoor unit silent operation	Outdoor unit silent operation	3-D air flow	Vertical auto swing	Horizontal auto swing	Auto fan speed	Fan speed steps
Dry programme	Silver allergen removal and air purifying filter	Flash Streamer	Titanium apatite deodorising filter	Air filter	Weekly timer	Infrared remote control	Wired remote control	Centralised control
Online controller	Auto-restart	Self diagnosis	Multi model application					

1 Features

1 - 8 FTXA-BT

- A compact and functional design suitable for all interiors in blackwood finish
- The Coanda effect optimises the airflow for a comfortable climate. By using specially designed flaps, a more focused airflow allows a better temperature distribution throughout the whole room
- The intelligent thermal sensor determines the current room temperature and distributes air evenly throughout the room before switching to an airflow pattern that directs warm or cool air to areas that need it
- Online controller: control your indoor from any location with an app, via your local network or internet
- Powerful air purification increases indoor air quality with Daikin Flash Streamer technology
- Practically inaudible: the unit runs so quietly, you will almost forget it is there.
- Choosing for an R-32 product, reduces the environmental impact with 68% compared to R-410A and leads directly to lower energy consumption thanks to its high energy efficiency
- Seasonal efficiency values up to A+++ in cooling and heating

1



Practically inaudible	Coanda effect - cooling	Coanda effect - heating	Intelligent thermal sensor	Econo mode	Energy saving during standby mode	Night set mode	Fan only	Comfort mode
Powerful mode	Auto cooling-heating changeover	Indoor unit silent operation	Outdoor unit silent operation	3-D air flow	Vertical auto swing	Horizontal auto swing	Auto fan speed	Fan speed steps
Dry programme	Silver allergen removal and air purifying filter	Flash Streamer	Titanium apatite deodorising filter	Air filter	Weekly timer	Infrared remote control	Wired remote control	Centralised control
Online controller	Auto-restart	Self diagnosis	Multi model application					

2 Specifications

2

2-1 Technical Specifications				CTXA15AW	CTXA15BB	CTXA15BS	CTXA15BT	FTXA20AW	FTXA20BB	FTXA20BS	FTXA20BT		
Power input	Cooling	Nom.	kW	0.020									
	Heating	Nom.	kW	0.020									
Casing	Colour			White	Black	Silver	Blackwood	White	Black	Silver	Blackwood		
Dimensions	Unit	Height/Width/Depth	mm	295/798/189									
	Packed unit	Height/Width/Depth	mm	305/875/406									
Weight	Unit		kg	12	11.5			12	11.5				
	Packed unit		kg	14									
Packing	Weight		kg	3	2.5			3	2.5				
Heat exchanger	Length		mm	622									
	Rows	Quantity		2									
	Fin pitch		mm	1.40									
	Face area		m ²	0.214									
	Stages	Quantity		18									
	Passes	Quantity		3	3.385			3	3.385				
	Tube type		ø5 Hi-XB										
	Tube material		Copper										
	Tube diameter		mm	5									
	Fin	Type		ML fin (Multi louver)									
Heat exchanger 2	Length		mm	614									
	Rows	Quantity		1									
	Fin pitch		mm	1.40									
	Face area		m ²	0.047									
	Stages	Quantity		4									
Air filter	Type		Removable / washable										
	Quantity		pc	2									
Fan	Type		Cross flow fan										
	Quantity		1										
	Air flow rate	Cooling	High	m ³ /min	11.0								
				cfm	388								
			Medium	m ³ /min	8	8.2			8	8.2			
				cfm	290								
			Low	m ³ /min	6.1								
				cfm	215								
		Silent operation	m ³ /min	4.6									
			cfm	162									
		Heating	High	m ³ /min	10.9								
				cfm	385								
			Medium	m ³ /min	8.7	8.7							
cfm				307									
Low	m ³ /min		6.4										
	cfm		226										
Silent operation	m ³ /min	4.5											
	cfm	159											

2 Specifications

2-1 Technical Specifications				CTXA15AW	CTXA15BB	CTXA15BS	CTXA15BT	FTXA20AW	FTXA20BB	FTXA20BS	FTXA20BT	
Fan motor	Quantity			1								
	Model			MM9G07N9SA								
	Speed	Cooling	High/ Medium/ Low/ Silent operation	rpm	1,100/870/690/570							
		Heating	High/ Medium/ Low/ Silent operation	rpm	1,090/920/740/590							
Sound power level	Cooling		dBA	57								
	Heating		dBA	-								
Sound pressure level	Cooling	High/Medium/ Low/Silent operation	dBA	39/32/25/21	39/32/25/21			39/32/25/19				
	Heating	High/Medium/ Low/Silent operation	dBA	39/32/25/21			39/32/25/19					
Control systems	Infrared remote control			ARC466A58								
	Wired remote control			BRC073								
Refrigerant	Type			R-32								
	GWP			675.0								
Piping connections	Liquid	OD		6.35								
	Gas	OD		9.50								
	Drain			18								
	Heat insulation			Both liquid and gas pipes								
Temperature control			Microcomputer control									
Air direction control			Right, Left, Horizontal, Downward									

Standard Accessories : Installation manual; Quantity : 1;

Standard Accessories : Operation manual; Quantity : 1;

Standard Accessories : Air filter; Quantity : 2;

Standard Accessories : Infrared remote control; Quantity : 1;

Standard Accessories : Remote controller mounting plate; Quantity : 1;

Standard Accessories : Screw bag; Quantity : 1;

Standard Accessories : Screw cover; Quantity : 2;

Standard Accessories : AAA dry-cell batteries; Quantity : 2;

Standard Accessories : General safety precautions; Quantity : 1;

2-2 Technical Specifications				FTXA25AW	FTXA25BB	FTXA25BS	FTXA25BT	FTXA35AW	FTXA35BB	FTXA35BS	FTXA35BT
Power input	Cooling	Nom.	kW	0.022				0.023			
	Heating	Nom.	kW	0.020				0.022			
Casing	Colour			White	Black	Silver	Blackwood	White	Black	Silver	Blackwood
Dimensions	Unit	Height/Width/ Depth	mm	295/798/189							
	Packed unit	Height/Width/ Depth	mm	305/875/406							
Weight	Unit		kg	12	11.5			12	11.5		
	Packed unit		kg	14							
Packing	Weight		kg	3	2.5			3	2.5		

2 Specifications

2

2-2 Technical Specifications				FTXA25AW	FTXA25BB	FTXA25BS	FTXA25BT	FTXA35AW	FTXA35BB	FTXA35BS	FTXA35BT		
Heat exchanger	Length		mm	622									
	Rows	Quantity		2									
	Fin pitch		mm	1.40									
	Face area		m ²	0.214									
	Stages	Quantity		18									
	Passes	Quantity		3	3.385				3	3.385			
	Tube type		ø5 Hi-XB										
	Tube material		Copper										
	Tube diameter		mm	5									
	Fin	Type		ML fin (Multi louver)									
Heat exchanger 2	Length		mm	614									
	Rows	Quantity		1									
	Fin pitch		mm	1.40									
	Face area		m ²	0.047									
	Stages	Quantity		4									
Air filter	Type		Removable / washable										
	Quantity		pc	2									
Fan	Type		Cross flow fan										
	Quantity		1										
	Air flow rate	Cooling	High	m ³ /min	11.5				11.9				
				cfm	406				420				
			Medium	m ³ /min	9	8.6				9	8.6		
				cfm	304								
			Low	m ³ /min	6.1								
				cfm	215								
		Silent operation	m ³ /min	4.6									
			cfm	162									
		Heating	High	m ³ /min	11.1				11.5				
				cfm	392				406				
			Medium	m ³ /min	9.0								
				cfm	318								
Low	m ³ /min		6.4										
	cfm		226										
Silent operation	m ³ /min	4.5											
	cfm	159											
Fan motor	Quantity		1										
	Model		MM9G07N9SA										
	Speed	Cooling	High/Medium/Low/Silent operation	rpm	1,140/900/690/570				1,180/900/690/570				
					Heating	High/Medium/Low/Silent operation	rpm	1,110/940/740/590				1,140/940/740/590	
	Sound power level		Cooling	dBA				57				60	
Sound pressure level		Cooling	High/Medium/Low/Silent operation	dBA	40/33/25/19				41/33/25/19				
		Heating	High/Medium/Low/Silent operation	dBA	40/33/25/19				41/33/25/19				
Control systems	Infrared remote control		ARC466A58										
	Wired remote control		BRC073										

2 Specifications

2-2 Technical Specifications		FTXA25AW	FTXA25BB	FTXA25BS	FTXA25BT	FTXA35AW	FTXA35BB	FTXA35BS	FTXA35BT
Refrigerant	Type	R-32							
	GWP	675.0							
Piping connections	Liquid	-							
	Gas	-							
Drain	18								
Heat insulation	Both liquid and gas pipes								
Temperature control	Microcomputer control								
Air direction control	Right, Left, Horizontal, Downward								

Standard Accessories : Installation manual; Quantity : 1;

Standard Accessories : Operation manual; Quantity : 1;

Standard Accessories : Air filter; Quantity : 2;

Standard Accessories : Infrared remote control; Quantity : 1;

Standard Accessories : Remote controller mounting plate; Quantity : 1;

Standard Accessories : Screw bag; Quantity : 1;

Standard Accessories : Screw cover; Quantity : 2;

Standard Accessories : AAA dry-cell batteries; Quantity : 2;

Standard Accessories : General safety precautions; Quantity : 1;

2-3 Technical Specifications				FTXA42AW	FTXA42BB	FTXA42BS	FTXA42BT	FTXA50AW	FTXA50BB	FTXA50BS	FTXA50BT
Power input	Cooling	Nom.	kW	0.028				0.030			
	Heating	Nom.	kW	0.036				0.039			
Casing	Colour			White	Black	Silver	Blackwood	White	Black	Silver	Blackwood
Dimensions	Unit	Height/Width/Depth	mm	295/798/189							
	Packed unit	Height/Width/Depth	mm	305/875/406							
Weight	Unit	kg		12	11.5			12	11.5		
	Packed unit	kg		14							
Packing	Weight	kg		3	2.5			3	2.5		
Heat exchanger	Length	mm		622							
	Rows	Quantity		2							
	Fin pitch	mm		1.40							
	Face area	m ²		0.214							
	Stages	Quantity		18							
	Passes	Quantity		3	3.385			3	3.385		
	Tube type			ø5 Hi-XB							
	Tube material			Copper							
	Tube diameter	mm		5							
	Fin	Type		ML fin (Multi louver)							
Heat exchanger 2	Length	mm		614							
	Rows	Quantity		1							
	Fin pitch	mm		1.40							
	Face area	m ²		0.047							
	Stages	Quantity		4							
Air filter	Type			Removable / washable							
	Quantity	pc		2							

2 Specifications

2-3 Technical Specifications				FTXA42AW	FTXA42BB	FTXA42BS	FTXA42BT	FTXA50AW	FTXA50BB	FTXA50BS	FTXA50BT			
Fan	Type			Cross flow fan										
	Quantity			1										
	Air flow rate	Cooling	High	m ³ /min	13.1				13.5					
				cfm	463				477					
			Medium	m ³ /min	10	9.8				10	10.4			
				cfm	346				367					
			Low	m ³ /min	7.2				7.6					
				cfm	254				268					
		Silent operation	m ³ /min	4.6				5.2						
			cfm	162				184						
		Heating	High	m ³ /min	14.6				15.1					
				cfm	516				533					
			Medium	m ³ /min	10.5				11.1					
				cfm	371				392					
	Low		m ³ /min	7.7				8.2						
cfm			272				290							
Silent operation	m ³ /min	5.2				5.7								
	cfm	184				201								
Fan motor	Quantity			1										
	Model			MM9G07N9SA										
	Speed	Cooling	High/ Medium/ Low/ Silent operation	rpm	1,210/980/780/570				1,240/1,020/820/620					
					Heating	High/ Medium/ Low/ Silent operation	rpm	1,310/1,070/850/640				1,350/1,190/930/680		
Sound power level	Cooling		dB(A)	60										
	Heating			-										
Sound pressure level	Cooling	High/Medium/ Low/Silent operation	dB(A)	45/37/29/21				46/39/31/24						
	Heating			45/37/29/21				46/42/33/24						
Control systems	Infrared remote control			ARC466A58										
	Wired remote control			BRC073										
Refrigerant	Type			R-32										
	GWP			675.0										
Piping connections	Liquid			-										
	Gas			-										
Drain				18										
Heat insulation				Both liquid and gas pipes										
Temperature control				Microcomputer control										
Air direction control				Right, Left, Horizontal, Downward										

Standard Accessories : Installation manual; Quantity : 1;

Standard Accessories : Operation manual; Quantity : 1;

Standard Accessories : Air filter; Quantity : 2;

Standard Accessories : Infrared remote control; Quantity : 1;

Standard Accessories : Remote controller mounting plate; Quantity : 1;

Standard Accessories : Screw bag; Quantity : 1;

2 Specifications

Standard Accessories : Screw cover; Quantity : 2;

Standard Accessories : AAA dry-cell batteries; Quantity : 2;

Standard Accessories : General safety precautions; Quantity : 1;

2-4 Electrical Specifications				CTXA15AW	CTXA15BB	CTXA15BS	CTXA15BT	FTXA20AW	FTXA20BB	FTXA20BS	FTXA20BT
Power supply	Name		V1								
	Phase		1~								
	Frequency	Hz	50								
	Voltage	V	220-240								
Current	Nominal running current (RLA) - 50Hz	Cooling	A	0.3							
		Heating	A	0.3							
Wiring connections - 50Hz	For power supply	Quantity	3								
		Remark	3 for power supply, 4 for interunit wiring (Earth wire included)								

2-5 Electrical Specifications				FTXA25AW	FTXA25BB	FTXA25BS	FTXA25BT	FTXA35AW	FTXA35BB	FTXA35BS	FTXA35BT
Power supply	Name		V1								
	Phase		1~								
	Frequency	Hz	50								
	Voltage	V	220-240								
Current	Nominal running current (RLA) - 50Hz	Cooling	A	0.4							
		Heating	A	0.4							
Wiring connections - 50Hz	For power supply	Quantity	3								
		Remark	3 for power supply, 4 for interunit wiring (Earth wire included)								

2-6 Electrical Specifications				FTXA42AW	FTXA42BB	FTXA42BS	FTXA42BT	FTXA50AW	FTXA50BB	FTXA50BS	FTXA50BT
Power supply	Name		V1								
	Phase		1~								
	Frequency	Hz	50								
	Voltage	V	220-240								
Current	Nominal running current (RLA) - 50Hz	Cooling	A	0.5							
		Heating	A	0.6							
Wiring connections - 50Hz	For power supply	Quantity	3								
		Remark	3 for power supply, 4 for interunit wiring (Earth wire included)								

3 Options

3 - 1 Options

3

CTXA-AW_BB_BS_BT
FTXA-AW_BB_BS_BT

Option kit	Product name	Remark	Applicable models	Class	Casting	Factory
Wired remote control	BRC073A4	②③	CTXA15A2W1BW	15	STW0H	00C
Extension cord for wired remote control (-3-m)	BRCW901A03		CTXA15A2W1BS	15	STW0H	00C
Extension cord for wired remote control (-8-m)	BRCW901A08		CTXA15A2W1BF	15	STW0H	00C
Interface adaptor for DIII-NET	KRP928BA25	②③	FTXA20A2W1BW	20	STW0H	00C
Central remote control	DCS302CA51	②③	FTXA20A2W1BS	20	STW0H	00C
Schedule timer	DST301BA51	②③	FTXA20A2W1BF	20	STW0H	00C
Unified ON/OFF controller	DCS301BA51	②③	FTXA25A2W1BW	25	STW0H	00C
Wiring adaptor (normal open contact - normal open pulse contact)	KRP413A15	②③	FTXA25A2W1BS	25	STW0H	00C
Conversion wire harness	EKRS21	②	FTXA25A2W1BF	25	STW0H	00C
Anti-theft protection for remote control	KKFS10A4		FTXA35A2W1BW	35	STW0H	00C
KNX interface	KLIC-DD	②③	FTXA35A2W1BS	35	STW0H	00C
Titanium apatite deodorising filter without frame	KAF970A46	②	FTXA35A2W1BF	35	STW0H	00C
Silver particle filter (Ag-ion) with frame	KAF057A41	②	FTXA42A2W1BW	42	STW0H	00C
			FTXA42A2W1BS	42	STW0H	00C
			FTXA42A2W1BF	42	STW0H	00C
			FTXA50A2W1BW	50	STW0H	00C
			FTXA50A2W1BS	50	STW0H	00C
			FTXA50A2W1BF	50	STW0H	00C
			FTXA30A2W1BW	30	STW0H	00C
			FTXA15B2V1BB	15	STW0H	00C
			CTXA15B2V1BS	15	STW0H	00C
			CTXA15B2V1BF	15	STW0H	00C
			FTXA20B2V1BB	20	STW0H	00C
			FTXA20B2V1BS	20	STW0H	00C
			FTXA20B2V1BF	20	STW0H	00C
			FTXA25B2V1BB	25	STW0H	00C
			FTXA25B2V1BS	25	STW0H	00C
			FTXA25B2V1BF	25	STW0H	00C
			FTXA35B2V1BB	35	STW0H	00C
			FTXA35B2V1BS	35	STW0H	00C
			FTXA35B2V1BF	35	STW0H	00C
			FTXA42B2V1BB	42	STW0H	00C
			FTXA42B2V1BS	42	STW0H	00C
			FTXA42B2V1BF	42	STW0H	00C
			FTXA50B2V1BB	50	STW0H	00C
			FTXA50B2V1BS	50	STW0H	00C
			FTXA50B2V1BF	50	STW0H	00C

Notes

- Standard accessory
- This option features a(n) ·S21· connector. To connect this option to the indoor unit, therefore conversion wire harness ·EKRS21· is required.
- This option cannot operate together with the wireless LAN functionality that is a standard feature of the indoor unit.
When connecting this option to the indoor unit, turn off the indoor unit's wireless LAN functionality.

3D114991B

4 Dimensional drawings

4 - 1 Dimensional Drawings

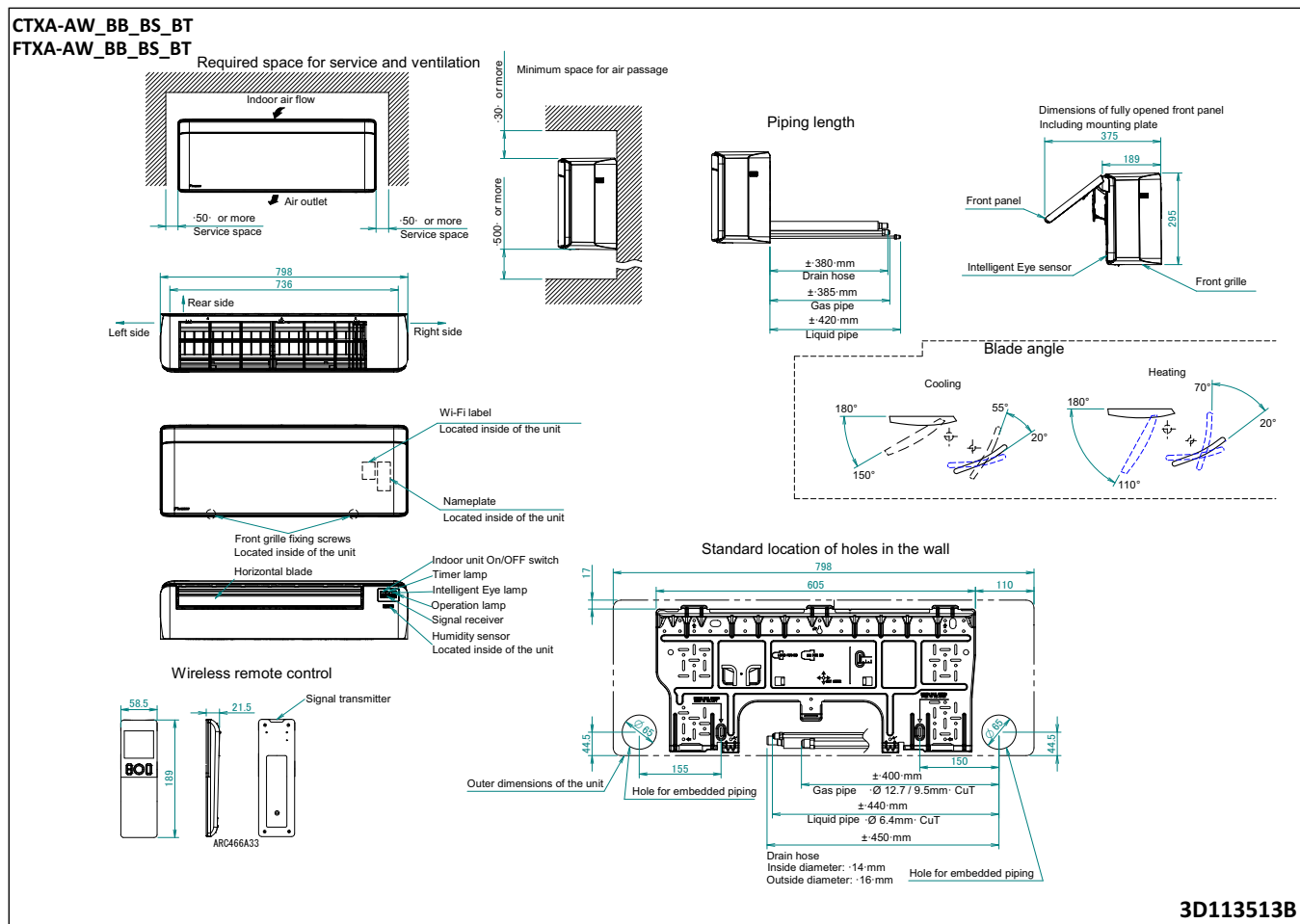

5 Centre of gravity

5 - 1 Centre of Gravity

CTXA-AW_BB_BS_BT

FTXA-AW_BB_BS_BT

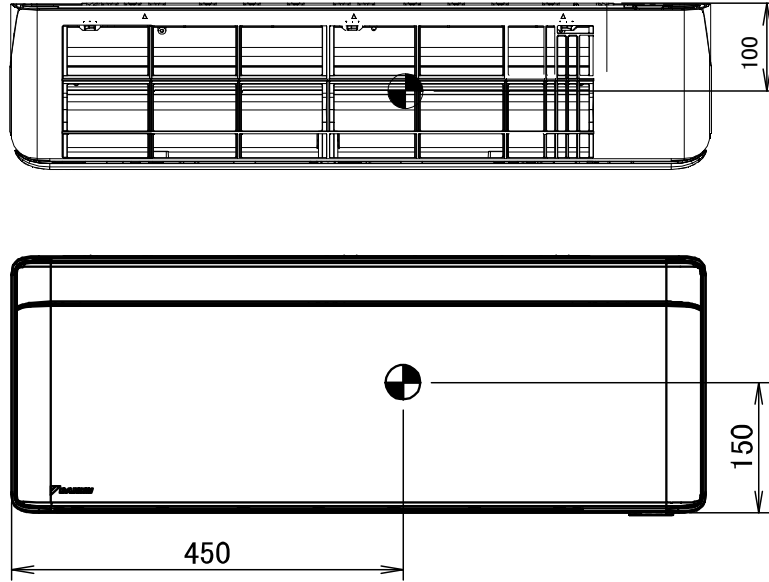

4D114705

6 Piping diagrams

6 - 1 Piping Diagrams

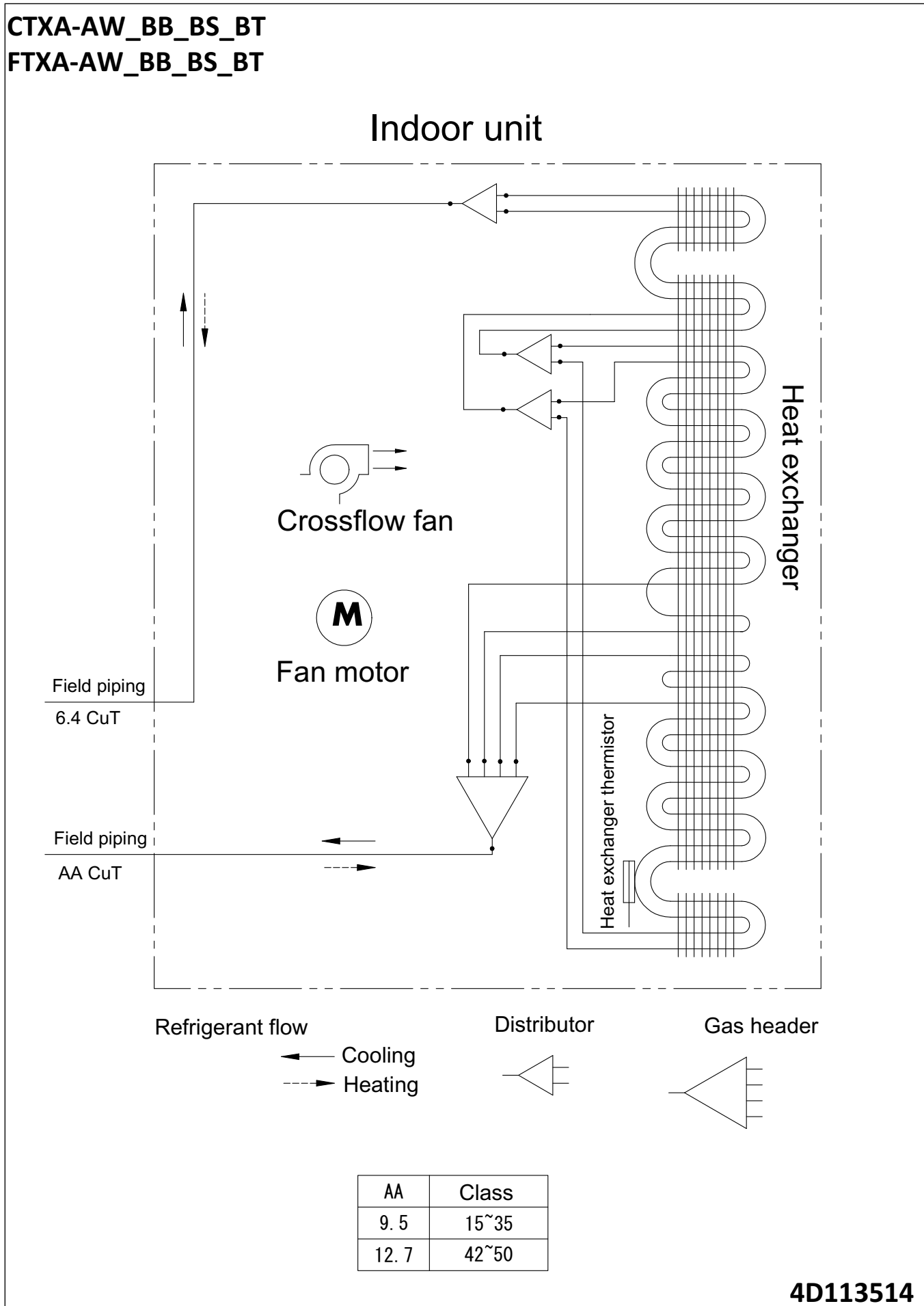

7 Wiring diagrams

7 - 1 Wiring Diagrams - Single Phase

7

CTXA-AW_BB_BS_BT
FTXA-AW_BB_BS_BT

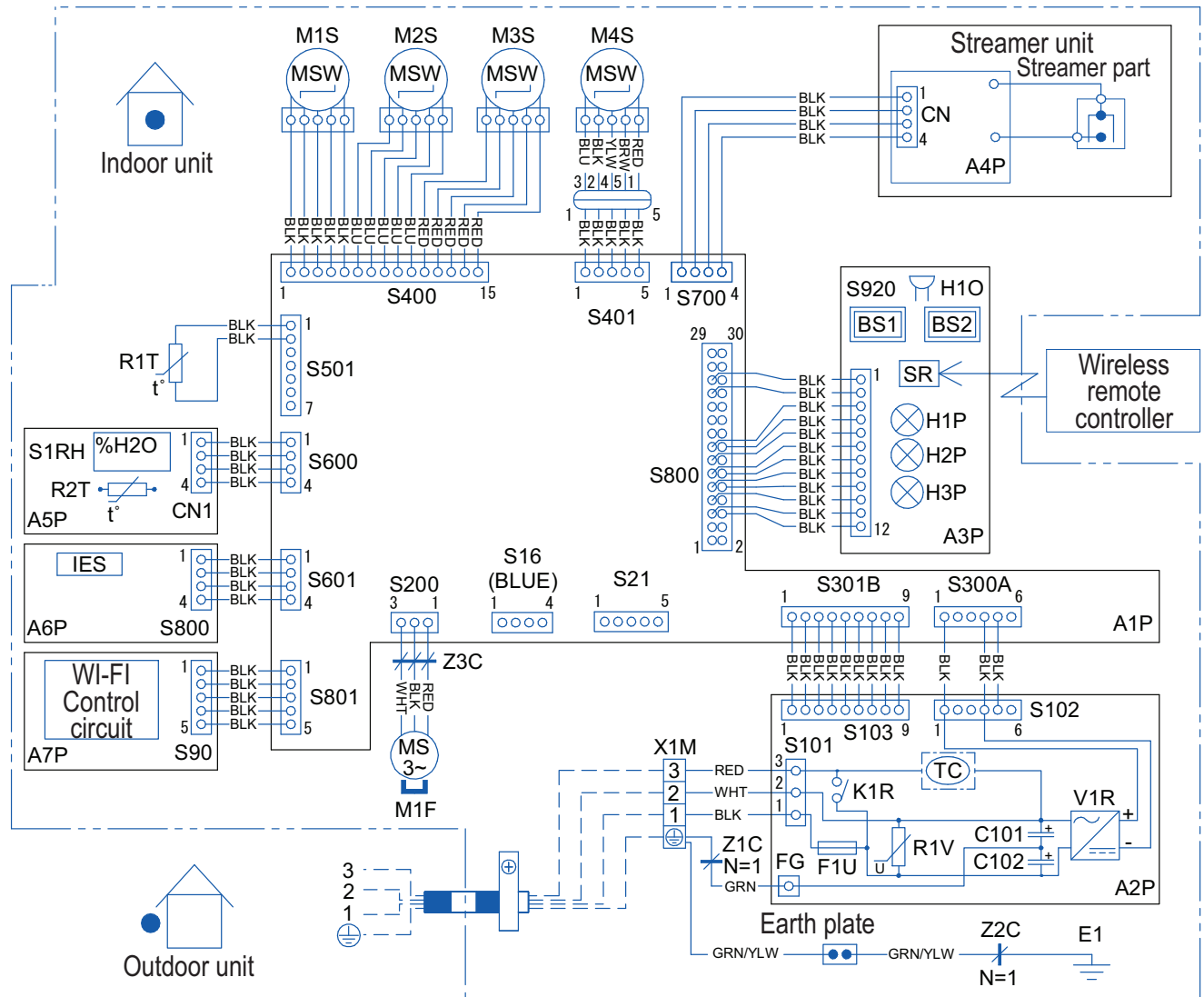

CN, CN1, S16-920, FG	Connector
X1M	Terminal block
F1U	Fuse (T, 3.15A, 250V)
M1F	Motor (indoor fan)
M1-3S	Motor (swing flap)
M4S	Motor (front panel)
A1-7P	Printed circuit
R1T, R2T	Thermistor
IES	Intelligent eye sensor
BS1, BS2	Button switch
H1-3P	Pilot lamp
SR	Signal receiver
H10	Buzzer
S1RH	Humidity sensor
Z1C, Z2C, Z3C	Ferrite core
E1	Heat exchanger
K1R	Magnetic relay
V1R	Rectifier
C101, C102	Capacitor
TC	Transmission circuit
⊕	Protective earth
R1V	Varistor

: Field wiring

WIRE COLORS

- BLK : Black
- YLW : Yellow
- RED : Red
- BLU : Blue
- BRW : Brown
- WHT : White

CAUTION

1. When the main power is turned off and then back on again, operation will resume automatically.

3D113338D

8 Sound data

8 - 1 Sound Power Spectrum

CTXA20AW_BB_BS_BT
FTXA20AW_BB_BS_BT

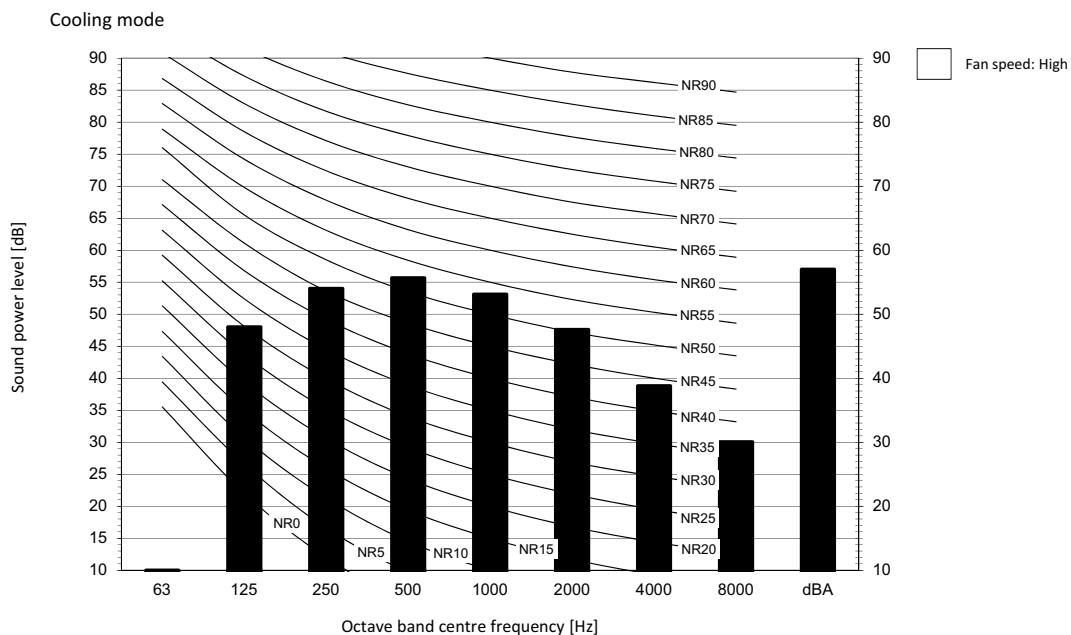

Notes

1. dBA = A-weighted sound power level (A scale according to IEC).
2. Reference acoustic intensity 0dB = $\cdot 10E-6\mu W/m^2$.
3. Measured according to ISO 3744

3D115037A

FTXA25AW_BB_BS_BT

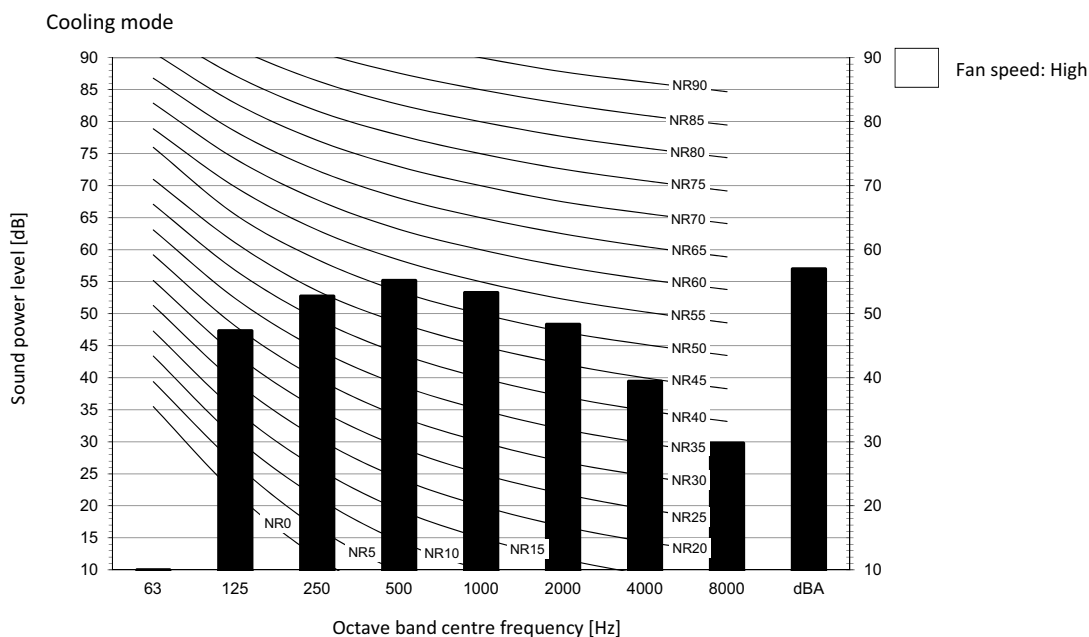

Notes

1. dBA = A-weighted sound power level (A scale according to IEC).
2. Reference acoustic intensity 0dB = $\cdot 10E-6\mu W/m^2$.
3. Measured according to ISO 3744

3D115038A

8 Sound data

8 - 1 Sound Power Spectrum

8

FTXA35AW_BB_BS_BT

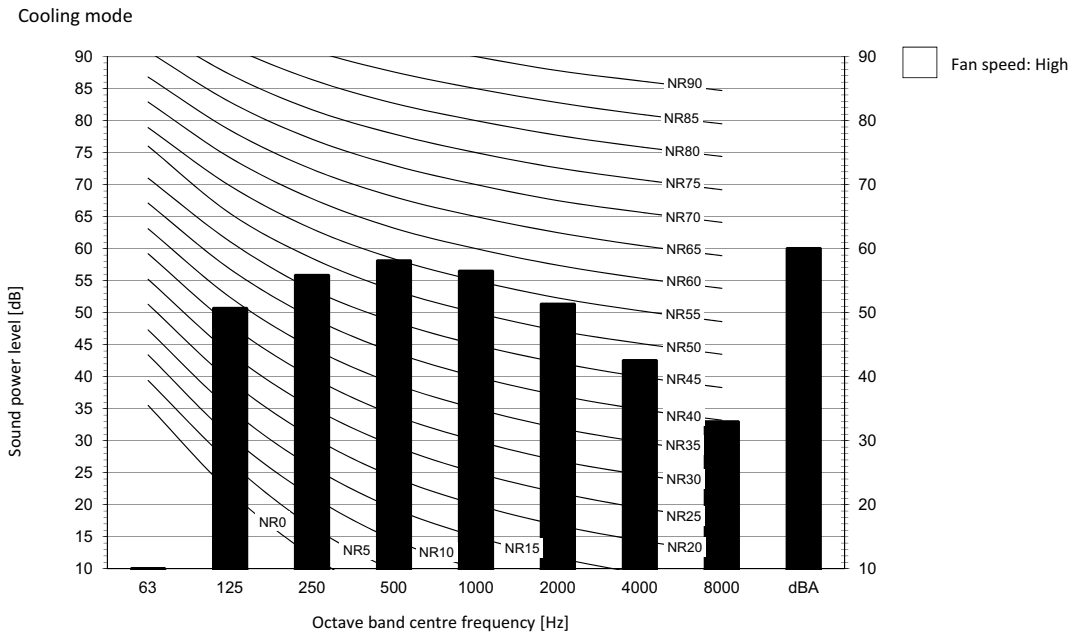

Notes

1. dBA = A-weighted sound power level (A scale according to IEC).
2. Reference acoustic intensity 0dB = $10^{-6} \mu\text{W}/\text{m}^2$.
3. Measured according to ISO 3744

3D115039A

FTXA42AW_BB_BS_BT

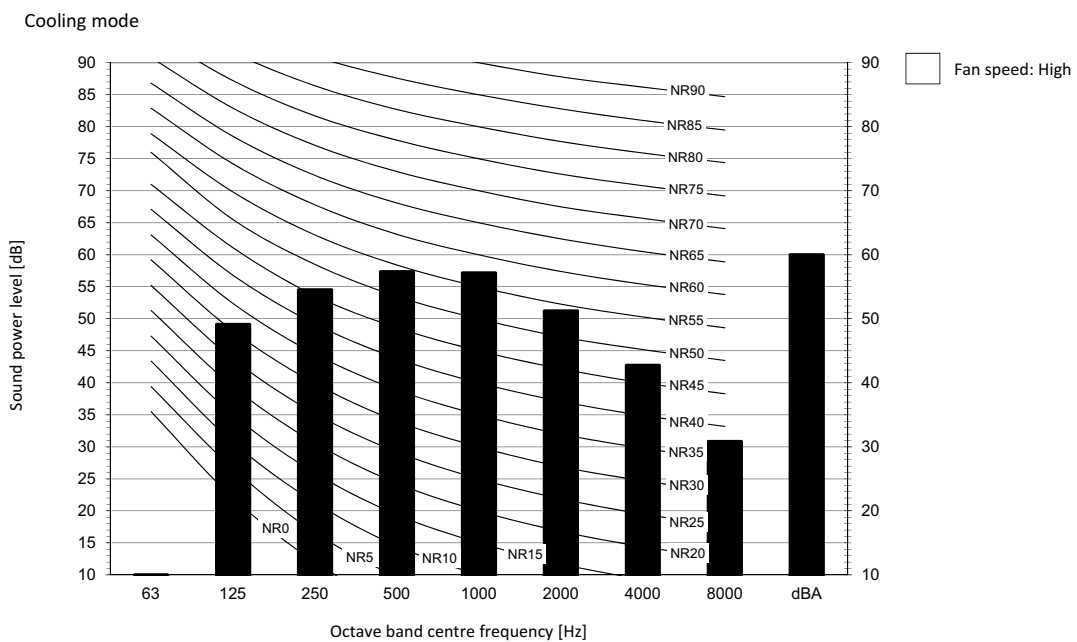

Notes

1. dBA = A-weighted sound power level (A scale according to IEC).
2. Reference acoustic intensity 0dB = $10^{-6} \mu\text{W}/\text{m}^2$.
3. Measured according to ISO 3744

3D115040A

8 Sound data

8 - 1 Sound Power Spectrum

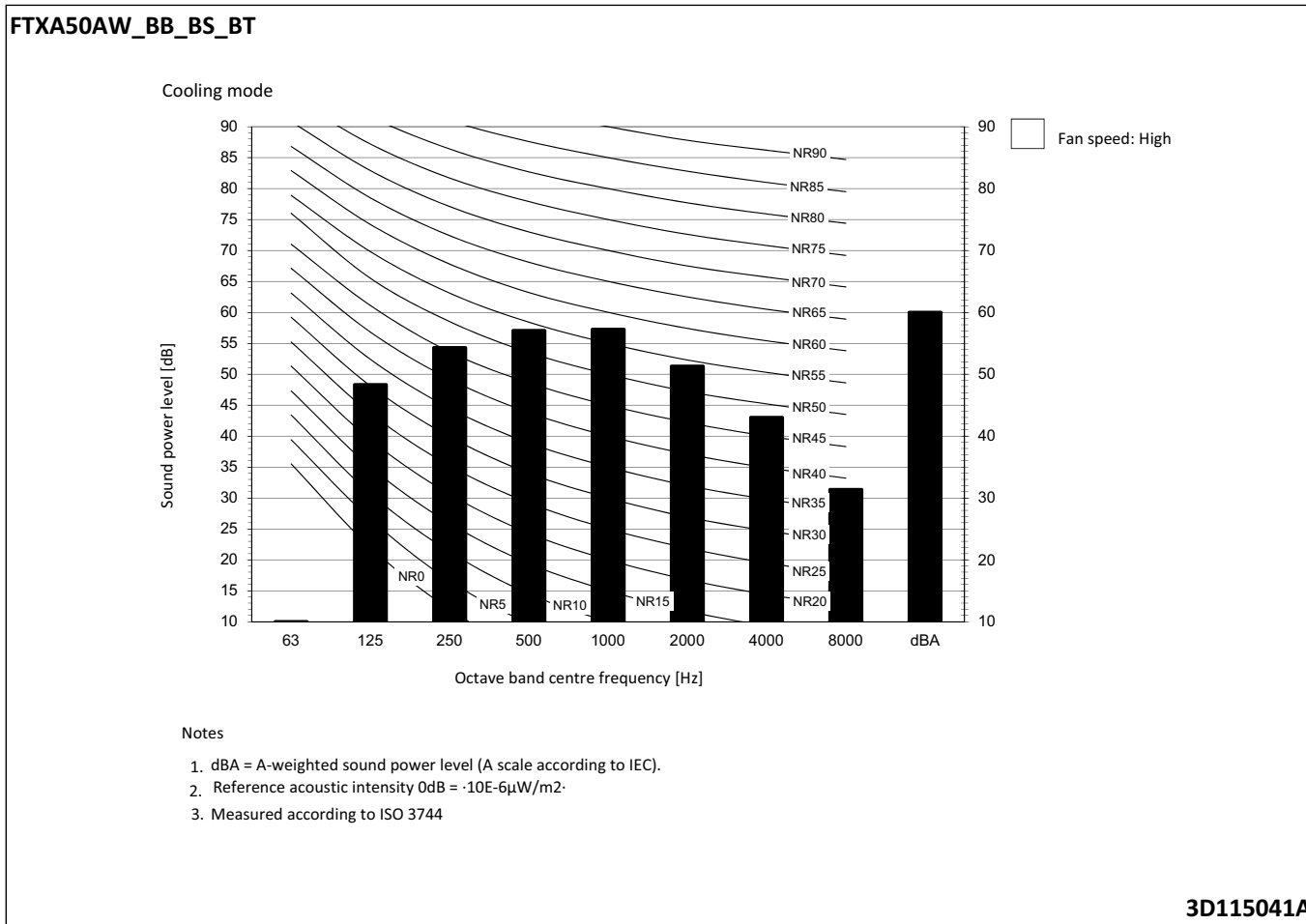

8 Sound data

8 - 2 Sound Pressure Spectrum

8

CTXA-AW_BB_BT_BS

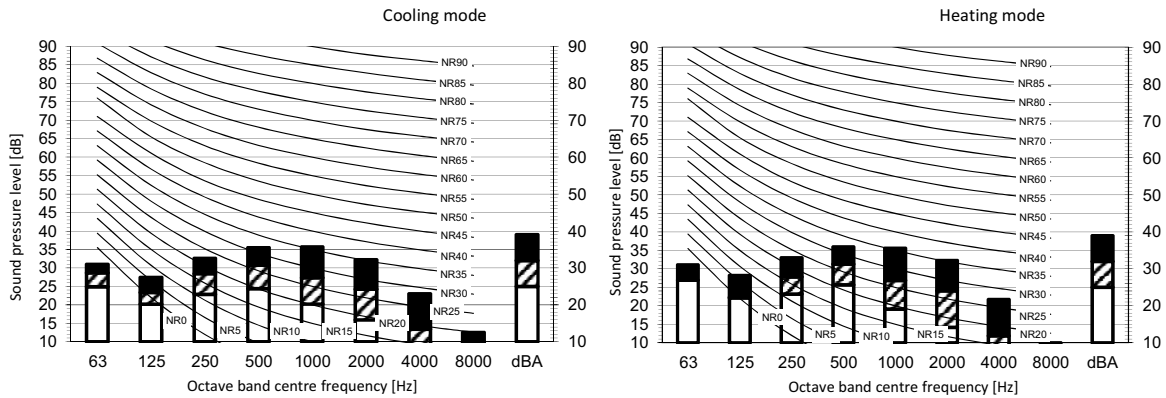

Legend

dBA = A-weighted sound pressure level (A scale according to IEC).

A Scale

- B Fan speed: High
- C Fan speed: Medium
- D Fan speed: Low

Location of microphone

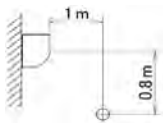

Cooling Total dB

A	B	C	D
dBA	39,0	32,0	25,0

Heating Total dB

A	B	C	D
dBA	39,0	32,0	25,0

Notes

- Operating conditions: power source 220-240 V/220 V 50/60 Hz; JIS standard
- Background noise already taken into account.
- Operating noise varies depending on operation and ambient conditions.
- The operation noise measuring method is in accordance with JISC9612.
- Measuring location: anechoic chamber

3D114924B

FTXA20AW_BB_BS_BT

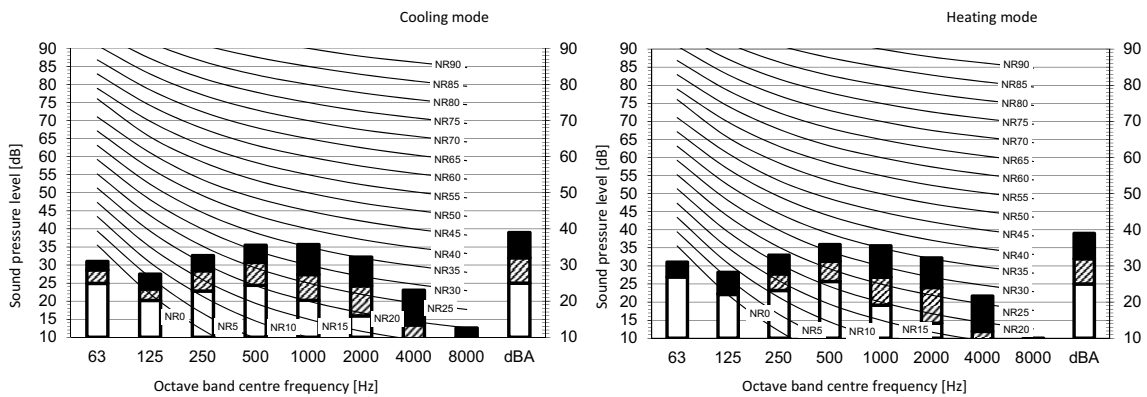

Legend

dBA = A-weighted sound pressure level (A scale according to IEC).

A Scale

- B Fan speed: High
- C Fan speed: Medium
- D Fan speed: Low

Location of microphone

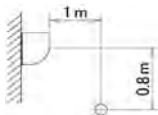

Cooling Total dB

A	B	C	D
dBA	39,0	32,0	25,0

Heating Total dB

A	B	C	D
dBA	39,0	32,0	25,0

Notes

- Operating conditions: power source 220-240 V/220 V 50/60 Hz; JIS standard
- Background noise already taken into account.
- Operating noise varies depending on operation and ambient conditions.
- The operation noise measuring method is in accordance with JISC9612.
- Measuring location: anechoic chamber

3D114919B

8 Sound data

8 - 2 Sound Pressure Spectrum

FTXA25AW_BB_BS_BT

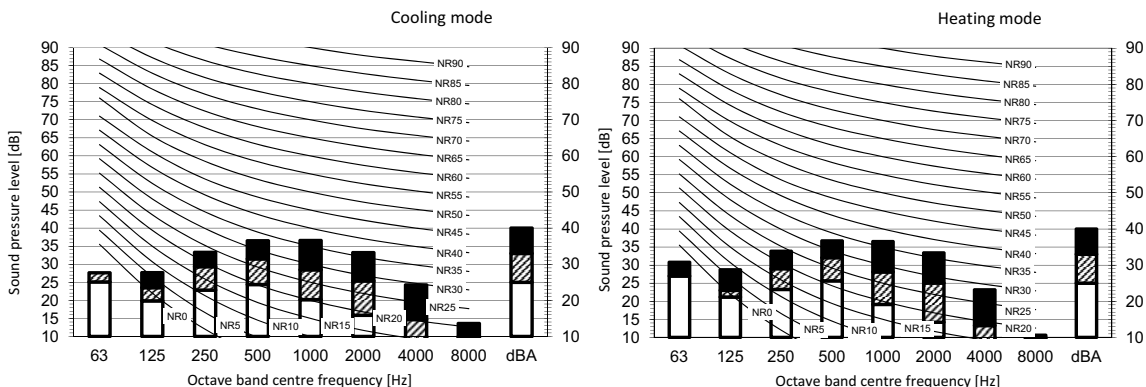

Legend

dBA = A-weighted sound pressure level (A scale according to IEC).

A Scale

- B Fan speed: High
- C Fan speed: Medium
- D Fan speed: Low

Location of microphone

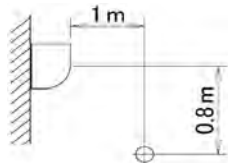

Cooling				Heating			
Total dB				Total dB			
A	B	C	D	A	B	C	D
dBA	40,0	33,0	25,0	dBA	40,0	33,0	25,0

Notes

1. Operating conditions: power source 220-240 V/220 V 50/60 Hz; JIS standard
2. Background noise already taken into account.
3. Operating noise varies depending on operation and ambient conditions.
4. The operation noise measuring method is in accordance with JISC9612.
5. Measuring location: anechoic chamber

3D114920B

FTXA35AW_BB_BS_BT

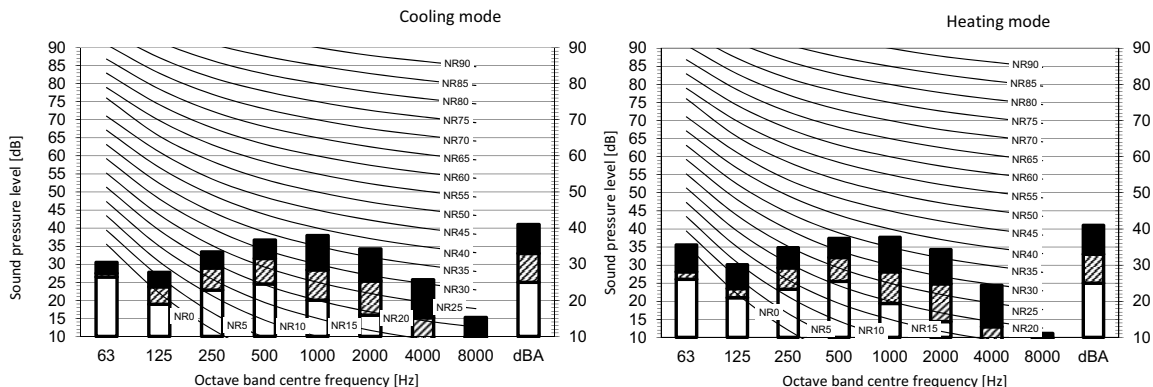

Legend

dBA = A-weighted sound pressure level (A scale according to IEC).

A Scale

- B Fan speed: High
- C Fan speed: Medium
- D Fan speed: Low

Location of microphone

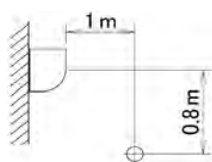

Cooling				Heating			
Total dB				Total dB			
A	B	C	D	A	B	C	D
dBA	41,0	33,0	25,0	dBA	41,0	33,0	25,0

Notes

1. Operating conditions: power source 220-240 V/220 V 50/60 Hz; JIS standard
2. Background noise already taken into account.
3. Operating noise varies depending on operation and ambient conditions.
4. The operation noise measuring method is in accordance with JISC9612.
5. Measuring location: anechoic chamber

3D114921B

8 Sound data

8 - 2 Sound Pressure Spectrum

8

FTXA42AW_BB_BS_BT

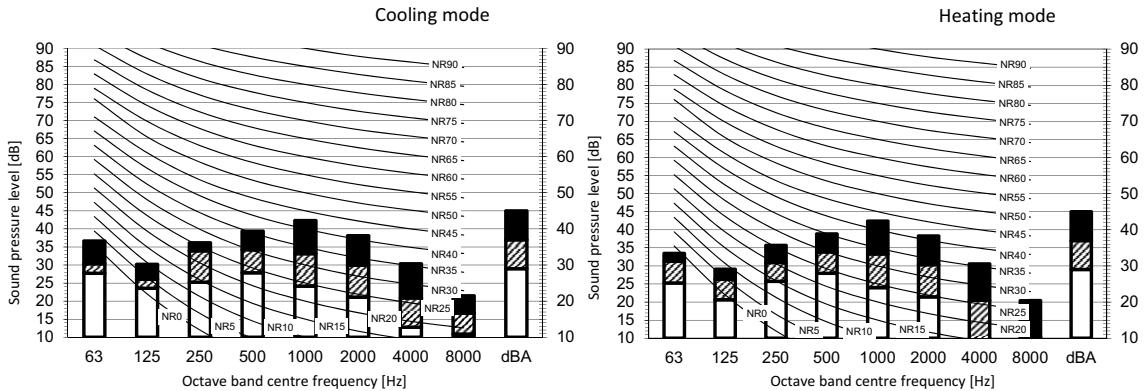

Legend

dBA = A-weighted sound pressure level (A scale according to IEC).

A Scale

- B Fan speed: High
- C Fan speed: Medium
- D Fan speed: Low

Location of microphone

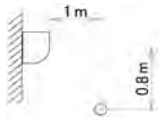

Cooling		Total dB			
A	B	C	D		
dBA	45,0	37,0	29,0		

Heating		Total dB			
A	B	C	D		
dBA	45,0	37,0	29,0		

Notes

1. Operating conditions: power source 220-240 V/220 V 50/60 Hz; JIS standard
2. Background noise already taken into account.
3. Operating noise varies depending on operation and ambient conditions.
4. The operation noise measuring method is in accordance with JISC9612.
5. Measuring location: anechoic chamber

3D114922B

FTXA50AW_BB_BS_BT

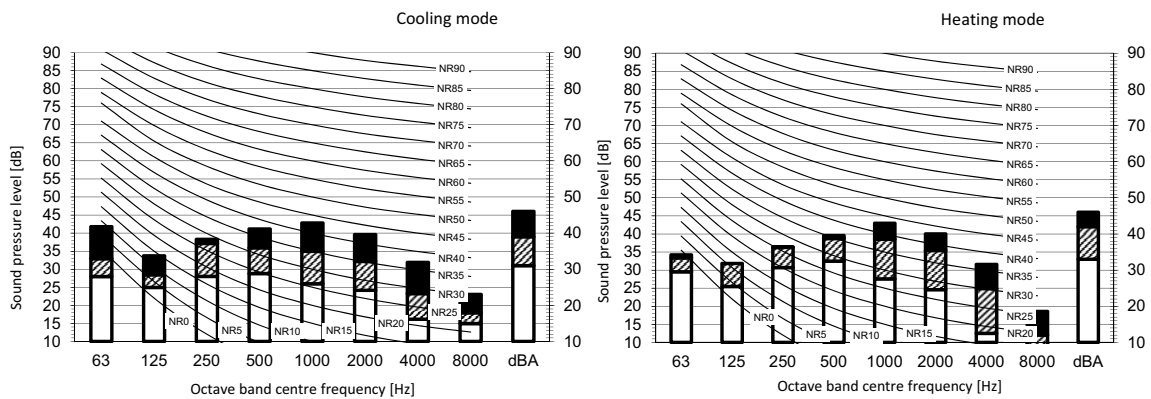

Legend

dBA = A-weighted sound pressure level (A scale according to IEC).

A Scale

- B Fan speed: High
- C Fan speed: Medium
- D Fan speed: Low

Location of microphone

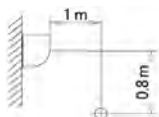

Cooling		Total dB			
A	B	C	D		
dBA	46,0	39,0	31,0		

Heating		Total dB			
A	B	C	D		
dBA	46,0	42,0	33,0		

Notes

1. Operating conditions: power source 220-240 V/220 V 50/60 Hz; JIS standard
2. Background noise already taken into account.
3. Operating noise varies depending on operation and ambient conditions.
4. The operation noise measuring method is in accordance with JISC9612.
5. Measuring location: anechoic chamber

3D114923C



Daikin Europe N.V. Naamloze Vennootschap - Zandvoordestraat 300, B-8400 Oostende - Belgium - BE 0412 120 336 - RPR Oostende

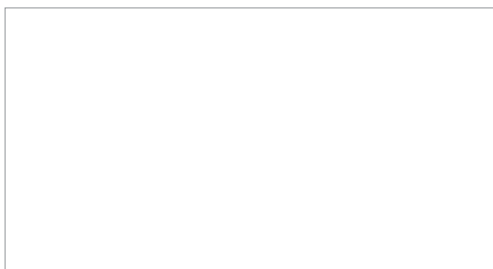

EEDEN20 01/20



Daikin Europe N.V. participates in the Eurovent Certified Performance programme for Liquid Chilling Packages and Hydronic Heat Pumps, Fan Coil Units and Variable Refrigerant Flow systems. Check ongoing validity of certificate



The present leaflet is drawn up by way of information only and does not constitute an offer binding upon Daikin Europe N.V.. Daikin Europe N.V. has compiled the content of this leaflet to the best of its knowledge. No express or implied warranty is given for the completeness, accuracy, reliability or fitness for particular purpose of its content and the products and services presented therein. Specifications are subject to change without prior notice. Daikin Europe N.V. explicitly rejects any liability for any direct or indirect damage, in the broadest sense, arising from or related to the use and/or interpretation of this leaflet. All content is copyrighted by Daikin Europe N.V.