

Standard Chiller Modular HP 1/4 Generic /Bitzer screw compressor and CAREL valve

Application program for pCO¹, pCO², pCO³



User manual

Manual Version: 1.4 dated 11/09/08
Program code: FLSTDmMSBE

→ LEGGI E CONSERVA
QUESTE ISTRUZIONI ←
→ READ AND SAVE
THESE INSTRUCTIONS ←



We wish to save you time and money!

We can assure you that the thorough reading of this manual will guarantee correct installation and safe use of the product described.

IMPORTANT WARNINGS



BEFORE INSTALLING OR HANDLING THE DEVICE PLEASE CAREFULLY READ AND FOLLOW THE INSTRUCTIONS DESCRIBED IN THIS MANUAL.

The device this software refers to was built to operate risk free for the intended purposes, providing: software installation, programming, operational control and maintenance must be carried out by qualified personnel according to the instructions in this manual; all the conditions prescribed and contained in the installation and use manual of the application in question are observed.

All other uses and modifications made to the device which are not authorised by the manufacturer are considered incorrect. Liability for injury or damage caused by the incorrect use of the device lies exclusively with the user.

INDEX

1.	APPLICATIONS AND FUNCTIONS PERFORMED BY THE SOFTWARE	7
2.	THE USER TERMINAL	8
2.1	TYPE AND OPERATION	8
2.2	LEDS	8
2.3	USE OF THE BUTTONS	9
3.	PLAN MANAGEMENT BETWEEN BOARDS	11
3.1	HOW TO ASSIGN THE PLAN ADDRESSES	11
4.	INSTALLATION OF DEFAULT VALUES	12
5.	LANGUAGE OPTION	12
6.	SELECTING THE UNIT OF MEASURE	12
7.	LIST OF INPUTS/OUTPUTS	13
7.1	CHILLER-ONLY UNIT - MACHINE TYPE "0"	13
7.2	CHILLER UNIT + HEAT PUMP - MACHINE TYPE "1"	14
7.3	CHILLER UNIT WITH FREECOOLING - MACHINE TYPE "2"	15
7.4	CHILLER-ONLY UNIT - MACHINE TYPE "3"	16
7.5	CHILLER UNIT + HEAT PUMP WITH GAS REVERSING - MACHINE TYPE "4"	17
7.6	CHILLER UNIT + HEAT PUMP WITH WATER REVERSING - MACHINE TYPE "5"	18
8.	LIST OF PARAMETERS	19
9.	SCREENS	24
9.1	LIST OF SCREENS	24
10.	EVD 200 ELECTRONIC EXPANSION VALVE	25
10.1	DRIVER PARAMETERS	25
10.2	SPECIAL "GO AHEAD" FUNCTION	28
11.	UNIT ON/OFF	29
12.	CONTROL	29
12.1	CONTROL SET-POINT	29
12.2	INLET TEMPERATURE CONTROL	30
12.3	OUTLET TEMPERATURE CONTROL	30
12.4	CONTROL OF WATER/WATER CHILLER ONLY UNITS	31
12.5	CONTROL OF WATER/WATER CHILLER UNIT WITH GAS REVERSING HEAT PUMP	31
12.6	CONTROL OF WATER/WATER CHILLER UNIT WITH WATER REVERSING HEAT PUMP	32
13.	TYPES OF CONTROLLED COMPRESSORS	33
13.1	STEPPED CAPACITY CONTROL	33
13.2	STEPPED CAPACITY CONTROL WITH CONTROL AT INLET	34
13.3	STEPPED CAPACITY CONTROL WITH CONTROL AT OUTLET	34
13.4	CONTINUOUS CAPACITY CONTROL	34
13.5	CONTINUOUS CAPACITY CONTROL WITH CONTROL AT OUTLET	35
IN THE INCREASING ZONE, TB MASK, COMES CONTROLLED EVERY "DERIVATIVE TIME" IF THE OUTLET TEMPERATURE IS CHANGED IN ORDER MORE THAN 0,2 °C. IF THIS IS TRUE THE COMPRESSOR REMAINS IN STAND-BY UNTIL THE NEW CONTROL. THIS MANAGEMENT CAN BE DISABLED WITH "DERIVATIVE TIME" EQUAL TO 0.		
14.	COMPRESSOR ROTATION	37
15.	STARTING A SINGLE COMPRESSOR	37
15.2	STARTING THE COMPRESSOR MOTOR	37
15.3	COMPRESSOR START RESTRICTIONS	37
16.	FORCED CAPACITY CONTROL	38
17.	SOLENOID-VALVE MANAGEMENT	39
18.	PUMP-DOWN	39
19.	CONDENSATION CONTROL	40
19.1	ON/OFF CONDENSER CONTROL LINKED TO COMPRESSOR OPERATION	40
19.2	ON/OFF CONDENSER CONTROL LINKED TO THE PRESSURE OR TEMPERATURE SENSOR	40
19.3	MODULATING CONDENSER CONTROL LINKED TO THE PRESSURE OR TEMPERATURE SENSOR	40
19.4	PREVENT FUNCTION	40
20.	DEFROSTING CONTROL FOR WATER/AIR MACHINES	41
20.1	TYPES OF DEFROSTING	41
20.2	TYPE OF END AND START DEFROST	41
20.3	DEFROSTING A CIRCUIT WITH TIME/TEMPERATURE CONTROL	41
20.4	DEFROSTING A CIRCUIT WITH TIME/PRESSURE SWITCHES CONTROL	41
20.5	OPERATION OF FANS DURING THE DEFROSTING STAGE	41

21.	FREE COOLING CONTROL	42
21.2	FREE COOLING ACTIVATION CONDITION	42
21.3	FREE COOLING THERMOSTAT	43
21.4	FREE COOLING DISABLING CONDITIONS	44
21.5	FREE COOLING ON/OFF VALVE	44
21.6	FREE COOLING ON/OFF VALVE WITH STEPPED CONDENSATION	45
21.7	FREE COOLING ON/OFF VALVE WITH INVERTER CONTROLLED CONDENSATION	45
21.8	0-10 VOLT FREE COOLING ON/OFF VALVE	46
21.9	0-10 VOLT FREE COOLING ON/OFF VALVE WITH STEPPED CONDENSATION	46
21.10	0-10 VOLT FREE COOLING VALVE WITH INVERTER CONTROLLED CONDENSATION	47
22.	CONTROL ALGORITHM FOR BITZER SCREW COMPRESSORS	48
22.1	PROTECTION	49
22.2	START UP PROCEDURE	50
22.3	CAPACITY CONTROL	50
23.	ALARMS	51
23.1	SERIOUS ALARMS	51
23.2	CIRCUIT ALARMS	51
23.3	WARNING ONLY ALARMS	51
23.4	PRESSURE DIFFERENTIAL ALARM MANAGEMENT	51
23.5	ANTIFREEZE CONTROL	51
23.6	PCO ALARMS TABLE	52
23.7	DRIVER CARD ALARMS	53
24.	ALARM LOG	54
24.1	STANDARD LOG	54
24.2	ADVANCED LOG	54
24.3	LIST OF ALARM LOG CODES	54
25.	SUPERVISOR	55

1. Applications and functions performed by the software

Type of control unit

AIR / WATER CHILLER

- Chiller only
- Chiller + Heat pump
- Chiller + Freecooling

WATER / WATER CHILLER

- Chiller only
- Chiller + Heat pump with gas reversing
- Chiller + Heat pump with water reversing

Type of control

Proportional or proportional + integral control on the evaporator water inlet temperature probe.
Time control of the neutral zone on the evaporator water outlet temperature probe.

Types of compressors

Screw compressors with 4 capacity control steps
Screw compressors with continuous duty capacity control.
Bitzer screw compressors

Maximum number of compressors

From 1 to 4 with a maximum of 4 capacity control steps (1 compressor for every pCO*)
From 1 to 4 with continuous duty capacity control. (1 compressor for every pCO*)

Compressor duty call rotation

Rotation of all compressors to FIFO logic for stepped and continuous duty capacity control.

Condensation

Condensation can be performed according to temperature, pressure or ON/OFF
Fan management in stepped mode or with 0/10 Volt proportional signal

Type of defrosting

Overall defrosting of all pCO units connected to network: Independent/Simultaneous/Separate

Safety devices for all refrigerating circuits

High pressure (pressure switch/transducer)
Low pressure (pressure switch/transducer)
Oil/Oil Level differential pressure switch
Compressor thermal cutout
Thermal cutout for condensation fan
High delivery temperature to compressor
Pressure differential alarm
Antifreeze alarm
Low superheat alarm (only with EVD driver enabled)

System Safety devices

Serious alarm input (shuts down entire unit)
Flow-switch input for evaporator/condenser (shuts down entire unit)
Pump thermal cutout input (shuts down entire unit)
Remote ON/OFF input.
Check electronic expansion valve driver operating status (only with EVD driver enabled)

Other functions

Alarms logging
Built-in terminal management (on pCO²-pCO³ only)
Management of ratiometric probes for pressure control (on pCO¹-pCO³ only)
EVD driver for piloting the EXV valve.
Multi-language management.

Accessories

Supervision with serial card RS485 (CAREL or MODBUS protocol)
Supervision with LON serial board

Compatible hardware

pCO¹ Medium, pCO² Medium and pCO² Medium built-in, pCO³ Medium and pCO³ Medium built-in.

2. The user terminal

2.1 Type and operation

Three different types of user terminal can be connected:

1. PGD0/semigraphic/6 buttons/4 rows - 20 columns/connection via telephone cable
2. LCD/15 buttons/4 rows - 20 columns/connection via telephone cable
3. Built-in display/6 buttons/4 rows - 20 columns (only on pCO² - pCO³ board)

The user terminal, whichever is used, can perform all the operations allowed by the application program installed. The user terminal displays the operating conditions of the unit.

The terminal can be used to modify all the unit operating parameters, in real time.

The user terminal is not required for the correct operation of the unit.

2.2 LEDs

2.2.1 PGD0 terminal with 6 buttons

LEDs	Colour	Description
[Alarm] button (Alarm)	Red	On – One or more alarm conditions have occurred
PRG button	Yellow	On – Unit on Flashing – Unit off from supervisor or digital input

All the LEDs not described and located underneath the remaining 4 buttons indicate that the instrument is powered.

Together with the backlighting of the display, these will be switched off if no button is pressed on the keypad for 5 minutes.

2.2.2 LCD terminal with 15 buttons

Each button has a green LED indicating the specific group of parameters selected during the operations to display/modify the operating parameters.

The silicone rubber buttons have three different coloured LEDs, whose meaning is specified in the following table:

LEDs	Colour	Description
[On/Off] button	Green	On – Unit on Flashing – Unit off from supervisor or digital input
[Alarm] button	Red	On – One or more alarm conditions have occurred
[Enter] button	Yellow	On – Instrument correctly powered

2.2.3 Built-In terminal with 6 buttons

Given the number of buttons and LEDs available, these have general meanings, as described below:

LEDs	Colour	Description
[Alarm] button (Alarm)	Red	On – One or more alarm conditions have occurred
[Enter] button (Enter)	Yellow	On – Unit on Flashing – Unit off from supervisor or digital input
[Prg] button	Green	On – Displaying/modifying the operating parameters
[Esc] button	Green	On – Main menu parameters displayed

2.3 Use of the buttons

2.3.1 PGD0 terminal with 6 buttons

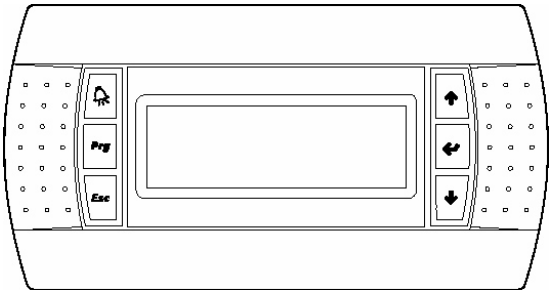











ALARM	UP
PRG	ENTER
ESC	DOWN

Button	Description
ALARM	displays the alarms, mutes the buzzer and deletes the active alarms
UP	if the cursor is in the home position (top left corner), scrolls up the screens in the same group; if the cursor is in a setting field, increases the value
DOWN	if the cursor is in the home position (top left corner), scrolls down the screens in the same group; if the cursor is in a setting field, decreases the value
ENTER	used to move the cursor from the home position (top left corner) to the setting fields, in the setting fields confirms the set value and moves to the next parameter
PRG	accesses the menu for selecting the group of parameters to be displayed/modified (access to the parameters is confirmed by pressing the [Enter] button)
PRG + ENTER	In pLAN applications with more than one board connected in the network and a shared user terminal, switches the user terminal between the different units to display/modify the parameters
ESC + ENTER	Pressed at the same time for 20 seconds access the screen for switching the unit On/Off

2.3.2 LCD terminal with 15 buttons



Button	Description
	MENU From any point of the user interface (with the exception of the manufacturer group of parameters) returns to the Main menu screen (M0) displaying the unit status, readings of the control probes and operating mode. In the group of manufacturer parameters, organised into nested sub-groups, returns to screen for selecting the parameters.
	MAINTENANCE Goes to the first screen of Maintenance parameters (A0) The maintenance parameters are used to check the operating status of devices and the probes, control maintenance, calibrate the readings and run manual operations
	PRINTER Temporary display of the pLAN address of the current board
	INPUTS AND OUTPUTS Goes to the first screen of I/O parameters (I0) The I/O parameters display the status of the inputs and the outputs on the board
	CLOCK Goes to the first screen of Clock parameters (K0) The Clock parameters are used to display/set the operating parameters for the clock board and activate the time bands

Button		Description
	SET POINT	Goes to the first screen of Set point parameters (S0). The Set point parameters are used to display/modify the unit working set point within the limits defined in the configuration
	PROGRAM	Goes to the screen for entering the user password (P0) The user parameters are used to modify the unit operating mode
	MENU+PROG	Goes to the screen for entering the manufacturer password (Z0) The manufacturer parameters are used to configure the unit in terms of the number and type of devices connected, enable specific accessories or special functions
	INFO	In pLAN applications with more than one board connected in the network and a shared user terminal, switches the user terminal between the different units to display/modify the parameters
	RED	With the unit off, if the chiller+heat pump configuration is featured, enables heating operation
	BLUE	With the unit off, if the chiller+heat pump configuration is featured, enables cooling operation

Silicon rubber buttons



Button		Description
1	ON/OFF	switches the unit on/off
2	ALARM	displays the alarms, mutes the buzzer and deletes the active alarms
3	UP ARROW	if the cursor is in the home position (top left corner), scrolls up the screens in the same group; if the cursor is in a setting field, increases the value
4	DOWN ARROW	if the cursor is in the home position (top left corner), scrolls down the screens in the same group; if the cursor is in a setting field, decreases the value
5	ENTER	used to move the cursor from the home position (top left corner) to the setting fields, in the setting fields confirms the set value and moves to the next parameter

2.3.3 Built-in 6 button terminal



ALARM	PRG	ESC
-------	-----	-----

DOWN	UP	ENTER
------	----	-------

Button	Description
ALARM	displays the alarms, mutes the buzzer and deletes the active alarms
UP	if the cursor is in the home position (top left corner), scrolls up the screens in the same group; if the cursor is in a setting field, increases the value
DOWN	if the cursor is in the home position (top left corner), scrolls down the screens in the same group; if the cursor is in a setting field, decreases the value
ENTER	used to move the cursor from the home position (top left corner) to the setting fields, in the setting fields confirms the set value and moves to the next parameter
PRG	accesses the menu for selecting the group of parameters to be displayed/modified (access to the parameters is confirmed by pressing the [Enter] button)
PRG + ENTER	Temporary display of the board pLAN serial address
ESC + ENTER	Pressed at the same time for 20 seconds access the screen for switching the unit On/Off

3. pLAN management between boards

The pLAN network identifies a physical connection between the cards (pCO¹, pCO², pCO³) and the external terminals.

pLAN=physical Local Area Network. The purpose of the pLAN network connection between the cards is to exchange variables among the cards with a logic decided by the program, in order to make the cards work together functionally.

The variables exchanged among the cards have already been established by the program, and likewise their direction of origin and destination. Therefore, the user does not have to set them, but has only make the electrical connections.

The following is a layout of the pLAN network

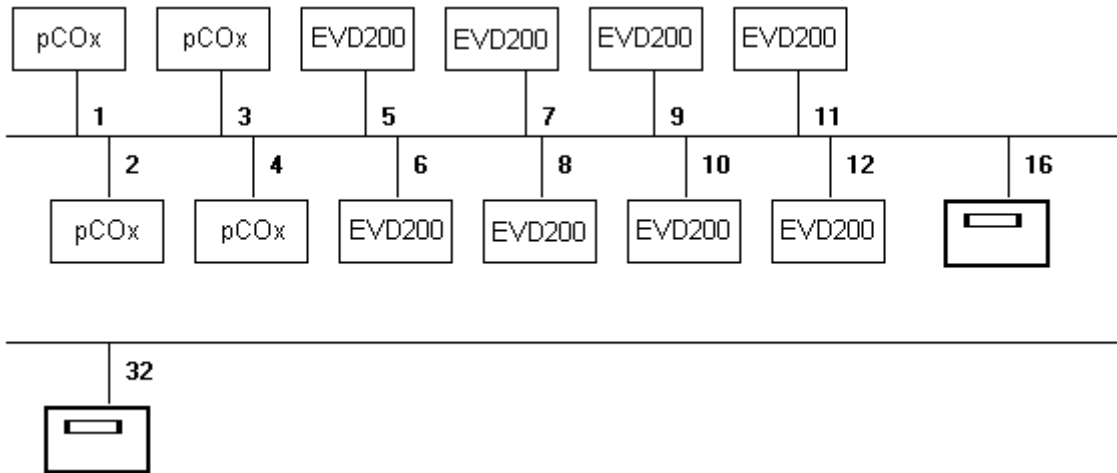

The main MO mask shows the address of the connected card in the bottom left-hand corner. With the terminal showing 32, it is possible to view all the boards without the need for other terminals.

3.1 How to assign the pLAN addresses

The pLAN addresses have to be unequivocal and correspond with the diagram shown above.

There are various means of assigning the pLAN address

3.1.1 PGD0 Terminal

To direct (default level is 32) a PGD0 terminal, one has to:

1. Provide the terminal with voltage
2. Press the Up + Down + ENTER buttons until a "display address setting" appears
3. Type in the numerical pLAN address with the Up and Down buttons, then confirm by pressing Enter
4. The "No link" screen appears
5. If the "NO Link" screen does not appear, press Up + Down + ENTER again
6. Once the "display address setting" screen appears, press Enter 3 times

Once the "adr Priv/shard" screen appears, set the correct levels and confirm by typing in "YES"

3.1.2 pCO¹- pCO³ addressing

Here is a description of the operations necessary for addressing pLAN from the pCO¹, pCO³ cards.

1. Power down the pCO¹ card and connect a LCD 4x20 / PGD0 terminal with the pLAN "0" address.
2. Power up the pCO¹ card, by holding down the Alarm + Up keys until a mask appears
3. When the "pLAN Address" screen is shown, perform the indicated operations, i.e. insert the numeric (1,2,3 or 4...) pLAN address with the Up and Down keys and then confirm by pressing Enter.
4. Power down the pCO^{*} card.
5. If necessary, assign the correct pLAN address to the external terminal if specified.
6. Power up the pCO^{*} card.

3.1.3 pCO² addressing, PCOI/PCOT terminals and EVD-200 valve driver

The pLAN addresses on these are set with binary logic, changing the position of a group of dip-switches located at the back of the pCOI / PCOT terminals, on the pCO² cards and inside the EVD-200 electronic valve drivers, with all the devices compulsorily powered down. For further information, consult the specific manual for the device.

In all the other screens in the program, to display the address of the board that is currently connected, press the printer button or Enter+Prg, depending on the terminal used.

7. List of inputs/outputs

Inputs and outputs are listed below based on unit type. A number has been associated with each type of machine. This number is the program's main parameter because it identifies the inputs and outputs configuration. Using this list of inputs and outputs, select the number you require from the numbers associated in the program configuration screens.

AIR/WATER UNIT WITH MAX. 4 SCREW COMPRESSORS (UP TO 4 CAPACITY STAGES PER COMPRESSOR)

7.1 CHILLER-ONLY UNIT - MACHINE TYPE "0"

DIGITAL INPUTS

N°	pCO ₂ / pCO ₃ MEDIUM	
	Master (Address 1)	Slave (addresses 2/3/4)
ID 1	Serious Alarm	Serious Alarm
ID 2	Evaporator Flow-switch	Evaporator Flow-switch
ID 3	Remote ON/OFF	Remote ON/OFF
ID 4	Pump Thermal cutout	
ID 5	Low Pressure 2 Pressure-switch	Low Pressure 2 Pressure-switch
ID 6	Differential / Oil Level	Differential / Oil Level
ID 7	Phase monitor	Phase monitor
ID 8	Double Set-point	
ID 9	Fan 1 Thermal cutout	Fan 1 Thermal cutout
ID10	Fan 2 Thermal cutout	Fan 2 Thermal cutout
ID11	High Pressure Pressure-switch	High Pressure Pressure-switch
ID12	Compressor Thermal cutout	Compressor Thermal cutout
ID13		
ID14		

pCO ₁ MEDIUM	
Master (Address 1)	Slave (addresses 2/3/4)
Serious Alarm	Serious Alarm
Evaporator Flow-switch	Evaporator Flow-switch
Remote ON/OFF	Remote ON/OFF
Pump Thermal cutout	
Low Pressure 2 Pressure-switch	Low Pressure 2 Pressure-switch
Differential / Oil Level	Differential / Oil Level
Phase monitor	Phase monitor
Double Set-point	
Fan 1 Thermal cutout	Fan 1 Thermal cutout
Fan 2 Thermal cutout	Fan 2 Thermal cutout
High Pressure Pressure-switch	High Pressure Pressure-switch
Compressor Thermal cutout	Compressor Thermal cutout

ANALOGUE INPUTS

N°	pCO ₂ / pCO ₃ MEDIUM	
	Master (Address 1)	Slave (addresses 2/3/4)
B1	Water temperature at Evaporator Inlet ⁽¹⁾	
B2	Water temp. at Evaporator Outlet ⁽¹⁾	Water temp. at Evaporator Outlet ⁽¹⁾
B3		
B4	Outlet Temperature ⁽⁴⁾	Outlet Temperature ⁽⁴⁾
B5	Condenser Temperature ⁽¹⁾	Condenser temperature
B6	Voltage/Current/Ext. Set-point ⁽⁵⁾	Voltage / Current ⁽⁵⁾
B7	High Pressure ⁽²⁾	High Pressure ⁽²⁾
B8	Low Pressure ⁽²⁾	Low Pressure ⁽²⁾

pCO ₁ MEDIUM	
Master (Address 1)	Slave (addresses 2/3/4)
High Pressure ⁽³⁾	High Pressure ⁽³⁾
Low Pressure ⁽³⁾	Low Pressure ⁽³⁾
Voltage/Current/Ext. Set point ⁽⁶⁾	Voltage / Current ⁽⁶⁾
Outlet Temperature ⁽²⁾	Outlet Temperature ⁽²⁾
Water temp. at Evaporator Inlet ⁽¹⁾	
Water temp. at Evaporator Outlet ⁽¹⁾	Water temp. at Evaporator Outlet ⁽¹⁾
Condenser Temperature ⁽¹⁾	Condenser Temperature ⁽¹⁾

(1) NTC (2) 4-20 mA (3) 4-20mA/0-5V (4) NTC-HT/4-20mA/NTC/PT1000 (5) 4-20mA/0-1V/0-10V (6) 4-20mA/0-1V (7) NTC-HT/4-20mA/NTC

DIGITAL OUTPUTS

N°	pCO ₂ / pCO ₃ MEDIUM			
	Master (Address 1)		Slave (addresses 2/3/4)	
	Generic	Bitzer	Generic	Bitzer
NO1	Relay 1	CR1	Relay 1	CR1
NO2	Relay 2	CR2	Relay 2	CR2
NO3	Circulation Pump			
NO 4	Fan 1		Fan 1	
NO 5	Liquid Solenoid		Liquid Solenoid	
NO 6	Antifreeze Heater		Antifreeze Heater	
NO 7	Relay 3	CR3	Relay 3	CR3
NO 8	General Alarm		General Alarm	
NO 9	Liquid inj./Econ/Oil Cooler		Liquid inj./Econ/Oil Cooler	
NO10	Line Contactor	PW1	Line Contactor	PW1
NO11	Triangle Contactor	PW2	Triangle Contactor	PW2
NO12	Star Contactor	CR4	Star Contactor	CR4
NO13	Fan 2		Fan 2	

pCO ₁ MEDIUM			
Master (Address 1)		Slave (addresses 2/3/4)	
Generic	Bitzer	Generic	Bitzer
Relay 1	CR1	Relay 1	CR1
Relay 2	CR2	Relay 2	CR2
Circulation Pump			
Fan 1		Fan 1	
Liquid Solenoid		Liquid Solenoid	
Antifreeze Heater		Antifreeze Heater	
Relay 3	CR3	Relay 3	CR3
General Alarm		General Alarm	
Liquid inj./Econ/Oil Cooler		Liquid inj./Econ/Oil Cooler	
Line Contactor	PW1	Line Contactor	PW1
Triangle Contactor	PW2	Triangle Contactor	PW2
Star Contactor	CR4	Star Contactor	CR4
Fan 2		Fan 2	

ANALOGUE OUTPUTS

N°	pCO ₂ / pCO ₃ MEDIUM	
	Master (Address 1)	Slave (addresses 2/3/4)
Y1	Speed Controller	Speed Controller
Y2		
Y3		
Y4		

pCO ₁ MEDIUM	
Master (Address 1)	Slave (addresses 2/3/4)
Speed Controller	Speed Controller

7.2 CHILLER UNIT + HEAT PUMP - MACHINE TYPE "1"

DIGITAL INPUTS

N°	pCO2 / pCO3 MEDIUM	
	Master (Address 1)	Slave (addresses 2/3/4)
ID 1	Serious Alarm	Serious Alarm
ID 2	Evaporator Flow-switch	Evaporator Flow-switch
ID 3	Remote ON/OFF	Remote ON/OFF
ID 4	Pump Thermal cutout	
ID 5	Low Pressure 2 Pressure-switch	Low Pressure 2 Pressure-switch
ID 6	Differential / Oil Level	Differential / Oil Level
ID 7	Phase monitor	Phase monitor
ID 8	Double Set-point	
ID 9	Fan 1 Thermal cutout	Fan 1 Thermal cutout
ID10	Summer / Winter	
ID11	High Pressure Pressure-switch	High Pressure Pressure-switch
ID12	Compressor Thermal cutout	Compressor Thermal Cutouts
ID13		
ID14		

pCO1 MEDIUM	
Master (Address 1)	Slave (addresses 2/3/4)
Serious Alarm	Serious Alarm
Evaporator Flow-switch	Evaporator Flow-switch
Remote ON/OFF	Remote ON/OFF
Pump Thermal cutout	
Low Pressure 2 Pressure-switch	Low Pressure 2 Pressure-switch
Differential / Oil Level	Differential / Oil Level
Phase monitor	Phase monitor
Double Set-point	
Fan 1 Thermal cutout	Fan 1 Thermal cutout
Summer / Winter	
High Pressure Pressure-switch	High Pressure Pressure-switch
Compressor Thermal cutout	Compressor Thermal Cutouts

ANALOGUE INPUTS

N°	pCO2 / pCO3 MEDIUM	
	Master (Address 1)	Slave (addresses 2/3/4)
B1	Water temperature at Evaporator Inlet ⁽¹⁾	
B2	Water temperature at Evaporator Outlet ⁽¹⁾	Water temperature at Evaporator Outlet ⁽¹⁾
B3		
B4	Outlet Temperature ⁽⁴⁾	Outlet Temperature ⁽⁴⁾
B5	Condenser temperature	Condenser temperature
B6	Voltage / Current / External Set-point ⁽⁵⁾	Voltage / Current ⁽⁵⁾
B7	High Pressure ⁽²⁾	High Pressure ⁽²⁾
B8	Low Pressure ⁽²⁾	Low Pressure ⁽²⁾

pCO1 MEDIUM	
Master (Address 1)	Slave (addresses 2/3/4)
High Pressure ⁽³⁾	High Pressure ⁽³⁾
Low Pressure ⁽³⁾	Low Pressure ⁽³⁾
Voltage / Current / External Set-point ⁽⁶⁾	Voltage / Current ⁽⁶⁾
Outlet Temperature ⁽⁷⁾	Outlet Temperature ⁽⁷⁾
Water temperature at Evaporator Inlet ⁽¹⁾	
Water temperature at Evaporator Outlet ⁽¹⁾	Water temperature at Evaporator Outlet ⁽¹⁾
Condenser temperature	Condenser temperature

(1) NTC (2) 4-20 mA (3) 4-20mA/0-5V (4) NTC-HT/4-20mA/NTC/PT1000 (5) 4-20mA/0-1V/0-10V (6) 4-20mA/0-1V (7) NTC-HT/4-20mA/NTC

DIGITAL OUTPUTS

N°	pCO2 / pCO3 MEDIUM			
	Master (Address 1)		Slave (addresses 2/3/4)	
	Generic	Bitzer	Generic	Bitzer
NO1	Relay 1	CR1	Relay 1	CR1
NO2	Relay 2	CR2	Relay 2	CR2
NO3	Circulation Pump			
NO 4	Fan 1		Fan 1	
NO 5	Liquid Solenoid		Liquid Solenoid	
NO 6	Antifreeze Heater		Antifreeze Heater	
NO 7	Relay 3	CR3	Relay 3	CR3
NO 8	General Alarm		General Alarm	
NO 9	Liquid inj./Econ/Oil Cooler		Liquid inj./Econ/Oil Cooler	
NO10	Line Contactor	PW1	Line Contactor	PW1
NO11	Triangle Contactor	PW2	Triangle Contactor	PW2
NO12	Star Contactor	CR4	Star Contactor	CR4
NO13	4-way Valve		4-way Valve	

pCO1 MEDIUM			
Master (Address 1)		Slave (addresses 2/3/4)	
Generic	Bitzer	Generic	Bitzer
Relay 1	CR1	Relay 1	CR1
Relay 2	CR2	Relay 2	CR2
Circulation Pump			
Fan 1		Fan 1	
Liquid Solenoid		Liquid Solenoid	
Antifreeze Heater		Antifreeze Heater	
Relay 3	CR3	Relay 3	CR3
General Alarm		General Alarm	
Liquid inj./Econ/Oil Cooler		Liquid inj./Econ/Oil Cooler	
Line Contactor	PW1	Line Contactor	PW1
Triangle Contactor	PW2	Triangle Contactor	PW2
Star Contactor	CR4	Star Contactor	CR4
4-way Valve		4-way Valve	

ANALOGUE OUTPUTS

N°	pCO2 / pCO3 MEDIUM	
	Master (Address 1)	Slave (addresses 2/3/4)
Y1		
Y2	Speed Controller	Speed Controller
Y3		
Y4		

pCO1 MEDIUM	
Master (Address 1)	Slave (addresses 2/3/4)
Speed Controller	Speed Controller

7.3 CHILLER UNIT WITH FREECOOLING - MACHINE TYPE "2"

DIGITAL INPUTS

N°	pCO2 / pCO3 MEDIUM	
	Master (Address 1)	Slave (addresses 2/3/4)
ID 1	Serious Alarm	Serious Alarm
ID 2	Evaporator Flow-switch	Evaporator Flow-switch
ID 3	Remote ON/OFF	Remote ON/OFF
ID 4	Pump Thermal cutout	
ID 5	Low Pressure 2 Pressure-switch	Low Pressure 2 Pressure-switch
ID 6	Differential / Oil Level	Differential / Oil Level
ID 7	Phase monitor	Phase monitor
ID 8	Double Set-point	
ID 9	Fan 1 Thermal cutout	Fan 1 Thermal cutout
ID10	Fan 2 Thermal cutout	Fan 2 Thermal cutout
ID11	High Pressure Pressure-switch	High Pressure Pressure-switch
ID12	Compressor Thermal cutout	Compressor Thermal cutout
ID13		
ID14		

pCO1 MEDIUM	
Master (Address 1)	Slave (addresses 2/3/4)
Serious Alarm	Serious Alarm
Evaporator Flow-switch	Evaporator Flow-switch
Remote ON/OFF	Remote ON/OFF
Pump Thermal cutout	
Low Pressure 2 Pressure-switch	Low Pressure 2 Pressure-switch
Differential / Oil Level	Differential / Oil Level
Phase monitor	Phase monitor
Double Set-point	
Fan 1 Thermal cutout	Fan 1 Thermal cutout
Fan 2 Thermal cutout	Fan 2 Thermal cutout
High Pressure Pressure-switch	High Pressure Pressure-switch
Compressor Thermal cutout	Compressor Thermal cutout

ANALOGUE INPUTS

N°	pCO2 / pCO3 MEDIUM	
	Master (Address 1)	Slave (addresses 2/3/4)
B1	Water temperature at Evaporator Inlet ⁽¹⁾	
B2	Water temperature at Evaporator Outlet ⁽¹⁾	Water temperature at Evaporator Outlet ⁽¹⁾
B3	Water temperature at Freecooling Inlet ⁽¹⁾	
B4	Outlet Temperature ⁽⁴⁾	Outlet Temperature ⁽⁴⁾
B5	Outside Air Temperature ⁽¹⁾	
B6	Voltage / Current / External Set-point ⁽⁵⁾	Voltage / Current ⁽⁵⁾
B7	High Pressure ⁽²⁾	High Pressure ⁽²⁾
B8	Low Pressure ⁽²⁾	Low Pressure ⁽²⁾

pCO1 MEDIUM	
Master (Address 1)	Slave (addresses 2/3/4)
High Pressure ⁽³⁾	High Pressure ⁽³⁾
Low Pressure ⁽³⁾	Low Pressure ⁽³⁾
Voltage / Current / External Set-point ⁽⁶⁾	Voltage / Current ⁽⁶⁾
Outlet Temperature ⁽⁷⁾	Outlet Temperature ⁽⁷⁾
Water temperature at Evaporator Inlet ⁽¹⁾	
Water temperature at Evaporator Outlet ⁽¹⁾	Water temperature at Evaporator Outlet ⁽¹⁾
Outside Air Temperature ⁽¹⁾	
Water temperature at Freecooling Inlet ⁽¹⁾	

(1) NTC (2) 4-20 mA (3) 4-20mA/0-5V (4) NTC-HT/4-20mA/NTC/PT1000 (5) 4-20mA/0-1V/0-10V (6) 4-20mA/0-1V (7) NTC-HT/4-20mA/NTC

DIGITAL OUTPUTS

N°	pCO2 / pCO3 MEDIUM			
	Master (Address 1)		Slave (addresses 2/3/4)	
	Generic	Bitzer	Generic	Bitzer
NO1	Relay 1	CR1	Relay 1	CR1
NO2	Relay 2	CR2	Relay 2	CR2
NO3	Circulation Pump			
NO 4	Fan 1		Fan 1	
NO 5	Liquid Solenoid		Liquid Solenoid	
NO 6	Antifreeze Heater		Antifreeze Heater	
NO 7	Relay 3	CR3	Relay 3	CR3
NO 8	General Alarm		General Alarm	
NO 9	Liquid inj./Econ/Oil cooler		Liquid inj./Econ/Oil cooler	
NO10	Line Contactor	PW1	Line Contactor	PW1
NO11	Triangle Contactor	PW2	Triangle Contactor	PW2
NO12	Star Contactor	CR4	Star Contactor	CR4
NO13	Freecooling ON/OFF Valve			

pCO1 MEDIUM			
Master (Address 1)		Slave (addresses 2/3/4)	
Generic	Bitzer	Generic	Bitzer
Relay 1	CR1	Relay 1	CR1
Relay 2	CR2	Relay 2	CR2
Circulation Pump			
Fan 1		Fan 1	
Liquid Solenoid		Liquid Solenoid	
Antifreeze Heater		Antifreeze Heater	
Relay 3	CR3	Relay 3	CR3
General Alarm		General Alarm	
Liquid inj./Econ/Oil cooler		Liquid inj./Econ/Oil cooler	
Line Contactor	PW1	Line Contactor	PW1
Triangle Contactor	PW2	Triangle Contactor	PW2
Star Contactor	CR4	Star Contactor	CR4
Freecooling ON/OFF Valve			

ANALOGUE OUTPUTS

N°	pCO2 / pCO3 MEDIUM	
	Master (Address 1)	Slave (addresses 2/3/4)
Y1	Speed Controller	Speed Controller
Y2	3-way Freecooling Valve	
Y3		
Y4		

pCO1 MEDIUM	
Master (Address 1)	Slave (addresses 2/3/4)
Speed Controller	Speed Controller
3-way Freecooling Valve	

WATER/WATER UNIT WITH MAX. 4 SCREW COMPRESSORS (UP TO 4 CAPACITY STAGES PER COMPRESSOR)**7.4 CHILLER-ONLY UNIT - MACHINE TYPE "3"****DIGITAL INPUTS**

N°	pCO2 / pCO3 MEDIUM	
	Master (Address 1)	Slave (addresses 2/3/4)
ID 1	Serious Alarm	Serious Alarm
ID 2	Evaporator Flow-switch	Evaporator Flow-switch
ID 3	Remote ON/OFF	Remote ON/OFF
ID 4	Evaporator Pump thermal Cutout	
ID 5	Low Pressure 2 Pressure-switch	Low Pressure 2 Pressure-switch
ID 6	Differential / Oil Level	Differential / Oil Level
ID 7	Phase monitor	Phase monitor
ID 8	Double Set-point	
ID 9	Evaporator Flow-switch (Enabable)	Evaporator Flow-switch (Enabable)
ID10	Condenser Pump thermal Cutout	
ID11	High Pressure Pressure-switch	High Pressure Pressure-switch
ID12	Compressor Thermal cutout	Compressor Thermal cutout
ID13		
ID14		

pCO1 MEDIUM	
Master (Address 1)	Slave (addresses 2/3/4)
Serious Alarm	Serious Alarm
Evaporator Flow-switch	Evaporator Flow-switch
Remote ON/OFF	Remote ON/OFF
Evaporator Pump thermal Cutout	
Low Pressure 2 Pressure-switch	Low Pressure 2 Pressure-switch
Differential / Oil Level	Differential / Oil Level
Phase monitor	Phase monitor
Double Set-point	
Evaporator Flow-switch (Enabable)	Evaporator Flow-switch (Enabable)
Condenser Pump thermal Cutout	
High Pressure Pressure-switch	High Pressure Pressure-switch
Compressor Thermal cutout	Compressor Thermal cutout

ANALOGUE INPUTS

N°	pCO2 / pCO3 MEDIUM	
	Master (Address 1)	Slave (addresses 2/3/4)
B1	Water temperature at Evaporator Inlet ⁽¹⁾	
B2	Water temperature at Evaporator Outlet ⁽¹⁾	Water temperature at Evaporator Outlet ⁽¹⁾
B3	Water temperature at Condenser Outlet ⁽¹⁾	Water temperature at Condenser Outlet ⁽¹⁾
B4	Outlet Temperature ⁽⁴⁾	Outlet Temperature ⁽⁴⁾
B5	Water temperature at Condenser Inlet ⁽¹⁾	
B6	Voltage / Current / External Set-point ⁽⁵⁾	Voltage / Current ⁽⁵⁾
B7	High Pressure ⁽²⁾	High Pressure ⁽²⁾
B8	Low Pressure ⁽²⁾	Low Pressure ⁽²⁾

pCO1 MEDIUM	
Master (Address 1)	Slave (addresses 2/3/4)
High Pressure ⁽³⁾	High Pressure ⁽³⁾
Low Pressure ⁽³⁾	Low Pressure ⁽³⁾
Voltage / Current / External Set-point ⁽⁶⁾	Voltage / Current ⁽⁶⁾
Outlet Temperature ⁽⁷⁾	Outlet Temperature ⁽⁷⁾
Water temperature at Evaporator Inlet ⁽¹⁾	
Water temperature at Evaporator Outlet ⁽¹⁾	Water temperature at Evaporator Outlet ⁽¹⁾
Water temperature at Condenser Inlet ⁽¹⁾	
Water temperature at Condenser Outlet ⁽¹⁾	Water temperature at Condenser Outlet ⁽¹⁾

(1) NTC (2) 4-20 mA (3) 4-20mA/0-5V (4) NTC-HT/4-20mA/NTC/PT1000 (5) 4-20mA/0-1V/0-10V (6) 4-20mA/0-1V (7) NTC-HT/4-20mA/NTC

DIGITAL OUTPUTS

N°	pCO2 / pCO3 MEDIUM			
	Master (Address 1)		Slave (addresses 2/3/4)	
	Generic	Bitzer	Generic	Bitzer
NO1	Relay 1	CR1	Relay 1	CR1
NO2	Relay 2	CR2	Relay 2	CR2
NO3	Evaporator Pump			
NO 4	Condenser Pump			
NO 5	Liquid Solenoid		Liquid Solenoid	
NO 6	Antifreeze Heater		Antifreeze Heater	
NO 7	Relay 3	CR3	Relay 3	CR3
NO 8	General Alarm		General Alarm	
NO 9	Liquid inj./Econ/Oil Cooler		Liquid inj./Econ/Oil Cooler	
NO10	Line Contactor	PW1	Line Contactor	PW1
NO11	Triangle Contactor	PW2	Triangle Contactor	PW2
NO12	Star Contactor	CR4	Star Contactor	CR4
NO13				

pCO1 MEDIUM			
Master (Address 1)		Slave (addresses 2/3/4)	
Generic	Bitzer	Generic	Bitzer
Relay 1	CR1	Relay 1	CR1
Relay 2	CR2	Relay 2	CR2
Evaporator Pump			
Condenser Pump			
Liquid Solenoid		Liquid Solenoid	
Antifreeze Heater		Antifreeze Heater	
Relay 3	CR3	Relay 3	CR3
General Alarm		General Alarm	
Liquid inj./Econ/Oil Cooler		Liquid inj./Econ/Oil Cooler	
Line Contactor	PW1	Line Contactor	PW1
Triangle Contactor	PW2	Triangle Contactor	PW2
Star Contactor	CR4	Star Contactor	CR4

ANALOGUE OUTPUTS

N°	pCO2 / pCO3 MEDIUM	
	Master (Address 1)	Slave (addresses 2/3/4)
Y1		
Y2		
Y3		
Y4		

pCO1 MEDIUM	
Master (Address 1)	Slave (addresses 2/3/4)

7.5 CHILLER UNIT + HEAT PUMP WITH GAS REVERSING - MACHINE TYPE "4"

DIGITAL INPUTS

N°	pCO2 / pCO3 MEDIUM	
	Master (Address 1)	Slave (addresses 2/3/4)
ID 1	Serious Alarm	Serious Alarm
ID 2	Evaporator Flow-switch	Evaporator Flow-switch
ID 3	remote ON/OFF	
ID 4	Evaporator Pump thermal Cutout	
ID 5	Low Pressure Pressure-switch	Low Pressure Pressure-switch
ID 6	Oil differential / Oil Level	Oil differential / Oil Level
ID 7	Phase monitor	Phase monitor
ID 8	Double Set-point	
ID 9	Evaporator Flow-switch (Enable)	Evaporator Flow-switch (Enable)
ID10	Summer / Winter	
ID11	High pressure pressure-switch	High pressure pressure-switch
ID12	Compressor Thermal cutout	Compressor Thermal cutout
ID13		
ID14		

pCO1 MEDIUM	
Master (Address 1)	Slave (addresses 2/3/4)
Serious Alarm	Serious Alarm
Evaporator Flow-switch	Evaporator Flow-switch
remote ON/OFF	
Evaporator Pump thermal Cutout	
Low Pressure Pressure-switch	Low Pressure Pressure-switch
Oil differential / Oil Level	Oil differential / Oil Level
Phase monitor	Phase monitor
Double Set-point	
Evaporator Flow-switch (Enable)	Evaporator Flow-switch (Enable)
Summer / Winter	
High pressure pressure-switch	High pressure pressure-switch
Compressor Thermal cutout	Compressor Thermal cutout

ANALOGUE INPUTS

N°	pCO2 / pCO3 MEDIUM	
	Master (Address 1)	Slave (addresses 2/3/4)
B1	Water temperature at Evaporator Inlet ⁽¹⁾	
B2	Water temperature at Evaporator Outlet ⁽¹⁾	Water temperature at Evaporator Outlet ⁽¹⁾
B3	Water temperature at Condenser Outlet ⁽¹⁾	Water temperature at Condenser Outlet ⁽¹⁾
B4	Outlet Temperature ⁽⁴⁾	Outlet Temperature ⁽⁴⁾
B5	Water temperature at Condenser Inlet ⁽¹⁾	
B6	Voltage / Current / External Set-point ⁽⁵⁾	Voltage / Current ⁽⁵⁾
B7	High Pressure ⁽²⁾	High Pressure ⁽²⁾
B8	Low Pressure ⁽²⁾	Low Pressure ⁽²⁾

pCO1 MEDIUM	
Master (Address 1)	Slave (addresses 2/3/4)
High Pressure ⁽³⁾	High Pressure ⁽³⁾
Low Pressure ⁽³⁾	Low Pressure ⁽³⁾
Voltage / Current / External Set-point ⁽⁶⁾	Voltage / Current ⁽⁶⁾
Outlet Temperature ⁽⁷⁾	Outlet Temperature ⁽⁷⁾
Water temperature at Evaporator Inlet ⁽¹⁾	
Water temperature at Evaporator Outlet ⁽¹⁾	Water temperature at Evaporator Outlet ⁽¹⁾
Water temperature at Condenser Inlet ⁽¹⁾	
Water temperature at Condenser Outlet ⁽¹⁾	Water temperature at Condenser Outlet ⁽¹⁾

(1) NTC (2) 4-20 mA (3) 4-20mA/0-5V (4) NTC-HT/4-20mA/NTC/PT1000 (5) 4-20mA/0-1V/0-10V (6) 4-20mA/0-1V (7) NTC-HT/4-20mA/NTC

DIGITAL OUTPUTS

N°	pCO2 / pCO3 MEDIUM			
	Master (Address 1)		Slave (addresses 2/3/4)	
	Generic	Bitzer	Generic	Bitzer
NO1	Relay 1	CR1	Relay 1	CR1
NO2	Relay 2	CR2	Relay 2	CR2
NO3	Evaporator Pump			
NO 4	Condenser Pump			
NO 5	Liquid Solenoid		Liquid Solenoid	
NO 6	Antifreeze Heater		Antifreeze Heater	
NO 7	Relay 3	CR3	Relay 3	CR3
NO 8	General Alarm		General Alarm	
NO 9	Liquid inj./Econ/Oil Cooler		Liquid inj./Econ/Oil Cooler	
NO10	Line Contactor	PW1	Line Contactor	PW1
NO11	Triangle Contactor	PW2	Triangle Contactor	PW2
NO12	Star Contactor	CR4	Star Contactor	CR4
NO13	4-way Valve		4-way Valve	

pCO1 MEDIUM			
Master (Address 1)		Slave (addresses 2/3/4)	
Generic	Bitzer	Generic	Bitzer
Relay 1	CR1	Relay 1	CR1
Relay 2	CR2	Relay 2	CR2
Evaporator Pump			
Condenser Pump			
Liquid Solenoid		Liquid Solenoid	
Antifreeze Heater		Antifreeze Heater	
Relay 3	CR3	Relay 3	CR3
General Alarm		General Alarm	
Liquid inj./Econ/Oil Cooler		Liquid inj./Econ/Oil Cooler	
Line Contactor	PW1	Line Contactor	PW1
Triangle Contactor	PW2	Triangle Contactor	PW2
Star Contactor	CR4	Star Contactor	CR4
4-way Valve		4-way Valve	

ANALOGUE OUTPUTS

N°	pCO2 / pCO3 MEDIUM	
	Master (Address 1)	Slave (addresses 2/3/4)
Y1		
Y2		
Y3		
Y4		

pCO1 MEDIUM	
Master (Address 1)	Slave (addresses 2/3/4)

7.6 CHILLER UNIT + HEAT PUMP WITH WATER REVERSING - MACHINE TYPE "5"

DIGITAL INPUTS

N°	pCO ² MEDIUM	
	Master (Address 1)	Slave (addresses 2/3/4)
ID 1	Serious Alarm	Serious Alarm
ID 2	Evaporator Flow-switch	Evaporator Flow-switch
ID 3	Remote ON/OFF	Remote ON/OFF
ID 4	Evaporator Pump thermal Cutout	
ID 5	Low Pressure Pressure-switch	Low Pressure Pressure-switch
ID 6	Oil 1 differential / Oil Level	Oil 2 differential / Oil Level
ID 7	Phase monitor	Phase monitor
ID 8	Double Set-point	
ID 9	Evaporator Flow-switch (Enabable)	Evaporator Flow-switch (Enabable)
ID10	Summer / Winter	
ID11	High pressure pressure-switch	High pressure pressure-switch
ID12	Compressor Thermal cutout	Compressor Thermal cutout
ID13		
ID14		

pCO ¹ MEDIUM	
Master (Address 1)	Slave (addresses 2/3/4)
Serious Alarm	Serious Alarm
Evaporator Flow-switch	Evaporator Flow-switch
Remote ON/OFF	Remote ON/OFF
Evaporator Pump thermal Cutout	
Low Pressure Pressure-switch	Low Pressure Pressure-switch
Oil 1 differential / Oil Level	Oil 2 differential / Oil Level
Phase monitor	Phase monitor
Double Set-point	
Evaporator Flow-switch (Enabable)	Evaporator Flow-switch (Enabable)
Summer / Winter	
High pressure pressure-switch	High pressure pressure-switch
Compressor Thermal cutout	Compressor Thermal cutout

ANALOGUE INPUTS

N°	pCO ₂ / pCO ₃ MEDIUM	
	Master (Address 1)	Slave (addresses 2/3/4)
B1	Water temperature at Evaporator Inlet ⁽¹⁾	
B2	Water temperature at Evaporator Outlet ⁽¹⁾	Water temperature at Evaporator Outlet ⁽¹⁾
B3	Water temperature at Condenser Outlet ⁽¹⁾	Water temperature at Condenser Outlet ⁽¹⁾
B4	Outlet Temperature ⁽⁴⁾	Outlet Temperature ⁽⁴⁾
B5	Water temperature at Condenser Inlet ⁽¹⁾	
B6	Voltage / Current / External Set-point ⁽⁵⁾	Voltage / Current ⁽⁵⁾
B7	High Pressure ⁽²⁾	High Pressure ⁽²⁾
B8	Low Pressure ⁽²⁾	Low Pressure ⁽²⁾

pCO ¹ MEDIUM	
Master (Address 1)	Slave (addresses 2/3/4)
High Pressure ⁽³⁾	High Pressure ⁽³⁾
Low Pressure ⁽³⁾	Low Pressure ⁽³⁾
Voltage / Current / External Set-point ⁽⁶⁾	Voltage / Current ⁽⁶⁾
Outlet Temperature ⁽⁷⁾	Outlet Temperature ⁽⁷⁾
Water temperature at Evaporator Inlet ⁽¹⁾	
Water temperature at Evaporator Outlet ⁽¹⁾	Water temperature at Evaporator Outlet ⁽¹⁾
Water temperature at Condenser Inlet ⁽¹⁾	
Water temperature at Condenser Outlet ⁽¹⁾	Water temperature at Condenser Outlet ⁽¹⁾

(1) NTC (2) 4-20 mA (3) 4-20mA/0-5V (4) NTC-HT/4-20mA/NTC/PT1000 (5) 4-20mA/0-1V/0-10V (6) 4-20mA/0-1V (7) NTC-HT/4-20mA/NTC

DIGITAL OUTPUTS

N°	pCO ₂ / pCO ₃ MEDIUM			
	Master (Address 1)		Slave (addresses 2/3/4)	
	Generic	Bitzer	Generic	Bitzer
NO1	Relay 1	CR1	Relay 1	CR1
NO2	Relay 2	CR2	Relay 2	CR2
NO3	Evaporator Pump			
NO4	Condenser Pump			
NO5	Liquid Solenoid		Liquid Solenoid	
NO6	Antifreeze Heater		Antifreeze Heater	
NO7	Relay 3	CR3	Relay 3	CR3
NO8	General Alarm		General Alarm	
NO9	Liquid inj./Econ/Oil Cooler		Liquid inj./Econ/Oil Cooler	
NO10	Line Contactor	PW1	Line Contactor	PW1
NO11	Triangle Contactor	PW2	Triangle Contactor	PW2
NO12	Star Contactor	CR4	Star Contactor	CR4
NO13	4-way Valve		4-way Valve	

pCO ¹ MEDIUM			
Master (Address 1)		Slave (addresses 2/3/4)	
Generic	Bitzer	Generic	Bitzer
Relay 1	CR1	Relay 1	CR1
Relay 2	CR2	Relay 2	CR2
Evaporator Pump			
Condenser Pump			
Liquid Solenoid		Liquid Solenoid	
Antifreeze Heater		Antifreeze Heater	
Relay 3	CR3	Relay 3	CR3
General Alarm		General Alarm	
Liquid inj./Econ/Oil Cooler		Liquid inj./Econ/Oil Cooler	
Line Contactor	PW1	Line Contactor	PW1
Triangle Contactor	PW2	Triangle Contactor	PW2
Star Contactor	CR4	Star Contactor	CR4
4-way Valve		4-way Valve	

ANALOGUE OUTPUTS

N°	pCO ₂ / pCO ₃ MEDIUM	
	Master (Address 1)	Slave (addresses 2/3/4)
Y1		
Y2		
Y3		
Y4		

pCO ¹ MEDIUM	
Master (Address 1)	Slave (addresses 2/3/4)

8. List of parameters

The table below describes program parameters along with the following additional information: screen code (screens have a code in the top right corner) to make identifying the parameter easier (screen), factory setting, upper and lower limits of the range within which values can be effected, unit of measurement, and an empty column for writing the desired value.

To find the parameter you are interested in on the terminal's display, proceed as follows:

- Locate the parameter in the table below and the code of the screen it appears on
- Using the list of screens (coming section) and screen code, call up the screen on the terminal

DESCRIPTION OF PARAMETER	SCREEN	MASTER SLAVE	FACTORY VALUE	USER VALUE	RANGE	UNIT MEASUREMENT	
MAINTENANCE		15 button terminal			Terminal with 6-keys or built-in version		
		MAINTENANCE button			PRG and MAINTENANCE button in the menu		
Password inputting	A3	M/S	1234		0÷9999		
Duty hours thresholds for evaporator pump	A4	M	10		0÷999	hours x 1000	
Reset duty hours thresholds for evaporator pump	A4	M	N		Y/N		
Duty hours thresholds for condenser pump	A5	M	10		0÷999	hours x 1000	
Reset duty hours thresholds for condenser pump	A5	M	N		Y/N		
Duty hours thresholds for compressor	A6	M	10		0÷999	hours x 1000	
Reset compressor duty hours	A6	M	N		Y/N		
Adjustment of probe B1	A7	M/S	0		-9.9÷9.9		
Adjustment of probe B2	A7	M/S	0		-9.9÷9.9		
Adjustment of probe B3	A7	M/S	0		-9.9÷9.9		
Adjustment of probe B4	A7	M/S	0		-9.9÷9.9		
Adjustment of probe B5	A8	M/S	0		-9.9÷9.9		
Adjustment of probe B6	A8	M/S	0		-9.9÷9.9		
Adjustment of probe B7	A8	M/S	0		-9.9÷9.9		
Adjustment of probe B8	A8	M/S	0		-9.9÷9.9		
Compressor 1 enable	A9	M	Y		Y/N		
Compressor 2 enable	A9	M	Y		Y/N		
Compressor 3 enable	A9	M	Y		Y/N		
Compressor 4 enable	A9	M	Y		Y/N		
Alarm log delete	Aa	M/S	N		Y/N		
Manual release of Driver 1 at start-up	Ab	M/S	No		No-Yes		
Manual release of Driver 2 at start-up	Ac	M/S	No		No-Yes		
Adjustment mode for Driver 1 valve	Ad	M/S	Automatic		Aut-Man		
Number of steps for manual opening of Driver 1 valve	Ad	M/S	0		0÷9999	Steps	
Adjustment mode for Driver 2 valve	Ae	M/S	Automatic		Aut-Man		
Number of steps for manual opening of Driver 2 valve	Ae	M/S	0		0÷9999	Steps	
Enter new Maintenance password	Af	M/S	1234		0÷9999		
CLOCK		15 button terminal			PGD0 Terminal with 6-keys or built-in version		
		CLOCK button			PRG and CLOCK button in the menu		
Hour setting	K1	M/S	current hour		0÷23	Hours	
Minute setting	K1	M/S	current minutes		0÷59	minutes	
Day setting	K1	M/S	current day		1÷31		
Month setting	K1	M/S	current month		1÷12		
Year setting	K1	M/S	current year		0÷99		
Enter clock password	K2	M	1234				
Enable on-off time bands	K3	M	N		Y/N		
Start and end hours and minutes for time band F1-1 and F1-2	K4	M	0		0-23 0-59	Hours Minutes	
Start and end hours and minutes for time band F2	K5	M	0		0-23 0-59	Hours Minutes	
Select time bands (F1-F2-F3-F4) for each day	K6	M	F1		F1-F2-F3-F4		
Enter new Clock password	K7	M	1234		0 ÷ 9999		
SET POINT		15 button terminal			PGD0 Terminal with 6-keys or built-in version		
		SET POINT key			PRG and SET POINT button in the menu		
Summer set point	S1	M/S	12.0		see P1	°C	
Winter set point	S1	M	45.0		see P2	°C	
Second summer set-point	S2	M	12.0		see P1	°C	
Second winter set point	S2	M/S	45.0		see P2	°C	
USER		15 button terminal			PGD0 Terminal with 6-keys or built-in version		
		PROG button			PRG and USER button in the menu		
User password inputting	P0	M/S	1234		0÷9999		
Minimum limit of summer set point	P1	M/S	7.0		-99.9 / 99.9	°C	
Maximum limits for the cooling set point	P1	M	17.0		-99.9 / 99.9	°C	
Minimum limit of winter set point	P2	M	40.0		-99.9 / 99.9	°C	
Maximum limits for the heating set point	P2	M	50.0		-99.9 / 99.9	°C	
Selection of control probe	P3	M	Input		Input / Output		
Control with probe at evaporator input	P4	M	Prop.		Prop./Prop+Int.		
Integration time	P4	M	600		0÷9999	seconds	
Control at output - summer forced power down	P5	M	5.0		-99.9 ÷ 99.9	°C	
Control at output - winter forced power down	P5	M	47.0		-99.9 ÷ 99.9	°C	
Control band	P6	M	3.0		0÷99.9	°C	
Neutral zone with modulating capacity control	P7	M/S	1.0		0÷99.9	°C	
Delayed power up between pump and compressors	P8	M	5		0÷999	seconds	
Delayed power down of main pump	P9	M	5		0÷999	seconds	

DESCRIPTION OF PARAMETER	SCREEN	MASTER SLAVE	FACTORY VALUE	USER VALUE	RANGE	UNIT MEASUREMENT
Enable remote On/Off	Pa	M/S	N		Y/N	
Type of remote on / off from master	Pa	M	On/Off Unit		On/Off unit On/Off circuit	
Enable On/Off from supervisor	Pl	M/S	N		Y/N	
Alarm relay logic	Pl	M/S	N.A		N.O. / N.C.	
Enable summer / winter selection from digital input	Pb	M	N		Y/N	
Enable summer / winter selection from supervisor	Pb	M	N		Y/N	
Enable language mask start-up	Pc	M/S	Y		Y/N	
Type of freecooling control	Pd	M/S	Prop.		Prop./Prop+Int.	
Integral time for freecooling management	Pd	M/S	150		0÷9999	seconds
Freecooling offset on set-point	Pd	M/S	5,0		0÷99,9	°C
Minimum freecooling delta	Pe	M/S	2,0		0÷99,9	°C
Maximum freecooling delta	Pe	M/S	10,0		0÷99,9	°C
Freecooling differential	Pe	M/S	4,0		2,0÷99,9	°C
Compressors delay in freecooling	Pe	M/S	5		0÷500	minutes
Minimum threshold for freecooling valve start	Pf	M/S	50		0÷100	%
Maximum threshold for freecooling valve opening	Pf	M/S	50		0÷100	%
Defrosting starts	Pg	M/S	2,0		-99,9 / 99,9	°C/bar
Defrosting ends	Pg	M/S	12,0		-99,9 / 99,9	°C/bar
Drip-off time	Ph	M/S	10		5÷999	seconds
Delayed defrosting start	Ph	M/S	1800		0÷32000	seconds
Maximum defrosting time	Ph	M/S	300		0÷32000	seconds
Cycle reversing configuration	Pi	M/S	Comp. always on		Comp. always ON Comp. OFF start of defr. Comp. OFF end defr. Comp. OFF start/end	
Board identification number for supervisory network	Pj	M/S	1		0÷200	
Card communication speed for supervision network	Pj	M/S	19200		1200÷19200	bps
Selection of communication serial network	Pj	M/S	CAREL PTC		Carel / Modbus / LON	
Select type of unit of measure	Pm	M	STANDARD		STANDARD / ANGLO-SAXON	
New user password inputting	Pk	M/S	1234		0÷9999	
MANUFACTURER	15 button terminal PROG + MENU button		PGD0 Terminal with 6-keys or built-in version PRG and MANUFACTURER button in the menu			
Constructor password inputting	Z0	M/S	1234		0÷9999	
CONFIGURATION →						
Unit configuration	C1	M/S	0		0÷5	
Enable probe B1	C2	M/S	S (if pCO2-pCO3) N (if pCO1)		Y/N	
Enable probe B2	C2	M/S	N		Y/N	
Enable probe B3	C2	M/S	N		Y/N	
Enable probe B4	C2	M/S	N		Y/N	
Enable probe B5	C2	M/S	N (if pCO2-pCO3) S (if pCO1)		Y/N	
Enable probe B6	C2	M/S	N		Y/N	
Enable probe B7	C2	M/S	N		Y/N	
Enable probe B8	C2	M/S	N		Y/N	
Generic probe generic configuration (B4 on pCO1, B5 on pCOC, B6 on pCO2)	C3	M/S	No		No Current Voltage external Set-point	
Type of generic probe	C3	M/S	0-1V(Set point and voltage) 4-20mA(current)		0-1 V 0-10 V 4-20mA	
Generic probe lower limit	C4	M/S	0 (voltage and current), -5.0 (external set - point)		-999,9÷999,9	°C/N/A
Generic probe upper limit	C4	M/S	630(voltage) 400(current) 5.0 (external set - point)		-999,9÷999,9	°C/N/A
Type of probes on analogue inputs 1 and 2 (pCO1 only)	C5	M/S	4-20mA		4-20mA / 0-5V	
Type of delivery temperature probe	C6	M/S	Ntc		Ntc / 4-20mA	
Delivery probe lower limit	C6	M/S	-30,0		-999,9÷999,9	°C
Delivery probe upper limit	C6	M/S	150,0		0,0÷999,9	°C
High pressure probe lower limit	C7	M/S	00,0		-99,9÷99,9	bar
High pressure probe upper limit	C7	M/S	30,0		-99,9÷99,9	bar
Low pressure probe lower limit	C8	M/S	-0,5		-99,9÷99,9	bar
Low pressure probe upper limit	C8	M/S	7,0		-99,9÷99,9	bar
Enable double set-point	C9	M	Disabled		Disabled / Enabled	
Number of drivers present	Ca	M/S	0		0÷2	
Number of compressors present	Ca	M/S	1		1÷4	
Compressor rotation	Ca	M	Y		Y/N	
Kind of compressor and load steps	Cb	M/S	Generic-step		Generic-Step Generic-Stepless Bitzer-Step Bitzer-Stepless	
Number of steps per compressor	Cb	M/S	4		1÷4	

DESCRIPTION OF PARAMETER	SCREEN	MASTER SLAVE	FACTORY VALUE	USER VALUE	RANGE	UNIT MEASUREMENT
Solenoid valve configuration	Cy	M/S	None		None/ Liquid Injection/ Economiser	
Field enabling reduced power	Ch	M/S	N		Y/N	
Step 1 - Relay 1 logic	Cd	M/S	ON		OFF/ON	
Step 1 - Relay 2 logic	Cd	M/S	OFF		OFF/ON	
Step 1 - Relay 3 logic	Cd	M/S	OFF		OFF/ON	
Step 2 - Relay 1 logic	Ce	M/S	OFF		OFF/ON	
Step 2 - Relay 2 logic	Ce	M/S	OFF		OFF/ON	
Step 2 - Relay 3 logic	Ce	M/S	ON		OFF/ON	
Step 3 - Relay 1 logic	Cf	M/S	OFF		OFF/ON	
Step 3 - Relay 2 logic	Cf	M/S	ON		OFF/ON	
Step 3 - Relay 3 logic	Cf	M/S	OFF		OFF/ON	
Step 4 - Relay 1 logic	Cg	M/S	OFF		OFF/ON	
Step 4 - Relay 2 logic	Cg	M/S	OFF		OFF/ON	
Step 4 - Relay 3 logic	Cg	M/S	OFF		OFF/ON	
Off configuration for relay 1	Cz	M/S	OFF		OFF/ON	
Off configuration for relay 2	Cz	M/S	ON		OFF/ON	
Stand-by configuration for relay 1	Ci	M/S	OFF		OFF/ON	
Stand-by configuration for relay 2	Ci	M/S	ON		OFF/ON	
Decrementing configuration for relay 1	Cj	M/S	ON		OFF/ON	
Decrementing configuration for relay 2	Cj	M/S	ON		OFF/ON	
Incrementing configuration for relay 1	Ck	M/S	OFF		OFF/ON	
Incrementing configuration for relay 2	Ck	M/S	OFF		OFF/ON	
Compressor configuration visualisation OFF CR 1 (Btz)	Ct	M/S	OFF		OFF/ON	
Compressor configuration visualisation OFF CR 2 (Btz)	Ct	M/S	ON		OFF/ON	
Compressor configuration visualisation OFF CR 3 (Btz)	Ct	M/S	OFF		OFF/ON	
Compressor configuration visualisation stand-by CR 1 (Btz)	Cu	M/S	OFF		OFF/ON	
Compressor configuration visualisation stand-by CR 2 (Btz)	Cu	M/S	OFF		OFF/ON	
Compressor configuration visualisation stand-by CR 3 (Btz)	Cu	M/S	OFF		OFF/ON	
Decreasing configuration visualisation CR 1 (Btz)	Cv	M/S	OFF		OFF/ON	
Decreasing configuration visualisation CR 2 (Btz)	Cv	M/S	ON		OFF/ON	
Decreasing configuration visualisation CR 3 (Btz)	Cv	M/S	OFF		OFF/ON	
Increasing configuration visualisation CR 1 (Btz)	Cw	M/S	OFF		OFF/ON	
Increasing configuration visualisation CR 2 (Btz)	Cw	M/S	OFF		OFF/ON	
Increasing configuration visualisation CR 3 (Btz)	Cw	M/S	ON		OFF/ON	
Enable solenoid forcing when compressor OFF	Co	M/S	N		Y/N	
Enable pump - down	Cp	M/S	N		Y/N	
Minimum pump - down time	Cp	M/S	50		0÷999	seconds
Conf. step compressor for safety capacity	Cq	M/S	Max. power		Max. power / Min. power	
Enable condensation	Cr	M/S	No		NO/YES	
Type of condensation control	Cr	M/S	Inverter		Inverter / Steps	
Number of fans per condenser	Cr	M/S	1		1÷2	
Enable clock card	Cs	M/S	Disabled		Disabled / Enabled	
PARAMETERS →						
Enable high pressure prevention	G1	M/S	N		Y/N	
Type of high condensation prevention	G1	M/S	Pressure		Press / Temp	
Condensation set-point	G1	M/S	20,0		0÷99,9	bar/ °C
High condensation differential	G1	M/S	2,0		0÷99,9	bar/ °C
Enable delivery prevention	G2	M/S	N		Y/N	
Delivery prevention set-point	G2	M/S	90,0		0÷999,9	°C
Delivery prevention differential	G2	M/S	5,0		0÷99,9	°C
Antifreeze prevention setpoint	G3	M/S	6,0		-99,9÷99,9	°C
Antifreeze prevention differential	G3	M/S	1,0		0÷99,9	°C
Condensation set-point	G4	M/S	14,0		-999,9÷999,9	bar/ °C
Condensing differential	G4	M/S	2,0		-999,9÷999,9	bar/ °C
Inverter maximum speed	G5	M/S	10,0		0,0÷10,0	V
Inverter maximum speed	G5	M/S	3,0		0,0÷10,0	V
Maximum speed time	G5	M/S	10		0÷99	seconds
Enable serious alarm	G6	M/S	N		Y/N	
Enable phase monitor alarm	G6	M/S	N		Y/N	
Enable evaporator flow-switch alarm	G7	M/S	N		Y/N	
Enable condenser flow-switch alarm	G7	M/S	N		Y/N	
Alarm set-point for delivery temperature probe	G8	M/S	120,0		0÷999,9	°C
Alarm differential for delivery temperature probe	G8	M/S	5,0		0÷99,9	°C
High pressure probe alarm set-point	G9	M/S	21,0		0÷99,9	bar
High pressure probe alarm differential	G9	M/S	2,0		0÷99,9	bar
Low pressure probe alarm set-point	Ga	M/S	1,0		-99,9÷99,9	bar
Low pressure probe alarm differential	Ga	M/S	0,5		-99,9÷99,9	bar
Alarm set-point: difference between high and low pressure	Gb	M/S	6,0		0÷99,9	bar
Delayed start due to low pressure difference alarm	Gb	M/S	20		0÷999	seconds
High voltage alarm set-point	Gc	M/S	440,0		0÷999,9	V
High voltage alarm differential	Gc	M/S	5,0		0÷99,9	V
High current alarm set-point	Gd	M/S	200,0		0÷999,9	A
High current alarm percentage differential	Gd	M/S	10,0		0÷99,9	%
Antifreeze set point	Ge	M/S	3,0		0÷999,9	°C
Antifreeze differential	Ge	M/S	1,0		0÷99,9	°C
Pump status in case of antifreeze alarm	Gf	M	Pump ON		Pump ON / Pump OFF	

DESCRIPTION OF PARAMETER	SCREEN	MASTER SLAVE	FACTORY VALUE	USER VALUE	RANGE	UNIT MEASURE MENT
Pump status in the event of evaporator or condenser flow switch alarm	Gk	M	Pumps off		Pumps on / Pumps off	
Solenoid-valve management set-point	Gg	M/S	80,0		0÷999,9	°C
Solenoid-valve management differential	Gg	M/S	10,0		0÷99,9	°C
Antifreeze heater setpoint	Gh	M/S	5,0		0÷99,9	°C
Antifreeze heater differential	Gh	M/S	1,0		0÷99,9	°C
Cycle reversing valve logic	Gi	M/S	N.O.		N.O. / N.C.	
Type of freecooling control	Gi	M/S	0/10V		ON-OFF/0-10V	
Antifreeze temperature	Gi	M/S	-2,0		-99,9÷99,9	°C
Defrosting probe configuration	Cj	M/S	Pressure switches		Temperature Pressure switches	
Type of overall defrosting	Cj	M/S	Simultaneous		Simultaneous Separate Independent	
CAREL EXV DRIVERS / System parameters →						
Activation of driver battery	F0	M/S	N		Y/N	
Type of valve	F2	M/S	---		See EVD Manual	
Select bi-directional valve	F2	M/S	N		Y/N	
Type of refrigerant	F2	M/S	R407c		See EVD Manual	
Custom Valve: minimum steps	F3	M/S	0		0÷8100	
Custom Valve: maximum steps	F3	M/S	1600		0÷8100	
Custom Valve: closing steps	F3	M/S	3600		0÷8100	
Custom Valve: enable extra step at opening	F4	M/S	N		Y/N	
Custom Valve: enable extra step at closure	F4	M/S	N		Y/N	
Custom Valve: current operating	F5	M/S	250		0÷1000	mA
Custom Valve: current stopped	F5	M/S	100		0÷1000	mA
Custom Valve: frequency	F6	M/S	100		32÷330	Hertz
Custom Valve: duty cycle	F6	M/S	50		0÷100	%
Custom Valve: stand-by steps	F7	M/S	0		0÷8100	
Minimum value of S1 pressure sensor	F8	M/S	-0,5		-9,9÷10,0	Bar
Maximum value of S1 pressure sensor	F8	M/S	7,0		3,5÷200,0	Bar
Delay low superheat alarm	F9	M/S	120		0÷3600	seconds
Delay high superheat alarm	F9	M/S	20		0÷500	minutes
Delay LOP alarm	Fa	M/S	120		0÷3600	seconds
Delay MOP alarm	Fa	M/S	0		0÷3600	seconds
Capacity required from driver with step 1 active (stepped capacity control) or with continuous capacity control	Fc	M/S	33		0÷100	%
Capacity required from driver with step 2 active	Fc	M/S	55		0÷100	%
Capacity required from driver with step 3 active	Fd	M/S	77		0÷100	%
Capacity required from driver with step 4 active	Fd	M/S	100		0÷100	%
CAREL EXV DRIVERS / Autosetup →						
Installation of default parameters	Fs	M/S	N		Y/N	
Percentage ratio between fridge power and driver power	Ft	M/S	60		0÷100	%
Type of compressor or unit	Fu	M/S	Screws		See EVD manual	
Type of capacity control	Fu	M/S	Steps		See EVD manual	
Type of cold mode exchanger	Fv	M/S	---		See EVD manual	
Type of heat mode exchanger	Fv	M/S	---		See EVD manual	
Threshold for LOP protection during chiller operation	Fw	M/S	-2,0		-70,0÷50,0	°C
Threshold for LOP protection during heat pump operation	Fw	M/S	-18,0		-70,0÷50,0	°C
Threshold for LOP protection during defrost. operation	Fw	M/S	-30,0		-70,0÷50,0	°C
Threshold for MOP protection during chiller operation	Fx	M/S	12,0		-50,0÷90,0	°C
Threshold for MOP protection during heat pump operation	Fx	M/S	12,0		-50,0÷90,0	°C
Threshold for MOP protection during defrost. operation	Fx	M/S	15,0		-50,0÷90,0	°C
Superheat high alarm threshold	Fy	M/S	20,0		0,0÷99,9	°C
CAREL EXV DRIVERS / Advanced →						
Percentage ratio between fridge power and driver power in chiller function	Fe	M/S	60		0÷100	%
Proportional gain in chiller function	Ff	M/S	0		0,0÷99,9	
Integral time during chiller operation	Ff	M/S	0		0÷999	seconds
Superheat set point during chiller operation	Fg	M/S	7,0		2,0÷50,0	°C
Threshold for superheat protection during chiller operation.	Fg	M/S	2,5		0÷9,9	°C
Percentage ratio between fridge power and driver power during heat pump operation	Fh	M/S	60		0÷100	%
Proportional gain during heat pump operation	Fi	M/S	0		0,0÷99,9	
Integral time during heat pump operation	Fi	M/S	0		0÷999	seconds
Superheat set-point during heat pump operation	Fj	M/S	7,0		2,0÷50,0	°C
Threshold for superheat low protection during heat pump operation	Fj	M/S	2,5		0÷9,9	°C
Percentage ratio between fridge power and driver power during defrosting operation	Fk	M/S	60		0÷100	%
Proportional gain during defrosting operation	Fl	M/S	0		0,0÷99,9	
Integral time during defrosting operation	Fl	M/S	0		0÷999	seconds
Superheat set point during defrosting operation	Fm	M/S	7,0		2,0÷50,0	°C
Threshold for low superheat protection during defrost. operation	Fm	M/S	2,5		0÷9,9	°C
Superheat dead band	Fn	M/S	0		0÷9,9	°C
Derivative time	Fn	M/S	1,5		0÷99,9	
Integral time for superheat low protection	Fo	M/S	1,0		0÷30,0	seconds
Threshold Integral time for LOP protection during chiller. operation	Fo	M/S	1,5		0÷25,5	seconds
Threshold Integral time for LOP protection during chiller. operation	Fp	M/S	2,5		0÷25,5	seconds
Delay in MOP protection departure	Fp	M/S	60		0÷500	seconds

DESCRIPTION OF PARAMETER	SCREEN	MASTER SLAVE	FACTORY VALUE	USER VALUE	RANGE	UNIT MEASUREMENT
Dynamic proportional enabling factor	Fq	M/S	N		Y/N	
Protection threshold for high temperature condensation	Fr	M/S	85,0		0÷99,9	°C
Integral time for high temperature condensation	Fr	M/S	0		0÷25,5	seconds
TIMES →						
Delayed start due to evaporator flow-switch alarm	T0	M/S	15		0÷99	seconds
Delayed steady state operation due to evaporator flow-switch alarm	T0	M/S	3		0÷99	seconds
Delayed start due to condenser flow-switch alarm	T1	M/S	15		0÷99	seconds
Delayed steady state operation due to condenser flow-switch alarm	T1	M/S	3		0÷99	seconds
Delayed start due to low pressure alarm	T2	M/S	40		0÷99	seconds
Delayed steady state operation due to low pressure alarm	T2	M/S	0		0÷99	seconds
Delayed start due to oil differential alarm	T3	M/S	120		0÷999	seconds
Delayed steady state operation due to oil differential alarm	T3	M/S	10		0÷999	seconds
High current alarm activation delay from compressor start	T8	M/S	10		0÷9999	seconds
High current alarm delay from threshold exceeded	T8	M/S	300		0÷9999	seconds
Time between star / line	T4	M/S	2		0÷999	100 seconds.
Star time	T4	M/S	200		0÷999	100 seconds.
Delta / star time	T4	M/S	1		0÷999	100 seconds.
Compressor minimum ON time	T5	M/S	60		0÷9999	seconds
Compressor minimum OFF time	T5	M/S	360		0÷9999	seconds
Time between power ups of different compressors	T6	M/S	10		0÷9999	seconds
Time between thrusts of same compressor	T6	M/S	450		0÷9999	seconds
Time for reaching maximum power	Td	M/S	60		0÷9999	seconds
Time for reaching minimum power	Td	M/S	60		0÷9999	seconds
Solenoid-compressor start sequence	T7	M/S	SOL/CMP		0: SOL/CMP 1: CMP/SOL	
Time between solenoid and compressor or opposite. During this time the condenser fan is force to 100%	T7	M/S	10		0÷9999	seconds
Time between capacity controls 1 and 2	T7	M/S	25		0÷9999	seconds
Time between capacity controls 2 and 3	T7	M/S	300		0÷9999	seconds
Time between capacity controls 3 and 4	T7	M/S	300		0÷9999	seconds
CR4 period	T9	M/S	10		0÷999	seconds
Maximum operating time out-with the operating limits	T9	M/S	60			seconds
Delay at start up of the high suction pressure alarm	T9	M/S	300		0÷9999	seconds
Pulse period for modulating configuration	Ta	M/S	6		0÷99	seconds
Minimum decrementing pulse	Ta	M/S	1,5		0÷99,9	seconds
Maximum decrementing pulse	Ta	M/S	3,0		0÷99,9	seconds
Derivation time for modulating configuration	Tb	M/S	3			seconds
Minimum increasing pulse	Tb	M/S	1,5		0÷99,9	seconds
Maximum increasing pulse	Tb	M/S	3,0		0÷99,9	seconds
Decrement forcing time at compressor start	Tc	M/S	20		0÷999	seconds
Delay to reach to the normal working	Te	M/S	0		0÷999	Minute
Unloader time	Te	M/S	0		0÷9999	Second
INITIALISATION →						
Deletion of memory and installation of default values.	V0	M/S	N		Y/N	
Set new Constructor password	V1	M/S	1234		0÷9999	

9. Screens

Screens can be divided into 5 categories:

USER screens, not password protected: they appear in all loops except "prog" and "menu+prog" and show probe values, alarms, hours of operation of the devices, time and date, and can be used to set temperature and humidity setpoints and for clock set-up. They are marked with the "⓪" symbol in the parameters table below.









password-protected USER screens (password 1234, editable): called up by pressing the "prog" key, via these screens you can set the main functions (times, setpoints, differentials) of connected devices. Screens referring to functions that are not available are not displayed. They are marked with the "Ⓛ" symbol in the parameters table below.

password-protected MAINTENANCE screens (password 1234, editable): called up by pressing the "maintenance" key. Via these screens you can monitor devices, set connected probes, edit hours of operation and manage devices in manual mode. They are marked with the "Ⓜ" symbol in the parameters table below.

password-protected MANUFACTURER screens (password 1234, editable): called up by pressing key combination "menu+prog" - via these screens you can configure the air-conditioner and enable main functions, as well as choosing connected devices. They are marked with the "Ⓜ" symbol in the parameters table below.

9.1 List of screens

Following is the list of screens shown on the display. The table's columns represent screen loops, and the first screen (A0, B0...) is the one that appears when you press the relevant key. You can then use the arrow keys to scroll through the others. The codes (Ax, Bx, Cx...) appear in the top right corner of the screens, making them easier to distinguish. The meaning of the symbols ⓪, Ⓛ, Ⓜ... is explained in the previous paragraph. The PSW symbol indicates screens where you are required to enter passwords.

							
⓪ M0	⓪ Ah		⓪ I0	⓪ K0	⓪ S0	PSW P0	PSW Z0
	⓪ Ai		⓪ I1	⓪ K1	⓪ S1	⓪ P1	CONFIGURAZIONE → ⓪ C1
	⓪ Ak		⓪ I2	PSW K2	⓪ S2	⓪ P2	⓪ C2
	⓪ A0		⓪ I3	⓪ K3		⓪ P3
	⓪ A1		⓪ I4	⓪ K4		⓪ P4	⓪ Cb
	⓪ A2		⓪ I5	⓪ K5		⓪ P5	⓪ Cy
	PSW A3		⓪ I6	⓪ K6		⓪ P6	⓪ Ch
	Ⓜ A4		⓪ I7	⓪ K7		⓪ P7	⓪ Cd
	Ⓜ A5		⓪ I8			⓪ P8	⓪ Ce
	Ⓜ A6		⓪ I9			⓪ P9	⓪ Cf
	Ⓜ A7		⓪ Ia			⓪ Pa	⓪ Cg
	Ⓜ A8		⓪ Ib			⓪ Pi	⓪ Cz
	Ⓜ A9		⓪ Ic			⓪ Pb	⓪ Ci
	Ⓜ Aa		⓪ Id			⓪ Pc	⓪ Cj
	Ⓜ Ab					⓪ Pd	⓪ Ck
	Ⓜ Ac					⓪ Pe	⓪ Cl
	Ⓜ Ad					⓪ Pf	⓪ Cu
	Ⓜ Ae					⓪ Pg	⓪ Cv
	Ⓜ Af					⓪ Ph	⓪ Cw
						⓪ Pi	⓪ Co
						⓪ Pj	⓪ Cp
						⓪ Pm	⓪ Cq
						⓪ Pk	⓪ Cr
							⓪ Cs
							PARAMETRI → ⓪ G1
						
							⓪ Gf
							⓪ Gk
							⓪ Gg
							⓪ Gh
							⓪ Gi
							⓪ Gj
							CAREL EXV DRIVER → ⓪ F0
							Parametri di sistema ⓪ F2
						
							⓪ Fd
							CAREL EXV DRIVER → ⓪ Fe
							Advanced ⓪ Ff
						
							⓪ Fr
							CAREL EXV DRIVER → ⓪ Fs
							Autosetup ⓪ Fs
						
							⓪ Fy
							TEMPISTICHE → ⓪ T0
							⓪ T1
							⓪ T2
							⓪ T3
							⓪ T8
							⓪ T4
							⓪ T5
							⓪ T6
							⓪ Td
							⓪ T7
							⓪ T9
							⓪ Ta
							⓪ Tb
							⓪ Tc
							INIZIALIZZAZIONE → ⓪ V0
							⓪ V1

10. EVD 200 electronic expansion valve

The EV Driver module for piloting the electronic expansion valves (EEV) for the pLAN network, makes it possible to control intake superheating to enable the refrigerating unit to operate more efficiently and with greater versatility.

We say efficiently, because by improving and stabilising the flow of refrigerant to the evaporator, we increase the system's overall performance, while guaranteeing safety (low pressure pressure switch less frequently tripped, fewer returns of liquid refrigerant to the compressor,...). Furthermore, if the EEV is correctly sized, use of condensation pressure (or evaporation pressure,) either floating or at low set point, considerably increases the system's efficiency, while ensuring lower energy consumption and greater refrigerating yield. It is versatile, because the electronic expansion valve makes it possible to serve refrigerating units with a lower refrigerating capacity and in operating conditions which may differ considerably from each other.

Using an expansion valve entails the installation not only of the EVDriver and the expansion valve itself, but also of a temperature sensor and a pressure transducer, both located on the refrigerating side at the end of the evaporator (on the compressor's intake pipe). Consult the following diagram for a better understanding of the system's typical lay-out. The priorities to be considered for optimal control of the refrigerating system: obtaining a high, constant refrigerating yield rather than very low, stable superheating. The heart of the control is a PID control with settable coefficients for superheating.

These are the additional controls:

LOW	(Low superheating with integral time and adjustable threshold)
LOP	(Low evaporation pressure, operating in transients only, with integral time and adjustable threshold)
MOP	(High evaporation pressure with integral time and adjustable threshold)
HIT cond	(High condensing pressure, activated with condensing pressure probe read by the pCO, with programmable integral time and threshold)

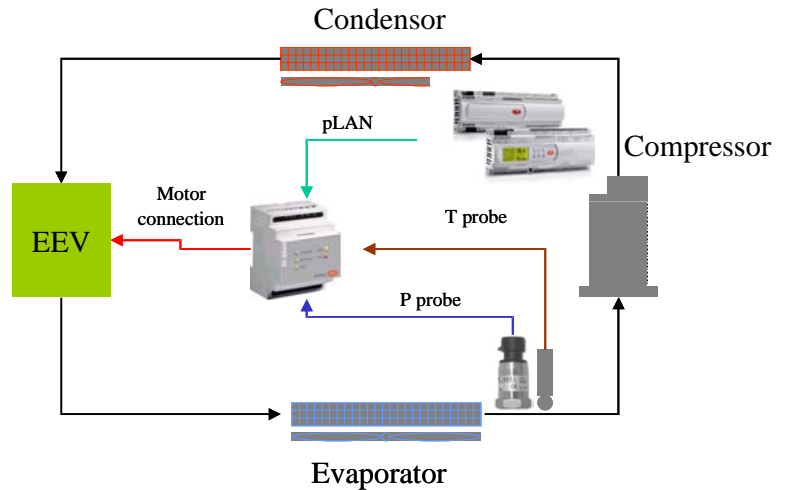

10.1 Driver parameters

Below are shown the fundamental and most important parameters to operate the EVD200 driver. The parameters are divided into three different branches that can be accessed via the EVD menu:

- System parameters (information on what is physically installed)
- Autosetup (Standard information on the kind of unit)
- Advanced parameters (parameters who should be changed by experts)

IMPORTANT : in order for the unit to operate, the parameters in the "system parameter" and "autosetup" branches should be inserted. Otherwise, an alarm will appear to indicate that the autosetup procedure has not occurred.

10.1.1 BRANCH system parameter

- **Battery presence**
Indicate the presence of the battery connected to EVD
- **Valve type**
Insert the kind of electronic valve used, a read only parameter will indicate the number of maximum regulation passes of the valve (useful for identifying certain valve models should the trade name be changed)
Alco EX5
Alco EX6
Alco EX7
Alco EX8
SPORLAND 0.5-20tons
SPORLAND 25-20tons
SPORLAND 50-250tons
CAREL E2V**P
CAREL E2V
DANFOSS ETS-25/50
DANFOSS ETS-100
DANFOSS ETS-250/400
CUSTOM
An incorrect choice of valve or configuration of the CUSTOM valve can damage the hardware of the valve itself.
- **Refrigerant**
Select the kind of refrigerant used.
R22, R134A, R404A, R407C, R410A, R507C, R290, R600, R600A, R717, R744, R728, R1270.

- **CUSTOM VALVE CONFIGURATION**

If a CUSTOM valve is selected, the configuration levels shown below appear.

Minimum Steps

Minimum opening steps used only in repositioning to capacity change.

Maximum Steps

Maximum opening steps

Closure Steps

Steps to obtain a complete closure of the valve

Extra Opening Step

Enabling opening steps beyond the maximum ones.

Do not activate if one's own expansion valve has an overall course (closure steps) greater than the controlling course (Maximum steps) for example with the Sporlan valve.

Do not use without prior authorisation from one's own EEV supplier at the enabling of the steps against the opening mechanical end stroke.

These steps are given every second up to 30% of the maximum steps in the event that the valve is completely open with overheating above the setpoint.

On return to normality (superheat below the setpoint and/or valve opening below maximum) the meter for the extra steps provides is reset and if the fault reappears, others will be provided again 30% greater than the maximum steps.

Extra Step Closure

Enabling of closure steps with valve already completely closed.

Do not use without prior authorisation from one's own EEV supplier at the enabling of the steps against the closure mechanical end stroke.

These steps are given every second up to 30% of the maximum steps in the event that the valve is completely closed with overheating below the setpoint. On

return to normality (superheat above the setpoint and/or valve opening different from zero) the meter for the extra steps provides is reset and if the fault reappears, others will be provided again 30% greater than the maximum steps.

Movement Current

Stationary Current

Step Frequency

Duty Cycle

Report on maximum gear.

Indicate the maximum time percentage (based on a second) where the valve can be running (to avoid superheat of some motors).

- **EEV steps in standby**

Represents the number of steps that the valve maintains during the adjustment pauses (unit at OFF).

By selecting a level greater than zero, the valve will remain partially open.

If a solenoid valve is installed before the expansion valve, this level can be increased (e.g. 25% of the maximum steps) to minimise the risks of blocking the valve (due to ice, dirt, wear...)

- **Pressure sensor limits (default -1..9.3 barg)**

Range of an adjustment sensor for overheating connected to the EVD.

- **ALARMS DELAY**

Low Superheat (Default 120 S)

A zero level deactivates the alarm.

High Superheat (Default 20 Min)

A zero level deactivates the alarm.

LOP (default 120 s)

Delay alarm for evaporation low pressure.

A zero level deactivates the alarm.

MOP (default 0 s)

Delay alarm for evaporation high pressure.

A zero level deactivates the alarm.

10.1.2 BRANCH autoseup

- **Start up opening percentage**

Insert the ratio between the circuit potential and that of the valve, considering the circuit at 100%. The percentage is always lower than or equal to 100% the valve will always be larger than the circuit where it is installed. This percentage is used to calculate the position of the first opening (pre-positioned) of the valve when the circuit starts up. In the case of non modulating circuits (0% or 100%), the percentage is the only parameter that influences the first opening: by selecting 40% the valve will open 40% of its controlling course. In the case of *stepped circuits* (e.g. 0%-25%-50%-100%), the valve will open 40% of the controlling course multiplied for the first step of the circuit (e.g. 40%*25%=10%).

The parameter is changed according to the ideal obtained from the ratio of the circuit/valve capacity so that when the circuit is turned on, there is no considerable liquid reflux (for more than a minute, in this case reduce the percentage) or excessively low evaporation pressure problems for an excessively long period (in this case increase the percentage). The parameter also automatically influences certain PID regulation levels (proportional gain).

- **Kind if compressor or unit**

Insert the unit/compressor category in which the expansion valve is used.

This selection optimises the PID control parameters and the Driver's auxiliary protection, bearing in mind the control specifications in the various kinds of plant.

The following choices are available:

Alternative

Screws

Scroll

Rapid Group / Cell

Group / Cell

- **Kind of load step**
In this field, one must insert the kind of capacity control used in the circuit.
The following choices are available:
None or steps: compressor without load steps or with step load steps.
Slow continuation: compressor with continuous modulation that is not particularly fast or with a considerable inertia speed (e.g. case for screw compressors)
compressor with fast continuous modulation or with low inertia (e.g. control with inverter or with speed case)
- **Kind of evaporator**
Insert the kind of exchanger used as evaporator for the hot and/or cold modes: depending on the reversibility of the circuit there can be either one or two fields.
The following choices are available:
Metal sheets
Plates/pipes
Fast Finned
Slow Finned
- **Minimum saturation temperature (LOP)**
Separately set the limits lower than the evaporation temperature for the operational modes available (Cold, Hot, Defrost).
The level to be inserted is not the calibration level of a low pressure switch but the minimum temperature of acceptable evaporation for the unit in continuous operation.
For example, for water refrigerator without glycol with water outlet setpoint at 7°C, a typical level is -2°C.
On the other hand, for a heat pump, the level could also be lower than -20°C depending on the use and project characteristics.
In the case of centralised unit (e.g. supermarket) and/or multi-evaporator where the behaviour of the valve does not influence the evaporation pressure (being set a compressor pack) set at -50°C (function not operational).
- **Maximum saturation temperature (MOP)**
Separately set the limits greater than the evaporation temperature for the operational modes available (Cold, Hot, Defrost).
Once this threshold has been reached, the expansion valve will start to modulate (closing) in order to stay below.
Obviously in these cases, the superheat control will be abandoned: the MOP work point normally helps maintain the superheat considerably above the set setpoint.
- **Superheat high alarm threshold Default 20°C**
Insert the maximum superheat for the generation of the relative alarm (delay set in the system branch).
This parameter shows a double field like the one in the advanced branch.

10.1.3 Advanced BRANCH

This branch allows for the configuration of all the expansion valve control parameters that is generally unnecessary.

For each parameter, in this section, two fields are shown. The left hand field shows the level set by the AUTOSSETUP procedure and cannot be changed since it is read only. The right hand field can be changed (by default equal to zero that means the use of the autoseup parameter) and makes it possible to change the level of variation used by the control. The description of the parameter can start with a prefix indicating on which operational mode it will be used:

CH: COLD mode

HP: HOT mode

DF: DEFROST mode

- **EEV opening percentage**
Percentage of initial opening of the valve on activation of the driver/circuit.
- **Set superheat**
Superheat target level that the driver aims at.
Do not set levels that are too low (less than 5°C) or too close to the limit of low superheat (a difference of at least 3°C).

Proportional gain

Proportional gain of the PID control.

On increasing this parameter, the valve's reaction speed increases, above all with frequent variations of superheat (e.g. fast capacity ramp or evaporator loading). This parameter influences all the valve's movements, not only those linked to the standard PID but also to the control of accessories (low superheat, high or low evaporation pressure.....)

- **Integral time**
Integral time of PID control.
On the decreasing of this valve, the driver increases the number of steps sends a command to the valve every second to achieve the setpoint.
High levels, therefore, reduce the integral action and slow down the valve movement.
Excessively low levels (below 20s) can create hunting to the system for excessive movements of the expansion valve. The level 0 (zero) completely cancels the integral action.
- **Low superheat**
Limits of low superheat.
Below this level of superheat, the driver sends a command to the expansion valve for a faster closure speed than normal, in order to avoid liquid reflux.
In fact, it represents an additional integral term to the PID control that intervenes below the threshold selected.
Do not set levels that are too close to the superheat setpoint (a difference of at least 3°C) or levels too close to zero (less than 2°C) in order to avoid the protection intervening in the event of an incorrect reading of the control probes.

- **Superheat neutral area**
Neutral area for PID control. In this setpoint context, the driver will stop the control and the valve not make any movements.
The control starts again when the superheat exits the neutral area.
- **Derivative time**
Derivative time of PID control.
Avoid levels greater than 4 seconds in order to prevent unstable control.
- **Low superheat integral time**
Integral time for low superheat control.
On this parameter decreasing, the control of low superheat diverts more speed/energy. Levels close to 1.0 seconds are advised for fast evaporators (plates, piping bands....) and close to 10.0 seconds for slow batteries (refrigeration counters, centralised units..).
A level of 0 (zero) disables the control.
- **LOP integral time**
Integral control time at the protection stage for low pressure/evaporation temperature (LOP).
When this parameter diminishes, the control becomes faster.
Levels close to 1.0 seconds are advised for fast evaporators (plates, piping bands....) and close to 10.0 seconds for slow batteries (refrigeration counters, units..). *It is advisable to deactivate for centralised use (supermarket use, centralised units....)*
A level of 0 (zero) disables the protection.
- **MOP integral time**
Integral control time at the protection stage for high pressure/evaporation temperature (MOP).
When this parameter diminishes, the control becomes faster.
Levels close to 2.5 seconds are advised for fast evaporators (plates, piping bands....) and close to 25.0 seconds for slow batteries (refrigeration counters, units..). A level of 0 (zero) disables the control.
- **Delay in MOP start up**
The MOP action is disabled for this time when control starts.
This time is needed to allow for the achievement of low evaporation pressures in circuits that start with equalised pressures. in the case of excessively reduced times, the MOP control leaving the unit could be activated only because the evaporation pressure did not have the time to reach the "real" working level.
- **High condensation temperature protection**
Maximum condensation temperature.
Only use if the driver controls the condensation probe or receives the level from the main control (pCO...)
Over and above this level, the driver ignores the superheat control and progressively closes the expansion valve to limit the fridge capacity and subsequently the condensation pressure. This way, the evaporation pressure is considerably reduced. Only use in plants that can operate at negative evaporation temperatures and that do not have other methods to reduce the condensation pressure (unloading, capacity reduction....)
- **Integral time for high condensation temperature**
Integral control time during the protection stage for high condensation pressure (HiTcond).
When this parameter diminishes, the control becomes faster.
Levels close to 5.0 seconds are advised.
A level of 0 (zero) disables the control.
- **Dynamic proportional control**
This function allows the driver to change the proportional PID gain depending on the actual circuit capacity.
In the case of valves that are particularly large and/or circuits with the possibility of working at low load steps (below 50%), this function allows for the automatic reduction of the gain in proportion to the low potential.
Use in the case of low potential, the valve seems to react too quickly/violently, causing hunting in the evaporation pressure and/or superheat.
This is a particular function to activate, so it will only show one field.

10.2 Special "go ahead" function

```

+-----+
|Driver 1 status|
|Valve open restart|
|Go ahead? N|
+-----+

```

There are three alarm conditions which prevent the driver from performing normal control (one of these is shown above):

- an open valve → during the last blackout, the valve was not shut completely
- battery charge → the battery is not operating correctly or it is discharged or disconnected
- eeprom restart → malfunctioning eeprom

When one of these conditions is active, the following alarm appears:

```

+-----+
|AL086|
|Driver1:Waiting for|
|eeprom/batt.charged|
|or open valve error|
+-----+

```

With the "Ignore" function, these alarms can be ignored to enable the driver to control the valve (otherwise the driver would keep the valve shut).

WARNING! deleting the alarms means ignoring them, and consequently it is recommended to carefully check that the system is not damaged or malfunctioning or becomes unreliable (e.g.: if "recharge battery" is signalled, it probably means that the battery is not charged or is not connected, etc. Consequently, in the event of a blackout, it may not be able to close the valve. The valve would thus remain open when the installation starts again).

If none of the three above alarms is present, the screen changes over to the next screen:

```

+-----+
| Driver 1 status |
|                 |
| No fault        |
|                 |
+-----+

```

11. Unit On/Off

There two power-up and power-down modes for the machine:

1. Power-up and power-down of System
2. Power-up and power-down of Circuit

The unit status can be controlled from the keypad, digital input (can be enabled), supervisor (can be enabled)

The power-up/power down operation with the ON/OFF key on the keyboard has absolute priority. When this key is pressed, the green LED (ON or OFF) near the key will indicate the current status.

The machine can be powered up or down from the supervisor and/or the digital input, only if it was powered up from the keyboard. Any power-down from the supervisor or digital input will be signalled by the flashing of the green LED on the ON/OFF key and by a special wording on the main menu screen.

Power-up and power-down of System

Control is by the master board : if the board is powered up, it will power up also all the system's slaves, and vice-versa if OFF.

Power-up and power-down of Circuit

Control is by the slave board : the individual slave boards can be powered up or down from the supervisor/digital input, only if the master card is ON.

The main mask of the terminal connected to master board shows, on normal working, the status of unit. If the master circuit is switch-off, by digital input, the status blink between unit status and circuit off (Circ.OFF).

12. Control

There are two different modes for controlling the control thermostat:

- control depending on the water temperature values measured by the probe installed at the evaporator inlet;
- control depending on the water temperature values measured by the probe installed at the evaporator outlet.

In the first case, the control is proportional and based on the absolute temperature value measured by the probe; in the second case, control features a dead band based on the time the temperature measured by the probe remains over certain thresholds. The type of control in any case depends on the type of compressor managed:

- if the compressor features stepped capacity control (load steps) then either type of control can be used;
- if the compressor features continuous capacity control, then only outlet temperature control will be available.

Control set-point

Employed Inputs:

- Digital input to enable second set point
- Analogue input for remote set point variation
- Supervisor serial network

Employed Parameters:

- Control set point
- Enable second set point from digital input
- Enable remote set point from analogue input
- Limits for calculating remote set point from analogue input
- Display set point used by the control

Description of operation

The temperature control, irrespective of the type, is based on the setting of two fundamental parameters: set point and control band.

The control set point can be changed according to the operating requirements of the unit.

There are four different ways to change the control set point:

- Different from the screen: accessing the special screen, the user can set the value of the parameter directly.
- Different from the supervisor: if a supervisory system is connected, the cooling or heating set point can be modified by accessing the dedicated addresses.
- Different from digital input: enabling the management of the secondary set point, the set point defined on the dedicated screen will be replaced by the corresponding user parameter, depending on the status of the digital input.
- Different from analogue input: enabling the remote set point from analogue input (0-1V) will activate the control set point compensation, with a proportional value between the two limits for the conversion of the input signal.

All the conditions may exist together, condition "1" is always active, while the others can be enabled or disabled separately.

Inlet temperature control

Employed Inputs:

- Water temperature at evaporator inlet

Employed Parameters:

- Type of unit
- Total number of compressors
- Type of compressor capacity control
- Number of Capacity Control Steps
- Control set-point
- Proportional band for control at inlet.
- Type of control (proportional or proportional + integral)
- Integration time (if the proportional + integral control is enabled)
- Time between start-up and first capacity control
- Time between first and second capacity control
- Time between second and third capacity control
- Time between third and fourth capacity control

Outputs used:

- Liquid Solenoid
- Windings for compressor Line - Delta - Star
- All compressor capacity control relays

The thermostatic control according to the values measured by the temperature probe at evaporator inlet, is based on proportional control. According to the total number of configured compressors and capacity control steps per compressor, the set control band will be subdivided into a certain number of steps of equal amplitude. When the activation thresholds of the individual steps is exceeded, a different compressor or capacity control steps will be activated.

To determine the different activation thresholds, the following relations must be applied:

Total number of control steps : Total number of compressors * Number of capacity control/compressor steps

Step proportional amplitude = Proportional control band / Total number of control steps

Step activation thresholds = Control set-point + (Step proportional amplitude * Step sequential number [1,2,3...])

Outlet temperature control

Employed Inputs:

- Water temperature at evaporator outlet

Employed Parameters:

- Type of unit
- Total number of compressors
- Type of compressor capacity control
- Number of capacity control steps
- Control set-point
- Control band for outlet control
- Delayed starting of compressor capacity control stages
- Devices activation delay
- Devices disablement delay
- Summer limit of temperature at outlet (powers down all compressors without observing the disabling time)
- Winter limit of temperature at outlet (powers down all compressors without observing the disabling time)

Outputs used :

- Liquid Solenoid
- Windings for compressor Line - Delta - Star
- All compressor capacity control relays

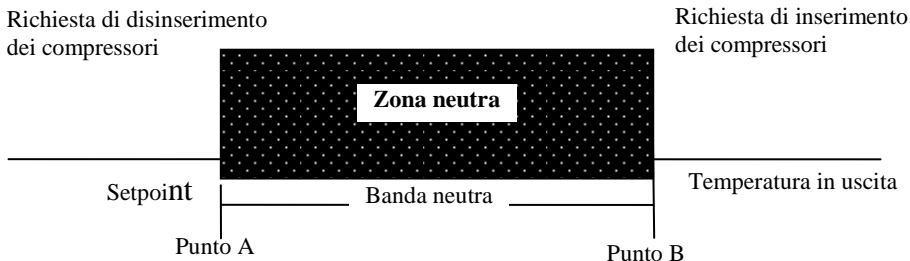

A neutral temperature zone is identified, based on the set set-point and band values.

- Temperature values between the set point and set point + band ($A < \text{Temperature} < B$) will not switch any compressors On/Off.

- Temperature values above set point + band ($\text{Temperature} > \text{Point B}$) will activate the compressors

- Temperature values below the set point ($\text{Temperature} < \text{Point A}$) will deactivate the compressors

A temperature threshold, subdivided into summer and winter operation is also specified: the installed devices are unconditionally disabled above/below this threshold, in order to prevent the units producing too much cold/heat.

With capacity-control compressors, the activation and deactivation occur further outside of point A and B. See the chapter *Continuous capacity control with outlet control*.

Control of water /water chiller only units

Employed Inputs:

- Water temperature at evaporator inlet
- Water temperature at evaporator outlet
- Water temperature at condenser inlet
- Water temperature at condenser outlet

Employed Parameters:

- Type of unit
- Total number of compressors
- Type of compressor capacity control
- Number of capacity control steps
- Control set-point
- Control band
- Type of control (inlet - outlet)
- Type of control at inlet (proportional - proportional + integral)
- Integration time (if the proportional + integral control is enabled)
- Delayed starting of compressor capacity control stages
- Devices activation delay

Outputs used :

- Liquid Solenoid
- Windings for compressor Line - Delta – Star
- All compressor capacity control relays

Description of operation:

Activation of compressors is controlled by the water temperature measured by the probe located at evaporator inlet/outlet. No condensation fans are supplied because the condenser is water-cooled.

Control of water/water chiller unit with gas reversing heat pump

Employed Inputs:

- Water temperature at evaporator inlet
- Water temperature at evaporator outlet
- Water temperature at condenser inlet
- Water temperature at condenser outlet

Employed Parameters:

- Type of unit
- Total number of compressors
- Type of compressor capacity control
- Number of capacity control steps
- Control set-point
- Control band
- Type of control (inlet - outlet)
- Type of control at inlet (proportional - proportional + integral)
- Integration time (if the proportional + integral control is enabled)
- Delayed starting of compressor capacity control stages
- Devices activation delay
- Refrigerating circuit reversing valve logic
- Outputs used
- Liquid Solenoid
- Windings for compressor Line - Delta - Star
- All compressor capacity control relays
- Refrigerating circuit reversing valve

Description of operation:

Activation of compressors is controlled by the water temperature measured by the probe located at evaporator inlet/outlet. No condensation fans are supplied because the condenser is water-cooled.

During the reversing of the refrigerator cycle, i.e. at changeover from refrigeration to heating and vice-versa, the evaporator and condenser functions are exchanged. In this mode, the refrigerating circuit is reversed, but the compressors are always controlled by the temperature at evaporator inlet/outlet.

Control of water/water chiller unit with water reversing heat pump

Employed Inputs:

- Water temperature at evaporator inlet
- Water temperature at evaporator outlet
- Water temperature at condenser inlet
- Water temperature at condenser outlet

Employed Parameters:

- Type of unit
- Total number of compressors
- Type of compressor capacity control
- Number of capacity control steps
- Control set-point
- Control band
- Type of control (inlet - outlet)
- Type of control at inlet (proportional - proportional + integral)
- Integration time (if the proportional + integral control is enabled)
- Delayed starting of compressor capacity control stages
- Devices activation delay
- Water circuit reversing valve logic

Outputs used

- Liquid Solenoid
- Windings for compressor Line - Delta - Star
- All compressor capacity control relays
- Water circuit reversing valve

Description of operation:

Activation of compressors is controlled by the water temperature measured by the probe located at evaporator inlet/outlet. There are no condensation fans because the condenser is cooled using water. During the reversal of the refrigerator cycle, that is, during the passage from refrigeration to heating or vice versa, there is no exchange between the evaporator and condenser functions. In this mode, the water circuit is reversed, and the compressors are controlled by the temperature at evaporator or condenser inlet/outlet according to the selected mode.

13. Types of controlled compressors

Stepped capacity control

A maximum number of four compressors are managed, with a maximum of four capacity control steps each. Capacity control is achieved by three relay outputs which, when suitably commanded, short-circuit the refrigerant thrust by the compressor, varying its capacity and, therefore, the power input into the circuit.

Configuration of stepped capacity control relays

The enabling sequence of the capacity control relays differs for each compressor. Therefore, the software has a facility for configuring the enabling sequence according to the needs of different compressor manufacturers. For multi-card systems: as several compressors are housed on the same machine, it is considered that the compressors controlled by each pCO are perfectly equal and, therefore, the capacity control configuration selected on board the master card also applies to the slave cards. The following table shows examples of the configuration of the dedicated digital outputs for the different power stages entered.

The effective status of the digital output is indicated. The relation between the data in the table and the values set on the display.

Closed = ON Open = OFF

Default configuration :

% LOAD	Relay 1	Relay 2	Relay 3
25%	CLOSED	OPEN	OPEN
50%	OPEN	OPEN	CLOSED
75%	OPEN	CLOSED	OPEN
100%	OPEN	OPEN	OPEN

Configuration example :

% LOAD	Relay 1	Relay 2	Relay 3
25%	OPEN	CLOSED	CLOSED
50%	CLOSED	CLOSED	OPEN
75%	CLOSED	OPEN	CLOSED
100%	CLOSED	CLOSED	CLOSED

Stepped capacity control times

Delays are specified for capacity control management. These delays can be set when the capacity controls are enabled. Such delays indicate the minimum operating time of a compressor at a given power stage. If the machine is enabled at maximum level request, these delays prevent a changeover from power level 0 to maximum level.

Graph of times for capacity control in 4 steps:

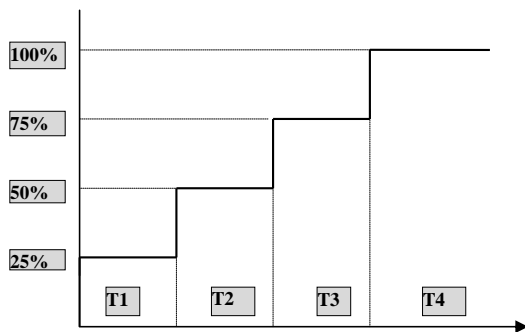

With Bitzer compressor the time T2-T3-T4 are forced to the following value:

T2: The minimum value is forced to 10 seconds

T3: zero

T4: zero

The T1 time does not have restriction.

To have more flexible management of the unloader during the unit start up and the normal working condition, it is possible to set a time (mask Te) starting from the pump on and after this the unit is in normal working mode. If this time is equal to zero then the management is disabled.

During start up mode the time T1, T2, T3 (mask T7) are respected, but in normal mode they are ignored and an equal time for all the unloaders is used set by mask Te. With Bitzer compressor the minimum time is forced to 10 seconds.

Special management of capacity control first stage

A facility is provided for enabling special management of the first stage of capacity control, managing the compressor's special requirements when it is operating at low power. In general, the control entails the use of the first capacity control stage only at power-up and if temperature falls below the control set-point. When controlling the compressor, this type of control uses a reduced power modulation range, between the second and maximum power stages.

Management varies according to whether the compressor is in its starting or disabling stage. In both cases, you are recommended not to work at 25% power for too long.

- **Starting:** after being started, if the compressor does not receive any thermostatic request for changeover to the second capacity control stage, the changeover is forced by the software after a time which can be set on the screen (T1).
- **Power-down:** if a reduction in the power of the circuit is requested, power is controlled between the maximum and second capacity control stage. Only if temperature drops below set-point value, the compressor is forced to operate according to the first capacity control stage for the set time (T1).

This special operating mode is enabled from the screen. If the first capacity control step is not enabled, it is treated as just any step. The compressor can operate at this power level for an infinite time.

Stepped capacity control with control at inlet

A description of stepped capacity control of 4 compressors with four capacity control steps each:

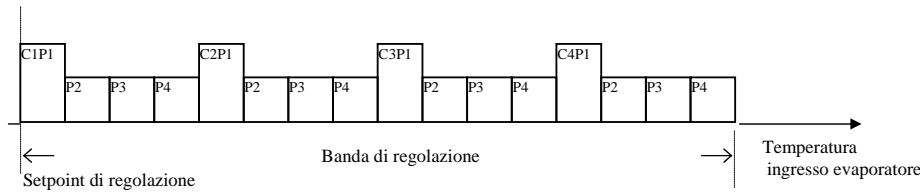

All compressors and the relevant capacity control steps will be proportionally positioned in the band. Increasing temperature values will cause the control steps to be subsequently input. Each step will be input according to the set delay times. The compressors will be started at the first entered capacity control stage. If special management of the first capacity control stage was selected, control will be effected according to the description in the dedicated section. In any event, the times for the capacity controls will be applied as described.

Stepped capacity control with control at outlet

A description of stepped capacity control of 4 compressors with four capacity control steps each:

Activation of compressors

if the water temperature measured by the probe located at the evaporator outlet exceeds the threshold of Control Set-point + Control Band (Point B), the number of power stages will be increased - the power stages were input according to the set parameter known as "delay between power-up of different devices".

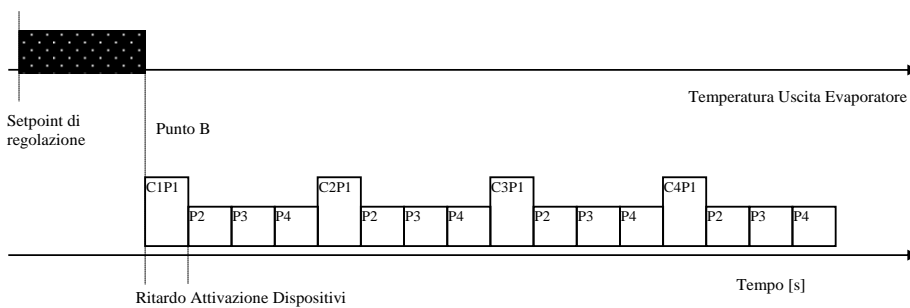

In this configuration the time between the activation of the steps will be equal to the set time between the starts of different compressors, while in the event of capacity-control, the delay time between load steps set will still be applied, and therefore the higher of the two times will prevail.

Power-down of compressors

If the water temperature measured by the probe located at the evaporator outlet falls below the Control set point (Point A), then the number of load steps will be decreased, according to the parameter "device deactivation delay".

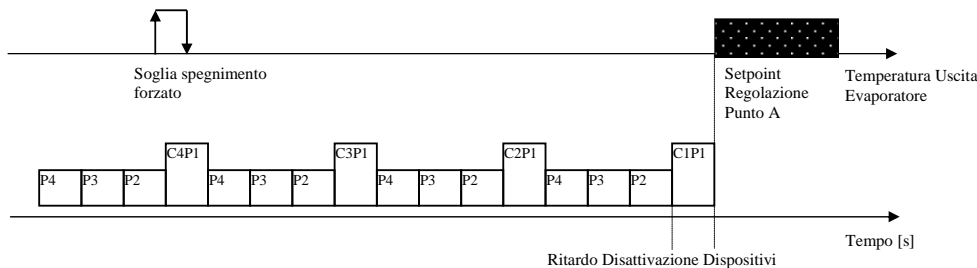

If the temperature falls below the forced off threshold, the compressors are stopped irrespective of the set delays, to avoid the activation of the antifreeze alarm.

Continuous capacity control

A maximum number of four compressors are managed, with continuous capacity control. The compressor's capacity is controlled by two relay outputs, which, when suitably controlled, enable compressor power to be increased or reduced, varying the capacity of the compression chamber. Compressor power is controlled by sending impulses to the outputs of the capacity control relays. These impulses command the compressor to be charged or discharged. These impulses are at a constant frequency, settable, and of variable duration between two minimum and maximum limits, also settable. As there is no acquisition regarding the absolute position of the compressor's capacity control valve, and consequently, as no direct verification is possible of the power percentage input in the circuit, a time based control is run. With this control, when a set time threshold is reached, the compressor is considered fully charged/discharged and thus control of the capacity control impulses is suspended.

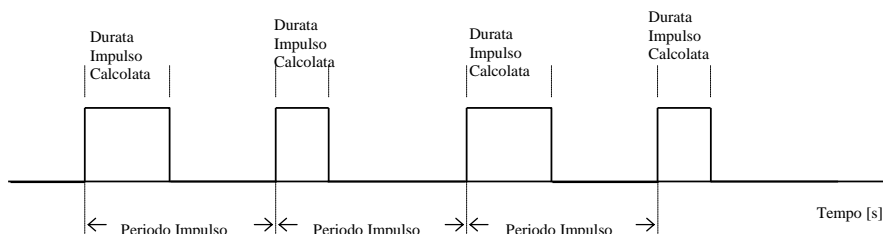

13.4.1 Configuration of continuous capacity control relays

The control method of the capacity control relays differs for each compressor. Therefore, the software has a facility for configuring the enabling sequence according to the needs of different compressor manufacturers.

For multi-card systems: as several compressors are housed on the same machine, it is considered that the compressors controlled by each pCO are perfectly equal and, therefore, the capacity control configuration selected on board the master card also applies to the slave cards. The following table shows examples of the configuration of the dedicated digital outputs for the different power stages entered.

The effective status of the digital output is indicated.

The relation between the data in the table and the values set on the display.

Closed = ON

Open = OFF

Default configuration :

Compressor behaviour	Relay 1	Relay 2
Power reduction	CLOSED	CLOSED
Power stand-by	OPEN	CLOSED
Power increase	OPEN	OPEN

The power stand-by configuration is taken on by the outputs when no variation of input power is requested, or if the maximum/minimum compressor power is reached, or because the water temperature measured by the probe located at evaporator outlet is inside the neutral control zone. For compressor charging /discharging, the digital outputs of the pCO card are commanded alternately according to the stand-by and charge/discharge configuration, causing the dedicated relay to pulse.

13.5 Continuous capacity control with control at outlet

Temperature control with compressors on continuous capacity control can occur only if control at outlet is selected, according to the temperature values measured by the probe located at evaporator outlet. To that end, further configuration parameters are input. They are specific for the particular type of compressor, and are added to those previously mentioned in the description of the special type of control.

Employed Parameters:

- Neutral zone for continuous capacity control
- Impulse period
- Charging impulse minimum duration
- Charging impulse maximum duration
- Discharging impulse minimum duration
- Discharging impulse maximum duration
- Forced discharge period at compressor power-up
- Capacity control relay forcing enabled when compressor is OFF:

Outputs used :

- Compressor capacity control Relay 1
- Compressor capacity control Relay 2

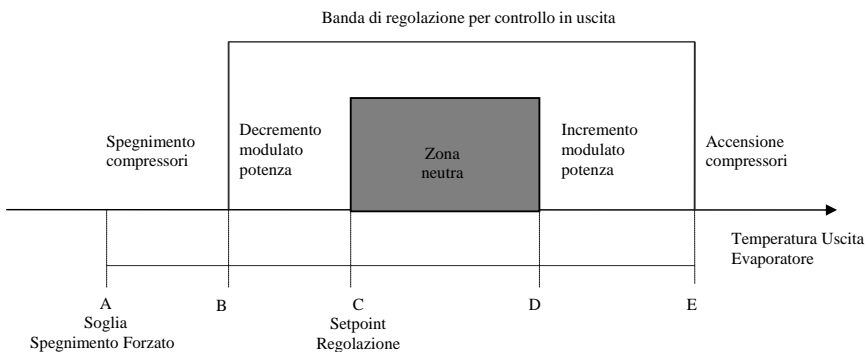

13.5.1 Control of continuous capacity control according to points in the graph

According to the set-point values, the control band with control at output and the neutral zone of compressors on continuous capacity control, points C, D and E are identified. If the water temperature measured by the probe located at evaporator outlet exceeds point E

$$\text{Point E} = \text{Control set point} + \text{Control band}/2 + \text{Dead zone} /2$$

Then there will be a request for the compressor to start and an increase in capacity according to charge impulses of the maximum duration until reaching the maximum compressor load time. If the water temperature measured by the probe located at evaporator outlet is below point B

$$\text{Point B} = \text{Control set point} + \text{Dead zone} /2 - \text{Control band}/2$$

In this case, there is a request for the compressors to be discharged according to the maximum duration impulses until compressor maximum discharging time is reached and until possible power-down. If the water temperature measured by the probe located at the evaporator outlet is between points D-E/B-C

$$\text{Point D} = \text{Control set point} + \text{Dead zone}$$

$$\text{Point C} = \text{Control set point}$$

Then the power of the compressor will be increased/reduced by impulses of variable duration according to the values calculated within the minimum and maximum limits set for an infinite time.

13.5.2 Power-up of compressors (temperature above point E)

The compressors are powered up in sequence at a rate calculated by the set time required to reach maximum power. As there is no absolute measurement of the effective capacity, when the compressor is started it performs a forced unload cycle for a set time (unloader relays energised continuously according to the unload configuration). Subsequently, the compressor power will be increased by maximum duration impulses.

13.5.3 Increase of compressor power

When the maximum time limit for reaching maximum power is reached, a forced charging cycle is commanded for a time of 20% of the set threshold, then the compressor capacity control relays change to the power stand-by configuration.

If the temperature remains in the power-up zone (beyond point E), every ten minutes a forced charging cycle is commanded with a duration of 20% of the time required to reach the maximum set power.

In the case of multi-compressor units, the periodic forced charging cycle will be carried out by all powered-up compressors which have reached maximum power.

13.5.4 Modulated increase of power (temperature in range between points D-E)

The compressor's power is modulated in this temperature range, by applying charging impulses of variable duration to the capacity control relays (duration is calculated between the minimum and maximum values set according to the measured temperature values).

For multi-compressor units, modulated increase of power will occur simultaneously for all powered-up compressors.

13.5.5 Operation of compressor in neutral zone (temperature in range between points C-D)

If the temperature value locates inside the neutral zone, the capacity control relays of all powered-up compressors change to the power stand-by configuration, thus maintaining the power level that had been reached.

13.5.6 Modulated reduction of power (temperature in range between points C-B)

The compressor's power is modulated in this temperature range, by applying discharging impulses of variable duration to the capacity control relays (duration is calculated between the minimum and maximum values set according to the measured temperature values). For multi-compressor units, modulated reduction of power will occur simultaneously for all powered-up compressors.

13.5.7 Power-down of compressors (temperature below point B)

The compressors are first unloaded by sending unload impulses of the maximum duration to the unloader relays. The compressors are then powered down, by reducing the number of requested devices, at a rate equal to the time required to reach minimum set power.

FIFO Rotation is applied, whereby the first powered-up compressor is discharged and then powered-down. Instead, if rotation is disabled, the last powered-up compressors is discharged and then powered down.

13.5.8 Derivative regulation in the increasing zone

In the increasing zone, Tb mask, comes controlled every "Derivative Time" if the outlet temperature is changed in order more than 0,2 °C. If this is true the compressor remains in stand-by until the new control. This management can be disabled with "Derivative time" equal to 0.

14. Compressor rotation

Compressor calls are rotated in order to equal the number of duty hours and power-ups among the devices. Rotation follows the FIFO logic: the first compressor to be powered up is the first to be powered down. At the initial stage, there may be considerable differences in the on-duty hours of the compressors, however, the hours are very similar to each other in steady state. Rotation occurs only among compressors and not among capacity controls, and, in any case, this type of rotation operates only if the compressors have stepped capacity control.

Rotation-free management

- Power-up: C1,C2,C3,C4.
- Power-down: C4,C3,C2,C1.

FIFO rotation management (the first compressor to be powered up is the first to be powered down):

- Power-up: C1,C2,C3,C4.
- Power-down: C1,C2,C3,C4.

15. Starting a single compressor

15.1.1 Description of operation

The start-up stages are described in the following graph

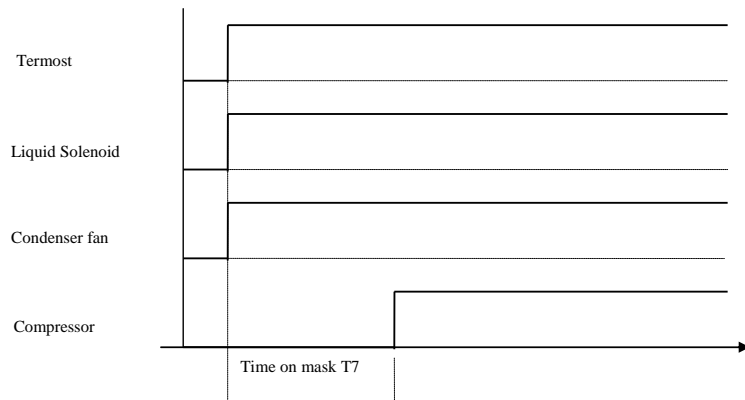

From mask T7 it is possible to set the liquid solenoid and compressor start sequence. Pay attention that during this time the condenser fan are force to maximum speed.

15.2 Starting the compressor motor

15.2.1 Delta / Star starting

Starting the motor is described in the following diagram

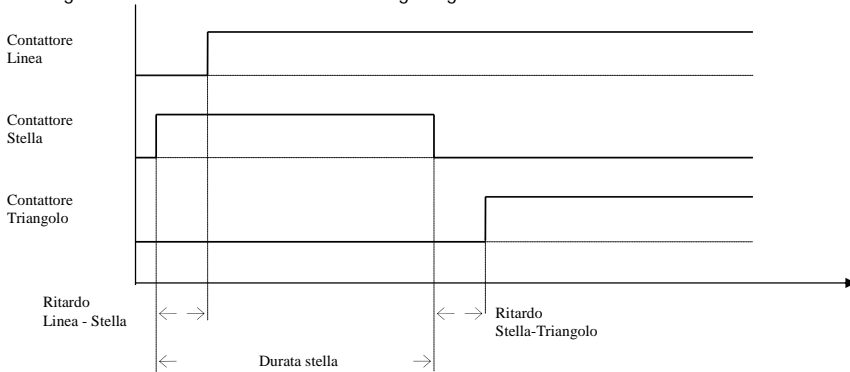

15.2.2 Start-up with Part - Winding

To start the compressor with part-winding, you must reset the star and delta-star times, setting the desired part-winding time as the delta-star time. The outputs used are those of the line and triangle relays, used respectively as part-winding relays A and B. Example:

Star-line time 0 / 100 s

Star Time 0 / 100 s

Delta-star time 100 / 100 s for a part-winding time of 1 s.

15.3 Compressor start restrictions

There are two start restricting methods. Both start the compressor directly with the delta contactor, by-passing the star contactor. There is a single enablement for both cases:

1. Set high and low pressure thresholds exceeded
2. Set equalised pressure threshold exceeded (equalised pressure is the average pressure between high and low pressure measured by the transducers).

16. Forced capacity control

Inputs used

- Water temperature at evaporator outlet
- Compressor delivery temperature
- Condensation pressure
- Current

Parameters used

- High delivery temperature prevention threshold
- High delivery temperature prevention differential
- High pressure prevention threshold
- High pressure prevention differential
- Antifreeze temperature prevention threshold
- Antifreeze temperature prevention differential
- Forced selection of compressor at minimum/maximum power
- High current alarm threshold
- High current alarm percentage differential
- Delay time to signal the high current alarm
- Delay time to prevent high current from compressor start

Outputs used

- All compressor capacity control relays

16.1.1 Description of the condensing pressure-antifreeze-discharge temperature prevent function

The compressor forced capacity control function prevents the unit from operating in abnormal conditions of pressure, refrigerated water temperature or condensation temperature, thus preventing any intervention by specific alarms. A parameter is provided for selecting the compressor operating mode if forced capacity control is enabled. The compressor can be taken to minimum/maximum power according to the selection when:

- High delivery temperature threshold exceeded
- High pressure threshold exceeded
- Antifreeze temperature threshold exceeded

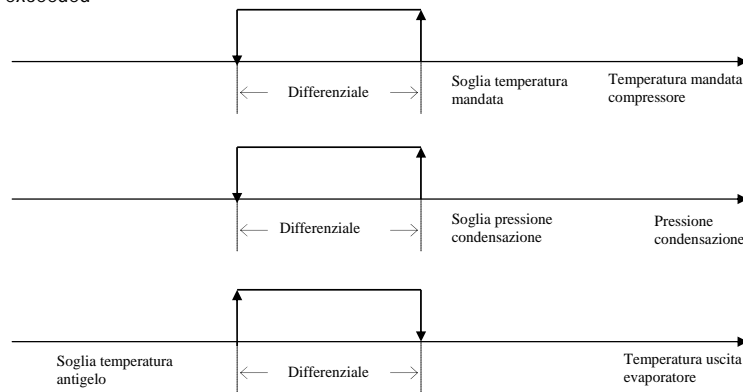

16.1.2 Description of the high current prevent function

If the probe for measuring the current input is enabled and correctly configured, forced capacity control is active for the high current condition.

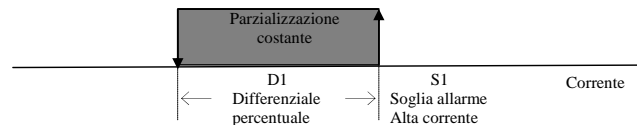

The high current is controlled on a settable alarm threshold and differential. After a delay time from when compressor starts, is the current measured exceeds the set alarm threshold, a preventive action starts, which involves gradually decreasing the capacity of the compressor. The frequency of capacity reduction is equal to 1/3 of the set time T1 (delay time for signalling the high current alarm); in the case of compressors with stepped capacity control, the number of steps on will gradually be reduced, in the case of compressors with continuous capacity control, the unload will be managed with impulses lasting equal the minimum set time. There is a settable differential to return from the forced capacity control condition, expressed as a percentage of the alarm differential. The return of the current to values below the alarm threshold and in any case within the set differential will not cause any variation to the capacity of the compressor.

The activation of a further forced capacity-control function due to pressure or temperature will be managed by assigning higher priority to the function that involves a greater decrease in compressor capacity. The duration of the current measured above the alarm threshold for a continuous time that exceeds the set time, will involve the activation of the corresponding high current alarm, with the immediate shutdown of the compressor and the need for manual reset by the user.

16.1.3 Compressors with stepped capacity control

For compressors with stepped capacity control, forced capacity control means that the compressor has to operate at minimum or maximum power according to selection.

16.1.4 Compressors with continuous capacity control.

For compressors with continuous capacity control, forced capacity control means that the compressor has to operate in continuous charging or discharging mode according to selection.

17. Solenoid-valve management.

Inputs used:

- Compressor delivery temperature

Parameters used:

- Solenoid-valve activation threshold
- Solenoid-valve differential

Outputs used:

- Economizer solenoid-valve, oil-cooler, liquid-injection

17.1.1 Description of operation

A digital output is provided for controlling an economizer solenoid-valve, oil-cooler and liquid injection. Activation depends on the compressor discharge temperature read by the probe, as shown in the following graph:

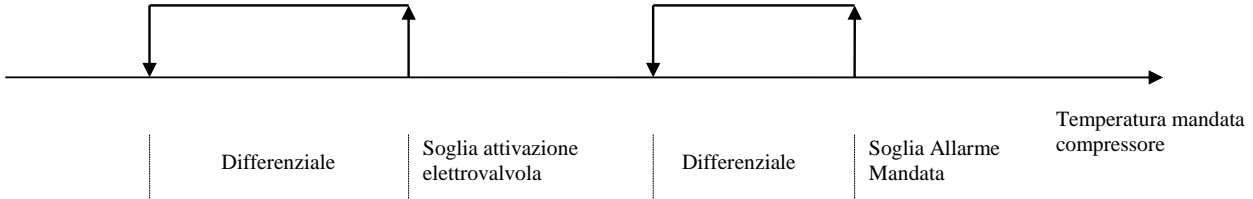

18. Pump-down

Inputs used

- Low Pressure Pressure-switch

Parameters used

- Enable pump - down
- Pump - down maximum duration

Outputs used

- Liquid Solenoid
- Windings for compressor Line - Delta - Star
- All compressor capacity control relays

18.1.1 Description of operation

If enabled, pump-down occurs by the thermostat disabling the compressor.

The duration of the function can be set, and ends after a maximum time or if the low pressure switch is activated.

If any alarm powers down the machine or even just the compressor, the pump-down finishes immediately.

The activation of the pump-down function operates the compressor in forced capacity control mode:

- for compressors with stepped capacity control, the compressor operates at the minimum/maximum capacity.
- for compressors with modulating capacity-control, the compressor operates in continuous unload/load.

19. Condensation control

Condensation can be performed in the following modes:

- ON/OFF linked to compressor operation (without pressure transducers)
- ON/OFF or modulating linked to reading by the pressure transducer (if the high pressure transducers were enabled)
- ON/OFF or modulating linked to reading by the battery temperature probes (if the battery temperature probes were enabled)

Employed Inputs:

- Condensing pressure probe
- Condenser coil temperature probe

Outputs used:

- Fan 1
- Fan 2
- Speed control for fans AOUT 1

Employed Parameters:

- Selection of condensation control None /pressure/temperature
- Condensation set point
- Condensation band
- Number of fans
- Enable prevent function
- Prevent threshold
- Prevent differential
- Output voltage for inverter minimum speed
- Output voltage for inverter maximum speed
- Inverter speed-up time

19.1 ON/OFF condenser control linked to compressor operation

Fan operation will solely depend on compressor operation:

Compressor OFF = fan OFF

Compressor ON = fan ON

19.2 ON/OFF condenser control linked to the pressure or temperature sensor

Fan operation depends on compressor operation and on the value read by the pressure or temperature sensors according to a set point or to a band. When the pressure/temperature is lower than or equal to the set point, all fans are OFF, but when the pressure/temperature rises to set point + band, all fans are ON.

19.3 Modulating condenser control linked to the pressure or temperature sensor

With this type of condensation, the fans will be controlled through a 0/10 V analogue output, in proportion to demand by the pressure/temperature sensors. If the lower limit of the ramp is greater than 0 V, there will not be a proportional straight line, but, as in the first section of the graph, it will be below the set point-diff. by one step.

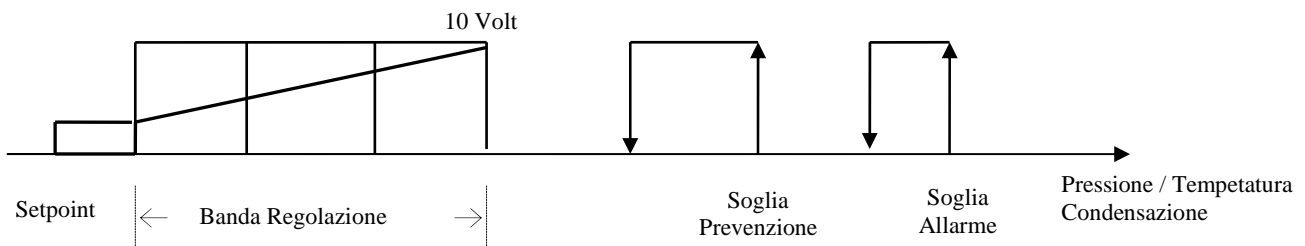

19.4 Prevent function

This function can be selected under the constructor password, and is used to prevent circuits shutting down due to high pressure. With the compressor ON, when this threshold is reached, the compressor is capacity-control forced until pressure returns to below the set point - of a settable differential. With the compressor OFF, when this threshold is reached, the fans are capacity-control forced until pressure returns to below the set point - a settable differential.

21. Free Cooling Control

Inputs used

- Water temperature at evaporator outlet
- Water temperature at inlet of Free Cooling battery
- External air temperature

Parameters used

- Type of unit
- Number of units
- Type of condensation
- Number of fans
- Free Cooling valve type
- Free Cooling type control
- Integration time
- Control set point
- Control setpoint offset
- Minimum Free Cooling Delta
- Maximum Free Cooling Delta
- Free Cooling Control differential
- Maximum threshold for Free Cooling valve opening
- Minimum threshold for condensation speed controller
- Free Cooling antifreeze threshold
- Compressor activation delay

Outputs used

- Condenser fans
- Condensation fans speed controller
- Free Cooling ON/OFF valve
- Free Cooling 3-way valve

21.1.1 Description of operation

Free Cooling control makes it possible to exploit the temperature conditions of external air to facilitate cooling use water. To this end, a heat exchanger is supplied. If necessary, a certain quantity of water is returned to this exchanger by the system, deviated via an appropriately commanded valve.

The favourable conditions of outside air cause the water to cool beforehand, and, therefore activation of the cooling devices is delayed.

Free Cooling is available in the air/water unit in the internal Free Cooling mode only. i.e. with the Free Cooling battery housed inside the machine near the condensation battery/ies, with which it shares control of the condensation fan/s.

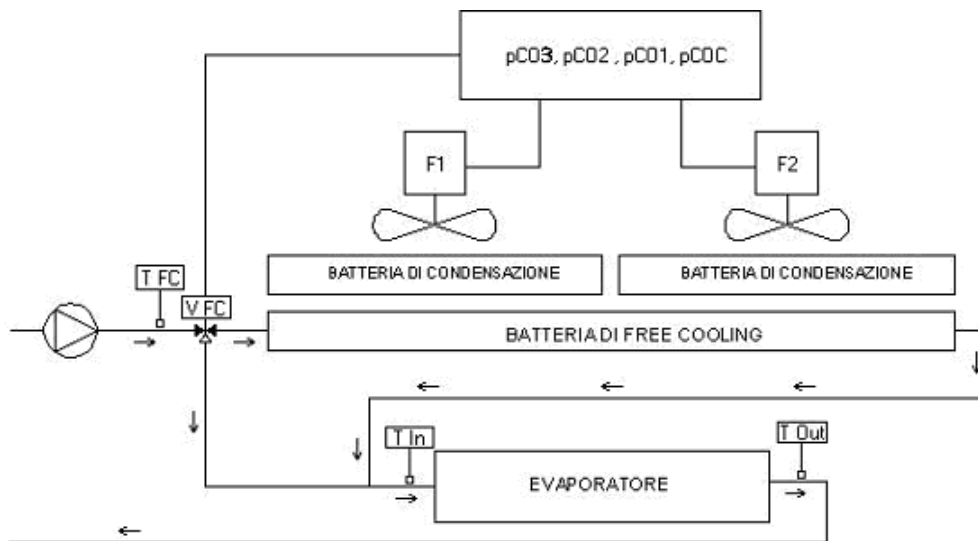

21.2 Free Cooling activation condition

The entire Free Cooling procedure is based on a relationship between the temperature value measured by the external temperature probe, and the temperature value measured by the temperature probe located at the input of the Free Cooling heat exchanger and the set Free Cooling delta.

$$\text{External } T. < \text{Free Cooling Input } T. - \text{Min. Delta Freecooling}$$

If this condition is true, the freecooling function will be enabled, by activating/deactivating the dedicated devices.

21.3 Free Cooling Thermostat

Free Cooling control exploits the calculated control set point values (taking into account any compensation) and the set Free Cooling control differential. The control is based on the water temperature measured by the probe located at the evaporator outlet, considering the effective supply of cold of the Free Cooling exchanger according to the different external temperature conditions.

Two different control modes can be selected: proportional, proportional + integral - the integration constant must be set in the latter case.

The set point for thermostatic control of Free Cooling will be determined according to the nominal value of the temperature of the water you wish the unit to produce. Depending on the type of control adopted for the compressors (inlet – outlet), as the temperature references are different, two distinct control graphs will be identified. In machines controlled output with a neutral zone, the Free Cooling control set point will correspond to the control set point of the compressors.

Free Cooling Set point = Compressors set Point

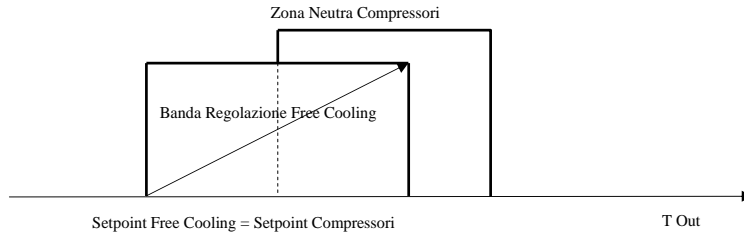

The proportional control band will be equally distributed at the sides of the set point. The proportional band will be equally distributed on both sides of the set point. In units with inlet control and proportional band, the freecooling control set point will use an offset from the compressor control set point to compensate for the presence of the evaporator coil.

Free Cooling Set point = Compressors Set-point - Offset

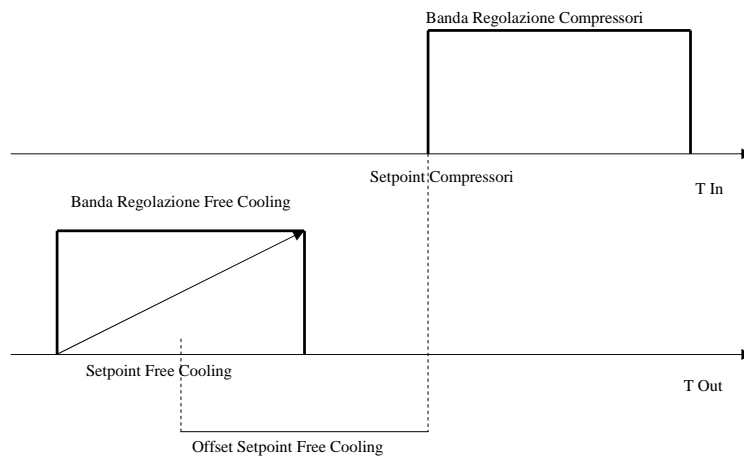

The proportional control band will be equally distributed at the sides of the set point. In the Free Cooling control band, the activation thresholds for dedicated devices (e.g. valves and fans or speed variators) will be calculated in different ways according to the type of selection.

As the fans and/or speed variators are shared by Free Cooling control and condensation control, if one or more compressors in a given refrigerating circuit is/are enabled, priority will be given to condensation control to protect the circuit itself.

The Free Cooling valve will, in any event, be maintained fully open to provide as high as possible a thermal yield even at minimum ventilating capacity.

To optimise Free Cooling performance during the machine start transients and in steady state operating situations, a by-pass time is applied for thermostatic control of the compressors.

The purpose of this time is to delay the activation of the compressors in order to give Free Cooling sufficient time to reach the steady state conditions and take the machine's yield to nominal value. Only after this time has elapsed, and with the main thermostat dissatisfied, the compressors are commanded to operate. If time is set to 0, the function will be disabled. While the unit is operating, the same parameter is used by Free Cooling control to reassess the machine's working conditions according to the value measured by the external temperature probe. A further temperature delta should be set. This identifies a second threshold below which the yield of the Free Cooling battery is so high that it can fully satisfy the system's thermal load solely through combined operation of valve and fans.

If the compressors are ON, the external temperature falls below "maximum delta" set according to the following relation:

$$\text{External T.} < \text{Free Cooling Input T.} - \text{Free Cooling "Maximum Delta"}$$

and this condition continues for a continuous time period equal to the set by-pass time for the compressors. When this time has elapsed, the compressors will be commanded to OFF followed by a changeover to pure Free Cooling operation to satisfy load requirements with minimum use of energy. When the by-pass time for thermostatic control of the compressors has again elapsed, the requests will be re-assessed.

An antifreeze threshold is specified. It is based on the temperature value of external air to protect the heat exchanger when operating in a cold environment. If the temperature of external air is lower than the set threshold, the valve controlling water flow inside the Free Cooling exchanger will be commanded to open, and the main circulation pump will be enabled (if OFF). This pump moves the fluid and prevents the interior of the exchanger from freezing.

If the valve is a 0-10V type, the degree of opening will depend on the unit's operating status.

- with the unit off the valve will open to 100% of capacity
- with the unit on the valve will open to 10% of capacity

If the valve is of the ON/OFF type, it will always open to maximum value irrespective of the unit's operating mode.

The entire procedure will finish as soon as the external air temperature reaches a fixed hysteresis of 1.0°C with respect to the set threshold.

21.4 Free Cooling disabling conditions

There are two main causes of the closure of the Free Cooling valve: the first depends on the external temperature conditions, and the second on thermostatic demand. The freecooling valve will be closed if the freecooling conditions are no longer present

$$\text{External T.} < \text{Free Cooling Input T.} - (\text{Free Cooling Delta}) + 1.5^{\circ}\text{C}$$

The Free Cooling valve will close if the Free Cooling thermostat is satisfied. For system safety, the reading of the water temperature probe at the evaporator outlet will be checked. According to the set thresholds, the following will be processed: an antifreeze pre-alarm, which will enable any post-heating heaters and totally disable the Free Cooling devices; and an antifreeze alarm which will totally disable the unit. Other system safety devices: serious alarm from digital input, circulation pump thermal cutout, failed control probe, failed antifreeze control probe, evaporator flow-switch alarm, phase monitor alarm. These safety device will totally disabled the unit, and, therefore, stop the Free Cooling control.

21.5 Free Cooling ON/OFF valve

21.5.1 Proportional control

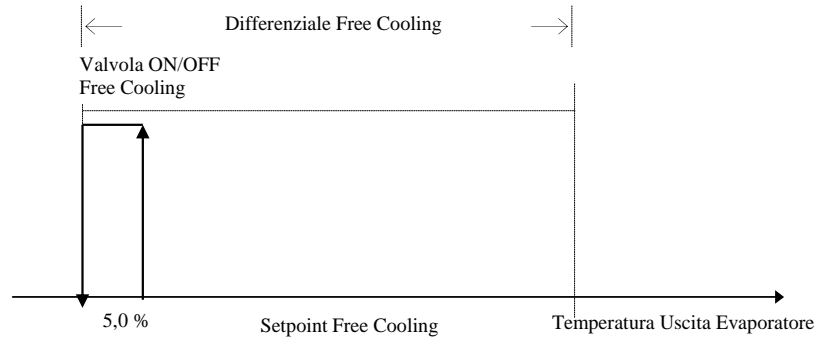

If temperature conditions favour Free Cooling control, the Free Cooling ON/OFF valve will be activated as soon as temperature exceeds the activation threshold of the individual step, identified by a temperature value of:

$$\text{Control Set point} - \text{Free Cooling Differential} + 5.0\% \text{ Free Cooling Differential}$$

The step amplitude is fixed at 5.0% of the set Free Cooling control differential.

21.5.2 Proportional + integral control

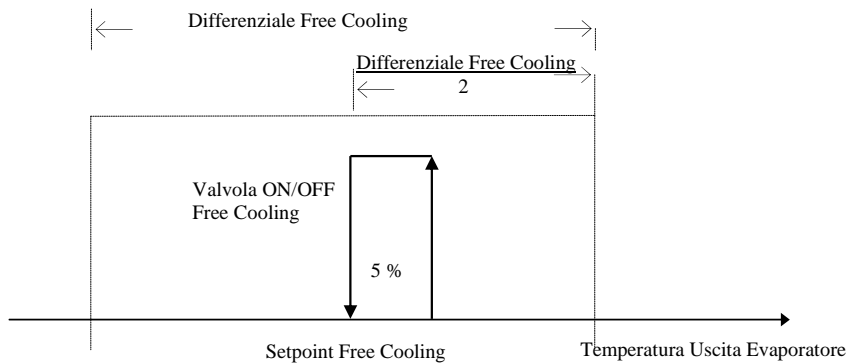

If temperature conditions favour Free Cooling control, the Free Cooling ON/OFF valve will be activated as soon as temperature exceeds the activation threshold of the individual step, identified by a temperature value of:

$$\text{Control Set point} + 5.0\% \text{ Freecooling differential}$$

The step amplitude is fixed at 5.0% of the Free Cooling control differential.

21.6 Free Cooling ON/OFF valve with stepped condensation

21.6.1 Proportional control

Here is an example of Free Cooling control with ON/OFF valve and three condensation steps.

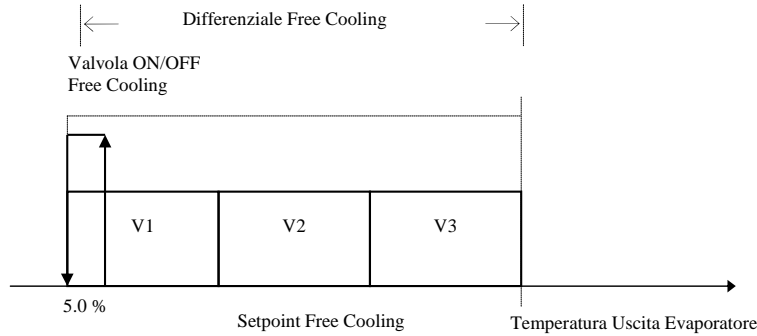

The ON/OFF valve activation step will, in any case, be positioned in the first part of the control differential and will have an amplitude of 5.0% of the said differential. The activation steps of the condensation fans will be positioned proportionally inside the Free Cooling control differential.

To calculate the amplitude of each step, use the following relation:

$$\text{Step amplitude} = \frac{\text{Free Cooling Differential}}{(\text{Number of Master fans} \times \text{number of cards})}$$

It is assumed that all the circuits controlled by the pCO cards making up the system are equivalent and that the number of controlled devices is the same.

21.6.2 Proportional + integral control

Here is an example of Free Cooling control with ON/OFF valve and three condensation steps.

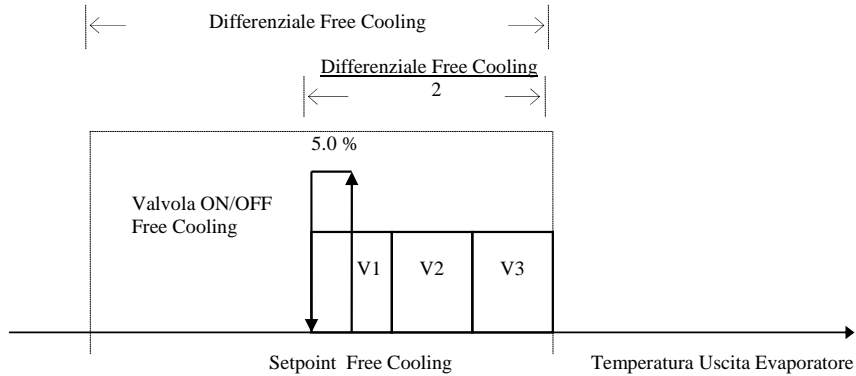

The devices, whether they are valve or fans, will be activated in the second half of the control differential through the effect of the integrating control. Their activation will be tied to the set integrating constant: the slower it is, the greater the value attributed to the specific parameter.

The amplitude of the valve control step will be 5.50% of the said control differential.

The amplitude of the fan control steps will be calculated according to the following relation:

$$\text{Step amplitude} = \frac{\text{Free Cooling Differential}}{(\text{Number of Master fans} \times \text{number of cards})}$$

It is assumed that all the circuits controlled by the pCO cards making up the system are equivalent and that the number of controlled devices is the same.

21.7 Free Cooling ON/OFF valve with inverter controlled condensation

21.7.1 Proportional control

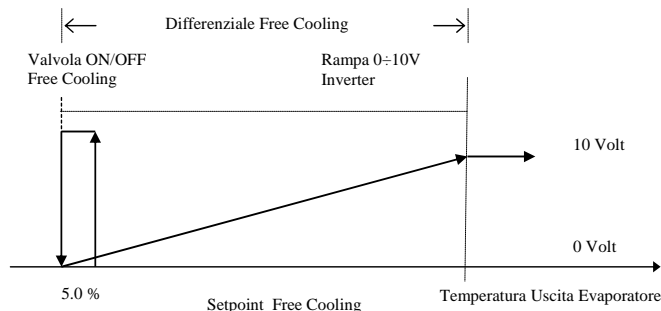

The ON/OFF valve activation step will, in any case, be positioned in the first part of the control differential and will have an amplitude of 5.0% of the said differential. The proportional ramp for piloting the analogue control output of the condensation inverter will be calculated on the entire control differential. If necessary, Value 0-10 Volt can be further limited downward according to the minimum output voltage value set on the screen.

All proportional outputs relating to the different units of the system will be piloted in parallel

21.7.2 Proportional + integral control

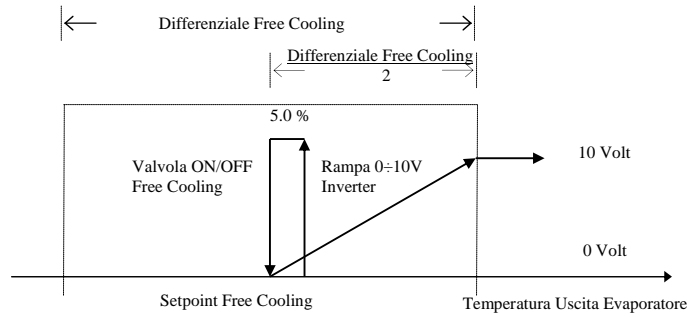

The devices, whether they are valve or fans, will be activated in the second half of the control differential through the effect of the integrating control. Their activation will be tied to the set integrating constant: the slower it is, the greater the value attributed to the specific parameter. The amplitude of the valve control step will be 5.50% of the said control differential. All proportional outputs relating to the different units of the system will be piloted in parallel

21.8 0-10 Volt Free Cooling ON/OFF valve

The Free Cooling valve is proportionally commanded in a different way depending on whether condensation control is in steps or by inverter. The control diagrams of the two different situations are shown below.

21.9 0-10 Volt Free Cooling ON/OFF valve with stepped condensation

21.9.1 Proportional control

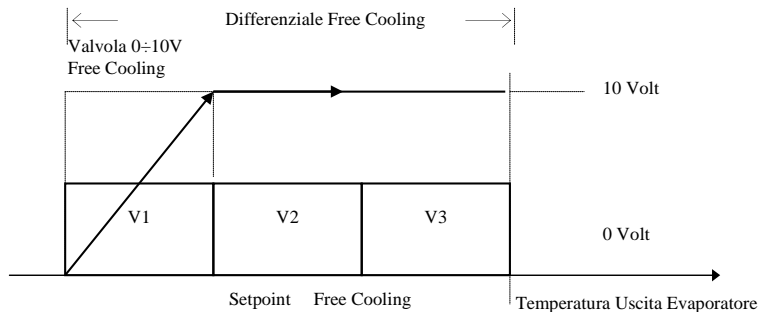

The proportional control ramp of the Free Cooling valve will be calculated inside the first activation step of the condensation fans. In this way, when the first fan is enabled, the valve will be completely open, and, therefore, water flow in the Free Cooling exchanger will be at maximum level. The activation steps of the condensation fans will be positioned proportionally inside the Free Cooling control differential. To calculate the amplitude of each step, use the following relation:

$$\text{Step amplitude} = \frac{\text{Free Cooling Differential}}{(\text{Number of Master fans} \times \text{number of cards})}$$

It is assumed that all the circuits controlled by the pCO cards making up the system are equivalent and that the number of controlled devices is the same.

21.9.2 Proportional + integral control

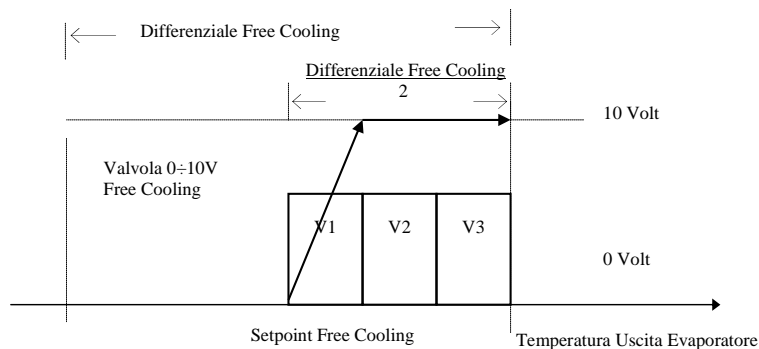

The devices, whether they are valve or fans, will be activated in the second half of the control differential through the effect of the integrating control. Their activation will be tied to the set integrating constant: the slower it is, the greater the value attributed to the specific parameter. The proportional control ramp of the Free Cooling valve will be calculated inside the first activation step of the fans. In this way, when the first fan is enabled, the valve will be completely open, and, therefore, water flow in the Free Cooling battery (exchanger) will be at maximum level. The activation steps of the fans will be positioned proportionally inside the Free Cooling control differential.

To calculate the amplitude of each step, use the following relation:

$$\text{Step amplitude} = \frac{\text{Free Cooling Differential}}{(\text{Number of Master fans} \times \text{number of cards})}$$

It is assumed that all the circuits controlled by the pCO cards making up the system are equivalent and that the number of controlled devices is the same.

21.10 0-10 Volt Free Cooling valve with inverter controlled condensation

21.10.1 Proportional control

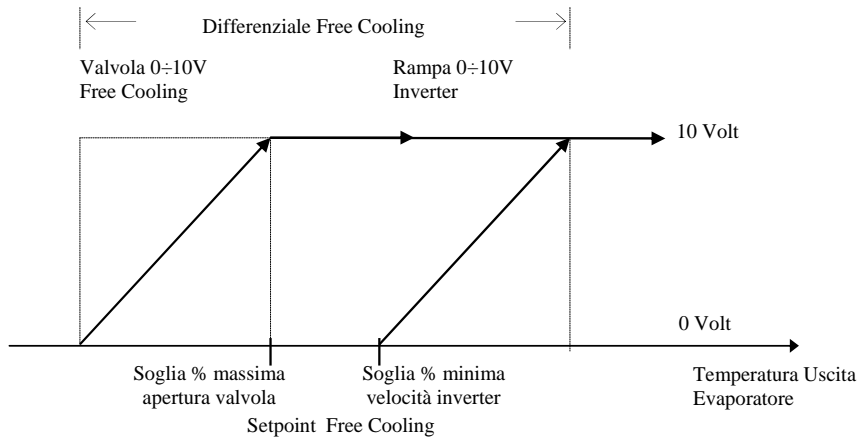

The control proportional ramp of the Free Cooling valve will be calculated inside the area determined by the thresholds:

Control Set point -Free Cooling Differential/2

Control Set point -Free Cooling Differential/2 + valve maximum opening % Threshold

The control proportional ramp of the condensation inverter will be calculated inside the area determined by the thresholds:

Control Set point -Free Cooling Differential/2 + inverter speed minimum % Threshold

Control Set point + Free Cooling Differential/2

The start/end points of the two control ramps can be modified at the user's discretion by varying the value of the thresholds (see graph) as a percentage of the value of the set Free Cooling differential.

For the Free Cooling valve, the setting field ranges from 25 to 100% of the differential.

For the condensation inverter, the setting field ranges from 0 to 75% of the differential.

Example

Control setpoint	12.0°C
Free Cooling Differential	4.0°C
Free Cooling valve % threshold	40%
Condensation inverter % threshold:	80%

Proportional area for control of Free Cooling valve = $10.0 \div 11.6 \text{ }^\circ\text{C}$
 Control Set point - Free Cooling Differential/2 = 10.0°C
 Maximum % threshold for valve opening = 1.6°C

Proportional area for control of condensation inverter = $13.2 \div 16.0 \text{ }^\circ\text{C}$
 Control Set point - Free Cooling Differential/2 = 10.0°C
 Control Set point - Free Cooling Differential/2 + inverter speed minimum % Threshold = 13.2°C

21.10.2 Proportional + integral control

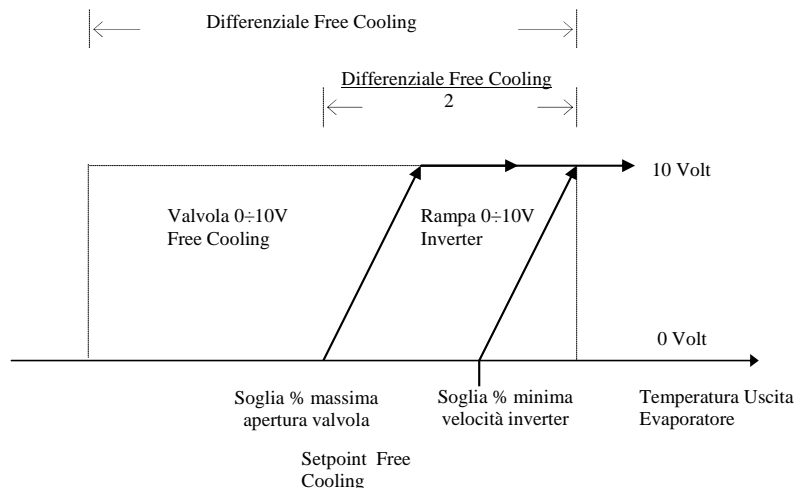

The devices, whether they are valve or fans, will be activated in the second half of the control differential through the effect of the integrating control. This activation will be constrained by the set integrative constant. The greater the value assigned to the integration time, the slower the system's response.

22. Control algorithm for Bitzer screw compressors

Carel developed a second Algorithm according to the Bitzer specifications to manage and protect their compressors.

By setting the "Compressor Type" parameter to "Bitzer Steps" or "Bitzer Stepless", the compressor's control algorithm is automatically set according to their specifications.

With this kind of compressor, it is best to use hardware with SSR outlets to guarantee a long control life, because the CR4 valve switchings in the Steps and CR3 and CR4 in the Stepless are very high.

In this case, the hardware codes become PCO1004CM0, PCO3002AM0 or PCO3002BM0 and for the connection table (chpt. 7) see the Bitzer column.

The Bitzer management is integrated into the software application and keeps the suction and outlet pressure conditions under control, optimising the compressor fridge capacity both via the management of the control valves in step mode and in continuous control mode.

On the basis of the refrigerant selected via the "Refrigerant" parameter, the Bitzer management considers the compressor's application limits, that is, the enveloping of the pressures according to the Bitzer specifications. With this compressor, only the R407c, R22, R134a refrigerants can be selected.

This enveloping of the application limits.

Diagramma di applicazione

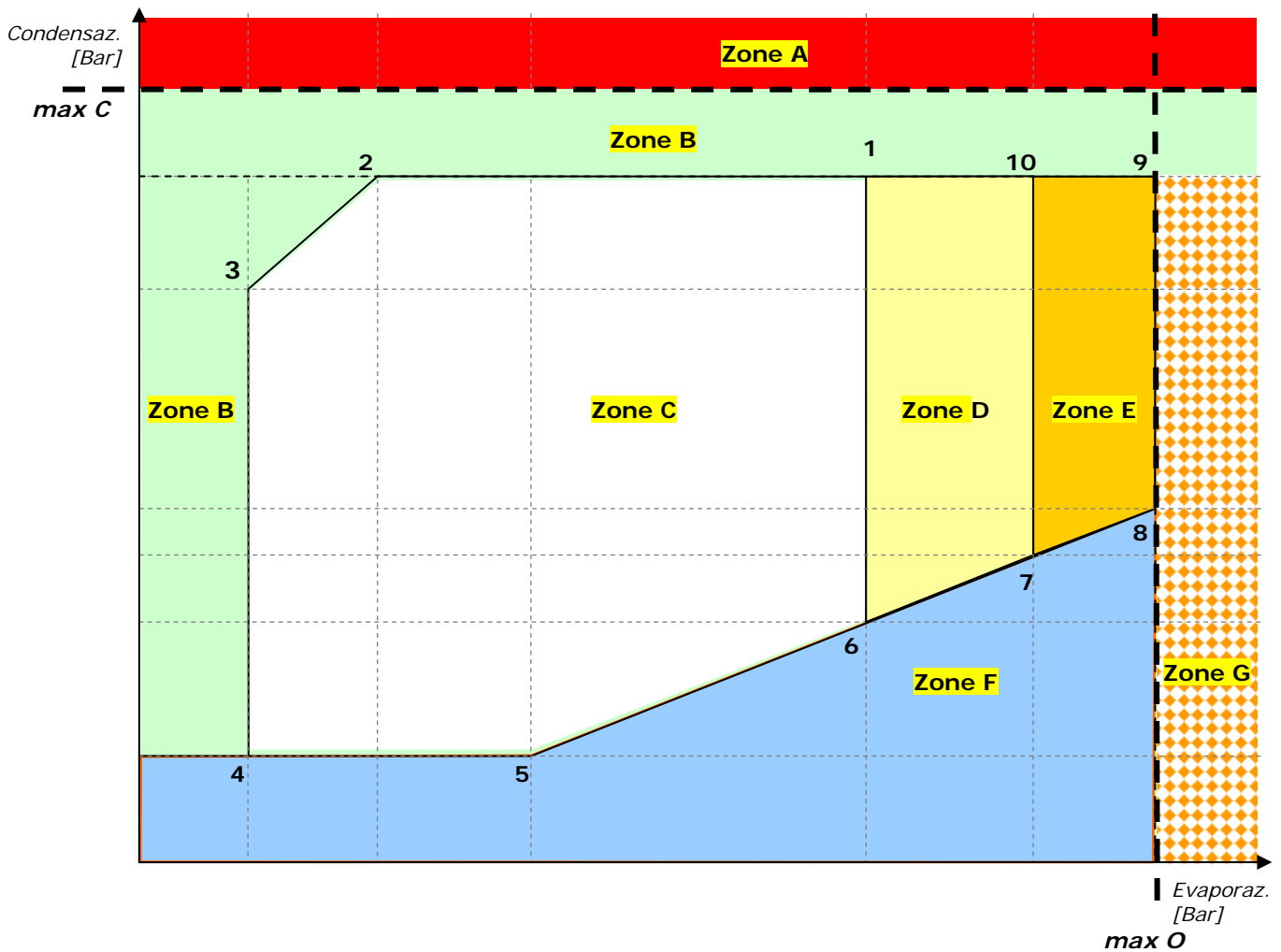

For each refrigerant, the polygon changes shape according to the following levels in the table.

Absolute pressures												
Polygon points	R22 With or without ECO				R134a ECO With or without ECO				R407C With or without ECO			
	to	po	tc	pc	to	po	Tc	pc	to	po	tc	pc
1	12,5	7,3	60,0	24,3	12,5	4,5	60,0	16,8	12,5	7,0	60,0	25,3
2	-10,0	3,5	60,0	24,3	-13,0	1,8	60,0	16,8	-8,0	3,5	60,0	25,3
3	-15,0	3,0	55,0	21,7	-15,0	1,6	58,0	16,0	-15,0	2,6	55,0	22,4
4	-15,0	3,0	20,0	9,1	-15,0	1,6	20,0	5,7	-15,0	2,6	20,0	8,8
5	-3,0	4,5	20,0	9,1	-10,0	2,0	20,0	5,7	0,0	4,6	20,0	8,8
6	12,5	7,3	32,5	12,7	12,5	4,5	35,0	8,9	12,5	7,0	32,5	12,6
7	15,0	7,9	34,0	13,2	15,5	5,0	37,0	9,4	15,0	7,6	34,0	13,1
8	17,5	8,5	35,8	13,8	20,0	5,7	40,0	10,2	17,5	8,2	35,8	13,8
9	17,5	8,5	60,0	24,3	20,0	5,7	60,0	16,8	17,5	8,2	60,0	25,3
10	15,0	7,9	60,0	24,3	15,5	5,0	60,0	16,8	15,0	7,6	60,0	25,3
max c			60,0	24,3			65,0	18,9			60,0	25,3
max o	17,5	8,5			20,0	5,7			17,5	8,2		

22.1 Protection

Apart from the standard protection with the high and low pressure switches, the heat windings, the oil differential pressure switch and the Bitzer management keeps the compressor away from dangerous pressure conditions. Furthermore, the Bitzer management controls the frequency of the compressor thrusts, including in the case of loss of power, and minimum on/off times.

And more than this:

22.1.1 Zone A

- *Above the maximum condensation limit (max. c)*

The compressor is stopped immediately.

22.1.2 Zone B

The maximum capacity of the compressor is limited to 75%, and this condition is allowed for a maximum of one minute; if after one minute, the pressure level is not yet within the polygon, the compressor is stopped immediately.

22.1.3 Zone F

NORMAL WORKING

The maximum capacity of the compressor is unlimited (available up to 100%), but this condition is allowed for a maximum of one minute; if after one minute, the pressure level is not yet within the polygon, the compressor is stopped immediately.

START-UP

The compressor is switch-on with the power to 25% for 10s in order then passing to 50% and remains in this state for any thermostatic demand. In this zone the compressor can remain active if after 70s min difference HP-LP is greater then 1 bar and if after 370s the same difference is greater then 3 bars. If one of these conditions doesn't respect the compressor is switched-off then it is turned-on when protection times expired. This last procedure is repeated for 3 attempts. The compressor is stopped if after third attempts it stills into zone F. During the compressor restart the unit status, present in the main mask, will display "RESTART". This type of protection is active when the compressor, in same starting, is not entered in zone C.

22.1.4 Zone C

- *Polygon compressed between 1-2-3-4-5-6 points*

Inside this zone, the compressor's capacity is unlimited and is managed solely according to the requests made.

22.1.5 Zone D

- *Polygon compressed between points 6-7-10-1*

The maximum capacity of the compressor is limited to 75% without any time limit. In this case, the compressor is not compressed.

22.1.6 Zone E

- *Polygon compressed between points 7-8-10-1*

The maximum capacity of the compressor is limited to 50%, and this condition is allowed for a maximum of 10 minutes; if after 10 minutes, the pressure level is not yet within the polygon, the compressor is stopped immediately.

22.1.7 Zone G

- *above max. o*

If the limit is reached when already operational, the compressor is stopped immediately.

On the contrary, only at the start, above this limit, the maximum capacity of the compressor is limited to 50% and this condition is allowed for a maximum of 5 minutes.

If after 5 minutes from the start, the pressure level is still not inside the polygon, the compressor is stopped immediately, otherwise all the above protections are applied.

22.1.8 High delivery temperature alarm

The alarm condition that can be set via relative setpoint and hysteresis, stops the compressor immediately. The default level is 120°C.

22.2 Start up procedure

On start up, the compressor capacity is limited to 25% for 10 seconds. After 10 seconds, the compressor is controlled according to the enveloping of the application limits and depending on the requests made.

22.2.1 Part winding

The part winding start up is handled directly by Macroblocco in line with Bitzer specifications.

22.3 Capacity control

Via the "Compressor Type" parameter, the kind of capacity control can be selected, that is, stepped if "Bitzer Steps" or modulating if set at "Bitzer Stepless".

22.3.1 Step control

By choosing "Bitzer Steps", the compressor capacity varies between 0% (compressor off), 25%, 50%, 75% and 100% (maximum load) depending on the requests made. Under every kind of condition, the maximum capacity is limited according to application enveloping even in the case where 100% is requested.

There is no delay in the stepped control on the capacity change.

22.3.2 Stepless control

By choosing "Bitzer Stepless", the compressor capacity varies between 0% (compressor off), and is modulated from 25% to 100% (full load) depending on the requests made. Under every kind of condition, the maximum capacity is limited according to application enveloping even in the case where 100% is requested.

In all condition the maximum cooling capacity is limited according to the envelop application limits, even in case of cooling demand is requiring 100%.

22.3.3 Economiser and liquid injection

The economiser or liquid injection valve is controlled by the relative setpoints and hysteresis

23. Alarms

Alarms are divided into three categories:

- signal-only alarms (signal on the display, buzzer, alarm relay)
- circuit alarms (deactivate only the corresponding circuit, signal on the display, buzzer, alarm relay)
- serious alarms (deactivate the entire system, signal on the display, buzzer, alarm relay)

23.1 Serious alarms

- "No water flow" alarm
- Serious alarm from digital input
- Phase monitor alarm
- Pump thermal cutout

23.2 Circuit alarms

- High pressure/pressure switch alarm
- Low pressure alarm
- Compressor thermal overload alarm
- Oil differential alarm
- Fan thermal overload alarm
- Unit disconnected from network alarm
- Pressure differential alarm
- Evaporator antifreeze alarm
- High current alarm

23.3 Warning only alarms

- Unit maintenance alarm
- Compressor maintenance alarm
- Clock card faulty or disconnected alarm
- High voltage alarm

23.4 Pressure differential alarm management

Inputs used

- Low pressure transducer
- High pressure transducer

Parameters used

- Enable alarm
- Pressure differential set-point
- Alarm activation delay

Outputs used

- General alarm relays
- All compressor outputs

23.4.1 Description of operation

The alarm is based on the differential between high and low pressure probe readings. If this differential drops below the set differential value, the alarm is signalled and the compressor is powered down, according to the set delay.

23.5 Antifreeze control

Inputs used:

- Water temperature at evaporator outlet
- Water temperature at condenser outlet

Parameters used:

- Enable evaporator outlet probe
- Enable condenser outlet probe
- Antifreeze heater setpoint
- Antifreeze heater differential
- Antifreeze alarm set point
- Antifreeze alarm set point
- Forcing of main pump due to antifreeze alarm

Outputs used :

- Antifreeze heater
- General alarm relays
- All compressor outputs
- Main circulation pump

Description of operation

Every pCO unit is able to manage antifreeze control providing the water temperature probe at evaporator/condenser outlet is connected and enabled according to the type of unit being controlled.

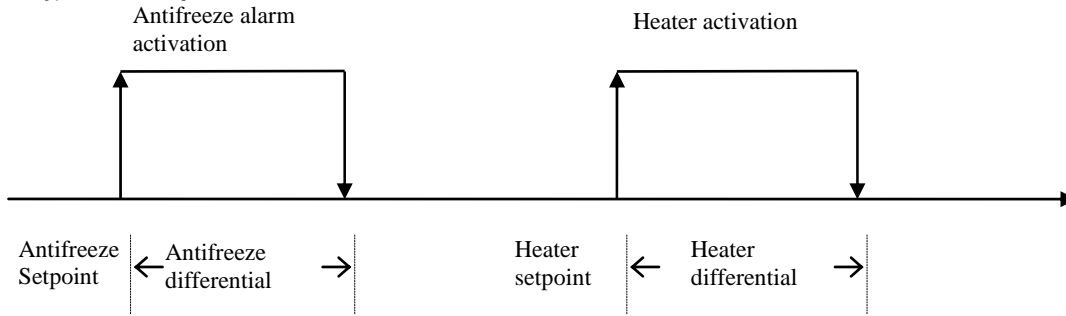

Antifreeze control is always enabled, even if the machine is OFF, both in summer and winter operating modes. For type 5 machines with reversing of the water circuit, the antifreeze control always controls water temperature at evaporator outlet, shifting control to the evaporator or condenser according to the operating mode (summer-winter).

The antifreeze alarm is a circuit alarm, in multi-board systems, and will cause the total shutdown of the unit when all the circuits are in antifreeze mode. A control parameter is provided, which enables you to select whether to keep the main circulation pump ON or OFF in the event of an antifreeze alarm. This will have effect only when all the circuits are in antifreeze status, otherwise the pump will remain on. In units with the freecooling coil, in the event of antifreeze alarms the 4-way valve will be closed.

The heater activation is displayed on unit status of main mask.

23.6 pCO alarms table

Code	Alarm description	OFF Compressors	OFF Fans	OFF Pump	OFF System	Reset	Delay	Signal
011	Serious Alarm	*	*	*	*	Manual		Mst/Slv
012	Phase Monitor Alarm	*	*	*	*	Manual		Mst/Slv
018	Evaporator Pump thermal Cutout	*	*	*	*	Manual		Mst
019	Condenser Pump thermal Cutout	*	*	*	*	Manual		Mst
013	Evaporator Flow-switch	*	*	*	*	Manual	Settable	Mst/Slv
014	Condenser Flow-switch	*	*	*	*	Manual	Settable	Mst/Slv
031	Antifreeze alarm	*	*		*	Manual		Mst/Slv
001	Unit 1 Offline	*	*	*	*	Automatic	50 / 30 s	Slv
002	Unit 2 Offline	*	*	*	*	Automatic	50 / 30 s	Mst
003	Unit 3 Offline	*	*	*	*	Automatic	50 / 30 s	Mst
004	Unit 4 Offline	*	*	*	*	Automatic	50 / 30 s	Mst
020	Compressor Thermal cutout	*				Manual		Mst/Slv
015	Oil Differential Pressure Switch	*	*			Manual	Settable	Mst/Slv
032	Low Pressure Differential	*				Manual	Settable	Mst/Slv
017	Low Pressure 2 Pressure-switch	*	*			Manual	Settable	Mst/Slv
016	High Pressure Pressure-switch	*				Manual		Mst/Slv
034	Low Transducer Pressure	*	*			Manual		Mst/Slv
033	High Transducer Pressure	*				Manual		Mst/Slv
021	Fan 1 Thermal cutout		*			Manual		Mst/Slv
022	Fan 2 Thermal cutout		*			Manual		Mst/Slv
035	High outlet temperature	*				Manual		Mst/Slv
036	High Voltage					Manual		Mst/Slv
037	High Current	*				Manual		Mst/Slv
051	Evap. Pump Maintenance					Manual		Mst
052	Cond. Pump Maintenance					Manual		Mst
053	Compressor Maintenance					Manual		Mst/Slv
060	B1 Probe Failed	*	*	*	*	Automatic	10 s	Mst
061	B2 Probe Failed	*	*	*	*	Automatic	10 s	Mst/Slv
062	B3 Probe Failed					Automatic	10 s	Mst/Slv
063	B4 Probe Failed					Automatic	10 s	Mst/Slv
064	B5 Probe Failed					Automatic	10 s	Mst/Slv
065	B6 Probe Failed					Automatic	10 s	Mst/Slv
066	B7 Probe Failed					Automatic	10 s	Mst/Slv
067	B8 Probe Failed					Automatic	10 s	Mst/Slv
041	32KB Clock Card Failed					Manual		Mst/Slv
090	Operation limit exceed	*	*	*		Manual		Mst/Slv
091	Gas not managed					Automatic		Mst/Slv

23.7 Driver card alarms

Code	Alarm description	OFF Compressors	OFF Fans	OFF Pump	OFF System	Reset	Delay	Signal
101	Probe driver 1 fault							
102	Diver 1 EEPROM error	*				Manual		Mst/Siv
103	Diver 1 stepped motor error	*				Manual		Mst/Siv
104	Diver 1 battery error	*				Manual		Mst/Siv
105	High pressure on driver 1					Manual		Mst/Siv
106	Low pressure on driver 1					Manual		Mst/Siv
107	Low super-heat driver 1	*				Manual		Mst/Siv
108	Valve not shut while driver 1 being disabled	*				Manual		Mst/Siv
109	High super-heat driver 1					Manual		Mst/Siv
114	Standby due to EEPROM /battery recharge / or open valve error, driver 1	*				Manual		Mst/Siv
115	LAN disconnected, driver 1	*				Manual		Mst/Siv
116	Setup incomplete					Manual		Mst/Siv
201	Probe driver 1 fault	*				Manual		Mst/Siv
202	Diver 2 motor EEPROM error	*				Manual		Mst/Siv
203	Diver 2 stepped motor error	*				Manual		Mst/Siv
204	Diver 2 battery error	*				Manual		Mst/Siv
205	High pressure on driver 2					Manual		Mst/Siv
206	Low pressure on driver 2					Manual		Mst/Siv
207	Low super-heat driver 2	*				Manual		Mst/Siv
208	Valve not shut while driver 2 being disabled	*				Manual		Mst/Siv
209	Driver 2 high intake temperature					Manual		Mst/Siv
214	Standby due to EEPROM /battery recharge / or open valve error, driver 2	*				Manual		Mst/Siv
215	LAN disconnected, driver 2	*				Manual		Mst/Siv
216	Setup incomplete					Manual		Mst/Siv

24. Alarm log

The alarm log can store the standard chiller's operating state when alarms are generated or at particular times. Each record represents an event that can be displayed from the list of all the events available in the memory. The log is used to resolve problems and faults as it represents a "snapshot" of the installation at the moment the alarm was activated, and may suggest the possible causes and solutions to the faults. There are two kinds of log in the program, the STANDARD log and ADVANCED log.

24.1 Standard log

The pCO* boards' considerable buffer space means events can be saved in the STANDARD log, which is always available on the various boards. If there is no clock card (optional extra on pCO1, built-in feature on pCO2 and pCO3), the STANDARD log just gives the alarm code. The maximum number of events that can be logged is 100. Once the hundredth alarm is reached, i.e. the last available slot in the memory is taken, the oldest alarm (00) is erased as it is overwritten with the next alarm, and so on for subsequent events. Logged events cannot be deleted by the user unless installing factory settings. The STANDARD log screen can be called up by pressing the MAINTENANCE key, and looks like this:

```

+-----+
| Alarms history  A2 |
|AL000 00:00 00/00/00|
|TIn 000.0 TOut 000.0|
|HP 000.0 LP 000.0 |
+-----+

```

For each alarm, the following data are stored relating to the standard chiller at the time of the alarm:

- alarm code
- Time;
- Date;
- chronological number of the event (0...99)

The chronological event number indicates the "seniority" of the event with respect to the 100 available storage slots. The alarm with number 00 is the first to occur after the STANDARD logs are enabled, and hence the oldest.

If you move the cursor onto the chronological number, you can run through the alarm log, from 0 to 99, using the arrow keys.

For instance, if you are on position 00, pressing the down arrow will not take you anywhere.

If 15 alarms have been logged, for instance, and you are on position 014, pressing the up arrow will not take you anywhere.

24.2 Advanced log

Events are logged on the 1MB or 2MB memory expansion module, which is a permanent appendix to the board. Advantages and features are listed below:

- Event-based log: a typical event-based log is the alarm log. When an alarm occurs, the alarm generated is stored along with significant data (temperatures, pressures, setpoints etc.).
- Time-based log: a typical event[sic! probably time]-based log is the temperatures/pressure log. Temperature and pressure values are stored at regular intervals.
- Log log: this is the log of the last alarms/temperatures/pressures stored before a serious alarm. Unlike data stored in the event- and time-based logs, these data are not overwritten when the memory is full.
- You have the option of choosing the values to be saved at any time as well as the method used to save them. Using the "WinLOAD" utility program, you can define the values to be saved and the method used to save them with the aid of a practical Wizard. WinLOAD does not need application software files as it can procure all the information required directly from the pCO* board's resident application software.
- 1MB of dedicated FLASH memory. With this system, data are saved to the 1MB FLASH memory included in the memory expansion module (code PCO200MEM0 for pCO2). By way of example, 1MB of memory can hold 5,000 alarm events with 5 values for each alarm, and 6 months of recording 2 values - for instance, temperature and pressure - saved every 5 minutes.
- Option of defining up to 7 different log configurations. Usually, each controller will have one alarm log and one log for control values (temperature/humidity/pressure) configured, in addition to a number of "log logs".
- Stored data can be consulted either via the (separate or built-in) LCD terminal or via a connected PC.
- "Black box" operating mode. The memory expansion module containing the logs can be removed from the controlled unit's pCO² and inserted in another pCO², via which the stored data can be consulted. The host pCO² does not need to contain the same software as the original.
- Stored data reliability. Data are saved to a FLASH memory that does not need batteries, which are liable to run down. If previously stored data are not compatible with new software following an upgrade, all data are erased (you are prompted to confirm first).

24.3 List of alarm log codes

AL:001	Unit No. 1 Offline
AL:002	Unit No. 2 Offline
AL:003	Unit No.3 Offline
AL:004	Unit no. 4 Offline
AL:011	Serious alarm from digital input
AL:012	Phase monitor alarm
AL:013	Evaporator flow-switch alarm
AL:014	Condenser flow-switch alarm
AL:015	Oil level alarm
AL:016	High pressure alarm (pressure switch)
AL:017	Low pressure alarm (pressure switch)
AL:018	Evaporator Pump thermal Cutout

AL:019	Condenser Pump thermal cutout
AL:020	Compressor thermal cutout
AL:021	Condenser 1 Thermal cutout
AL:022	Condenser 2 Thermal cutout
AL:031	Antifreeze alarm
AL:032	Low pressure differential alarm
AL:033	High pressure alarm (transducer)
AL:034	Low pressure alarm (transducer)
AL:035	High delivery temperature alarm
AL:036	High voltage alarm
AL:037	High current alarm
AL:041	Alarm: clock card failed or disconnected
AL:051	Evaporator pump maintenance
AL:052	Condenser pump maintenance
AL:053	Compressor Maintenance
AL:060	Probe B1 failed or not connected
AL:061	Probe B2 failed or not connected
AL:062	Probe B3 failed or not connected
AL:063	Probe B4 failed or not connected
AL:064	Probe B5 failed or not connected
AL:065	Probe B6 failed or not connected
AL:066	Probe B7 failed or not connected
AL:067	Probe B8 failed or not connected
AL:090	Compressor out-with operating limits
AL:101	Driver 1 probe fault
AL:102	Diver 1 EEPROM error
AL:103	Diver 1 stepped motor error
AL:104	Alarm: driver 1 battery
AL:105	High pressure (MOP) driver 1
AL:106	Low pressure (LOP) driver 1
AL:107	Low super-heat alarm, driver 1
AL:108	Valve not shut while driver 1 being disabled
AL:109	High super-heat alarm, driver 1
AL:114	Standby due to EEPROM /battery recharge / or open valve error, driver 1
AL:115	LAN disconnected, driver 1
AL:116	Incomplete setup procedure on driver 1
AL:201	Driver 2 probe fault
AL:202	Diver 2 EEPROM error
AL:203	Diver 2 stepped motor error
AL:204	Alarm: driver 2 battery
AL:205	High pressure (MOP) driver 2
AL:206	Low pressure (LOP) driver 2
AL:207	Low super-heat alarm, driver 2
AL:208	Valve not shut while driver 2 being disabled
AL:209	High super-heat alarm, driver 2
AL:214	Standby due to EEPROM /battery recharge / or open valve error, driver 2
AL:215	LAN disconnected, driver 2
AL:216	Incomplete setup procedure on driver 2

25. Supervisor

The unit can be interfaced to a local or remote supervision/remote-assistance system. Between the pCO* card accessories, an optional card is planned for serial communication via RS485 interface, supplied separately from the pCO* card (for installation instructions for the serial communication optional cards, see installation manual of pCO* card).

The software can handle the following supervision protocols:

- CAREL
- Modbus
- LonWorks (via special optional card)
- Trend (via special optional card)
- Bacnet (via external gateway or PCO-WEB)

If the serial communication values (serial address and communication speed) are correctly set, the parameters transmitted by the unit will be as shown on the following table. By setting the serial identification number to 0, the communication towards the supervision system is disabled.

Follow the list of variables managed by the supervisor.

25.1.1.1 Key

A Analogue variable

D Digital variable

I Integer variable

IN Input variable

OUT Output variable

IN/OUT Input/output variable

pCO ← Supervisor

pCO → Supervisor

pCO ↔ Supervisor

Type	Direction	Address	Description
A	OUT	1	Analogue input 1 value
A	OUT	2	Analogue input 2 value
A	OUT	3	Analogue input 3 value
A	OUT	4	Analogue input 4 value
A	OUT	5	Analogue input 5 value
A	OUT	6	Analogue input 6 value
A	OUT	7	Analogue input 7 value
A	OUT	8	Analogue input 8 value
A	OUT	9	Analogue output 1 value
A	OUT	10	Analogue output 2 value
A	IN/OUT	11	Summer temperature set-point
A	IN/OUT	12	Winter temperature set-point
A	IN/OUT	13	Condensation set-point
A	IN/OUT	14	Temperature control band
A	IN/OUT	15	Double cooling temperature set point
A	IN/OUT	16	Double heating temperature set point
A	OUT	127	Software version
I	OUT	1	Unit status
I	OUT	2	pLAN address of unit
I	OUT	3	Type of fan management
I	OUT	4	Unit configuration type
I	OUT	5	Number of compressors
I	OUT	6	Number of fans
I	OUT	7	Kind of compressor
I	OUT	50	Minimum compressor on time / Time to reach minimum capacity
I	OUT	51	Minimum compressor off time
I	OUT	52	Time between starts of different compressors / Time to reach maximum capacity
I	OUT	53	Time between thrusts of same compressor
I	OUT	80	Bitzer working point
I	OUT	119	pCO type
I	OUT	120	pCO size
I	OUT	121	Bios release
I	OUT	122	Bios data
I	OUT	123	Boot release
I	OUT	124	Boot data
I	OUT	125	Software date- day
I	OUT	126	Software date- month
I	OUT	127	Software date- year
D	OUT	1	Unit status (On/Off)
D	OUT	2	Digital output 1 value
D	OUT	3	Digital output 2 value
D	OUT	4	Digital output 3 value
D	OUT	5	Digital output 4 value
D	OUT	6	Digital output 5 value
D	OUT	7	Digital output 6 value
D	OUT	8	Digital output 7 value
D	OUT	9	Digital output 8 value
D	OUT	10	Digital output 9 value
D	OUT	11	Digital output 10 value
D	OUT	12	Digital output 11 value
D	OUT	13	Digital output 12 value
D	OUT	14	Digital output 13 value
D	OUT	15	Enable evaporator flow-switch alarm
D	OUT	16	Enable probe 1
D	OUT	17	Enable probe 2
D	OUT	18	Enable probe 3
D	OUT	19	Enable probe 4
D	OUT	20	Enable probe 5
D	OUT	21	Enable probe 6
D	OUT	22	Enable probe 7
D	OUT	23	Enable probe 8
D	OUT	24	ON/OFF by supervisor
D	OUT	25	Enable starting restrictions
D	OUT	26	Type of compressor capacity control

Type	Direction	Address	Description
D	OUT	27	Summer/Winter selection from digital input
D	OUT	28	Heat pump enabled
D	OUT	29	Summer/Winter operation
D	OUT	30	Selection of condensation with inverter
D	IN/OUT	31	Select cooling / heating
D	IN/OUT	32	Reset alarms
D	OUT	45	General alarm
D	OUT	46	Antifreeze alarm
D	OUT	47	Compressor thermal overload alarm
D	OUT	48	Evaporator flow-switch alarm
D	OUT	49	Condenser flow-switch alarm
D	OUT	50	High pressure alarm from pressure switch
D	OUT	51	Oil level alarm
D	OUT	52	Low pressure alarm from pressure switch
D	OUT	53	High pressure alarm from transducer
D	OUT	54	Serious alarm from digital input
D	OUT	55	Fan 1 thermal cutout alarm
D	OUT	56	Fan 2 thermal cutout alarm
D	OUT	57	Evaporator pump thermal cutout alarm
D	OUT	58	Card 1 offline alarm
D	OUT	59	Slave 1 Offline alarm
D	OUT	60	Slave 2 Offline alarm
D	OUT	61	Slave 3 Offline alarm
D	OUT	62	Alarm: Probe 1 failed or not connected
D	OUT	63	Alarm: Probe 2 failed or not connected
D	OUT	64	Alarm: Probe 3 failed or not connected
D	OUT	65	Alarm: Probe 4 failed or not connected
D	OUT	66	Alarm: Probe 5 failed or not connected
D	OUT	67	Alarm: Probe 6 failed or not connected
D	OUT	68	Alarm: Probe 7 failed or not connected
D	OUT	69	Alarm: Probe 8 failed or not connected
D	OUT	70	Condenser pump duty hours alarm
D	OUT	71	Compressor duty hours alarm
D	OUT	72	Condenser pump thermal cutout alarm
D	OUT	73	Clock alarm
D	OUT	74	Phase monitor alarm
D	OUT	75	Low pressure alarm from transducer
D	OUT	76	High voltage alarm
D	OUT	77	High current alarm
D	OUT	78	Evaporator pump duty hours alarm
D	OUT	79	Operation limit exceedi alarm
D	OUT	80	High delivery temperature alarm
D	OUT	81	Pressure differential alarm
D	OUT	82	Driver 1 probe alarm
D	OUT	83	Alarm: driver 1 EEPROM error
D	OUT	84	Alarm: driver 1 stepped motor valve error
D	OUT	86	Driver 1 high pressure alarm (MOP)
D	OUT	87	Driver 1 low pressure alarm (LOP)
D	OUT	88	Driver 1 low superheat alarm
D	OUT	89	Alarm - valve not shut after driver 1 black-out
D	OUT	90	Driver 1 high intake temperature alarm
D	OUT	92	Alarm: driver 2 EEPROM error
D	OUT	93	Alarm: driver 2 stepped motor valve error
D	OUT	94	Driver 2 probe alarm
D	OUT	95	Driver 2 high pressure alarm (MOP)
D	OUT	96	Driver 2 low pressure alarm (LOP)
D	OUT	97	Driver 2 low superheat alarm
D	OUT	98	Alarm - valve not shut after driver 2 black-out
D	OUT	99	Driver 2 high intake temperature alarm
D	OUT	100	Standby due to eeprom or open valve error, driver 1
D	OUT	101	Standby due to eeprom or open valve error, driver 2
D	OUT	102	Probe alarm on diver 1
D	OUT	103	Probe alarm on diver 2

CAREL

CAREL S.p.A.
Via dell'Industria, 11 - 35020 Brugine - Padova (Italy)
Tel. (+39) 049.9716611 Fax (+39) 049.9716600
<http://www.carel.com> - e-mail: carel@carel.com

Agency

Cod. CAREL +030221296 - rel. 1.4 - 11/09/08