

Non-penetrative supports for pipework, duct and cable ladder/tray

The H Frame Set is a quick, versatile and economical solution for supporting pipework, duct, cable ladders/trays or any combination of these. You provide your own strut, keeping the duct and pipe installations low-cost and totally flexible by fabricating the frameworks on-site.

The majority of installations require 305mm H Frames but where a greater load distribution is required 450mm and 600mm H Frames are also available.

H Frame Set 305mm

- Versatile application
- Quick & easy installation
- Excellent load distribution
- Compatible with industry standard componentry
- Interchangeable with 3 strut sizes – one foot fits all
- Supplied with adhered rubber mats for optimum roof protection
- Boxed for convenience



KIT INCLUDES

| | |
|-----------------------|-----|
| Feet with adhered mat | x 2 |
| Brackets and fixings | x 4 |
| Assembly instructions | x 1 |

FOOT FLEECES

Recommended for use on PVC membrane roof surfaces to prevent polymer migration

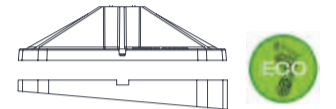

305 ANGLED MATS

2.5° and 5° rubber mats are also available for sloped roof applications



PLEASE NOTE: Strut NOT included

PRODUCT INFORMATION

| Model | 305mm | 305mm 5 Pack |
|----------------------|---|---|
| Part no. | B6088  | B9645  |
| Foot Size (mm) | 305 | 305 |
| Rec. frame load (kg) | 300 | 300 |
| Packaged weight (kg) | 6.75 | 34 |

INTERCHANGEABLE STRUT

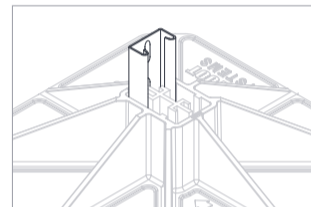

21 x 41 x 1.5mm Strut

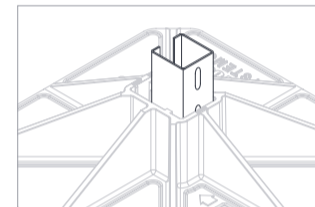

40 x 38 x 1.9mm Euro Strut

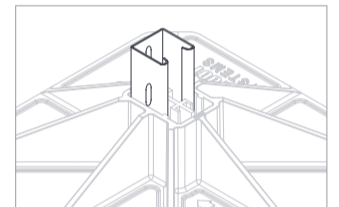

41 x 41 x 1.5mm Strut

H Frame Set 450mm & 600mm

- Versatile application
- Quick & easy installation
- Excellent load distribution
- Compatible with industry standard componentry
- Supplied with removable rubber mats for optimum roof protection
- Boxed for convenience

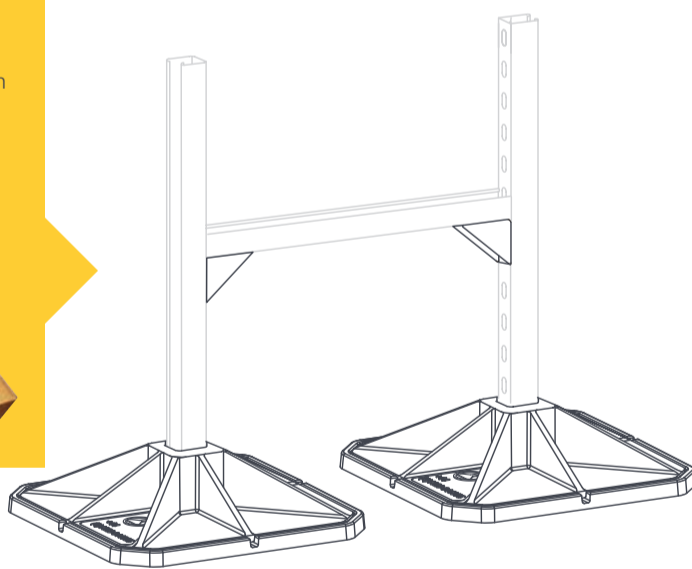

KIT INCLUDES

| | |
|-----------------------|-----|
| Plastic feet | x 2 |
| Rubber mats | x 2 |
| Insert | x 2 |
| Brackets and fixings | x 2 |
| Assembly instructions | x 1 |

FOOT FLEECES

Recommended for use on PVC membrane roof surfaces to prevent polymer migration

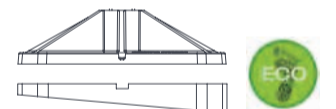

450 ANGLED MATS

2.5° and 5° rubber mats are also available for sloped roof applications



PLEASE NOTE: Strut NOT included

PRODUCT INFORMATION

| Model | 450mm | 600mm |
|----------------------|---|---|
| Part no. | B6089  | B9222  |
| Foot Size (mm) | 450 | 600 |
| Rec. frame load (kg) | 500 | 500 |
| Packaged weight (kg) | 13.35 | 23.10 |

STRUT INSERT

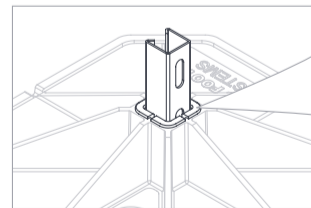

41 x 41 x 1.5mm Strut

For ease of specification these products are detailed on the following building product libraries:

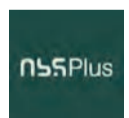

listed in **LUCKINSLIVE**

