

## VMF system

PANNELLO COMANDI ELETTRONICO PER VENTILCONVETTORI

ELECTRONIC CONTROL PANEL FOR FAN COILS

PANNEAU DE COMMANDE ELECTRONIQUE POUR VENTILO-  
CONVECTEURS

ELEKTRONISCHE BEDIENTAFEL FÜR GEBLÄSEKONVEKTOREN

TABLERO DE MANDOS ELECTRÓNICO PARA FAN COILS

# VMF-E2

---



---

## INDICE GENERALE

---

<b>Italiano</b>	3
<b>English</b>	8
<b>Français</b>	13
<b>Deutsche</b>	18
<b>Español</b>	23

---

## CONTENTS

Important information	8
Control panel functions	9
Use	10
Visualisations for the user	11
Installation information	12

## IMPORTANT INFORMATION

**⚠ WARNING:** VMF-E2 are designed for indoor use.

**⚠ WARNING:** the fan coil is connected to power supply and water circuit. Operations performed by persons without the required technical skills can lead to personal injury to the operator or damage to the unit and surrounding objects.

**⚠ WARNING:** components sensitive to static electricity may be destroyed by discharge notably lower than those at the human perception threshold. These discharges form when you touch a component or electric contact of a unit, without first discharging accumulated static electricity from your body. The damage caused to the unit by an overvoltage is not immediately evident - it only appears after a certain period of operation.

### STATIC ELECTRICITY ACCUMULATION

Any person not connected in a conductive manner with the electronic potential of his surrounding environment can accumulate electrostatic charges.

### STANDARD PROTECTION AGAINST ELECTROSTATIC CHARGES

#### Earthing quality

**⚠** When working with units sensitive to electrostatic electricity, ensure that people, workplaces and unit casings are correctly earthed. This will prevent the formation of electrostatic charges.

#### Avoid direct contact

**⚠** Only touch the element exposed to electrostatic risk when absolutely essential (e.g. for maintenance).

**⚠** Touch the element without coming into contact with either the contact pins or the wire guides. If you follow this rule, the energy of the electrostatic charges cannot reach or damage the sensitive parts. Before taking measurements on the unit, it is necessary to discharge all electrostatic charges from your body: to do this, just touch an earthed metal object. Only use earthed measuring instruments.

### POWER THE FAN COIL ONLY WITH 230V, SINGLE-PHASE VOLTAGE

Any other type of power supply could

permanently damage the fan coil.

### ADJUST TEMPERATURE ADEQUATELY

The room temperature should be adjusted in order to provide maximum comfort to the people in the room, especially if they are elderly, children or sick people; avoid differences over 7°C between the outdoor temperature and the temperature inside the room in summer.

In summer, a temperature that is too low causes higher electrical consumption.

### ⚠ MALFUNCTIONING

**In the event of a malfunction, cut off power supply to the unit, then restore the power and start the unit again. If the problem occurs again, call the local After-Sales Service immediately.**

### DO NOT TUG THE ELECTRIC CABLE

**⚠** It is very dangerous to pull, tread on or crush the electric power cable, or fix it with nails or drawing pins.

**⚠** A damaged power cable can cause short circuits and injure people.

# CONTROL PANEL FUNCTIONS

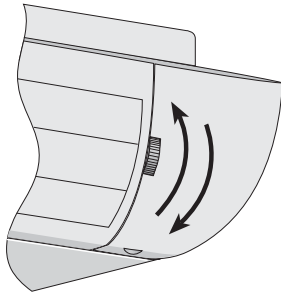

Ventilation is only allowed with the fin open; it must be manually opened. The closure of the fin causes ventilation to switch off. To access the control panel, lift the protection flap. Closing the master fan coil fin, the electronic thermostat card and the other fan coils in the network will carry on working.

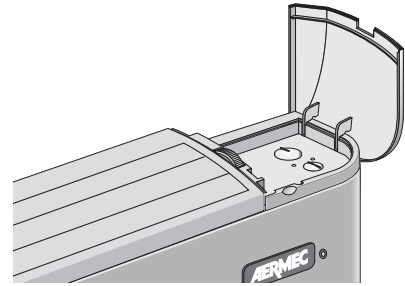

– (B) Temperature selector

– (C) Operation mode indicator light  
RED - BLUE - FUCHSIA

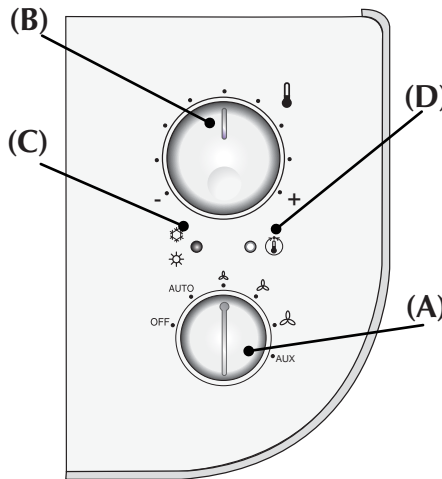

– (D) Ventilation request indicator light  
YELLOW

– (A) Ventilation speed selector:

- OFF The anti-freeze function is active
- AUTO Automatic ventilation mode
- Manual ventilation speed selection

- V1 = Minimum speed
- V2 = Average speed
- V3 = Maximum speed
- AUX Minimum speed  
Special accessories enabling, consult the relative manuals.

Temperature  
standard  
configuration  
(dead band 5°C)

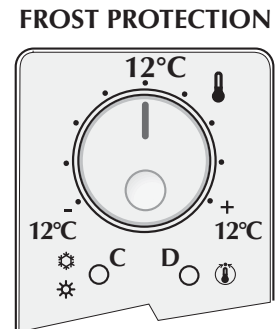
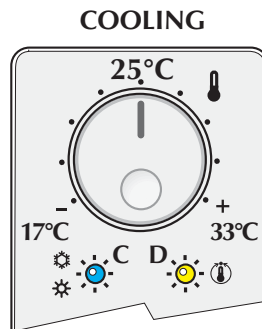
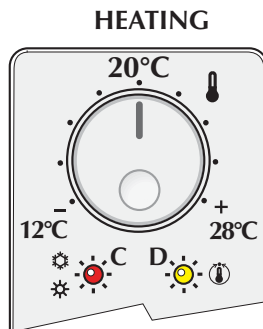

Temperature  
optional  
configuration  
(dead band 2°C)

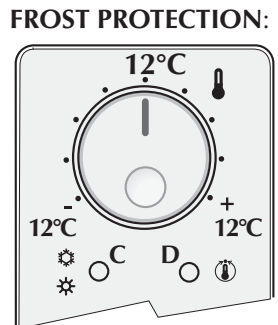
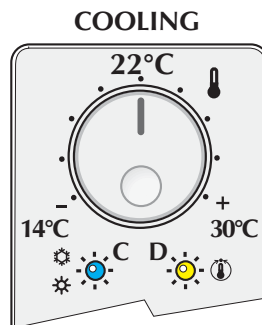
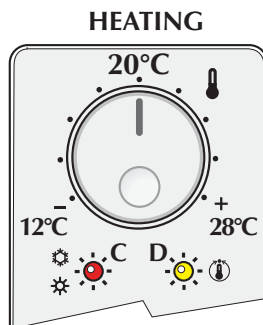



## USE

### Starting

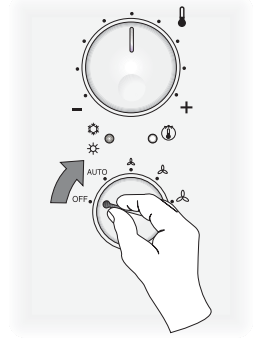
- To start up the fan coil, turn the knob and choose a ventilation speed.
- To switch off the fan coil, turn the knob to the **OFF** position.
- **OFF** The fan coil is switched off.  
In the OFF condition, the thermostat carries on working.  
If the room temperature falls below 7°C, and the system conditions allow it, the thermostat will activate ventilation (anti-freeze function).



### Selecting the ventilation speed

- **AUTO** The thermostat maintains the set temperature by automatically changing the ventilation speed on the basis of the room temperature and the set temperature.
-  The thermostat maintains the set temperature by means of ON-OFF cycles, using the **minimum fan speed**.
-  The thermostat maintains the set temperature by means of ON-OFF cycles, using the **average fan speed**.
-  The thermostat maintains the set temperature by means of ON-OFF cycles, using the **maximum fan speed**.

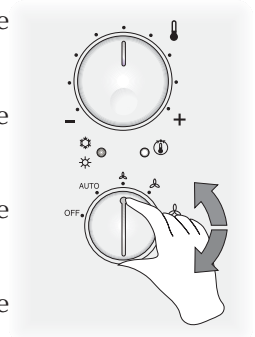

### Selecting the temperature

- To increase the room temperature, turn the knob to the right (+).
- To reduce the room temperature, turn the knob to the left (-).

The temperatures are not indicated on the panel because, on one single knob position, the value changes in line with the operating mode (Heating, Cooling or Anti-freeze).

The maximum and minimum temperature differences compared with the central position are +8°C and -8°C; only with the anti-freeze function is the set temperature fixed throughout the field.

The temperature with the selector set in the central position is:

- Heating 20°C
- Cooling 25°C (standard configuration with dead band 5°C)
- Anti-freeze: the minimum room temperature is 7°C in all selector positions (the 12°C set activates automatically)

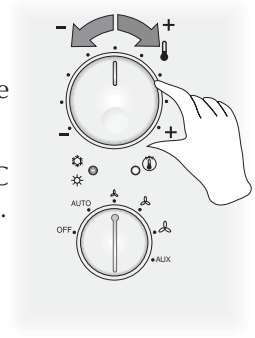

### Season changeover

Water side changeover: the thermostat automatically sets Heating or Cooling operation according to the temperature of the water in the system.

Air side changeover: for special settings, the season change function can be set by operating the temperature selector.

## INDICATOR LIGHTS FOR THE USER (STANDARD CONFIGURATION)

LED **D** indicates a ventilation request:

### YELLOW

- (ON) The ambient conditions require the use of the fan (when the speed selector is on AUTO, V1, V2, V3)
- (OFF) The ambient conditions do not require the use of the fan, or the selector is in the OFF (standby) position, or the fin is closed
- (slow flashing) Operation mode managed by the centralised system. The fan selector on the panel is automatically blocked.
- (quick flashing) Indicates an ambient probe fault (contact the After Sales Service)

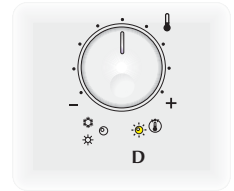

LED **C** indicates the active operating mode:

### RED

- Heating
- Quick flashing indicates that the Anti-freeze (Frost Protection) function is active

### RED + FUCHSIA

- Heating. The alternate flashing colours indicate the absence of suitable conditions for enabling ventilation (unsuitable water temperature, or closed fin on versions with motorised fin).

### BLUE

- Cooling

### BLUE + FUCHSIA

- Cooling. The alternate flashing colours indicate the absence of suitable conditions for enabling ventilation (unsuitable water temperature, or closed fin on versions with motorised fin).

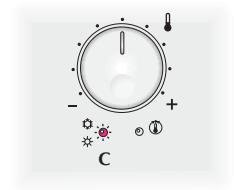

Special visualisations following particular operating conditions:

(these visualisations can be interpreted by the After Sales Service)

### BLUE + YELLOW

- Slow flashing of the BLUE LED (C) and the YELLOW LED (D). Addressing procedure in progress. Turn the ventilation speed selector knob to activate the automatic procedure to assign the address to the unit. The thermostat functions are temporarily disabled.

### FUCHSIA + BLUE + RED

- Visualisation of the unit's serial address
  - The number of flashes of the FUCHSIA LED indicates the units.
  - The number of flashes of the BLUE LED indicates the tens.
  - The number of flashes of the RED LED indicates the hundreds.

### FUCHSIA + YELLOW

- Slow contemporary flashing of the YELLOW LED and the FUCHSIA LED indicates the absence of communication between the control panel and the thermostat.

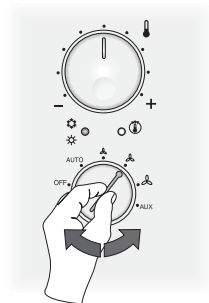

## SET POINT - AN EXAMPLE OF A SETTING

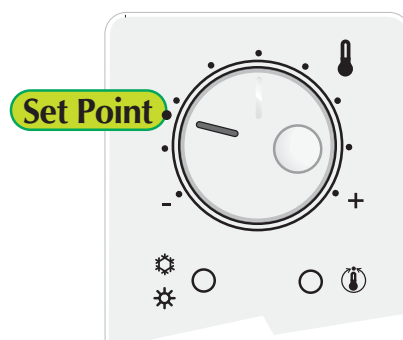

## INSTALLATION

**⚠ WARNING:** VMF-E2 is designed for indoor use.

**⚠ WARNING:** check that the power supply is disconnected before carrying out any procedures on the unit.

**⚠ WARNING:** before carrying out any work, put the proper individual protection equipment on.

**⚠ WARNING:** the device must be installed in compliance with national plant engineering rules.

**⚠ WARNING:** the electrical connections, plus the installation of

fan coils and relevant accessories, should only be performed by a technician with the necessary technical and professional expertise to install, modify, extend and maintain systems, and who is able to check the systems for purposes of safety and correct operation (in this manual such technicians will be indicated with the general term "personnel with specific technical skills").

In the specific case of electrical wirings, the following must be checked:

- measurement of the electrical system insulation strength.
- continuity of the protection wires

**⚠ WARNING:** Install a device, main switch, or electric plug so you can fully disconnect the device from the power supply.

The essential indications to install the device correctly are given here.

The installer's experience will be necessary however, to perfect all the operations in accordance with the specific requirements.

The assembly site must be chosen in such a way that the maximum and minimum ambient temperature limits are respected 0-45°C (<85% R.H.).

- Loosen the screws to remove the housing.
- Fit the panel (see figure).

- Make all the connections.
- Reassemble the casing.

- Make sure the fan coil is working properly.

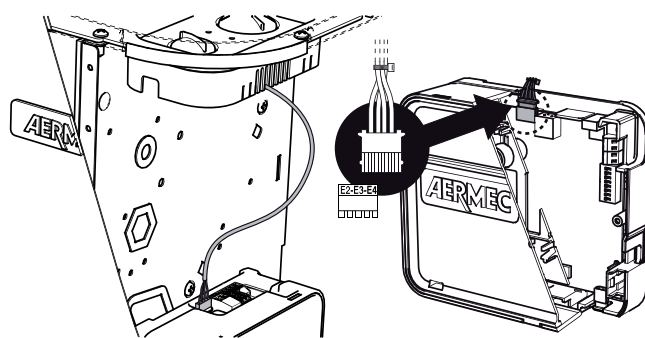
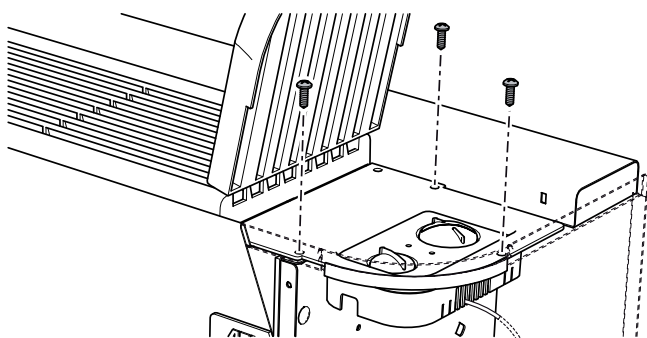
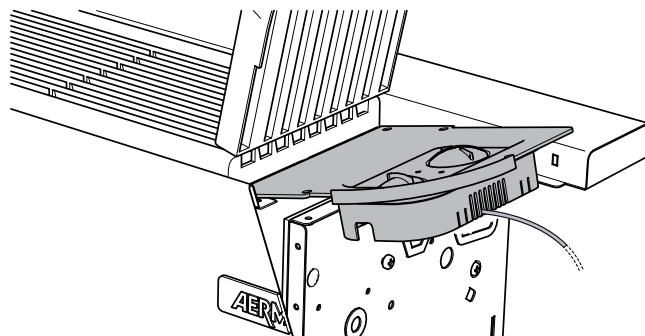
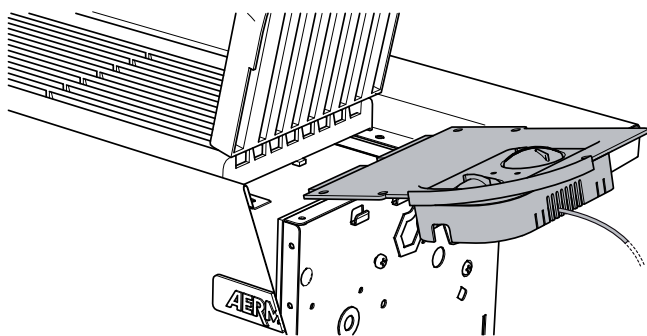

## ELECTRICAL WIRINGS

For all the connections, follow the wiring diagrams.

The connections must be made with the connectors on the electronic card on the side of the fan coil (protected by a plastic box).

**⚠ WARNING:** the diagram showing the connections of the electronic card to the control board is printed inside its box cover.

---

I dati tecnici riportati nella presente documentazione non sono impegnativi.

AERMEC S.p.A. si riserva la facoltà di apportare in qualsiasi momento tutte le modifiche ritenute necessarie per il miglioramento del prodotto.

Les données mentionnées dans ce manuel ne constituent aucun engagement de notre part. Aermec S.p.A. se réserve le droit de modifier à tous moments les données considérées nécessaires à l'amélioration du produit.

Technical data shown in this booklet are not binding.

Aermec S.p.A. shall have the right to introduce at any time whatever modifications deemed necessary to the improvement of the product.

Im Sinne des technischen Fortschrittes behält sich Aermec S.p.A. vor, in der Produktion Änderungen und Verbesserungen ohne Ankündigung durchzuführen.

Los datos técnicos indicados en la presente documentación no son vinculantes.

Aermec S.p.A. se reserva el derecho de realizar en cualquier momento las modificaciones que estime necesarias para mejorar el producto.

---

**AERMEC S.p.A.**

I-37040 Bevilacqua (VR) - Italia

Via Roma, 996 - Tel. (+39) 0442 633111

Telefax (+39) 0442 93730 - (+39) 0442 93566

www.aermec.com

---