

**Revision A:**

• MUZ-FH50VEHZ- **E1** has been added.

Please void OBH625.

# OUTDOOR UNIT SERVICE MANUAL



**No. OBH625  
REVISED EDITION-A**

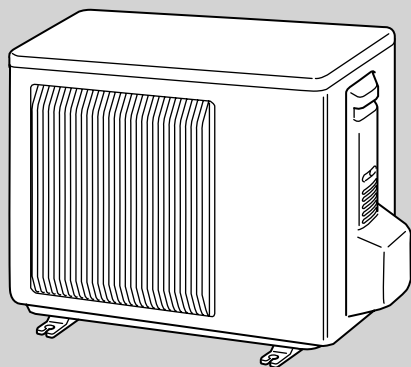
## Models

**MUZ-FH25VEHZ** - **E1**

**MUZ-FH35VEHZ** - **E1**

**MUZ-FH50VEHZ** - **E1**

Indoor unit service manual  
MSZ-FH•VE Series (OBH623)



**MUZ-FH25VEHZ  
MUZ-FH35VEHZ**

## CONTENTS

1. TECHNICAL CHANGES .....	3
2. PART NAMES AND FUNCTIONS .....	3
3. SPECIFICATION .....	4
4. NOISE CRITERIA CURVES .....	7
5. OUTLINES AND DIMENSIONS .....	8
6. WIRING DIAGRAM .....	9
7. REFRIGERANT SYSTEM DIAGRAM .....	11
8. PERFORMANCE CURVES .....	13
9. ACTUATOR CONTROL .....	24
10. SERVICE FUNCTIONS .....	25
11. TROUBLESHOOTING .....	26
12. DISASSEMBLY INSTRUCTIONS .....	48

**PARTS CATALOG (OBB625)**

**NOTE:**

RoHS compliant products have <G> mark on the spec name plate.



## Use the specified refrigerant only

### **Never use any refrigerant other than that specified.**

Doing so may cause a burst, an explosion, or fire when the unit is being used, serviced, or disposed of.

Correct refrigerant is specified in the manuals and on the spec labels provided with our products.

We will not be held responsible for mechanical failure, system malfunction, unit breakdown or accidents caused by failure to follow the instructions.

### **<Preparation before the repair service>**

- Prepare the proper tools.
- Prepare the proper protectors.
- Provide adequate ventilation.
- After stopping the operation of the air conditioner, turn off the power-supply breaker and remove the power plug.
- Discharge the capacitor before the work involving the electric parts.

### **<Precautions during the repair service>**

- Do not perform the work involving the electric parts with wet hands.
- Do not pour water into the electric parts.
- Do not touch the refrigerant.
- Do not touch the hot or cold areas in the refrigeration cycle.
- When the repair or the inspection of the circuit needs to be done without turning off the power, exercise great caution not to touch the live parts.

### **Revision A:**

- MUZ-FH50VEHZ- [E1] has been added.

# 1

## TECHNICAL CHANGES

MUZ-FH25VEHZ -E1

MUZ-FH35VEHZ -E1

MUZ-FH50VEHZ -E1

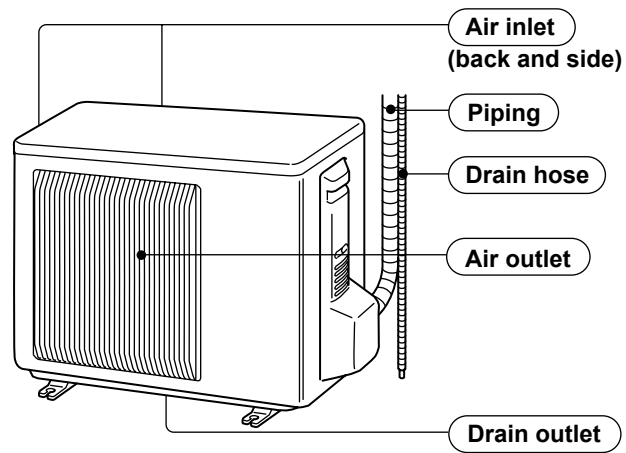
1. New model

# 2

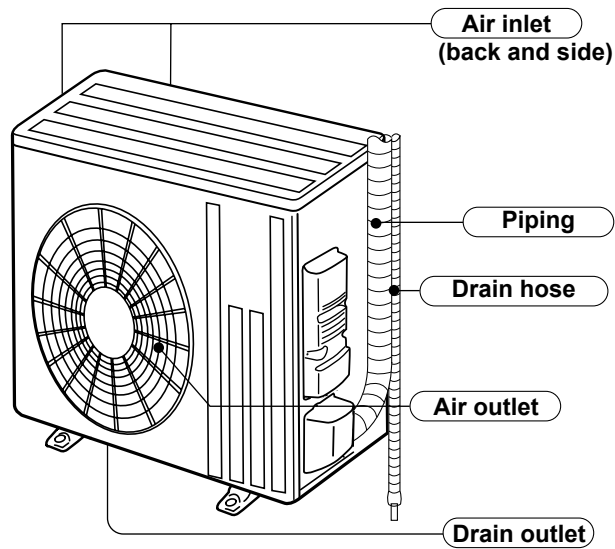
## PART NAMES AND FUNCTIONS

MUZ-FH25VEHZ

MUZ-FH35VEHZ



MUZ-FH50VEHZ



# 3

# SPECIFICATION

Outdoor model				MUZ-FH25VEHZ	MUZ-FH35VEHZ	
Power supply				Single phase, 230 V, 50 Hz		
Capacity		Cooling	kW	2.5 (0.8 - 3.5)	3.5 (0.8 - 4.0)	
Rated frequency (Min.-Max.)		Heating		3.2 (1.0 - 6.3)	4.0 (1.0 - 6.6)	
Breaker Capacity			A	10	12	
Electrical data	Power input *1 (Total)		W	485	820	
				Heating	580	800
	Running current *1 (Total)		A	Cooling	2.6	3.9
				Heating	2.9	3.8
	Power factor *1 (Total)		%	Cooling	81	91
				Heating	86	91
Starting current *1 (Total)			A	2.9	3.9	
Coefficient of performance (COP) *1 (Total)		Cooling		5.15	4.27	
		Heating		5.52	5.00	
Compressor	Model			SNB140FRUMT		
	Output		W	950		
	Current *1	Cooling	A	2.04	3.32	
		Heating		2.34	3.22	
Refrigeration oil (Model)			L	0.35 (FV50S)		
Fan motor	Model			RC0J50-CI		
	Current *1	Cooling	A	0.28	0.30	
Heating		0.28		0.30		
Dimensions W × H × D			mm	800 × 550 × 285		
Weight			kg	37		
Special remarks	Dehumidification		Cooling	L/h	0.2	0.8
	Air flow *1	Cooling	High	m <sup>3</sup> /h	1,806	
			Low		1,038	
		Heating	High		2,016	
			Med.		1,710	
			Low		1,326	
	Sound level *1	Cooling		dB(A)	46	49
		Heating			49	50
	Fan speed	Cooling	High	rpm	810	
			Low		490	
		Heating	High		900	
			Med.		770	
Low			610			
Fan speed regulator				3		
Refrigerant filling capacity (R410A)			kg	1.15		

**NOTE:** Test conditions are based on ISO 5151.

Cooling: Indoor Dry-bulb temperature 27°C  
 Outdoor Dry-bulb temperature 35°C

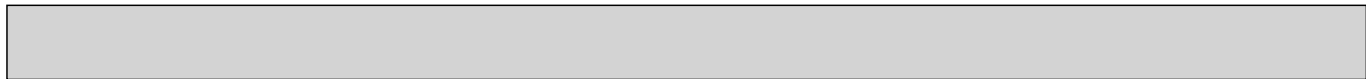
Wet-bulb temperature 19°C

Heating: Indoor Dry-bulb temperature 20°C  
 Outdoor Dry-bulb temperature 7°C

Wet-bulb temperature 6°C

Refrigerant piping length (one way): 5 m

\*1 Measured under rated operating frequency.



Outdoor model				<b>MUZ-FH50VEHZ</b>		
Power supply				Single phase, 230 V, 50 Hz		
Capacity		Cooling	kW	5.0 (1.9 - 6.0)		
Rated frequency (Min. - Max.)		Heating		6.0 (1.7 - 8.7)		
Breaker Capacity			A	16		
Electrical data	Power input *1 (Total)		Cooling	W	1,380	
			Heating		1,480	
	Running current *1 (Total)		Cooling	A	6.1	
			Heating		6.5	
	Power factor *1 (Total)		Cooling	%	98	
		Heating	98			
Starting current *1 (Total)			A	6.5		
Coefficient of performance (COP) *1 (Total)		Cooling	3.62			
		Heating	4.05			
Compressor		Model		SNB172FEKMT		
		Output	W	1,200		
Current *1		Cooling	A	4.98		
		Heating		5.37		
Refrigeration oil (Model)		L		0.40(FV50S)		
Fan motor		Model		RC0J60-BC		
Current *1		Cooling	A	0.83		
		Heating		0.84		
Dimensions W × H × D			mm	840 × 880 × 330		
Weight			kg	55		
Special remarks	Dehumidification		Cooling	L/h	2.0	
	Air flow *1	Cooling	High	m <sup>3</sup> /h	3,006	
			Med.		3,006	
			Low		1,626	
		Heating	High		2,892	
			Med.		2,892	
			Low		2,280	
	Sound level *1		Cooling	dB(A)	51	
			Heating		54	
	Fan speed	Cooling	High	rpm	840	
			Med.		840	
			Low		480	
		Heating	High		810	
			Med.		810	
			Low		650	
Fan speed regulator			3			
Refrigerant filling capacity (R410A)			kg	1.55		

**NOTE:** Test conditions are based on ISO 5151.

Cooling: Indoor Dry-bulb temperature 27°C

Wet-bulb temperature 19°C

Outdoor Dry-bulb temperature 35°C

Heating: Indoor Dry-bulb temperature 20°C

Wet-bulb temperature 6°C

Outdoor Dry-bulb temperature 7°C

Refrigerant piping length (one way): 5 m

\*1 Measured under rated operating frequency.



**Specifications and rated conditions of main electric parts**

Item		Model	MUZ-FH25VEHZ	MUZ-FH35VEHZ
Smoothing capacitor		(C61, C62)	600 μF/ 620 μF 420 V	
Diode module		(DB61)	15 A 600 V	
Fuse		(F61)	T20AL250V	
		(F701, F801, F901)	T3.15AL250V	
Defrost heater		(H)	230 V 130 W	
Power module		(IC700)	15 A 600 V	
		(IC932)	8A600V	
Expansion valve coil		(LEV)	12 V DC	
Reactor		(L61)	23 mH	
Power factor controller		(IC820)	20A 600V	
Circuit protection		(PTC64, PTC65)	33 Ω	
Terminal block		(TB)	5 P	
Relay		(X63)	3 A 250 V	
		(X64)	20 A 250 V	
		(X66)	3 A 250 V	
		(X69)	10A 230V	
R.V. coil		(21S4)	220 - 240 V AC	
Heater protector		(26H)	Open 45°C	

**Specifications and rated conditions of main electric parts**

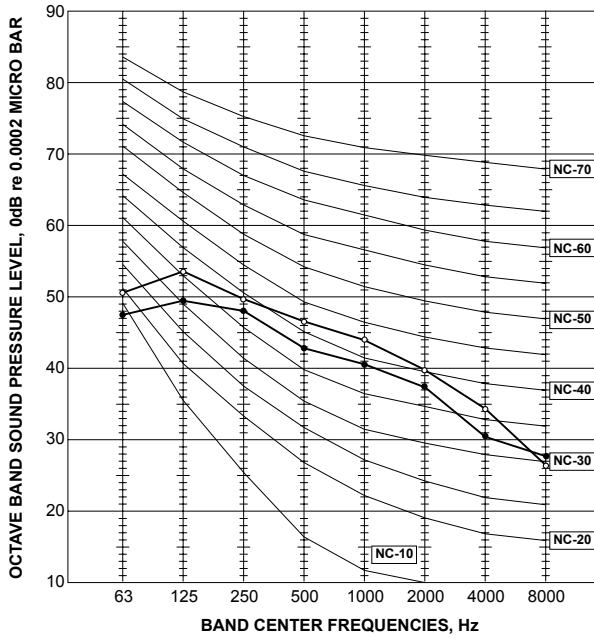
Item		Model	MUZ-FH50VEHZ
Smoothing capacitor		(CB1, CB2, CB3)	560 μF 450 V
Fuse		(F601, F880, F901)	T3.15AL250 V
Defrost heater		(H)	230 V 120 W
IGBT module		(IC932)	5 A 600 V
		(IC700)	20 A 600 V
Expansion valve coil		(LEV)	12 V DC
Reactor		(L)	340 μH
Diode module		(IC820)	20 A 600 V
Circuit protection		(PTC64, PTC65)	33 Ω
Terminal block		(TB1, TB2)	3 P
Relay		(X64)	20 A 250 V
		(X65)	20 A 250 V
		(X69)	10 A 250 V
		(X601)	3 A 250 V
		(X602)	3 A 250 V
R.V. coil		(21S4)	220 - 240 V AC
Heater protector		(26H)	Open 45 °C

# 4

# NOISE CRITERIA CURVES

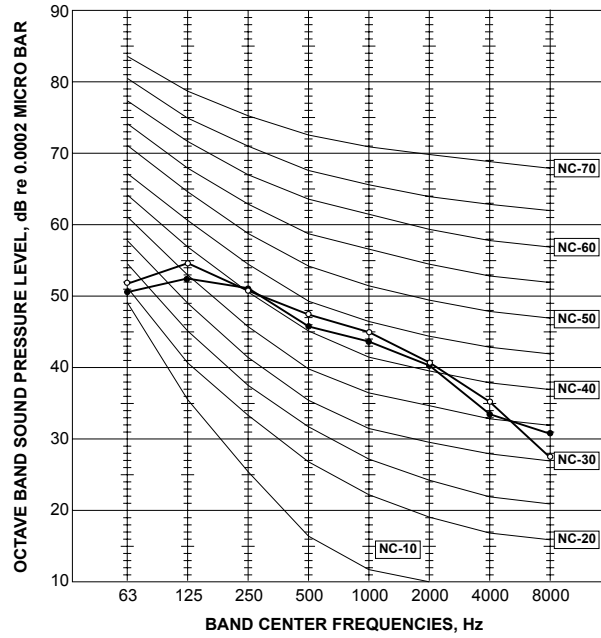
## MUZ-FH25VEHZ

FUNCTION	SPL(dB(A))	LINE
COOLING	46	●—●
HEATING	49	○—○



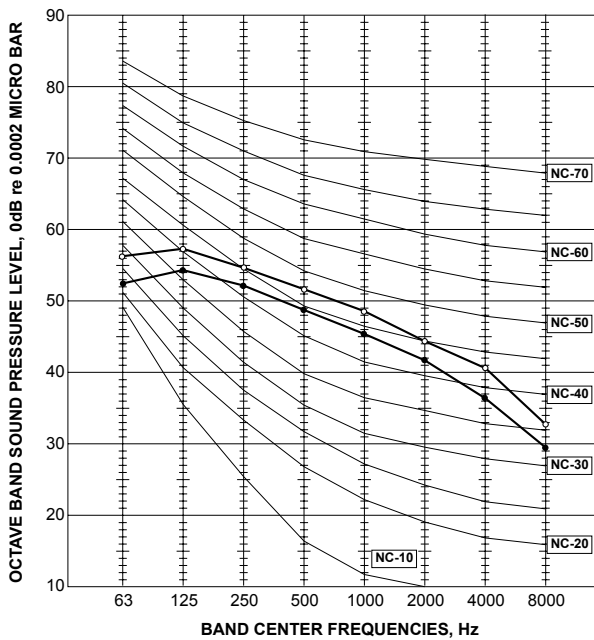
## MUZ-FH35VEHZ

FUNCTION	SPL(dB(A))	LINE
COOLING	49	●—●
HEATING	50	○—○



## MUZ-FH50VEHZ

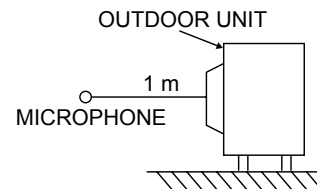
FUNCTION	SPL(dB(A))	LINE
COOLING	51	●—●
HEATING	54	○—○



### Test conditions

Cooling: Dry-bulb temperature 35°C

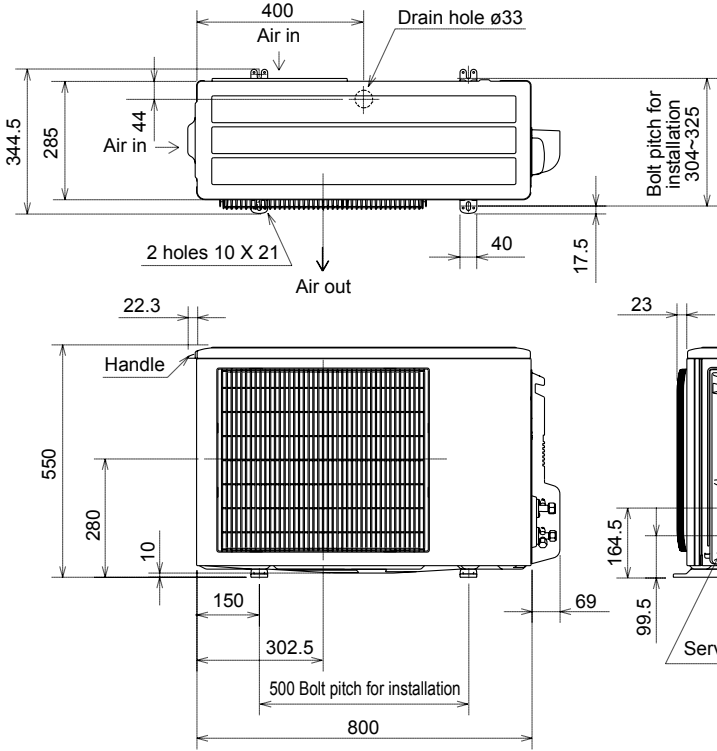
Heating: Dry-bulb temperature 7°C Wet-bulb temperature 6°C



# 5

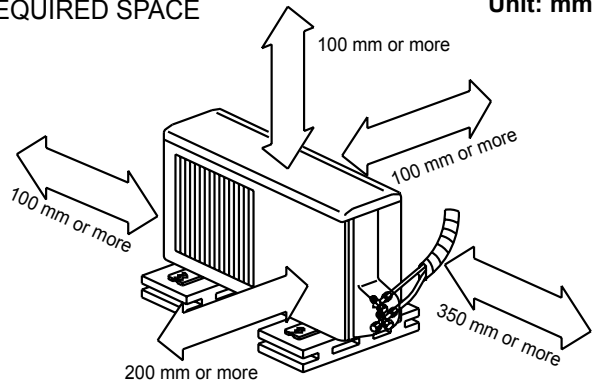
# OUTLINES AND DIMENSIONS

## MUZ-FH25VEHZ MUZ-FH35VEHZ

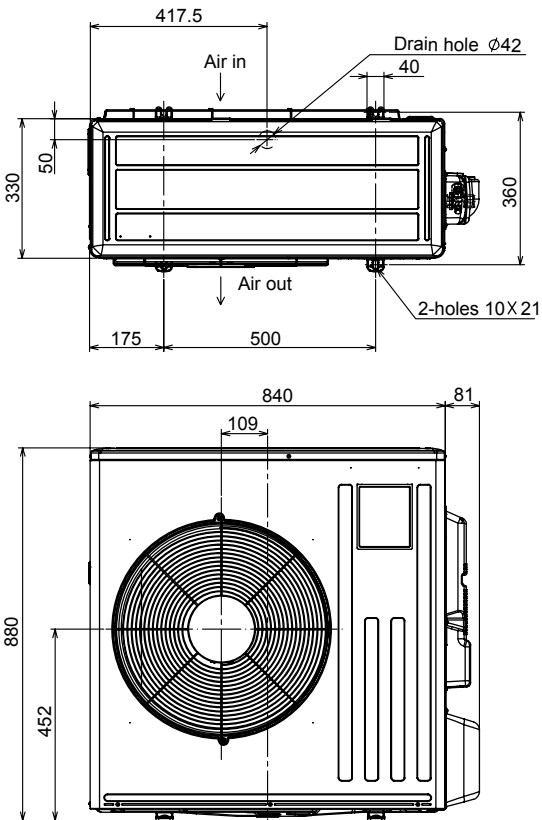


### REQUIRED SPACE

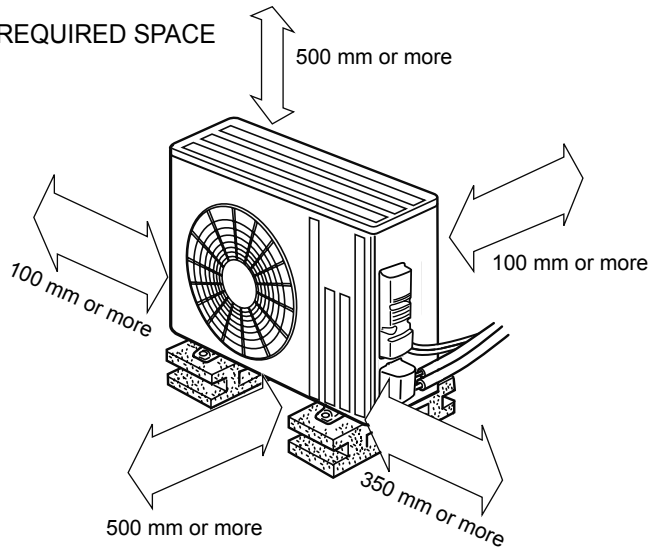
Unit: mm



## MUZ-FH50VEHZ



### REQUIRED SPACE



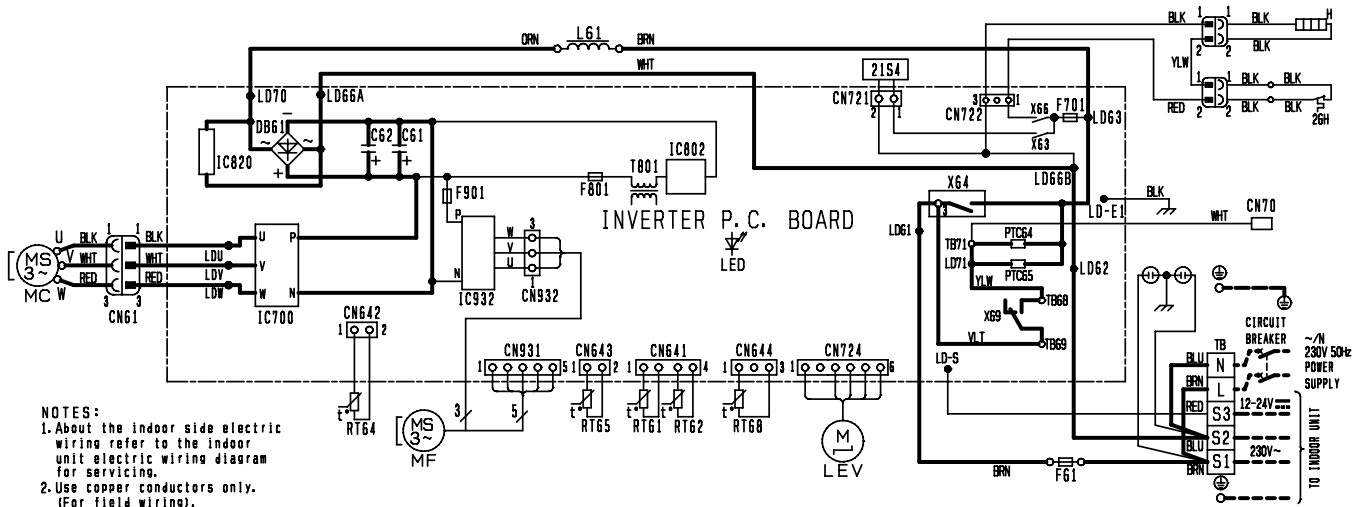
## OBH625A



# 6

# WIRING DIAGRAM

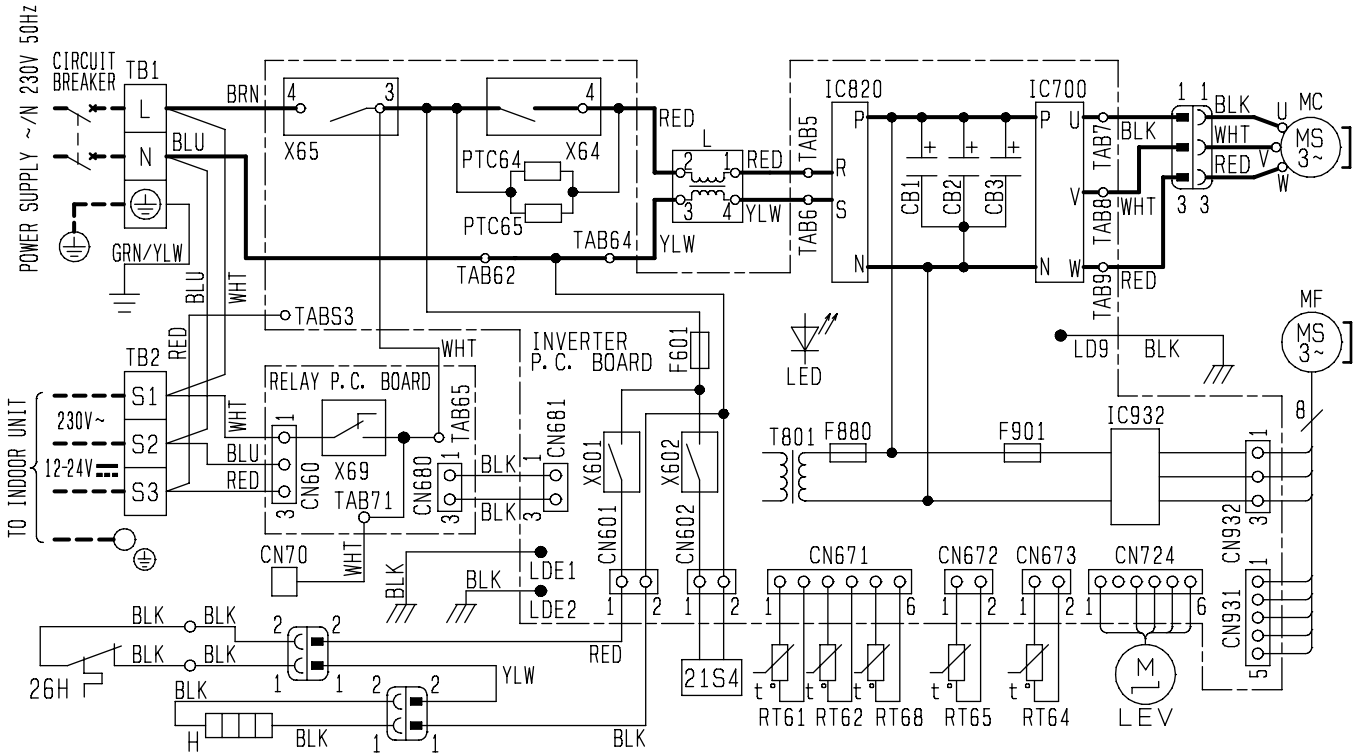
MUZ-FH25VEHZ  
MUZ-FH35VEHZ



NOTES:  
1. About the indoor side electric wiring refer to the indoor unit electric wiring diagram for servicing.  
2. Use copper conductors only. (For field wiring).

SYMBOL	NAME	SYMBOL	NAME	SYMBOL	NAME
CN70	CONNECTOR	LEV	EXPANSION VALVE COIL	RT68	OUTDOOR HEAT EXCHANGER TEMP. THERMISTOR.
C61, C62	SMOOTHING CAPACITOR	L61	REACTOR	TB	TERMINAL BLOCK
DB61	DIODE MODULE	MC	COMPRESSOR	T801	TRANSFORMER
F61	FUSE (T20AL250V)	MF	FAN MOTOR	X63, X64	RELAY
F701, F801, F901	FUSE (T3. 15AL250V)	PTC64, PTC65	CIRCUIT PROTECTION	X66, X69	RELAY
H	DEFROST HEATER	RT61	DEFROST THERMISTOR	21S4	REVERSING VALVE COIL
IC700, IC820, IC932	POWER MODULE	RT62	DISCHARGE TEMP. THERMISTOR	26H	HEATER PROTECTOR
IC802	POWER DEVICE	RT64	FIN TEMP. THERMISTOR		
LED	LED	RT65	AMBIENT TEMP. THERMISTOR		

# MUZ-FH50VEHZ

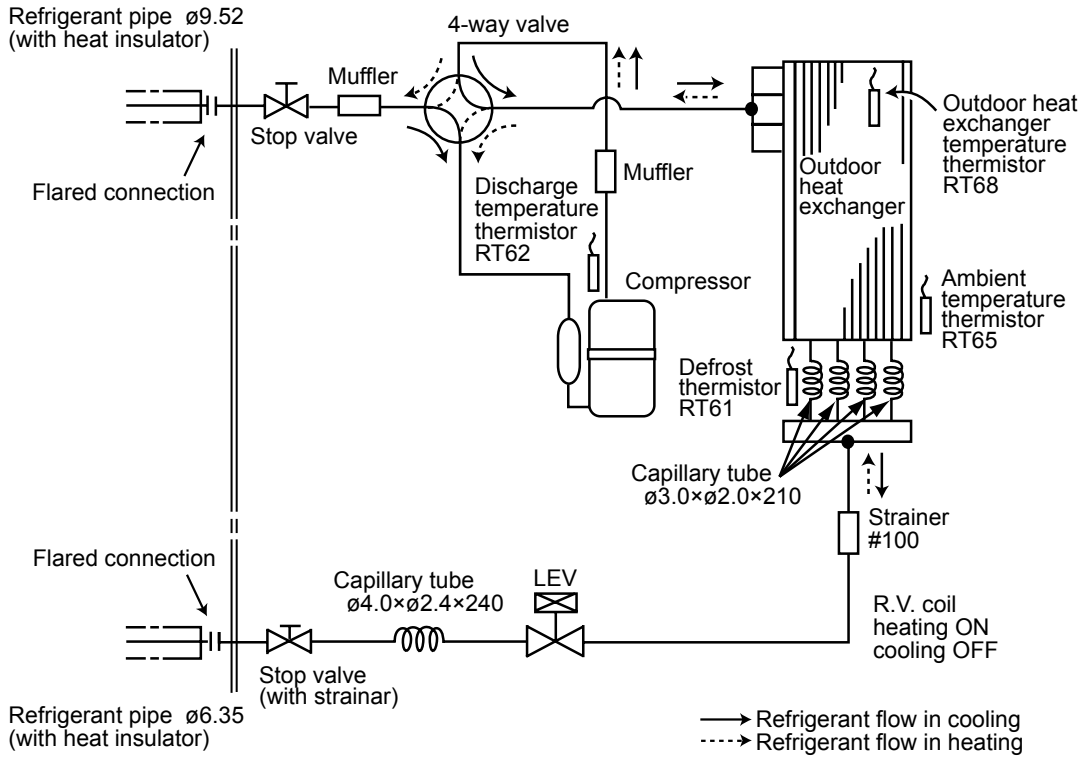


SYMBOL	NAME	SYMBOL	NAME	SYMBOL	NAME	SYMBOL	NAME
CB1~3	SMOOTHING CAPACITOR	IC932	IGBT Module	RT61	DEFROST THERMISTOR	X601	RELAY
CN70	CONNECTOR	L	REACTOR	RT62	DISCHARGE TEMP. THERMISTOR	X602	RELAY
F601	FUSE (T3. 15A/250V)	LED	LED	RT64	FIN TEMP. THERMISTOR	X64	RELAY
F880	FUSE (T3. 15A/250V)	LEV	EXPANSION VALVE COIL	RT65	AMBIENT TEMP. THERMISTOR	X69	RELAY
F901	FUSE (T3. 15A/250V)	MC	COMPRESSOR	RT68	OUTDOOR HEAT EXCHANGER TEMP. THERMISTOR	X69	RELAY
H	DEFROST HEATER	MF	FAN MOTOR	21S4	REVERSING VALVE SOLENOID COIL		
IC700	IGBT Module	PTC64	CIRCUIT PROTECTION	TB1, TB2	TERMINAL BLOCK	26H	HEATER PROTECTOR
IC820	DIODE Module	PTC65	CIRCUIT PROTECTION	T801	TRANSFORMER		

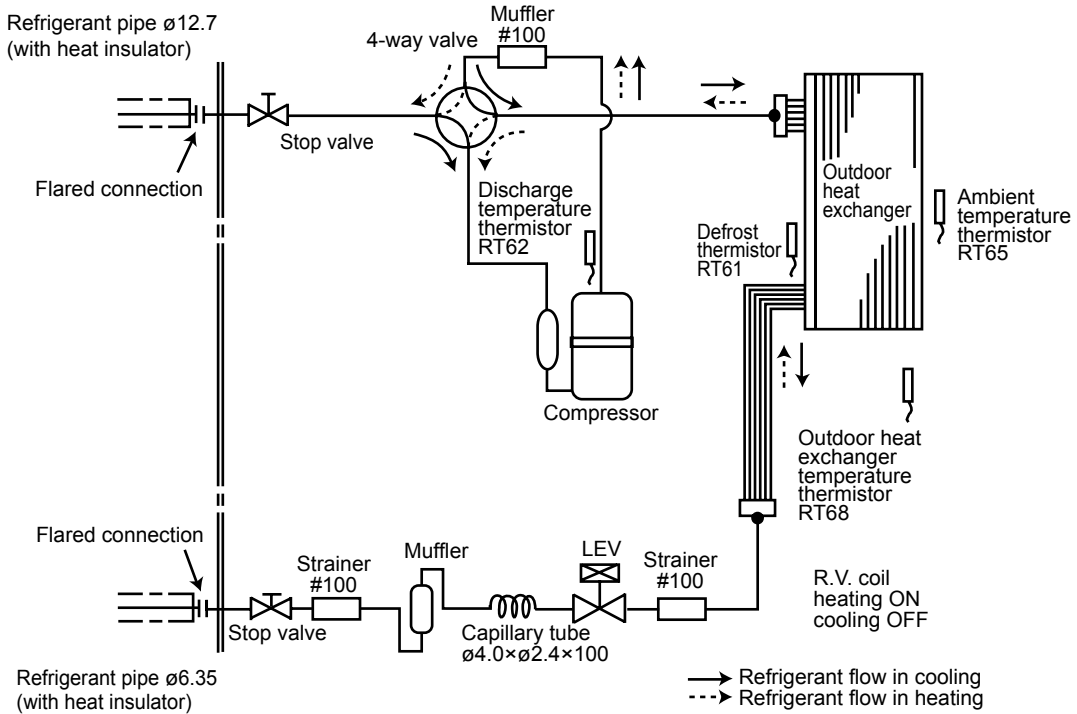
NOTES 1. About the indoor side electric wiring, refer to the indoor unit electric wiring diagram for servicing.  
 2. Use copper conductors only (for field wiring). 3. Symbols indicate, : Terminal block

MUZ-FH25VEHZ  
MUZ-FH35VEHZ

Unit: mm

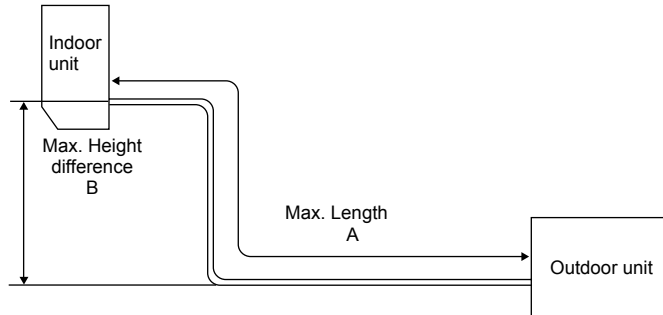


MUZ-FH50VEHZ



## MAX. REFRIGERANT PIPING LENGTH and MAX. HEIGHT DIFEFRENCE

Model	Refrigerant piping: m		Piping size O.D: mm	
	Max. Length A	Max. Height difference B	Gas	Liquid
<b>MUZ-FH25/35</b>	20	12	9.52	6.35
<b>MUZ-FH50</b>	30	15	12.7	6.35



## ADDITIONAL REFRIGERANT CHARGE (R410A: g)

Model	Outdoor unit precharged	Refrigerant piping length (one way)									
		7 m	8 m	9 m	10 m	11 m	12 m	13 m	14 m	15 m	20 m
<b>MUZ-FH25/35</b>	1,150	0	30	60	90	120	150	180	210	240	390

Calculation:  $X \text{ g} = 30 \text{ g/m} \times (\text{Refrigerant piping length (m)} - 7)$

Model	Outdoor unit precharged	Refrigerant piping length (one way)					
		7 m	10 m	15 m	20 m	25 m	30 m
<b>MUZ-FH50</b>	1,550	0	60	160	260	360	460

Calculation:  $X \text{ g} = 20 \text{ g/m} \times (\text{Refrigerant piping length (m)} - 7)$

**MUZ-FH25VEHZ**  
**MUZ-FH35VEHZ**  
**MUZ-FH50VEHZ**

The standard specifications apply only to the operation of the air conditioner under normal conditions. Since operating conditions vary according to the areas where these units are installed, the following information has been provided to clarify the operating characteristics of the air conditioner under the conditions indicated by the performance curve.

**(1) GUARANTEED VOLTAGE**

198 ~ 264 V, 50 Hz

**(2) AIR FLOW**

Air flow should be set at MAX.

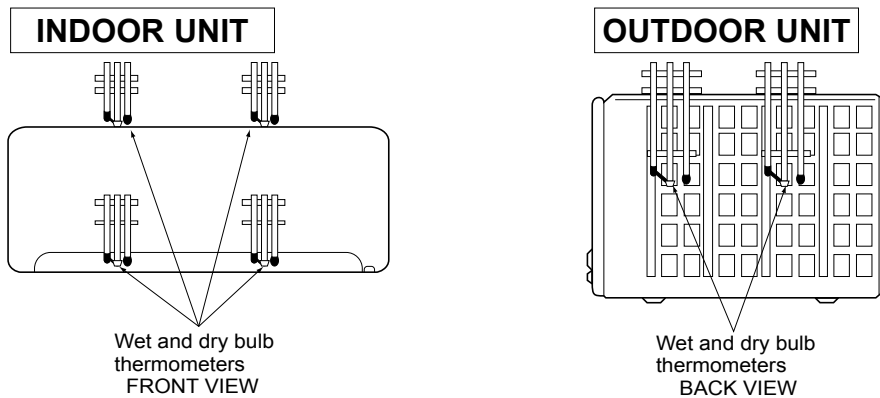
**(3) MAIN READINGS**

- |  |         |           |
|--|---------|-----------|
| (1) Indoor intake air wet-bulb temperature:  | °C [WB] | } Cooling |
| (2) Indoor outlet air wet-bulb temperature:  | °C [WB] |           |
| (3) Outdoor intake air dry-bulb temperature: | °C [DB] |           |
| (4) Total input:                             | W       | } Heating |
| (5) Indoor intake air dry-bulb temperature:  | °C [DB] |           |
| (6) Outdoor intake air wet-bulb temperature: | °C [WB] |           |
| (7) Total input:                             | W       |           |

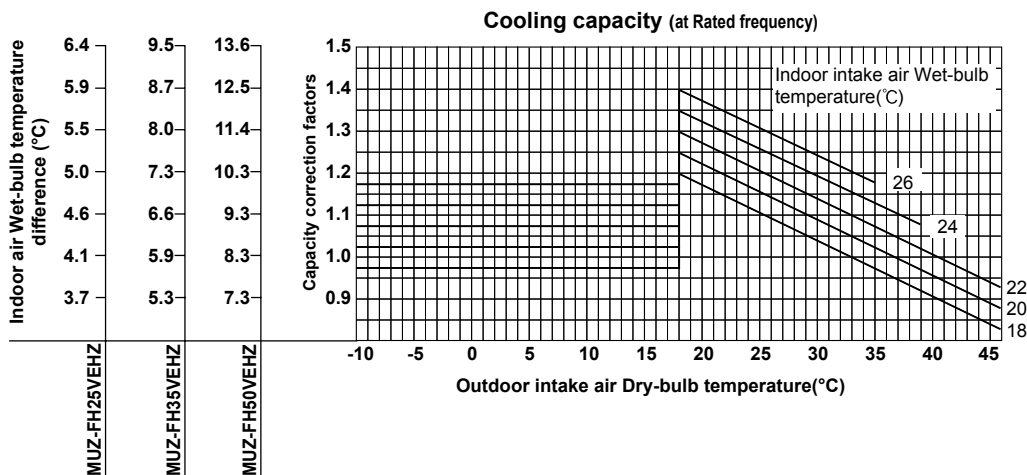
Indoor air wet and dry bulb temperature difference on the left side of the following chart shows the difference between the indoor intake air wet and dry bulb temperature and the indoor outlet air wet and dry bulb temperature for your reference at service.

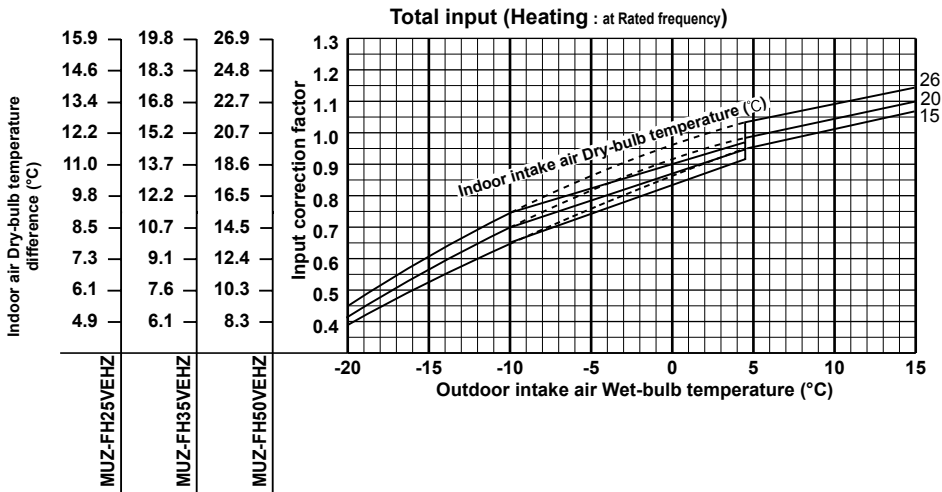
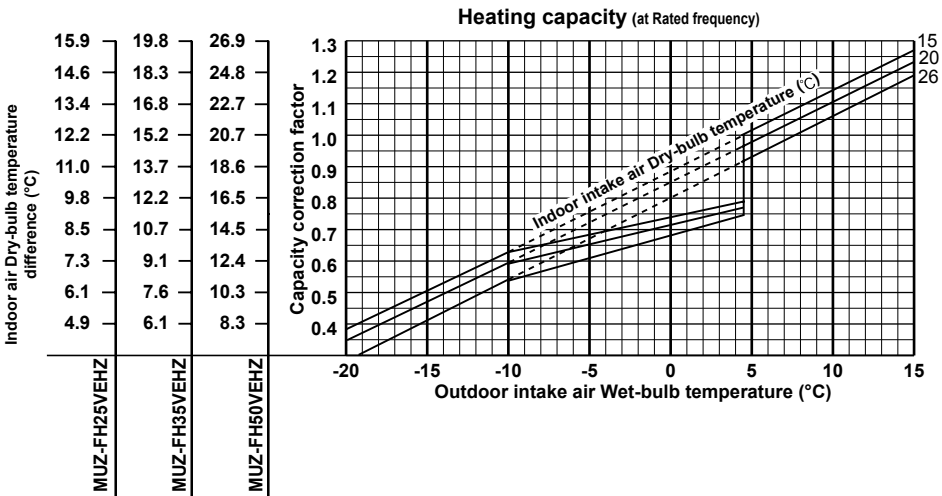
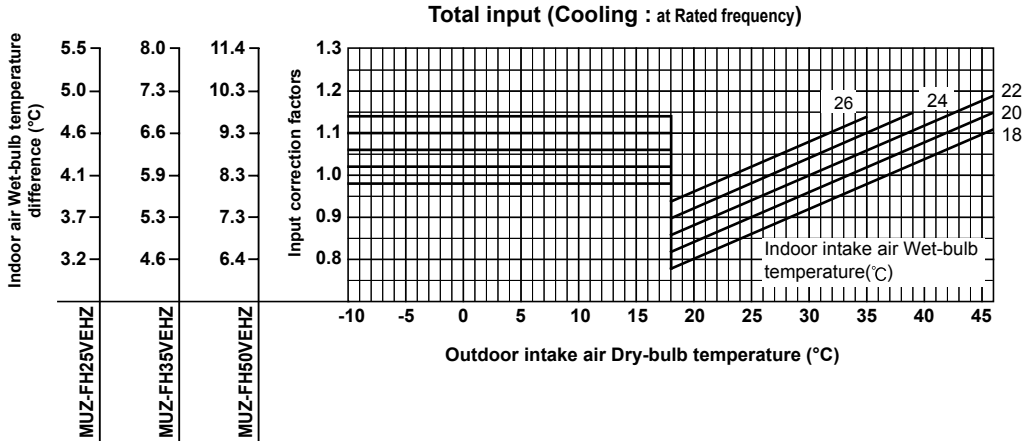
**How to measure the indoor air wet and dry bulb temperature difference**

1. Attach at least 2 sets of wet and dry bulb thermometers to the indoor air intake as shown in the figure, and at least 2 sets of wet and dry bulb thermometers to the indoor air outlet. The thermometers must be attached to the position where air speed is high.
2. Attach at least 2 sets of wet and dry bulb thermometers to the outdoor air intake.  
Cover the thermometers to prevent direct rays of the sun.
3. Check that the air filter is cleaned.
4. Open windows and doors of room.
5. Press the EMERGENCY OPERATION switch once (twice) to start the EMERGENCY COOL (HEAT) MODE.
6. When system stabilizes after more than 15 minutes, measure temperature and take an average temperature.
7. 10 minutes later, measure temperature again and check that the temperature does not change.



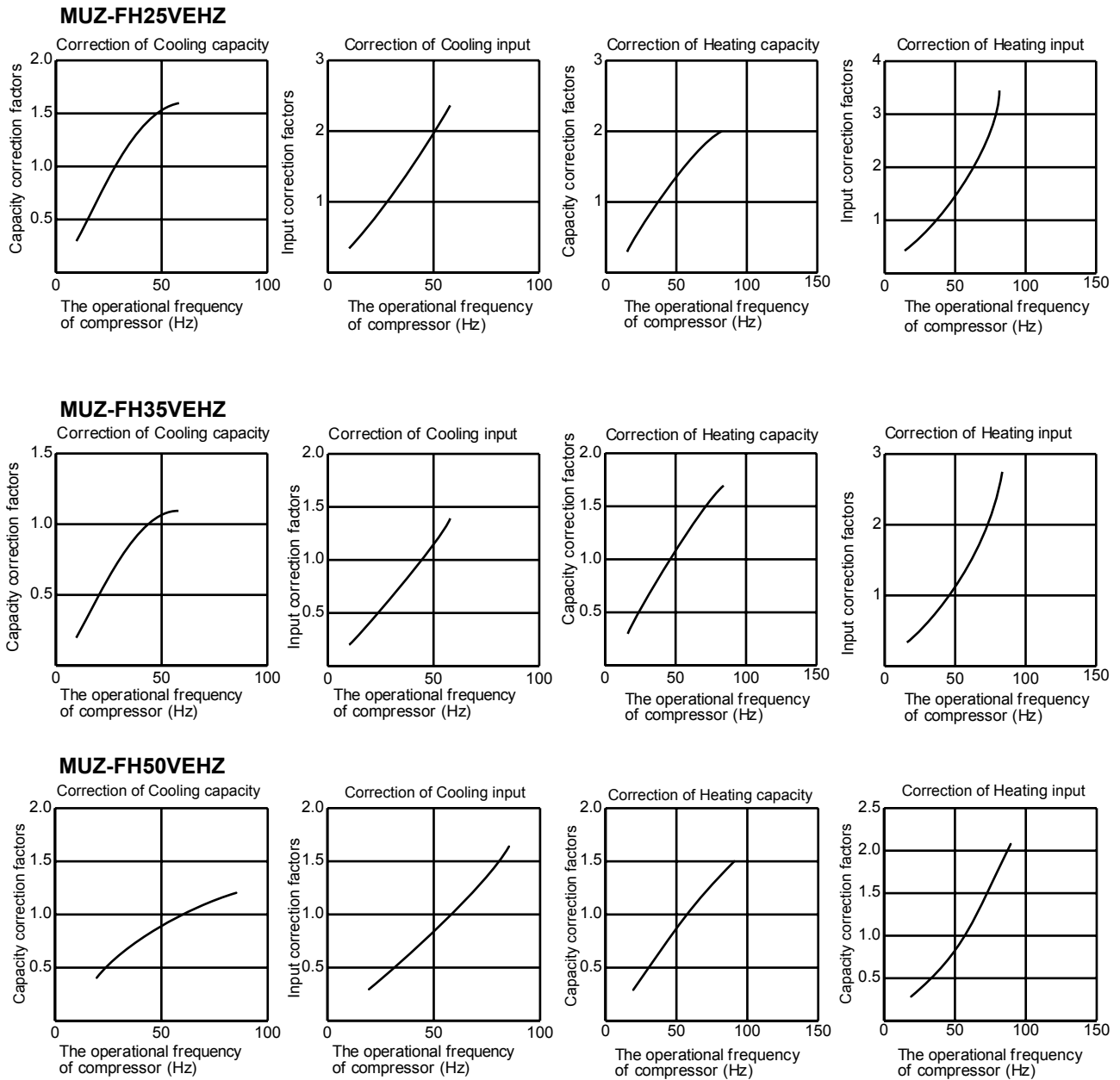
**8-1. CAPACITY AND INPUT CURVES**





**NOTE:** The above broken lines are for the heating operation without any frost and defrost operation.

## 8-2. CAPACITY AND INPUT CORRECTION BY OPERATIONAL FREQUENCY OF COMPRESSOR



## 8-3. HOW TO OPERATE FIXED-FREQUENCY OPERATION

<Test run operation>

1. Press EMERGENCY OPERATION switch to start COOL or HEAT mode (COOL: Press once, HEAT: Press twice).
2. Test run operation starts and continues to operate for 30 minutes.
3. Compressor operates at rated frequency in COOL mode or 58 Hz in HEAT mode.
4. Indoor fan operates at High speed.
5. After 30 minutes, test run operation finishes and EMERGENCY OPERATION starts (operation frequency of compressor varies).
6. To cancel test run operation (EMERGENCY OPERATION), press EMERGENCY OPERATION switch or any button on remote controller.

## 8-4. OUTDOOR LOW PRESSURE AND OUTDOOR UNIT CURRENT

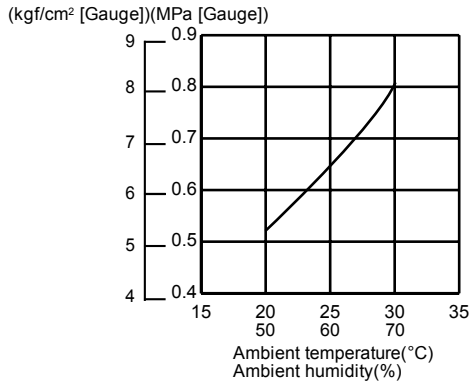
### COOL operation

- ① Both indoor and outdoor unit are under the same temperature/humidity condition.
- ② Operation: TEST RUN OPERATION (Refer to 8-3.)

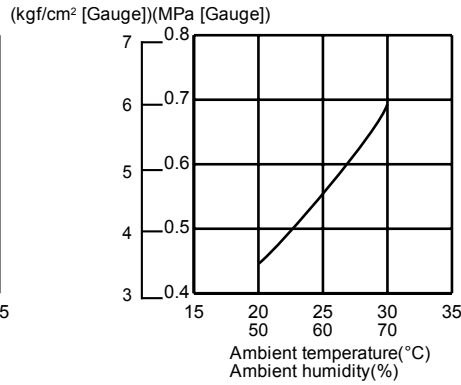
Dry-bulb temperature (°C)	Relative humidity (%)
20	50
25	60
30	70

### Outdoor low pressure

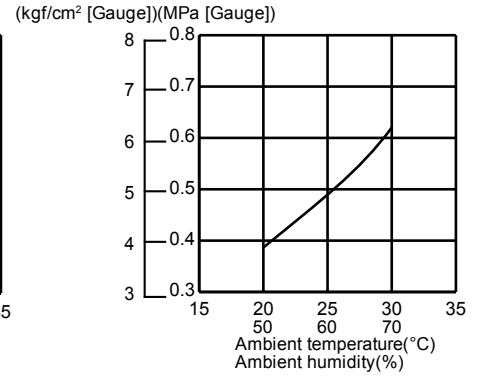
#### MUZ-FH25VEHZ



#### MUZ-FH35VEHZ



#### MUZ-FH50VEHZ

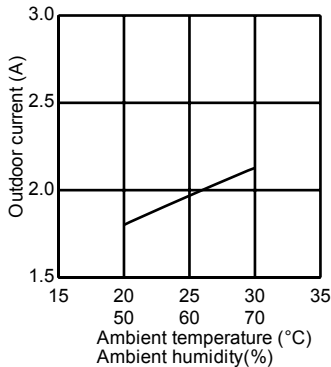


### NOTE:

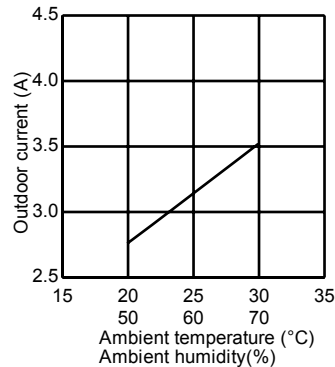
The unit of pressure has been changed to MPa on the international system of units (SI unit system)  
The conversion factor is: **1 (MPa [Gauge]) = 10.2 (kgf/cm² [Gauge])**

### Outdoor unit current

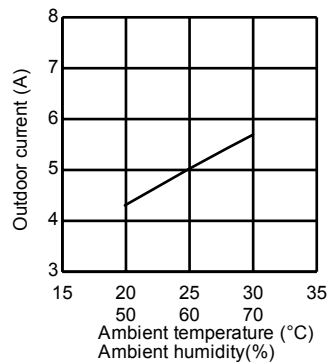
#### MUZ-FH25VEHZ



#### MUZ-FH35VEHZ



#### MUZ-FH50VEHZ



### HEAT operation

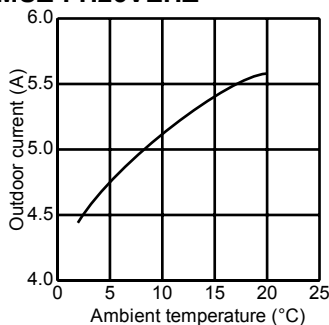
- ① Condition:

	Indoor	Outdoor			
Dry bulb temperature (°C)	20.0	2	7	15	20.0
Wet bulb temperature (°C)	14.5	1	6	12	14.5

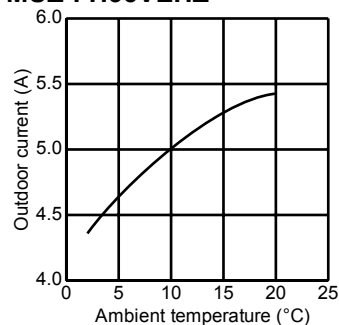
- ② Operation: Test run operation (Refer to 8-3.)

### Outdoor unit current

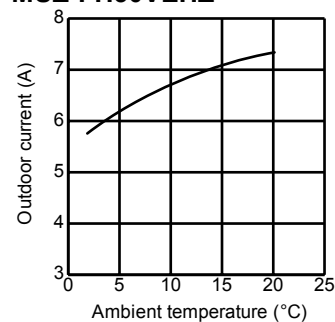
#### MUZ-FH25VEHZ



#### MUZ-FH35VEHZ



#### MUZ-FH50VEHZ





**PERFORMANCE DATA COOL operation at Rated frequency**  
**MUZ-FH25VEHZ**

CAPACITY: 2.5 kW SHF: 0.95 INPUT: 485 W

INDOOR DB (°C)	INDOOR WB (°C)	OUTDOOR DB (°C)															
		21				25				27				30			
		Q	SHC	SHF	INPUT	Q	SHC	SHF	INPUT	Q	SHC	SHF	INPUT	Q	SHC	SHF	INPUT
21	18	2.94	2.26	0.77	388	2.81	2.17	0.77	407	2.70	2.08	0.77	427	2.60	2.00	0.77	446
21	20	3.06	1.99	0.65	407	2.94	1.91	0.65	432	2.85	1.85	0.65	441	2.75	1.79	0.65	461
22	18	2.94	2.38	0.81	388	2.81	2.28	0.81	407	2.70	2.19	0.81	427	2.60	2.11	0.81	446
22	20	3.06	2.11	0.69	407	2.94	2.03	0.69	432	2.85	1.97	0.69	441	2.75	1.90	0.69	461
22	22	3.19	1.82	0.57	422	3.08	1.75	0.57	449	3.00	1.71	0.57	461	2.88	1.64	0.57	480
23	18	2.94	2.50	0.85	388	2.81	2.39	0.85	407	2.70	2.30	0.85	427	2.60	2.21	0.85	446
23	20	3.06	2.24	0.73	407	2.94	2.14	0.73	432	2.85	2.08	0.73	441	2.75	2.01	0.73	461
23	22	3.19	1.94	0.61	422	3.08	1.88	0.61	449	3.00	1.83	0.61	461	2.88	1.75	0.61	480
24	18	2.94	2.61	0.89	388	2.81	2.50	0.89	407	2.70	2.40	0.89	427	2.60	2.31	0.89	446
24	20	3.06	2.36	0.77	407	2.94	2.26	0.77	432	2.85	2.19	0.77	441	2.75	2.12	0.77	461
24	22	3.19	2.07	0.65	422	3.08	2.00	0.65	449	3.00	1.95	0.65	461	2.88	1.87	0.65	480
24	24	3.35	1.78	0.53	441	3.23	1.71	0.53	466	3.15	1.67	0.53	480	3.05	1.62	0.53	504
25	18	2.94	2.73	0.93	388	2.81	2.62	0.93	407	2.70	2.51	0.93	427	2.60	2.42	0.93	446
25	20	3.06	2.48	0.81	407	2.94	2.38	0.81	432	2.85	2.31	0.81	441	2.75	2.23	0.81	461
25	22	3.19	2.20	0.69	422	3.08	2.12	0.69	449	3.00	2.07	0.69	461	2.88	1.98	0.69	480
25	24	3.35	1.91	0.57	441	3.23	1.84	0.57	466	3.15	1.80	0.57	480	3.05	1.74	0.57	504
26	18	2.94	2.85	0.97	388	2.81	2.73	0.97	407	2.70	2.62	0.97	427	2.60	2.52	0.97	446
26	20	3.06	2.60	0.85	407	2.94	2.50	0.85	432	2.85	2.42	0.85	441	2.75	2.34	0.85	461
26	22	3.19	2.33	0.73	422	3.08	2.24	0.73	449	3.00	2.19	0.73	461	2.88	2.10	0.73	480
26	24	3.35	2.04	0.61	441	3.23	1.97	0.61	466	3.15	1.92	0.61	480	3.05	1.86	0.61	504
26	26	3.45	1.69	0.49	466	3.35	1.64	0.49	490	3.30	1.62	0.49	504	3.20	1.57	0.49	519
27	18	2.94	2.94	1.00	388	2.81	2.81	1.00	407	2.70	2.70	1.00	427	2.60	2.60	1.00	446
27	20	3.06	2.73	0.89	407	2.94	2.61	0.89	432	2.85	2.54	0.89	441	2.75	2.45	0.89	461
27	22	3.19	2.45	0.77	422	3.08	2.37	0.77	449	3.00	2.31	0.77	461	2.88	2.21	0.77	480
27	24	3.35	2.18	0.65	441	3.23	2.10	0.65	466	3.15	2.05	0.65	480	3.05	1.98	0.65	504
27	26	3.45	1.83	0.53	466	3.35	1.78	0.53	490	3.30	1.75	0.53	504	3.20	1.70	0.53	519
28	18	2.94	2.94	1.00	388	2.81	2.81	1.00	407	2.70	2.70	1.00	427	2.60	2.60	1.00	446
28	20	3.06	2.85	0.93	407	2.94	2.73	0.93	432	2.85	2.65	0.93	441	2.75	2.56	0.93	461
28	22	3.19	2.58	0.81	422	3.08	2.49	0.81	449	3.00	2.43	0.81	461	2.88	2.33	0.81	480
28	24	3.35	2.31	0.69	441	3.23	2.23	0.69	466	3.15	2.17	0.69	480	3.05	2.10	0.69	504
28	26	3.45	1.97	0.57	466	3.35	1.91	0.57	490	3.30	1.88	0.57	504	3.20	1.82	0.57	519
29	18	2.94	2.94	1.00	388	2.81	2.81	1.00	407	2.70	2.70	1.00	427	2.60	2.60	1.00	446
29	20	3.06	2.97	0.97	407	2.94	2.85	0.97	432	2.85	2.76	0.97	441	2.75	2.67	0.97	461
29	22	3.19	2.71	0.85	422	3.08	2.61	0.85	449	3.00	2.55	0.85	461	2.88	2.44	0.85	480
29	24	3.35	2.45	0.73	441	3.23	2.35	0.73	466	3.15	2.30	0.73	480	3.05	2.23	0.73	504
29	26	3.45	2.10	0.61	466	3.35	2.04	0.61	490	3.30	2.01	0.61	504	3.20	1.95	0.61	519
30	18	2.94	2.94	1.00	388	2.81	2.81	1.00	407	2.70	2.70	1.00	427	2.60	2.60	1.00	446
30	20	3.06	3.06	1.00	407	2.94	2.94	1.00	432	2.85	2.85	1.00	441	2.75	2.75	1.00	461
30	22	3.19	2.84	0.89	422	3.08	2.74	0.89	449	3.00	2.67	0.89	461	2.88	2.56	0.89	480
30	24	3.35	2.58	0.77	441	3.23	2.48	0.77	466	3.15	2.43	0.77	480	3.05	2.35	0.77	504
30	26	3.45	2.24	0.65	466	3.35	2.18	0.65	490	3.30	2.15	0.65	504	3.20	2.08	0.65	519
31	18	2.94	2.94	1.00	388	2.81	2.81	1.00	407	2.70	2.70	1.00	427	2.60	2.60	1.00	446
31	20	3.06	3.06	1.00	407	2.94	2.94	1.00	432	2.85	2.85	1.00	441	2.75	2.75	1.00	461
31	22	3.19	2.96	0.93	422	3.08	2.86	0.93	449	3.00	2.79	0.93	461	2.88	2.67	0.93	480
31	24	3.35	2.71	0.81	441	3.23	2.61	0.81	466	3.15	2.55	0.81	480	3.05	2.47	0.81	504
31	26	3.45	2.38	0.69	466	3.35	2.31	0.69	490	3.30	2.28	0.69	504	3.20	2.21	0.69	519
32	18	2.94	2.94	1.00	388	2.81	2.81	1.00	407	2.70	2.70	1.00	427	2.60	2.60	1.00	446
32	20	3.06	3.06	1.00	407	2.94	2.94	1.00	432	2.85	2.85	1.00	441	2.75	2.75	1.00	461
32	22	3.19	3.09	0.97	422	3.08	2.98	0.97	449	3.00	2.91	0.97	461	2.88	2.79	0.97	480
32	24	3.35	2.85	0.85	441	3.23	2.74	0.85	466	3.15	2.68	0.85	480	3.05	2.59	0.85	504
32	26	3.45	2.52	0.73	466	3.35	2.45	0.73	490	3.30	2.41	0.73	504	3.20	2.34	0.73	519

**NOTE** Q : Total capacity (kW) SHF : Sensible heat factor DB : Dry-bulb temperature  
 SHC : Sensible heat capacity (kW) INPUT : Total power input (W) WB : Wet-bulb temperature

**PERFORMANCE DATA COOL operation at Rated frequency**

**MUZ-FH25VEHZ**

CAPACITY: 2.5 kW

SHF: 0.95

INPUT: 485 W

INDOOR DB (°C)	INDOOR WB (°C)	OUTDOOR DB (°C)											
		35				40				46			
		Q	SHC	SHF	INPUT	Q	SHC	SHF	INPUT	Q	SHC	SHF	INPUT
21	18	2.45	1.89	0.77	475	2.25	1.73	0.77	504	2.08	1.60	0.77	524
21	20	2.58	1.67	0.65	495	2.40	1.56	0.65	519	2.23	1.45	0.65	548
22	18	2.45	1.98	0.81	475	2.25	1.82	0.81	504	2.08	1.68	0.81	524
22	20	2.58	1.78	0.69	495	2.40	1.66	0.69	519	2.23	1.54	0.69	548
22	22	2.73	1.55	0.57	514	2.55	1.45	0.57	543	2.38	1.35	0.57	563
23	18	2.45	2.08	0.85	475	2.25	1.91	0.85	504	2.08	1.76	0.85	524
23	20	2.58	1.88	0.73	495	2.40	1.75	0.73	519	2.23	1.62	0.73	548
23	22	2.73	1.66	0.61	514	2.55	1.56	0.61	543	2.38	1.45	0.61	563
24	18	2.45	2.18	0.89	475	2.25	2.00	0.89	504	2.08	1.85	0.89	524
24	20	2.58	1.98	0.77	495	2.40	1.85	0.77	519	2.23	1.71	0.77	548
24	22	2.73	1.77	0.65	514	2.55	1.66	0.65	543	2.38	1.54	0.65	563
24	24	2.88	1.52	0.53	534	2.70	1.43	0.53	558	2.55	1.35	0.53	582
25	18	2.45	2.28	0.93	475	2.25	2.09	0.93	504	2.08	1.93	0.93	524
25	20	2.58	2.09	0.81	495	2.40	1.94	0.81	519	2.23	1.80	0.81	548
25	22	2.73	1.88	0.69	514	2.55	1.76	0.69	543	2.38	1.64	0.69	563
25	24	2.88	1.64	0.57	534	2.70	1.54	0.57	558	2.55	1.45	0.57	582
26	18	2.45	2.38	0.97	475	2.25	2.18	0.97	504	2.08	2.01	0.97	524
26	20	2.58	2.19	0.85	495	2.40	2.04	0.85	519	2.23	1.89	0.85	548
26	22	2.73	1.99	0.73	514	2.55	1.86	0.73	543	2.38	1.73	0.73	563
26	24	2.88	1.75	0.61	534	2.70	1.65	0.61	558	2.55	1.56	0.61	582
26	26	3.03	1.48	0.49	553	2.85	1.40	0.49	577	2.68	1.31	0.49	601
27	18	2.45	2.45	1.00	475	2.25	2.25	1.00	504	2.08	2.08	1.00	524
27	20	2.58	2.29	0.89	495	2.40	2.14	0.89	519	2.23	1.98	0.89	548
27	22	2.73	2.10	0.77	514	2.55	1.96	0.77	543	2.38	1.83	0.77	563
27	24	2.88	1.87	0.65	534	2.70	1.76	0.65	558	2.55	1.66	0.65	582
27	26	3.03	1.60	0.53	553	2.85	1.51	0.53	577	2.68	1.42	0.53	601
28	18	2.45	2.45	1.00	475	2.25	2.25	1.00	504	2.08	2.08	1.00	524
28	20	2.58	2.39	0.93	495	2.40	2.23	0.93	519	2.23	2.07	0.93	548
28	22	2.73	2.21	0.81	514	2.55	2.07	0.81	543	2.38	1.92	0.81	563
28	24	2.88	1.98	0.69	534	2.70	1.86	0.69	558	2.55	1.76	0.69	582
28	26	3.03	1.72	0.57	553	2.85	1.62	0.57	577	2.68	1.52	0.57	601
29	18	2.45	2.45	1.00	475	2.25	2.25	1.00	504	2.08	2.08	1.00	524
29	20	2.58	2.50	0.97	495	2.40	2.33	0.97	519	2.23	2.16	0.97	548
29	22	2.73	2.32	0.85	514	2.55	2.17	0.85	543	2.38	2.02	0.85	563
29	24	2.88	2.10	0.73	534	2.70	1.97	0.73	558	2.55	1.86	0.73	582
29	26	3.03	1.85	0.61	553	2.85	1.74	0.61	577	2.68	1.63	0.61	601
30	18	2.45	2.45	1.00	475	2.25	2.25	1.00	504	2.08	2.08	1.00	524
30	20	2.58	2.58	1.00	495	2.40	2.40	1.00	519	2.23	2.23	1.00	548
30	22	2.73	2.43	0.89	514	2.55	2.27	0.89	543	2.38	2.11	0.89	563
30	24	2.88	2.21	0.77	534	2.70	2.08	0.77	558	2.55	1.96	0.77	582
30	26	3.03	1.97	0.65	553	2.85	1.85	0.65	577	2.68	1.74	0.65	601
31	18	2.45	2.45	1.00	475	2.25	2.25	1.00	504	2.08	2.08	1.00	524
31	20	2.58	2.58	1.00	495	2.40	2.40	1.00	519	2.23	2.23	1.00	548
31	22	2.73	2.53	0.93	514	2.55	2.37	0.93	543	2.38	2.21	0.93	563
31	24	2.88	2.33	0.81	534	2.70	2.19	0.81	558	2.55	2.07	0.81	582
31	26	3.03	2.09	0.69	553	2.85	1.97	0.69	577	2.68	1.85	0.69	601
32	18	2.45	2.45	1.00	475	2.25	2.25	1.00	504	2.08	2.08	1.00	524
32	20	2.58	2.58	1.00	495	2.40	2.40	1.00	519	2.23	2.23	1.00	548
32	22	2.73	2.64	0.97	514	2.55	2.47	0.97	543	2.38	2.30	0.97	563
32	24	2.88	2.44	0.85	534	2.70	2.30	0.85	558	2.55	2.17	0.85	582
32	26	3.03	2.21	0.73	553	2.85	2.08	0.73	577	2.68	1.95	0.73	601

**NOTE** Q : Total capacity (kW) SHF : Sensible heat factor DB : Dry-bulb temperature  
 SHC : Sensible heat capacity (kW) INPUT : Total power input (W) WB : Wet-bulb temperature

**PERFORMANCE DATA COOL operation at Rated frequency**  
**MUZ-FH35VEHZ**

CAPACITY: 3.5 kW SHF: 0.84 INPUT: 820 W

INDOOR DB (°C)	INDOOR WB (°C)	OUTDOOR DB (°C)															
		21				25				27				30			
		Q	SHC	SHF	INPUT	Q	SHC	SHF	INPUT	Q	SHC	SHF	INPUT	Q	SHC	SHF	INPUT
21	18	4.11	2.71	0.66	656	3.94	2.60	0.66	689	3.78	2.49	0.66	722	3.64	2.40	0.66	754
21	20	4.29	2.32	0.54	689	4.11	2.22	0.54	730	3.99	2.15	0.54	746	3.85	2.08	0.54	779
22	18	4.11	2.88	0.70	656	3.94	2.76	0.70	689	3.78	2.65	0.70	722	3.64	2.55	0.70	754
22	20	4.29	2.49	0.58	689	4.11	2.39	0.58	730	3.99	2.31	0.58	746	3.85	2.23	0.58	779
22	22	4.46	2.05	0.46	713	4.31	1.98	0.46	759	4.20	1.93	0.46	779	4.03	1.85	0.46	812
23	18	4.11	3.04	0.74	656	3.94	2.91	0.74	689	3.78	2.80	0.74	722	3.64	2.69	0.74	754
23	20	4.29	2.66	0.62	689	4.11	2.55	0.62	730	3.99	2.47	0.62	746	3.85	2.39	0.62	779
23	22	4.46	2.23	0.50	713	4.31	2.15	0.50	759	4.20	2.10	0.50	779	4.03	2.01	0.50	812
24	18	4.11	3.21	0.78	656	3.94	3.07	0.78	689	3.78	2.95	0.78	722	3.64	2.84	0.78	754
24	20	4.29	2.83	0.66	689	4.11	2.71	0.66	730	3.99	2.63	0.66	746	3.85	2.54	0.66	779
24	22	4.46	2.41	0.54	713	4.31	2.32	0.54	759	4.20	2.27	0.54	779	4.03	2.17	0.54	812
24	24	4.69	1.97	0.42	746	4.52	1.90	0.42	787	4.41	1.85	0.42	812	4.27	1.79	0.42	853
25	18	4.11	3.37	0.82	656	3.94	3.23	0.82	689	3.78	3.10	0.82	722	3.64	2.98	0.82	754
25	20	4.29	3.00	0.70	689	4.11	2.88	0.70	730	3.99	2.79	0.70	746	3.85	2.70	0.70	779
25	22	4.46	2.59	0.58	713	4.31	2.50	0.58	759	4.20	2.44	0.58	779	4.03	2.33	0.58	812
25	24	4.69	2.16	0.46	746	4.52	2.08	0.46	787	4.41	2.03	0.46	812	4.27	1.96	0.46	853
26	18	4.11	3.54	0.86	656	3.94	3.39	0.86	689	3.78	3.25	0.86	722	3.64	3.13	0.86	754
26	20	4.29	3.17	0.74	689	4.11	3.04	0.74	730	3.99	2.95	0.74	746	3.85	2.85	0.74	779
26	22	4.46	2.77	0.62	713	4.31	2.67	0.62	759	4.20	2.60	0.62	779	4.03	2.50	0.62	812
26	24	4.69	2.35	0.50	746	4.52	2.26	0.50	787	4.41	2.21	0.50	812	4.27	2.14	0.50	853
26	26	4.83	1.84	0.38	787	4.69	1.78	0.38	828	4.62	1.76	0.38	853	4.48	1.70	0.38	877
27	18	4.11	3.70	0.90	656	3.94	3.54	0.90	689	3.78	3.40	0.90	722	3.64	3.28	0.90	754
27	20	4.29	3.34	0.78	689	4.11	3.21	0.78	730	3.99	3.11	0.78	746	3.85	3.00	0.78	779
27	22	4.46	2.95	0.66	713	4.31	2.84	0.66	759	4.20	2.77	0.66	779	4.03	2.66	0.66	812
27	24	4.69	2.53	0.54	746	4.52	2.44	0.54	787	4.41	2.38	0.54	812	4.27	2.31	0.54	853
27	26	4.83	2.03	0.42	787	4.69	1.97	0.42	828	4.62	1.94	0.42	853	4.48	1.88	0.42	877
28	18	4.11	3.87	0.94	656	3.94	3.70	0.94	689	3.78	3.55	0.94	722	3.64	3.42	0.94	754
28	20	4.29	3.52	0.82	689	4.11	3.37	0.82	730	3.99	3.27	0.82	746	3.85	3.16	0.82	779
28	22	4.46	3.12	0.70	713	4.31	3.01	0.70	759	4.20	2.94	0.70	779	4.03	2.82	0.70	812
28	24	4.69	2.72	0.58	746	4.52	2.62	0.58	787	4.41	2.56	0.58	812	4.27	2.48	0.58	853
28	26	4.83	2.22	0.46	787	4.69	2.16	0.46	828	4.62	2.13	0.46	853	4.48	2.06	0.46	877
29	18	4.11	4.03	0.98	656	3.94	3.86	0.98	689	3.78	3.70	0.98	722	3.64	3.57	0.98	754
29	20	4.29	3.69	0.86	689	4.11	3.54	0.86	730	3.99	3.43	0.86	746	3.85	3.31	0.86	779
29	22	4.46	3.30	0.74	713	4.31	3.19	0.74	759	4.20	3.11	0.74	779	4.03	2.98	0.74	812
29	24	4.69	2.91	0.62	746	4.52	2.80	0.62	787	4.41	2.73	0.62	812	4.27	2.65	0.62	853
29	26	4.83	2.42	0.50	787	4.69	2.35	0.50	828	4.62	2.31	0.50	853	4.48	2.24	0.50	877
30	18	4.11	4.11	1.00	656	3.94	3.94	1.00	689	3.78	3.78	1.00	722	3.64	3.64	1.00	754
30	20	4.29	3.86	0.90	689	4.11	3.70	0.90	730	3.99	3.59	0.90	746	3.85	3.47	0.90	779
30	22	4.46	3.48	0.78	713	4.31	3.36	0.78	759	4.20	3.28	0.78	779	4.03	3.14	0.78	812
30	24	4.69	3.10	0.66	746	4.52	2.98	0.66	787	4.41	2.91	0.66	812	4.27	2.82	0.66	853
30	26	4.83	2.61	0.54	787	4.69	2.53	0.54	828	4.62	2.49	0.54	853	4.48	2.42	0.54	877
31	18	4.11	4.11	1.00	656	3.94	3.94	1.00	689	3.78	3.78	1.00	722	3.64	3.64	1.00	754
31	20	4.29	4.03	0.94	689	4.11	3.87	0.94	730	3.99	3.75	0.94	746	3.85	3.62	0.94	779
31	22	4.46	3.66	0.82	713	4.31	3.53	0.82	759	4.20	3.44	0.82	779	4.03	3.30	0.82	812
31	24	4.69	3.28	0.70	746	4.52	3.16	0.70	787	4.41	3.09	0.70	812	4.27	2.99	0.70	853
31	26	4.83	2.80	0.58	787	4.69	2.72	0.58	828	4.62	2.68	0.58	853	4.48	2.60	0.58	877
32	18	4.11	4.11	1.00	656	3.94	3.94	1.00	689	3.78	3.78	1.00	722	3.64	3.64	1.00	754
32	20	4.29	4.20	0.98	689	4.11	4.03	0.98	730	3.99	3.91	0.98	746	3.85	3.77	0.98	779
32	22	4.46	3.84	0.86	713	4.31	3.70	0.86	759	4.20	3.61	0.86	779	4.03	3.46	0.86	812
32	24	4.69	3.47	0.74	746	4.52	3.34	0.74	787	4.41	3.26	0.74	812	4.27	3.16	0.74	853
32	26	4.83	2.99	0.62	787	4.69	2.91	0.62	828	4.62	2.86	0.62	853	4.48	2.78	0.62	877

**NOTE** Q : Total capacity (kW) SHF : Sensible heat factor DB : Dry-bulb temperature  
 SHC : Sensible heat capacity (kW) INPUT : Total power input (W) WB : Wet-bulb temperature

**PERFORMANCE DATA COOL operation at Rated frequency**  
**MUZ-FH35VEHZ**

CAPACITY: 3.5 kW SHF: 0.84 INPUT: 820 W

INDOOR DB (°C)	INDOOR WB (°C)	OUTDOOR DB (°C)											
		35				40				46			
		Q	SHC	SHF	INPUT	Q	SHC	SHF	INPUT	Q	SHC	SHF	INPUT
21	18	3.43	2.26	0.66	804	3.15	2.08	0.66	853	2.91	1.92	0.66	886
21	20	3.61	1.95	0.54	836	3.36	1.81	0.54	877	3.12	1.68	0.54	927
22	18	3.43	2.40	0.70	804	3.15	2.21	0.70	853	2.91	2.03	0.70	886
22	20	3.61	2.09	0.58	836	3.36	1.95	0.58	877	3.12	1.81	0.58	927
22	22	3.82	1.75	0.46	869	3.57	1.64	0.46	918	3.33	1.53	0.46	951
23	18	3.43	2.54	0.74	804	3.15	2.33	0.74	853	2.91	2.15	0.74	886
23	20	3.61	2.24	0.62	836	3.36	2.08	0.62	877	3.12	1.93	0.62	927
23	22	3.82	1.91	0.50	869	3.57	1.79	0.50	918	3.33	1.66	0.50	951
24	18	3.43	2.68	0.78	804	3.15	2.46	0.78	853	2.91	2.27	0.78	886
24	20	3.61	2.38	0.66	836	3.36	2.22	0.66	877	3.12	2.06	0.66	927
24	22	3.82	2.06	0.54	869	3.57	1.93	0.54	918	3.33	1.80	0.54	951
24	24	4.03	1.69	0.42	902	3.78	1.59	0.42	943	3.57	1.50	0.42	984
25	18	3.43	2.81	0.82	804	3.15	2.58	0.82	853	2.91	2.38	0.82	886
25	20	3.61	2.52	0.70	836	3.36	2.35	0.70	877	3.12	2.18	0.70	927
25	22	3.82	2.21	0.58	869	3.57	2.07	0.58	918	3.33	1.93	0.58	951
25	24	4.03	1.85	0.46	902	3.78	1.74	0.46	943	3.57	1.64	0.46	984
26	18	3.43	2.95	0.86	804	3.15	2.71	0.86	853	2.91	2.50	0.86	886
26	20	3.61	2.67	0.74	836	3.36	2.49	0.74	877	3.12	2.31	0.74	927
26	22	3.82	2.37	0.62	869	3.57	2.21	0.62	918	3.33	2.06	0.62	951
26	24	4.03	2.01	0.50	902	3.78	1.89	0.50	943	3.57	1.79	0.50	984
26	26	4.24	1.61	0.38	935	3.99	1.52	0.38	976	3.75	1.42	0.38	1017
27	18	3.43	3.09	0.90	804	3.15	2.84	0.90	853	2.91	2.61	0.90	886
27	20	3.61	2.81	0.78	836	3.36	2.62	0.78	877	3.12	2.43	0.78	927
27	22	3.82	2.52	0.66	869	3.57	2.36	0.66	918	3.33	2.19	0.66	951
27	24	4.03	2.17	0.54	902	3.78	2.04	0.54	943	3.57	1.93	0.54	984
27	26	4.24	1.78	0.42	935	3.99	1.68	0.42	976	3.75	1.57	0.42	1017
28	18	3.43	3.22	0.94	804	3.15	2.96	0.94	853	2.91	2.73	0.94	886
28	20	3.61	2.96	0.82	836	3.36	2.76	0.82	877	3.12	2.55	0.82	927
28	22	3.82	2.67	0.70	869	3.57	2.50	0.70	918	3.33	2.33	0.70	951
28	24	4.03	2.33	0.58	902	3.78	2.19	0.58	943	3.57	2.07	0.58	984
28	26	4.24	1.95	0.46	935	3.99	1.84	0.46	976	3.75	1.72	0.46	1017
29	18	3.43	3.36	0.98	804	3.15	3.09	0.98	853	2.91	2.85	0.98	886
29	20	3.61	3.10	0.86	836	3.36	2.89	0.86	877	3.12	2.68	0.86	927
29	22	3.82	2.82	0.74	869	3.57	2.64	0.74	918	3.33	2.46	0.74	951
29	24	4.03	2.50	0.62	902	3.78	2.34	0.62	943	3.57	2.21	0.62	984
29	26	4.24	2.12	0.50	935	3.99	2.00	0.50	976	3.75	1.87	0.50	1017
30	18	3.43	3.43	1.00	804	3.15	3.15	1.00	853	2.91	2.91	1.00	886
30	20	3.61	3.24	0.90	836	3.36	3.02	0.90	877	3.12	2.80	0.90	927
30	22	3.82	2.98	0.78	869	3.57	2.78	0.78	918	3.33	2.59	0.78	951
30	24	4.03	2.66	0.66	902	3.78	2.49	0.66	943	3.57	2.36	0.66	984
30	26	4.24	2.29	0.54	935	3.99	2.15	0.54	976	3.75	2.02	0.54	1017
31	18	3.43	3.43	1.00	804	3.15	3.15	1.00	853	2.91	2.91	1.00	886
31	20	3.61	3.39	0.94	836	3.36	3.16	0.94	877	3.12	2.93	0.94	927
31	22	3.82	3.13	0.82	869	3.57	2.93	0.82	918	3.33	2.73	0.82	951
31	24	4.03	2.82	0.70	902	3.78	2.65	0.70	943	3.57	2.50	0.70	984
31	26	4.24	2.46	0.58	935	3.99	2.31	0.58	976	3.75	2.17	0.58	1017
32	18	3.43	3.43	1.00	804	3.15	3.15	1.00	853	2.91	2.91	1.00	886
32	20	3.61	3.53	0.98	836	3.36	3.29	0.98	877	3.12	3.05	0.98	927
32	22	3.82	3.28	0.86	869	3.57	3.07	0.86	918	3.33	2.86	0.86	951
32	24	4.03	2.98	0.74	902	3.78	2.80	0.74	943	3.57	2.64	0.74	984
32	26	4.24	2.63	0.62	935	3.99	2.47	0.62	976	3.75	2.32	0.62	1017

**NOTE** Q : Total capacity (kW) SHF : Sensible heat factor DB : Dry-bulb temperature  
 SHC : Sensible heat capacity (kW) INPUT : Total power input (W) WB : Wet-bulb temperature

**PERFORMANCE DATA COOL operation at Rated frequency**

**MUZ-FH50VEHZ**

CAPACITY: 5.0 kW

SHF: 0.73

INPUT: 1380 W

INDOOR DB (°C)	INDOOR WB (°C)	OUTDOOR DB (°C)															
		21				25				27				30			
		Q	SHC	SHF	INPUT	Q	SHC	SHF	INPUT	Q	SHC	SHF	INPUT	Q	SHC	SHF	INPUT
21	18	5.88	3.23	0.55	1104	5.63	3.09	0.55	1159	5.40	2.97	0.55	1214	5.20	2.86	0.55	1270
21	20	6.13	2.63	0.43	1159	5.88	2.53	0.43	1228	5.70	2.45	0.43	1256	5.50	2.37	0.43	1311
22	18	5.88	3.47	0.59	1104	5.63	3.32	0.59	1159	5.40	3.19	0.59	1214	5.20	3.07	0.59	1270
22	20	6.13	2.88	0.47	1159	5.88	2.76	0.47	1228	5.70	2.68	0.47	1256	5.50	2.59	0.47	1311
22	22	6.38	2.23	0.35	1201	6.15	2.15	0.35	1277	6.00	2.10	0.35	1311	5.75	2.01	0.35	1366
23	18	5.88	3.70	0.63	1104	5.63	3.54	0.63	1159	5.40	3.40	0.63	1214	5.20	3.28	0.63	1270
23	20	6.13	3.12	0.51	1159	5.88	3.00	0.51	1228	5.70	2.91	0.51	1256	5.50	2.81	0.51	1311
23	22	6.38	2.49	0.39	1201	6.15	2.40	0.39	1277	6.00	2.34	0.39	1311	5.75	2.24	0.39	1366
24	18	5.88	3.94	0.67	1104	5.63	3.77	0.67	1159	5.40	3.62	0.67	1214	5.20	3.48	0.67	1270
24	20	6.13	3.37	0.55	1159	5.88	3.23	0.55	1228	5.70	3.14	0.55	1256	5.50	3.03	0.55	1311
24	22	6.38	2.74	0.43	1201	6.15	2.64	0.43	1277	6.00	2.58	0.43	1311	5.75	2.47	0.43	1366
24	24	6.70	2.08	0.31	1256	6.45	2.00	0.31	1325	6.30	1.95	0.31	1366	6.10	1.89	0.31	1435
25	18	5.88	4.17	0.71	1104	5.63	3.99	0.71	1159	5.40	3.83	0.71	1214	5.20	3.69	0.71	1270
25	20	6.13	3.61	0.59	1159	5.88	3.47	0.59	1228	5.70	3.36	0.59	1256	5.50	3.25	0.59	1311
25	22	6.38	3.00	0.47	1201	6.15	2.89	0.47	1277	6.00	2.82	0.47	1311	5.75	2.70	0.47	1366
25	24	6.70	2.35	0.35	1256	6.45	2.26	0.35	1325	6.30	2.21	0.35	1366	6.10	2.14	0.35	1435
26	18	5.88	4.41	0.75	1104	5.63	4.22	0.75	1159	5.40	4.05	0.75	1214	5.20	3.90	0.75	1270
26	20	6.13	3.86	0.63	1159	5.88	3.70	0.63	1228	5.70	3.59	0.63	1256	5.50	3.47	0.63	1311
26	22	6.38	3.25	0.51	1201	6.15	3.14	0.51	1277	6.00	3.06	0.51	1311	5.75	2.93	0.51	1366
26	24	6.70	2.61	0.39	1256	6.45	2.52	0.39	1325	6.30	2.46	0.39	1366	6.10	2.38	0.39	1435
26	26	6.90	1.86	0.27	1325	6.70	1.81	0.27	1394	6.60	1.78	0.27	1435	6.40	1.73	0.27	1477
27	18	5.88	4.64	0.79	1104	5.63	4.44	0.79	1159	5.40	4.27	0.79	1214	5.20	4.11	0.79	1270
27	20	6.13	4.10	0.67	1159	5.88	3.94	0.67	1228	5.70	3.82	0.67	1256	5.50	3.69	0.67	1311
27	22	6.38	3.51	0.55	1201	6.15	3.38	0.55	1277	6.00	3.30	0.55	1311	5.75	3.16	0.55	1366
27	24	6.70	2.88	0.43	1256	6.45	2.77	0.43	1325	6.30	2.71	0.43	1366	6.10	2.62	0.43	1435
27	26	6.90	2.14	0.31	1325	6.70	2.08	0.31	1394	6.60	2.05	0.31	1435	6.40	1.98	0.31	1477
28	18	5.88	4.88	0.83	1104	5.63	4.67	0.83	1159	5.40	4.48	0.83	1214	5.20	4.32	0.83	1270
28	20	6.13	4.35	0.71	1159	5.88	4.17	0.71	1228	5.70	4.05	0.71	1256	5.50	3.91	0.71	1311
28	22	6.38	3.76	0.59	1201	6.15	3.63	0.59	1277	6.00	3.54	0.59	1311	5.75	3.39	0.59	1366
28	24	6.70	3.15	0.47	1256	6.45	3.03	0.47	1325	6.30	2.96	0.47	1366	6.10	2.87	0.47	1435
28	26	6.90	2.42	0.35	1325	6.70	2.35	0.35	1394	6.60	2.31	0.35	1435	6.40	2.24	0.35	1477
29	18	5.88	5.11	0.87	1104	5.63	4.89	0.87	1159	5.40	4.70	0.87	1214	5.20	4.52	0.87	1270
29	20	6.13	4.59	0.75	1159	5.88	4.41	0.75	1228	5.70	4.28	0.75	1256	5.50	4.13	0.75	1311
29	22	6.38	4.02	0.63	1201	6.15	3.87	0.63	1277	6.00	3.78	0.63	1311	5.75	3.62	0.63	1366
29	24	6.70	3.42	0.51	1256	6.45	3.29	0.51	1325	6.30	3.21	0.51	1366	6.10	3.11	0.51	1435
29	26	6.90	2.69	0.39	1325	6.70	2.61	0.39	1394	6.60	2.57	0.39	1435	6.40	2.50	0.39	1477
30	18	5.88	5.35	0.91	1104	5.63	5.12	0.91	1159	5.40	4.91	0.91	1214	5.20	4.73	0.91	1270
30	20	6.13	4.84	0.79	1159	5.88	4.64	0.79	1228	5.70	4.50	0.79	1256	5.50	4.35	0.79	1311
30	22	6.38	4.27	0.67	1201	6.15	4.12	0.67	1277	6.00	4.02	0.67	1311	5.75	3.85	0.67	1366
30	24	6.70	3.69	0.55	1256	6.45	3.55	0.55	1325	6.30	3.47	0.55	1366	6.10	3.36	0.55	1435
30	26	6.90	2.97	0.43	1325	6.70	2.88	0.43	1394	6.60	2.84	0.43	1435	6.40	2.75	0.43	1477
31	18	5.88	5.58	0.95	1104	5.63	5.34	0.95	1159	5.40	5.13	0.95	1214	5.20	4.94	0.95	1270
31	20	6.13	5.08	0.83	1159	5.88	4.88	0.83	1228	5.70	4.73	0.83	1256	5.50	4.57	0.83	1311
31	22	6.38	4.53	0.71	1201	6.15	4.37	0.71	1277	6.00	4.26	0.71	1311	5.75	4.08	0.71	1366
31	24	6.70	3.95	0.59	1256	6.45	3.81	0.59	1325	6.30	3.72	0.59	1366	6.10	3.60	0.59	1435
31	26	6.90	3.24	0.47	1325	6.70	3.15	0.47	1394	6.60	3.10	0.47	1435	6.40	3.01	0.47	1477
32	18	5.88	5.82	0.99	1104	5.63	5.57	0.99	1159	5.40	5.35	0.99	1214	5.20	5.15	0.99	1270
32	20	6.13	5.33	0.87	1159	5.88	5.11	0.87	1228	5.70	4.96	0.87	1256	5.50	4.79	0.87	1311
32	22	6.38	4.78	0.75	1201	6.15	4.61	0.75	1277	6.00	4.50	0.75	1311	5.75	4.31	0.75	1366
32	24	6.70	4.22	0.63	1256	6.45	4.06	0.63	1325	6.30	3.97	0.63	1366	6.10	3.84	0.63	1435
32	26	6.90	3.52	0.51	1325	6.70	3.42	0.51	1394	6.60	3.37	0.51	1435	6.40	3.26	0.51	1477

**NOTE** Q : Total capacity (kW) SHF : Sensible heat factor DB : Dry-bulb temperature  
 SHC : Sensible heat capacity (kW) INPUT : Total power input (W) WB : Wet-bulb temperature

**PERFORMANCE DATA COOL operation at Rated frequency**

**MUZ-FH50VEHZ**

CAPACITY: 5.0 kW

SHF: 0.73

INPUT: 1380 W

INDOOR DB (°C)	INDOOR WB (°C)	OUTDOOR DB (°C)											
		35				40				46			
		Q	SHC	SHF	INPUT	Q	SHC	SHF	INPUT	Q	SHC	SHF	INPUT
21	18	4.90	2.70	0.55	1352	4.50	2.48	0.55	1435	4.15	2.28	0.55	1490
21	20	5.15	2.21	0.43	1408	4.80	2.06	0.43	1477	4.45	1.91	0.43	1559
22	18	4.90	2.89	0.59	1352	4.50	2.66	0.59	1435	4.15	2.45	0.59	1490
22	20	5.15	2.42	0.47	1408	4.80	2.26	0.47	1477	4.45	2.09	0.47	1559
22	22	5.45	1.91	0.35	1463	5.10	1.79	0.35	1546	4.75	1.66	0.35	1601
23	18	4.90	3.09	0.63	1352	4.50	2.84	0.63	1435	4.15	2.61	0.63	1490
23	20	5.15	2.63	0.51	1408	4.80	2.45	0.51	1477	4.45	2.27	0.51	1559
23	22	5.45	2.13	0.39	1463	5.10	1.99	0.39	1546	4.75	1.85	0.39	1601
24	18	4.90	3.28	0.67	1352	4.50	3.02	0.67	1435	4.15	2.78	0.67	1490
24	20	5.15	2.83	0.55	1408	4.80	2.64	0.55	1477	4.45	2.45	0.55	1559
24	22	5.45	2.34	0.43	1463	5.10	2.19	0.43	1546	4.75	2.04	0.43	1601
24	24	5.75	1.78	0.31	1518	5.40	1.67	0.31	1587	5.10	1.58	0.31	1656
25	18	4.90	3.48	0.71	1352	4.50	3.20	0.71	1435	4.15	2.95	0.71	1490
25	20	5.15	3.04	0.59	1408	4.80	2.83	0.59	1477	4.45	2.63	0.59	1559
25	22	5.45	2.56	0.47	1463	5.10	2.40	0.47	1546	4.75	2.23	0.47	1601
25	24	5.75	2.01	0.35	1518	5.40	1.89	0.35	1587	5.10	1.79	0.35	1656
26	18	4.90	3.68	0.75	1352	4.50	3.38	0.75	1435	4.15	3.11	0.75	1490
26	20	5.15	3.24	0.63	1408	4.80	3.02	0.63	1477	4.45	2.80	0.63	1559
26	22	5.45	2.78	0.51	1463	5.10	2.60	0.51	1546	4.75	2.42	0.51	1601
26	24	5.75	2.24	0.39	1518	5.40	2.11	0.39	1587	5.10	1.99	0.39	1656
26	26	6.05	1.63	0.27	1573	5.70	1.54	0.27	1642	5.35	1.44	0.27	1711
27	18	4.90	3.87	0.79	1352	4.50	3.56	0.79	1435	4.15	3.28	0.79	1490
27	20	5.15	3.45	0.67	1408	4.80	3.22	0.67	1477	4.45	2.98	0.67	1559
27	22	5.45	3.00	0.55	1463	5.10	2.81	0.55	1546	4.75	2.61	0.55	1601
27	24	5.75	2.47	0.43	1518	5.40	2.32	0.43	1587	5.10	2.19	0.43	1656
27	26	6.05	1.88	0.31	1573	5.70	1.77	0.31	1642	5.35	1.66	0.31	1711
28	18	4.90	4.07	0.83	1352	4.50	3.74	0.83	1435	4.15	3.44	0.83	1490
28	20	5.15	3.66	0.71	1408	4.80	3.41	0.71	1477	4.45	3.16	0.71	1559
28	22	5.45	3.22	0.59	1463	5.10	3.01	0.59	1546	4.75	2.80	0.59	1601
28	24	5.75	2.70	0.47	1518	5.40	2.54	0.47	1587	5.10	2.40	0.47	1656
28	26	6.05	2.12	0.35	1573	5.70	2.00	0.35	1642	5.35	1.87	0.35	1711
29	18	4.90	4.26	0.87	1352	4.50	3.92	0.87	1435	4.15	3.61	0.87	1490
29	20	5.15	3.86	0.75	1408	4.80	3.60	0.75	1477	4.45	3.34	0.75	1559
29	22	5.45	3.43	0.63	1463	5.10	3.21	0.63	1546	4.75	2.99	0.63	1601
29	24	5.75	2.93	0.51	1518	5.40	2.75	0.51	1587	5.10	2.60	0.51	1656
29	26	6.05	2.36	0.39	1573	5.70	2.22	0.39	1642	5.35	2.09	0.39	1711
30	18	4.90	4.46	0.91	1352	4.50	4.10	0.91	1435	4.15	3.78	0.91	1490
30	20	5.15	4.07	0.79	1408	4.80	3.79	0.79	1477	4.45	3.52	0.79	1559
30	22	5.45	3.65	0.67	1463	5.10	3.42	0.67	1546	4.75	3.18	0.67	1601
30	24	5.75	3.16	0.55	1518	5.40	2.97	0.55	1587	5.10	2.81	0.55	1656
30	26	6.05	2.60	0.43	1573	5.70	2.45	0.43	1642	5.35	2.30	0.43	1711
31	18	4.90	4.66	0.95	1352	4.50	4.28	0.95	1435	4.15	3.94	0.95	1490
31	20	5.15	4.27	0.83	1408	4.80	3.98	0.83	1477	4.45	3.69	0.83	1559
31	22	5.45	3.87	0.71	1463	5.10	3.62	0.71	1546	4.75	3.37	0.71	1601
31	24	5.75	3.39	0.59	1518	5.40	3.19	0.59	1587	5.10	3.01	0.59	1656
31	26	6.05	2.84	0.47	1573	5.70	2.68	0.47	1642	5.35	2.51	0.47	1711
32	18	4.90	4.85	0.99	1352	4.50	4.46	0.99	1435	4.15	4.11	0.99	1490
32	20	5.15	4.48	0.87	1408	4.80	4.18	0.87	1477	4.45	3.87	0.87	1559
32	22	5.45	4.09	0.75	1463	5.10	3.83	0.75	1546	4.75	3.56	0.75	1601
32	24	5.75	3.62	0.63	1518	5.40	3.40	0.63	1587	5.10	3.21	0.63	1656
32	26	6.05	3.09	0.51	1573	5.70	2.91	0.51	1642	5.35	2.73	0.51	1711

**NOTE** Q : Total capacity (kW) SHF : Sensible heat factor DB : Dry-bulb temperature  
 SHC : Sensible heat capacity (kW) INPUT : Total power input (W) WB : Wet-bulb temperature

**PERFORMANCE DATA HEAT operation at Rated frequency  
MUZ-FH25VEHZ**

CAPACITY: 3.2 kW INPUT: 580 W

INDOOR DB (°C)	OUTDOOR WB (°C)													
	-10		-5		0		5		10		15		20	
	Q	INPUT	Q	INPUT	Q	INPUT	Q	INPUT	Q	INPUT	Q	INPUT	Q	INPUT
15	2.02	377	2.43	452	2.85	510	3.26	551	3.68	586	4.06	603	4.48	615
21	1.92	406	2.30	481	2.72	534	3.10	574	3.52	603	3.90	621	4.30	644
26	1.73	435	2.14	510	2.53	563	2.94	603	3.36	632	3.74	650	4.16	667

**MUZ-FH35VEHZ**

CAPACITY: 4.0 kW INPUT: 800 W

INDOOR DB (°C)	OUTDOOR WB (°C)													
	-10		-5		0		5		10		15		20	
	Q	INPUT	Q	INPUT	Q	INPUT	Q	INPUT	Q	INPUT	Q	INPUT	Q	INPUT
15	2.52	520	3.04	624	3.56	704	4.08	760	4.60	808	5.08	832	5.60	848
21	2.40	560	2.88	664	3.40	736	3.88	792	4.40	832	4.88	856	5.38	888
26	2.16	600	2.68	704	3.16	776	3.68	832	4.20	872	4.68	896	5.20	920

**MUZ-FH50VEHZ**

CAPACITY: 6.0 kW INPUT: 1480 W

INDOOR DB (°C)	OUTDOOR WB (°C)													
	-10		-5		0		5		10		15		20	
	Q	INPUT	Q	INPUT	Q	INPUT	Q	INPUT	Q	INPUT	Q	INPUT	Q	INPUT
15	3.78	962	4.56	1154	5.34	1302	6.12	1406	6.90	1495	7.62	1539	8.40	1569
21	3.60	1036	4.32	1228	5.10	1362	5.82	1465	6.60	1539	7.32	1584	8.07	1643
26	3.24	1110	4.02	1302	4.74	1436	5.52	1539	6.30	1613	7.02	1658	7.80	1702

**NOTE:** Q: Total capacity (kW) INPUT : Total power input (W) DB: Dry-bulb temperature WB: Wet-bulb temperature

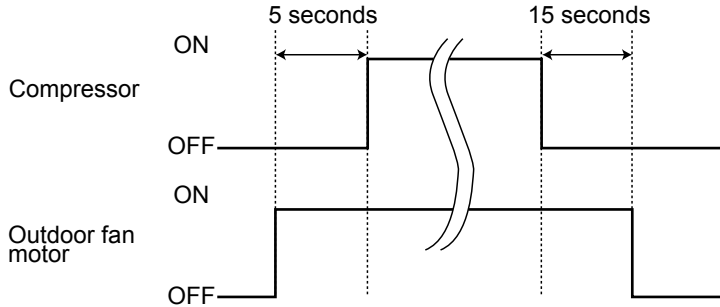
**MUZ-FH25VEHZ  
MUZ-FH35VEHZ  
MUZ-FH50VEHZ**

**9-1. OUTDOOR FAN MOTOR CONTROL**

The fan motor turns ON/OFF, interlocking with the compressor.

[ON] The fan motor turns ON 5 seconds before the compressor starts up.

[OFF] The fan motor turns OFF 15 seconds after the compressor has stopped running.



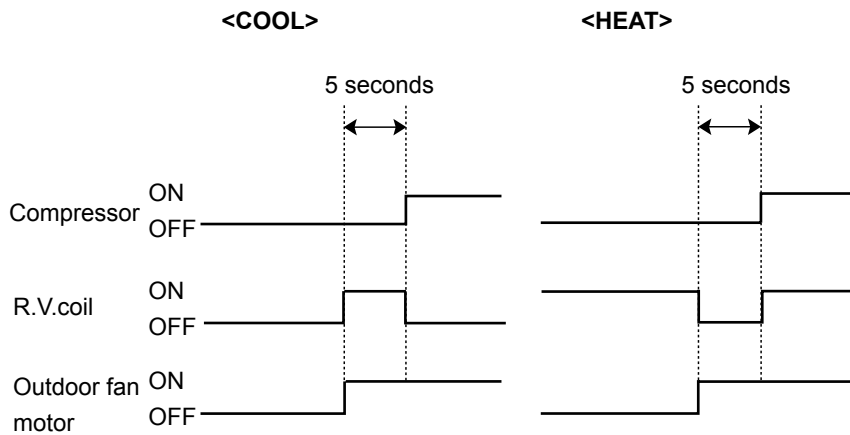
**9-2. R.V. COIL CONTROL**

Heating . . . . . ON

Cooling . . . . . OFF

Dry . . . . . OFF

**NOTE:** The 4-way valve reverses for 5 seconds right before start-up of the compressor.



**9-3. RELATION BETWEEN MAIN SENSOR AND ACTUATOR**

Sensor	Purpose	Actuator					
		Compressor	LEV	Outdoor fan motor	R.V.coil	Indoor fan motor	Defrost heater
Discharge temperature thermistor	Protection	○	○				
Indoor coil temperature thermistor	Cooling: Coil frost prevention	○					
	Heating: High pressure protection	○	○				
Defrost thermistor	Heating: Defrosting	○	○	○	○	○	
Fin temperature thermistor	Protection	○		○			
Ambient temperature thermistor	Cooling: Low ambient temperature operation	○	○	○			
	Heating: Defrosting (Heater)						○
Outdoor heat exchanger temperature thermistor	Cooling: Low ambient temperature operation	○	○	○			
	Cooling: High pressure protection	○	○	○			



**MUZ-FH25VEHZ****MUZ-FH35VEHZ****MUZ-FH50VEHZ****10-1. CHANGE IN DEFROST SETTING****Changing defrost finish temperature**

<JS> To change the defrost finish temperature, cut/solder the JS wire of the outdoor inverter P.C. board.  
(Refer to 11-6-1.)

Jumper wire		Defrost finish temperature (°C)	
		MUZ-FH25/35VEHZ	MUZ-FH50VEHZ
JS	Soldered (Initial setting)	8	10
	None (Cut)	15	18

**10-2. PRE-HEAT CONTROL SETTING****PRE-HEAT CONTROL****MUZ-FH25/35**

When moisture gets into the refrigerant cycle, it may interfere the start-up of the compressor at low discharge temperature. The pre-heat control prevents this interference. The pre-heat control turns ON when the discharge temperature is 20°C or below. When the pre-heat control turns ON, the compressor is energized. (About 50 W)

**MUZ-FH50**

Prolonged low load operation, in which the thermostat is OFF for a long time, at low outside temperature (0°C or less) may cause the following troubles. To prevent those troubles, activate the pre-heat control.

- 1) If moisture gets into the refrigerant cycle and freezes, it may interfere the start-up of the compressor.
- 2) If liquid refrigerant collects in the compressor, a failure in the compressor may occur.

The pre-heat control turns ON when the compressor temperature is 20°C or below. When the pre-heat control turns ON, the compressor is energized. (About 70 W)

**Pre-heat control setting**

<JK>

ON: To activate the pre-heat control, cut JK wire of the inverter P.C. board.

OFF: To deactivate the pre-heat control, solder JK wire of the inverter P.C. board.

(Refer to 11-6.1)

**NOTE:** When the inverter P.C. board is replaced, check JK wire, and cut/solder it if necessary.

**MUZ-FH25VEHZ**  
**MUZ-FH35VEHZ**  
**MUZ-FH50VEHZ**

**11-1. CAUTIONS ON TROUBLESHOOTING**

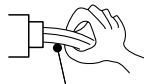
**1. Before troubleshooting, check the following**

- 1) Check the power supply voltage.
- 2) Check the indoor/outdoor connecting wire for miswiring.

**2. Take care of the following during servicing**

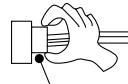
- 1) Before servicing the air conditioner, be sure to turn OFF the main unit first with the remote controller, and then after confirming the horizontal vane is closed, turn OFF the breaker and/or disconnect the power plug.
- 2) Be sure to turn OFF the power supply before removing the front panel, the cabinet, the top panel, and the electronic control P.C. board.
- 3) When removing the electrical parts, be careful of the residual voltage of smoothing capacitor.
- 4) When removing the electronic control P.C. board, hold the edge of the board with care NOT to apply stress on the components.
- 5) When connecting or disconnecting the connectors, hold the housing of the connector. DO NOT pull the lead wires.

<Incorrect>



**Lead wiring**

<Correct>



**Housing point**

**3. Troubleshooting procedure**

- 1) Check if the OPERATION INDICATOR lamp on the indoor unit is flashing on and off to indicate an abnormality.  
To make sure, check how many times the OPERATION INDICATOR lamp is flashing on and off before starting service work.
- 2) Before servicing, check that the connector and terminal are connected properly.
- 3) When the electronic control P.C. board seems to be defective, check the copper foil pattern for disconnection and the components for bursting and discoloration.
- 4) Refer to 11-2 and 11-3.

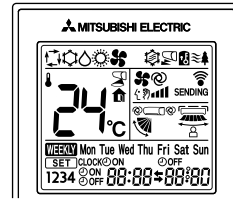
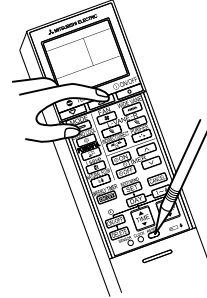
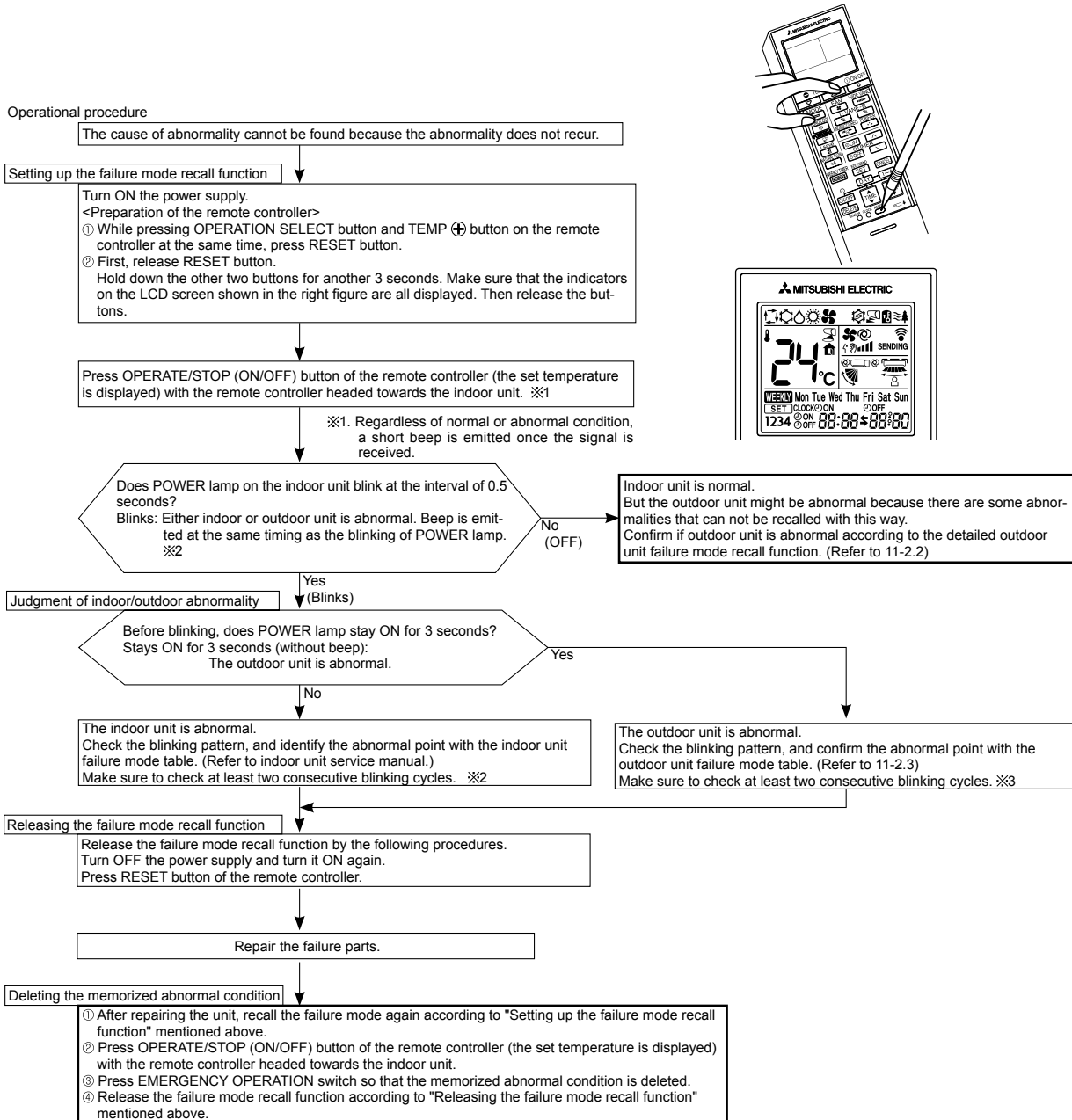
## 11-2. FAILURE MODE RECALL FUNCTION

Outline of the function

This air conditioner can memorize the abnormal condition which has occurred once.

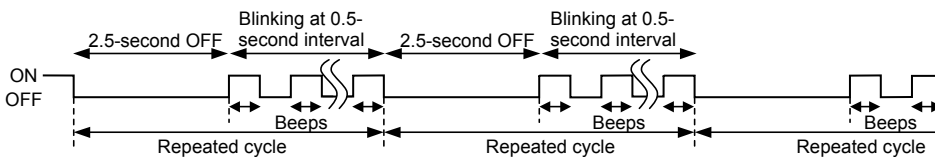
Even though LED indication listed on the troubleshooting check table (11-3.) disappears, the memorized failure details can be recalled.

### 1. Flow chart of failure mode recall function for the indoor/outdoor unit

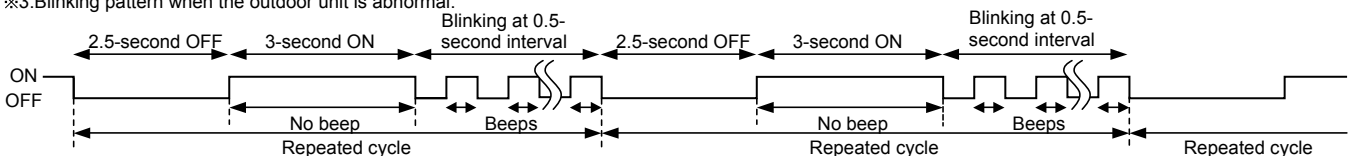


**NOTE:** 1. Make sure to release the failure mode recall function after it is set up, otherwise the unit cannot operate properly.  
2. If the abnormal condition is not deleted from the memory, the last abnormal condition is kept memorized.

※2. Blinking pattern when the indoor unit is abnormal:

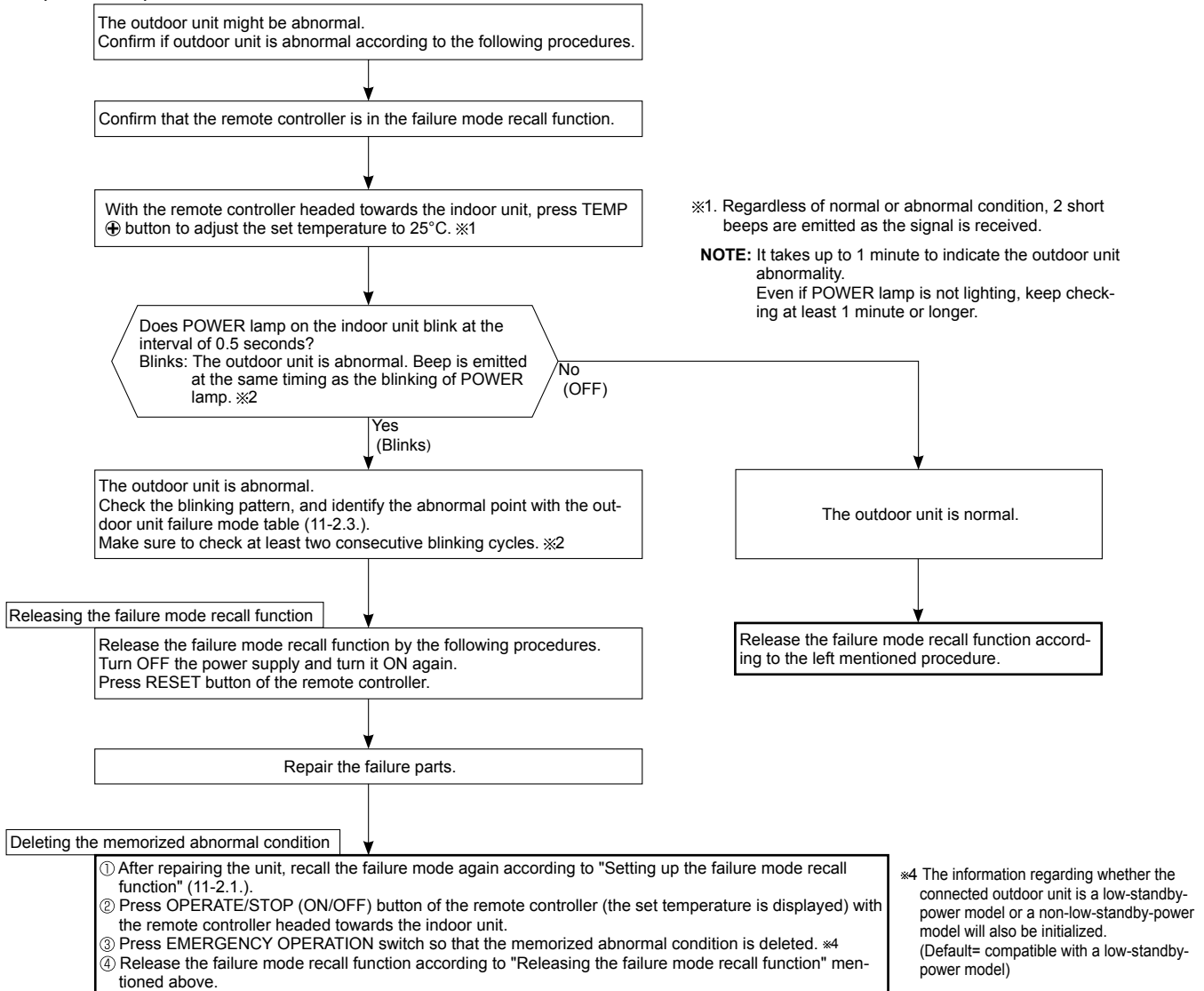


※3. Blinking pattern when the outdoor unit is abnormal:



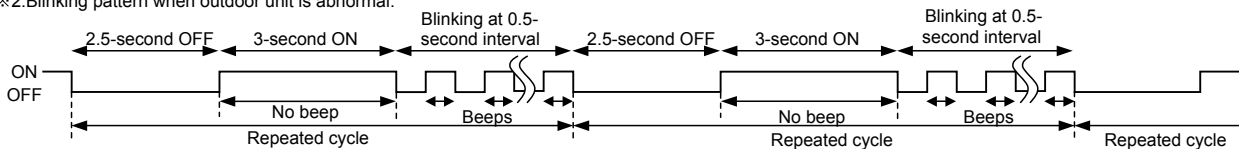
## 2. Flow chart of the detailed outdoor unit failure mode recall function

### Operational procedure



**NOTE:** 1. Make sure to release the failure mode recall function after it is set up, otherwise the unit cannot operate properly.  
2. If the abnormal condition is not deleted from the memory, the last abnormal condition is kept memorized.

※2. Blinking pattern when outdoor unit is abnormal:



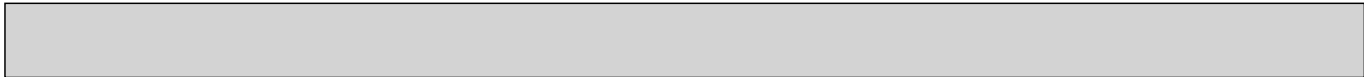
### 3. Outdoor unit failure mode table

POWER lamp (Indoor unit)	Abnormal point (Failure mode/protection)	LED indication (Outdoor P.C. board)	Condition	Remedy	Indoor/outdoor unit failure mode recall function	Outdoor unit failure mode recall function
OFF	None (Normal)	—	—	—	—	—
1-time flash 2.5 seconds OFF	Indoor/outdoor communication, receiving error	—	Any signals from the inverter P.C. board cannot be received normally for 3 minutes.	•Refer to 11-5. ㉓ How to check miswiring and serial signal error.	○	○
	Indoor/outdoor communication, receiving error	—	Although the inverter P.C. board sends signal "0", signal "1" has been received 30 consecutive times.	•Refer to 11-5. ㉓ How to check miswiring and serial signal error.		
2-time flash 2.5 seconds OFF	Outdoor power system	—	Overcurrent protection cut-out operates 3 consecutive times within 1 minute after the compressor gets started.	•Reconnect connectors. •Refer to 11-5. ㉓ How to check inverter/compressor". •Check stop valve.	○	○
3-time flash 2.5 seconds OFF	Discharge temperature thermistor	1-time flash every 2.5 seconds	Thermistor shorts or opens during compressor running.	•Refer to 11-5. ㉓ "Check of outdoor thermistors". Defective outdoor thermistors can be identified by checking the blinking pattern of LED.	○	○
	Defrost thermistor					
	Fin temperature thermistor	3-time flash 2.5 seconds OFF				
	P.C. board temperature thermistor	4-time flash 2.5 seconds OFF				
	Ambient temperature thermistor	2-time flash 2.5 seconds OFF				
Outdoor heat exchanger temperature thermistor	—					
4-time flash 2.5 seconds OFF	Overcurrent	11-time flash 2.5 seconds OFF	Large current flows into power module (IC700) (FH25/35)/ IGBT module (IC700) (FH50).	•Reconnect compressor connector. •Refer to 11-5. ㉓ How to check inverter/compressor". •Check stop valve.	—	○
	Compressor synchronous abnormality (Compressor start-up failure protection)	12-time flash 2.5 seconds OFF	Waveform of compressor current is distorted.	•Reconnect compressor connector. •Refer to 11-5. ㉓ How to check inverter/compressor".	—	○
5-time flash 2.5 seconds OFF	Discharge temperature	—	Temperature of discharge temperature thermistor exceeds 116°C, compressor stops. Compressor can restart if discharge temperature thermistor reads 100°C or less 3 minutes later.	•Check refrigerant circuit and refrigerant amount. •Refer to 11-5. ㉓ Check of LEV".	—	○
6-time flash 2.5 seconds OFF	High pressure	—	Temperature indoor coil thermistor exceeds 70°C in HEAT mode. Temperature defrost thermistor exceeds 70°C in COOL mode.	•Check refrigerant circuit and refrigerant amount. •Check stop valve.	—	○
7-time flash 2.5 seconds OFF	Fin temperature/ P.C. board temperature	7-time flash 2.5 seconds OFF	Temperature of the fin temperature thermistor on the inverter P.C. board exceeds 75 ~ 86°C (FH25/35)/75 ~ 80°C (FH50), or temperature of P.C. board temperature thermistor on the inverter P.C. board exceeds 72 ~ 85°C (FH25/35)/70 ~ 75°C (FH50).	•Check around outdoor unit. •Check outdoor unit air passage. •Refer to 11-5. ㉓ Check of outdoor fan motor".	—	○
8-time flash 2.5 seconds OFF	Outdoor fan motor	—	Outdoor fan has stopped 3 times in a row within 30 seconds after outdoor fan start-up.	•Refer to 11-5. ㉓ Check of outdoor fan motor". Refer to 11-5. ㉓ Check of inverter P.C. board".	—	○
9-time flash 2.5 seconds OFF	Nonvolatile memory data	5-time flash 2.5 seconds OFF	Nonvolatile memory data cannot be read properly.	•Replace the inverter P.C. board.	○	○
	Power module (IC700) (FH25/35) IGBT module (IC700) (FH50)	6-time flash 2.5 seconds OFF	The interface short circuit occurs in the output of the power module (IC700) (FH25/35)/IGBT module (IC700) (FH50). The compressor winding shorts circuit.	•Refer to 11-5. ㉓ How to check inverter/compressor".		
10-time flash 2.5 seconds OFF	Discharge temperature	—	Temperature of discharge temperature thermistor has been 50°C or less for 20 minutes.	•Refer to 11-5. ㉓ Check of LEV". •Check refrigerant circuit and refrigerant amount.	—	○
11-time flash 2.5 seconds OFF	Bus-bar voltage (DC)	8-time flash 2.5 seconds OFF	Bus-bar voltage of inverter cannot be detected normally.	•Refer to 11-5. ㉓ How to check inverter/compressor".	—	○
	Each phase current of compressor	9-time flash 2.5 seconds OFF	Each phase current of compressor cannot be detected normally.			
14-time flash 2.5 seconds OFF	Stop valve (Closed valve)	14-time flash 2.5 seconds OFF	Closed valve is detected by compressor current.	•Check stop valve.	○	○

**NOTE:** Blinking patterns of this mode differ from the ones of TROUBLESHOOTING CHECK TABLE (11-3.).

### 11-3. TROUBLESHOOTING CHECK TABLE

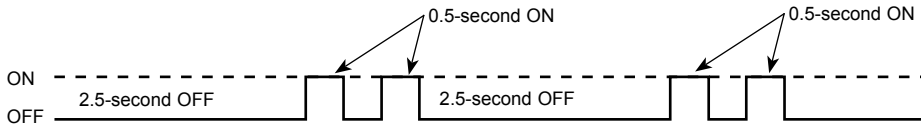
No.	Symptom	LED indication	Abnormal point/ Condition	Condition		Remedy
1	Outdoor unit does not operate.	1-time flash every 2.5 seconds	Outdoor power system	Overcurrent protection cut-out operates 3 consecutive times within 1 minute after the compressor gets started.		<ul style="list-style-type: none"> <li>•Reconnect connector of compressor.</li> <li>•Refer to 11-5.Ⓐ "How to check inverter/compressor".</li> <li>•Check stop valve.</li> </ul>
2			Outdoor thermistors	Discharge temperature thermistor, fin temperature thermistor, defrost thermistor, P.C. board temperature thermistor, outdoor heat exchanger temperature thermistor or ambient temperature thermistor shorts or opens during compressor running.		<ul style="list-style-type: none"> <li>•Refer to 11-5.Ⓒ "Check of outdoor thermistors".</li> </ul>
3			Outdoor control system	Nonvolatile memory data cannot be read properly. (POWER lamp of the indoor unit lights up or flashes 7-time.)		<ul style="list-style-type: none"> <li>•Replace inverter P.C. board.</li> </ul>
4		6-time flash 2.5 seconds OFF	Serial signal	The communication fails between the indoor and outdoor unit for 3 minutes.		<ul style="list-style-type: none"> <li>•Check connection between the inverter P.C. board and the relay P.C. board. (FH50)</li> <li>•Refer to 11-5.Ⓜ "How to check miswiring and serial signal error.</li> </ul>
5		11-time flash 2.5 seconds OFF	Stop valve/ Closed valve	Closed valve is detected by compressor current.		<ul style="list-style-type: none"> <li>•Check stop valve.</li> </ul>
6		14-time flash 2.5 seconds OFF	Outdoor unit (Other abnormality)	Outdoor unit is defective.		<ul style="list-style-type: none"> <li>•Refer to 11-2.2. "Flow chart of the detailed outdoor unit failure mode recall function".</li> </ul>
7	'Outdoor unit stops and restarts 3 minutes later' is repeated.	2-time flash 2.5 seconds OFF	Overcurrent protection	Large current flows into power module (IC700) (FH25/35)/ IGBT module (IC700) (FH50).		<ul style="list-style-type: none"> <li>•Reconnect connector of compressor.</li> <li>•Refer to 11-5.Ⓐ "How to check inverter/compressor".</li> <li>•Check stop valve.</li> </ul>
8		3-time flash 2.5 seconds OFF	Discharge temperature overheat protection	Temperature of discharge temperature thermistor exceeds 116°C, compressor stops. Compressor can restart if discharge temperature thermistor reads 100°C or less 3 minutes later.		<ul style="list-style-type: none"> <li>•Check refrigerant circuit and refrigerant amount.</li> <li>•Refer to 11-5.Ⓚ "Check of LEV".</li> </ul>
9		4-time flash 2.5 seconds OFF	Fin temperature /P.C. board temperature thermistor overheat protection	Temperature of the fin temperature thermistor on the heat sink exceeds 75 ~ 86°C (FH25/35)/75 ~ 80°C (FH50) or temperature of P.C. board temperature thermistor on the inverter P.C. board exceeds 72 ~ 85°C (FH25/35)/70 ~ 75°C (FH50).		<ul style="list-style-type: none"> <li>•Check around outdoor unit.</li> <li>•Check outdoor unit air passage.</li> <li>•Refer to 11-5.Ⓛ "Check of outdoor fan motor".</li> </ul>
10		5-time flash 2.5 seconds OFF	High pressure protection	Indoor coil thermistor exceeds 70°C in HEAT mode. Defrost thermistor exceeds 70°C in COOL mode.		<ul style="list-style-type: none"> <li>•Check refrigerant circuit and refrigerant amount.</li> <li>•Check stop valve.</li> </ul>
11		8-time flash 2.5 seconds OFF	Compressor synchronous abnormality	The waveform of compressor current is distorted.		<ul style="list-style-type: none"> <li>•Reconnect connector of compressor.</li> <li>•Refer to 11-5.Ⓐ "How to check inverter/compressor".</li> </ul>
12		10-time flash 2.5 seconds OFF	Outdoor fan motor	Outdoor fan has stopped 3 times in a row within 30 seconds after outdoor fan start-up.		<ul style="list-style-type: none"> <li>•Refer to 11-5.Ⓛ "Check of outdoor fan motor.</li> <li>•Refer to 11-5.Ⓛ "Check of inverter P.C. board.</li> </ul>
13		12-time flash 2.5 seconds OFF	Each phase current of compressor	Each phase current of compressor cannot be detected normally.		<ul style="list-style-type: none"> <li>•Refer to 11-5.Ⓐ "How to check inverter/compressor".</li> </ul>
14		13-time flash 2.5 seconds OFF	Bus-bar voltage (DC)	Bus-bar voltage of inverter cannot be detected normally.		<ul style="list-style-type: none"> <li>•It occurs with following case. Instantaneous power voltage drop. (Short time power failure) (FH50)</li> <li>•Refer to 11-5.Ⓞ "Check of power supply". (FH50)</li> <li>•Refer to 11-5.Ⓐ "How to check inverter/compressor".</li> </ul>
15	Outdoor unit operates.	1-time flash 2.5 seconds OFF	Frequency drop by current protection	FH25/35	When the input current exceeds approximately 10A (FH25)/10.5A (FH35), compressor frequency lowers.	<ul style="list-style-type: none"> <li>•The unit is normal, but check the following.</li> <li>•Check if indoor filters are clogged.</li> <li>•Check if refrigerant is short.</li> <li>•Check if indoor/outdoor unit air circulation is short cycled.</li> </ul>
16				FH50	Current from power outlet is nearing breaker capacity.	
16	3-time flash 2.5 seconds OFF	Frequency drop by high pressure protection	Temperature of indoor coil thermistor exceeds 55°C in HEAT mode, compressor frequency lowers.			
			Frequency drop by defrosting in COOL mode	Indoor coil thermistor reads 8°C or less in COOL mode, compressor frequency lowers.		
17	4-time flash 2.5 seconds OFF	Frequency drop by discharge temperature protection	Temperature of discharge temperature thermistor exceeds 111°C, compressor frequency lowers.		<ul style="list-style-type: none"> <li>•Check refrigerant circuit and refrigerant amount.</li> <li>•Refer to 11-5.Ⓚ "Check of LEV".</li> <li>•Refer to 11-5.Ⓒ "Check of outdoor thermistors".</li> </ul>	
18	MUZ-FH25/35 5-time flash 2.5 seconds OFF	Outside temperature thermistor protection	When the outside temperature thermistor shorts or opens, protective operation without that thermistor is performed.		<ul style="list-style-type: none"> <li>•Refer to 11-5. Ⓒ Check of outdoor thermistors.</li> </ul>	



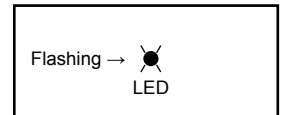
No.	Symptom	LED indication	Abnormal point/Condition	Condition	Remedy
19	Outdoor unit operates.	7-time flash 2.5 seconds OFF	Low discharge temperature protection	Temperature of discharge temperature thermistor has been 50°C or less for 20 minutes.	<ul style="list-style-type: none"> <li>Refer to 11-5. Ⓢ "Check of LEV".</li> <li>Check refrigerant circuit and refrigerant amount.</li> </ul>
20		8-time flash 2.5 seconds OFF	<b>MUZ-FH25/35</b> PAM protection PAM: Pulse Amplitude Modulation	The overcurrent flows into PFC (Power factor correction : IC820) or the bus-bar voltage reaches 394 V or more, PAM stops and restarts.	This is not malfunction. PAM protection will be activated in the following cases: 1 Instantaneous power voltage drop. (Short time power failure) 2 When the power supply voltage is high.
			<b>MUZ-FH50</b> Zero cross detecting circuit	Zero cross signal cannot be detected.	<ul style="list-style-type: none"> <li>It occurs with following cases.</li> <li>1 Instantaneous power voltage drop. (Short time power failure)</li> <li>2 Distortion of primary voltage</li> </ul> •Refer to 11-5. Ⓣ "Check of power supply".
21	9-time flash 2.5 seconds OFF	Inverter check mode	The connector of compressor is disconnected, inverter check mode starts.	<ul style="list-style-type: none"> <li>Check if the connector of the compressor is correctly connected. Refer to 11-5. ⓐ "How to check inverter/compressor".</li> </ul>	

**NOTE:** 1. The location of LED is illustrated at the right figure. Refer to 11-6.1.  
 2. LED is lighted during normal operation.

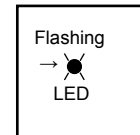
The flashing frequency shows the number of times the LED blinks after every 2.5-second OFF.  
 (Example) When the flashing frequency is "2".



Inverter P.C. board  
**MUZ-FH25/35VEHZ**



**MUZ-FH50VEHZ**



#### 11-4. TROUBLE CRITERION OF MAIN PARTS

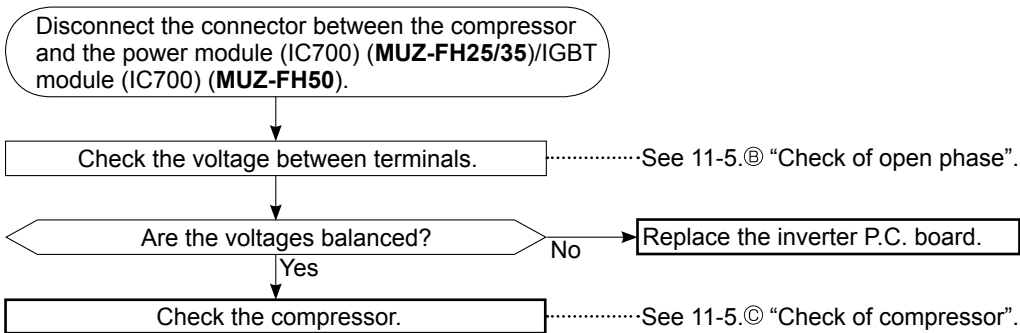
#### MUZ-FH25VEHZ MUZ-FH35VEHZ MUZ-FH50VEHZ

Part name	Check method and criterion	Figure										
Defrost thermistor (RT61) Fin temperature thermistor (RT64) Ambient temperature thermistor (RT65) Outdoor heat exchanger temperature thermistor (RT68)	Measure the resistance with a tester. Refer to 11-6. "Test point diagram and voltage", 1. "Inverter P.C. board", for the chart of thermistor.											
Discharge temperature thermistor (RT62)	Measure the resistance with a tester. Before measurement, hold the thermistor with your hands to warm it up. Refer to 11-6. "Test point diagram and voltage", 1. "Inverter P.C. board", for the chart of thermistor.											
Compressor	Measure the resistance between terminals using a tester. (Temperature: -10 ~ 40°C) <table border="1"> <thead> <tr> <th rowspan="2"></th> <th colspan="2">Normal (Ω)</th> </tr> <tr> <th>MUZ-FH25/35VEHZ</th> <th>MUZ-FH50VEHZ</th> </tr> </thead> <tbody> <tr> <td>U-V</td> <td rowspan="3">1.66 ~ 2.26</td> <td rowspan="3">0.87 ~ 1.18</td> </tr> <tr> <td>U-W</td> </tr> <tr> <td>V-W</td> </tr> </tbody> </table>		Normal (Ω)		MUZ-FH25/35VEHZ	MUZ-FH50VEHZ	U-V	1.66 ~ 2.26	0.87 ~ 1.18	U-W	V-W	
	Normal (Ω)											
	MUZ-FH25/35VEHZ	MUZ-FH50VEHZ										
U-V	1.66 ~ 2.26	0.87 ~ 1.18										
U-W												
V-W												
Outdoor fan motor	Measure the resistance between lead wires using a tester. (Temperature: -10 ~ 40°C) <table border="1"> <thead> <tr> <th rowspan="2">Color of lead wire</th> <th colspan="2">Normal (Ω)</th> </tr> <tr> <th>MUZ-FH25/35VEHZ</th> <th>MUZ-FH50VEHZ</th> </tr> </thead> <tbody> <tr> <td>RED - BLK</td> <td rowspan="3">12 ~ 16</td> <td rowspan="3">12 ~ 17</td> </tr> <tr> <td>BLK - WHT</td> </tr> <tr> <td>WHT - RED</td> </tr> </tbody> </table>	Color of lead wire	Normal (Ω)		MUZ-FH25/35VEHZ	MUZ-FH50VEHZ	RED - BLK	12 ~ 16	12 ~ 17	BLK - WHT	WHT - RED	
Color of lead wire	Normal (Ω)											
	MUZ-FH25/35VEHZ	MUZ-FH50VEHZ										
RED - BLK	12 ~ 16	12 ~ 17										
BLK - WHT												
WHT - RED												
R. V. coil (21S4)	Measure the resistance using a tester. (Temperature: -10 ~ 40°C) <table border="1"> <thead> <tr> <th colspan="2">Normal (kΩ)</th> </tr> <tr> <th>MUZ-FH25/35VEHZ</th> <th>MUZ-FH50VEHZ</th> </tr> </thead> <tbody> <tr> <td>1.41 ~ 2.00</td> <td>1.19 ~ 1.78</td> </tr> </tbody> </table>	Normal (kΩ)		MUZ-FH25/35VEHZ	MUZ-FH50VEHZ	1.41 ~ 2.00	1.19 ~ 1.78					
Normal (kΩ)												
MUZ-FH25/35VEHZ	MUZ-FH50VEHZ											
1.41 ~ 2.00	1.19 ~ 1.78											
Expansion valve coil (LEV)	Measure the resistance using a tester. (Temperature: -10 ~ 40°C) <table border="1"> <thead> <tr> <th>Color of lead wire</th> <th>Normal (Ω)</th> </tr> </thead> <tbody> <tr> <td>RED - ORN</td> <td rowspan="4">37 ~ 54</td> </tr> <tr> <td>RED - WHT</td> </tr> <tr> <td>RED - BLU</td> </tr> <tr> <td>RED - YLW</td> </tr> </tbody> </table>	Color of lead wire	Normal (Ω)	RED - ORN	37 ~ 54	RED - WHT	RED - BLU	RED - YLW				
Color of lead wire	Normal (Ω)											
RED - ORN	37 ~ 54											
RED - WHT												
RED - BLU												
RED - YLW												
Defrost heater	Measure the resistance using a tester. (Temperature: -10 ~ 40°C) <table border="1"> <thead> <tr> <th colspan="2">Normal (Ω)</th> </tr> <tr> <th>MUZ-FH25/35VEHZ</th> <th>MUZ-FH50VEHZ</th> </tr> </thead> <tbody> <tr> <td>394 ~ 428</td> <td>376 ~ 461</td> </tr> </tbody> </table>	Normal (Ω)		MUZ-FH25/35VEHZ	MUZ-FH50VEHZ	394 ~ 428	376 ~ 461					
Normal (Ω)												
MUZ-FH25/35VEHZ	MUZ-FH50VEHZ											
394 ~ 428	376 ~ 461											



## 11-5. TROUBLESHOOTING FLOW

### A How to check inverter/compressor



### B Check of open phase

- With the connector between the compressor and the power module (IC700) (MUZ-FH25/35)/IGBT module (IC700) (MUZ-FH50) disconnected, activate the inverter and check if the inverter is normal by measuring the **voltage balance** between the terminals.

Output voltage is 50 - 130 V. (The voltage may differ according to the tester.)

<< Operation method >>

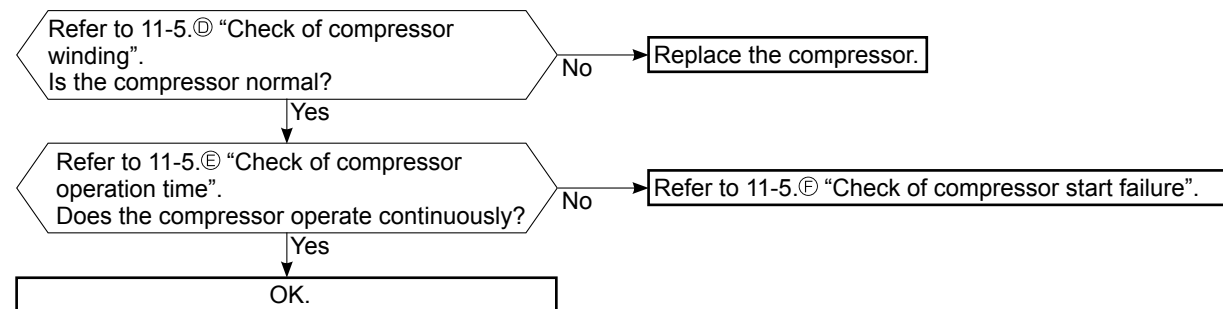
Start cooling or heating operation by pressing EMERGENCY OPERATION switch on the indoor unit. (TEST RUN OPERATION: Refer to 8-3.)

<< Measurement point >>

- At 3 points ※ Measure AC voltage between the lead wires at 3 points.
- BLK (U)-WHT (V)
- BLK (U)-RED (W)
- WHT(V)-RED (W)

- NOTE:**
- Output voltage varies according to power supply voltage.
  - Measure the voltage by analog type tester.
  - During this check, LED of the inverter P.C. board flashes 9 times. (Refer to 11-6.1.)

### C Check of compressor



### D Check of compressor winding

- Disconnect the connector between the compressor and the power module (IC700) (**MUZ-FH25/35**)/IGBT module (IC700) (**MUZ-FH50**), and measure the resistance between the compressor terminals.

<<Measurement point>>

at 3 points

BLK-WHT

BLK-RED

WHT-RED

※ Measure the resistance between the lead wires at 3 points.

<<Judgement>>

Refer to 11-4.

0 [Ω] .....Abnormal [short]

Infinite [Ω] .....Abnormal [open]

**NOTE:** Be sure to zero the ohmmeter before measurement.

### E Check of compressor operation time

- Connect the compressor and activate the inverter. Then measure the time until the inverter stops due to over current.

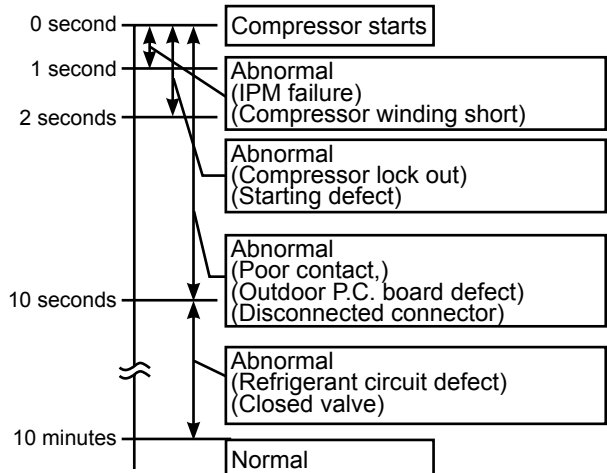
<<Operation method>>

Start heating or cooling operation by pressing EMERGENCY OPERATION switch on the indoor unit. (TEST RUN OPERATION: Refer to 8-3.)

<<Measurement>>

Measure the time from the start of compressor to the stop of compressor due to overcurrent.

<<Judgement>>



### F Check of compressor start failure

Confirm that ①~④ is normal.

•Electrical circuit check

①. Contact of the compressor connector

②. Output voltage of inverter P.C. board and balance of them (See 11-5.③)

③. Direct current voltage between DB61(+) and (-) (**MUZ-FH25/35**)/JP715(+) and JP30(-) (**MUZ-FH50**) on the inverter P.C. board

④. Voltage between outdoor terminal block S1-S2

Does the compressor run for 10 seconds or more after it starts?

Yes

Check the refrigerant circuit.  
Check the stop valve.

No

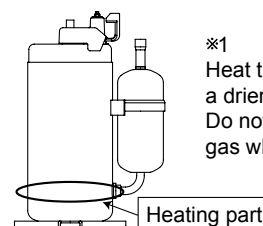
After the compressor is heated with a drier, does the compressor start? ※1

No

Replace the compressor.

Yes

Compressor start failure. Activate pre-heat control.  
(Refer to 10-2. "PRE-HEAT CONTROL SETTING")



※1 Heat the compressor with a drier for about 20 minutes. Do not recover refrigerant gas while heating.

### Ⓒ Check of outdoor thermistors

Disconnect the connector of thermistor in the outdoor P.C. board (see below table), and measure the resistance of thermistor.

Is the resistance of thermistor normal?  
(Refer to 11-6.1.)

No

Replace the thermistor except RT64.  
When RT64 is abnormal, replace the inverter P.C. board.

Yes

Reconnect the connector of thermistor.  
Turn ON the power supply and press EMERGENCY OPERATION switch.

Does the unit operate for 10 minutes or more  
without showing thermistor abnormality?

No

Replace the inverter P.C. board.

Yes

OK.  
(Cause is poor contact.)

#### MUZ-FH25/35

Thermistor	Symbol	Connector, Pin No.	Board
Defrost	RT61	Between CN641 pin1 and pin2	Inverter P.C. board
Discharge temperature	RT62	Between CN641 pin3 and pin4	
Fin temperature	RT64	Between CN642 pin1 and pin2	
Ambient temperature	RT65	Between CN643 pin1 and pin2	
Outdoor heat exchanger temperature	RT68	Between CN644 pin1 and pin3	

#### MUZ-FH50

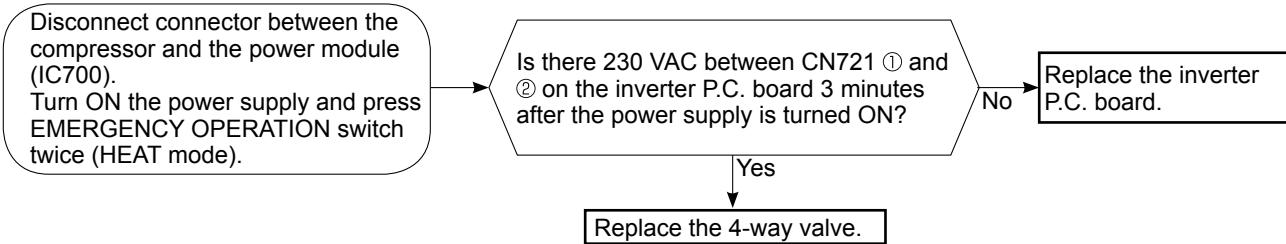
Thermistor	Symbol	Connector, Pin No.	Board
Defrost	RT61	Between CN671 pin1 and pin2	Inverter P.C. board
Discharge temperature	RT62	Between CN671 pin3 and pin4	
Fin temperature	RT64	Between CN673 pin1 and pin2	
Ambient temperature	RT65	Between CN672 pin1 and pin2	
Outdoor heat exchanger temperature	RT68	Between CN671 pin5 and pin6	

## H Check of R.V. coil

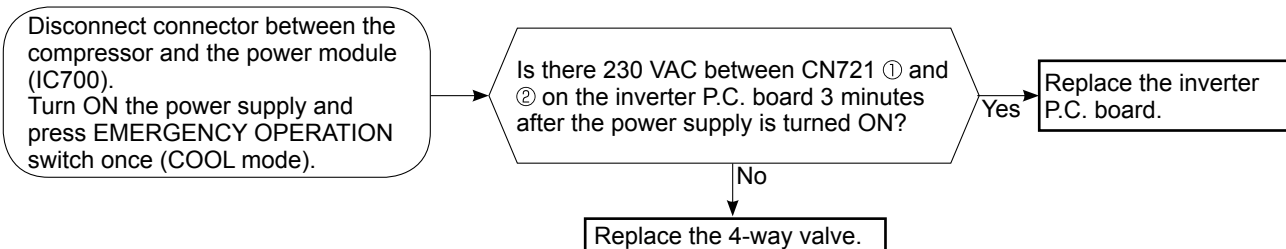
### MUZ-FH25/35

- ※ First of all, measure the resistance of R.V. coil to check if the coil is defective. Refer to 11-4.
- ※ In case CN721 is disconnected or R.V. coil is open, voltage is generated between the terminal pins of the connector although no signal is being transmitted to R.V. coil.  
Check if CN721 is connected.

#### Unit operates COOL mode even if it is set to HEAT mode.



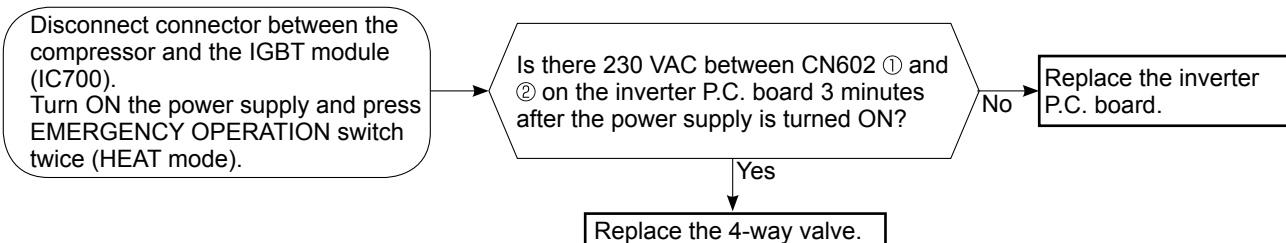
#### Unit operates HEAT mode even if it is set to COOL mode.



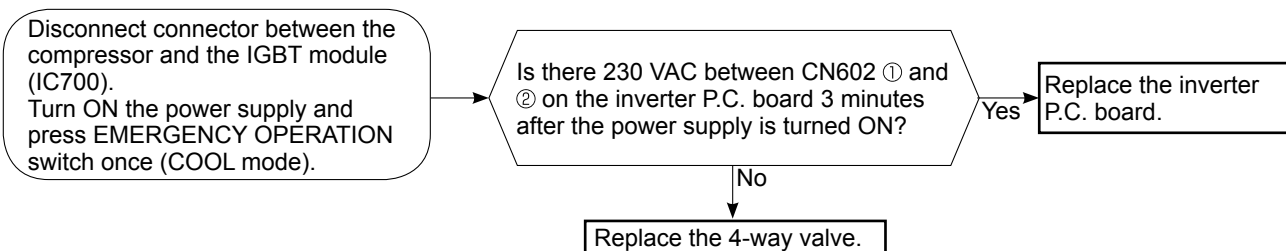
### MUZ-FH50

- ※ First of all, measure the resistance of R.V. coil to check if the coil is defective. Refer to 11-4.
- ※ In case CN602 is disconnected or R.V. coil is open, voltage is generated between the terminal pins of the connector although no signal is being transmitted to R.V. coil.  
Check if CN602 is connected.

#### Unit operates COOL mode even if it is set to HEAT mode.



#### Unit operates HEAT mode even if it is set to COOL mode.



### ① Check of outdoor fan motor

Disconnect the connectors CN931 and CN932 from the inverter P.C. board.  
Check the connection between the connector CN931 and CN932.

Is the resistance between each terminal of outdoor fan motor normal?  
(Refer to 11-4.)

Yes

Disconnect CN932 from the inverter P.C. board, and turn on the power supply.

Rotate the outdoor fan motor manually and measure the voltage of CN931.  
Between 1(+) and 5(-)  
Between 2(+) and 5(-)  
Between 3(+) and 5(-)

No

(Fixed to either 5 or 0 VDC)

Does the voltage between each terminal become 5 and 0 VDC repeatedly?

No

Yes

Does the outdoor fan motor rotate smoothly?

No

Yes

Replace the outdoor fan motor.

Replace the inverter P.C. board.

**Ⓝ Check of power supply**

Disconnect the connector between the compressor and the power module (IC700) (**MUZ-FH25/35**)/IGBT module (IC700) (**MUZ-FH50**).  
Turn ON power supply and press EMERGENCY OPERATION switch.

Does POWER lamp on the indoor unit light up?

Yes

No

Is there voltage 230 VAC between the indoor terminal block S1 and S2?

Yes

No

Replace the indoor electronic control P.C. board.

Rectify indoor/outdoor connecting wire.

Is there bus-bar voltage 260 - 370 VDC between DB61 (+) and DB61 (-) (**MUZ-FH25/35**)/325 - 370 VDC between JP715 (+) and JP30 (-) (**MUZ-FH50**) on the inverter P.C. board? (Refer to 11-6.1.)

Yes

No

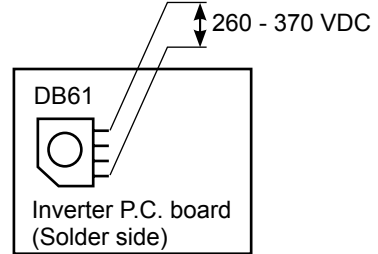
Does LED on the inverter P.C. board light up or flash? (Refer to 11-6.1.)

Replace the inverter P.C. board.

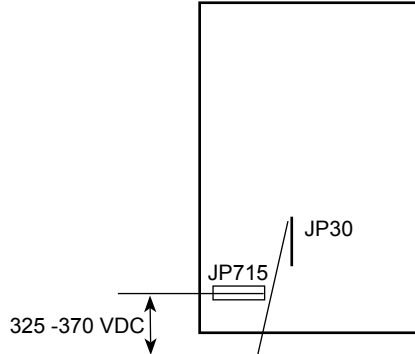
Yes

If light up, OK.  
If flash, refer to 11-3.

Check the electric parts in main circuit.



**MUZ-FH25/35**



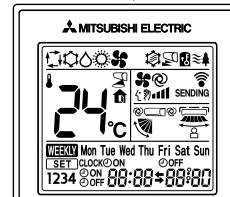
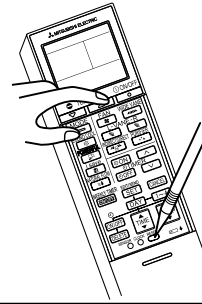
**MUZ-FH50**

## K Check of LEV (Expansion valve)

Turn ON the power supply.

<Preparation of the remote controller>

- ① While pressing both OPERATION SELECT button and TEMP  $\oplus$  button on the remote controller at the same time, press RESET button.
- ② First, release RESET button.  
Hold down the other two buttons for another 3 seconds. Make sure that the indicators on the LCD screen shown in the right figure are all displayed. Then release the buttons.



Press OPERATE/STOP (ON/OFF) button of the remote controller (the set temperature is displayed) with the remote controller headed towards the indoor unit. ※1

Expansion valve operates in full-opening direction.

Do you hear the expansion valve "click, click....." ?  
Do you feel the expansion valve vibrate on touching it ?

Yes

OK

No

Is LEV coil properly fixed to the expansion valve?

No

Properly fix the LEV coil to the expansion valve.

Yes

Does the resistance of LEV coil have the characteristics? (Refer to 11-4.)

Yes

Measure each voltage between connector pins of CN724 on the inverter P.C. board.  
1. Pin③(-) — Pin①(+)  
2. Pin④(-) — Pin①(+)  
3. Pin⑤(-) — Pin①(+)  
4. Pin⑥(-) — Pin①(+)  
Is there about 3 - 5 VAC between each?  
**NOTE:** Measure the voltage by an analog tester.

No

Replace the inverter P.C. board.

No

Replace the LEV coil.

Yes

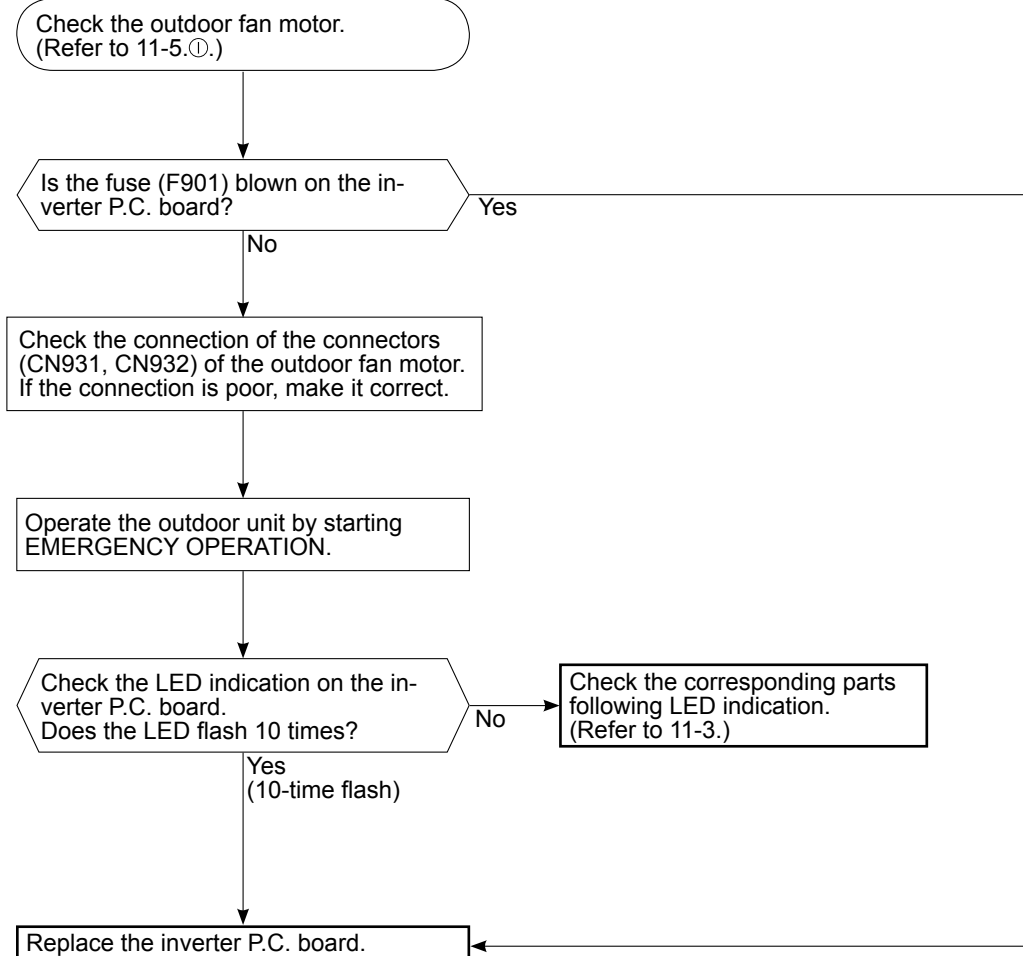
Replace the expansion valve.

※1. Regardless of normal or abnormal condition, a short beep is emitted once the signal is received.

**NOTE:** After check of LEV, do the undermentioned operations.

1. Turn OFF the power supply and turn it ON again.
2. Press RESET button on the remote controller.

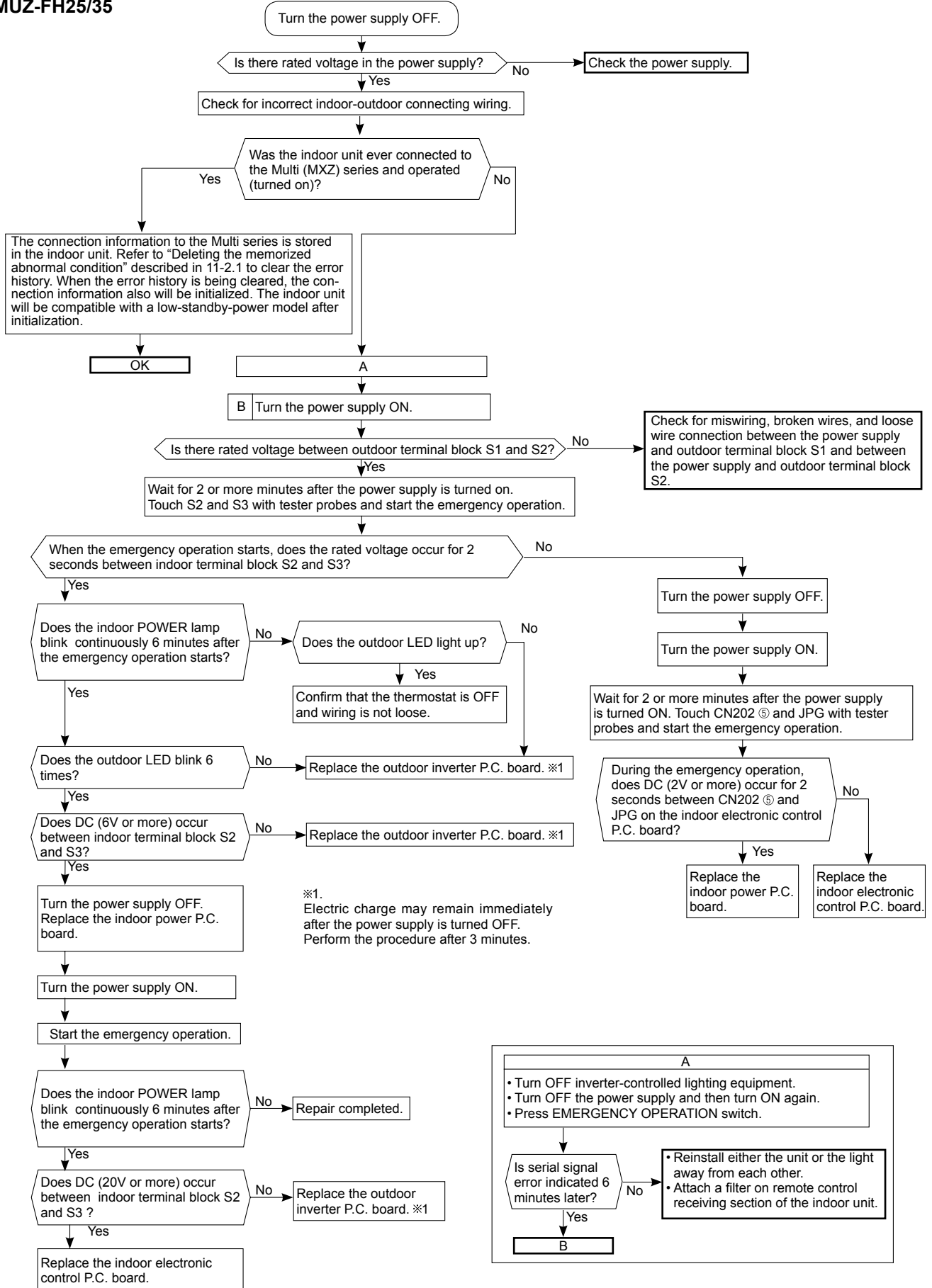
## Ⓛ Check of inverter P.C. board



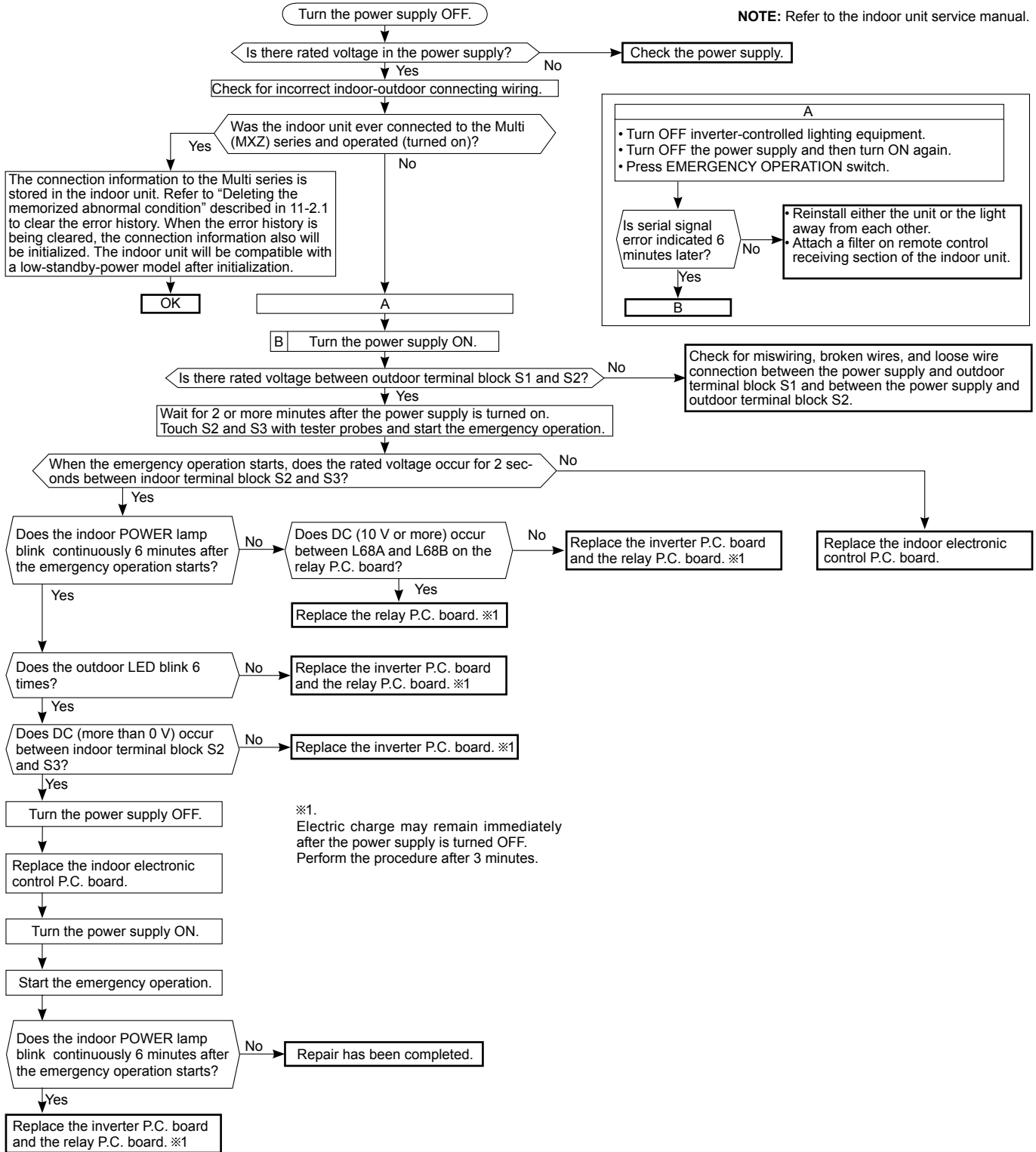


# M How to check miswiring and serial signal error

MUZ-FH25/35

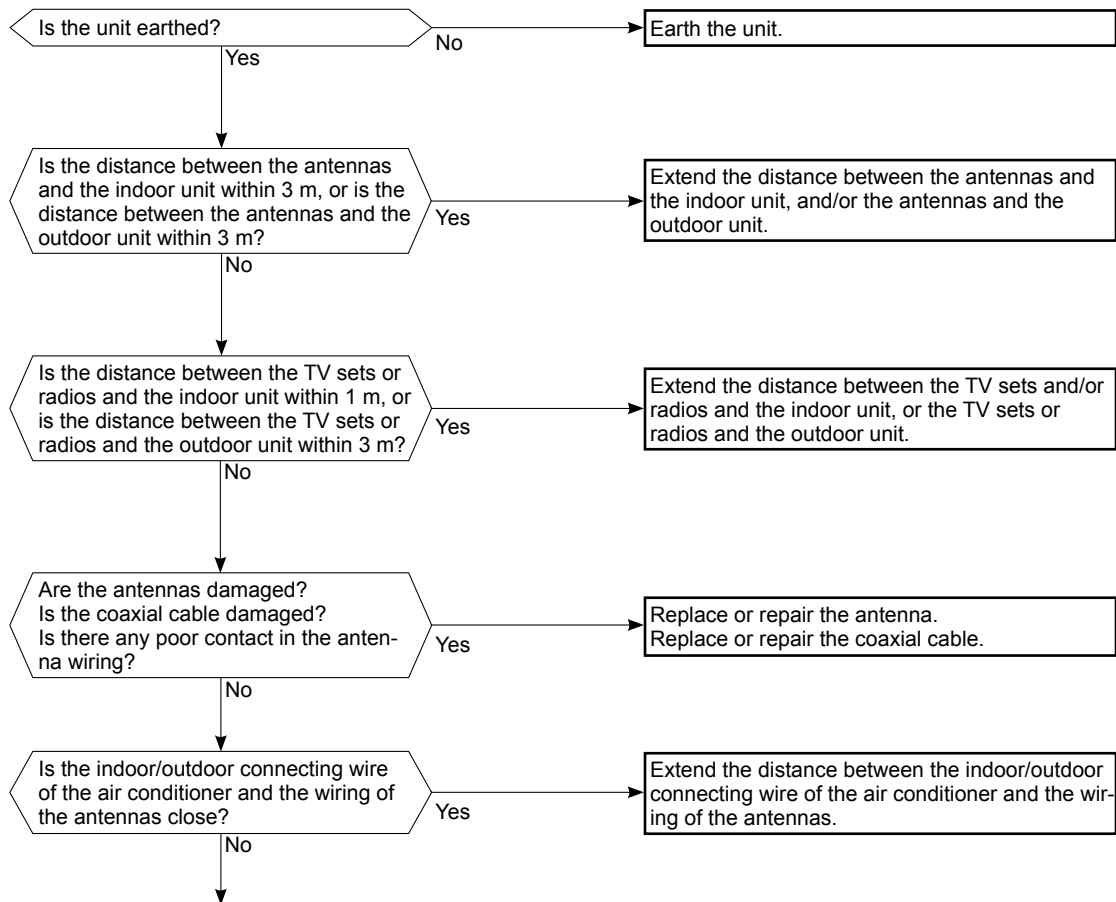


# MUZ-FH50





**N Electromagnetic noise enters into TV sets or radios**



Even if all of the above conditions are fulfilled, the electromagnetic noise may enter, depending on the electric field strength or the installation condition (combination of specific conditions such as antennas or wiring). Check the following before asking for service.

1. Devices affected by the electromagnetic noise  
TV sets, radios (FM/AM broadcast, shortwave)
2. Channel, frequency, broadcast station affected by the electromagnetic noise
3. Channel, frequency, broadcast station unaffected by the electromagnetic noise
4. Layout of:  
indoor/outdoor unit of the air conditioner, indoor/outdoor wiring, earth wire, antennas, wiring from antennas, receiver
5. Electric field intensity of the broadcast station affected by the electromagnetic noise
6. Presence or absence of amplifier such as booster
7. Operation condition of air conditioner when the electromagnetic noise enters in
  - 1) Turn OFF the power supply once, and then turn ON the power supply. In this situation, check for the electromagnetic noise.
  - 2) Within 3 minutes after turning ON the power supply, press OPERATE/STOP (ON/OFF) button on the remote controller for power ON, and check for the electromagnetic noise.
  - 3) After a short time (3 minutes later after turning ON), the outdoor unit starts running. During operation, check for the electromagnetic noise.
  - 4) Press OPERATE/STOP (ON/OFF) button on the remote controller for power OFF, when the outdoor unit stops but the indoor/outdoor communication still runs on. In this situation, check for the electromagnetic noise.

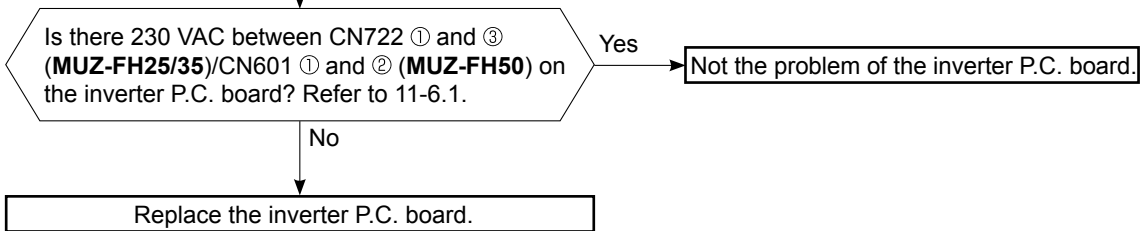
## ① Check of defrost heater

Check the following points before checking electric continuity.

1. Does the resistance of ambient temperature thermistor have the characteristics? Refer to 11-6.1.
2. Is the resistance of defrost heater normal? Refer to 11-4.
3. Does the heater protector remain conducted (not open)?
4. Are both ambient temperature thermistor and circuit of defrost heater securely connected to connectors?

In HEAT mode, for more than 5 minutes, let the ambient temperature thermistor continue to read 0°C or below, and let the defrost thermistor continue to read -1°C or below.

**NOTE:** In case both thermistors are more than the above temperature, cool them with cold water etc...

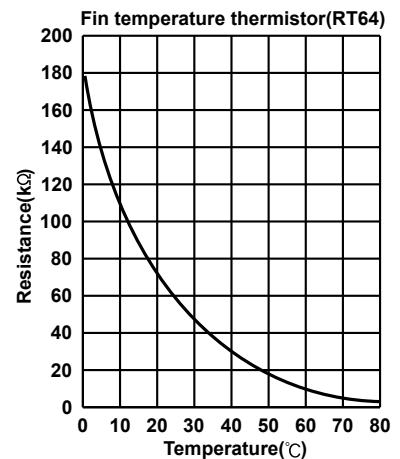
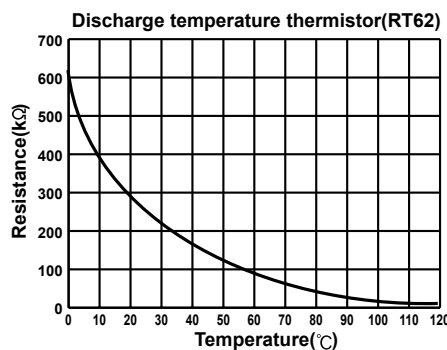
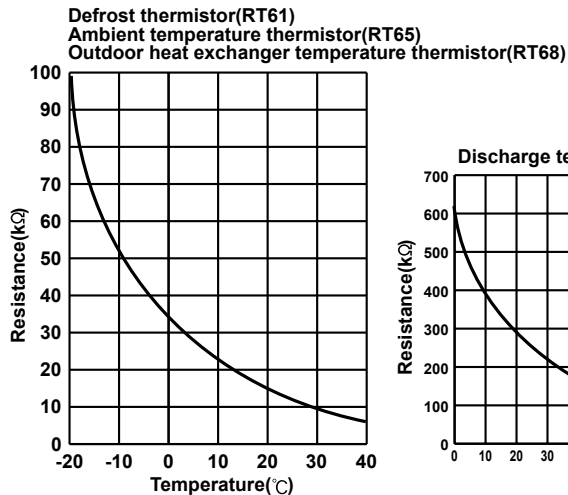
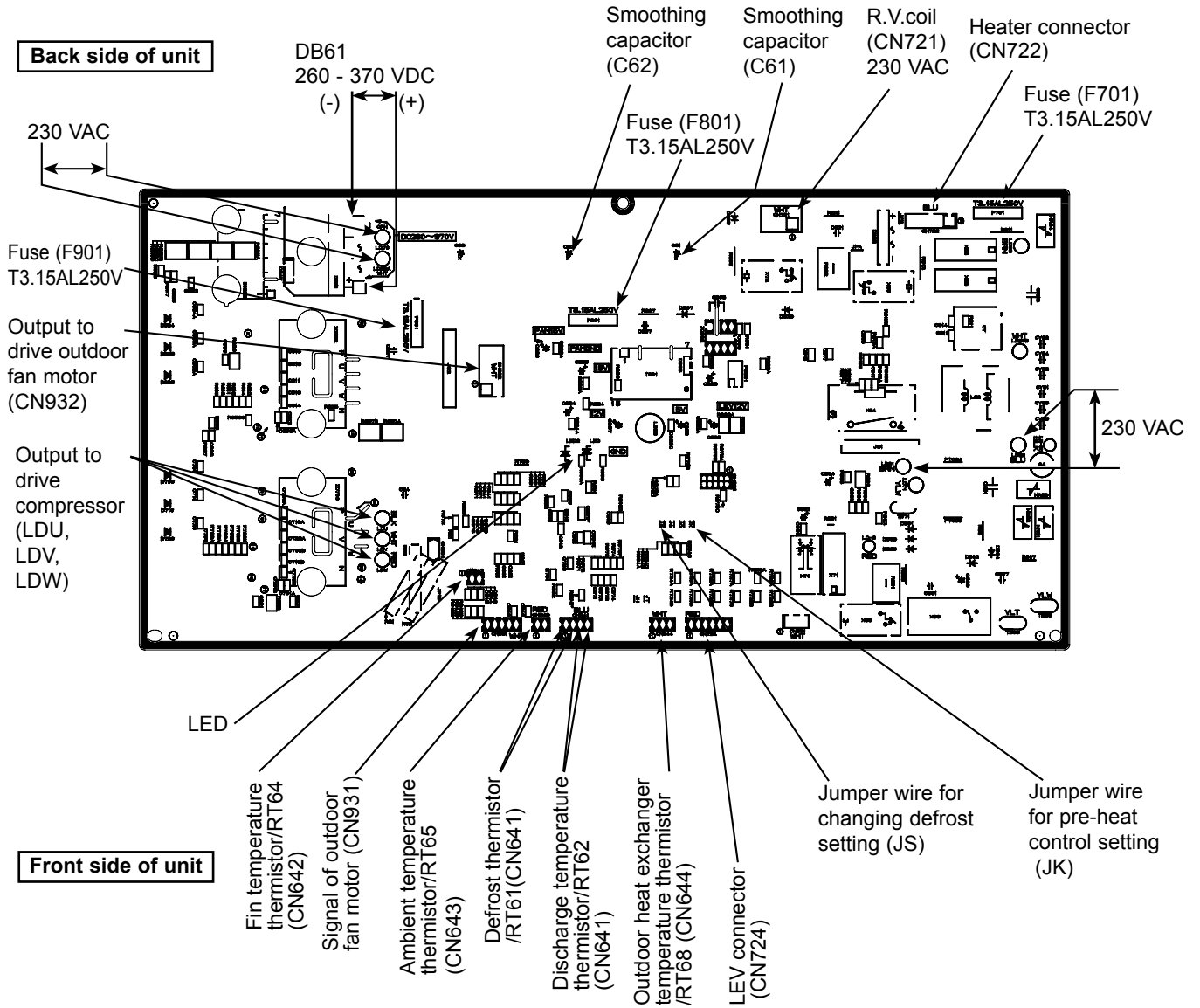


# 11-6. TEST POINT DIAGRAM AND VOLTAGE

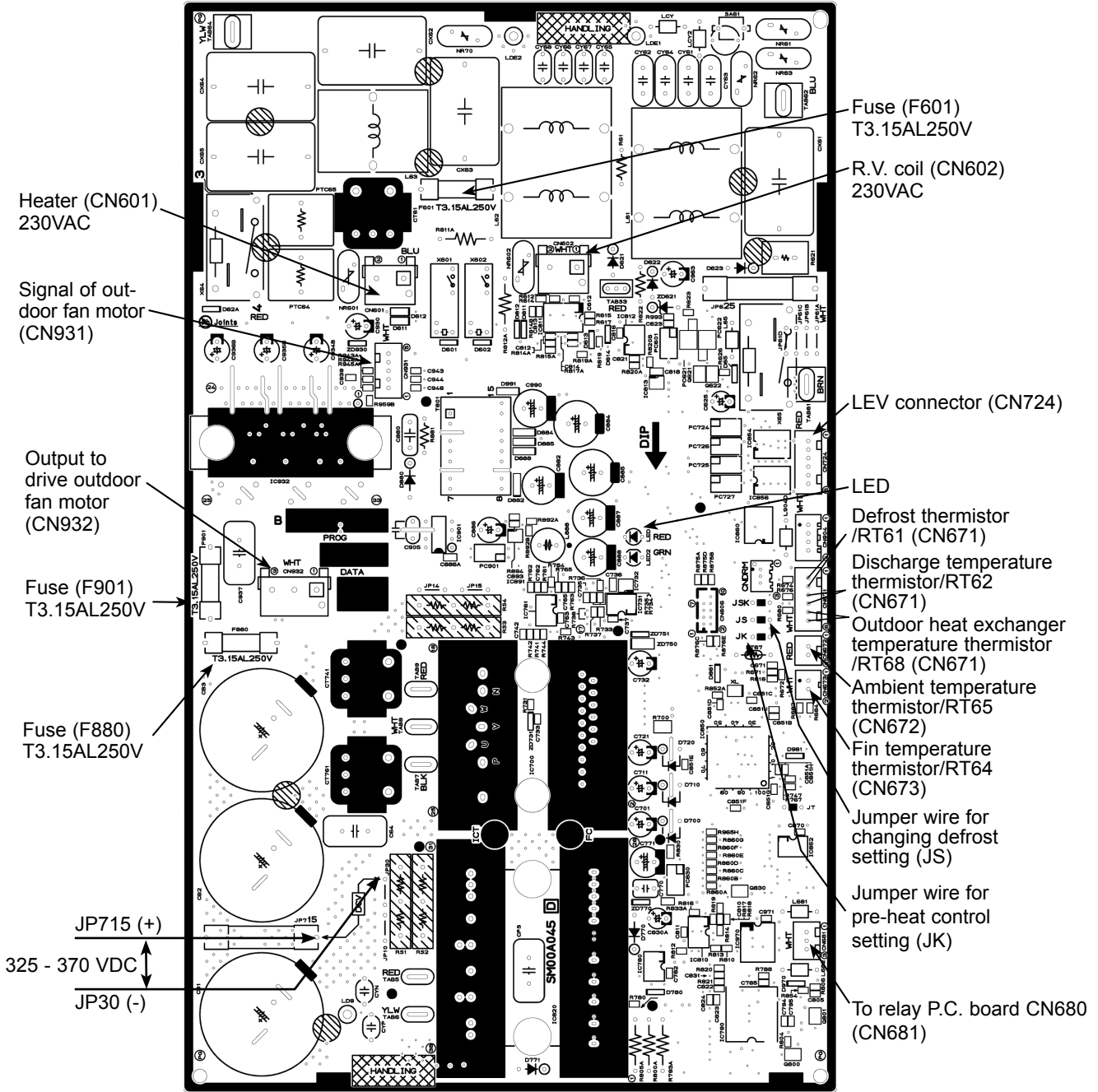
## 1. Inverter P.C. board

MUZ-FH25VEHZ

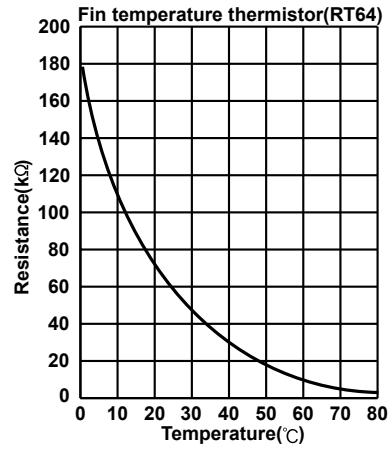
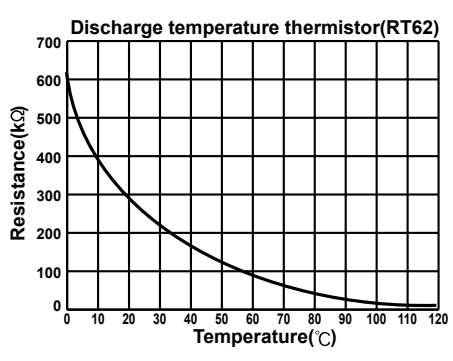
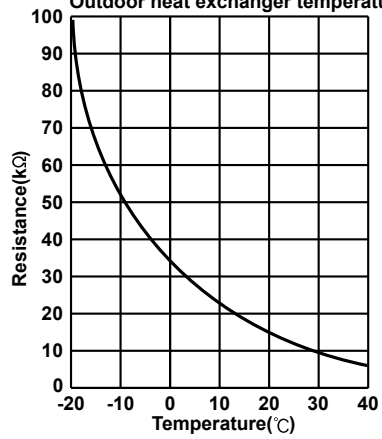
MUZ-FH35VEHZ



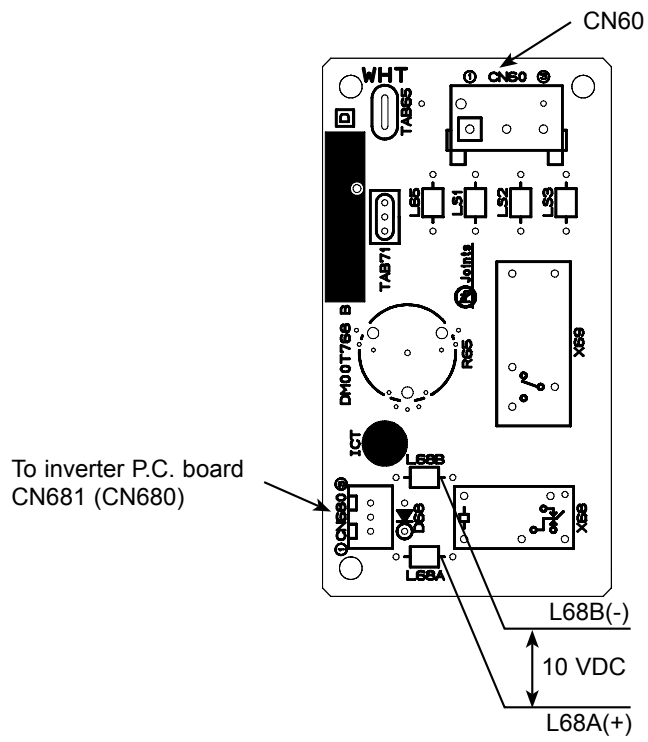
# MUZ-FH50VEHZ



Defrost thermistor(RT61)  
Ambient temperature thermistor(RT65)  
Outdoor heat exchanger temperature thermistor(RT68)



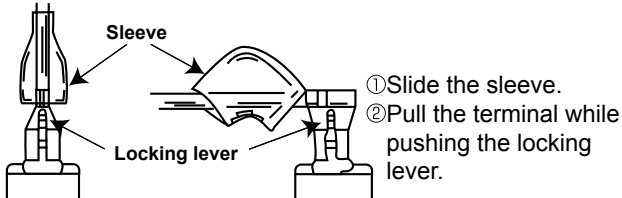
2. Relay P.C. board  
MUZ-FH50VEHZ



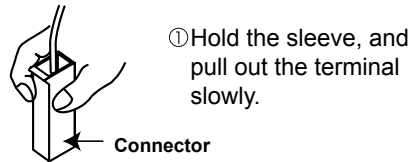
<"Terminal with locking mechanism" Detaching points>

The terminal which has the locking mechanism can be detached as shown below.  
 There are two types (refer to (1) and (2)) of the terminal with locking mechanism.  
 The terminal without locking mechanism can be detached by pulling it out.  
 Check the shape of the terminal before detaching.

(1) Slide the sleeve and check if there is a locking lever or not.



(2) The terminal with this connector has the locking mechanism.



**12-1. MUZ-FH25VEHZ  
 MUZ-FH35VEHZ**

**NOTE:** Turn OFF power supply before disassembly.

OPERATING PROCEDURE	PHOTOS
<p><b>1. Removing the cabinet</b></p> <ol style="list-style-type: none"> <li>(1) Remove the screw fixing the service panel.</li> <li>(2) Pull down the service panel and remove it.</li> <li>(3) Disconnect the power supply and indoor/outdoor connecting wire.</li> <li>(4) Remove the screws fixing the top panel.</li> <li>(5) Remove the top panel.</li> <li>(6) Remove the screws fixing the cabinet.</li> <li>(7) Remove the cabinet.</li> <li>(8) Remove the screws fixing the back panel.</li> <li>(9) Remove the back panel.</li> </ol>	<p><b>Photo 1</b></p> <p>Screws of the top panel              Screws of the top panel              Back panel              Screw of the back panel              Service panel              Screws of the cabinet</p> <p><b>Photo 2</b></p> <p>Screw of the cabinet              Screws of the terminal block support and the back panel              Screw of the service panel              Direction to remove              Screws of the cabinet              Hooks</p>



## OPERATING PROCEDURE

### 2. Removing the inverter assembly, inverter P.C. board

- (1) Remove the cabinet and panels. (Refer to 1.)
- (2) Disconnect the lead wire to the reactor and the following connectors:  
<Inverter P.C. board>  
CN721 (R.V. coil)  
CN722 (Defrost heater)  
CN931, CN932 (Fan motor)  
CN641 (Defrost thermistor and discharge temperature thermistor)  
CN643 (Ambient temperature thermistor)  
CN644 (Outdoor heat exchanger temperature thermistor)  
CN724 (LEV)
- (3) Remove the compressor connector (CN61).
- (4) Remove the screws fixing the heat sink support and the separator.
- (5) Remove the fixing screws of the terminal block support and the back panel.
- (6) Remove the inverter assembly.
- (7) Remove the screw of the earth wire and screw of the terminal block support.
- (8) Remove the heat sink support from the P.C. board support.
- (9) Remove the screw of the inverter P.C. board and remove the inverter P.C. board from the P.C. board support.

### 3. Removing R.V. coil

- (1) Remove the cabinet and panels. (Refer to 1.)
- (2) Disconnect the following connectors:  
<Inverter P.C. board>  
CN721 (R.V. coil)
- (3) Remove the R.V. coil.

### 4. Removing the discharge temperature thermistor, defrost thermistor, outdoor heat exchanger temperature thermistor and ambient temperature thermistor

- (1) Remove the cabinet and panels. (Refer to 1.)
- (2) Disconnect the lead wire to the reactor and the following connectors:  
<Inverter P.C. board>  
CN641 (Defrost thermistor and discharge temperature thermistor)  
CN643 (Ambient temperature thermistor)  
CN644 (Outdoor heat exchanger temperature thermistor)
- (3) Pull out the discharge temperature thermistor from its holder.
- (4) Pull out the defrost thermistor from its holder. (Photo 6)
- (5) Pull out the outdoor heat exchanger temperature thermistor from its holder. (Photo 6)
- (6) Pull out the ambient temperature thermistor from its holder.

## PHOTOS

Photo 3

Screws of the heat sink support and the separator      Screws of the terminal block support and the back panel

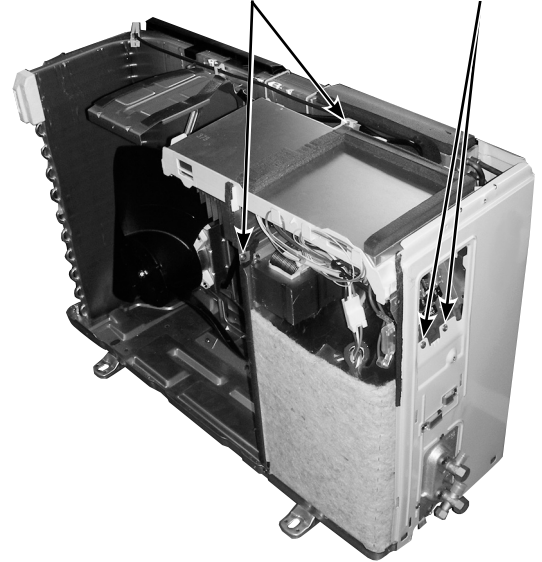


Photo 4 (Inverter assembly)

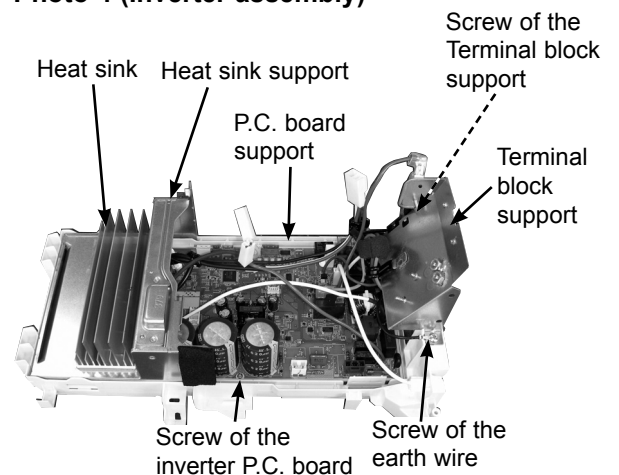
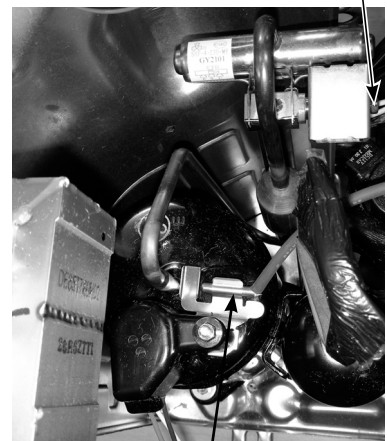


Photo 5

Screw of the R.V. coil



Discharge temperature thermistor

## OPERATING PROCEDURE

### 5. Removing outdoor fan motor

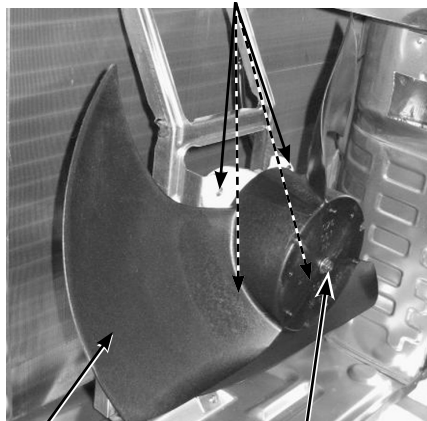
- (1) Remove the cabinet and panels. (Refer to 1.)
- (2) Disconnect the following connectors:  
<Inverter P.C. board>  
CN931, CN932 (Fan motor)
- (3) Remove the propeller nut.
- (4) Remove the propeller.
- (5) Remove the screws fixing the fan motor.
- (6) Remove the fan motor.

### 6. Removing the compressor and 4-way valve

- (1) Remove the cabinet and panels. (Refer to 1.)
- (2) Remove the inverter assembly. (Refer to 2.)
- (3) Recover gas from the refrigerant circuit.  
**NOTE:** Recover gas from the pipes until the pressure gauge shows 0 kg/cm<sup>2</sup> (0 MPa).
- (4) Detach the brazed part of the suction and the discharge pipe connected with compressor.
- (5) Remove the nuts of compressor legs.
- (6) Remove the compressor.
- (7) Detach the brazed part of pipes connected with 4-way valve.

**Photo 8**

Screws of the outdoor fan motor



Propeller

Propeller nut

**Photo 9**

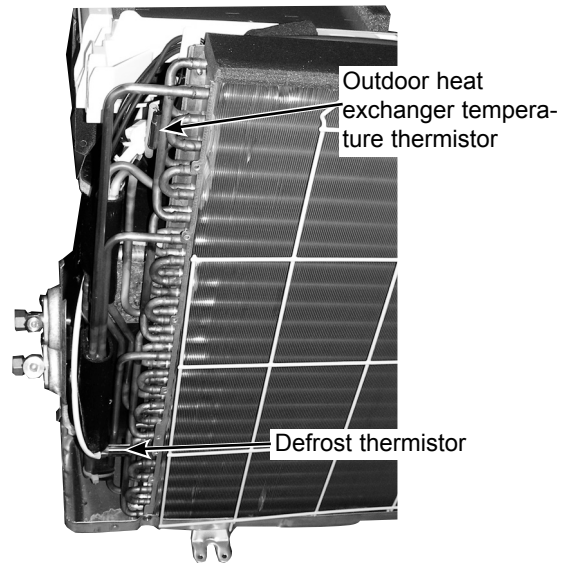
Suction pipe  
Discharge pipe brazed part  
brazed part



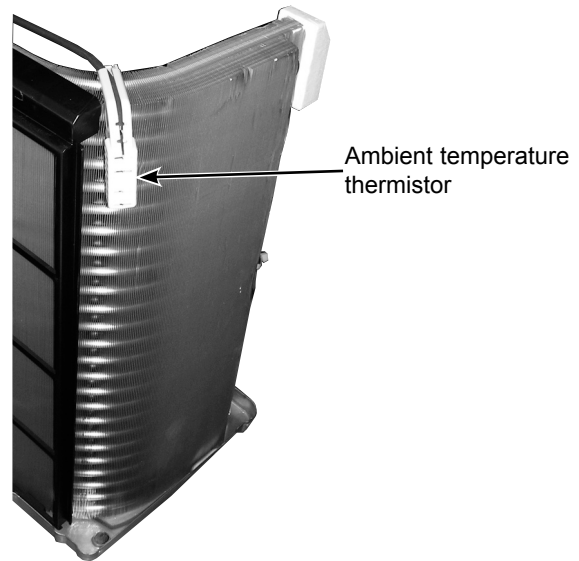
Brazed parts of 4-way valve

## PHOTOS

**Photo 6**

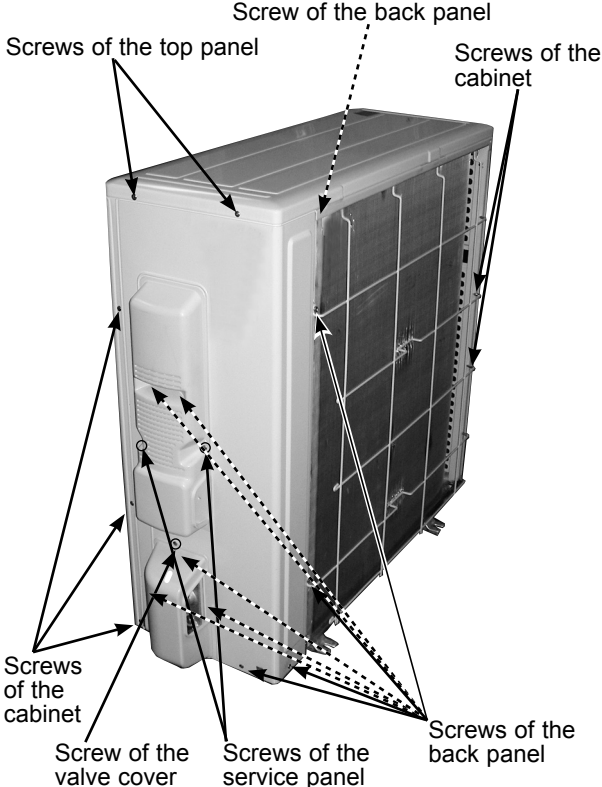
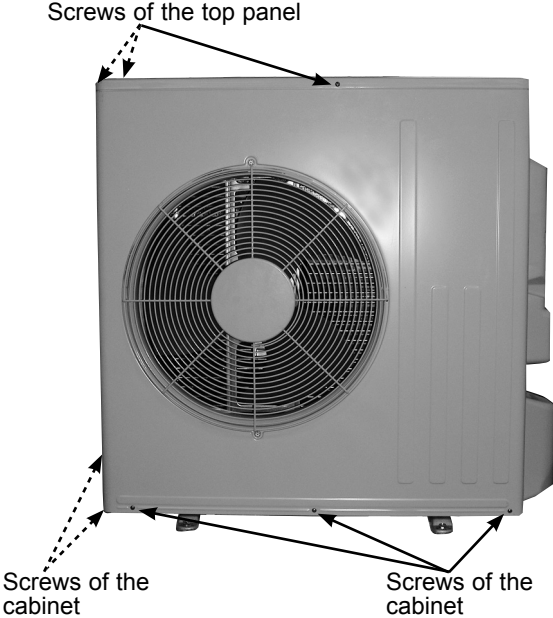


**Photo 7**



## 12-2. MUZ-FH50VEHZ

**NOTE:** Turn OFF power supply before disassembly.

OPERATING PROCEDURE	PHOTOS
<p><b>1. Removing the cabinet</b></p> <ol style="list-style-type: none"><li>(1) Remove the screws of the service panel.</li><li>(2) Remove the screws of the top panel.</li><li>(3) Remove the screw of the valve cover.</li><li>(4) Remove the service panel.</li><li>(5) Remove the top panel.</li><li>(6) Remove the valve cover.</li><li>(7) Disconnect the power supply and indoor/outdoor connecting wire.</li><li>(8) Remove the screws of the cabinet.</li><li>(9) Remove the cabinet.</li><li>(10) Remove the screws of the back panel.</li><li>(11) Remove the back panel.</li></ol> <p><b>Photo 2</b></p>  <p>Screws of the top panel</p> <p>Screw of the back panel</p> <p>Screws of the cabinet</p> <p>Screws of the cabinet</p> <p>Screws of the cabinet</p> <p>Screws of the cabinet</p> <p>Screw of the valve cover</p> <p>Screws of the service panel</p> <p>Screws of the back panel</p>	<p><b>Photo 1</b></p>  <p>Screws of the top panel</p> <p>Screws of the cabinet</p> <p>Screws of the cabinet</p>

## OPERATING PROCEDURE

### 2. Removing the inverter assembly, inverter P.C. board and relay P.C. board

- (1) Remove the cabinet and panels. (Refer to 1.)
- (2) Disconnect the lead wire to the reactor and the following connectors:
  - <Inverter P.C. board>
  - CN602 (R.V. coil)
  - CN931, CN932 (Fan motor)
  - CN671 (Defrost thermistor, discharge temperature thermistor and outdoor heat exchanger temperature thermistor)
  - CN672 (Ambient temperature thermistor)
  - CN724 (LEV)
  - CN601 (Defrost heater and heater protector)
- (3) Remove the compressor connector.
- (4) Remove the screws fixing the relay panel.
- (5) Remove the relay panel.
- (6) Remove the earth wires and the lead wires of the inverter P.C. board.
- (7) Remove the screws of the P.B. support.
- (8) Remove the inverter P.C. board from the relay panel.
- (9) Disconnect the following connectors:
  - <Relay P.C. board>
  - CN60 (Terminal block)
  - CN680 (Inverter P.C. board)
  - TAB65 (Inverter P.C. board)
  - TB71
- (10) Remove the screws fixing the P.B. holder.
- (11) Remove the relay P.C. board from the P.B. holder.

### 3. Removing R.V. coil

- (1) Remove the cabinet and panels. (Refer to 1.)
- (2) Disconnect the following connector:
  - <Inverter P.C. board>
  - CN602 (R.V. coil)
- (3) Remove the R.V. coil.

## PHOTOS

Photo 3

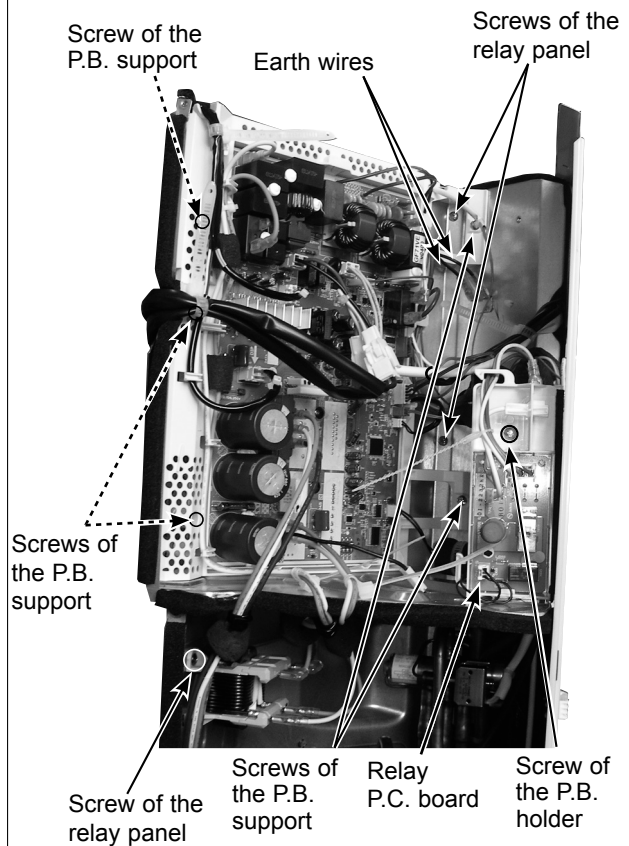


Photo 4



## OPERATING PROCEDURE

### 4. Removing the discharge temperature thermistor, defrost thermistor, outdoor heat exchanger temperature thermistor and ambient temperature thermistor

- (1) Remove the cabinet and panels. (Refer to 1.)
- (2) Disconnect the lead wire to the reactor and the following connectors:  
<Inverter P.C. board>  
CN671 (Defrost thermistor, discharge temperature thermistor and outdoor heat exchanger temperature thermistor)  
CN672 (Ambient temperature thermistor)
- (3) Pull out the discharge temperature thermistor from its holder. (Photo 7)
- (4) Pull out the defrost thermistor from its holder.
- (5) Pull out the outdoor heat exchanger temperature thermistor from its holder.
- (6) Pull out the ambient temperature thermistor from its holder.

### 5. Removing outdoor fan motor

- (1) Remove the top panel, cabinet and service panel. (Refer to 1.)
- (2) Disconnect the following connectors:  
<Inverter P.C. board>  
CN931 and CN932 (Fan motor)
- (3) Remove the propeller.
- (4) Remove the screws fixing the fan motor.
- (5) Remove the fan motor.

### 6. Removing the compressor and 4-way valve

- (1) Remove the top panel, cabinet and service panel. (Refer to 1.)
- (2) Remove the back panel. (Refer to 1.)
- (3) Remove the inverter assembly. (Refer to 2.)
- (4) Recover gas from the refrigerant circuit.  
**NOTE:** Recover gas from the pipes until the pressure gauge shows 0 kg/cm<sup>2</sup> (0 MPa).
- (5) Detach the brazed part of the suction and the discharge pipe connected with compressor.
- (6) Remove the compressor nuts.
- (7) Remove the compressor.
- (8) Detach the brazed parts of 4-way valve and pipe. (Photo 4)

## PHOTOS

Photo 5

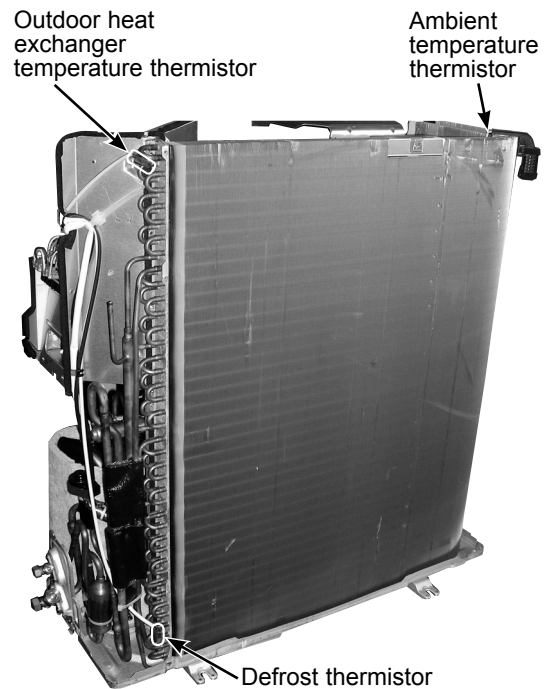
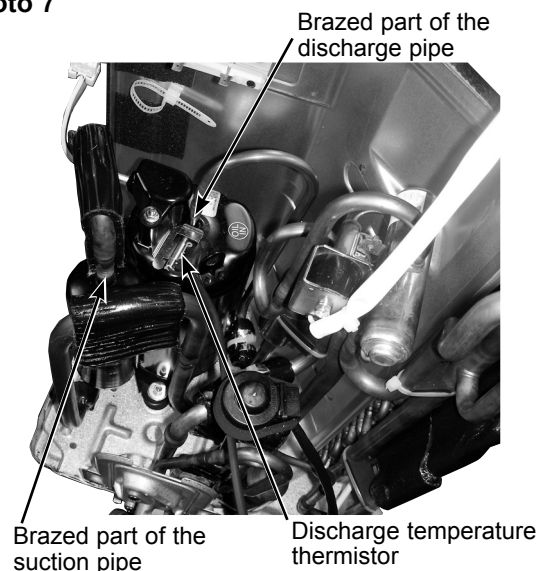


Photo 6



Photo 7



# **mitsubishi electric corporation**

HEAD OFFICE: TOKYO BLDG., 2-7-3, MARUNOUCHI, CHIYODA-KU, TOKYO 100-8310, JAPAN

© Copyright 2012 MITSUBISHI ELECTRIC CORPORATION  
Distributed in Mar. 2013. No. OBH625 REVISED EDITION-A  
Distributed in Jul. 2012. No. OBH625  
Made in Japan

New publication, effective Mar. 2013  
Specifications are subject to change without notice.